

SAU

QUALITY TOOLS ENGINEERING



Turning

Milling

Drilling

Tapping

Inserts

Taper Shanks

GK 224
GENERAL CATALOGUE



**TUTTI GLI IMBALLAGGI DEGLI UTENSILI
SONO INTERAMENTE IN PLASTICA RICICLATA**
**ALL TOOL PACKAGING IS MADE ENTIRELY
OF RECYCLED PLASTIC**



SAU, an Eco-Friendly Company

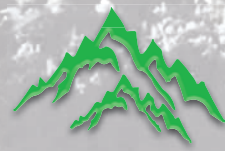



Pag. 2

MINITOL



Pag. 190

TORNITURA
TURNING
DREHEN
TOURNAGE
TORNEADO

Pag. 58

Pag. 100

Pag. 136

Pag. 164

Pag. 185

Pag. 234



Pag. 682

FRESATURA
MILLING
FRÄSEN
FRAISAGE
FRESADO

Pag. 259

Pag. 430

Pag. 446

Pag. 482

Pag. 500

Pag. 522



Pag. 696

FORATURA - LAVORAZIONE FORI
DRILLING - MACHINING OF BORES
BOHREN - BEARBEITUNG VON BOHRUNGEN
PERÇAGE - USINAGE DES TROUS
TALÁDRAR - TRABAJO DE LOS AGUJEROS

Pag. 563

Pag. 650

Pag. 666

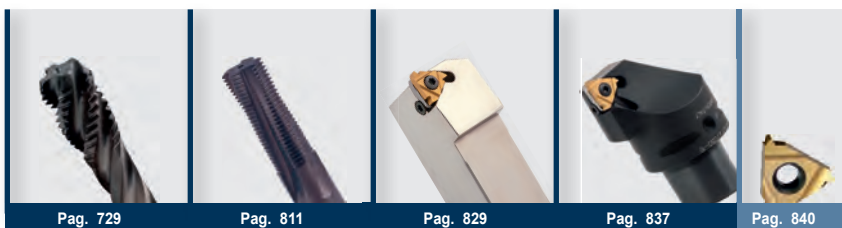

Pag. 840

FILETTATURA
THREADING
GEWINDEDREHEN
FILETAGE
ROSCADO

Pag. 729

Pag. 811

Pag. 829

Pag. 837



Pag. 932

SISTEMA MODULARE - BARENATURA
MODULAR TOOL SYSTEM - BORING
MODULARE WERKZEUGSYSTEME - AUSBOHREN
SYSTEMES MODULAIRE FLEXIBLE - ALÉSAGE
SISTEMA MODULAR FLEXIBLE - MANDRINADO

Pag. 883

Pag. 898

Pag. 914



Pag. 1044

MANDRINI E ACCESSORI
CHUCKS AND ACCESSORIES
AUFNAHMEN UND ZUBEHÖR
MANDRINS ET ACCESSOIRES
CONOS Y ACCESORIOS

Pag. 963

Pag. 984

Pag. 1008

Pag. 1032

RICAMBI - SPARE PARTS - ERSATZTEILE - RECHANGE - REPUESTOS

Pag. 1103

DATI TECNICI - TECHNICAL DATA - TECHNISCHE DATEN - DONNÉES TECHNIQUES - DATOS TECNICOS

Pag. 1125

INDICE ALFANUMERICO - ALPHANUMERIC INDEX - ALPHANUMERISCHE INHALTSÜBERSICHT - INDEX ALPHANUMÉRIQUE - INDICE ALFANUMÉRICO

Pag. 1209



Reg. Number	440 - A	Valid From	2022-02-04
First issue date	1997-12-15	Last change date	2022-02-04
Valid Until	2025-02-06	IAF Sector	17, 29

CERTIFICATE

Quality Management System Certificate
ISO 9001:2015

We certify that the Quality Management System of the Organization:

SAU S.p.A.

Is in compliance with the standard UNI EN ISO 9001:2015 for the following products/services:

Design, manufacture and marketing of precision mechanical tooling, chucks and related accessories.

Chief Operating Officer
Giampiero Belcredi



The maintaining of the certification is subject to annual surveillance and dependent on the observance of Kiwa Cermet Italia contractual requirements.
This certificate is composed of 1 page.

Kiwa Cermet Italia S.p.A.
Società con socio unico,
soggetta all'attività di
direzione e coordinamento di
Kiwa Italia Holding Srl
Via Cadriano, 23
40057 Granarolo dell'Emilia
(BO)
Tel. +39 051 459 3111
Fax +39 051 763 382
E-mail: info@kiwacermet.it,
www.kiwa.it

SAU S.p.A.
Registered Headquarters
- Via dei Raseni, 6/B 41040 Polinago (MO) Italia

Certified Sites
- Via dei Raseni, 6/B 41040 Polinago (MO) Italia
- Via Mozart, 43 41122 Modena Italia





Sau Group rappresenta una solida realtà con un forte radicamento al proprio territorio e al tessuto sociale. Il Gruppo viene rappresentato da quattro aziende storiche nel panorama industriale emiliano, nel nord Italia. La visione e politica aziendale vede, sia nei fornitori che nei partner, la valorizzazione del Made in Italy sinonimo da sempre di qualità ed eccellenza. Sau Group ha da sempre forte sensibilità verso l'innovazione e la ricerca, questo permette di garantire standard qualitativi elevati e nuove opportunità da proporre alle aziende partner, proprio per questo i prodotti di Sau Group sono distribuiti in tutto il mondo, rigorosamente Made in Italy.

Sau Group represents a solid reality with a strong root to its territory and social fabric. The Group is represented by four historical companies in the Emilian industrial panorama, in northern Italy. The vision and company policy sees, both in suppliers and partners, the enhancement of Made in Italy synonymous of quality and excellence. Sau Group has always had a strong sensitivity towards innovation and research, this allows to guarantee high quality standards and new opportunities to be offered to partner companies, and this is the reason why Sau Group products are distributed all over the world, strictly Made in Italy.



Since 1982

www.sautool.com



SAU TOOL

Produzione e vendita utensili
Production and sale of tools



Since 1956

www.gis-air.it



GIS AIR COMPRESSORS

Produzione e vendita Compressori
Production and sale of compressors



Since 2006

www.agsautomation.it



AGS AUTOMATION

Automazioni industriali, produzione magazzini verticali.
Industrial automation, production of vertical warehouses.



Since 1951

www.bbtools.com



BBO TOOLS SYSTEM

Produzione, affilatura, rivestimento e vendita utensili.
Production, sharpening, coating and sale of tools



Scopri di più



Sau nasce nel 1982 come azienda di servizio e di supporto alla commercializzazione di prodotti di utensileria standard, ben presto SAU S.p.A. si è trasformata in vera entità produttiva e progettuale autonoma. Il forte e continuativo impegno dello staff SAU S.p.A. profuso in questi anni, ha consentito di ottenere ottimi risultati sia in termini di fatturato che di presenza sul mercato interno ed internazionale. Flessibilità produttiva, qualità, disponibilità di prodotto, velocità di servizio e gamme di prodotti sempre più complete, fanno di SAU S.p.A. una solida e affidabile realtà produttiva ed imprenditoriale a cui rivolgersi per le aziende che guardano al futuro. Sau produce, nello stabilimento di oltre 23.000 mq su sette piani a Polinago, oltre 52.000 articoli lavorati in macchine a controllo numerico di ultima generazione e macchine affilatrici a controllo numerico a 5 e 6 assi con righe ottiche. Tutto il processo produttivo viene gestito da un sistema informatico personalizzato, questo permette una lavorazione 24 ore su 24 e con una banca parametri per l'ottimizzazione dei tempi e cicli. Ogni singolo utensile, prima di essere commercializzato, viene collaudato accuratamente per garantire costanza e qualità nel tempo.

Sau was founded in 1982 as a service and support company for the marketing of standard tooling products, soon SAU S.p.A. became a true independent production and design entity. The strong and continuous commitment of the SAU S.p.A. staff in recent years, has allowed to achieve excellent results both in terms of turnover and presence on the domestic and international market. Production flexibility, quality, product availability, speed of service and increasingly complete product ranges, make SAU S.p.A. a solid and reliable productive and entrepreneurial reality for companies who are looking to the future. Sau produces, in the factory of over 23,000 square meters on seven floors in Polinago, over 52,000 items processed in the latest generation of numerical control machines and grinding machines with 5-6-axis numerical control with optical lines. The entire production process is managed by a custom computer system, this allows 24-hour processing and with a parameter bank for the optimization of times and cycles. Every single tool, before being marketed, is carefully tested to ensure consistency and quality over time.





Discover more



STORY, PASSION AND QUALITY TOOLS

Since
1982

TERRITORIO, STORIA E SENSO DI APPARTENENZA >>>

Sau da oltre quarant'anni ha la sua storia legata fortemente al territorio, alla sua gente, alla voglia di creare un'azienda importante nel cuore dell'appennino modenese, tra natura e valori umani di spessore. Tenacia, caparbieta, dedizione, coerenza, onesta, voglia di crescere guardando al futuro senza dimenticare le radici, queste sono caratteristiche che fanno del personale Sau un valore aggiunto che si rispecchia negli utensili distribuiti in tutto il mondo.

TERRITORY, HISTORY AND SENSE OF BELONGING <<<

For over forty years, Sau has a strong history linked to the territory, its people, the desire to create an important company in the heart of the Modena Apennines, between nature and human values of depth. Tenacity, stubbornness, dedication, consistency, honesty, desire to grow looking to the future without forgetting the roots, these are characteristics that make Sau staff an added value that is reflected in tools distributed around the world.

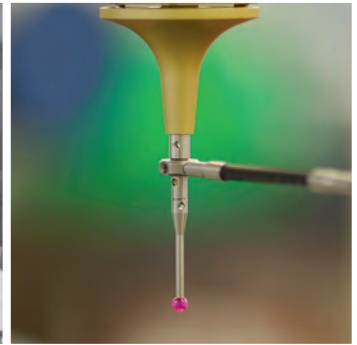
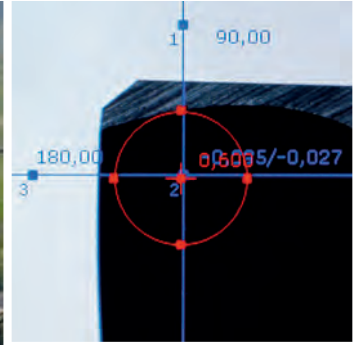



REPARTO COSTRUZIONE UTENSILI SPECIALI



L'ufficio e reparto "Speciale" Sau offre una squadra di tecnici specializzati a disposizione dei clienti con una altissima flessibilità e velocità d'azione. I Tecnici studiano le migliori soluzioni per l'ottimizzazione dei tempi di lavorazione, abbreviare i cicli e di conseguenza un risparmio in termini economici e di riuscita del prodotto.



SPECIAL TOOL CONSTRUCTION DEPARTMENT



The Sau "Special" office and department offers a team of specialized technicians available to customers with a very high flexibility and speed of action. The Technicians study the best solutions for the optimization of the working time, shorten the cycles and consequently a saving in economic terms and product success.

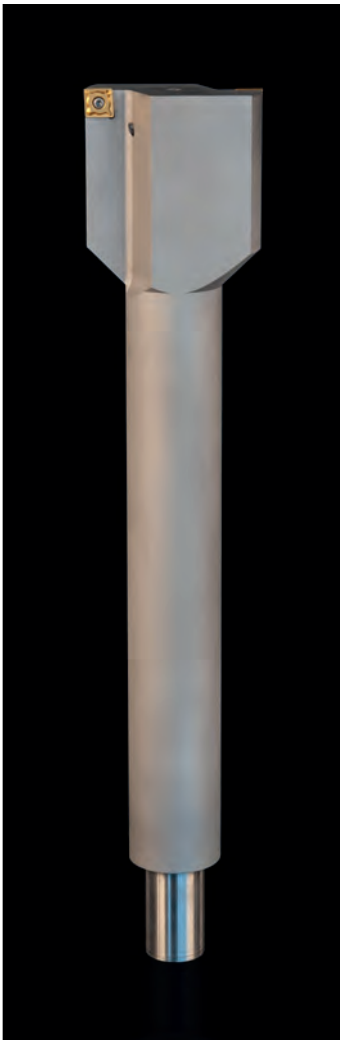

RICERCA E SVILUPPO >>>

SAU è da sempre attenta allo sviluppo di nuovi prodotti, all'evoluzione e miglioramento degli articoli esistenti, sempre rivolta alla scoperta e l'implementazione di nuovi o più efficienti processi di produzione.

RESEARCH AND DEVELOPMENT <<<

SAU has always been committed to the development of new products, the evolution and improvement of existing items, always striving for the discovery and implementation of new or more efficient production processes.

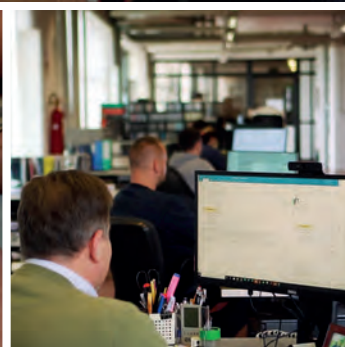
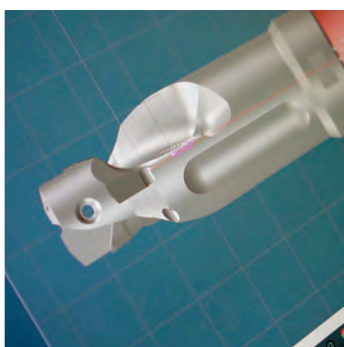

SALA METROLOGICA >>>

SAU dispone al suo interno di una sala metrologica d'eccellenza per il controllo della taratura degli utensili e degli strumenti di misura. Il servizio permette di verificare tempestivamente la conformità sia degli strumenti SAU sia di quelli del cliente alle norme di legge.

METROLOGY LAB <<<

SAU has always been committed to the development of new products, the evolution and improvement of existing items, always striving for the discovery and implementation of new or more efficient production processes.

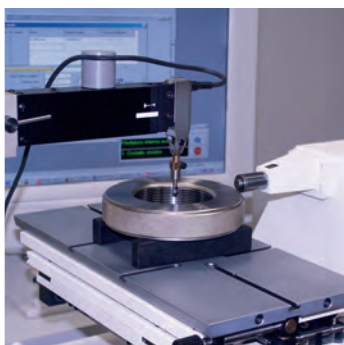

MAGAZZINO AUTOMATICO VERTICALE "THE BOX" >>>

Il magazzino automatico verticale specifico per il tool management. Completamente modulare ed espandibile tramite moduli affiancabili e sovrapponibili.

AUTOMATED VERTICAL WAREHOUSE "THE BOX" <<<

The automated vertical warehouse specific for tool management. Fully modular and expandable, by adding modules to the sides or top.

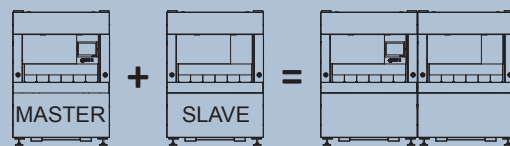

Made In Italy



Dimensioni:
L 1600 x H 2200 x P 1340 (mm)

Dimensions:
W 1600 x H 2200 x D 1340 (mm)



Peso:
8,5 q
Weight:
850 kg



Numero massimo cassetti:
20
Maximum number of drawers:
20



Numero massimo settori:
480 ubicazioni singole dinamiche
Maximum number of sectors:
480 dynamic individual locations



Portata a pieno carico:
oltre 1600 Kg
Load limit:
over 1600 Kg



Superficie a terra occupata:
L 1600 x P 1000 < 2 mt²
Footprint:
W 1600 x D 1000 < 2 mt²

Scopri di più



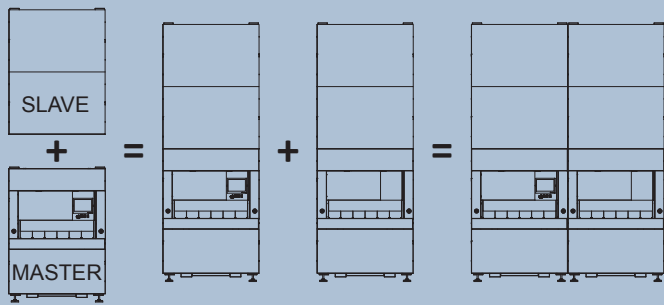

Dimensioni:
L 1600 x H 4200 x P 1340 (mm)
 Dimensions:
W 1600 x H 4200 x D 1340 (mm)



Peso:
12,5 q
 Weight:
1250 kg



Numero massimo cassetti:
70
 Maximum number of drawers:
70



Numero massimo settori:
1680 ubicazioni singole dinamiche
 Maximum number of sectors:
1680 dynamic individual locations



Portata a pieno carico:
oltre 5700 Kg
 Load limit:
over 5700 Kg



Superficie a terra occupata:
L 1600 x P 1000 < 2 mt²
 Footprint:
W 1600 x D 1000 < 2 mt²



Discover more





GIS, gli specialisti dell'aria compressa.
Gis, the compressed air specialists

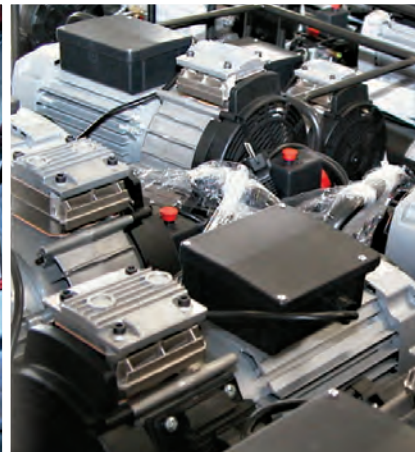

SCAN ME



GIS dal 1956 produce e commercializza a Carpi compressori di alta qualità e affidabilità, tutti rigorosamente Made in Italy. Grazie ad un know how maturato in oltre 67 anni di attività, i tecnici specializzati GIS sapranno indicarti la migliore soluzione per la tua azienda per darti affidabilità, resistenza nel tempo e risparmio in termini di energia. GIS offre un servizio di manutenzione e assistenza per ogni tipologia di compressore.

GIS has been producing and selling high quality and reliability compressors in Carpi since 1956, all strictly Made in Italy. Thanks to a know-how matured in over 67 years of activity, GIS technicians will show you the best solution for your company to give you reliability, durability and energy savings. GIS offers a service of maintenance and assistance of every type of compressor.

Compressori - Compressors :



Vite - Screw



Silenziati - Silenced



Oil free



Motocompressori - Motocompressors



Pistoni - Piston

DINA PLUS



Scopri di più

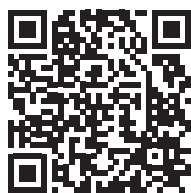

Discover more



DINAPLUS, IL CACCIAVITE DINAMOMETRICO DI SAU



- Un'unica impugnatura. Può essere utilizzata con 14 lame TORX da T6 a T20
- Non necessita di regolazione quando la lama viene cambiata
- Meno inserti rotti viti e corpi, con conseguente risparmio
- La garanzia di un perfetto serraggio comporta una maggiore durata e una maggiore qualità del prodotto finito.

DINAPLUS, SAU'S AUTOMATIC DYNAMOMETRIC SCREWDRIVER



- A single handle can be used with 14 Torx blades from T6 to T20
- Does not require adjustment when the blade is changed
- Fewer broken inserts screws and bodies, resulting in savings
- The guarantee of proper tightening results in longer life and higher quality for the finished product

IL MONDO SAU A PORTATA DI CLICK >>> SAU WORLD JUST A CLICK AWAY <<<

PER ESSERE SEMPRE COLLEGATI, 365 GIORNI ALL'ANNO 24 ORE SU 24 >>>

TO STAY CONNECTED, 365 DAYS A YEAR 24 HOURS A DAY <<<

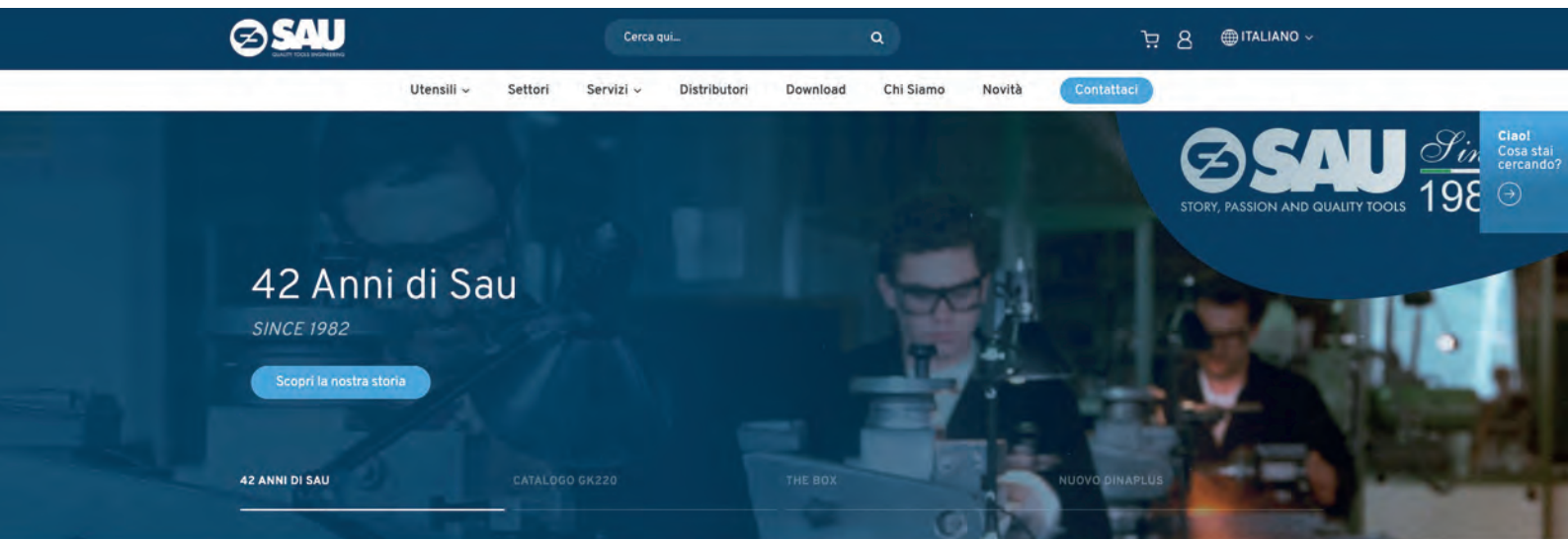

Trova il tuo **utensile**



www.sautool.com

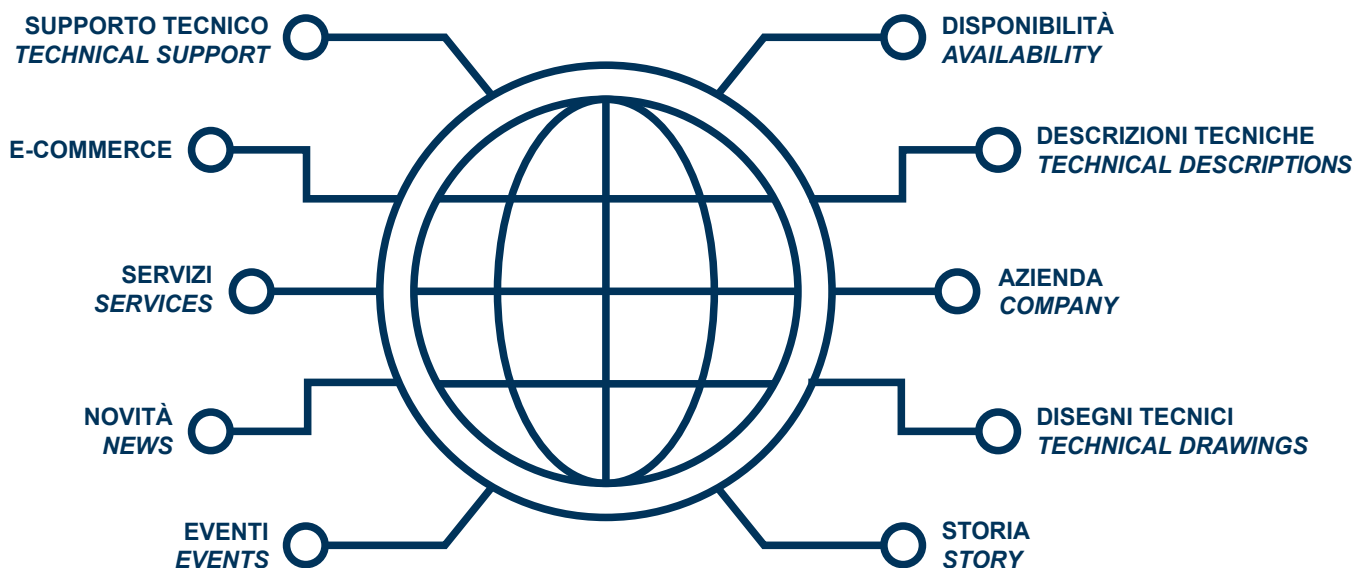





MINITOOL

	ART.	Ød	ØD	Pag.
PORTAUTENSILI - TOOL HOLDER				
	S100-TS-04-...	4	12-25	8
	S100-TS-05-...	5	12-25	9
	S100-TS-06-...	6	12-25	10
	S100-TS-07-...	7	16-25	11

APPLICAZIONE - APPLICATION	ART.	ØD min	Ød	t max	Pag.	
TORNITURA INTERNA - INTERNAL TURNING						
	 AGG. NEWS UPDATE	S101-04.9820-...015R/L	1,7-4,2	4	0,2-0,3	12
	 AGG. NEWS UPDATE	S101-05.9820-052-...020R/L	4,9-5,2	5	0,4-0,5	14
		S101-06.9820-062-...020R/L	6,2	6	0,5	16
	 AGG. NEWS UPDATE	S101-07.9820-072-...020R/L	7,2	7	0,5	18
	 AGG. NEWS UPDATE	S101-04.9847-...-...R/L	3,2-4,2	4	0,4-0,8	20
		S101-05.9847-052-...015R/L	5,2	5	1,0	20
		S101-06.9847-062-...015R/L	6,2	5	1,8	20
		S101-07.9847-072-40.020R/L	7,2	7	2,5	20
	 STM 2	S101-05.9020-052-...020R/L	5,2	5	0,5	22

APPLICAZIONE - APPLICATION	ART.	ØD min	Ød	t max	Pag.	
SCANALATURA - GROOVING						
		S102-04...000R/L	2,0-4,2	4	0,4-0,8	24
		S102-05...000R/L	5,0-5,2	5	1,0	26
		S102-06...-062-...000R/L	6,2	6	1,8	28
		S102-07...-072-...000R/L	7,2	7	2,5	30
		S102-04.R100-042-15.050R/L	4,2	4	0,8	32
		S102-05.R...-052-20...R/L	5,2	5	1,0	32
		S102-06.R...-062-25...R/L	6,2	6	1,8	32
		S102-07.R...-072-30...R/L	7,2	7	2,5	32
PRETAGLIO E SMUSSATURA - PRE-PART-OFF AND CHAMFERING						
		S105-04.0100-037-...000R/L	3,7-4,2	4	0,7	34
		S105-05.0100-052-...000R/L	5,2	5	0,7	34
		S105-06.0100-062-...000R/L	6,2	6	0,7	34
SCANALATURA FRONTALE - FACE GROOVING						
		S103-06...-I62-15.015R/L	6,2	6	2-6	36
		S103-06...-E62-15.015R/L	6,2	6	2-6	38
		S103-06.R...-I62-15...R/L	6,2	6	2-4	40
		S103-06.R...-E62-15...R/L	6,2	6	2-4	42

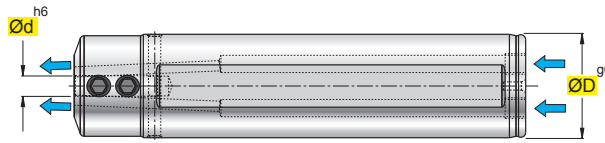

S	1	0	0	-	T	S	-	0	4	.	0	0	1	6
1								2			3			

- 1** COD. TIPOLOGIA ARTICOLO
COD. ITEM TYPE
- 2** Ød DIAMETRO ATTACCO "MINITOOL"
Ød "MINITOOL" ATTACHMENT DIAMETER
- 3** ØD DIAMETRO ATTACCO PORTA UTENSILE
ØD TOOL-HOLDER ATTACHMENT DIAMETER

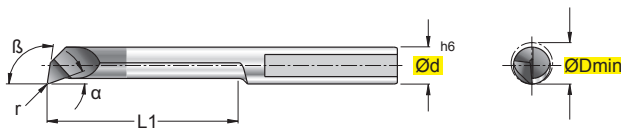

S	1	0	1	-	0	4	.	9	8	2	0	-	0	3	7	-	2	0	.	0	1	5	R
1		2		3		4		5		6		7		8									

- 1** COD. TIPOLOGIA ARTICOLO
COD. ITEM TYPE
- 2** Ød DIAMETRO ATTACCO "MINITOOL"
Ød "MINITOOL" ATTACHMENT DIAMETER
- 3** ANGOLO β TESTA
β ANGLE - HEAD
- 4** ANGOLO α TESTA
α ANGLE - HEAD
- 5** ØDmin DIAMETRO MINIMO DI ENTRATA
ØDmin MINIMUM PENETRATION DIAMETER
- 6** L1 PROFONDITÀ MASSIMA DI LAVORO
L1 MAXIMUM MACHINING DEPTH
- 7** r RAGGIO IN TESTA
r HEAD RADIUS
- 8** R/L DIREZIONE DI TAGLIO
R/L CUTTING DIRECTION

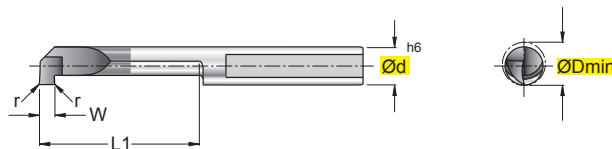

S	1	0	2	-	0	4	.	0	1	0	0	-	0	4	2	-	1	0	.	0	0	0	R
1		2		3		4		5		6		7		8									

- 1** COD. TIPOLOGIA ARTICOLO
COD. ITEM TYPE
- 2** Ød DIAMETRO ATTACCO "MINITOOL"
Ød "MINITOOL" ATTACHMENT DIAMETER
- 3** FORMA DELLA GOLA 0=PIANA R=SFERICA
SHAPE OF GROOVE 0=FLAT R=SPHERICAL
- 4** W LARGHEZZA SCANALATURA
W GROOVE WIDTH
- 5** ØDmin DIAMETRO MINIMO DI ENTRATA
ØDmin MINIMUM PENETRATION DIAMETER
- 6** L1 PROFONDITÀ MASSIMA DI LAVORO
L1 MAXIMUM MACHINING DEPTH
- 7** r RAGGIO IN TESTA
r HEAD RADIUS
- 8** R/L DIREZIONE DI TAGLIO
R/L CUTTING DIRECTION

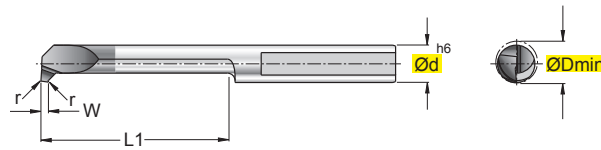

S 1 0 5 - 0 4 . 0 1 0 0 - 0 4 2 - 2 0 . 0 0 0 R
1 2 3 4 5 6 7 8

1 COD. TIPOLOGIA ARTICOLO COD. ITEM TYPE	2 Ød DIAMETRO ATTACCO "MINITOOL" Ød "MINITOOL" ATTACHMENT DIAMETER	3 FORMA DELLA GOLA 0=PIANA R=SFERICA SHAPE OF GROOVE 0=FLAT R=SPHERICAL
4 W LARGHEZZA SCANALATURA W GROOVE WIDTH	5 ØDmin DIAMETRO MINIMO DI ENTRATA ØDmin MINIMUM PENETRATION DIAMETER	6 L1 PROFONDITÀ MASSIMA DI LAVORO L1 MAXIMUM MACHINING DEPTH
7 r RAGGIO IN TESTA r HEAD RADIUS	8 R/L DIREZIONE DI TAGLIO R/L CUTTING DIRECTION	

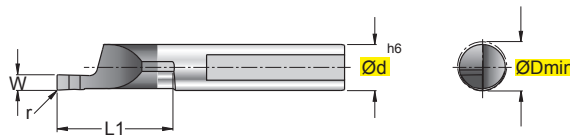

S 1 0 3 - 0 6 . 0 2 0 0 - I 6 2 - 1 5 . 0 1 5 R
1 2 3 4 5 6 7 8 9

1 COD. TIPOLOGIA ARTICOLO COD. ITEM TYPE	2 Ød DIAMETRO ATTACCO "MINITOOL" Ød "MINITOOL" ATTACHMENT DIAMETER	3 FORMA DELLA GOLA 0=PIANA R=SFERICA SHAPE OF GROOVE 0=FLAT R=SPHERICAL
4 W LARGHEZZA SCANALATURA W GROOVE WIDTH	5 TIPO TORNITURA I=INTERNA E=ESTERNA TURNING TYPE I=INTERNAL E=EXTERNAL	6 ØDmin DIAMETRO MINIMO DI ENTRATA ØDmin MINIMUM PENETRATION DIAMETER
7 L1 PROFONDITÀ MASSIMA DI ENTRATA L1 MAXIMUM PENETRATION DEPTH	8 r RAGGIO IN TESTA r HEAD RADIUS	9 R/L DIREZIONE DI TAGLIO R/L CUTTING DIRECTION

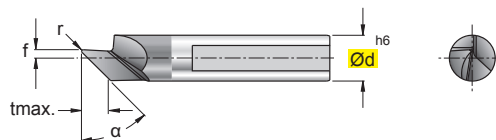

S 1 0 1 - 0 6 . 0 0 4 5 - 0 1 1 - 3 5 . 0 2 0 R
1 2 3 4 5 6 7

1 COD. TIPOLOGIA ARTICOLO COD. ITEM TYPE	2 Ød DIAMETRO ATTACCO "MINITOOL" Ød "MINITOOL" ATTACHMENT DIAMETER	3 ANGOLO α SMUSSATURA α ANGLE - CHAMFERING
4 f DISTANZA OLTRE CENTRO f OFF-CENTRE DISTANCE	5 tmax MASSIMA PROFONDITÀ DI LAVORO tmax MAXIMUM CUTTING DEPTH	6 r RAGGIO IN TESTA r HEAD RADIUS
7 R/L DIREZIONE DI TAGLIO R/L CUTTING DIRECTION		

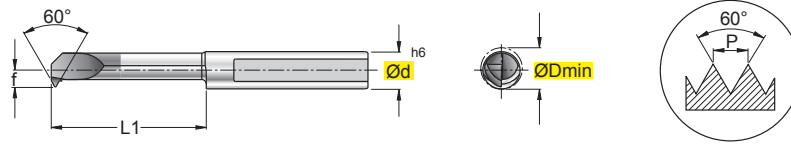

S	1	0	4	-	0	6	.	0	0	6	0	-	0	6	2	-	2	5	.	1	2	5	R
	1				2				3				4				5			6			7

1	COD. TIPOLOGIA ARTICOLO COD. ITEM TYPE	2	Ød DIAMETRO ATTACCO "MINITool" Ød "MINITool" ATTACHMENT DIAMETER	3	60° ANGOLO FILETTO 60° THREAD ANGLE
4	ØDmin DIAMETRO MINIMO DI ENTRATA ØDmin MINIMUM PENETRATION DIAMETER	5	L1 PROFONDITÀ MASSIMA DI ENTRATA L1 MAXIMUM PENETRATION DEPTH	6	P(min) PASSO MINIMO P(min) MINIMUM PITCH
7	R/L DIREZIONE DI TAGLIO R/L CUTTING DIRECTION				

S100-TS-04-...

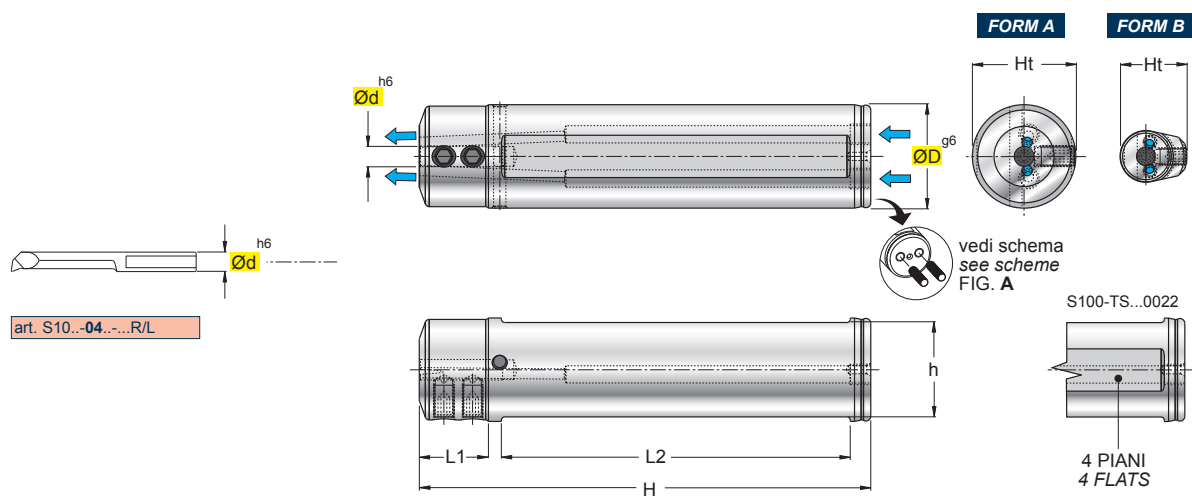

art. S10...-04...-...R/L

(mm)													
ART.	FORM	ØD	Ød	h	L1	L2	H	Ht					
S100-TS-04.0012	B	12	4	10	14	48	70	15,5	n°2 GR408C	n°1 GR304C	5002		
S100-TS-04.0016	B	16	4	14	14	53	75	17,5	n°2 GR408C	n°1 GR404C	5002		
S100-TS-04.0020	A	20	4	18	15	66	90	19,5	n°2 GR408C	n°1 GR505C	5002		
S100-TS-04.0022	A	22	4	20	15	86	110	21,5	n°2 GR508C	n°1 GR505C	5025		
S100-TS-04.0025	A	25	4	23	15	86	110	24,5	n°2 GR410C	n°1 GR505C	5002		

(FIG. A) SCHEMA REFRIGERAZIONE - (FIG. A) COOLING DIAGRAM - (ABB. A) KÜHLSCHEMA - (FIG. A) SCHEMA REFRIGERATION

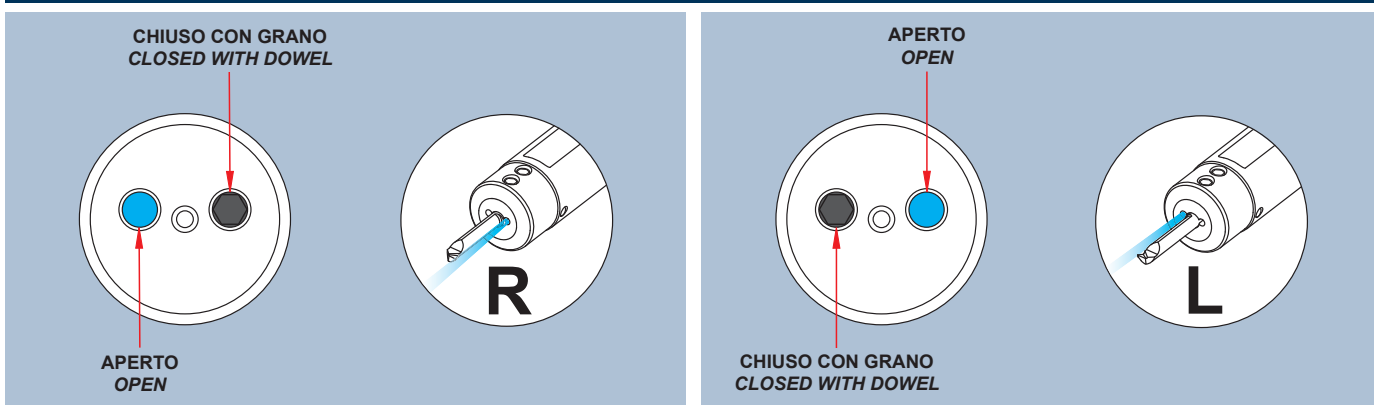

S100-TS-05-...

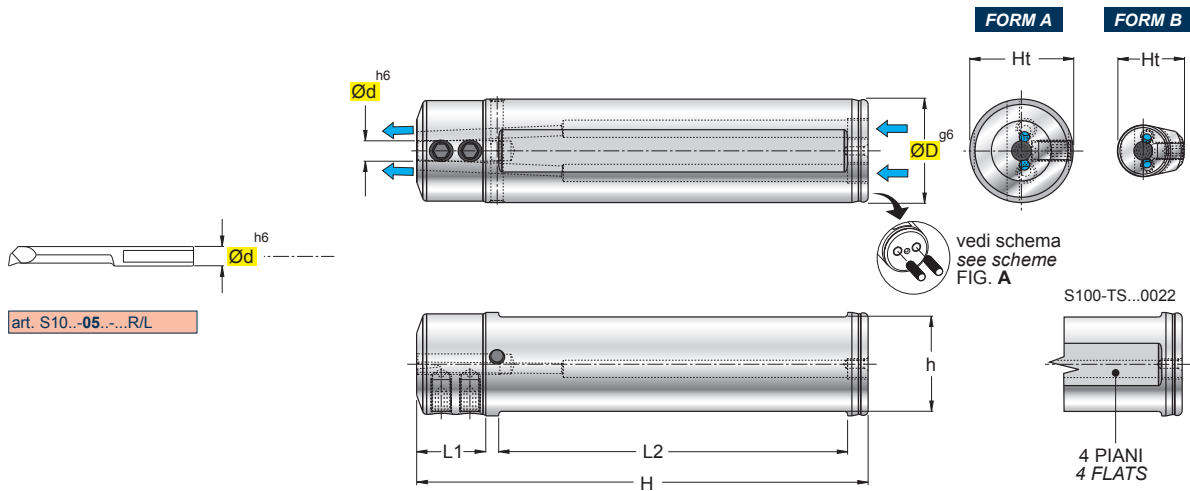

art. S10...05...R/L

(mm)														
ART.	FORM	ØD	Ød	h	L1	L2	H	Ht						
S100-TS-05.0012	B	12	5	10	15	47	70	16,0	n°2 GR508C	n°1 GR304C	5025			
S100-TS-05.0016	B	16	5	14	15	52	75	18,0	n°2 GR508C	n°1 GR404C	5025			
S100-TS-05.0020	A	20	5	18	15	66	90	19,5	n°2 GR508C	n°1 GR505C	5025			
S100-TS-05.0022	A	22	5	20	15	86	110	21,5	n°2 GR508C	n°1 GR505C	5025			
S100-TS-05.0025	A	25	5	23	15	86	110	24,5	n°2 GR510C	n°1 GR505C	5025			

(FIG. A) SCHEMA REFRIGERAZIONE - (FIG. A) COOLING DIAGRAM - (ABB. A) KÜHLSCHHEMA - (FIG. A) SCHEMA REFRIGERATION

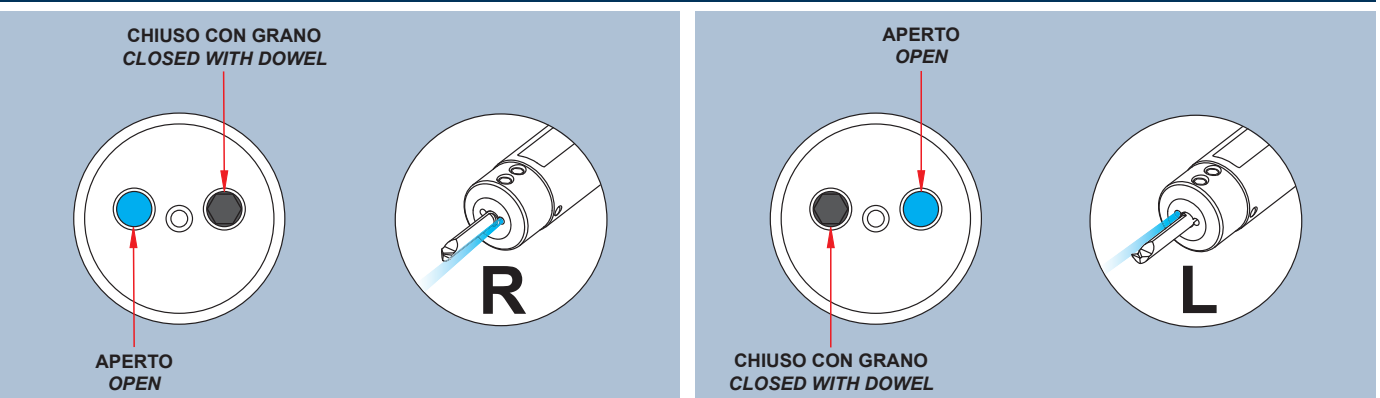

S100-TS-06-...

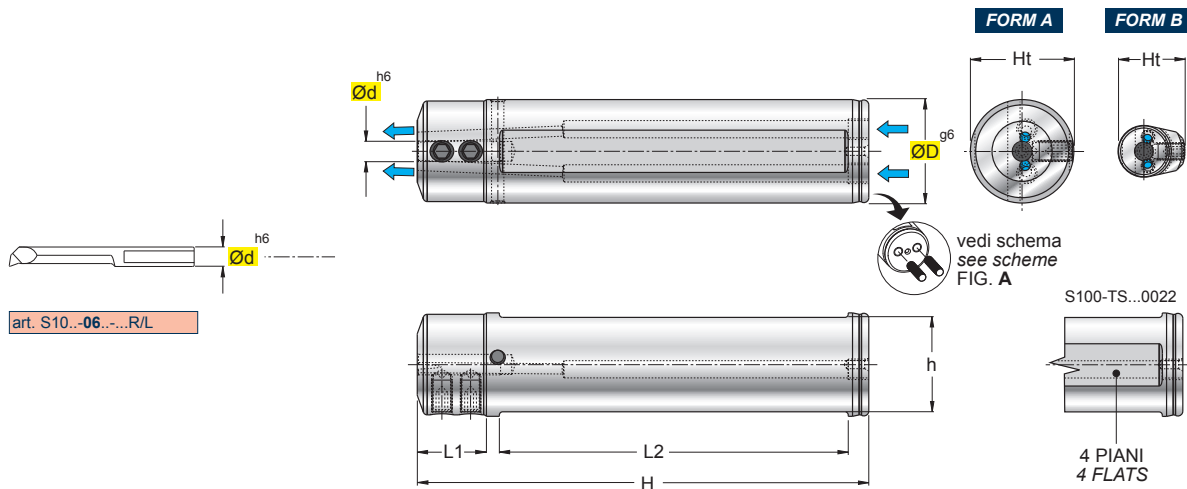

art. S10...-06...-...R/L

(mm)															
ART.	FORM	ØD	Ød	h	L1	L2	H	Ht							
S100-TS-06.0012	B	12	6	10	15	47	70	16,5	n°2 GR508C	n°1 GR304C	5025				
S100-TS-06.0016	B	16	6	14	15	55	78	18,5	n°2 GR508C	n°1 GR404C	5025				
S100-TS-06.0020	A	20	6	18	15	66	90	19,5	n°2 GR508C	n°1 GR505C	5025				
S100-TS-06.0022	A	22	6	20	15	86	110	21,5	n°2 GR508C	n°1 GR505C	5025				
S100-TS-06.0025	A	25	6	23	15	85	110	24,5	n°2 GR510C	n°1 GR505C	5025				

(FIG. A) SCHEMA REFRIGERAZIONE - (FIG. A) COOLING DIAGRAM - (ABB. A) KÜHLSCHHEMA - (FIG. A) SCHEMA REFRIGERATION

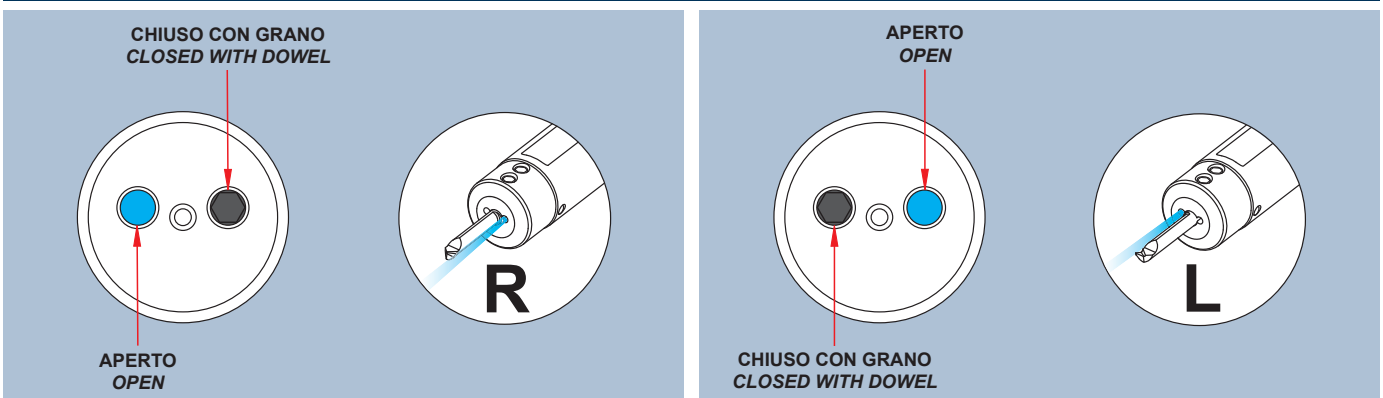

S100-TS-07-...

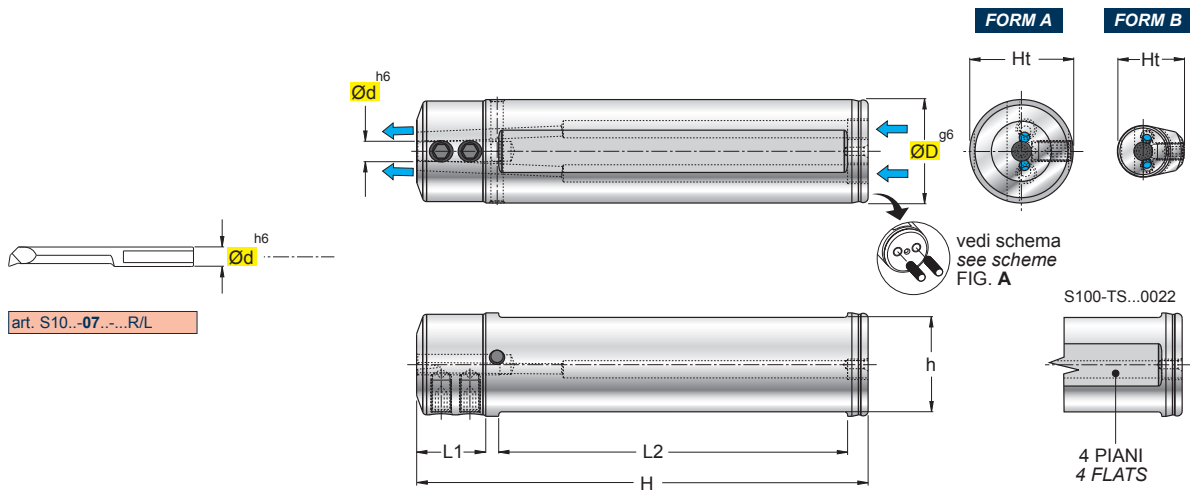

(mm)											
ART.	FORM	ØD	Ød	h	L1	L2	H	Ht			
S100-TS-07.0016	B	16	7	14	15	55	78	19,0	n°2 GR508C	n°1 GR404C	5025
S100-TS-07.0020	A	20	7	18	15	66	90	22,0	n°2 GR508C	n°1 GR505C	5025
S100-TS-07.0022	A	22	7	20	15	86	110	21,7	n°2 GR508C	n°1 GR505C	5025
S100-TS-07.0025	A	25	7	23	15	86	110	24,5	n°2 GR510C	n°1 GR505C	5025

(FIG. A) SCHEMA REFRIGERAZIONE - (FIG. A) COOLING DIAGRAM - (ABB. A) KÜHLSCHHEMA - (FIG. A) SCHEMA REFRIGERATION

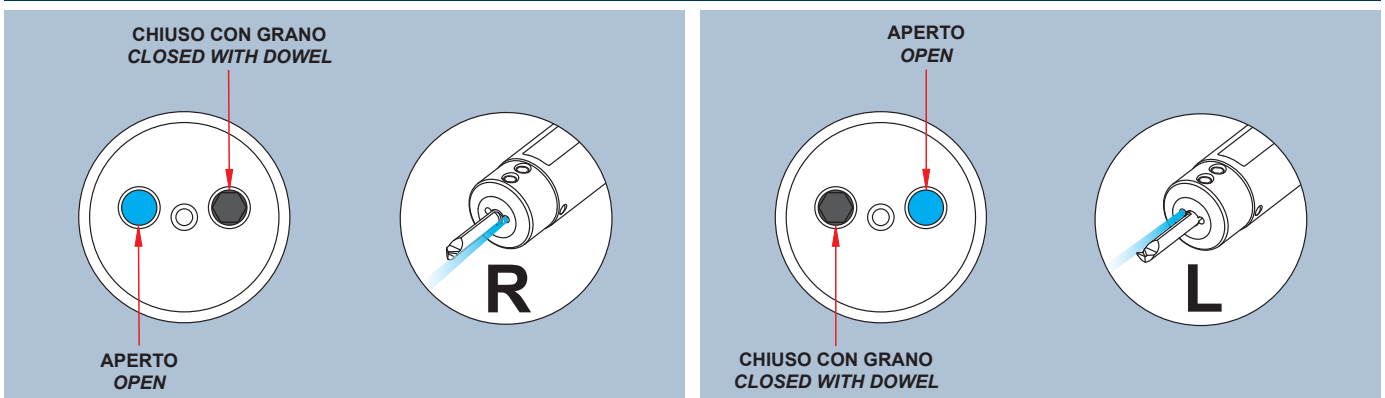

S101-04.9820-...R/L

Tornitura Interna - Internal Turning

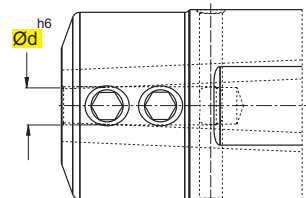
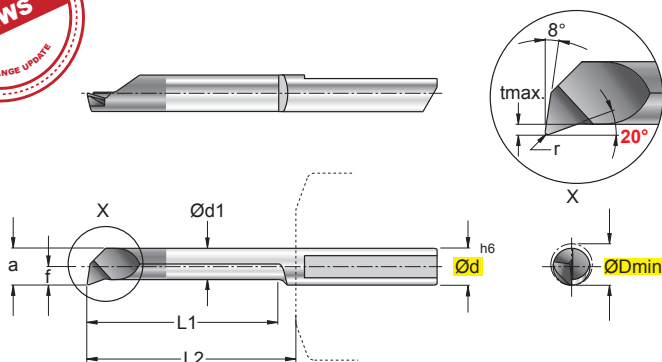
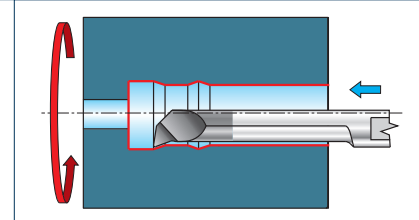

art. S100-TS-04..

In figura utensile destro - Right-hand shown

ART.	(mm)										P	M	K	N	S	H	HW		HC	
		ØDmin	Ød	Ød1	f	a	tmax	r	L1	L2							NON RIV. CEMENTED CARBIDE GRADES	RIVESTITI COATED GRADES BESCHICHTET RECOUVERTS		
																	N3635	F7835		
S101-04.9820-017-06.010R/L New		1,7	4	1,05	0,7	1,45	0,2	0,10	06	13	●	●	○	●	○	■		■		
S101-04.9820-017-09.010R/L New		1,7	4	1,05	0,7	1,45	0,2	0,10	09	13	●	●	○	●	○	■		■		
S101-04.9820-022-06.010R/L New		2,2	4	1,55	0,95	1,95	0,2	0,10	06	13	●	●	○	●	○	■		■		
S101-04.9820-022-09.010R/L New		2,2	4	1,55	0,95	1,95	0,2	0,10	09	13	●	●	○	●	○	■		■		
S101-04.9820-022-13.010R/L New		2,2	4	1,55	0,95	1,95	0,2	0,10	13	18	●	●	○	●	○	■		■		
S101-04.9820-027-10.005R/L New		2,7	4	2,05	1,2	2,45	0,2	0,05	10	13	●	●	○	●	○	■		■		
S101-04.9820-027-10.015R/L New		2,7	4	2,05	1,2	2,45	0,2	0,15	10	13	●	●	○	●	○	■		■		
S101-04.9820-027-15.005R/L New		2,7	4	2,05	1,2	2,45	0,2	0,05	15	18	●	●	○	●	○	■		■		
S101-04.9820-027-15.015R/L New		2,7	4	2,05	1,2	2,45	0,2	0,15	15	18	●	●	○	●	○	■		■		
S101-04.9820-030-20.015R/L New		3,0	4	2,35	1,35	2,75	0,2	0,15	20	23	●	●	○	●	○	■		■		
S101-04.9820-030-25.005R/L New		3,0	4	2,35	1,35	2,75	0,2	0,05	25	28	●	●	○	●	○	■		■		
S101-04.9820-032-10.015R/L		3,2	4	2,55	1,45	2,95	0,2	0,15	10	13	●	●	○	●	○	■		■		
S101-04.9820-032-15.005R/L New		3,2	4	2,55	1,45	2,95	0,2	0,05	15	18	●	●	○	●	○	■		■		
S101-04.9820-032-15.015R/L		3,2	4	2,55	1,45	2,95	0,2	0,15	15	18	●	●	○	●	○	■		■		
S101-04.9820-032-20.005R/L New		3,2	4	2,55	1,45	2,95	0,2	0,05	20	23	●	●	○	●	○	■		■		
S101-04.9820-032-20.015R/L		3,2	4	2,55	1,45	2,95	0,2	0,15	20	23	●	●	○	●	○	■		■		
S101-04.9820-037-10.015R/L		3,7	4	3,05	1,7	3,45	0,2	0,15	10	13	●	●	○	●	○	■		■		
S101-04.9820-037-15.015R/L		3,7	4	3,05	1,7	3,45	0,2	0,15	15	18	●	●	○	●	○	■		■		
S101-04.9820-037-20.015R/L		3,7	4	3,05	1,7	3,45	0,2	0,15	20	23	●	●	○	●	○	■		■		
S101-04.9820-037-25.015R/L		3,7	4	3,05	1,7	3,45	0,2	0,15	25	28	●	●	○	●	○	■		■		

S101-05.9820-...R/L

Tornitura Interna - Internal Turning

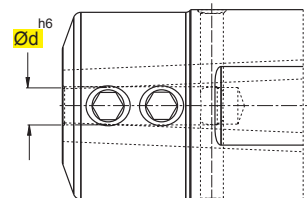
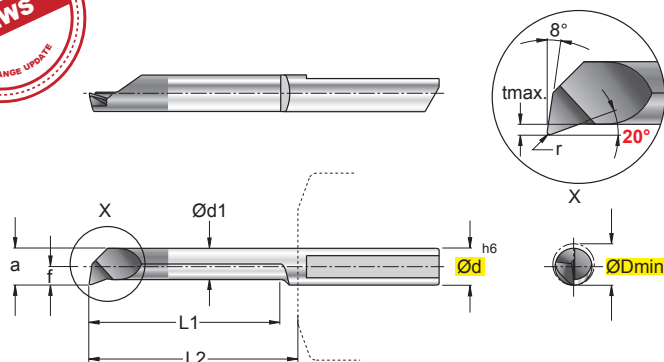
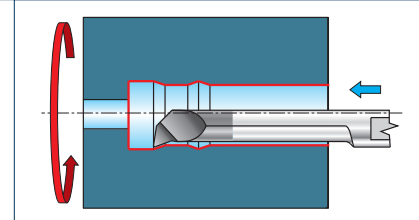

art. S100-TS-05..

In figura utensile destro - Right-hand shown

ART.	(mm)										P	M	K	N	S	H	HW		HC	
		ØDmin	Ød	Ød1	f	a	tmax	r	L1	L2							NON RIV.	RIVESTITI		
																	CEMENTED	COATED GRADES		
S101-05.9820-049-20.020R/L New		4,9	5	3,95	2,45	4,65	0,4	0,2	20	23	●	●	○	●	○	■		■		
S101-05.9820-049-25.020R/L New		4,9	5	3,95	2,45	4,65	0,4	0,2	25	28	●	●	○	●	○	■		■		
S101-05.9820-049-30.020R/L New		4,9	5	3,95	2,45	4,65	0,4	0,2	30	33	●	●	○	●	○	■		■		
S101-05.9820-049-35.020R/L New		4,9	5	3,95	2,45	4,65	0,4	0,2	35	38	●	●	○	●	○	■		■		
S101-05.9820-049-40.020R/L New		4,9	5	3,95	2,45	4,65	0,4	0,2	40	43	●	●	○	●	○	■		■		
S101-05.9820-052-10.005R/L New		5,2	5	4,25	2,45	4,95	0,5	0,05	10	13	●	●	○	●	○	■		■		
S101-05.9820-052-10.020R/L		5,2	5	4,25	2,45	4,95	0,5	0,2	10	13	●	●	○	●	○	■		■		
S101-05.9820-052-15.005R/L New		5,2	5	4,25	2,45	4,95	0,5	0,05	15	18	●	●	○	●	○	■		■		
S101-05.9820-052-15.020R/L		5,2	5	4,25	2,45	4,95	0,5	0,2	15	18	●	●	○	●	○	■		■		
S101-05.9820-052-20.005R/L New		5,2	5	4,25	2,45	4,95	0,5	0,05	20	23	●	●	○	●	○	■		■		
S101-05.9820-052-20.020R/L		5,2	5	4,25	2,45	4,95	0,5	0,2	20	23	●	●	○	●	○	■		■		
S101-05.9820-052-25.020R/L		5,2	5	4,25	2,45	4,95	0,5	0,2	25	28	●	●	○	●	○	■		■		
S101-05.9820-052-30.005R/L New		5,2	5	4,25	2,45	4,95	0,5	0,05	30	33	●	●	○	●	○	■		■		
S101-05.9820-052-30.020R/L		5,2	5	4,25	2,45	4,95	0,5	0,2	30	33	●	●	○	●	○	■		■		
S101-05.9820-052-35.020R/L		5,2	5	4,25	2,45	4,95	0,5	0,2	35	38	●	●	○	●	○	■		■		
S101-05.9820-052-40.020R/L		5,2	5	4,25	2,45	4,95	0,5	0,2	40	43	●	●	○	●	○	■		■		

MATERIALI - MATERIALS Pag. 1199		VDI 3323 GR.	HB Rm ¹⁾ HRC ²⁾	Vc m/min			fn mm
				N3635	F7835		
P	ACCIAIO NON LEGATO - NOT ALLOY STEEL	1-5	125-300		80-200		0,02-0,08
	ACCIAIO POCO LEGATO - LOW ALLOY STEEL	6-9	180-350		80-170		0,02-0,08
	ACCIAIO ALTO LEGATO - ALLOY STEEL	10-11	200-325		60-110		0,02-0,08
	INOX MARTENS. - STAINLESS STEEL MART	12-13	200-240		50-100		0,02-0,08
M	INOX AUST. DUPLEX - STAINLESS STEEL AUST	14.1-14.2	180-230		20-80		0,02-0,08
K	GHISA GRIGIA - GREY CAST IRON	15-16	180-260	30-90	30-150		0,02-0,08
	GHISA SFEROIDALE - SPHEROIDAL GRAPHITE	17-18	160-250	25-80	30-130		0,02-0,08
	GHISA MALLEABILE - MALLEABLE CAST IRON	19-20	130-230	30-90	30-100		0,02-0,08
N	ALLUMINIO E SUE LEGHE - ALUMINIUM	21-25	60-130	80-150			0,02-0,08
	RAME E SUE LEGHE - COPPER	26-28	90-110	50-110			0,02-0,08
	NON METALLICI - PLASTICS	29-30	/	20-100			0,02-0,08
S	LEGHE RESIST. CALORE - HIG. TEMP. ALLOY	31-35	200-320		30-80		0,005-0,05
	TITANIO E SUE LEGHE - TITANIUM	36-37	400-1050 ¹⁾		30-80		0,005-0,05
H	ACCIAIO TEMPRATO - HARDENED STEEL	38-41	45-60 ²⁾				

$$n = \frac{Vc \cdot 1000}{\varnothing D \cdot 3,14} = \text{giri/min (min}^{-1}\text{)}$$

$$Vf = fn \cdot n = \text{mm/min}$$

- Vc** = m/min VELOCITÀ DI TAGLIO - CUTTING SPEED
n = giri/min (min⁻¹) NUMERO DI GIRI - NUMBER OF REVOLUTIONS
fn = mm AVANZAMENTO AL GIRO - FEED / REVOLUTION
Vf = mm/min VELOCITÀ DI AVANZAMENTO - FEED SPEED

NOTE - NOTES

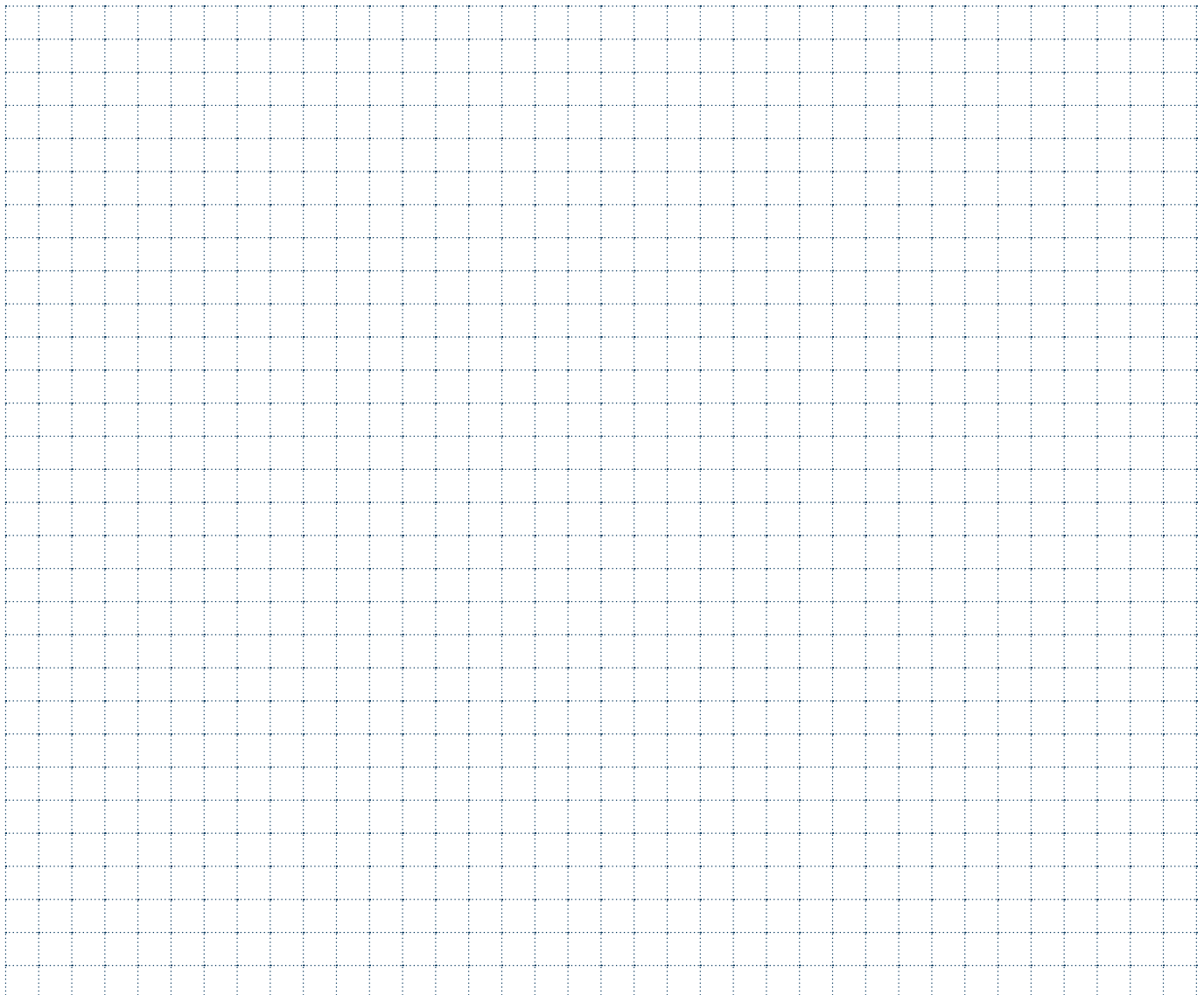

S101-06.9820-...R/L

Tornitura Interna - Internal Turning

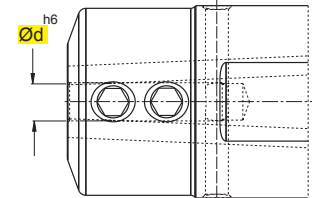
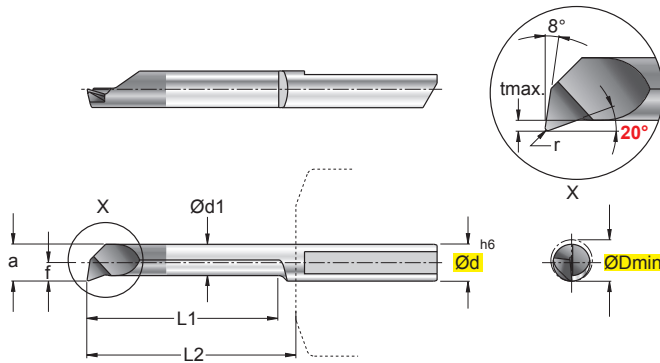
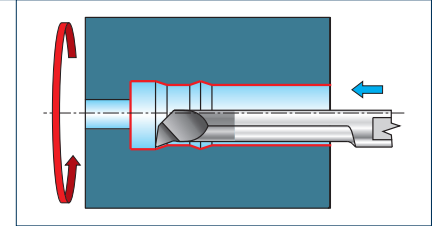

art. S100-TS-06..

In figura utensile destro - Right-hand shown

ART.	(mm)										P	M	K	N	S	H	HW		HC	
	 	ØDmin	Ød	Ød1	f	a	tmax	r	L1	L2							NON RIV.	RIVESTITI		
																	CEMENTED	COATED GRADES		
S101-06.9820-062-15.020R/L		6,2	6	5,25	2,95	5,95	0,5	0,2	15	18	●	●	○	●	○	■		■		
S101-06.9820-062-20.020R/L		6,2	6	5,25	2,95	5,95	0,5	0,2	20	23	●	●	○	●	○	■		■		
S101-06.9820-062-25.020R/L		6,2	6	5,25	2,95	5,95	0,5	0,2	25	28	●	●	○	●	○	■		■		
S101-06.9820-062-30.020R/L		6,2	6	5,25	2,95	5,95	0,5	0,2	30	33	●	●	○	●	○	■		■		
S101-06.9820-062-35.020R/L		6,2	6	5,25	2,95	5,95	0,5	0,2	35	38	●	●	○	●	○	■		■		
S101-06.9820-062-40.020R/L		6,2	6	5,25	2,95	5,95	0,5	0,2	40	43	●	●	○	●	○	■		■		

MATERIALI - MATERIALS Pag. 1199		VDI 3323 GR.	HB Rm ¹⁾ HRC ²⁾	Vc m/min			fn mm
				N3635	F7835		
P	ACCIAIO NON LEGATO - NOT ALLOY STEEL	1-5	125-300		80-200		0,02-0,08
	ACCIAIO POCO LEGATO - LOW ALLOY STEEL	6-9	180-350		80-170		0,02-0,08
	ACCIAIO ALTO LEGATO - ALLOY STEEL	10-11	200-325		60-110		0,02-0,08
	INOX MARTENS. - STAINLESS STEEL MART	12-13	200-240		50-100		0,02-0,08
M	INOX AUST. DUPLEX - STAINLESS STEEL AUST	14.1-14.2	180-230		20-80		0,02-0,08
K	GHISA GRIGIA - GREY CAST IRON	15-16	180-260	30-90	30-150		0,02-0,08
	GHISA SFEROIDALE - SPHEROIDAL GRAPHITE	17-18	160-250	25-80	30-130		0,02-0,08
	GHISA MALLEABILE - MALLEABLE CAST IRON	19-20	130-230	30-90	30-100		0,02-0,08
N	ALLUMINIO E SUE LEGHE - ALUMINIUM	21-25	60-130	80-150			0,02-0,08
	RAME E SUE LEGHE - COPPER	26-28	90-110	50-110			0,02-0,08
	NON METALLICI - PLASTICS	29-30	/	20-100			0,02-0,08
S	LEGHE RESIST. CALORE - HIG. TEMP. ALLOY	31-35	200-320		30-80		0,005-0,05
	TITANIO E SUE LEGHE - TITANIUM	36-37	400-1050 ¹⁾		30-80		0,005-0,05
H	ACCIAIO TEMPRATO - HARDENED STEEL	38-41	45-60 ²⁾				

$$n = \frac{Vc \cdot 1000}{\varnothing D \cdot 3,14} = \text{giri/min (min}^{-1}\text{)}$$

$$Vf = fn \cdot n = \text{mm/min}$$

Vc = m/min VELOCITÀ DI TAGLIO - CUTTING SPEED
n = giri/min (min⁻¹) NUMERO DI GIRI - NUMBER OF REVOLUTIONS
fn = mm AVANZAMENTO AL GIRO - FEED / REVOLUTION
Vf = mm/min VELOCITÀ DI AVANZAMENTO - FEED SPEED

NOTE - NOTES

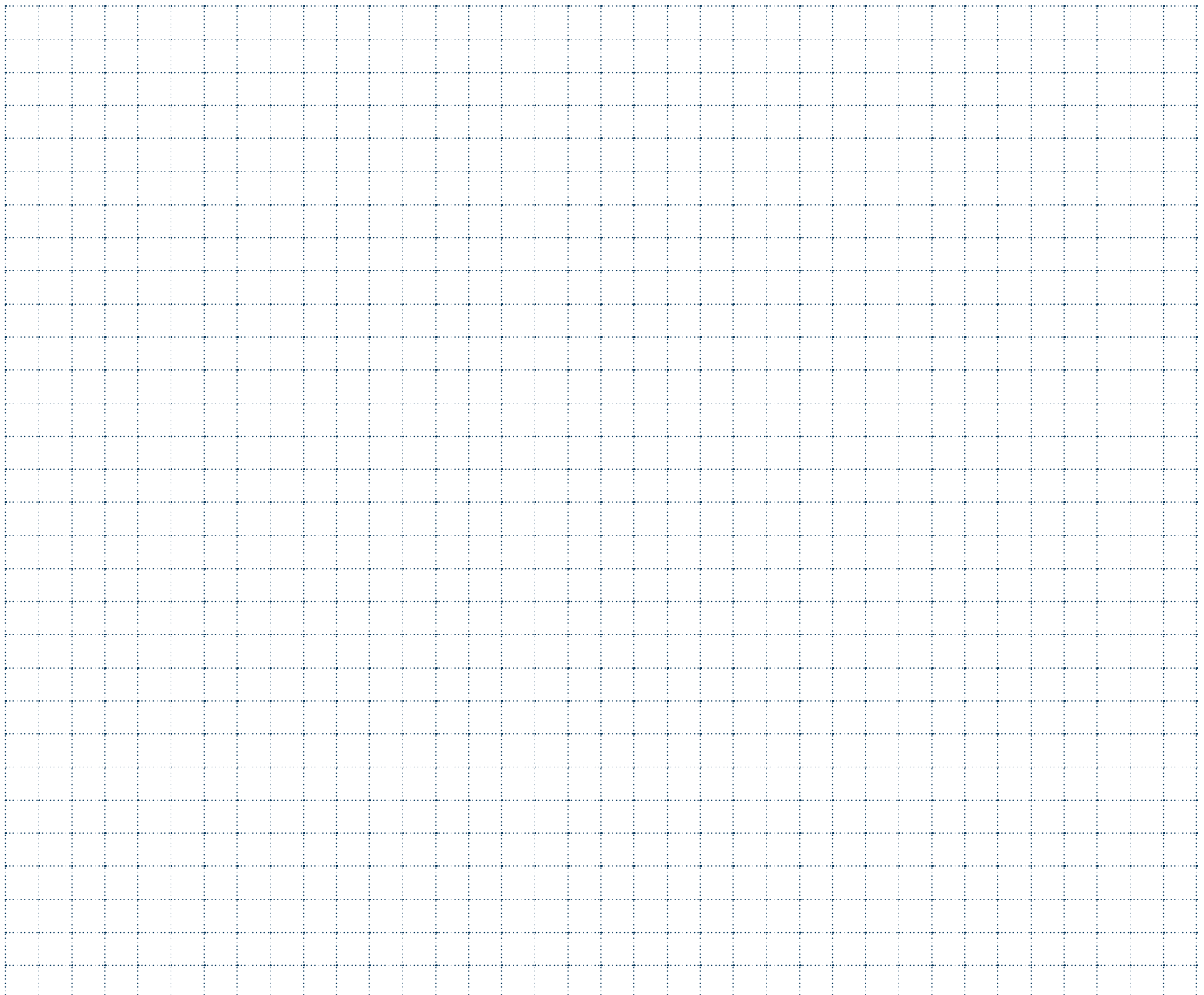

S101-07.9820-...R/L

Tornitura Interna - Internal Turning

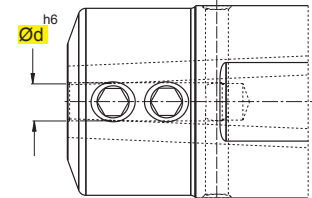
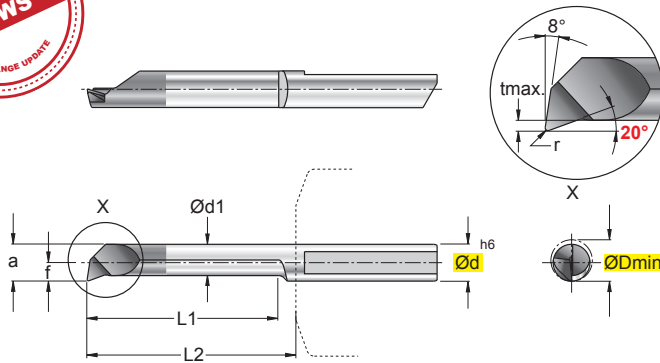
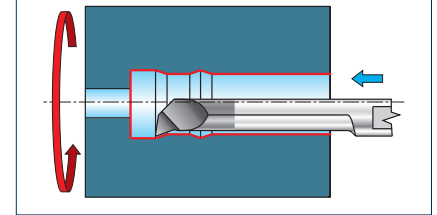

art. S100-TS-07..

In figura utensile destro - Right-hand shown

ART.	(mm)										P	M	K	N	S	H	HW		HC	
		ØDmin	Ød	Ød1	f	a	tmax	r	L1	L2							NON RIV. CEMENTED CARBIDE GRADES	RIVESTITI COATED GRADES BESCHICHTET RECOUVERTS	N3635	F7835
S101-07.9820-072-25.020R/L		7,2	7	6,25	3,45	6,95	0,5	0,2	25	28	●	●	○	●	○	■		■		
S101-07.9820-072-30.020R/L		7,2	7	6,25	3,45	6,95	0,5	0,2	30	33	●	●	○	●	○	■		■		
S101-07.9820-072-35.020R/L		7,2	7	6,25	3,45	6,95	0,5	0,2	35	38	●	●	○	●	○	■		■		
S101-07.9820-072-40.020R/L		7,2	7	6,25	3,45	6,95	0,5	0,2	40	43	●	●	○	●	○	■		■		
S101-07.9820-072-45.020R/L New		7,2	7	6,25	3,45	6,95	0,5	0,2	45	48	●	●	○	●	○	■		■	■	
S101-07.9820-072-50.020R/L		7,2	7	6,25	3,45	6,95	0,5	0,2	50	53	●	●	○	●	○	■		■		

MATERIALI - MATERIALS Pag. 1199		VDI 3323 GR.	HB Rm ¹⁾ HRC ²⁾	Vc m/min			fn mm
				N3635	F7835		
P	ACCIAIO NON LEGATO - NOT ALLOY STEEL	1-5	125-300		80-200		0,02-0,08
	ACCIAIO POCO LEGATO - LOW ALLOY STEEL	6-9	180-350		80-170		0,02-0,08
	ACCIAIO ALTO LEGATO - ALLOY STEEL	10-11	200-325		60-110		0,02-0,08
	INOX MARTENS. - STAINLESS STEEL MART	12-13	200-240		50-100		0,02-0,08
M	INOX AUST. DUPLEX - STAINLESS STEEL AUST	14.1-14.2	180-230		20-80		0,02-0,08
K	GHISA GRIGIA - GREY CAST IRON	15-16	180-260	30-90	30-150		0,02-0,08
	GHISA SFEROIDALE - SPHEROIDAL GRAPHITE	17-18	160-250	25-80	30-130		0,02-0,08
	GHISA MALLEABILE - MALLEABLE CAST IRON	19-20	130-230	30-90	30-100		0,02-0,08
N	ALLUMINIO E SUE LEGHE - ALUMINIUM	21-25	60-130	80-150			0,02-0,08
	RAME E SUE LEGHE - COPPER	26-28	90-110	50-110			0,02-0,08
	NON METALLICI - PLASTICS	29-30	/	20-100			0,02-0,08
S	LEGHE RESIST. CALORE - HIG. TEMP. ALLOY	31-35	200-320		30-80		0,005-0,05
	TITANIO E SUE LEGHE - TITANIUM	36-37	400-1050 ¹⁾		30-80		0,005-0,05
H	ACCIAIO TEMPRATO - HARDENED STEEL	38-41	45-60 ²⁾				

$$n = \frac{Vc \cdot 1000}{\varnothing D \cdot 3,14} = \text{giri/min (min}^{-1}\text{)}$$

$$Vf = fn \cdot n = \text{mm/min}$$

Vc = m/min VELOCITÀ DI TAGLIO - CUTTING SPEED
n = giri/min (min⁻¹) NUMERO DI GIRI - NUMBER OF REVOLUTIONS
fn = mm AVANZAMENTO AL GIRO - FEED / REVOLUTION
Vf = mm/min VELOCITÀ DI AVANZAMENTO - FEED SPEED

NOTE - NOTES

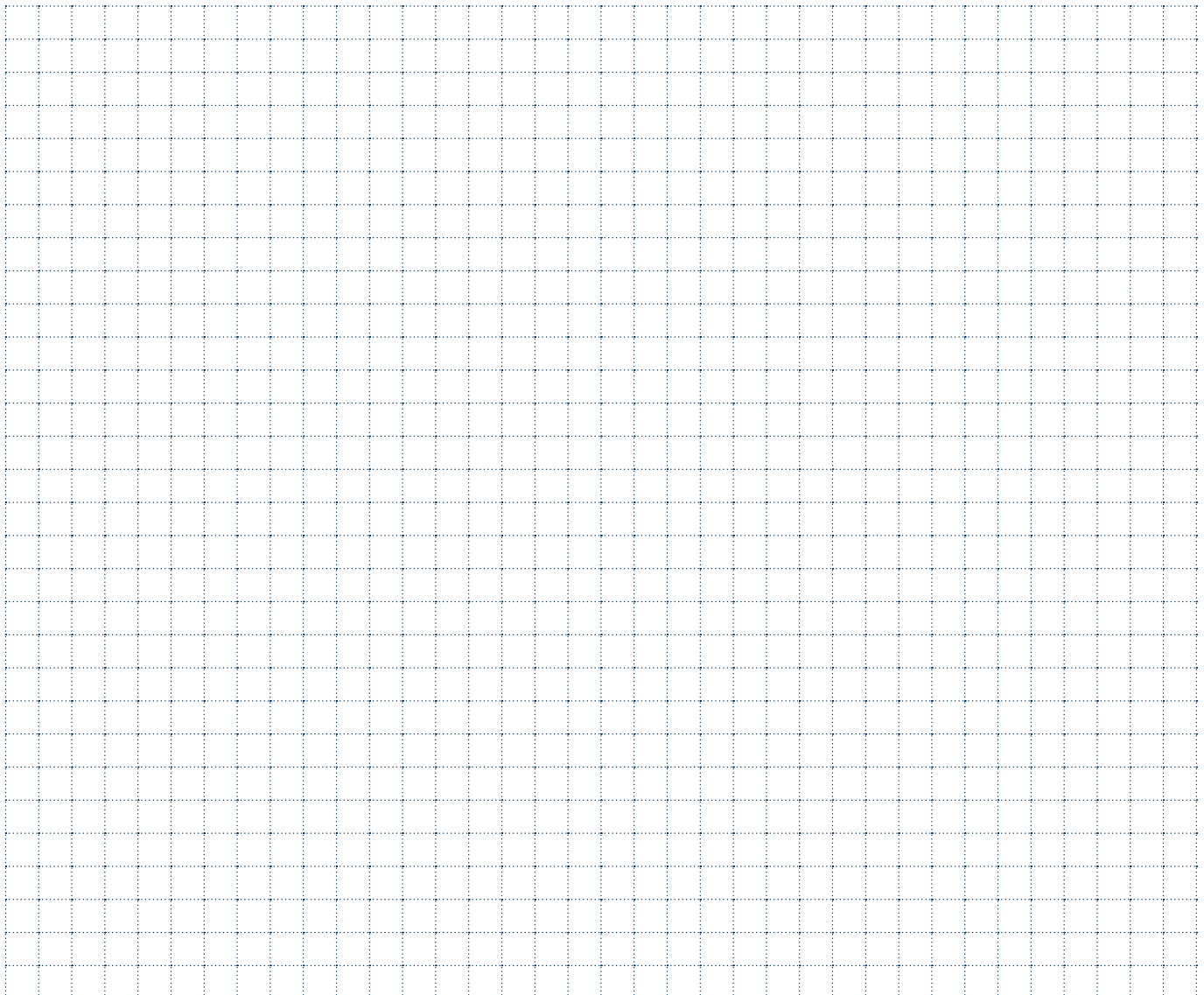

S101-...9847-...R/L

Tornitura Interna - Internal Turning

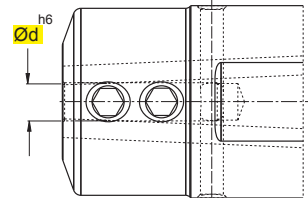
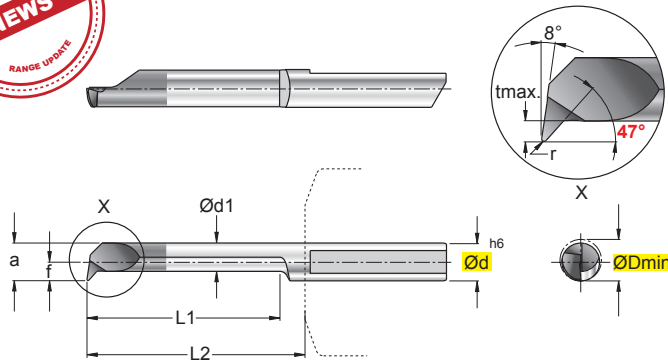
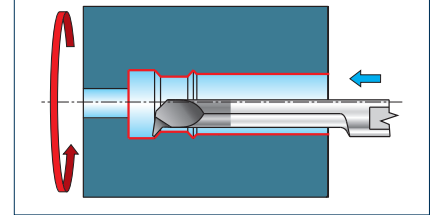

art. S100-TS-..

In figura utensile destro - Right-hand shown

ART.	(mm)										P	M	K	N	S	H	HW		HC	
	ØDmin	Ød	Ød1	f	a	tmax	r	L1	L2	NON RIV. CEMENTED CARBIDE GRADES							RIVESTITI COATED GRADES BESCHICHTET RECOUVERTS			
S101-04.9847-022-10.010R/L New	2,2	4	1,35	0,95	1,95	0,4	0,1	10	13	●	●	○	●	○		■		■		
S101-04.9847-027-15.010R/L New	2,7	4	1,75	1,2	2,45	0,5	0,1	15	18	●	●	○	●	○		■		■		
S101-04.9847-032-15.010R/L	3,2	4	2,15	1,45	2,95	0,6	0,1	15	18	●	●	○	●	○		■		■		
S101-04.9847-042-20.015R/L	4,2	4	2,95	1,95	3,95	0,8	0,15	20	23	●	●	○	●	○		■		■		
S101-05.9847-052-15.015R/L	5,2	5	3,75	2,45	4,95	1,0	0,15	15	18	●	●	○	●	○		■		■		
S101-05.9847-052-25.015R/L	5,2	5	3,75	2,45	4,95	1,0	0,15	25	28	●	●	○	●	○		■		■		
S101-06.9847-062-20.015R/L	6,2	6	3,95	2,95	5,95	1,8	0,15	20	23	●	●	○	●	○		■		■		
S101-06.9847-062-30.015R/L	6,2	6	3,95	2,95	5,95	1,8	0,15	30	33	●	●	○	●	○		■		■		
S101-07.9847-072-40.020R/L	7,2	7	4,15	3,45	6,95	2,5	0,2	40	43	●	●	○	●	○		■		■		

S101-05.9020-052...020R/L

Tornitura Interna - Internal Turning

NEW

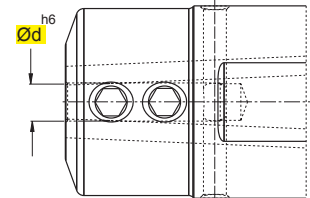
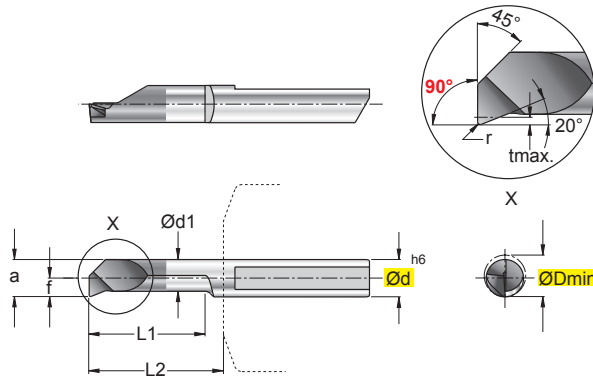
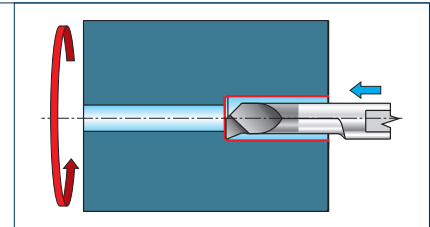

art. S100-TS-05..

In figura utensile destro - Right-hand shown

ART.	(mm)										P	M	K	N	S	H	HW		HC	
	 	ØDmin	Ød	Ød1	f	a	tmax	r	L1	L2							NON RIV. CEMENTED CARBIDE GRADES		RIVESTITI COATED GRADES BESCHICHTET RECOUVERTS	
																	N3635	F7835		
S101-05.9020-052-10.020R/L		5,2	5	4,25	2,45	4,95	0,5	0,2	10	13	●	●	○	●	○	■		■		
S101-05.9020-052-15.020R/L		5,2	5	4,25	2,45	4,95	0,5	0,2	15	18	●	●	○	●	○	■		■		
S101-05.9020-052-20.020R/L		5,2	5	4,25	2,45	4,95	0,5	0,2	20	23	●	●	○	●	○	■		■		

MATERIALI - MATERIALS Pag. 1199		VDI 3323 GR.	HB Rm ¹⁾ HRC ²⁾	Vc m/min			fn mm
				N3635	F7835		
P	ACCIAIO NON LEGATO - NOT ALLOY STEEL	1-5	125-300		80-200		0,02-0,08
	ACCIAIO POCO LEGATO - LOW ALLOY STEEL	6-9	180-350		80-170		0,02-0,08
	ACCIAIO ALTO LEGATO - ALLOY STEEL	10-11	200-325		60-110		0,02-0,08
	INOX MARTENS. - STAINLESS STEEL MART	12-13	200-240		50-100		0,02-0,08
M	INOX AUST. DUPLEX - STAINLESS STEEL AUST	14.1-14.2	180-230		20-80		0,02-0,08
K	GHISA GRIGIA - GREY CAST IRON	15-16	180-260	30-90	30-150		0,02-0,08
	GHISA SFEROIDALE - SPHEROIDAL GRAPHITE	17-18	160-250	25-80	30-130		0,02-0,08
	GHISA MALLEABILE - MALLEABLE CAST IRON	19-20	130-230	30-90	30-100		0,02-0,08
N	ALLUMINIO E SUE LEGHE - ALUMINIUM	21-25	60-130	80-150			0,02-0,08
	RAME E SUE LEGHE - COPPER	26-28	90-110	50-110			0,02-0,08
	NON METALLICI - PLASTICS	29-30	/	20-100			0,02-0,08
S	LEGHE RESIST. CALORE - HIG. TEMP. ALLOY	31-35	200-320		30-80		0,005-0,05
	TITANIO E SUE LEGHE - TITANIUM	36-37	400-1050 ¹⁾		30-80		0,005-0,05
H	ACCIAIO TEMPRATO - HARDENED STEEL	38-41	45-60 ²⁾				

$$n = \frac{Vc \cdot 1000}{\varnothing D \cdot 3,14} = \text{giri/min (min}^{-1}\text{)}$$

$$Vf = fn \cdot n = \text{mm/min}$$

Vc = m/min VELOCITÀ DI TAGLIO - CUTTING SPEED

n = giri/min (min⁻¹) NUMERO DI GIRI - NUMBER OF REVOLUTIONS

fn = mm AVANZAMENTO AL GIRO - FEED / REVOLUTION

Vf = mm/min VELOCITÀ DI AVANZAMENTO - FEED SPEED

NOTE - NOTES

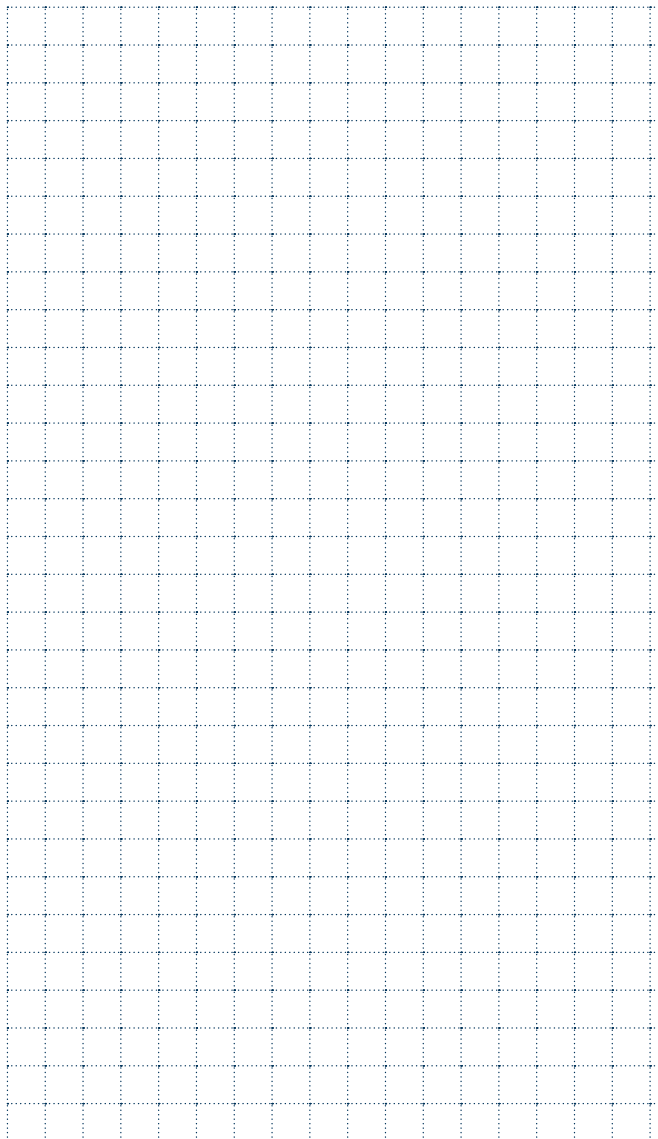
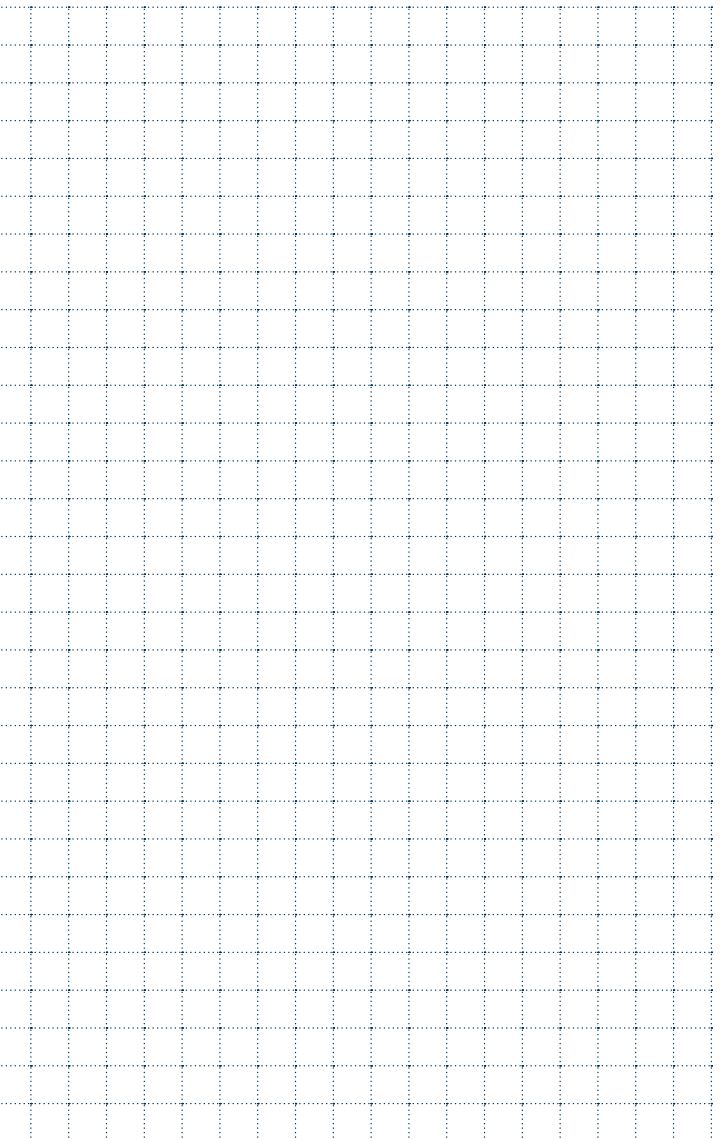
	
--	---

S102-04...-...R/L

Scanalatura - Grooving

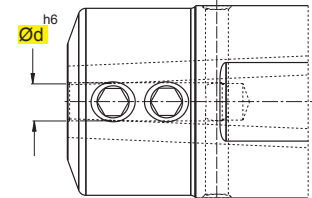
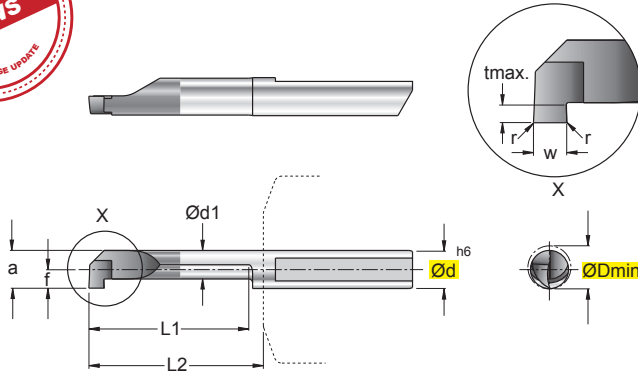
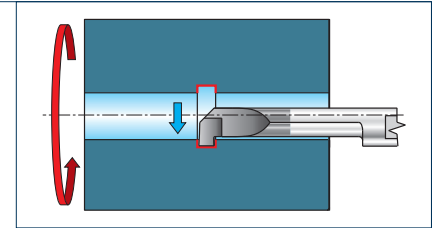

art. S100-TS-04..

In figura utensile destro - Right-hand shown

ART.	(mm)										P	M	K	N	S	H	HW		HC				
		ØDmin	Ød	Ød1	f	a	tmax	r	w	L1							L2	N3635	F7835	NON RIV. CEMENTED CARBIDE GRADES		RIVESTITI COATED GRADES	
																				+0.03 0		BESCHICHTET RECOUVERTS	
S102-04.0050-020-09.000R/L New		2,0	4	1,15	0,85	1,75	0,4	-	0,5	9	13	●	●	○	●	○	■		■				
S102-04.0070-030-08.000R/L		3,0	4	1,95	1,35	2,75	0,6	-	0,7	8	13	●	●	○	●	○	■		■				
S102-04.0079-042-10.000R/L New		4,2	4	2,95	1,95	3,95	0,8	-	0,79	10	13	●	●	○	●	○	■			■			
S102-04.0100-042-10.000R/L		4,2	4	2,95	1,95	3,95	0,8	-	1,0	10	13	●	●	○	●	○	■			■			
S102-04.0100-042-15.000R/L New		4,2	4	2,95	1,95	3,95	0,8	-	1,0	15	18	●	●	○	●	○	■			■			
S102-04.0100-042-20.000R/L		4,2	4	2,95	1,95	3,95	0,8	-	1,0	20	23	●	●	○	●	○	■			■			

MATERIALI - MATERIALS Pag. 1199		VDI 3323 GR.	HB Rm ¹⁾ HRC ²⁾	Vc m/min			fn mm
				N3635	F7835		
P	ACCIAIO NON LEGATO - NOT ALLOY STEEL	1-5	125-300		80-160		0,01-0,03
	ACCIAIO POCO LEGATO - LOW ALLOY STEEL	6-9	180-350		80-110		0,01-0,03
	ACCIAIO ALTO LEGATO - ALLOY STEEL	10-11	200-325		60-100		0,01-0,03
	INOX MARTENS. - STAINLESS STEEL MART	12-13	200-240		50-100		0,01-0,03
M	INOX AUST. DUPLEX - STAINLESS STEEL AUST	14.1-14.2	180-230		20-80		0,01-0,03
K	GHISA GRIGIA - GREY CAST IRON	15-16	180-260	30-90	30-150		0,01-0,03
	GHISA SFEROIDALE - SPHEROIDAL GRAPHITE	17-18	160-250	25-80	30-130		0,01-0,03
	GHISA MALLEABILE - MALLEABLE CAST IRON	19-20	130-230	30-90	30-100		0,01-0,03
N	ALLUMINIO E SUE LEGHE - ALUMINIUM	21-25	60-130	80-150			0,01-0,03
	RAME E SUE LEGHE - COPPER	26-28	90-110	50-110			0,01-0,03
	NON METALLICI - PLASTICS	29-30	/	20-80			0,01-0,03
S	LEGHE RESIST. CALORE - HIG. TEMP. ALLOY	31-35	200-320		30-80		0,01-0,03
	TITANIO E SUE LEGHE - TITANIUM	36-37	400-1050 ¹⁾		30-80		0,01-0,03
H	ACCIAIO TEMPRATO - HARDENED STEEL	38-41	45-60 ²⁾				

$$n = \frac{Vc \cdot 1000}{\varnothing D \cdot 3,14} = \text{giri/min (min}^{-1}\text{)}$$

$$Vf = fn \cdot n = \text{mm/min}$$

Vc = m/min VELOCITÀ DI TAGLIO - CUTTING SPEED
n = giri/min (min⁻¹) NUMERO DI GIRI - NUMBER OF REVOLUTIONS
fn = mm AVANZAMENTO AL GIRO - FEED / REVOLUTION
Vf = mm/min VELOCITÀ DI AVANZAMENTO - FEED SPEED

NOTE - NOTES

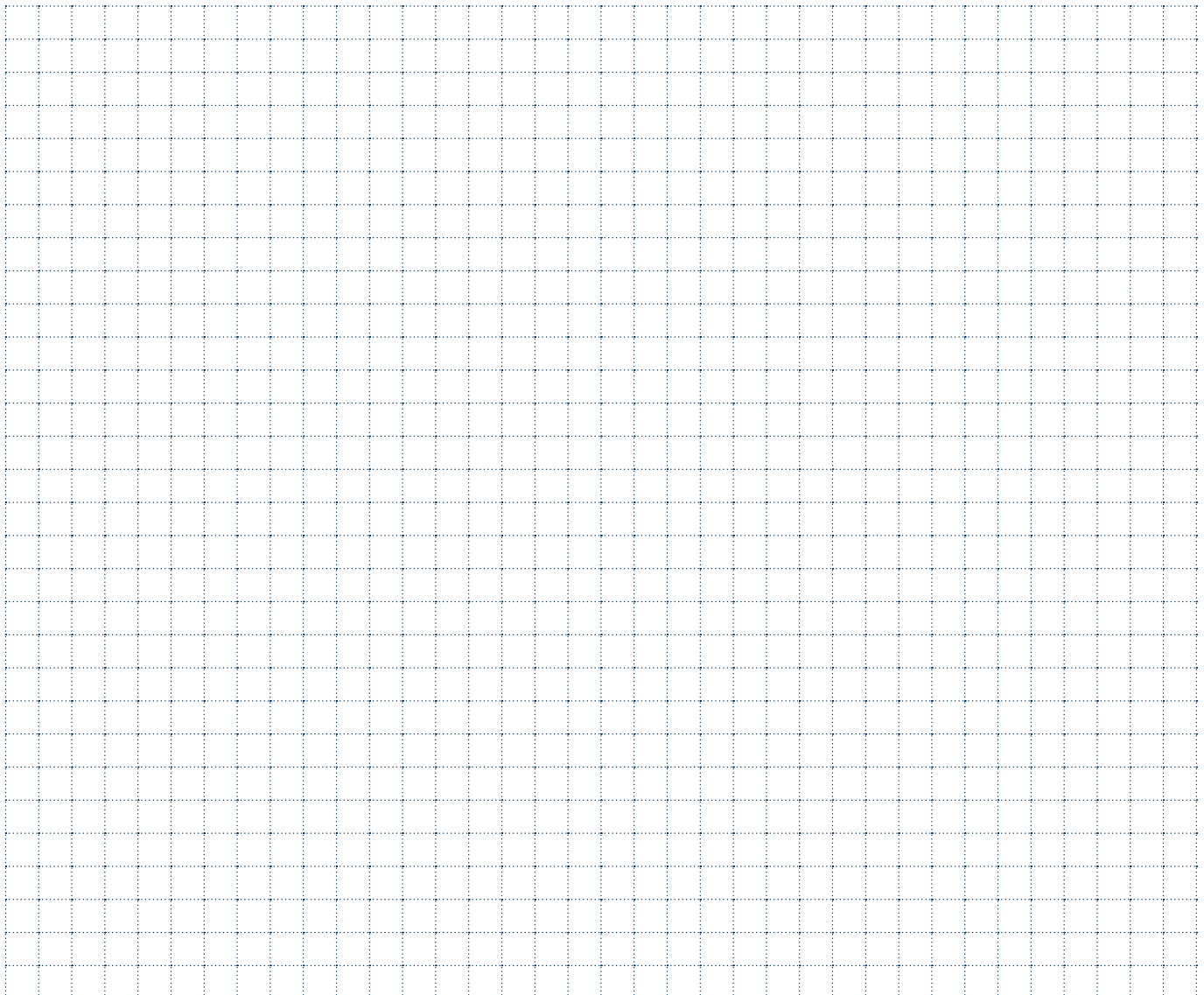

S102-05...-...R/L

Scanalatura - Grooving

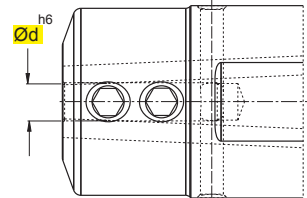
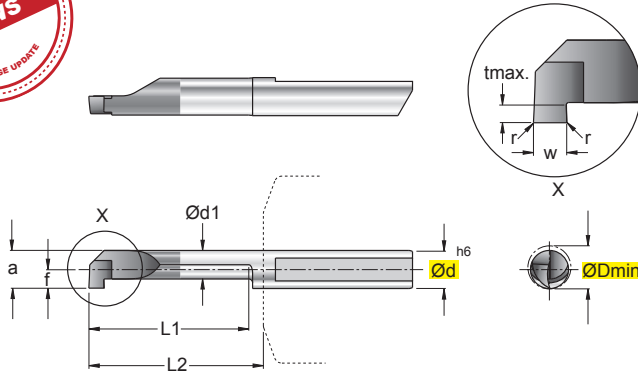
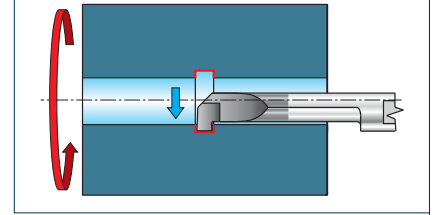

art. S100-TS-05..

In figura utensile destro - Right-hand shown

ART.	(mm)										P	M	K	N	S	H	HW		HC	
	ØDmin	Ød	Ød1	f	a	tmax	r	^{+0.03} ₀ w	L1	L2							N3635	F7835		
S102-05.0150-050-10.000R/L	5,0	5	3,30	1,9	4,40	1,0	-	1,5	10	13	●	●	○	●	○		■		■	
S102-05.0079-052-10.000R/L	5,2	5	3,75	2,45	4,95	1,0	-	0,79	10	13	●	●	○	●	○		■		■	
S102-05.0079-052-20.000R/L	5,2	5	3,75	2,45	4,95	1,0	-	0,79	20	23	●	●	○	●	○		■		■	
S102-05.0100-052-10.000R/L	5,2	5	3,75	2,45	4,95	1,0	-	1,0	10	13	●	●	○	●	○		■		■	
S102-05.0100-052-15.000R/L	5,2	5	3,75	2,45	4,95	1,0	-	1,0	15	18	●	●	○	●	○		■		■	
S102-05.0100-052-20.000R/L	5,2	5	3,75	2,45	4,95	1,0	-	1,0	20	23	●	●	○	●	○		■		■	
S102-05.0100-052-30.000R/L	5,2	5	3,75	2,45	4,95	1,0	-	1,0	30	33	●	●	○	●	○		■		■	
S102-05.0150-052-10.000R/L	5,2	5	3,75	2,45	4,95	1,0	-	1,5	10	13	●	●	○	●	○		■		■	
S102-05.0150-052-15.000R/L New	5,2	5	3,75	2,45	4,95	1,0	-	1,5	15	18	●	●	○	●	○		■		■	
S102-05.0150-052-20.000R/L	5,2	5	3,75	2,45	4,95	1,0	-	1,5	20	23	●	●	○	●	○		■		■	
S102-05.0150-052-25.000R/L	5,2	5	3,75	2,45	4,95	1,0	-	1,5	25	28	●	●	○	●	○		■		■	
S102-05.0150-052-30.000R/L	5,2	5	3,75	2,45	4,95	1,0	-	1,5	30	33	●	●	○	●	○		■		■	
S102-05.0150-052-35.000R/L	5,2	5	3,75	2,45	4,95	1,0	-	1,5	35	38	●	●	○	●	○		■		■	
S102-05.0200-052-10.000R/L	5,2	5	3,75	2,45	4,95	1,0	-	2,0	10	13	●	●	○	●	○		■		■	
S102-05.0200-052-15.000R/L	5,2	5	3,75	2,45	4,95	1,0	-	2,0	15	18	●	●	○	●	○		■		■	
S102-05.0200-052-20.000R/L	5,2	5	3,75	2,45	4,95	1,0	-	2,0	20	23	●	●	○	●	○		■		■	
S102-05.0200-052-25.000R/L New	5,2	5	3,75	2,45	4,95	1,0	-	2,0	25	28	●	●	○	●	○		■		■	
S102-05.0200-052-30.000R/L	5,2	5	3,75	2,45	4,95	1,0	-	2,0	30	33	●	●	○	●	○		■		■	

MATERIALI - MATERIALS Pag. 1199		VDI 3323 GR.	HB Rm ¹⁾ HRC ²⁾	Vc m/min			fn mm
				N3635	F7835		
P	ACCIAIO NON LEGATO - NOT ALLOY STEEL	1-5	125-300		80-160		0,01-0,03
	ACCIAIO POCO LEGATO - LOW ALLOY STEEL	6-9	180-350		80-110		0,01-0,03
	ACCIAIO ALTO LEGATO - ALLOY STEEL	10-11	200-325		60-100		0,01-0,03
	INOX MARTENS. - STAINLESS STEEL MART	12-13	200-240		50-100		0,01-0,03
M	INOX AUST. DUPLEX - STAINLESS STEEL AUST	14.1-14.2	180-230		20-80		0,01-0,03
K	GHISA GRIGIA - GREY CAST IRON	15-16	180-260	30-90	30-150		0,01-0,03
	GHISA SFEROIDALE - SPHEROIDAL GRAPHITE	17-18	160-250	25-80	30-130		0,01-0,03
	GHISA MALLEABILE - MALLEABLE CAST IRON	19-20	130-230	30-90	30-100		0,01-0,03
N	ALLUMINIO E SUE LEGHE - ALUMINIUM	21-25	60-130	80-150			0,01-0,03
	RAME E SUE LEGHE - COPPER	26-28	90-110	50-110			0,01-0,03
	NON METALLICI - PLASTICS	29-30	/	20-80			0,01-0,03
S	LEGHE RESIST. CALORE - HIG. TEMP. ALLOY	31-35	200-320		30-80		0,01-0,03
	TITANIO E SUE LEGHE - TITANIUM	36-37	400-1050 ¹⁾		30-80		0,01-0,03
H	ACCIAIO TEMPRATO - HARDENED STEEL	38-41	45-60 ²⁾				

$$n = \frac{Vc \cdot 1000}{\varnothing D \cdot 3,14} = \text{giri/min (min}^{-1}\text{)}$$

$$Vf = fn \cdot n = \text{mm/min}$$

Vc = m/min VELOCITÀ DI TAGLIO - CUTTING SPEED
n = giri/min (min⁻¹) NUMERO DI GIRI - NUMBER OF REVOLUTIONS
fn = mm AVANZAMENTO AL GIRO - FEED / REVOLUTION
Vf = mm/min VELOCITÀ DI AVANZAMENTO - FEED SPEED

NOTE - NOTES

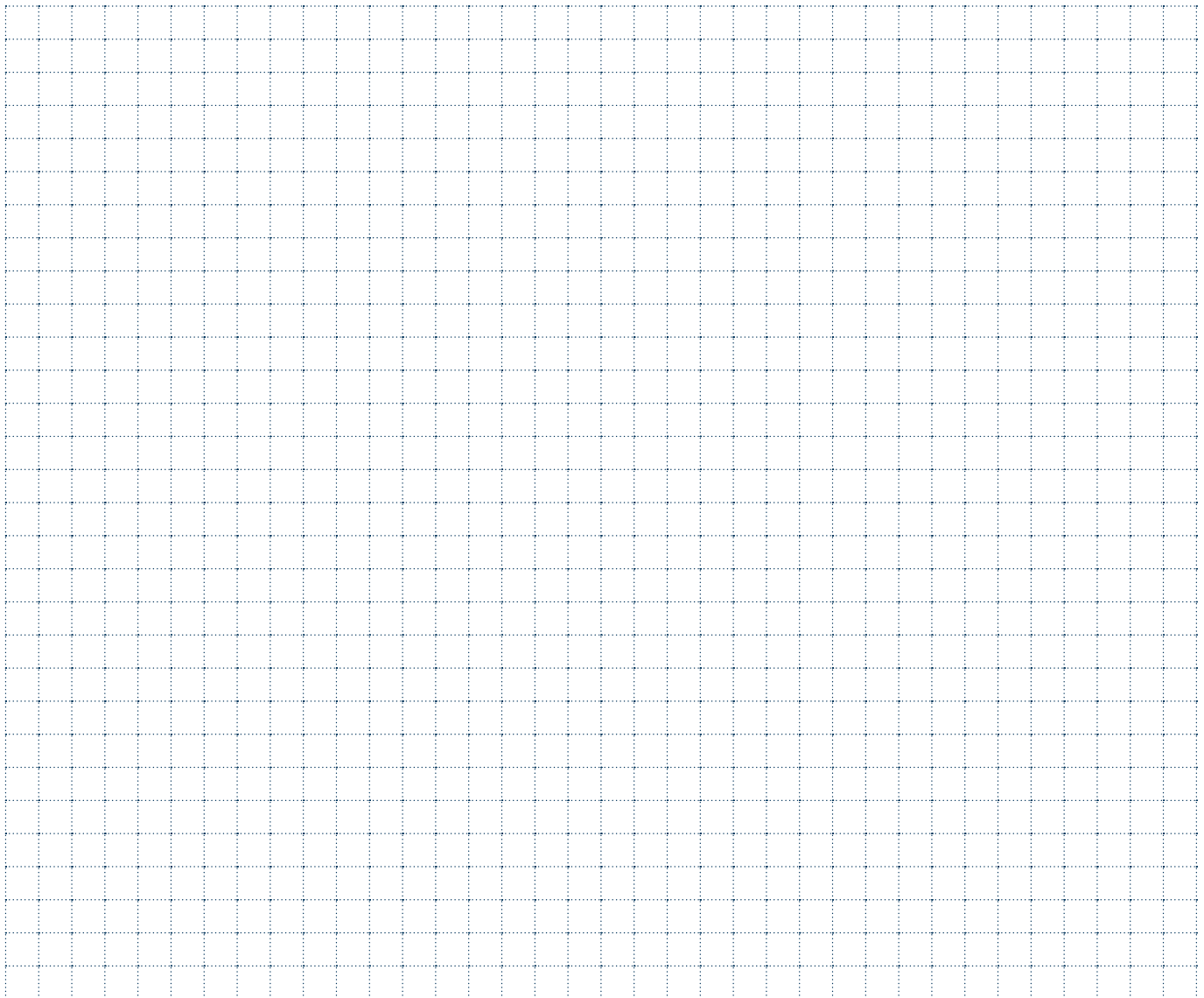

S102-06...-...R/L

Scanalatura - Grooving

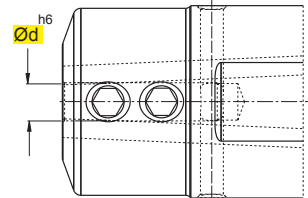
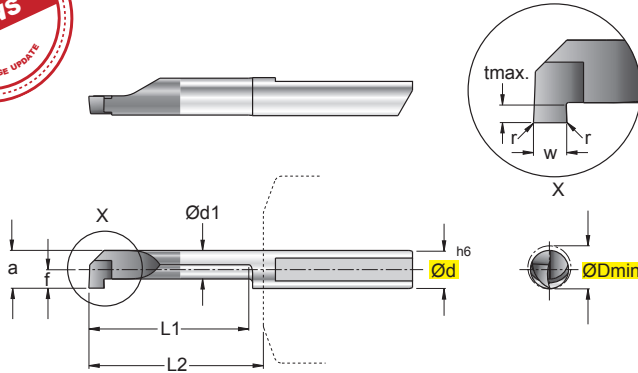
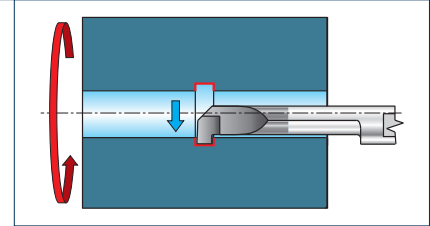

art. S100-TS-06..

In figura utensile destro - Right-hand shown

ART.	(mm)										P	M	K	N	S	H	HW		HC	
		ØDmin	Ød	Ød1	f	a	tmax	r	w	L1							L2	NON RIV.	RIVESTITI	
																		CEMENTED CARBIDE GRADES	COATED GRADES BESCHICHTET RECOUVERTS	
S102-06.0100-062-10.000R/L		6,2	6	3,95	2,95	5,95	1,8	-	1,0	10	13	●	●	○	●	○	■	■		
S102-06.0100-062-15.000R/L		6,2	6	3,95	2,95	5,95	1,8	-	1,0	15	18	●	●	○	●	○	■	■		
S102-06.0100-062-20.000R/L New		6,2	6	3,95	2,95	5,95	1,8	-	1,0	20	23	●	●	○	●	○	■	■		
S102-06.0100-062-25.000R/L		6,2	6	3,95	2,95	5,95	1,8	-	1,0	25	28	●	●	○	●	○	■	■		
S102-06.0100-062-35.000R/L		6,2	6	3,95	2,95	5,95	1,8	-	1,0	35	38	●	●	○	●	○	■	■		
S102-06.0150-062-10.000R/L New		6,2	6	3,95	2,95	5,95	1,8	-	1,5	10	13	●	●	○	●	○	■	■		
S102-06.0150-062-15.000R/L		6,2	6	3,95	2,95	5,95	1,8	-	1,5	15	18	●	●	○	●	○	■	■		
S102-06.0150-062-20.000R/L New		6,2	6	3,95	2,95	5,95	1,8	-	1,5	20	23	●	●	○	●	○	■	■		
S102-06.0150-062-25.000R/L		6,2	6	3,95	2,95	5,95	1,8	-	1,5	25	28	●	●	○	●	○	■	■		
S102-06.0150-062-35.000R/L		6,2	6	3,95	2,95	5,95	1,8	-	1,5	35	38	●	●	○	●	○	■	■		
S102-06.0200-062-10.000R/L New		6,2	6	3,95	2,95	5,95	1,8	-	2,0	10	13	●	●	○	●	○	■	■		
S102-06.0200-062-15.000R/L		6,2	6	3,95	2,95	5,95	1,8	-	2,0	15	18	●	●	○	●	○	■	■		
S102-06.0200-062-20.000R/L		6,2	6	3,95	2,95	5,95	1,8	-	2,0	20	23	●	●	○	●	○	■	■		
S102-06.0200-062-25.000R/L		6,2	6	3,95	2,95	5,95	1,8	-	2,0	25	28	●	●	○	●	○	■	■		
S102-06.0200-062-30.000R/L New		6,2	6	3,95	2,95	5,95	1,8	-	2,0	30	33	●	●	○	●	○	■	■		
S102-06.0200-062-35.000R/L		6,2	6	3,95	2,95	5,95	1,8	-	2,0	35	38	●	●	○	●	○	■	■		

MATERIALI - MATERIALS Pag. 1199		VDI 3323 GR.	HB Rm ¹⁾ HRC ²⁾	Vc m/min			fn mm
				N3635	F7835		
P	ACCIAIO NON LEGATO - NOT ALLOY STEEL	1-5	125-300		80-160		0,01-0,03
	ACCIAIO POCO LEGATO - LOW ALLOY STEEL	6-9	180-350		80-110		0,01-0,03
	ACCIAIO ALTO LEGATO - ALLOY STEEL	10-11	200-325		60-100		0,01-0,03
	INOX MARTENS. - STAINLESS STEEL MART	12-13	200-240		50-100		0,01-0,03
M	INOX AUST. DUPLEX - STAINLESS STEEL AUST	14.1-14.2	180-230		20-80		0,01-0,03
K	GHISA GRIGIA - GREY CAST IRON	15-16	180-260	30-90	30-150		0,01-0,03
	GHISA SFEROIDALE - SPHEROIDAL GRAPHITE	17-18	160-250	25-80	30-130		0,01-0,03
	GHISA MALLEABILE - MALLEABLE CAST IRON	19-20	130-230	30-90	30-100		0,01-0,03
N	ALLUMINIO E SUE LEGHE - ALUMINIUM	21-25	60-130	80-150			0,01-0,03
	RAME E SUE LEGHE - COPPER	26-28	90-110	50-110			0,01-0,03
	NON METALLICI - PLASTICS	29-30	/	20-80			0,01-0,03
S	LEGHE RESIST. CALORE - HIG. TEMP. ALLOY	31-35	200-320		30-80		0,01-0,03
	TITANIO E SUE LEGHE - TITANIUM	36-37	400-1050 ¹⁾		30-80		0,01-0,03
H	ACCIAIO TEMPRATO - HARDENED STEEL	38-41	45-60 ²⁾				

$$n = \frac{Vc \cdot 1000}{\varnothing D \cdot 3,14} = \text{giri/min (min}^{-1}\text{)}$$

$$Vf = fn \cdot n = \text{mm/min}$$

Vc = m/min VELOCITÀ DI TAGLIO - CUTTING SPEED
n = giri/min (min⁻¹) NUMERO DI GIRI - NUMBER OF REVOLUTIONS
fn = mm AVANZAMENTO AL GIRO - FEED / REVOLUTION
Vf = mm/min VELOCITÀ DI AVANZAMENTO - FEED SPEED

NOTE - NOTES

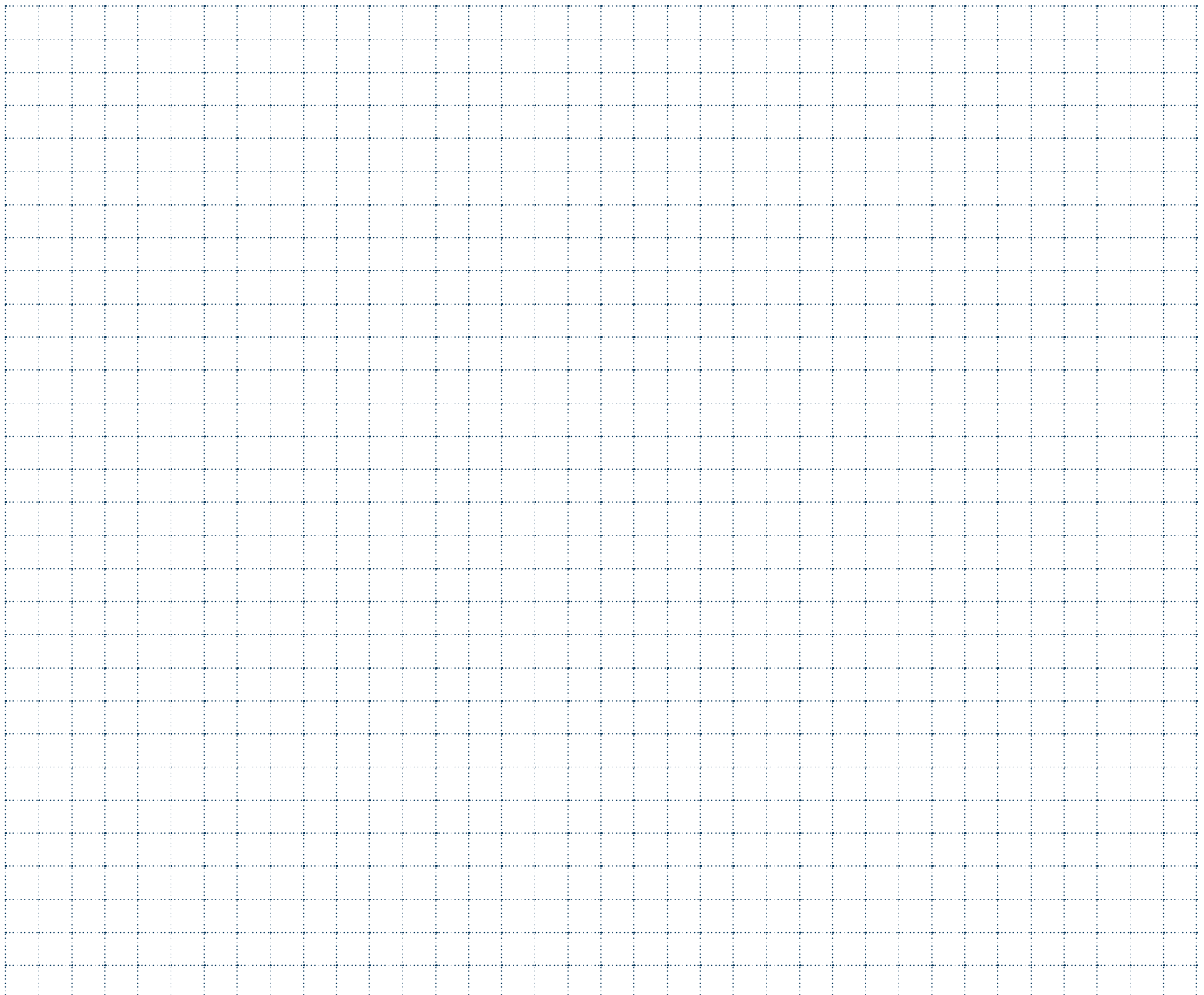

S102-07...-...R/L

Scanalatura - Grooving

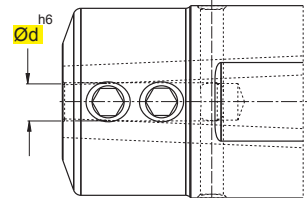
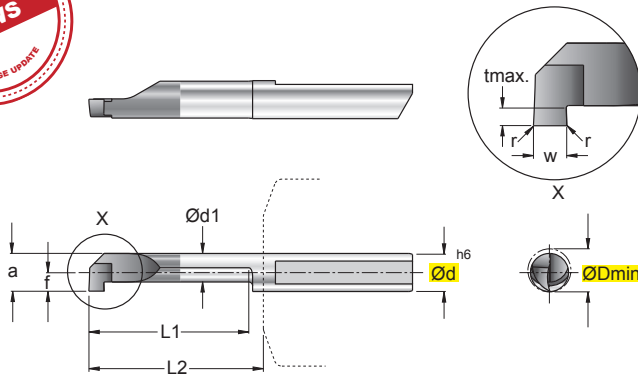
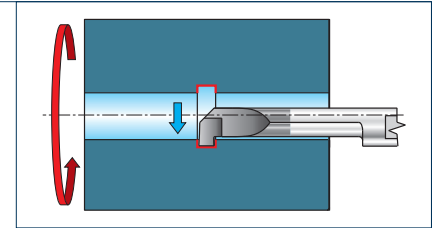

art. S100-TS-07..

In figura utensile destro - Right-hand shown

ART.	(mm)										P	M	K	N	S	H	HW		HC		
		ØDmin	Ød	Ød1	f	a	tmax	r	w	L1							L2	NON RIV. CEMENTED CARBIDE GRADES		RIVESTITI COATED GRADES BESCHICHTET RECOUVERTS	
																		N3635	F7835		
S102-07.0100-072-15.000R/L		7,2	7	4,25	3,45	6,95	2,5	-	1,0	15	18	●	●	○	●	○	■		■		
S102-07.0100-072-20.000R/L New		7,2	7	4,25	3,45	6,95	2,5	-	1,0	20	23	●	●	○	●	○	■		■		
S102-07.0100-072-25.000R/L		7,2	7	4,25	3,45	6,95	2,5	-	1,0	25	28	●	●	○	●	○	■		■		
S102-07.0100-072-35.000R/L		7,2	7	4,25	3,45	6,95	2,5	-	1,0	35	38	●	●	○	●	○	■		■		
S102-07.0150-072-10.000R/L New		7,2	7	4,25	3,45	6,95	2,5	-	1,5	10	13	●	●	○	●	○	■		■		
S102-07.0150-072-15.000R/L		7,2	7	4,25	3,45	6,95	2,5	-	1,5	15	18	●	●	○	●	○	■		■		
S102-07.0150-072-20.000R/L New		7,2	7	4,25	3,45	6,95	2,5	-	1,5	20	23	●	●	○	●	○	■		■		
S102-07.0150-072-25.000R/L		7,2	7	4,25	3,45	6,95	2,5	-	1,5	25	28	●	●	○	●	○	■		■		
S102-07.0150-072-30.000R/L New		7,2	7	4,25	3,45	6,95	2,5	-	1,5	30	33	●	●	○	●	○	■		■		
S102-07.0150-072-35.000R/L		7,2	7	4,25	3,45	6,95	2,5	-	1,5	35	38	●	●	○	●	○	■		■		
S102-07.0150-072-40.000R/L New		7,2	7	4,25	3,45	6,95	2,5	-	1,5	40	43	●	●	○	●	○	■		■		
S102-07.0157-072-10.000R/L		7,2	7	4,25	3,45	6,95	2,5	-	1,57	10	13	●	●	○	●	○	■		■		
S102-07.0200-072-10.000R/L		7,2	7	4,25	3,45	6,95	2,5	-	2,0	10	13	●	●	○	●	○	■		■		
S102-07.0200-072-15.000R/L		7,2	7	4,25	3,45	6,95	2,5	-	2,0	15	18	●	●	○	●	○	■		■		
S102-07.0200-072-20.000R/L		7,2	7	4,25	3,45	6,95	2,5	-	2,0	20	23	●	●	○	●	○	■		■		
S102-07.0200-072-25.000R/L		7,2	7	4,25	3,45	6,95	2,5	-	2,0	25	28	●	●	○	●	○	■		■		
S102-07.0200-072-30.000R/L		7,2	7	4,25	3,45	6,95	2,5	-	2,0	30	33	●	●	○	●	○	■		■		
S102-07.0200-072-35.000R/L		7,2	7	4,25	3,45	6,95	2,5	-	2,0	35	38	●	●	○	●	○	■		■		

MATERIALI - MATERIALS Pag. 1199		VDI 3323 GR.	HB Rm ¹⁾ HRC ²⁾	Vc m/min			fn mm
				N3635	F7835		
P	ACCIAIO NON LEGATO - NOT ALLOY STEEL	1-5	125-300		80-160		0,01-0,03
	ACCIAIO POCO LEGATO - LOW ALLOY STEEL	6-9	180-350		80-110		0,01-0,03
	ACCIAIO ALTO LEGATO - ALLOY STEEL	10-11	200-325		60-100		0,01-0,03
	INOX MARTENS. - STAINLESS STEEL MART	12-13	200-240		50-100		0,01-0,03
M	INOX AUST. DUPLEX - STAINLESS STEEL AUST	14.1-14.2	180-230		20-80		0,01-0,03
K	GHISA GRIGIA - GREY CAST IRON	15-16	180-260	30-90	30-150		0,01-0,03
	GHISA SFEROIDALE - SPHEROIDAL GRAPHITE	17-18	160-250	25-80	30-130		0,01-0,03
	GHISA MALLEABILE - MALLEABLE CAST IRON	19-20	130-230	30-90	30-100		0,01-0,03
N	ALLUMINIO E SUE LEGHE - ALUMINIUM	21-25	60-130	80-150			0,01-0,03
	RAME E SUE LEGHE - COPPER	26-28	90-110	50-110			0,01-0,03
	NON METALLICI - PLASTICS	29-30	/	20-80			0,01-0,03
S	LEGHE RESIST. CALORE - HIG. TEMP. ALLOY	31-35	200-320		30-80		0,01-0,03
	TITANIO E SUE LEGHE - TITANIUM	36-37	400-1050 ¹⁾		30-80		0,01-0,03
H	ACCIAIO TEMPRATO - HARDENED STEEL	38-41	45-60 ²⁾				

$$n = \frac{Vc \cdot 1000}{\varnothing D \cdot 3,14} = \text{giri/min (min}^{-1}\text{)}$$

$$Vf = fn \cdot n = \text{mm/min}$$

Vc = m/min VELOCITÀ DI TAGLIO - CUTTING SPEED
n = giri/min (min⁻¹) NUMERO DI GIRI - NUMBER OF REVOLUTIONS
fn = mm AVANZAMENTO AL GIRO - FEED / REVOLUTION
Vf = mm/min VELOCITÀ DI AVANZAMENTO - FEED SPEED

NOTE - NOTES

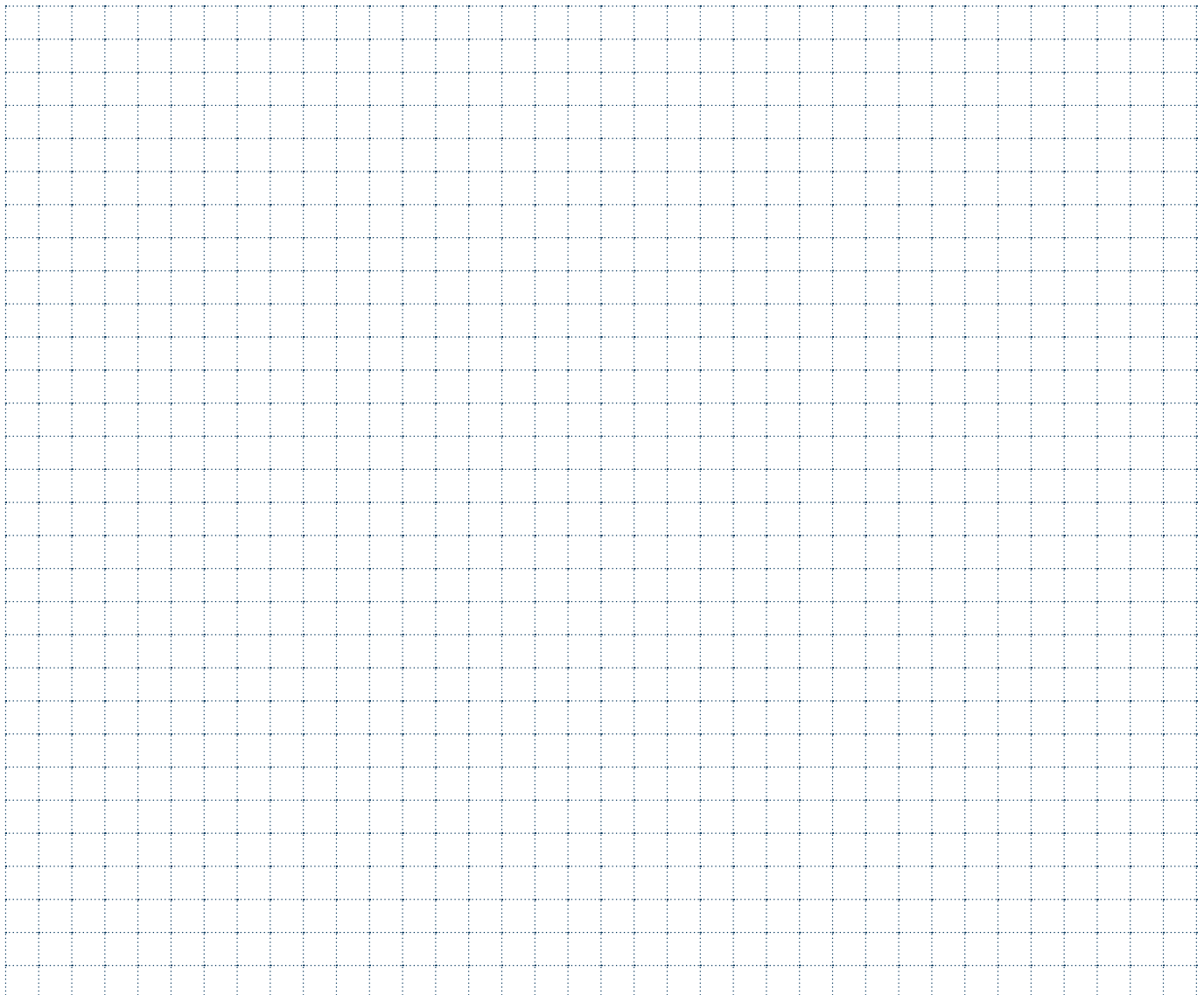

S102-...R...-...R/L

Scanalatura - Grooving

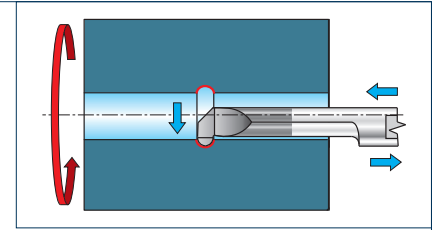

NEW

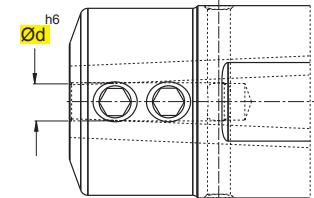
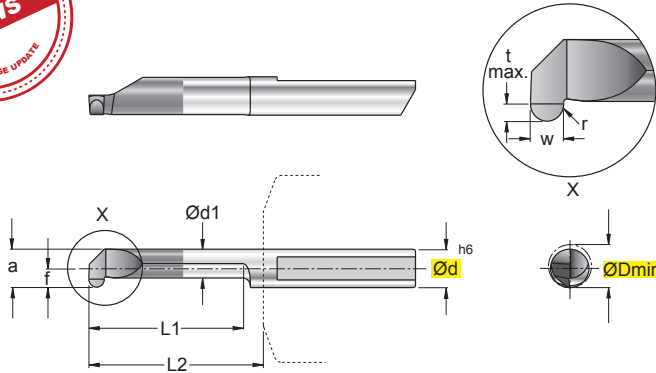

art. S100-TS-..

In figura utensile destro - Right-hand shown

ART.	(mm)										P	M	K	N	S	H	HW		HC	
	ØDmin	Ød	Ød1	f	a	tmax	r	^{+0.03} ₀ w	L1	L2							NON RIV. CEMENTED CARBIDE GRADES	RIVESTITI COATED GRADES BESCHICHTET RECOUVERTS		
S102-04.R100-042-15.050R/L New	4,2	4	2,95	1,95	3,95	0,8	0,5	1	15	18	●	●	○	●	○		■		■	
S102-05.R100-052-20.050R/L	5,2	5	3,75	2,45	4,95	1,0	0,5	1	20	23	●	●	○	●	○		■		■	
S102-05.R200-052-20.100R/L	5,2	5	3,75	2,45	4,95	1,0	1,0	2	20	23	●	●	○	●	○		■		■	
S102-06.R100-062-25.050R/L	6,2	6	3,95	2,95	5,95	1,8	0,5	1	25	28	●	●	○	●	○		■		■	
S102-06.R150-062-25.075R/L New	6,2	6	3,95	2,95	5,95	1,8	0,75	1,5	25	28	●	●	○	●	○		■		■	
S102-06.R200-062-20.100R/L New	6,2	6	3,95	2,95	5,95	1,8	1,0	2	20	23	●	●	○	●	○		■		■	
S102-06.R200-062-25.100R/L	6,2	6	3,95	2,95	5,95	1,8	1,0	2	25	28	●	●	○	●	○		■		■	
S102-07.R100-072-30.050R/L New	7,2	7	4,25	3,45	6,95	2,5	0,5	1	30	33	●	●	○	●	○		■		■	
S102-07.R150-072-30.075R/L New	7,2	7	4,25	3,45	6,95	2,5	0,75	1,5	30	33	●	●	○	●	○		■		■	
S102-07.R200-072-30.100R/L New	7,2	7	4,25	3,45	6,95	2,5	1,0	2	30	33	●	●	○	●	○		■		■	

MATERIALI - MATERIALS Pag. 1199		VDI 3323 GR.	HB Rm ¹⁾ HRC ²⁾	Vc m/min			fn mm
				N3635	F7835		
P	ACCIAIO NON LEGATO - NOT ALLOY STEEL	1-5	125-300		80-160		0,01-0,03
	ACCIAIO POCO LEGATO - LOW ALLOY STEEL	6-9	180-350		80-110		0,01-0,03
	ACCIAIO ALTO LEGATO - ALLOY STEEL	10-11	200-325		60-100		0,01-0,03
	INOX MARTENS. - STAINLESS STEEL MART	12-13	200-240		50-100		0,01-0,03
M	INOX AUST. DUPLEX - STAINLESS STEEL AUST	14.1-14.2	180-230		20-80		0,01-0,03
K	GHISA GRIGIA - GREY CAST IRON	15-16	180-260	30-90	30-150		0,01-0,03
	GHISA SFEROIDALE - SPHEROIDAL GRAPHITE	17-18	160-250	25-80	30-130		0,01-0,03
	GHISA MALLEABILE - MALLEABLE CAST IRON	19-20	130-230	30-90	30-100		0,01-0,03
N	ALLUMINIO E SUE LEGHE - ALUMINIUM	21-25	60-130	80-150			0,01-0,03
	RAME E SUE LEGHE - COPPER	26-28	90-110	50-110			0,01-0,03
	NON METALLICI - PLASTICS	29-30	/	20-80			0,01-0,03
S	LEGHE RESIST. CALORE - HIG. TEMP. ALLOY	31-35	200-320		30-80		0,01-0,03
	TITANIO E SUE LEGHE - TITANIUM	36-37	400-1050 ¹⁾		30-80		0,01-0,03
H	ACCIAIO TEMPRATO - HARDENED STEEL	38-41	45-60 ²⁾				

$$n = \frac{Vc \cdot 1000}{\varnothing D \cdot 3,14} = \text{giri/min (min}^{-1}\text{)}$$

$$Vf = fn \cdot n = \text{mm/min}$$

- Vc** = m/min VELOCITÀ DI TAGLIO - CUTTING SPEED
n = giri/min (min⁻¹) NUMERO DI GIRI - NUMBER OF REVOLUTIONS
fn = mm AVANZAMENTO AL GIRO - FEED / REVOLUTION
Vf = mm/min VELOCITÀ DI AVANZAMENTO - FEED SPEED

NOTE - NOTES

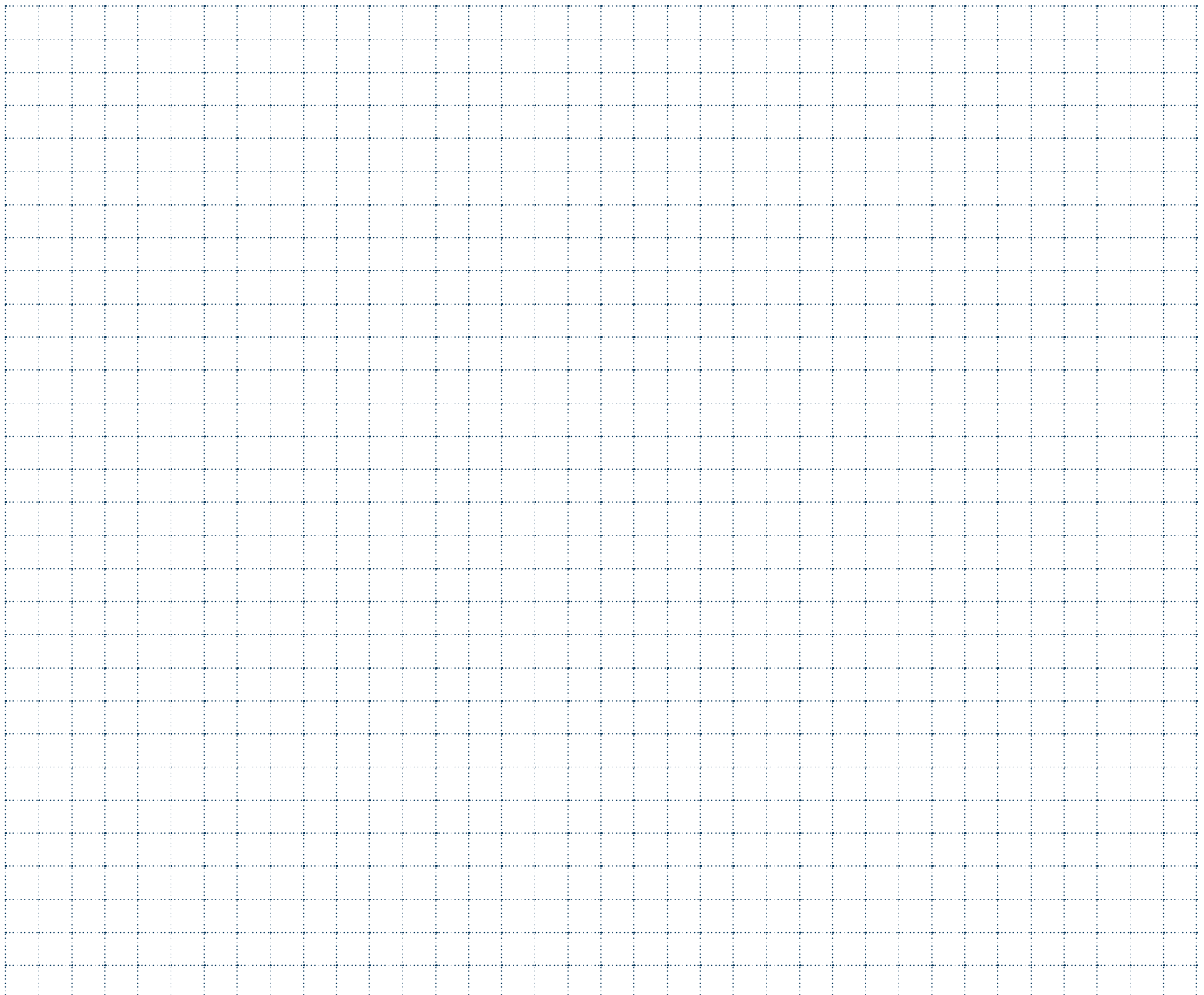

S105-...0100-...000R/L

**Pretaglio e smussatura
Pre-part-Off and Chamfering**

NEW

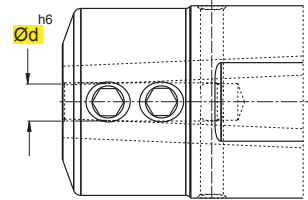
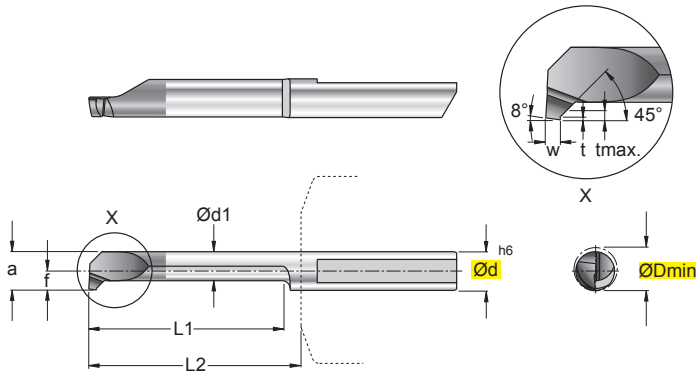
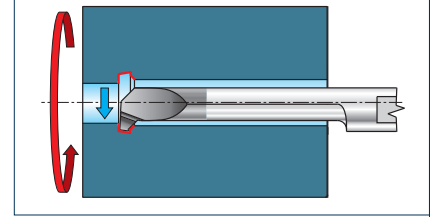

art. S100-TS-..

In figura utensile destro - Right-hand shown

ART.	(mm)											P	M	K	N	S	H	HW		HC	
	 	ØDmin	Ød	Ød1	f	a	t	tmax	w	L1	L2							NON RIV. CEMENTED CARBIDE GRADES		RIVESTITI COATED GRADES	
																		N3635	F7835	BESCHICHTET	RECOUVERTS
S105-04.0100-037-10.000R/L		3,7	4	2,45	1,7	3,45	0,2	0,7	1	10	13	●	●	○	●	○	■		■		
S105-04.0100-037-15.000R/L		3,7	4	2,45	1,7	3,45	0,2	0,7	1	15	18	●	●	○	●	○	■		■		
S105-04.0100-042-20.000R/L		4,2	4	2,95	1,95	3,95	0,2	0,7	1	20	23	●	●	○	●	○	■		■		
S105-04.0100-042-25.000R/L New		4,2	4	2,95	1,95	3,95	0,2	0,7	1	25	28	●	●	○	●	○	■		■		
S105-05.0100-052-15.000R/L		5,2	5	3,75	2,45	4,95	0,2	0,7	1	15	18	●	●	○	●	○	■		■		
S105-05.0100-052-20.000R/L		5,2	5	3,75	2,45	4,95	0,2	0,7	1	20	23	●	●	○	●	○	■		■		
S105-05.0100-052-25.000R/L		5,2	5	3,75	2,45	4,95	0,2	0,7	1	25	28	●	●	○	●	○	■		■		
S105-05.0100-052-30.000R/L		5,2	5	3,75	2,45	4,95	0,2	0,7	1	30	33	●	●	○	●	○	■		■		
S105-06.0100-062-30.000R/L		6,2	6	3,95	2,95	5,95	0,2	0,7	1	30	33	●	●	○	●	○	■		■		
S105-06.0100-062-40.000R/L		6,2	6	3,95	2,95	5,95	0,2	0,7	1	40	43	●	●	○	●	○	■		■		

■ DISPONIBILI - IN STOCK - LIEFERBAR - DISPONIBLES / ■ **NEW**
●● APPLICAZIONE CONSIGLIATA-RECOMMENDED APPLICATION
EMPFOLHENER EINSATZ - APPLICATION CONSEILLÉE

□ A RICHIESTA - ON REQUEST - AUF ANFRAGE - SUR DEMANDE / □ **NEW**
○○ APPLICAZIONE POSSIBILE - POSSIBLE APPLICATION
MÖGLICHE ANWENDUNG - APPLICATION POSSIBLE

MATERIALI - MATERIALS Pag. 1199		VDI 3323 GR.	HB Rm ¹⁾ HRC ²⁾	Vc m/min			fz mm
				N3635	F7835		
P	ACCIAIO NON LEGATO - NOT ALLOY STEEL	1-5	125-300		80-160		0,01-0,03
	ACCIAIO POCO LEGATO - LOW ALLOY STEEL	6-9	180-350		80-110		0,01-0,03
	ACCIAIO ALTO LEGATO - ALLOY STEEL	10-11	200-325		60-100		0,01-0,03
	INOX MARTENS. - STAINLESS STEEL MART	12-13	200-240		50-100		0,01-0,03
M	INOX AUST. DUPLEX - STAINLESS STEEL AUST	14.1-14.2	180-230		20-80		0,01-0,03
K	GHISA GRIGIA - GREY CAST IRON	15-16	180-260	30-90	30-150		0,01-0,03
	GHISA SFEROIDALE - SPHEROIDAL GRAPHITE	17-18	160-250	25-80	30-130		0,01-0,03
	GHISA MALLEABILE - MALLEABLE CAST IRON	19-20	130-230	30-90	30-100		0,01-0,03
N	ALLUMINIO E SUE LEGHE - ALUMINIUM	21-25	60-130	80-150			0,01-0,03
	RAME E SUE LEGHE - COPPER	26-28	90-110	50-110			0,01-0,03
	NON METALLICI - PLASTICS	29-30	/	20-80			0,01-0,03
S	LEGHE RESIST. CALORE - HIG. TEMP. ALLOY	31-35	200-320		30-80		0,01-0,03
	TITANIO E SUE LEGHE - TITANIUM	36-37	400-1050 ¹⁾		30-80		0,01-0,03
H	ACCIAIO TEMPRATO - HARDENED STEEL	38-41	45-60 ²⁾				

$$n = \frac{Vc \cdot 1000}{\varnothing D \cdot 3,14} = \text{giri/min (min}^{-1}\text{)}$$

$$Vf = fn \cdot n = \text{mm/min}$$

- Vc** = m/min VELOCITÀ DI TAGLIO - CUTTING SPEED
n = giri/min (min⁻¹) NUMERO DI GIRI - NUMBER OF REVOLUTIONS
fn = mm AVANZAMENTO AL GIRO - FEED / REVOLUTION
Vf = mm/min VELOCITÀ DI AVANZAMENTO - FEED SPEED

NOTE - NOTES

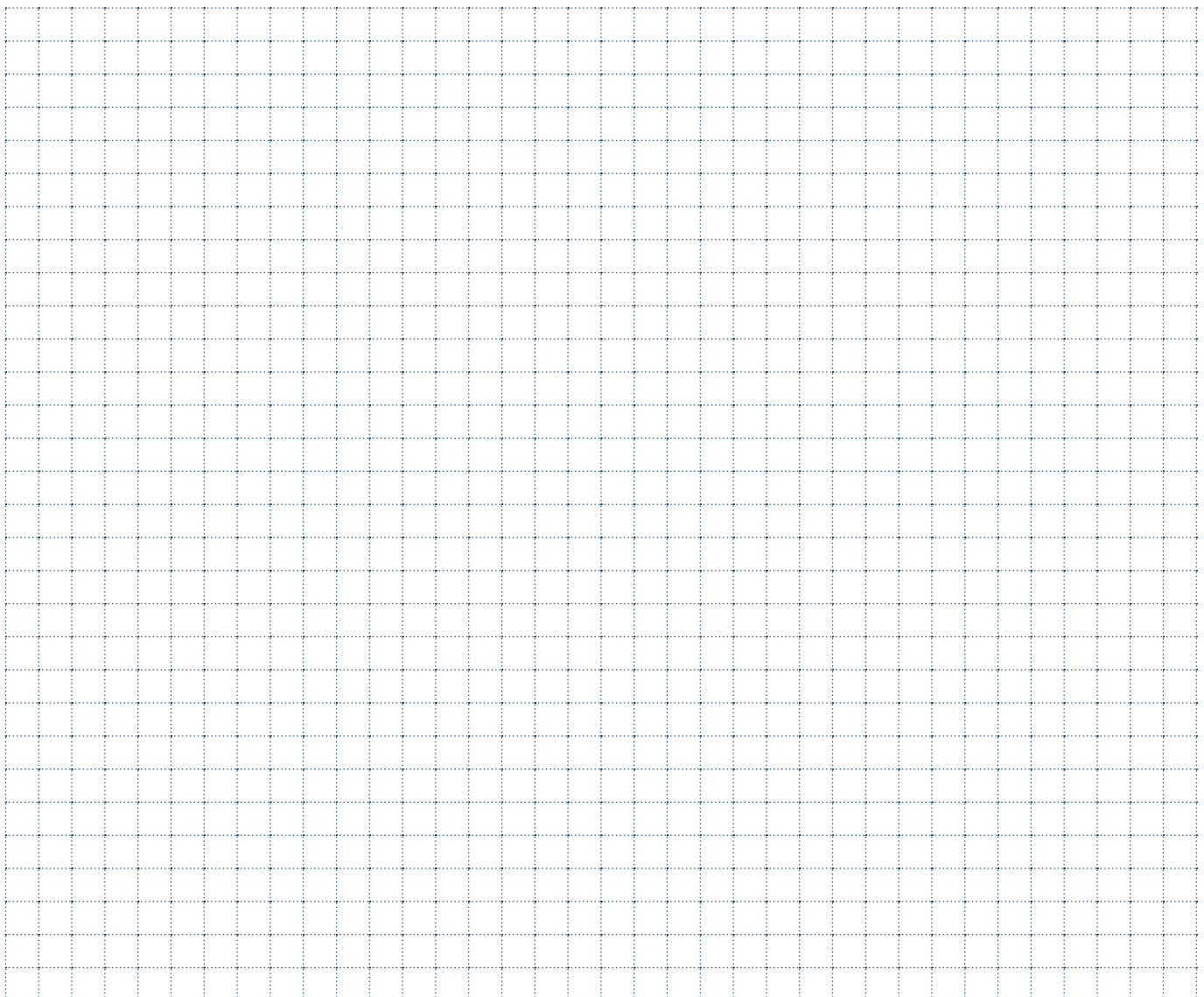

S103-06...-I62-15.015R/L

Scanalatura Frontale - Face Grooving

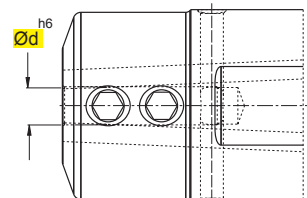
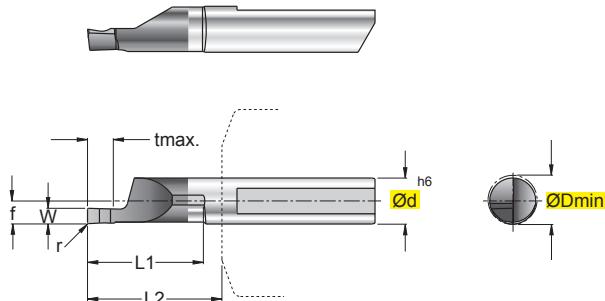
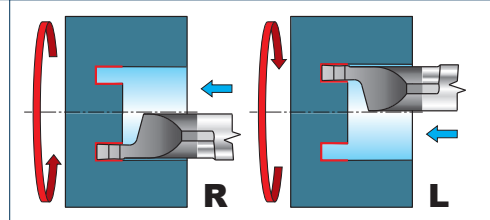

art. S100-TS-06..

In figura utensile destro - Right-hand shown

ART.	(mm)									P	M	K	N	S	H	HW		HC	
	 	ØDmin	Ød	f	tmax	r	$\begin{matrix} +0,05 \\ 0 \end{matrix}$ w	L1	L2							NON RIV.	RIVESTITI		
																CEMENTED	COATED GRADES		
S103-06.0100-I62-15.015R/L		6,2	6	2,95	2	0,15	1,0	15	18	●	●	○	●	○		■		■	
S103-06.0150-I62-15.015R/L		6,2	6	2,95	3	0,15	1,5	15	18	●	●	○	●	○		■		■	
S103-06.0200-I62-15.015R/L		6,2	6	2,95	4	0,15	2,0	15	18	●	●	○	●	○		■		■	
S103-06.0239-I62-15.015R/L		6,2	6	2,95	5	0,15	2,39	15	18	●	●	○	●	○		■		■	
S103-06.0250-I62-15.015R/L		6,2	6	2,95	5	0,15	2,5	15	18	●	●	○	●	○		■		■	
S103-06.0300-I62-15.015R/L		6,2	6	2,95	6	0,15	3,0	15	18	●	●	○	●	○		■		■	

MATERIALI - MATERIALS Pag. 1199		VDI 3323 GR.	HB Rm ¹⁾ HRC ²⁾	Vc m/min			fn mm
				N3635	F7835		
P	ACCIAIO NON LEGATO - NOT ALLOY STEEL	1-5	125-300		80-160		0,01-0,05
	ACCIAIO POCO LEGATO - LOW ALLOY STEEL	6-9	180-350		80-110		0,01-0,05
	ACCIAIO ALTO LEGATO - ALLOY STEEL	10-11	200-325		60-100		0,01-0,05
	INOX MARTENS. - STAINLESS STEEL MART	12-13	200-240		50-100		0,01-0,05
M	INOX AUST. DUPLEX - STAINLESS STEEL AUST	14.1-14.2	180-230		20-80		0,01-0,05
K	GHISA GRIGIA - GREY CAST IRON	15-16	180-260	30-90	30-150		0,01-0,05
	GHISA SFEROIDALE - SPHEROIDAL GRAPHITE	17-18	160-250	25-80	30-130		0,01-0,05
	GHISA MALLEABILE - MALLEABLE CAST IRON	19-20	130-230	30-90	30-100		0,01-0,05
N	ALLUMINIO E SUE LEGHE - ALUMINIUM	21-25	60-130	80-150			0,01-0,05
	RAME E SUE LEGHE - COPPER	26-28	90-110	50-110			0,01-0,05
	NON METALLICI - PLASTICS	29-30	/	20-80			0,01-0,05
S	LEGHE RESIST. CALORE - HIG. TEMP. ALLOY	31-35	200-320		30-80		0,01-0,05
	TITANIO E SUE LEGHE - TITANIUM	36-37	400-1050 ¹⁾		30-80		0,01-0,05
H	ACCIAIO TEMPRATO - HARDENED STEEL	38-41	45-60 ²⁾				

$$n = \frac{Vc \cdot 1000}{\varnothing D \cdot 3,14} = \text{giri/min (min}^{-1}\text{)}$$

$$Vf = fn \cdot n = \text{mm/min}$$

Vc = m/min VELOCITÀ DI TAGLIO - CUTTING SPEED
n = giri/min (min⁻¹) NUMERO DI GIRI - NUMBER OF REVOLUTIONS
fn = mm AVANZAMENTO AL GIRO - FEED / REVOLUTION
Vf = mm/min VELOCITÀ DI AVANZAMENTO - FEED SPEED

NOTE - NOTES

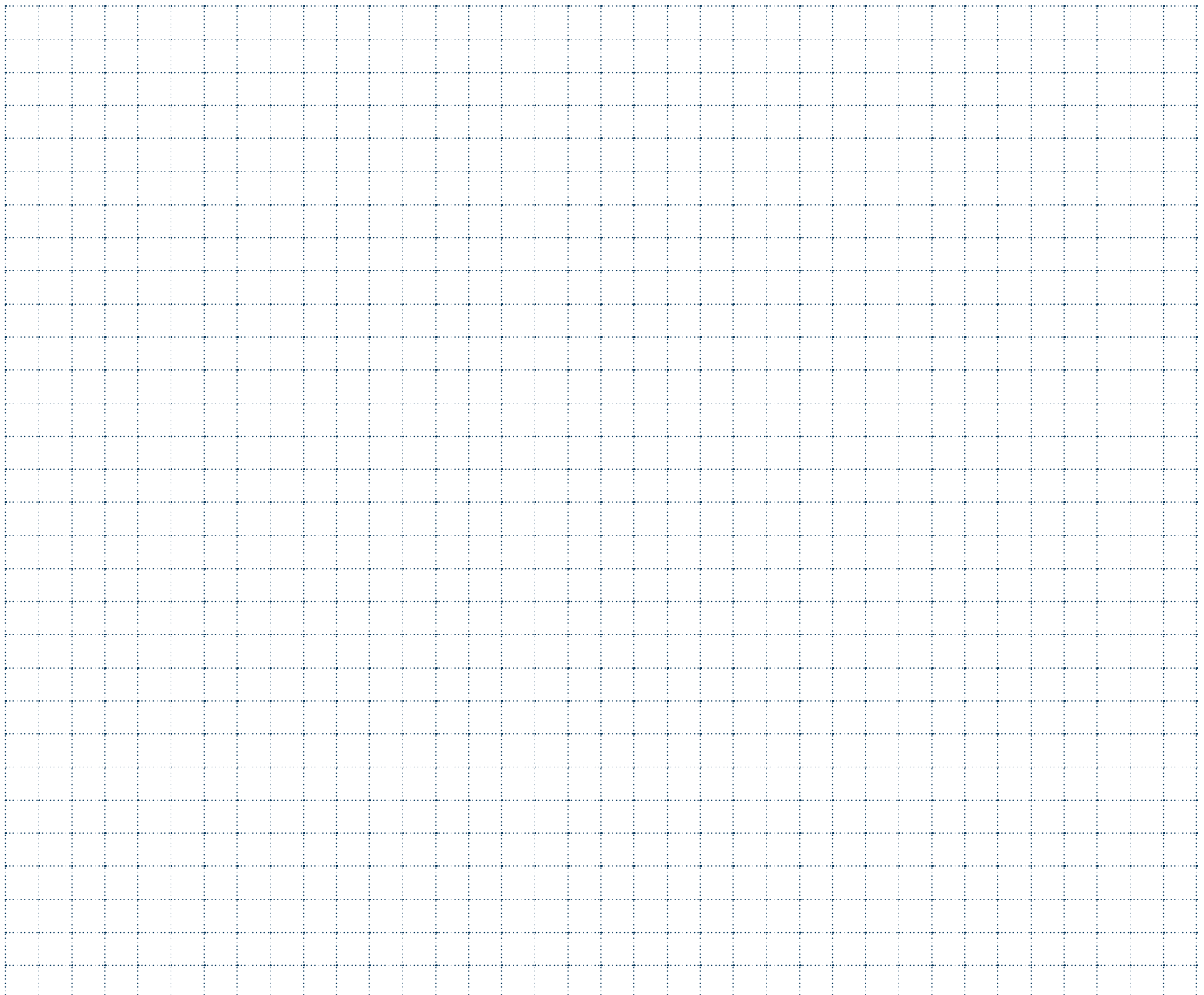

S103-06...-E62-15.015R/L Scanalatura Frontale - Face Grooving

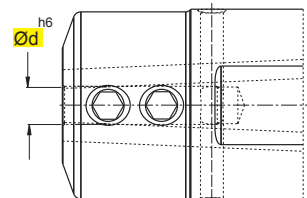
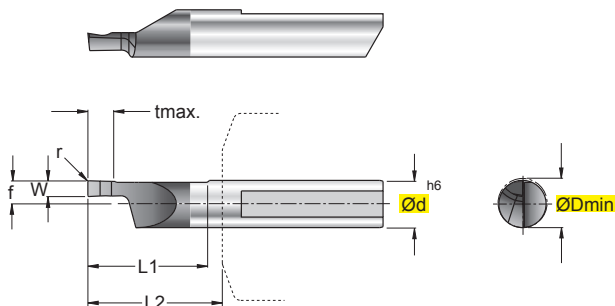
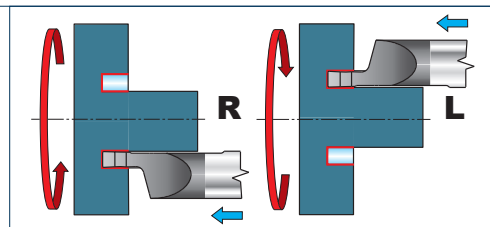

art. S100-TS-06..

In figura utensile destro - Right-hand shown

ART.	(mm)									P	M	K	N	S	H	HW		HC	
	 	ØDmin	Ød	f	tmax	r	$\begin{matrix} +0,05 \\ 0 \end{matrix}$ w	L1	L2							NON RIV.	RIVESTITI		
																CEMENTED	COATED GRADES		
S103-06.0100-E62-15.015R/L		6,2	6	2,95	2	0,15	1,0	15	18	●	●	○	●	○		■		■	
S103-06.0150-E62-15.015R/L		6,2	6	2,95	3	0,15	1,5	15	18	●	●	○	●	○		■		■	
S103-06.0200-E62-15.015R/L		6,2	6	2,95	4	0,15	2,0	15	18	●	●	○	●	○		■		■	
S103-06.0239-E62-15.015R/L		6,2	6	2,95	5	0,15	2,39	15	18	●	●	○	●	○		■		■	
S103-06.0250-E62-15.015R/L		6,2	6	2,95	5	0,15	2,5	15	18	●	●	○	●	○		■		■	
S103-06.0300-E62-15.015R/L		6,2	6	2,95	6	0,15	3,0	15	18	●	●	○	●	○		■		■	

MATERIALI - MATERIALS Pag. 1199		VDI 3323 GR.	HB Rm ¹⁾ HRC ²⁾	Vc m/min			fn mm
				N3635	F7835		
P	ACCIAIO NON LEGATO - NOT ALLOY STEEL	1-5	125-300		80-160		0,01-0,05
	ACCIAIO POCO LEGATO - LOW ALLOY STEEL	6-9	180-350		80-110		0,01-0,05
	ACCIAIO ALTO LEGATO - ALLOY STEEL	10-11	200-325		60-100		0,01-0,05
	INOX MARTENS. - STAINLESS STEEL MART	12-13	200-240		50-100		0,01-0,05
M	INOX AUST. DUPLEX - STAINLESS STEEL AUST	14.1-14.2	180-230		20-80		0,01-0,05
K	GHISA GRIGIA - GREY CAST IRON	15-16	180-260	30-90	30-150		0,01-0,05
	GHISA SFEROIDALE - SPHEROIDAL GRAPHITE	17-18	160-250	25-80	30-130		0,01-0,05
	GHISA MALLEABILE - MALLEABLE CAST IRON	19-20	130-230	30-90	30-100		0,01-0,05
N	ALLUMINIO E SUE LEGHE - ALUMINIUM	21-25	60-130	80-150			0,01-0,05
	RAME E SUE LEGHE - COPPER	26-28	90-110	50-110			0,01-0,05
	NON METALLICI - PLASTICS	29-30	/	20-80			0,01-0,05
S	LEGHE RESIST. CALORE - HIG. TEMP. ALLOY	31-35	200-320		30-80		0,01-0,05
	TITANIO E SUE LEGHE - TITANIUM	36-37	400-1050 ¹⁾		30-80		0,01-0,05
H	ACCIAIO TEMPRATO - HARDENED STEEL	38-41	45-60 ²⁾				

$$n = \frac{Vc \cdot 1000}{\varnothing D \cdot 3,14} = \text{giri/min (min}^{-1}\text{)}$$

$$Vf = fn \cdot n = \text{mm/min}$$

- Vc = m/min VELOCITÀ DI TAGLIO - CUTTING SPEED
- n = giri/min (min⁻¹) NUMERO DI GIRI - NUMBER OF REVOLUTIONS
- fn = mm AVANZAMENTO AL GIRO - FEED / REVOLUTION
- Vf = mm/min VELOCITÀ DI AVANZAMENTO - FEED SPEED

NOTE - NOTES

--	--

S103-06.R...-I62-15...R/L

Scanalatura Frontale - Face Grooving

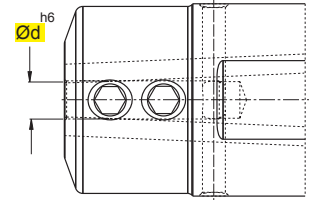
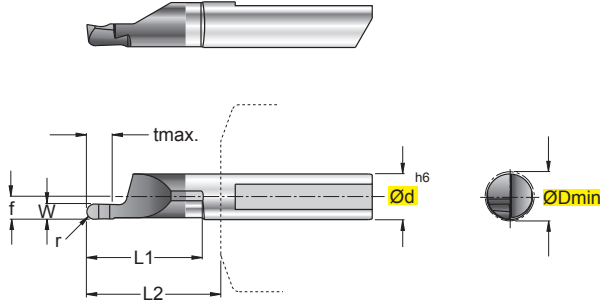
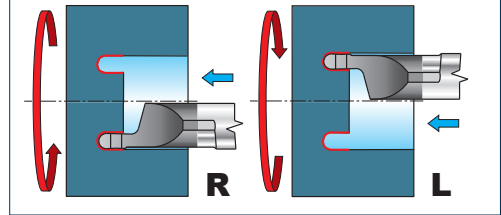

art. S100-TS-06..

In figura utensile destro - Right-hand shown

ART.	(mm)									P	M	K	N	S	H	HW		HC	
		ØDmin	Ød	f	tmax	r	$\begin{matrix} +0,05 \\ 0 \end{matrix}$	L1	L2							NON RIV.	RIVESTITI		
																CEMENTED	COATED GRADES		
S103-06.R100-I62-15.050R/L		6,2	6	2,95	2	0,5	1	15	18	●	●	○	●	○		■		■	
S103-06.R160-I62-15.080R/L		6,2	6	2,95	3	0,8	1,6	15	18	●	●	○	●	○		■		■	
S103-06.R200-I62-15.100R/L		6,2	6	2,95	4	1,0	2	15	18	●	●	○	●	○		■		■	

MATERIALI - MATERIALS Pag. 1199		VDI 3323 GR.	HB Rm ¹⁾ HRC ²⁾	Vc m/min			fn mm
				N3635	F7835		
P	ACCIAIO NON LEGATO - NOT ALLOY STEEL	1-5	125-300		80-160		0,01-0,05
	ACCIAIO POCO LEGATO - LOW ALLOY STEEL	6-9	180-350		80-110		0,01-0,05
	ACCIAIO ALTO LEGATO - ALLOY STEEL	10-11	200-325		60-100		0,01-0,05
	INOX MARTENS. - STAINLESS STEEL MART	12-13	200-240		50-100		0,01-0,05
M	INOX AUST. DUPLEX - STAINLESS STEEL AUST	14.1-14.2	180-230		20-80		0,01-0,05
K	GHISA GRIGIA - GREY CAST IRON	15-16	180-260	30-90	30-150		0,01-0,05
	GHISA SFEROIDALE - SPHEROIDAL GRAPHITE	17-18	160-250	25-80	30-130		0,01-0,05
	GHISA MALLEABILE - MALLEABLE CAST IRON	19-20	130-230	30-90	30-100		0,01-0,05
N	ALLUMINIO E SUE LEGHE - ALUMINIUM	21-25	60-130	80-150			0,01-0,05
	RAME E SUE LEGHE - COPPER	26-28	90-110	50-110			0,01-0,05
	NON METALLICI - PLASTICS	29-30	/	20-80			0,01-0,05
S	LEGHE RESIST. CALORE - HIG. TEMP. ALLOY	31-35	200-320		30-80		0,01-0,05
	TITANIO E SUE LEGHE - TITANIUM	36-37	400-1050 ¹⁾		30-80		0,01-0,05
H	ACCIAIO TEMPRATO - HARDENED STEEL	38-41	45-60 ²⁾				

$$n = \frac{Vc \cdot 1000}{\varnothing D \cdot 3,14} = \text{giri/min (min}^{-1}\text{)}$$

$$Vf = fn \cdot n = \text{mm/min}$$

- Vc** = m/min VELOCITÀ DI TAGLIO - CUTTING SPEED
n = giri/min (min⁻¹) NUMERO DI GIRI - NUMBER OF REVOLUTIONS
fn = mm AVANZAMENTO AL GIRO - FEED / REVOLUTION
Vf = mm/min VELOCITÀ DI AVANZAMENTO - FEED SPEED

NOTE - NOTES

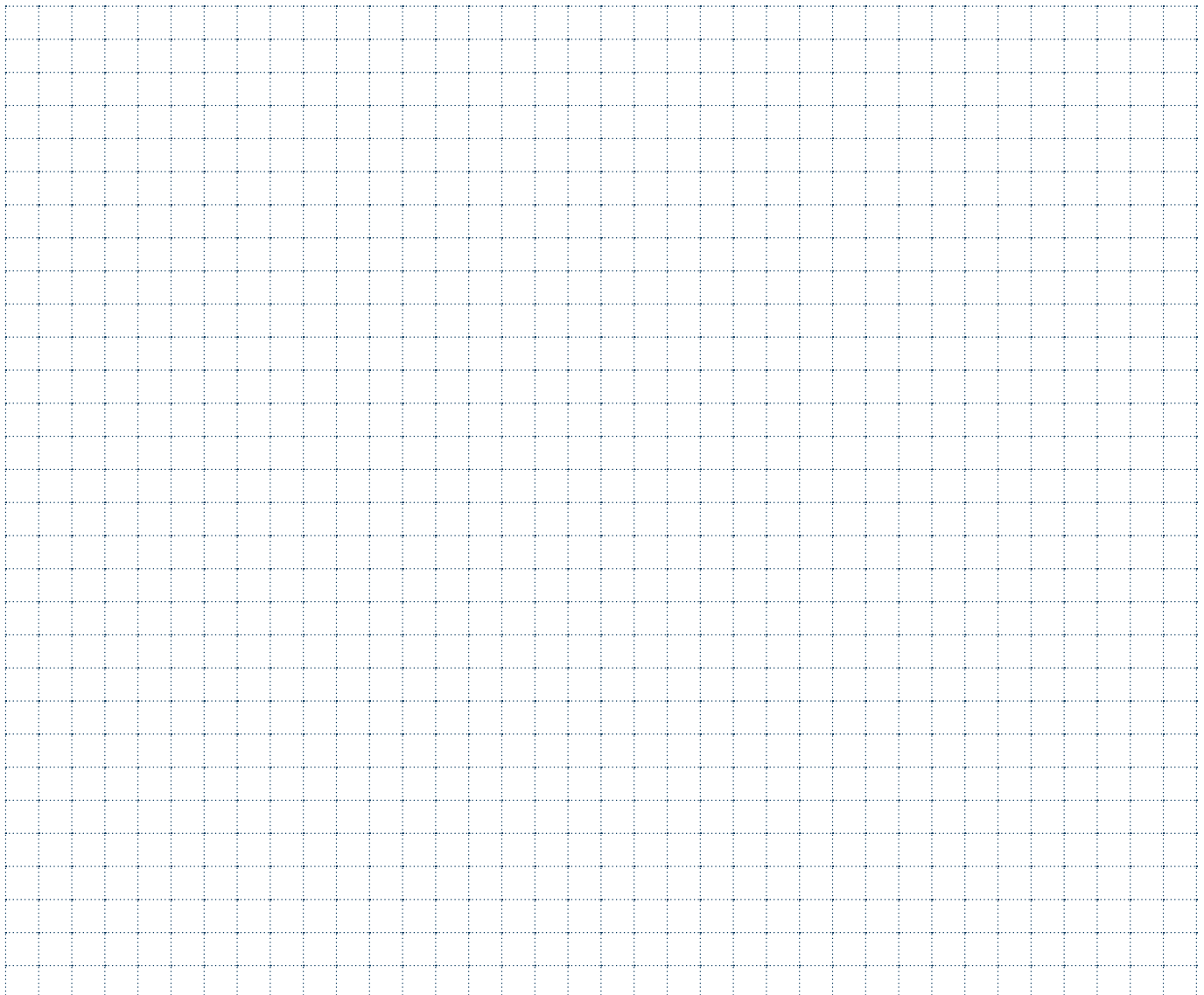

S103-06.R...-E62-15...R/L Scanalatura Frontale - Face Grooving

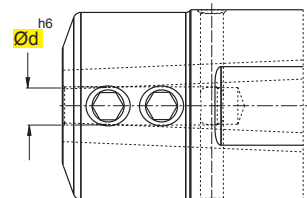
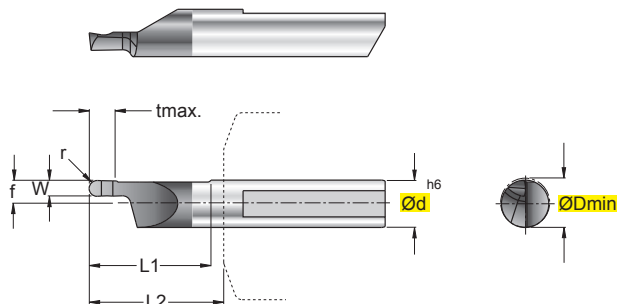
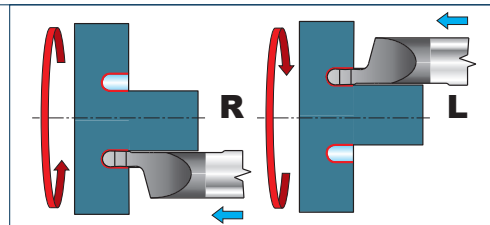

art. S100-TS-06..

In figura utensile destro - Right-hand shown

ART.	(mm)									P	M	K	N	S	H	HW		HC	
	ØDmin	Ød	f	tmax	r	$\begin{matrix} +0,05 \\ 0 \end{matrix}$ w	L1	L2	NON RIV. CEMENTED CARBIDE GRADES							RIVESTITI COATED GRADES BESCHICHTET RECOUVERTS			
S103-06.R100-E62-15.050R/L	6,2	6	2,95	2	0,5	1	15	18	●	●	○	●	○		■		■		
S103-06.R160-E62-15.080R/L	6,2	6	2,95	3	0,8	1,6	15	18	●	●	○	●	○		■		■		
S103-06.R200-E62-15.100R/L	6,2	6	2,95	4	1,0	2	15	18	●	●	○	●	○		■		■		

MATERIALI - MATERIALS Pag. 1199		VDI 3323 GR.	HB Rm ¹⁾ HRC ²⁾	Vc m/min			fn mm
				N3635	F7835		
P	ACCIAIO NON LEGATO - NOT ALLOY STEEL	1-5	125-300		80-160		0,01-0,05
	ACCIAIO POCO LEGATO - LOW ALLOY STEEL	6-9	180-350		80-110		0,01-0,05
	ACCIAIO ALTO LEGATO - ALLOY STEEL	10-11	200-325		60-100		0,01-0,05
	INOX MARTENS. - STAINLESS STEEL MART	12-13	200-240		50-100		0,01-0,05
M	INOX AUST. DUPLEX - STAINLESS STEEL AUST	14.1-14.2	180-230		20-80		0,01-0,05
K	GHISA GRIGIA - GREY CAST IRON	15-16	180-260	30-90	30-150		0,01-0,05
	GHISA SFEROIDALE - SPHEROIDAL GRAPHITE	17-18	160-250	25-80	30-130		0,01-0,05
	GHISA MALLEABILE - MALLEABLE CAST IRON	19-20	130-230	30-90	30-100		0,01-0,05
N	ALLUMINIO E SUE LEGHE - ALUMINIUM	21-25	60-130	80-150			0,01-0,05
	RAME E SUE LEGHE - COPPER	26-28	90-110	50-110			0,01-0,05
	NON METALLICI - PLASTICS	29-30	/	20-80			0,01-0,05
S	LEGHE RESIST. CALORE - HIG. TEMP. ALLOY	31-35	200-320		30-80		0,01-0,05
	TITANIO E SUE LEGHE - TITANIUM	36-37	400-1050 ¹⁾		30-80		0,01-0,05
H	ACCIAIO TEMPRATO - HARDENED STEEL	38-41	45-60 ²⁾				

$$n = \frac{Vc \cdot 1000}{\varnothing D \cdot 3,14} = \text{giri/min (min}^{-1}\text{)}$$

$$Vf = fn \cdot n = \text{mm/min}$$

- Vc = m/min VELOCITÀ DI TAGLIO - CUTTING SPEED
- n = giri/min (min⁻¹) NUMERO DI GIRI - NUMBER OF REVOLUTIONS
- fn = mm AVANZAMENTO AL GIRO - FEED / REVOLUTION
- Vf = mm/min VELOCITÀ DI AVANZAMENTO - FEED SPEED

NOTE - NOTES

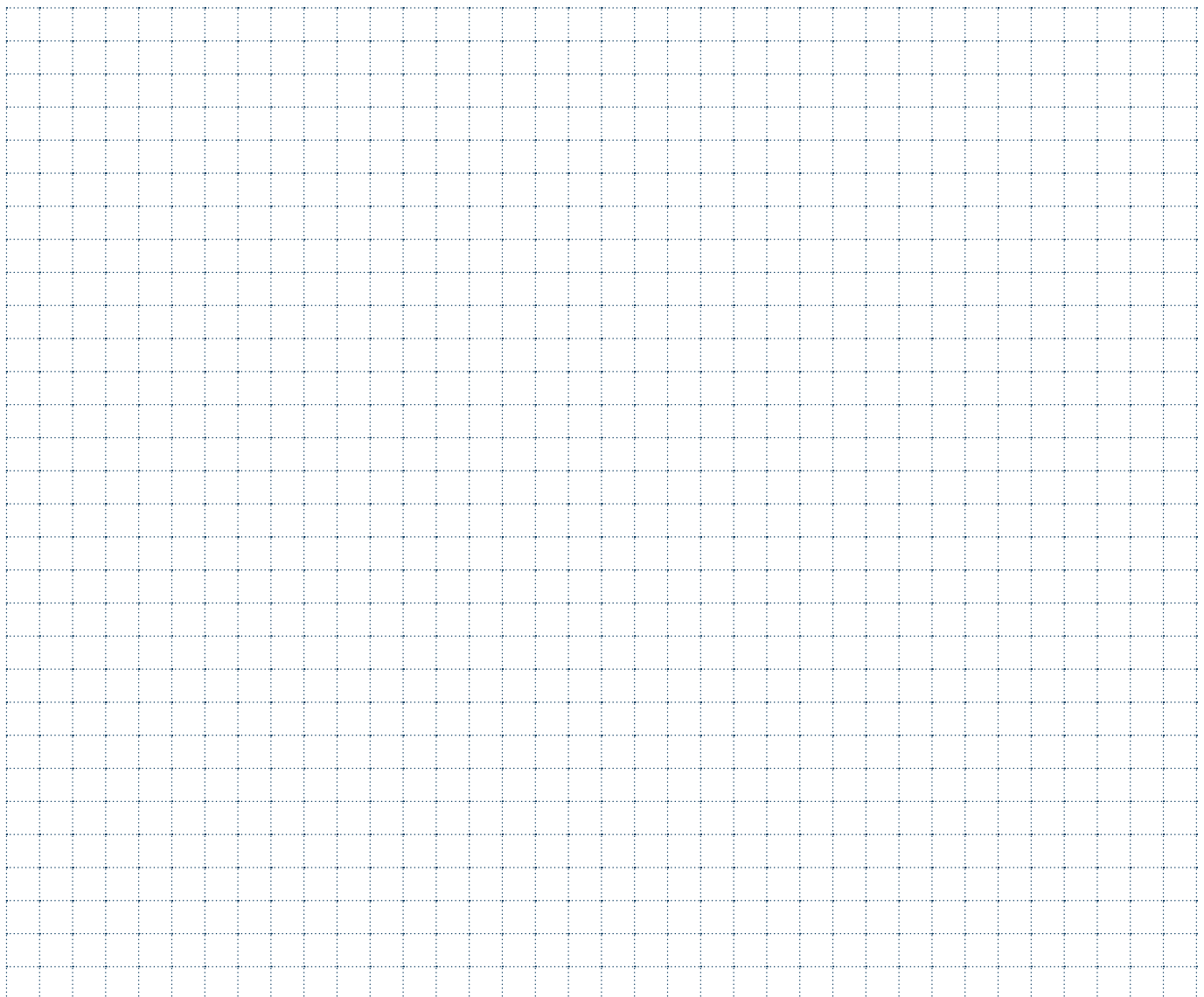

S101-06...-...020R/L

Smussatura - Chamfering
30° - 45° - 60°

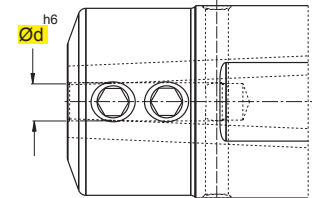
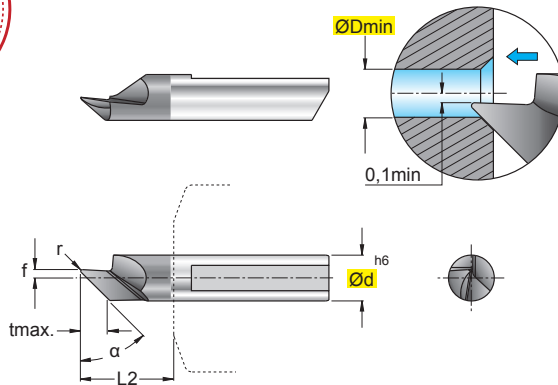
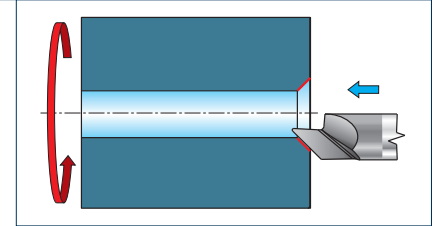

art. S100-TS-06..

In figura utensile destro - Right-hand shown

ART.	(mm)								P	M	K	N	S	H	HW		HC	
	 	ØDmin	Ød	f	r	α	tmax	L2							NON RIV.	RIVESTITI		
															CEMENTED	COATED GRADES		
S101-06.0030-017-22.020R/L New		1	6	1,7	0,2	30	2,2	13	●	●	○	●	○		■		■	
S101-06.0045-011-35.020R/L		1	6	1,1	0,2	45	3,5	13	●	●	○	●	○		■		■	
S101-06.0060-005-40.020R/L		1	6	0,5	0,2	60	4,0	13	●	●	○	●	○		■		■	

MATERIALI - MATERIALS Pag. 1199		VDI 3323 GR.	HB Rm ¹⁾ HRC ²⁾	Vc m/min			fn mm
				N3635	F7835		
P	ACCIAIO NON LEGATO - NOT ALLOY STEEL	1-5	125-300		80-160		0,01-0,05
	ACCIAIO POCO LEGATO - LOW ALLOY STEEL	6-9	180-350		80-110		0,01-0,05
	ACCIAIO ALTO LEGATO - ALLOY STEEL	10-11	200-325		60-100		0,01-0,05
	INOX MARTENS. - STAINLESS STEEL MART	12-13	200-240		50-100		0,01-0,05
M	INOX AUST. DUPLEX - STAINLESS STEEL AUST	14.1-14.2	180-230		20-80		0,01-0,05
K	GHISA GRIGIA - GREY CAST IRON	15-16	180-260	30-90	30-150		0,01-0,05
	GHISA SFEROIDALE - SPHEROIDAL GRAPHITE	17-18	160-250	25-80	30-130		0,01-0,05
	GHISA MALLEABILE - MALLEABLE CAST IRON	19-20	130-230	30-90	30-100		0,01-0,05
N	ALLUMINIO E SUE LEGHE - ALUMINIUM	21-25	60-130	80-150			0,01-0,05
	RAME E SUE LEGHE - COPPER	26-28	90-110	50-110			0,01-0,05
	NON METALLICI - PLASTICS	29-30	/	20-80			0,01-0,05
S	LEGHE RESIST. CALORE - HIG. TEMP. ALLOY	31-35	200-320		30-80		0,01-0,05
	TITANIO E SUE LEGHE - TITANIUM	36-37	400-1050 ¹⁾		30-80		0,01-0,05
H	ACCIAIO TEMPRATO - HARDENED STEEL	38-41	45-60 ²⁾				

$$n = \frac{Vc \cdot 1000}{\varnothing D \cdot 3,14} = \text{giri/min (min}^{-1}\text{)}$$

$$Vf = fn \cdot n = \text{mm/min}$$

- Vc** = m/min VELOCITÀ DI TAGLIO - CUTTING SPEED
n = giri/min (min⁻¹) NUMERO DI GIRI - NUMBER OF REVOLUTIONS
fn = mm AVANZAMENTO AL GIRO - FEED / REVOLUTION
Vf = mm/min VELOCITÀ DI AVANZAMENTO - FEED SPEED

NOTE - NOTES

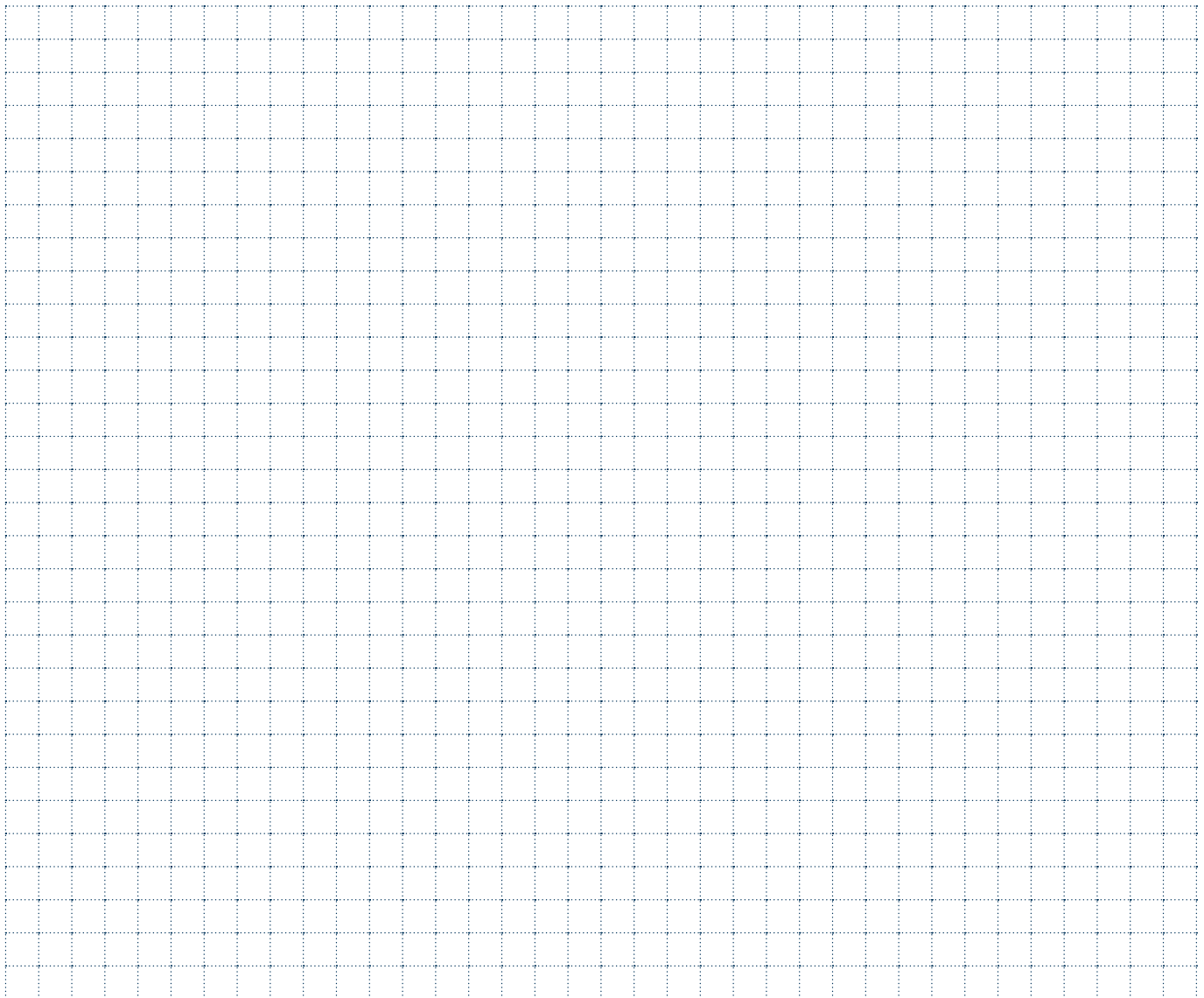

S104-...0060-...R/L

Filettatura ISO Profilo Parziale
ISO Threading, Partial Profile

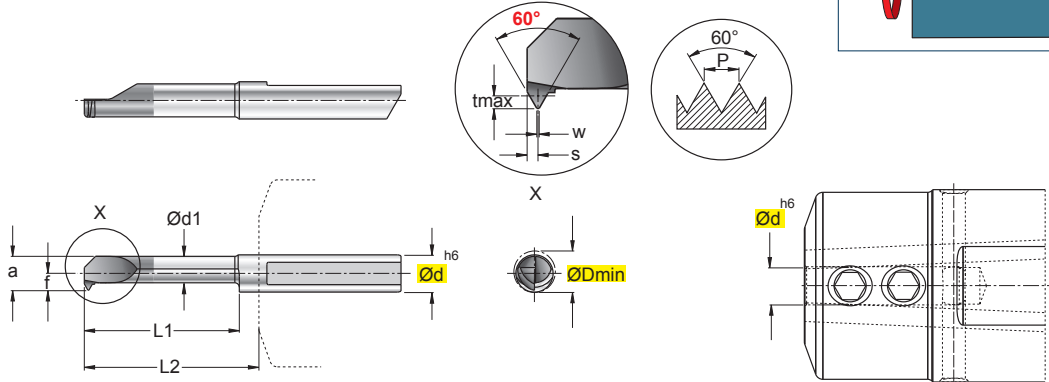
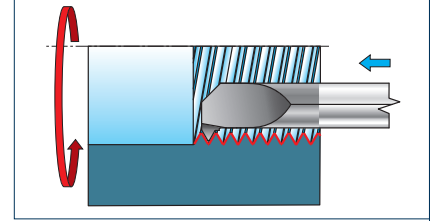

art. S100-TS-..

In figura utensile destro - Right-hand shown

ART.	(mm)											P	M	K	N	S	H	HW		HC	
	ØDmin	Ød	P _(min)	P _(max)	Ød1	f	a	tmax	s	w	L1							L2	NON RIV.	RIVESTITI	
																			CEMENTED	COATED GRADES	
S104-04.0060-042-15.050R	4,2	4	0,50	0,70	2,95	1,95	3,95	0,4	0,35	0,06	15	18	●	●	○	●	■	■			
S104-05.0060-048-15.100R/L	4,8	5	1,00	1,25	3,55	2,25	4,55	0,7	0,55	0,12	15	18	●	●	○	●	■	■			
S104-05.0060-048-20.100R/L	4,8	5	1,00	1,25	3,55	2,25	4,55	0,7	0,55	0,12	20	23	●	●	○	●	■	■			
S104-06.0060-062-15.125R	6,2	6	1,25	1,50	3,95	2,95	5,95	0,84	0,75	0,16	15	18	●	●	○	●	■	■			
S104-06.0060-062-25.125R	6,2	6	1,25	1,50	3,95	2,95	5,95	0,84	0,75	0,16	25	28	●	●	○	●	■	■			
S104-06.0060-062-15.150R	6,2	6	1,50	1,75	3,95	2,95	5,95	0,98	0,80	0,18	15	18	●	●	○	●	■	■			
S104-06.0060-062-25.150R	6,2	6	1,50	1,75	3,95	2,95	5,95	0,98	0,80	0,18	25	28	●	●	○	●	■	■			

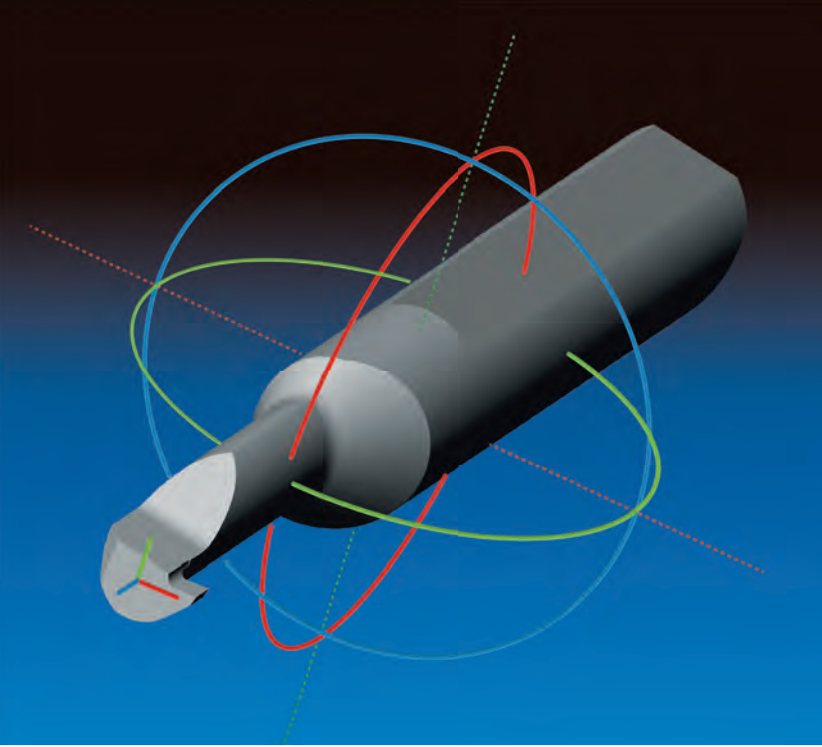

Panoramica qualità - General view - Qualitätsübersicht - Vue d'ensemble qualité

DIN ISO 513	P ACCIAI STEELS STAHL ACIERS					M ACCIAI INOSSIDABILI STAINLESS STEELS ROSTFREIER STAHL ACIER INOXYDABLE				K GHISE CAST IRON GRAUGUSS FONTE GRISE					N NON FERROSI NONFERROUS NICHTEISENMA PAS FERREUX				S MAT.DIFFICILI DIFFICULT MATERIAL SCHWIERIGE MATERI LIEN MAT.DIFFICILES					H MATERIALI DURI HARD MATERIALS HARTE MATERI LIEN MATÉRI AUX DURS				
	01	10	20	30	40	50	10	20	30	40	01	10	20	30	40	10	20	30	40	01	10	20	30	40	10	20	30	40
HW																												
HC																												
TENACITÀ - TOUGHNESS - ZÄHIGKEIT - TÉNACITÉ																												
RESISTENZA ALL'USURA - RESISTANCE TO WEAR - VERSCHLEISSFESTIGKEIT - RÉSISTANCE À L'USURE																												
AVANZAMENTO - FEED - VORSCHUB - AVANCE																												
VELOCITÀ - SPEED - GESCHWINDIGKEIT - VITESSE																												
HT CERMET										HW METALLO DURO NON RICOPERTO UNCOATED CARBIDE UNBESCHICHTETES HARTMETALL MÉTAL DUR PAS RECOUVERT										HC METALLO DURO RICOPERTO COATED CARBIDE BESCHICHTETES HARTMETALL MÉTAL DUR RECOUVERT								

Impiego delle qualità - Application of the grade - Einsatz der verschiedenen sorten - Utilisation de les qualités

SHG	DIN ISO 513	MATERIALE - MATERIAL MATERIALIEN - MATÉRI AUX						QUICK PICK	INDICAZIONI - USO
		P ACCIAI STEELS STAHL ACIER	M ACCIAI INOX STAINLESS STEELS ROSTFREIER STAHL ACIER INOXYDABLE	K GHISA CAST IRON GRAUGUSS FONTE GRISE	N MAT.NON FERROSI NONFERROUS MAT. NICHTEISENMATERIALIEN MAT.FERREUX	S MAT.DIFFICILI DIFFICULT MATERIAL SCHWIERIGE MATERI LIEN MAT.DIFFICILES	H MATERIALI DURI HARD MATERIALS HARTE MATERI LIEN MATÉRI AUX DURS		
N3635	HW K30-40 N30-40			○	●			<ul style="list-style-type: none"> - QUALITÀ ADATTA PER MATERIALI NON FERROSI - METALLO DURO DI ALTA TENACITÀ, IDEALE ANCHE IN CONDIZIONI DI TAGLIO DIFFICILI - GRADE SUITABLE FOR NON-FERROUS MATERIALS - VERY TOUGH HARD METAL, IDEALLY SUITED ALSO UNDER DIFFICULT CUTTING CONDITIONS - SORTE FÜR NICHTEISENMATERIALIEN - HARTMETALL MIT HOHER ZÄHIGKEIT, AUCH UNTER SCHWEREN SCHNITTBEDINGUNGEN BESTENS GEEIGNET - QUALITE INDIQUEE POUR DES MATERIAUX NON FERREUX. - METAL DUR D'UNE HAUTE TENACITE, IDEAL MEME DANS DES CONDITIONS DE COUPE DIFFICILES 	
F7835	HC P30-40 M30-40 K30-40 PVD S30-40 H30-40	●	●	●	○		<ul style="list-style-type: none"> - BUONA RESISTENZA ALL'USURA - ELEVATA STABILITÀ ALLO SHOCK TERMICO - MOLTO TENACE, ADATTO ANCHE IN CONDIZIONI DI TAGLIO DIFFICILI - GOOD RESISTANCE TO WEAR - HIGH THERMAL SHOCK RESISTANCE - VERY TOUGH, ALSO SUITABLE UNDER DIFFICULT CUTTING CONDITIONS - GUTE VERSCHLEISSFESTIGKEIT - HOHE TEMPERATURWECHSELBESTÄNDIGKEIT - SEHR ZÄH, AUCH UNTER SCHWEREN SCHNITTBEDINGUNGEN GEEIGNET - BONNE RESISTANCE A L'USURE - STABILITE ELEVÉE AU CHOC THERMIQUE - TRES TENACE, INDIQUE MEME DANS DES CONDITIONS DE COUPE DIFFICILES 		

- APPLICAZIONE CONSIGLIATA RECOMMENDED APPLICATION EMPFOHLENER EINSATZ APPLICATION CONSEILLÉE
- APPLICAZIONE POSSIBILE POSSIBLE APPLICATION MÖGLICHE ANWENDUNG APPLICATION POSSIBLE
- APPLICAZIONE CONSIGLIATA RECOMMENDED APPLICATION EMPFOHLENER EINSATZ APPLICATION CONSEILLÉE
- APPLICAZIONE POSSIBILE POSSIBLE APPLICATION MÖGLICHE ANWENDUNG APPLICATION POSSIBLE

**PARAMETRI DI TAGLIO - CUTTING DATA
SCHNITTPARAMETER - PARAMETRES DE COUPE**

MATERIALI - MATERIALS Pag. 1199		VDI 3323 GR.	HB Rm ¹⁾ HRC ²⁾	Vc m/min		
				N3635	F7835	
P	ACCIAIO NON LEGATO - NOT ALLOY STEEL	1-5	125-300		80-160	
	ACCIAIO POCO LEGATO - LOW ALLOY STEEL	6-9	180-350		80-110	
	ACCIAIO ALTO LEGATO - ALLOY STEEL	10-11	200-325		60-100	
	INOX MARTENS. - STAINLESS STEEL MART	12-13	200-240		50-100	
M	INOX AUST. DUPLEX - STAINLESS STEEL AUST	14.1-14.2	180-230		20-80	
K	GHISA GRIGIA - GREY CAST IRON	15-16	180-260	30-90	30-150	
	GHISA SFEROIDALE - SPHEROIDAL GRAPHITE	17-18	160-250	25-80	30-130	
	GHISA MALLEABILE - MALLEABLE CAST IRON	19-20	130-230	30-90	30-100	
N	ALLUMINIO E SUE LEGHE - ALUMINIUM	21-25	60-130	80-150		
	RAME E SUE LEGHE - COPPER	26-28	90-110	50-110		
	NON METALLICI - PLASTICS	29-30	/	20-80		
S	LEGHE RESIST. CALORE - HIG. TEMP. ALLOY	31-35	200-320		30-80	
	TITANIO E SUE LEGHE - TITANIUM	36-37	400-1050 ¹⁾		30-80	
H	ACCIAIO TEMPRATO - HARDENED STEEL	38-41	45-60 ²⁾			

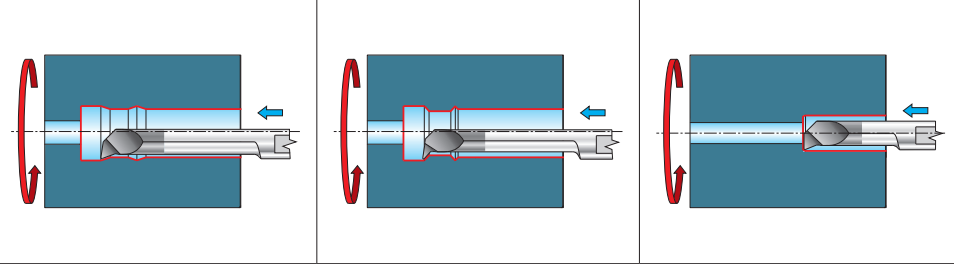
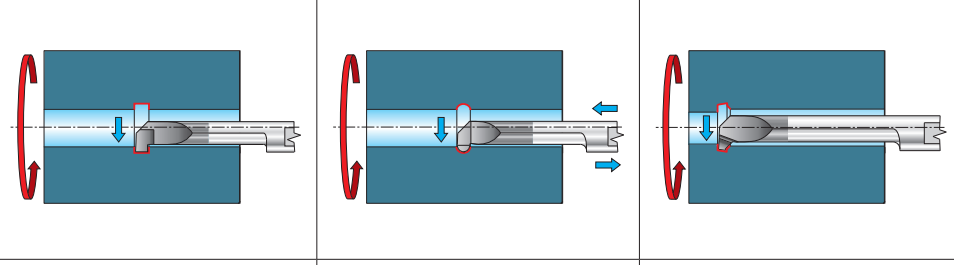
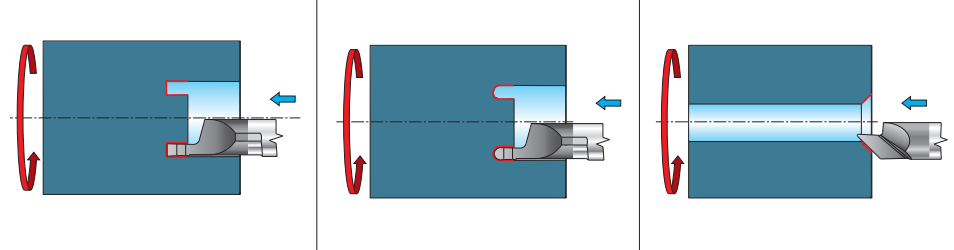
LAVORAZIONI MACHINING			AVANZAMENTO f (mm/giro) FEED f (mm/rev.)
COPIATURA COPY			0,02 - 0,08
SCANALATURA GROOVING			0,01 - 0,03
SCANALATURA FRONTALE FACE GROOVING			0,01 - 0,05

TORNITURA

TURNING / DREHEN / TOURNAGE / TORNEADO

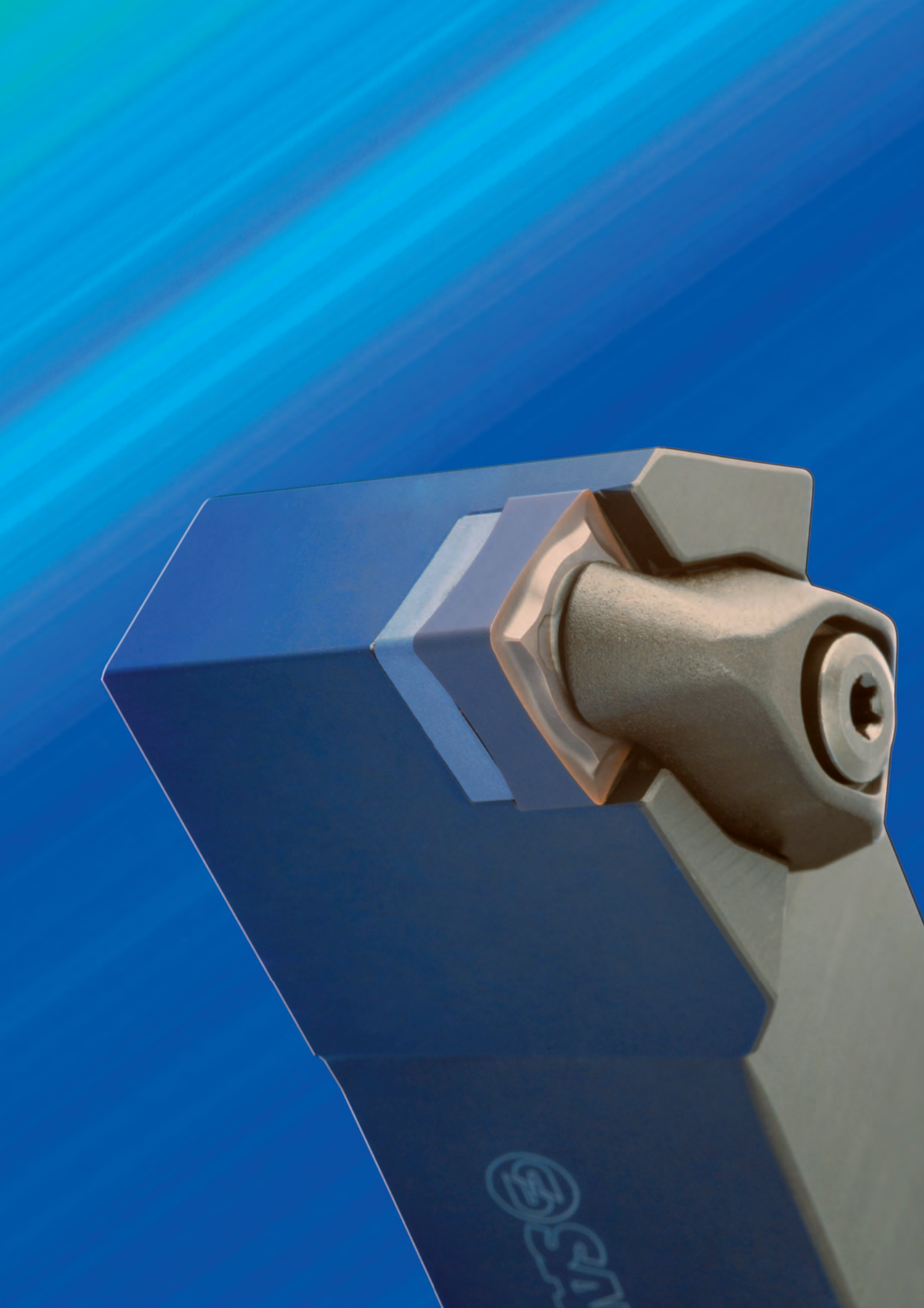







	UTENSILI PER TORNITURA ESTERNA	  
	EXTERNAL TURNING TOOLS	
	WERKZEUGE FUER AUSSENBEARBEITUNG	
	OUTILS DE TOURNAGE EXTÉRIEUR	
	HERRAMIENTAS PARA TORNEADO EXTERIOR	









Pag. 58

	UTENSILI PER TORNITURA INTERNA	  
	TOOL HOLDER FOR INTERNAL USE	
	WERKZEUGE FUER INNENBEARBEITUNG	
	OUTILS DE TOURNAGE INTÉRIEUR	
	HERRAMIENTAS PARA TORNEADO INTERIOR	

Pag. 100

	UTENSILI PER SCANALATURA E TAGLIO	  
	TOOLS FOR GROOVING AND PARTING	
	NUTDREHEN UND ABSTECHE	
	OUTILS À RAINURER ET TRONÇONNER	
	HERRAMIENTAS PARA RANURAS	

Pag. 136

	UTENSILI ISO 26623-1 PER TORNITURA ESTERNA ED INTERNA	  
	ISO 26623-1 INTERNAL AND EXTERNAL TURNING TOOLS	
	ISO 26623-1 INNEN- UND AUSSENDREHWERKZEUGE	
	OUTILS ISO 26623-1 POUR TOURNAGE EXTERNE ET INTERNE	
	HERRAMIENTAS ISO 26623-1 PARA TORNEADO EXTERIOR E INTERIOR	

Pag. 164

	UTENSILI PER STOZZATURA	  
	BROACHING TOOLS	
	NUTSTOßWERKZEUGE	
	OUTILS DE BROCHAGE	
	HERRAMIENTA DE BROCHADO	

Pag. 185

	INSERTI PER TORNITURA	  
	TURNING INSERTS	
	WENDEPLATTEN ZUM DREHEN	
	PLAQUÉTTES DE TOURNAGE	
	PLAQUITAS DE TORNEADO	

Pag. 191

	INSERTI PER SCANALATURA	  
	GROOVING INSERTS	
	WENDEPLATTEN ZUM NUTDREHEN	
	PLAQUÉTTES DE GORGES	
	PLAQUITAS DE RANURAS	

Pag. 235

**INDICAZIONI DI LETTURA
READING INSTRUCTIONS
HINWEISE ZUR ABLESUNG
INDICATIONS DE LÉCTURE**



- 1 = ARTICOLO + GAMMA DI STELI
- 2 = LAVORAZIONI CONSIGLIATE
- 3 = INSERTI
- 4 = SISTEMA DI BLOCCAGGIO
- 5 = INSERTI SAU DISPONIBILI
- 6 = ELENCO ARTICOLI
- 7 = MISURE, DATI, INDICAZIONI
- 8 = GRANDEZZA INSERTI CONSIGLIATI
- 9 = RICAMBI IN DOTAZIONE
- 10 = ACCESSORI E RICAMBI OPZIONALI A RICHIESTA
- 11 = SCHEMA DI MONTAGGIO
- 12 = DATI TECNICI E CONSIGLI D'USO



- 1 = ITEM + SHAFT RANGE
- 2 = RECOMMENDED MACHINING TYPES
- 3 = INSERTS
- 4 = CLAMPING SYSTEM
- 5 = AVAILABLE SAU INSERTS
- 6 = ITEM LIST
- 7 = MEASURES, DATA, INDICATIONS
- 8 = RECOMMENDED INSERTS SIZES
- 9 = SPARE PARTS EQUIPMENT
- 10 = OPTIONAL ACCESORIES AND SPARE PARTS ON REQUEST
- 11 = ASSEMBLY DIAGRAM
- 12 = TECHNICAL DATA AND SUGGESTIONS



- 1 = ARTIKEL + SCHAFTPALETTE
- 2 = EMPFOHLENE BEARBEITUNGEN
- 3 = WENDEPLATTEN
- 4 = SPANNSYSTEM
- 5 = LIEFERBARE SAU-WENDESCHNEIDPLATTEN
- 6 = AUFLISTUNG DER ARTIKEL
- 7 = ABMESSUNGEN, DATEN, HINWEISE
- 8 = EMPFOHLENE PLATTENGRÖSSEN
- 9 = ZUBEHÖREERSATZTEILE
- 10 = OPTIONALZUBEHÖR UND -ERSATZTEILE AUF ANFRAGE
- 11 = MONTAGEPLAN
- 12 = TECHNISCHE DATEN UND TIPPS



- 1 = ARTICLE + GAMME DE QUEUES
- 2 = USINAGES CONSEILLÉS
- 3 = PLAQUÉTTES
- 4 = SYSTÈME DE BLOPAGE
- 5 = PLAQUÉTTES SAU DISPONIBLES
- 6 = LISTE DES ARTICLES
- 7 = DIMENSIONES, DONNÉES, INDICATIONS
- 8 = DIMENSIONS DE LES PLAQUÉTTES CONSEILLÉES
- 9 = RECHANGE EN DOTATION
- 10 = ACCESSOIRES ET RECHANGE OPTIONNEL SUR DEMANDE
- 11 = SCHÉMA DE MONTAGE
- 12 = DONNÉES TECHNIQUES ET CONSEILLES D'USAGE

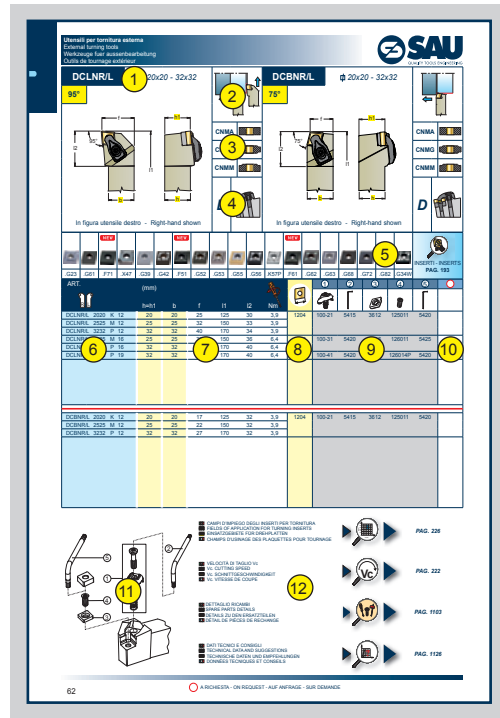

TIPI DI BLOCCAGGIO CLAMPING TYPES KLEMMTYPEN TYPES DE BLOCAGE

TIPO-TYPE-TYP-TYPE

D

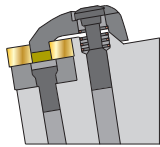

TIPO-TYPE-TYP-TYPE

P

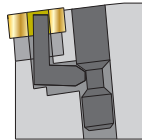

TIPO-TYPE-TYP-TYPE

M

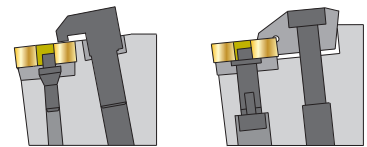

TIPO-TYPE-TYP-TYPE

S

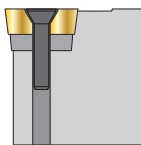

TIPO-TYPE-TYP-TYPE

C

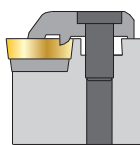

1 TIPO DI BLOCCAGGIO
TYPE OF CLAMPING

2 FORMA INSERTO
INSERT SHAPE

3 TIPO DI UTENSILE
TYPE OF TOOL

4 ANGOLI DI SPOGLIA
RAKE ANGLES

5 ESECUZIONE
DESIGN

P C L N R 32 25 P 12

1 2 3 4 5 6 7 8 9 10

6 ALTEZZA STELO
SHANK HEIGHT

7 LARGHEZZA STELO
SHANK WIDTH

8 LUNGHEZZA UTENSILE
TOOL LENGTH

L1 mm	ISO
32	A
40	B
50	C
60	D
70	E
80	F
90	G
100	H
110	J
125	K
140	L
150	M
160	N
170	P
180	Q
200	R
250	S
300	T
350	U
400	V
450	W
500	Y
SPECIALE SPECIAL	X

9 LUNGHEZZA TAGLIANTE
CUTTING EDGE LENGTH

10 FACOLTATIVO
OPTIONAL

INDICAZIONI SUPPLEMENTARI
ADDITIONALS DETAILS

S	20	S	C	T	F	P	R	16	
11	7	8	1	2	3	4	5	9	10

11 STELO SHANK

- S** = Stelo in acciaio
- A** = Stelo in acciaio + foro refrigerante
- B** = Stelo in acciaio + dispositivo antivibrante
- C** = Stelo in metallo duro con testa in acciaio
- D** = Stelo in acciaio + dispositivo antivibrante + foro refrigerante
- E** = Stelo in metallo duro con testa in acciaio + foro refrigerante
- F** = Stelo in metallo duro con testa in acciaio + dispositivo antivibrante
- G** = Stelo in metallo duro con testa in acciaio + dispositivo antivibrante + foro refrigerante
- H** = Stelo in metallo pesante
- J** = Stelo in metallo pesante + foro refrigerante

- S** = Steel shank
- A** = Steel shank + coolant hole
- B** = Steel shank +anti-vibration device
- C** = carbide shank with steel head
- D** = Steel shank + anti-vibration device + coolant hole
- E** = carbide shank with steel head + coolant hole
- F** = carbide shank with steel head + anti-vibration device
- G** =carbide shank with steel head + anti-vibration device + coolant hole
- H** = Heavy metal shank
- J** = Heavy metal shank + coolant hole

A...

ACCIAIO
 STEEL
 STAHL
 ACIER
 ACERO

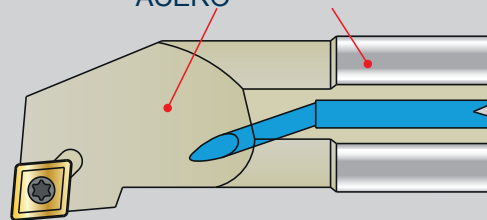

E...

ACCIAIO METALLO DURO
 STEEL SOLID CARBIDE
 STAHL HARTMETALL
 ACIER METAL DUR
 ACERO METAL DURO

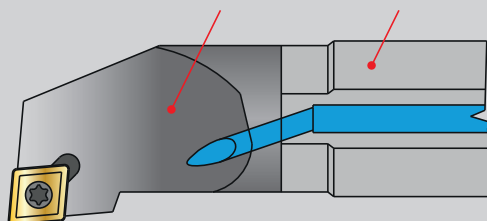

S...

ACCIAIO
 STEEL
 STAHL
 ACIER
 ACERO

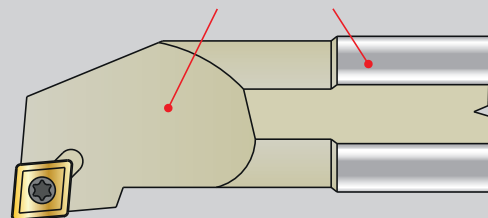

TORNITURA ESTERNA EXTERNAL TURNING		FORMA DELL'INSERTO - INSERT SHAPE							
		C	D	K	R	S	T	V	W
TIPO DI LAVORAZIONE - TYPE OF MACHINING	Tornitura Assiale / Sfacciatura Axial Turning / Facing 	●	○	○	○	○	○		○
	Profilatura Profiling 		●	○	○		○	○	
	Sfacciatura Facing 	○	○	○	○	●	○		○
	Tornitura a tuffo Plunge turning 				●		○		

● FORMA CONSIGLIATA - RECOMMENDED SHAPE

○ FORMA POSSIBILE - POSSIBLE SHAPE

TORNITURA INTERNA INTERNAL TURNING		FORMA DELL'INSERTO - INSERT SHAPE							
		C	D	K	R	S	T	V	W
TIPO DI LAVORAZIONE - TYPE OF MACHINING	Tornitura Assiale / Sfacciatura Axial Turning / Facing 	○	○		○	○	●		○
	Profilatura Profiling 		●	●			○	○	
	Sfacciatura Facing 	●	○		○		○		○

● FORMA CONSIGLIATA - RECOMMENDED SHAPE

○ FORMA POSSIBILE - POSSIBLE SHAPE

D 		D 		P 		P 		M 	
DCLNR/L Pag.62		DTJNR/L Pag.66		PCLNR/L Pag.68		PSBNR/L Pag.71		MTJNR/L Pag.75	
	 CNM. 1204.. 1606.. 1906..		 TNM. 1604..		 CNM. 0903.. 1204.. 1606.. 1906..		 SNM. 1204.. 1506.. 1906..		 TNM. 1604.. 2204..
□ 20x20 - 32x32		□ 20x20 - 32x32		□ 16x16 - 40x40		□ 20x20 - 40x40		□ 20x20 - 32x32	
DCBNR/L Pag.62		DWLNR/L Pag.67		PCBNR/L Pag.68		PSDNN Pag.71		MTENN Pag.75	
	 CNM. 1204..		 WNM. 0804..		 CNM. 1204.. 1606.. 1906..		 SNM. 1204.. 1906..		 TNM. 1604.. 2204..
□ 20x20 - 32x32		□ 20x20 - 25x25		□ 16x16 - 40x40		□ 16x16 - 32x32		□ 20x20 - 32x32	
DCKNR/L Pag.63				PCKNR/L Pag.69		PSKNR/L Pag.72		MWLNR/L Pag.76	
	 CNM. 1204..				 CNM. 1204.. 1906..		 SNM. 1204.. 1506.. 1906..		 WNM. 0604.. 0804..
□ 20x20 - 32x32				□ 16x16 - 40x40		□ 20x20 - 40x40		□ 20x20 - 32x32	
DCSNR/L Pag.63				PCSNR/L Pag.69		PSSNR/L Pag.72			
	 CNM. 1204..				 CNM. 1204.. 1606.. 1906..		 SNM. 1204.. 1506.. 1906..		
□ 20x20 - 32x32				□ 16x16 - 32x32		□ 16x16 - 40x40			
DDJNR/L Pag.64				PDJNR/L Pag.70		PTFNR/L Pag.73			
	 DNM. 1506..				 DNM. 1104.. 1506..		 TNM. 1604.. 2204..		
□ 20x20 - 25x25				□ 16x16 - 32x32		□ 20x20 - 32x32			
DSKNR/L Pag.65				PDNNR/L Pag.70		PTGNR/L Pag.73			
	 SNM. 1204.. 1506..				 DNM. 1104.. 1506..		 TNM. 1604.. 2204..		
□ 20x20 - 32x32				□ 16x16 - 32x32		□ 20x20 - 32x32			
DSSNR/L Pag.65						PWLNRL/L Pag.74			
	 SNM. 1204..						 WNM. 0604.. 0804..		
□ 20x20 - 25x25						□ 16x16 - 32x32			

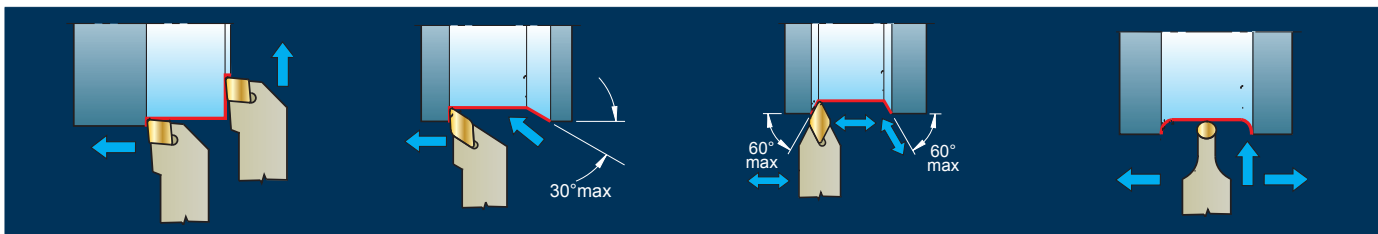

M 		M 		S 		S 		S 	
MCLNR/L Pag.77		MVJNR/L Pag.80		SCLCR/L Pag.82		STFCR/L Pag.87		SVVBN Pag.90	
									
CNM. 1204.. 1606.. 1906..		VNM. 1604..		CC.. 0602.. 09T3.. 1204..		TC.. 0902.. 1102.. 16T3..		VB.. 1604..	
☐ 20x20 - 32x32		☐ 20x20 - 32x25		☐ 08x08 - 25x25		☐ 08x08 - 25x25		☐ 20x20 - 32x25	
MDJNR/L Pag.78		MVVNN Pag.80		SCRCR/L Pag.82		STGCR/L Pag.87		C 	
								CKJNR/L Pag.91	
DNM. 1506..		VNM. 1604..		CC.. 0602.. 09T3.. 1204..		TC.. 0902.. 1102.. 16T3..			
☐ 20x20 - 32x32		☐ 20x20 - 32x25		☐ 08x08 - 25x25		☐ 08x08 - 25x25		KNUX 1604..	
MDQNR/L Pag.78		MVPCR/L Pag.81		SDHCR/L Pag.83		SVHCR/L Pag.88		☐ 20x20 - 32x32	
									
DNM. 1506..		VNM. 1604..		DC.. 0702.. 11T3..		VC.. 1103.. 1604..			
☐ 25x25		☐ 20x20 - 32x32		☐ 10x10 - 25x25		☐ 16x16 - 32x25			
MSSNR/L Pag.79				SDJCR/L Pag.83		SVJCR/L Pag.88			
									
SNM. 1204.. 1906..				DC.. 0702.. 11T3..		VC.. 1103.. 1604..			
☐ 20x20 - 40x40				☐ 08x08 - 25x25		☐ 12x12 - 32x25			
MSBNR/L Pag.79				SDNCN Pag.84		SVXCR/L Pag.89			
									
SNM. 1906..				DC.. 0702.. 11T3..		VC.. 1604..			
☐ 32x32 - 40x40				☐ 08x08 - 25x25		☐ 20x20 - 25x25			
				SRDCN Pag.85		SVVCN Pag.89			
									
				RC.. 0602M0.. 0803M0.. 1003M0..		VC.. 1103.. 1604..			
				☐ 12x12 - 25x25		☐ 16x16 - 32x25			
				SSSCR/L Pag.86		SVJBR/L Pag.90			
									
				SC.. 09T3.. 1204..		VB.. 1604..			
				☐ 12x12 - 32x25		☐ 16x16 - 32x25			

P 		S 							
FM PTGNR/L... Pag.96		FM SCLCR/L... Pag.97							
  90° 16x16	 TNM. 16T3..	  95° 10x10 - 16x16	 CC.. 0602.. 09T3..						
									
		FM SCACR/L... Pag.97							
		  90° 10x10 - 16x16	 CC.. 0602.. 09T3..						
		FM SDJCR/L... Pag.98							
		  93° 10x10 - 16x16	 DC.. 0702.. 11T3..						
		FM SDACR/L... Pag.98							
		  90° 10x10 - 16x16	 DC.. 0702.. 11T3..						
		FM SVJCR/L... Pag.99							
		  93° 10x10 - 16x16	 VC.. 1103.. 1604..						
		FM SVACR/L... Pag.99							
		  90° 10x10 - 16x16	 VC.. 1103.. 1604..						

DCLNR/L

∅ 20x20 - 32x32

95°

In figura utensile destro - Right-hand shown

DCBNR/L

∅ 20x20 - 32x32

75°

In figura utensile destro - Right-hand shown

CNMA

CNMG

CNMM

D

D



ART.	(mm)							Nm	1204	① ② ③ ④ ⑤				
	h=h1	b	f	l1	l2									
DCLNR/L 2020 K 12	20	20	25	125	30	3,9			100-21	5415	3612	125011	5420	
DCLNR/L 2525 M 12	25	25	32	150	33	3,9								
DCLNR/L 3232 P 12	32	32	40	170	34	3,9								
DCLNR/L 2525 M 16	25	25	32	150	36	6,4	1606		100-31	5420	3616	126011	5425	
DCLNR/L 3232 P 16	32	32	40	170	40	6,4								
DCLNR/L 3232 P 19	32	32	40	170	40	6,4	1906		100-41	5420	3619	126014P	5420	

DCBNR/L 2020 K 12	20	20	17	125	32	3,9	1204		100-21	5415	3612	125011	5420
DCBNR/L 2525 M 12	25	25	22	150	32	3,9							
DCBNR/L 3232 P 12	32	32	27	170	32	3,9							

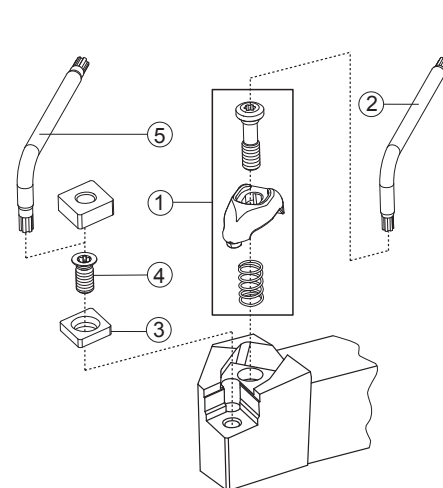

- CAMPI D'IMPIEGO DEGLI INSERTI PER TORNITURA
■ FIELDS OF APPLICATION FOR TURNING INSERTS
■ EINSATZGEBIETE FÜR DREHPLATTEN
■ CHAMPS D'USINAGE DES PLAQUETTES POUR TOURNAGE
- VELOCITÀ DI TAGLIO Vc
■ Vc. CUTTING SPEED
■ Vc. SCHNITTGESCHWINDIGKEIT
■ Vc. VITESSE DE COUPE
- DETTAGLIO RICAMBI
■ SPARE PARTS DETAILS
■ DETAILS ZU DEN ERSATZTEILEN
■ DÉTAIL DE PIÈCES DE RECHANGE
- DATI TECNICI E CONSIGLI
■ TECHNICAL DATA AND SUGGESTIONS
■ TECHNISCHE DATEN UND EMPFEHLUNGEN
■ DONNÉES TECHNIQUES ET CONSEILS

▶ **PAG. 226**

▶ **PAG. 222**

▶ **PAG. 1103**

▶ **PAG. 1126**

DCKNR/L		DCSNR/L											
75°		45°											
Ø 20x20 - 32x32		Ø 20x20 - 32x32											
<p>CNMA</p> <p>CNMG</p> <p>CNMM</p> <p>D</p>		<p>CNMA</p> <p>CNMG</p> <p>CNMM</p> <p>D</p>											
In figura utensile destro - Right-hand shown		In figura utensile destro - Right-hand shown											
.G23 .G61 .F71 .X47 .G39 .G42 .F51 .G52 .G53 .G55 .G56 .K57P .F61 .G62 .G63 .G68 .G72 .G34W		INSERTI - INSERTS PAG. 193											
ART.	(mm)	h=h1	b	f	l1	l2	Nm	1204	1	2	3	4	5
DCKNR/L 2020 K 12		20	20	25	125	30	3,9		100-21	5415	3612	125011	5420
DCKNR/L 2525 M 12		25	25	32	150	33	3,9						
DCKNR/L 3232 P 12		32	32	40	170	34	3,9						
<hr/>													
DCSNR/L 2020 K 12		20	20	25	125	35	3,9	1204	100-21	5415	3612	125011	5420
DCSNR/L 2525 M 12		25	25	32	150	36	3,9						
DCSNR/L 3232 P 12		32	32	40	170	40	3,9						

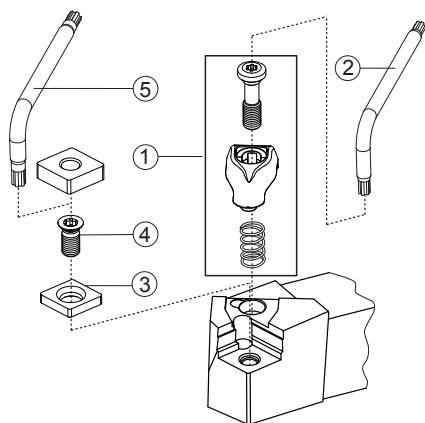

CAMPI D'IMPIEGO DEGLI INSERTI PER TORNITURA
 FIELDS OF APPLICATION FOR TURNING INSERTS
 EINSATZGEBIETE FÜR DREHPLATTEN
 CHAMPS D'USINAGE DES PLAQUETTES POUR TOURNAGE

VELOCITÀ DI TAGLIO Vc
 Vc. CUTTING SPEED
 Vc. SCHNITTGESCHWINDIGKEIT
 Vc. VITESSE DE COUPE

DETTAGLIO RICAMBI
 SPARE PARTS DETAILS
 DETAILS ZU DEN ERSATZTEILEN
 DÉTAIL DE PIÈCES DE RECHANGE

DATI TECNICI E CONSIGLI
 TECHNICAL DATA AND SUGGESTIONS
 TECHNISCHE DATEN UND EMPFEHLUNGEN
 DONNÉES TECHNIQUES ET CONSEILS



PAG. 226



PAG. 222



PAG. 1103



PAG. 1126

DDJNR/L

∅ 20x20 - 32x32

93°

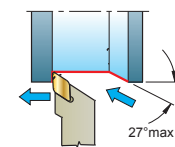
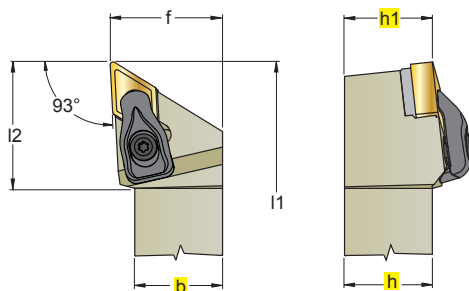

DNMA	
DNMG	
DNMM	

D



In figura utensile destro - Right-hand shown

			NEW 					NEW 						 INSERTI - INSERTS PAG. 195	
.G23	.G39	.G42	.F51	.G52	.G53	.G55	.G56	.F61	.G62	.G63	.G68	.G72	.G34W		
ART.		(mm)													
		h=h1	b	f	l1	l2	Nm								
DDJNR/L	2020	K	15	20	20	25	125	35	3,9	1506	100-21	5415	3715	125011	5420
DDJNR/L	2525	M	15	25	25	32	150	36	3,9						
DDJNR/L	3232	P	15	32	32	40	170	40	3,9						

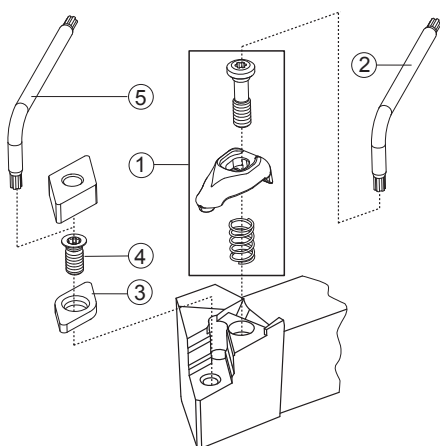

CAMPI D'IMPIEGO DEGLI INSERTI PER TORNITURA
 FIELDS OF APPLICATION FOR TURNING INSERTS
 EINSATZGEBIETE FÜR DREHPLATTEN
 CHAMPS D'USINAGE DES PLAQUETTES POUR TOURNAGE

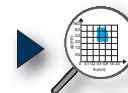

PAG. 226

VELOCITÀ DI TAGLIO Vc
 Vc. CUTTING SPEED
 Vc. SCHNITTGESCHWINDIGKEIT
 Vc. VITESSE DE COUPE



PAG. 222

DETTAGLIO RICAMBI
 SPARE PARTS DETAILS
 DETAILS ZU DEN ERSATZTEILEN
 DÉTAIL DE PIÈCES DE RECHANGE



PAG. 1103

DATI TECNICI E CONSIGLI
 TECHNICAL DATA AND SUGGESTIONS
 TECHNISCHE DATEN UND EMPFEHLUNGEN
 DONNÉES TECHNIQUES ET CONSEILS



PAG. 1126

DSKNR/L										DSSNR/L									
75°										45°									
Ø 20x20 - 32x32										Ø 20x20 - 25x25									
SNMA					SNMG					SNMM					D				
In figura utensile destro - Right-hand shown										In figura utensile destro - Right-hand shown									
ART. (mm)										INSERTI - INSERTS PAG. 196									
DSKNR/L 2020 K 12	20	20	25	125	30	3,9	1204	100-21	5415	3512	125011	5420							
DSKNR/L 2525 M 12	25	25	32	150	26	3,9													
DSKNR/L 3232 P 12	32	32	40	170	30	3,9													
DSKNR/L 3232 P 15	32	32	40	170	30	6,4	1506	100-31	5420	3515	126011	5425							
DSSNR/L 2020 K 12										DSSNR/L 2525 M 12									
20										25									
20										25									
25										32									
125										150									
35										36									
3,9										3,9									
1204										1204									
100-21										100-21									
5415										5415									
3512										3512									
125011										125011									
5420										5420									

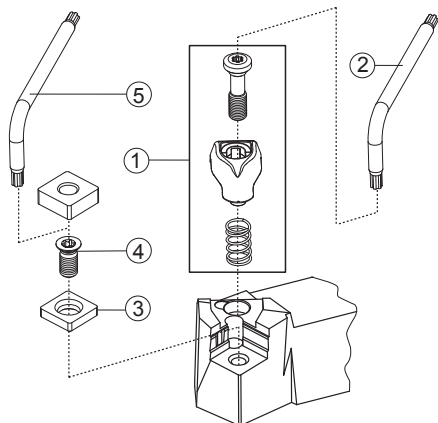

CAMPI D'IMPIEGO DEGLI INSERTI PER TORNITURA
 FIELDS OF APPLICATION FOR TURNING INSERTS
 EINSATZGEBIETE FÜR DREHPLATTEN
 CHAMPS D'USINAGE DES PLAQUETTES POUR TOURNAGE

VELOCITÀ DI TAGLIO Vc
 Vc. CUTTING SPEED
 Vc. SCHNITTGESCHWINDIGKEIT
 Vc. VITESSE DE COUPE

DETTAGLIO RICAMBI
 SPARE PARTS DETAILS
 DETAILS ZU DEN ERSATZTEILEN
 DÉTAIL DE PIÈCES DE RECHANGE

DATI TECNICI E CONSIGLI
 TECHNICAL DATA AND SUGGESTIONS
 TECHNISCHE DATEN UND EMPFEHLUNGEN
 DONNÉES TECHNIQUES ET CONSEILS

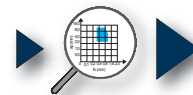

PAG. 226



PAG. 222



PAG. 1103



PAG. 1126

DTJNR/L

∅ 20x20 - 32x32

93°

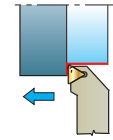
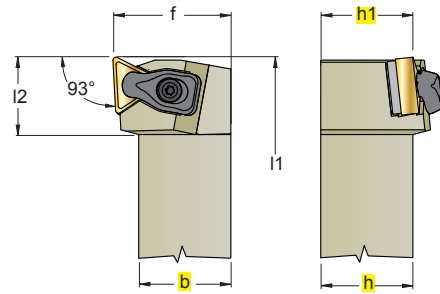

TNMA	
TNMG	
TNMM	



In figura utensile destro - Right-hand shown

	NEW 	NEW 	NEW 																 INSERTI - INSERTS PAG. 197
ART. (mm)										1	2	3	4	5					
DTJNR/L 2020 K 16				h=h1	b	f	l1	l2	Nm	1604	100-11	5409	3416	12409P	5515P				
DTJNR/L 2525 M 16				20	20	25	125	20	1,8										
DTJNR/L 3232 P 16				25	25	32	150	21	1,8										
				32	32	40	170	23	1,8										

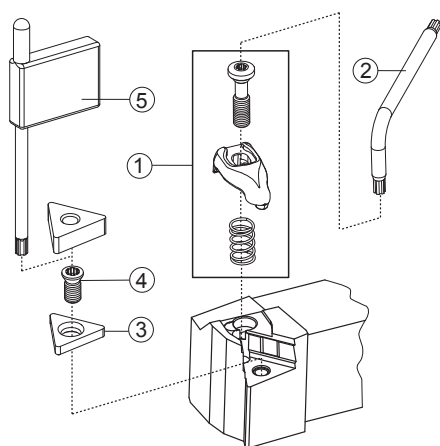

CAMPI D'IMPIEGO DEGLI INSERTI PER TORNITURA
 FIELDS OF APPLICATION FOR TURNING INSERTS
 EINSATZGEBIETE FÜR DREHPLATTEN
 CHAMPS D'USINAGE DES PLAQUETTES POUR TOURNAGE



VELOCITÀ DI TAGLIO Vc
 Vc. CUTTING SPEED
 Vc. SCHNITTGESCHWINDIGKEIT
 Vc. VITESSE DE COUPE



DETTAGLIO RICAMBI
 SPARE PARTS DETAILS
 DETAILS ZU DEN ERSATZTEILEN
 DÉTAIL DE PIÈCES DE RECHANGE



DATI TECNICI E CONSIGLI
 TECHNICAL DATA AND SUGGESTIONS
 TECHNISCHE DATEN UND EMPFEHLUNGEN
 DONNÉES TECHNIQUES ET CONSEILS



DWLNRL/L

∅ 20x20 - 25x25

93°

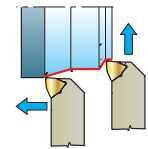
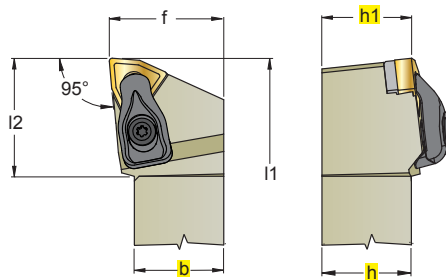

WNMA



WNMG



WNMM



D

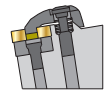

In figura utensile destro - Right-hand shown

		NEW 		NEW 						NEW 				 INSERTI - INSERTS PAG. 199
.G23	.G61	.F71	.G42	.F51	.G52	.G53	.G55	.G56	.K57P	.F61	.G62	.G63	.G34W	
ART.		(mm)												
		h=h1	b	f	l1	l2	Nm							
DWLNRL 2020 K 08		20	20	25	125	30	3,9	0804	100-21	5415	3308M	125011	5420	
DWLNRL 2525 M 08		25	25	32	150	33	3,9							

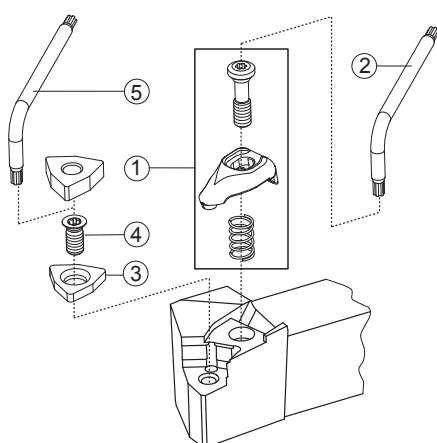

CAMPI D'IMPIEGO DEGLI INSERTI PER TORNITURA
FIELDS OF APPLICATION FOR TURNING INSERTS
EINSATZGEBIETE FÜR DREHPLATTEN
 CHAMPS D'USINAGE DES PLAQUETTES POUR TORNAGE

VELOCITÀ DI TAGLIO Vc
Vc. CUTTING SPEED
Vc. SCHNITTGESCHWINDIGKEIT
 Vc. VITESSE DE COUPE

DETTAGLIO RICAMBI
SPARE PARTS DETAILS
DETAILS ZU DEN ERSATZTEILEN
 DÉTAIL DE PIÈCES DE RECHANGE

DATI TECNICI E CONSIGLI
TECHNICAL DATA AND SUGGESTIONS
TECHNISCHE DATEN UND EMPFEHLUNGEN
 DONNÉES TECHNIQUES ET CONSEILS

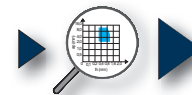

PAG. 226



PAG. 222



PAG. 1103



PAG. 1126

PCLNR/L $\varnothing 16 \times 16 - 40 \times 40$

95°

In figura utensile destro - Right-hand shown

PCBNR/L $\varnothing 16 \times 16 - 40 \times 40$

75°

In figura utensile destro - Right-hand shown

CNMA

CNMG

CNMM

P

P



ART.	(mm)						0903	①	②	③	④	⑤	⑥
	h=h1	b	f	l1	l2	8009		1606	5025	3608	4109	0009	
PCLNR/L 1616 H 09	16	16	20	100	22	0903	8009	1606	5025	3608	4109	0009	
PCLNR/L 2020 K 09	20	20	25	125	26								
PCLNR/L 2525 M 09	25	25	32	150	25								
PCLNR/L 1616 H 12 New	16	16	20	100	26	1204	8012	1648	5003	3612	4112	0012	
PCLNR/L 2020 K 12	20	20	25	125	28	1204	8012	1608	5003	3612	4112	0012	
PCLNR/L 2525 M 12	25	25	32	150	33	1606	8016	1618	5003	3616	4115	0015	
PCLNR/L 3225 P 12	32	25	32	170	28								
PCLNR/L 3232 P 12	32	32	40	170	30								
PCLNR/L 2525 M 16	25	25	32	150	33	1906	8019	1610	5004	3619	4119	0019	
PCLNR/L 3225 P 16	32	25	32	170	33								
PCLNR/L 3232 P 16	32	32	40	170	33								
PCLNR/L 2525 M 19	25	25	32	150	36	1906	8019	1610	5004	3619	4119	0019	
PCLNR/L 3232 P 19	32	32	40	170	40								
PCLNR/L 4040 S 19	40	40	50	250	40								

PCBNR/L 1616 H 09 New	16	16	14	100	20	0903	8009	1606	5025	3608	4109	0009
PCBNR/L 2020 K 09 New	20	20	17	125	21							
PCBNR/L 2525 M 09 New	25	25	22	150	21							
PCBNR/L 2020 K 12	20	20	17	125	28	1204	8012	1608	5003	3612	4112	0012
PCBNR/L 2525 M 12	25	25	22	150	29	1606	8016	1618	5003	3616	4115	0015
PCBNR/L 3225 P 12	32	25	22	170	32							
PCBNR/L 2525 M 16	25	25	22	150	29							
PCBNR/L 3225 P 16	32	25	22	170	32	1906	8019	1610	5004	3619	4119	0019
PCBNR/L 3232 P 16	32	32	27	170	35							
PCBNR/L 3232 P 19	32	32	27	170	35							
PCBNR/L 4040 S 19	40	40	35	250	37	1906	8019	1610	5004	3619	4119	0019

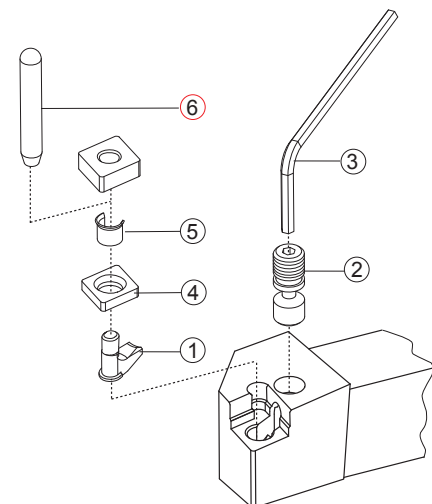

CAMPI D'IMPIEGO DEGLI INSERTI PER TORNITURA
 FIELDS OF APPLICATION FOR TURNING INSERTS
 EINSATZGEBIETE FÜR DREHPLATTEN
 CHAMPS D'USINAGE DES PLAQUETTES POUR TOURNAGE

VELOCITÀ DI TAGLIO Vc
 Vc. CUTTING SPEED
 Vc. SCHNITTGESCHWINDIGKEIT
 Vc. VITESSE DE COUPE

DETTAGLIO RICAMBI
 SPARE PARTS DETAILS
 DETAILS ZU DEN ERSATZTEILEN
 DÉTAIL DE PIÈCES DE RECHANGE

DATI TECNICI E CONSIGLI
 TECHNICAL DATA AND SUGGESTIONS
 TECHNISCHE DATEN UND EMPFEHLUNGEN
 DONNÉES TECHNIQUES ET CONSEILS



PCKNR/L

Ø 16x16 - 40x40

75°

In figura utensile destro - Right-hand shown

PCSNR/L

Ø 16x16 - 32x32

45°

In figura utensile destro - Right-hand shown

CNMA

CNMG

CNMM

P

P



ART.		(mm)						0903	①	②	③	④	⑤	⑥
R	L	h=h1	b	f	l1	l2	8009		1606	5025	3608	4109	0009	
PCKNR/L	1616 H 09 New	16	16	20	100	22	0903	8009	1606	5025	3608	4109	0009	
PCKNR/L	2020 K 09 New	20	20	25	125	20								
PCKNR/L	2525 M 09 New	25	25	32	150	25								
PCKNR/L	2020 K 12	20	20	25	125	26	1204	8012	1608	5003	3612	4112	0012	
PCKNR/L	2525 M 12	25	25	32	150	30	1606	8016	1618	5003	3616	4115	0015	
PCKNR/L	2525 M 16	25	25	32	150	33								
PCKNR/L	3232 P 16	32	32	40	170	34								
PCKNR/L	3232 P 19	32	32	40	170	36	1906	8019	1610	5004	3619	4119	0019	
PCKNR/L	4040 S 19	40	40	50	250	45								

PCSNR/L	1616 H 09 New	16	16	20	100	22	0903	8009	1606	5025	3608	4109	0009
PCSNR/L	2020 K 09 New	20	20	25	125	26							
PCSNR/L	2525 M 09 New	25	25	32	150	25							
PCSNR/L	2020 K 12	20	20	25	125	28	1204	8012	1608	5003	3612	4112	0012
PCSNR/L	2525 M 12	25	25	32	150	30	1606	8016	1618	5003	3616	4115	0015
PCSNR/L	2525 M 16	25	25	32	150	33							
PCSNR/L	3232 P 16	32	32	40	170	34							
PCSNR/L	3232 P 19	32	32	40	170	40	1906	8019	1610	5004	3619	4119	0019

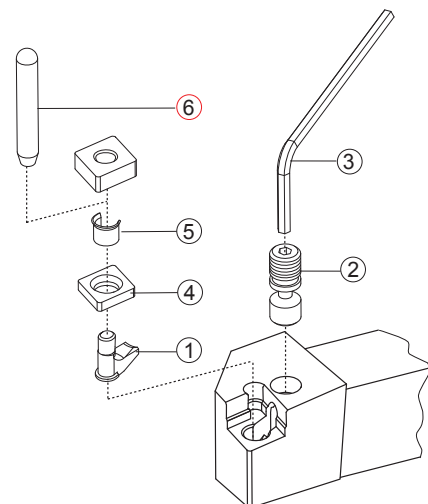

CAMPI D'IMPIEGO DEGLI INSERTI PER TORNITURA
 FIELDS OF APPLICATION FOR TURNING INSERTS
 EINSATZGEBIETE FÜR DREHPLATTEN
 CHAMPS D'USINAGE DES PLAQUETTES POUR TOURNAGE

VELOCITÀ DI TAGLIO Vc
 Vc. CUTTING SPEED
 Vc. SCHNITTGESCHWINDIGKEIT
 Vc. VITESSE DE COUPE

DETTAGLIO RICAMBI
 SPARE PARTS DETAILS
 DETAILS ZU DEN ERSATZTEILEN
 DÉTAIL DE PIÈCES DE RECHANGE

DATI TECNICI E CONSIGLI
 TECHNICAL DATA AND SUGGESTIONS
 TECHNISCHE DATEN UND EMPFEHLUNGEN
 DONNÉES TECHNIQUES ET CONSEILS

PAG. 226

Vc **PAG. 222**

PAG. 1103

PAG. 1126

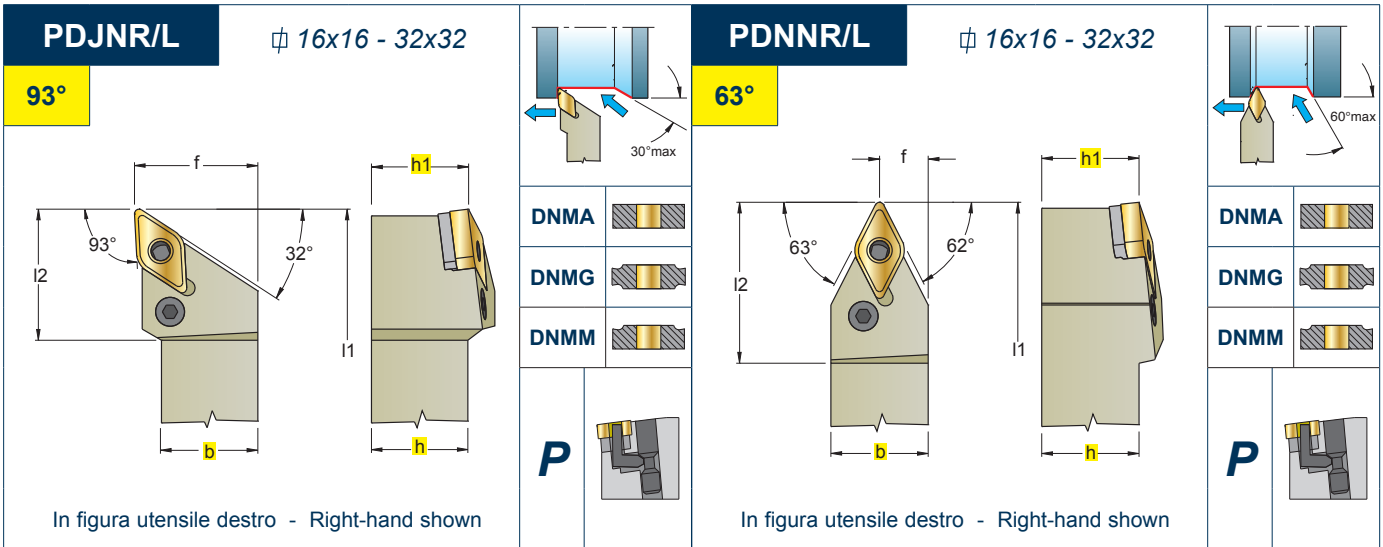

														 INSERTI - INSERTS PAG. 195	
.G23	.G39	.G42	.F51	.G52	.G53	.G55	.G56	.F61	.G62	.G63	.G68	.G72	.G34W		
ART. (mm)														① ② ③ ④ ⑤ ⑥	
h=h1 b f l1 l2															
PDJNR/L 1616 H 11			16	16	20	100	30		1104	8411	1606	5025	3710	4108	0009
PDJNR/L 2020 K 11			20	20	25	125	30								
PDJNR/L 2525 M 11			25	25	32	150	30								
PDJNR/L 2020 K 15			20	20	25	125	35		1506	8415	1638	5003	3715	4112	0012
PDJNR/L 2525 M 15			25	25	32	150	35								
PDJNR/L 3225 P 15			32	25	32	170	35								
PDJNR/L 3232 P 15			32	32	40	170	36								

PDNNR/L 1616 H 11			16	16	8,0	100	25		1104	8411	1606	5025	3710	4108	0009
PDNNR/L 2020 K 11			20	20	12,0	125	25								
PDNNR/L 2525 M 11			25	25	12,0	150	29								
PDNNR/L 2020 K 15			20	20	12,0	125	35		1506	8415	1638	5003	3715	4112	0012
PDNNR/L 2525 M 15			25	25	12,0	150	37								
PDNNR/L 3225 P 15			32	25	12,0	170	37								
PDNNR/L 3232 P 15			32	32	16,8	170	37								

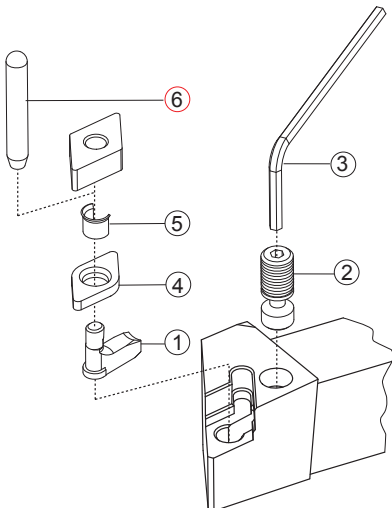

CAMPI D'IMPIEGO DEGLI INSERTI PER TORNITURA
 FIELDS OF APPLICATION FOR TURNING INSERTS
 EINSATZGEBIETE FÜR DREHPLATTEN
 CHAMPS D'USINAGE DES PLAQUETTES POUR TOURNAGE

VELOCITÀ DI TAGLIO Vc
 Vc. CUTTING SPEED
 Vc. SCHNITTGESCHWINDIGKEIT
 Vc. VITESSE DE COUPE

DETTAGLIO RICAMBI
 SPARE PARTS DETAILS
 DETAILS ZU DEN ERSATZTEILEN
 DÉTAIL DE PIÈCES DE RECHANGE

DATI TECNICI E CONSIGLI
 TECHNICAL DATA AND SUGGESTIONS
 TECHNISCHE DATEN UND EMPFEHLUNGEN
 DONNÉES TECHNIQUES ET CONSEILS

PAG. 226

Vc **PAG. 222**

PAG. 1103

PAG. 1126

PSBNR/L $\varnothing 20 \times 20 - 40 \times 40$								PSDNN $\varnothing 16 \times 16 - 32 \times 32$							
75°								45°							
In figura utensile destro - Right-hand shown															
								 INSERTI - INSERTS PAG. 196							
ART. (mm)															
 h=h1 b f l1 l2								 ① ② ③ ④ ⑤ ⑥							
PSBNR/L 2020 K 12			20	20	17	125	28	1204	8012	1608	5003	3512	4112	0012	
PSBNR/L 2525 M 12			25	25	22	150	29	1506	8016	1618	5003	3515	4115	0015	
PSBNR/L 2525 M 15			25	25	22	150	32		8019	1610	5004	3519	4119	0019	
PSBNR/L 3232 P 15			32	32	27	170	32	1906	8019	1610	5004	3519	4119	0019	
PSBNR/L 3232 P 19			32	32	27	170	39								
PSBNR/L 4040 S 19			40	40	35	250	39								
PSDNN 1616 H 12			16	16	8,3	100	30	1204	8012	1608	5003	3512	4112	0012	
PSDNN 2020 K 12			20	20	10,3	125	28	1506							
PSDNN 2525 M 12			25	25	12,8	150	29								
PSDNN 3232 P 19			32	32	16,5	170	40	1906	8019	1610	5004	3519	4119	0019	

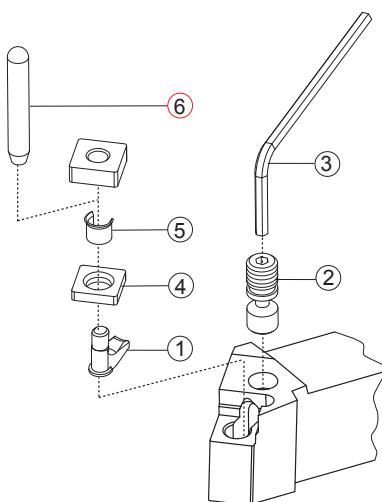

CAMPI D'IMPIEGO DEGLI INSERTI PER TORNITURA
 FIELDS OF APPLICATION FOR TURNING INSERTS
 EINSATZGEBIETE FÜR DREHPLATTEN
 CHAMPS D'USINAGE DES PLAQUETTES POUR TOURNAGE

VELOCITÀ DI TAGLIO Vc
 Vc. CUTTING SPEED
 Vc. SCHNITTGESCHWINDIGKEIT
 Vc. VITESSE DE COUPE

DETTAGLIO RICAMBI
 SPARE PARTS DETAILS
 DETAILS ZU DEN ERSATZTEILEN
 DÉTAIL DE PIÈCES DE RECHANGE

DATI TECNICI E CONSIGLI
 TECHNICAL DATA AND SUGGESTIONS
 TECHNISCHE DATEN UND EMPFEHLUNGEN
 DONNÉES TECHNIQUES ET CONSEILS

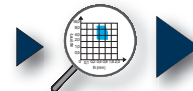

PAG. 226



PAG. 222



PAG. 1103



PAG. 1126

PSKNR/L \varnothing 20x20 - 40x40								PSSNR/L \varnothing 16x16 - 40x40								
75°								45°								
SNMA SNMG SNMM P								SNMA SNMG SNMM P								
In figura utensile destro - Right-hand shown								In figura utensile destro - Right-hand shown								
ART. (mm)																
h=h1 b f l1 l2																
PSKNR/L 2020 K 12	NEW		NEW		20	20	25	125	26	1204	8012	1608	5003	3512	4112	0012
PSKNR/L 2525 M 12	NEW		NEW		25	25	32	150	26	1506	8016	1618	5003	3515	4115	0015
PSKNR/L 2525 M 15	NEW		NEW		25	25	32	150	30	1906	8019	1610	5004	3519	4119	0019
PSKNR/L 3232 P 15	NEW		NEW		32	32	40	170	34							
PSKNR/L 3232 P 19	NEW		NEW		32	32	40	170	34							
PSKNR/L 4040 S 19	NEW		NEW		40	40	50	250	38							
PSSNR/L 1616 H 12	NEW		NEW		16	16	20	100	26	1204	8012	1608	5003	3512	4112	0012
PSSNR/L 2020 K 12	NEW		NEW		20	20	25	125	29	1506	8016	1618	5003	3515	4115	0015
PSSNR/L 2525 M 12	NEW		NEW		25	25	32	150	29	1906	8019	1610	5004	3519	4119	0019
PSSNR/L 3225 P 12	NEW		NEW		32	25	32	170	29							
PSSNR/L 2525 M 15	NEW		NEW		25	25	32	150	36							
PSSNR/L 3232 P 15	NEW		NEW		32	32	40	170	40							
PSSNR/L 3232 P 19	NEW		NEW		32	32	40	170	40							
PSSNR/L 4040 S 19	NEW		NEW		40	40	50	250	40							

INSERTI - INSERTS
PAG. 196

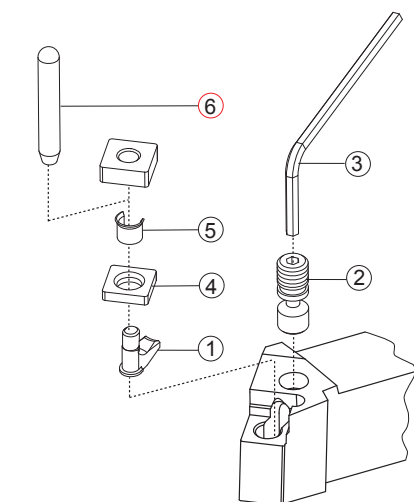

CAMPI D'IMPIEGO DEGLI INSERTI PER TORNITURA
 FIELDS OF APPLICATION FOR TURNING INSERTS
 EINSATZGEBIETE FÜR DREHPLATTEN
 CHAMPS D'USINAGE DES PLAQUETTES POUR TOURNAGE

VELOCITÀ DI TAGLIO Vc
 Vc. CUTTING SPEED
 Vc. SCHNITTGESCHWINDIGKEIT
 Vc. VITESSE DE COUPE

DETTAGLIO RICAMBI
 SPARE PARTS DETAILS
 DETAILS ZU DEN ERSATZTEILEN
 DÉTAIL DE PIÈCES DE RECHANGE

DATI TECNICI E CONSIGLI
 TECHNICAL DATA AND SUGGESTIONS
 TECHNISCHE DATEN UND EMPFEHLUNGEN
 DONNÉES TECHNIQUES ET CONSEILS

PAG. 226

PAG. 222

PAG. 1103

PAG. 1126

PTFNR/L		PTGNR/L											
90°		90°											
Ø 20x20 - 32x32		Ø 20x20 - 32x32											
<p>TNMA </p> <p>TNMG </p> <p>TNMM </p> <p>P </p>		<p>TNMA </p> <p>TNMG </p> <p>TNMM </p> <p>P </p>											
In figura utensile destro - Right-hand shown		In figura utensile destro - Right-hand shown											
		<p>INSERTI - INSERTS PAG. 197</p>											
ART. (mm)		1		2		3		4		5		6	
PTFNR/L 2020 K 16	20	20	25	125	20	1604	8009	1606	5025	3416	4109	0009	
PTFNR/L 2525 M 16	25	25	32	150	21	2204	8012	1608	5003	3422	4112	0012	
PTFNR/L 2525 M 22	25	25	32	150	27								
PTFNR/L 3225 P 22	32	25	32	170	25								
PTFNR/L 3232 P 22	32	32	40	170	25								
PTGNR/L 2020 K 16	20	20	25	125	20	1604	8009	1606	5025	3416	4109	0009	
PTGNR/L 2525 M 16	25	25	32	150	21	2204	8012	1608	5003	3422	4112	0012	
PTGNR/L 2525 M 22	25	25	32	150	27								
PTGNR/L 3225 P 22	32	25	32	170	29								
PTGNR/L 3232 P 22	32	32	40	170	29								

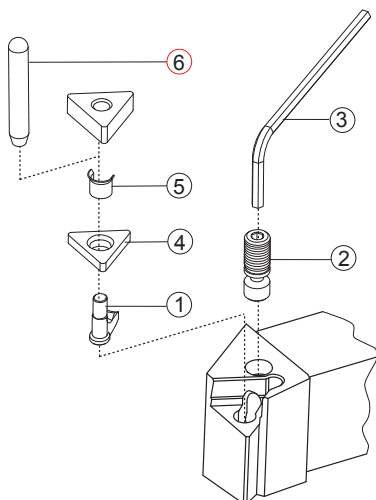

CAMPI D'IMPIEGO DEGLI INSERTI PER TORNITURA
 FIELDS OF APPLICATION FOR TURNING INSERTS
 EINSATZGEBIETE FÜR DREHPLATTEN
 CHAMPS D'USINAGE DES PLAQUETTES POUR TOURNAGE

VELOCITÀ DI TAGLIO Vc
 Vc. CUTTING SPEED
 Vc. SCHNITTGESCHWINDIGKEIT
 Vc. VITESSE DE COUPE

DETTAGLIO RICAMBI
 SPARE PARTS DETAILS
 DETAILS ZU DEN ERSATZTEILEN
 DÉTAIL DE PIÈCES DE RECHANGE

DATI TECNICI E CONSIGLI
 TECHNICAL DATA AND SUGGESTIONS
 TECHNISCHE DATEN UND EMPFEHLUNGEN
 DONNÉES TECHNIQUES ET CONSEILS

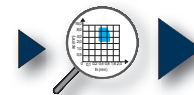

PAG. 226



PAG. 222



PAG. 1103



PAG. 1126

PWLNRL

∅ 16x16 - 32x32

95°

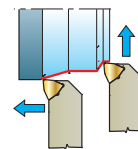
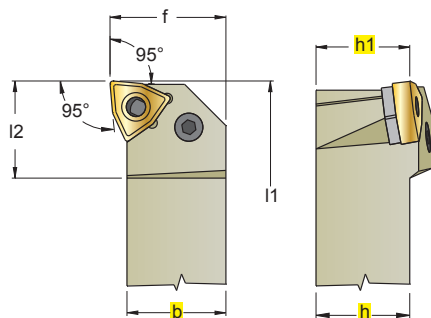

WNMA	
WNMG	
WNMM	

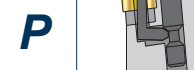

In figura utensile destro - Right-hand shown

		NEW		NEW						NEW				 INSERTI - INSERTS PAG. 199		
.G23	.G61	.F71	.G42	.F51	.G52	.G53	.G55	.G56	.K57P	.F61	.G62	.G63	.G34W			
ART. (mm)											①	②	③	④	⑤	⑥
		h=h1			b	f	l1	l2								
PWLNRL/1616	H 06	16	16	20	100	16	0604	8009	1606	5025	3306	4109	0009			
PWLNRL/2020	K 06	20	20	25	125	16										
PWLNRL/2525	M 06	25	25	32	150	16										
PWLNRL/2020	K 08	20	20	25	125	20	0804	8012	1608	5003	3308M	4112	0012			
PWLNRL/2525	M 08	25	25	32	150	21										
PWLNRL/3225	P 08	32	25	32	170	23										
PWLNRL/3232	P 08	32	32	40	170	23										

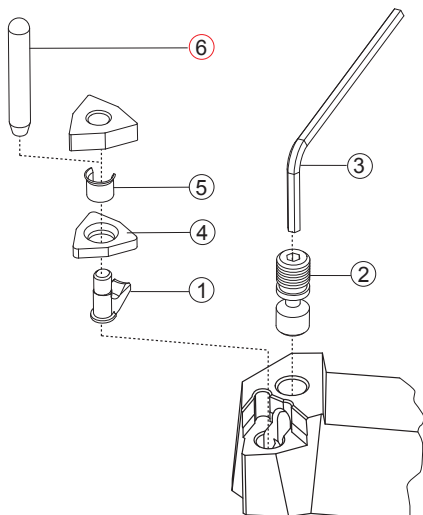

CAMPI D'IMPIEGO DEGLI INSERTI PER TORNITURA
 FIELDS OF APPLICATION FOR TURNING INSERTS
 EINSATZGEBIETE FÜR DREHPLATTEN
 CHAMPS D'USINAGE DES PLAQUETTES POUR TOURNAGE

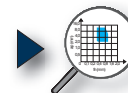

PAG. 226

VELOCITÀ DI TAGLIO Vc
 Vc. CUTTING SPEED
 Vc. SCHNITTGESCHWINDIGKEIT
 Vc. VITESSE DE COUPE



PAG. 222

DETTAGLIO RICAMBI
 SPARE PARTS DETAILS
 DETAILS ZU DEN ERSATZTEILEN
 DÉTAIL DE PIÈCES DE RECHANGE



PAG. 1103

DATI TECNICI E CONSIGLI
 TECHNICAL DATA AND SUGGESTIONS
 TECHNISCHE DATEN UND EMPFEHLUNGEN
 DONNÉES TECHNIQUES ET CONSEILS



PAG. 1126

MTJNR/L		ϕ 20x20 - 32x32		MTENN		ϕ 20x20 - 32x32	
93°				60°			
 In figura utensile destro - Right-hand shown		 25°max		 58°max		 25°max	
TNMA TNMG TNMM		TNMA TNMG TNMM		TNMA TNMG TNMM		TNMA TNMG TNMM	
ART. (mm)		h=h1 b f l1 l2		1604 2204		1 2 3 4 5 6	
MTJNR/L 2020 K 16		20 20 25 125 31		1604		100-50 5025 3216 4186 4196 5003	
MTJNR/L 2525 M 16		25 25 32 150 36		1604		100-50 5025 3216 4186 4196 5003	
MTJNR/L 3225 P 16		32 25 32 170 35		1604		100-50 5025 3216 4186 4196 5003	
MTJNR/L 2525 M 22		25 25 32 150 36		2204		100-51 5003 3222 4192 4196 -	
MTJNR/L 3225 P 22		32 25 32 170 35		2204		100-51 5003 3222 4192 4196 -	
MTJNR/L 3232 P 22		32 32 40 170 40		2204		100-51 5003 3222 4192 4196 -	
MTENN 2020 K 16		20 20 10,5 125 35		1604		100-50 5025 3216 4186 4196 5003	
MTENN 2525 M 16		25 25 13,0 150 37		1604		100-50 5025 3216 4186 4196 5003	
MTENN 2525 M 22		25 25 13,0 150 37		2204		100-51 5003 3222 4192 4196 -	
MTENN 3232 P 22		32 32 16,5 170 37		2204		100-51 5003 3222 4192 4196 -	

INSERTI - INSERTS
PAG. 197

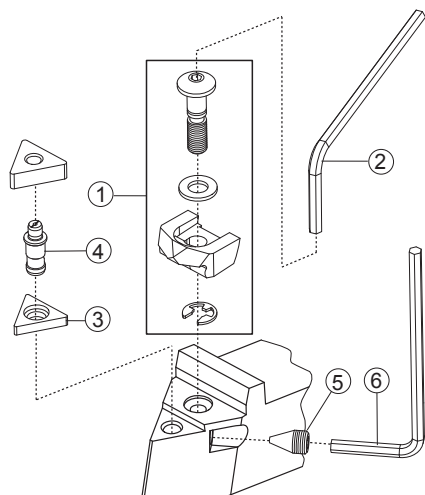

CAMPI D'IMPIEGO DEGLI INSERTI PER TORNITURA
FIELDS OF APPLICATION FOR TURNING INSERTS
EINSATZGEBIETE FÜR DREHPLATTEN
CHAMPS D'USINAGE DES PLAQUETTES POUR TOURNAGE

VELOCITÀ DI TAGLIO Vc
Vc. CUTTING SPEED
Vc. SCHNITTGESCHWINDIGKEIT
Vc. VITESSE DE COUPE

DETTAGLIO RICAMBI
SPARE PARTS DETAILS
DETAILS ZU DEN ERSATZTEILEN
DÉTAIL DE PIÈCES DE RECHANGE

DATI TECNICI E CONSIGLI
TECHNICAL DATA AND SUGGESTIONS
TECHNISCHE DATEN UND EMPFEHLUNGEN
DONNÉES TECHNIQUES ET CONSEILS

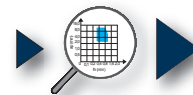

PAG. 226



PAG. 222



PAG. 1103



PAG. 1126

MWLNRL

∅ 20x20 - 32x32

95°

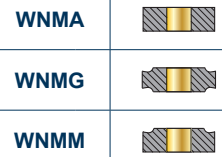
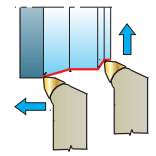
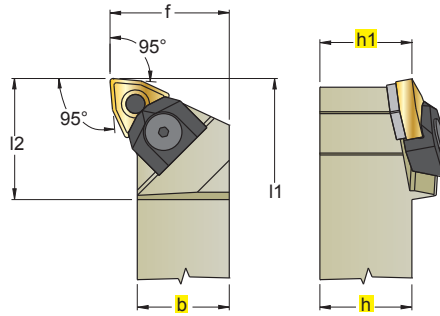

M



In figura utensile destro - Right-hand shown

NEW														INSERTI - INSERTS PAG. 199			
.G23	.G61	.F71	.G42	.F51	.G52	.G53	.G55	.G56	.K57P	.F61	.G62	.G63	.G34W				
ART. (mm)								①	②	③	④	⑤	⑥	⑦	⊙		
MWLNRL/L 2020 K 06			20	20	25	125	31	0604	100-53	-	5510	3306	4188	VBL03L	-		
MWLNRL/L 2525 M 06			25	25	32	150	25	0804	100-52	5025	-	3308M	4192	4196	5003		
MWLNRL/L 2020 K 08N			20	20	25	125	28										
MWLNRL/L 2525 M 08N			25	25	32	150	31										
MWLNRL/L 3232 P 08N			32	32	40	170	31										

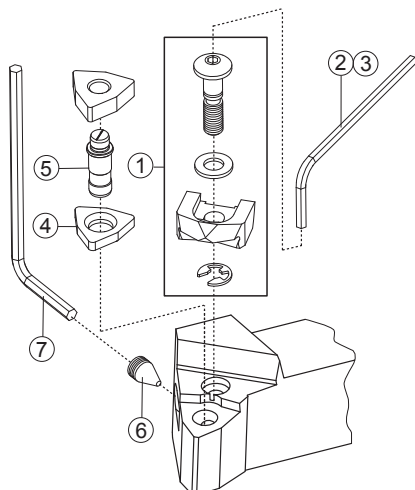

CAMPI D'IMPIEGO DEGLI INSERTI PER TORNITURA
 FIELDS OF APPLICATION FOR TURNING INSERTS
 EINSATZGEBIETE FÜR DREHPLATTEN
 CHAMPS D'USINAGE DES PLAQUETTES POUR TOURNAGE

PAG. 226

VELOCITÀ DI TAGLIO Vc
 Vc. CUTTING SPEED
 Vc. SCHNITTGESCHWINDIGKEIT
 Vc. VITESSE DE COUPE

PAG. 222

DETTAGLIO RICAMBI
 SPARE PARTS DETAILS
 DETAILS ZU DEN ERSATZTEILEN
 DÉTAIL DE PIÈCES DE RECHANGE

PAG. 1103

DATI TECNICI E CONSIGLI
 TECHNICAL DATA AND SUGGESTIONS
 TECHNISCHE DATEN UND EMPFEHLUNGEN
 DONNÉES TECHNIQUES ET CONSEILS

PAG. 1126

MCLNR/L

∅ 20x20 - 40x40

95°

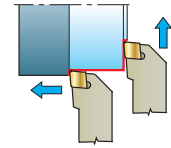
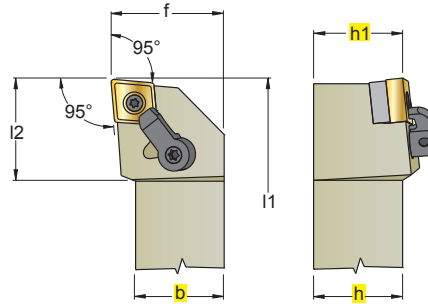

CNMA



CNMG



CNMM



M

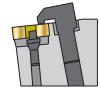

In figura utensile destro - Right-hand shown

																			 INSERTI - INSERTS PAG. 193							
.G23	.G61	.F71	.X47	.G39	.G42	.F51	.G52	.G53	.G55	.G56	.K57P	.F61	.G62	.G63	.G68	.G72	.G82	.G34W								
ART. (mm)															①	②	③	④	⑤	⑥	⑦					
MCLNR/L 2020 K 12																			1204	KCN433	KLM 46	CKM 21	STCM20	5415	KMS 4	RCN1225
MCLNR/L 2525 M 12																										
MCLNR/L 3225 P 12																										
MCLNR/L 3232 P 12																										
MCLNR/L 2525 M 16																										
MCLNR/L 3225 P 16																										
MCLNR/L 3232 P 16																										
MCLNR/L 3232 P 19																										
MCLNR/L 4040 S 19																										

ART.	DIMENSIONI MEASURES ABMESSUNGEN DIMENSIONS	INSERTO INSERT WENDEPLATTEN PLAQUETTES
RCN 1225		
	L 10,7	
	H 2,5	
	R 2,3	CN.. 1204..

- VITE DI FISSAGGIO DEL SOTTOPLACCHETTA PER INSERTI SENZA FORO
 - SHIM CLAMPING SCREW FOR INSERTS WITHOUT BORE
 - UNTERLEGPLATTENBEFESTIGUNGSSCHRAUBE FÜR WENDEPLATTEN OHNE BOHRUNG
 - VIS DE FIXAGE DE SOUS-PLAQUETTE POUR PLAQUETTES SANS TROU
- ROMPIRUCIOLO PER INSERTI CERAMICI E SENZA FORO
 - CHIP BREAKER FOR CERAMIC INSERTS AND FOR INSERTS WITHOUT BORE
 - SPANBRECHER FÜR KERAMISCHE WENDEPLATTEN UND FÜR WENDEPLATTEN OHNE KUEHLMITTELBOHRUNG
 - BRISÉ-CPEAUX POUR PLAQUETTES CERAMIQUES ET POUR PLAQUETTES SANS TROU

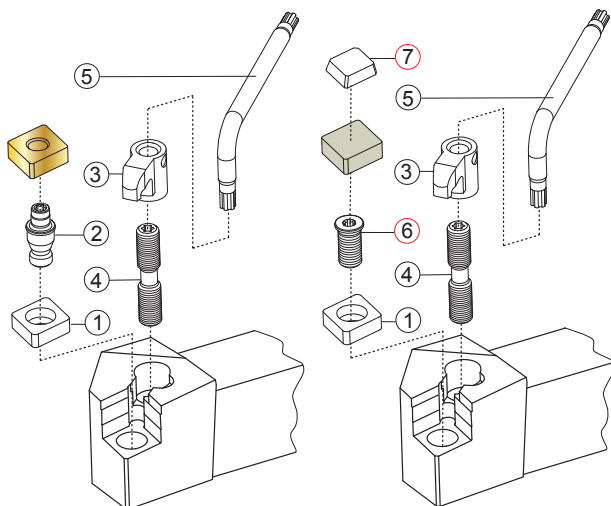

- CAMPI D'IMPIEGO DEGLI INSERTI PER TORNITURA
 - FIELDS OF APPLICATION FOR TURNING INSERTS
 - EINSATZGEBIETE FÜR DREHPLATTEN
 - CHAMPS D'USINAGE DES PLAQUETTES POUR Tournage



PAG. 226

- VELOCITÀ DI TAGLIO Vc
 - Vc. CUTTING SPEED
 - Vc. SCHNITTGESCHWINDIGKEIT
 - Vc. VITESSE DE COUPE



PAG. 222

- DETTAGLIO RICAMBI
 - SPARE PARTS DETAILS
 - DETAILS ZU DEN ERSATZTEILEN
 - DÉTAIL DE PIÈCES DE RECHANGE



PAG. 1103

- DATI TECNICI E CONSIGLI
 - TECHNICAL DATA AND SUGGESTIONS
 - TECHNISCHE DATEN UND EMPFEHLUNGEN
 - DONNÉES TECHNIQUES ET CONSEILS



PAG. 1126

MDJNR/L \varnothing 20x20 - 32x32								MDQNR/L \varnothing 25x25							
93°								107,5°							
<p>In figura utensile destro - Right-hand shown</p>								<p>In figura utensile destro - Right-hand shown</p>							
ART.								INSERTI - INSERTS PAG. 195							
(mm)															
h=h1 b f l1 l2								① ② ③ ④ ⑤ ⑥							
MDJNR/L 2020 K 15	20	20	25	125	35	1506	KDN433	KLM 46L	CKM 22	STCM20	5415	KMS 4			
MDJNR/L 2525 M 15	25	25	32	150	35	1506	KDN433	KLM 46L	CKM 22	STCM20	5415	KMS 4			
MDJNR/L 3225 P 15	32	25	32	170	36										
MDJNR/L 3232 P 15	32	32	40	170	36										
<p> - VITE DI FISSAGGIO DEL SOTTOPLACCHETTA PER INSERTI SENZA FORO - SHIM CLAMPING SCREW FOR INSERTS WITHOUT BORE - UNTERLEGPLATTENBEFESTIGUNGSSCHRAUBE FÜR WENDEPLATTEN OHNE BOHRUNG - VIS DE FIXAGE DE SOUS-PLAQUETTE POUR PLAQUETTES SANS TROU </p>															
MDQNR/L 2525 M 15	25	25	32	150	36	1506	KDN433	KLM 46L	CKM 22	STCM20	5415	KMS 4			
<p> - VITE DI FISSAGGIO DEL SOTTOPLACCHETTA PER INSERTI SENZA FORO - SHIM CLAMPING SCREW FOR INSERTS WITHOUT BORE - UNTERLEGPLATTENBEFESTIGUNGSSCHRAUBE FÜR WENDEPLATTEN OHNE BOHRUNG - VIS DE FIXAGE DE SOUS-PLAQUETTE POUR PLAQUETTES SANS TROU </p>															

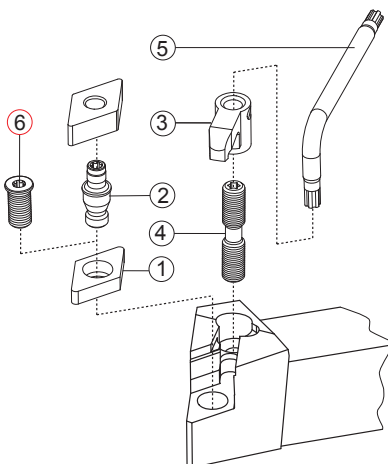

CAMPI D'IMPIEGO DEGLI INSERTI PER TORNITURA
 FIELDS OF APPLICATION FOR TURNING INSERTS
 EINSATZGEBIETE FÜR DREHPLATTEN
 CHAMPS D'USINAGE DES PLAQUETTES POUR TOURNAGE

VELOCITÀ DI TAGLIO Vc
 Vc. CUTTING SPEED
 Vc. SCHNITTGESCHWINDIGKEIT
 Vc. VITESSE DE COUPE

DETTAGLIO RICAMBI
 SPARE PARTS DETAILS
 DETAILS ZU DEN ERSATZTEILEN
 DÉTAIL DE PIÈCES DE RECHANGE

DATI TECNICI E CONSIGLI
 TECHNICAL DATA AND SUGGESTIONS
 TECHNISCHE DATEN UND EMPFEHLUNGEN
 DONNÉES TECHNIQUES ET CONSEILS



MSSNR/L \varnothing 20x20 - 40x40								MSBNR/L \varnothing 32x32 - 40x40							
45°								75°							
SNMA				SNMG				SNMM				M			
In figura utensile destro - Right-hand shown								In figura utensile destro - Right-hand shown							
ART. (mm)															
		h=h1		b		f		l1		l2					
MSSNR/L 2020	K 12	20	20	25	125	32	1204	KSN433	KLM 46	CKM 21	STCM20	5415	KMS 4	RSN1225	
MSSNR/L 2525	M 12	25	25	32	150	33									
MSSNR/L 3232	P 12	32	32	40	170	40									
MSSNR/L 3232	P 19	32	32	40	170	40	1906	KSN633	KLM 68	CKM 12	STCM4	5425	KMS 6	-	
MSSNR/L 4040	S 19	40	40	50	250	40									
<hr/>															
MSBNR/L 3232	P 19	32	32	27	170	39	1906	KSN633	KLM 68	CKM 12	STCM4	5425	KMS 6	-	
MSBNR/L 4040	S 19	40	40	35	250	39									

ART.	DIMENSIONI MEASURES ABMESSUNGEN DIMENSIONS	INSERTO INSERT WENDEPLATTEN PLAQUETTES
RSN 1225		

- VITE DI FISSAGGIO DEL SOTTOPLACCHETTA PER INSERTI SENZA FORO
 - SHIM CLAMPING SCREW FOR INSERTS WITHOUT BORE
 - UNTERLEGPLATTENBEFESTIGUNGSSCHRAUBE FÜR WENDEPLATTEN OHNE BOHRUNG
 - VIS DE FIXAGE DE SOUS-PLAQUETTE POUR PLAQUETTES SANS TROU

- ROMPIRUCIOLO PER INSERTI CERAMICI E SENZA FORO
 - CHIP BREAKER FOR CERAMIC INSERTS AND FOR INSERTS WITHOUT BORE
 - SPANBRECHER FUER KERAMISCHE WENDEPLATTEN UND FUER WENDEPLATTEN OHNE KUEHLMITTELBOHRUNG
 - BRISE-CPEAUX POUR PLAQUETTES CERAMIQUES ET POUR PLAQUETTES SANS TROU

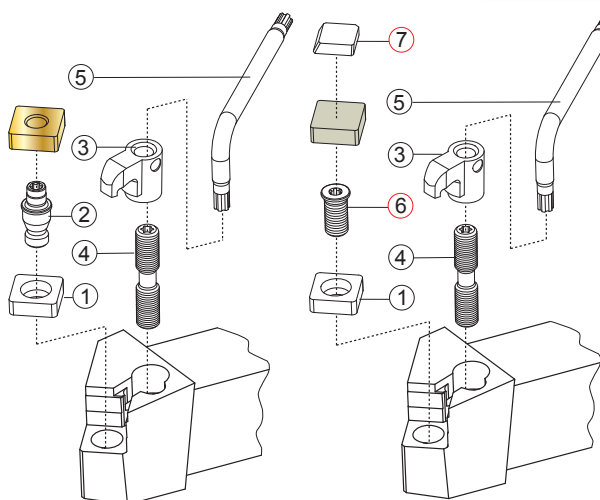

- CAMPI D'IMPIEGO DEGLI INSERTI PER TORNITURA
 - FIELDS OF APPLICATION FOR TURNING INSERTS
 - EINSATZGEBIETE FÜR DREHPLATTEN
 - CHAMPS D'USINAGE DES PLAQUETTES POUR Tournage

- VELOCITÀ DI TAGLIO Vc
 - Vc. CUTTING SPEED
 - Vc. SCHNITTGESCHWINDIGKEIT
 - Vc. VITESSE DE COUPE

- DETTAGLIO RICAMBI
 - SPARE PARTS DETAILS
 - DETAILS ZU DEN ERSATZTEILEN
 - DÉTAIL DE PIÈCES DE RECHANGE

- DATI TECNICI E CONSIGLI
 - TECHNICAL DATA AND SUGGESTIONS
 - TECHNISCHE DATEN UND EMPFEHLUNGEN
 - DONNÉES TECHNIQUES ET CONSEILS



PAG. 226



PAG. 222



PAG. 1103



PAG. 1126

MVPCR/L

∅ 20x20 - 32x32

117,5°

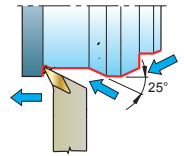
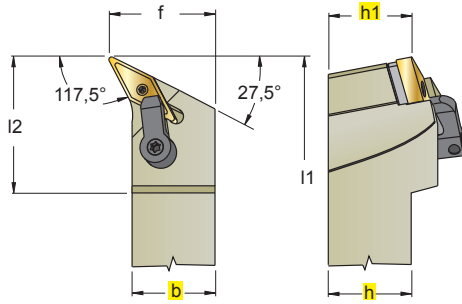

VNMG



M



In figura utensile destro - Right-hand shown

																		INSERTI - INSERTS PAG. 198	
.G23	.G42	.G52	.G53	.G55															
ART.		(mm)																	
		h=h1	b	f	l1	l2		1	2	3	4	5	6	7					
MVPCR/L	2020 K 16	20	20	25	125	41	1604	KVN323	KLM34L	5508	CKM22	STCM20	5415	KMS 3					
MVPCR/L	2525 M 16	25	25	32	150	41													
MVPCR/L	3225 P 16	32	25	32	170	41													
MVPCR/L	3232 P 16	32	32	40	170	40													

- VITE DI FISSAGGIO DEL SOTTOPLACCHETTA PER INSERTI SENZA FORO
 - SHIM CLAMPING SCREW FOR INSERTS WITHOUT BORE
 - UNTERLEGPLATTENBEFESTIGUNGSSCHRAUBE FÜR WENDEPLATTEN OHNE BOHRUNG
 - VIS DE FIXAGE DE SOUS-PLAQUETTE POUR PLAQUETTES SANS TROU

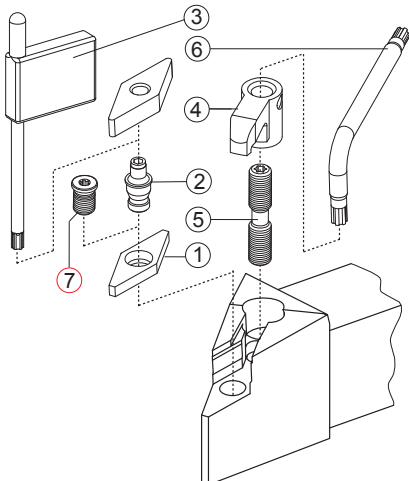

CAMPI D'IMPIEGO DEGLI INSERTI PER TORNITURA
 FIELDS OF APPLICATION FOR TURNING INSERTS
 EINSATZGEBIETE FÜR DREHPLATTEN
 CHAMPS D'USINAGE DES PLAQUETTES POUR TOURNAGE

VELOCITÀ DI TAGLIO Vc
 Vc. CUTTING SPEED
 Vc. SCHNITTGESCHWINDIGKEIT
 Vc. VITESSE DE COUPE

DETTAGLIO RICAMBI
 SPARE PARTS DETAILS
 DETAILS ZU DEN ERSATZTEILEN
 DÉTAIL DE PIÈCES DE RECHANGE

DATI TECNICI E CONSIGLI
 TECHNICAL DATA AND SUGGESTIONS
 TECHNISCHE DATEN UND EMPFEHLUNGEN
 DONNÉES TECHNIQUES ET CONSEILS

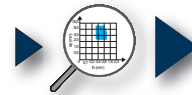

PAG. 226



PAG. 222



PAG. 1103



PAG. 1126

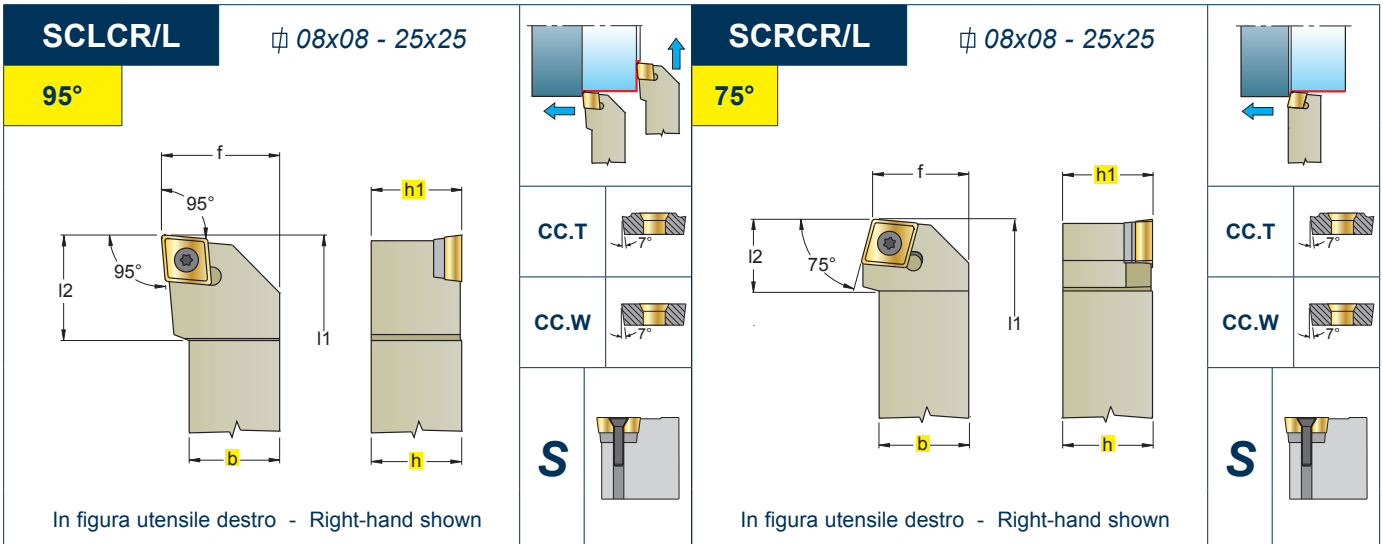

ART.		(mm)							Nm	0602	①	②	③	④	⊙
R	L	h=h1	b	f	l1	l2									
SCLCR/L	0808 D 06	8	8	10	60	10	1,1+1,3	0602	-	-	12256P	5508P			
SCLCR/L	1010 E 06	10	10	12	70	10	1,1+1,3	0602	-	-	12256P	5508P			
SCLCR/L	1212 F 09	12	12	16	80	15	3,8+5,0	09T3	-	-	12409P	5515P			
SCLCR/L	1616 H 09	16	16	20	100	15	3,0+3,5	09T3	3609	BCL7	123511P	5515P			
SCLCR/L	2020 K 09	20	20	25	125	17	3,0+3,5	09T3	3609	BCL7	123511P	5515P			
SCLCR/L	2525 M 09	25	25	32	150	18	3,0+3,5	09T3	3609	BCL7	123511P	5515P			
SCLCR/L	1616 H 12	16	16	20	100	20	4,0+5,0	1204	3611	BCL15	124513P	5520P			
SCLCR/L	2020 K 12	20	20	25	125	20	4,0+5,0	1204	3611	BCL15	124513P	5520P			
SCLCR/L	2525 M 12	25	25	32	150	20	4,0+5,0	1204	3611	BCL15	124513P	5520P			

- PER UTENSILE R MONTARE INSERTO CCET..R.B22 , PER UTENSILE L MONTARE INSERTO CCET..L.B22
 - FOR R TOOL FIT INSERT CCET..R.B22, FOR L TOOL FIT INSERT CCET..L.B22
 - FÜR DAS WERKZEUG R DIE WENDEPLATTE CCET..R.B22 EINSETZEN; FÜR DAS WERKZEUG L DIE WENDEPLATTE CCET..L.B22...
 - DANS LE CAS DE L'OUTIL R MONTER LA PLAQUETTE CCET..R.B22, DANS LE CAS DE L'OUTIL L MONTER LA PLAQUETTE CCET..L.B22

ART.		(mm)							Nm	0602	①	②	③	④	⊙
R	L	h=h1	b	f	l1	l2									
SCRCR/L	0808 D 06	8	8	9	60	10	1,1+1,3	0602	-	-	12256P	5508P			
SCRCR/L	1010 E 06	10	10	11	70	10	1,1+1,3	0602	-	-	12256P	5508P			
SCRCR/L	1212 F 09	12	12	13	80	15	3,8+5,0	09T3	-	-	12409P	5515P			
SCRCR/L	1616 H 09	16	16	17	100	15	3,0+3,5	09T3	3609	BCL7	123511P	5515P			
SCRCR/L	2020 K 09	20	20	22	125	18	3,0+3,5	09T3	3609	BCL7	123511P	5515P			
SCRCR/L	1616 H 12	16	16	17	100	20	4,0+5,0	1204	3611	BCL15	124513P	5520P			
SCRCR/L	2020 K 12	20	20	22	125	20	4,0+5,0	1204	3611	BCL15	124513P	5520P			
SCRCR/L	2525 M 12	25	25	27	150	20	4,0+5,0	1204	3611	BCL15	124513P	5520P			

- PER UTENSILE R MONTARE INSERTO CCET..R.B22 , PER UTENSILE L MONTARE INSERTO CCET..L.B22
 - FOR R TOOL FIT INSERT CCET..R.B22, FOR L TOOL FIT INSERT CCET..L.B22
 - FÜR DAS WERKZEUG R DIE WENDEPLATTE CCET..R.B22 EINSETZEN; FÜR DAS WERKZEUG L DIE WENDEPLATTE CCET..L.B22...
 - DANS LE CAS DE L'OUTIL R MONTER LA PLAQUETTE CCET..R.B22, DANS LE CAS DE L'OUTIL L MONTER LA PLAQUETTE CCET..L.B22

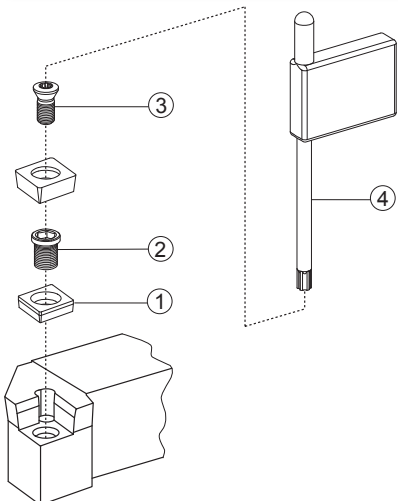





CAMPI D'IMPIEGO DEGLI INSERTI PER TORNITURA
 FIELDS OF APPLICATION FOR TURNING INSERTS
 EINSATZGEBIETE FÜR DREHPLATTEN
 CHAMPS D'USINAGE DES PLAQUETTES POUR TOURNAGE

VELOCITÀ DI TAGLIO Vc
 Vc. CUTTING SPEED
 Vc. SCHNITTGESCHWINDIGKEIT
 Vc. VITESSE DE COUPE



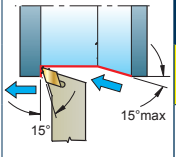
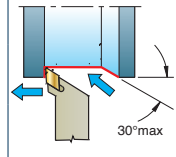
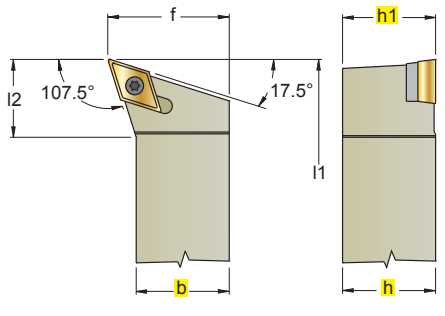
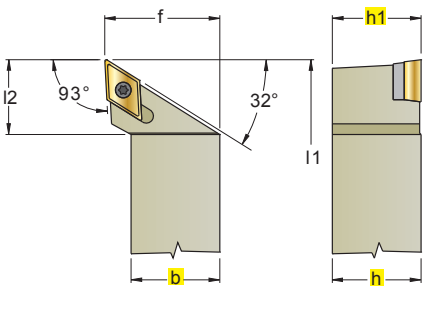

DETTAGLIO RICAMBI
 SPARE PARTS DETAILS
 DETAILS ZU DEN ERSATZTEILEN
 DÉTAIL DE PIÈCES DE RECHANGE

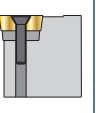
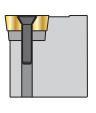
DATI TECNICI E CONSIGLI
 TECHNICAL DATA AND SUGGESTIONS
 TECHNISCHE DATEN UND EMPFEHLUNGEN
 DONNÉES TECHNIQUES ET CONSEILS







SDHCR/L	∅ 10x10 - 25x25		SDJCR/L	∅ 08x08 - 25x25	
107,5°			93°		
					
DC.T 		DC.T 			
DC.W 		DC.W 			
S 		S 			
In figura utensile destro - Right-hand shown			In figura utensile destro - Right-hand shown		

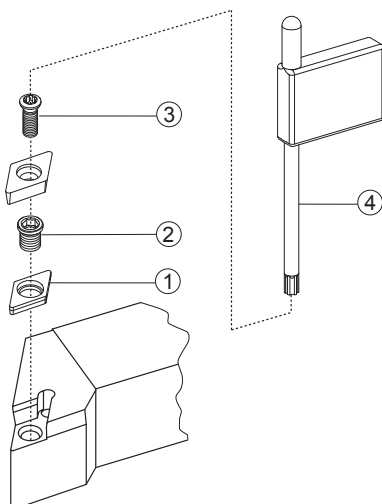

															 INSERTI - INSERTS PAG. 203
.G13	L.F45	R.F45	.F46	.F47	.B53	.G57P	.X47	.F32	.F33	.G39	.G42	.F51	.G52	.G32W	

ART.	(mm)							Nm		   			
	R	L	h=h1	b	f	l1	l2			1	2	3	4
SDHCR/L 1010 E 07			10	10	12	70	10	1,1+1,3	0702	-	-	12256P	5508P
SDHCR/L 1212 F 07			12	12	16	80	12	1,1+1,3					
SDHCR/L 1616 H 11			16	16	20	100	19	3,0+3,5	11T3	3711	BCL7	123511P	5515P
SDHCR/L 2020 K 11			20	20	25	125	18	3,0+3,5					
SDHCR/L 2525 M 11			25	25	32	150	20	3,0+3,5					
SDJCR/L 0808 D 07			8	8	10	60	14	1,1+1,3	0702	-	-	12256P	5508P
SDJCR/L 1010 E 07			10	10	12	70	14	1,1+1,3					
SDJCR/L 1212 F 07			12	12	16	80	14	1,1+1,3					
SDJCR/L 1212 F 11			12	12	16	80	21	3,8+5,0	11T3	-	-	12409P	5515P
SDJCR/L 1616 H 11			16	16	20	100	22	3,0+3,5	11T3	3711	BCL7	123511P	5515P
SDJCR/L 2020 K 11			20	20	25	125	23	3,0+3,5					
SDJCR/L 2525 M 11			25	25	32	150	27	3,0+3,5					



 CAMPI D'IMPIEGO DEGLI INSERTI PER TORNITURA
 FIELDS OF APPLICATION FOR TURNING INSERTS
 EINSATZGEBIETE FÜR DREHPLATTEN
 CHAMPS D'USINAGE DES PLAQUETTES POUR Tournage

 VELOCITÀ DI TAGLIO Vc
 Vc. CUTTING SPEED
 Vc. SCHNITTGESCHWINDIGKEIT
 Vc. VITESSE DE COUPE

 DETTAGLIO RICAMBI
 SPARE PARTS DETAILS
 DETAILS ZU DEN ERSATZTEILEN
 DÉTAIL DE PIÈCES DE RECHANGE

 DATI TECNICI E CONSIGLI
 TECHNICAL DATA AND SUGGESTIONS
 TECHNISCHE DATEN UND EMPFEHLUNGEN
 DONNÉES TECHNIQUES ET CONSEILS

 **PAG. 226**

 **PAG. 222**

 **PAG. 1103**

 **PAG. 1126**

SDNCN

∅ 08x08 - 25x25

63°

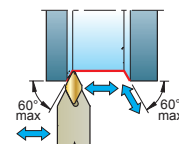
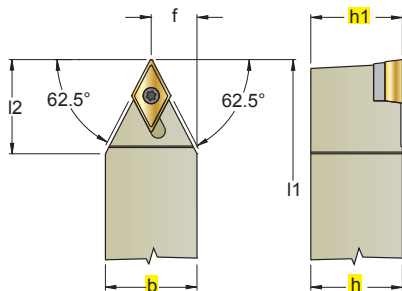

DC.T



DC.W



S



	NEW	NEW	NEW	NEW				NEW	NEW			NEW			 INSERTI - INSERTS PAG. 203
.G13	L.F45	R.F45	.F46	.F47	.B53	.G57P	.X47	.F32	.F33	.G39	.G42	.F51	.G52	.G32W	

ART.		(mm)							Nm		① ② ③ ④				
R	L	h=h1	b	f	l1	l2									
SDNCN	0808 D 07	8	8	4,0	60	9	1,1+1,3	0702	-	-	12256P	5508P			
SDNCN	1010 E 07	10	10	5,0	70	11	1,1+1,3								
SDNCN	1212 F 07	12	12	6,0	80	13	1,1+1,3								
SDNCN	1212 F 11	12	12	6,0	80	12	3,8+5,0	11T3	-	-	12409P	5515P			
SDNCN	1616 H 11	16	16	8,0	100	16	3,0+3,5	11T3	3711	BCL7	123511P	5515P			
SDNCN	2020 K 11	20	20	10,0	125	20	3,0+3,5								
SDNCN	2525 M 11	25	25	12,5	150	25	3,0+3,5								

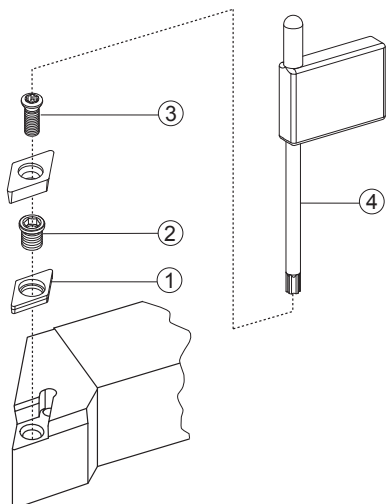

CAMPI D'IMPIEGO DEGLI INSERTI PER TORNITURA
 FIELDS OF APPLICATION FOR TURNING INSERTS
 EINSATZGEBIETE FÜR DREHPLATTEN
 CHAMPS D'USINAGE DES PLAQUETTES POUR TOURNAGE

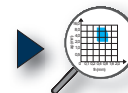

PAG. 226

VELOCITÀ DI TAGLIO Vc
 Vc. CUTTING SPEED
 Vc. SCHNITTGESCHWINDIGKEIT
 Vc. VITESSE DE COUPE



PAG. 222

DETTAGLIO RICAMBI
 SPARE PARTS DETAILS
 DETAILS ZU DEN ERSATZTEILEN
 DÉTAIL DE PIÈCES DE RECHANGE



PAG. 1103

DATI TECNICI E CONSIGLI
 TECHNICAL DATA AND SUGGESTIONS
 TECHNISCHE DATEN UND EMPFEHLUNGEN
 DONNÉES TECHNIQUES ET CONSEILS



PAG. 1126

SRDCN

∅ 12x12 - 25x25

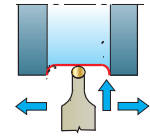
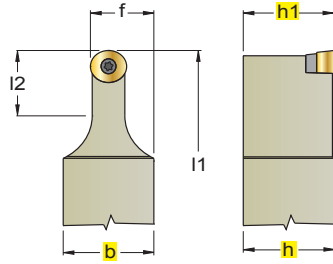

RC.T

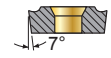

RC.W

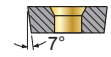

S



.Z57 .G52

INSERTI - INSERTS
PAG. 205

ART.	(mm)						Nm	0602M0	①	②	③	④	○	
	R	L	h=h1	b	f	l1			l2	①	②	③		④
SRDCN 1212 F 06			12	12	9,0	80	12,5	1,1+1,3	0602M0	-	-	12256P	5508P	
SRDCN 1616 H 06			16	16	11,0	100	12,5	1,1+1,3						
SRDCN 2020 K 06			20	20	13,0	125	12,5	1,1+1,3						
SRDCN 2525 M 06			25	25	15,5	150	12,5	1,1+1,3						
SRDCN 1616 H 08			16	16	12,0	100	16,5	1,2+1,5	0803M0	-	-	123008P	5508P	
SRDCN 2020 K 08			20	20	14,0	125	16,5	1,2+1,5						
SRDCN 2525 M 08			25	25	16,5	150	16,5	1,2+1,5						
SRDCN 1616 H 10			16	16	13,0	100	20,5	3,0+3,5	1003M0	3810	BCL7	123511P	5515P	
SRDCN 2020 K 10			20	20	15,0	125	20,5	3,0+3,5						
SRDCN 2525 M 10			25	25	17,5	150	20,5	3,0+3,5						

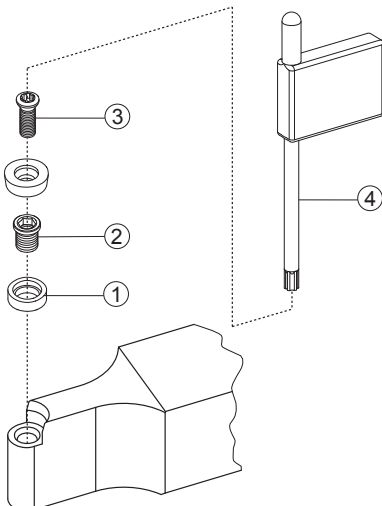

CAMPI D'IMPIEGO DEGLI INSERTI PER TORNITURA
FIELDS OF APPLICATION FOR TURNING INSERTS
EINSATZGEBIETE FÜR DREHPLATTEN
CHAMPS D'USINAGE DES PLAQUETTES POUR TOURNAGE

VELOCITÀ DI TAGLIO Vc
Vc. CUTTING SPEED
Vc. SCHNITTGESCHWINDIGKEIT
Vc. VITESSE DE COUPE

DETTAGLIO RICAMBI
SPARE PARTS DETAILS
DETAILS ZU DEN ERSATZTEILEN
DÉTAIL DE PIÈCES DE RECHANGE

DATI TECNICI E CONSIGLI
TECHNICAL DATA AND SUGGESTIONS
TECHNISCHE DATEN UND EMPFEHLUNGEN
DONNÉES TECHNIQUES ET CONSEILS

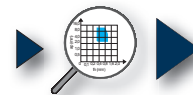

PAG. 226



PAG. 222



PAG. 1103



PAG. 1126

SSSCR/L

∅ 12x12 - 25x25

45°

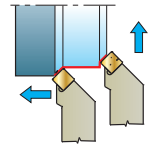
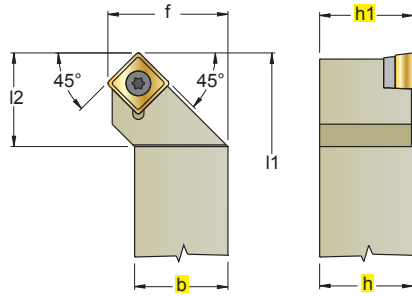

SC.T

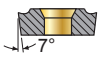

SC.W

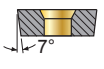

S

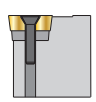

In figura utensile destro - Right-hand shown

NEW		NEW																		 INSERTI - INSERTS PAG. 205	
.F51		.G57		.G57P		.G52															
ART.																					

STFCR/L		Ø 08x08 - 25x25		STGCR/L		Ø 08x08 - 25x25					
90°				90°							
TC.T				TC.T							
TC.W				TC.W							
S				S							
In figura utensile destro - Right-hand shown				In figura utensile destro - Right-hand shown							
.G39 .G57P .X37 .X47 .G39 .S42 .G52											
INSERTI - INSERTS PAG. 206											
ART.	(mm)										
	h=h1	b	f	l1	l2	Nm		①	②	③	④
STFCR/L 0808 D 09	8	8	10	60	10	0,9+1,0	0902	-	-	12225P	5507P
STFCR/L 1010 E 09	10	10	12	70	10	0,9+1,0	1102	-	-	12256P	5508P
STFCR/L 1212 F 11	12	12	16	80	14	1,1+1,3					
STFCR/L 1616 H 11	16	16	20	100	15	1,1+1,3	16T3	3415	BCL7	123511P	5515P
STFCR/L 1616 H 16	16	16	20	100	20	3,0+3,5					
STFCR/L 2020 K 16	20	20	25	125	23	3,0+3,5					
STFCR/L 2525 M 16	25	25	32	150	23	3,0+3,5					
<hr/>											
STGCR/L 0808 D 09	8	8	10	60	10	0,9+1,0	0902	-	-	12225P	5507P
STGCR/L 1010 E 09	10	10	12	70	10	0,9+1,0	1102	-	-	12256P	5508P
STGCR/L 1212 F 11	12	12	16	80	15	1,1+1,3					
STGCR/L 1616 H 11	16	16	20	100	15	1,1+1,3	16T3	3415	BCL7	123511P	5515P
STGCR/L 1616 H 16	16	16	20	100	20	3,0+3,5					
STGCR/L 2020 K 16	20	20	25	125	20	3,0+3,5					
STGCR/L 2525 M 16	25	25	32	150	20	3,0+3,5					

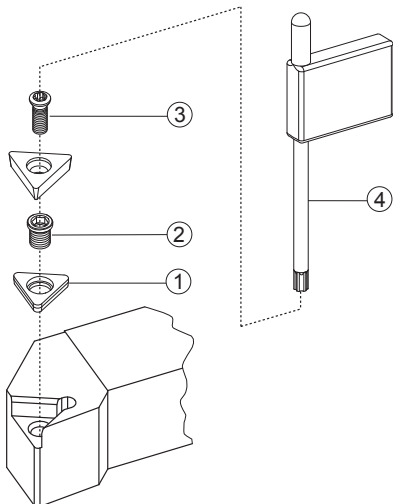

CAMPI D'IMPIEGO DEGLI INSERTI PER TORNITURA
 FIELDS OF APPLICATION FOR TURNING INSERTS
 EINSATZGEBIETE FÜR DREHPLATTEN
 CHAMPS D'USINAGE DES PLAQUETTES POUR TOURNAGE

VELOCITÀ DI TAGLIO Vc
 Vc. CUTTING SPEED
 Vc. SCHNITTGESCHWINDIGKEIT
 Vc. VITESSE DE COUPE

DETTAGLIO RICAMBI
 SPARE PARTS DETAILS
 DETAILS ZU DEN ERSATZTEILEN
 DÉTAIL DE PIÈCES DE RECHANGE

DATI TECNICI E CONSIGLI
 TECHNICAL DATA AND SUGGESTIONS
 TECHNISCHE DATEN UND EMPFEHLUNGEN
 DONNÉES TECHNIQUES ET CONSEILS

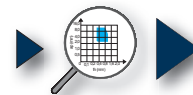

PAG. 226



PAG. 222



PAG. 1103



PAG. 1126

SVHCR/L										SVJCR/L																			
Ø 16x16 - 32x25										Ø 12x12 - 32x25																			
107,5°										93°																			
VC.T					VC.W					S					VC.T					VC.W					S				
In figura utensile destro - Right-hand shown										In figura utensile destro - Right-hand shown																			
ART.										INSERTI - INSERTS PAG. 207																			
(mm)										1 2 3 4																			
h=h1 b f l1 l2 Nm																													
SVHCR/L 1616 H 11	SVHCR/L 2020 K 11	SVHCR/L 2525 M 11	SVHCR/L 2020 K 16	SVHCR/L 2525 M 16	SVHCR/L 3225 P 16	SVJCR/L 1212 F 11	SVJCR/L 1616 H 11	SVJCR/L 2020 K 11	SVJCR/L 2525 M 11	SVJCR/L 2020 K 16	SVJCR/L 2525 M 16	SVJCR/L 3225 P 16	SVJCR/L 1212 F 11	SVJCR/L 1616 H 11	SVJCR/L 2020 K 11	SVJCR/L 2525 M 11	SVJCR/L 2020 K 16	SVJCR/L 2525 M 16	SVJCR/L 3225 P 16	SVJCR/L 1212 F 11	SVJCR/L 1616 H 11	SVJCR/L 2020 K 11	SVJCR/L 2525 M 11	SVJCR/L 2020 K 16	SVJCR/L 2525 M 16	SVJCR/L 3225 P 16			
16	20	25	20	25	32	12	16	20	25	20	25	32	1103	1103	1103	1103	1103	1103	1103	1103	1103	1103	1103	1103	1103	1103	1103		
16	20	25	20	25	32	16	16	20	25	20	25	32	1604	1604	1604	1604	1604	1604	1604	1604	1604	1604	1604	1604	1604	1604	1604		
20	25	32	25	32	32	16	20	25	32	25	32	32	1,1+1,3	1,1+1,3	1,1+1,3	1,1+1,3	1,1+1,3	1,1+1,3	1,1+1,3	1,1+1,3	1,1+1,3	1,1+1,3	1,1+1,3	1,1+1,3	1,1+1,3	1,1+1,3	1,1+1,3		
100	125	150	125	150	170	80	100	125	150	125	150	170	3,0+3,5	3,0+3,5	3,0+3,5	3,0+3,5	3,0+3,5	3,0+3,5	3,0+3,5	3,0+3,5	3,0+3,5	3,0+3,5	3,0+3,5	3,0+3,5	3,0+3,5	3,0+3,5	3,0+3,5		
15	18	25	17	23	23	21	24	23	27	30	33	33	1103	1103	1103	1103	1103	1103	1103	1103	1103	1103	1103	1103	1103	1103	1103		
1103	1103	1103	1103	1103	1103	1103	1103	1103	1103	1103	1103	1103	1103	1103	1103	1103	1103	1103	1103	1103	1103	1103	1103	1103	1103	1103	1103	1103	
-	-	-	-	-	-	-	-	-	-	-	-	-	-	-	-	-	-	-	-	-	-	-	-	-	-	-	-		
12256P	5508P	12256P	5508P	12256P	5508P	12256P	5508P	12256P	5508P	12256P	5508P	12256P	5508P	12256P	5508P	12256P	5508P	12256P	5508P	12256P	5508P	12256P	5508P	12256P	5508P	12256P	5508P		
5508P	5515P	5515P	5515P	5515P	5515P	5508P	5508P	5508P	5508P	5508P	5508P	5508P	5508P	5508P	5508P	5508P	5508P	5508P	5508P	5508P	5508P	5508P	5508P	5508P	5508P	5508P	5508P	5508P	

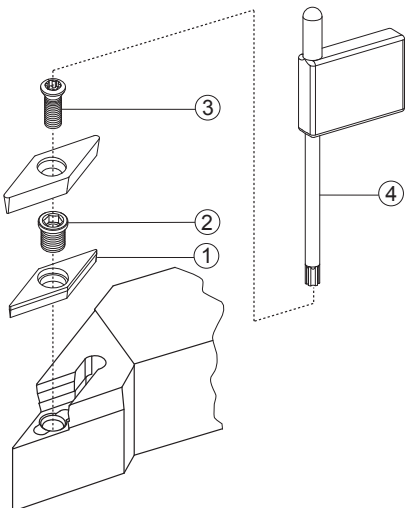

CAMPI D'IMPIEGO DEGLI INSERTI PER TORNITURA
 FIELDS OF APPLICATION FOR TURNING INSERTS
 EINSATZGEBIETE FÜR DREHPLATTEN
 CHAMPS D'USINAGE DES PLAQUETTES POUR TOURNAGE

VELOCITÀ DI TAGLIO Vc
 Vc. CUTTING SPEED
 Vc. SCHNITTGESCHWINDIGKEIT
 Vc. VITESSE DE COUPE

DETTAGLIO RICAMBI
 SPARE PARTS DETAILS
 DETAILS ZU DEN ERSATZTEILEN
 DÉTAIL DE PIÈCES DE RECHANGE

DATI TECNICI E CONSIGLI
 TECHNICAL DATA AND SUGGESTIONS
 TECHNISCHE DATEN UND EMPFEHLUNGEN
 DONNÉES TECHNIQUES ET CONSEILS

PAG. 226

PAG. 222

PAG. 1103

PAG. 1126

SVXCR/L										SVVCN										
Ø 20x20 - 25x25										Ø 16x16 - 32x25										
VC.T										VC.T										
VC.W										VC.W										
S										S										
In figura utensile destro - Right-hand shown																				
										 INSERTI - INSERTS PAG. 207										
ART.																				
(mm)																				
h=h1										b										
f										l1										
l2										Nm										
SVXCR/L	2020	K	16	20	20	25	125	25	3,0+3,5	1604	3716	BCL7	123511P	5515P						
SVXCR/L	2525	M	16	25	25	32	150	25	3,0+3,5											
SVVCN	1616	H	11	16	16	8,0	100	26	1,1+1,3	1103	-	-	12256P	5508P						
SVVCN	2020	K	11	20	20	10,0	125	32	1,1+1,3											
SVVCN	2525	M	11	25	25	12,5	150	40	1,1+1,3											
SVVCN	2020	K	16	20	20	10,0	125	34	3,0+3,5	1604	3716	BCL7	123511P	5515P						
SVVCN	2525	M	16	25	25	12,5	150	42	3,0+3,5											
SVVCN	3225	P	16	32	25	12,5	170	42	3,0+3,5											

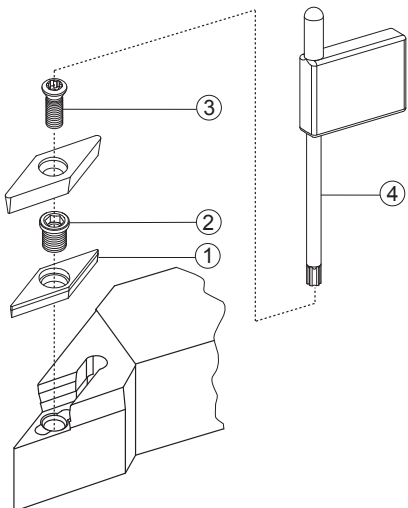

CAMPI D'IMPIEGO DEGLI INSERTI PER TORNITURA
 FIELDS OF APPLICATION FOR TURNING INSERTS
 EINSATZGEBIETE FÜR DREHPLATTEN
 CHAMPS D'USINAGE DES PLAQUETTES POUR TOURNAGE

VELOCITÀ DI TAGLIO Vc
 Vc. CUTTING SPEED
 Vc. SCHNITTGESCHWINDIGKEIT
 Vc. VITESSE DE COUPE

DETTAGLIO RICAMBI
 SPARE PARTS DETAILS
 DETAILS ZU DEN ERSATZTEILEN
 DÉTAIL DE PIÈCES DE RECHANGE

DATI TECNICI E CONSIGLI
 TECHNICAL DATA AND SUGGESTIONS
 TECHNISCHE DATEN UND EMPFEHLUNGEN
 DONNÉES TECHNIQUES ET CONSEILS

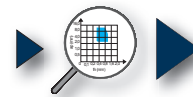

PAG. 226



PAG. 222



PAG. 1103



PAG. 1126

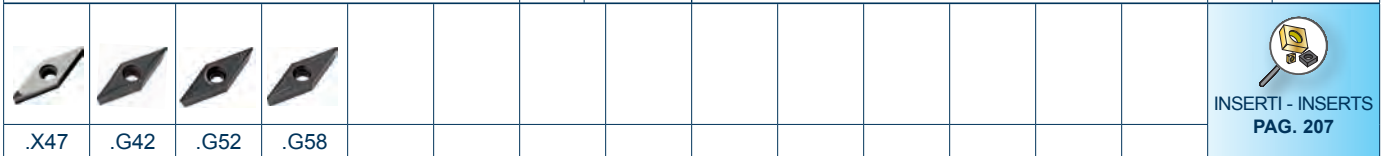
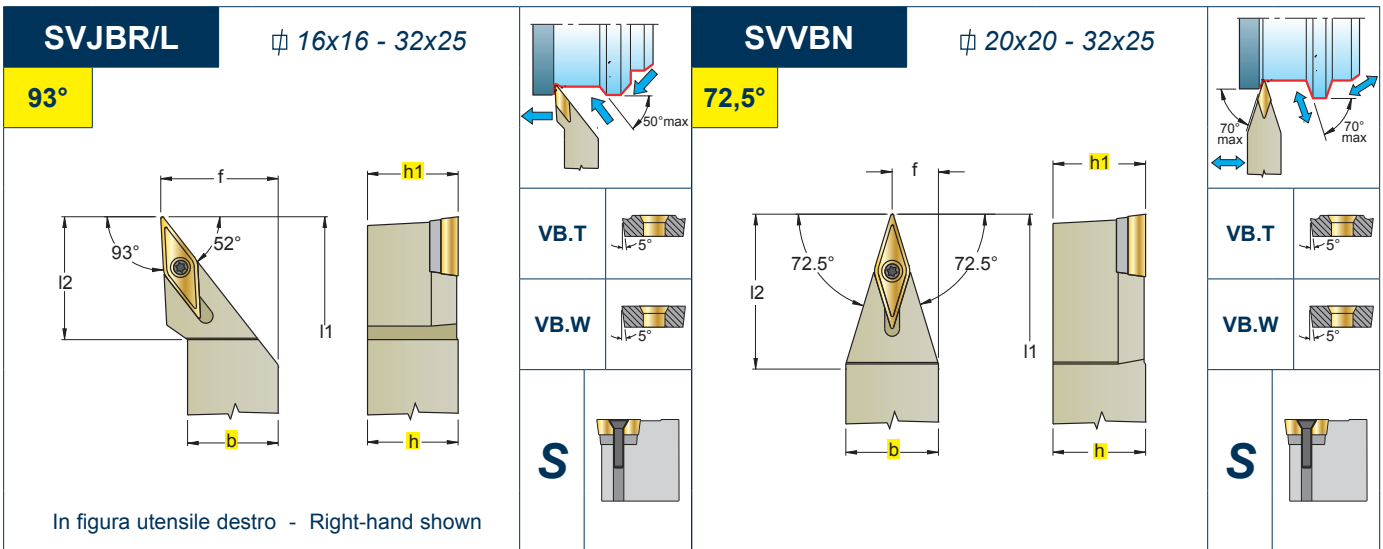

ART.		(mm)							Nm	1604	1	2	3	4	
R	L	h=h1	b	f	l1	l2									
SVJBR/L	1616 H 16	16	16	20	100	30	3,0+3,5								
SVJBR/L	2020 K 16	20	20	25	125	30	3,0+3,5								
SVJBR/L	2525 M 16	25	25	32	150	33	3,0+3,5								
SVJBR/L	3225 P 16	32	25	32	170	33	3,0+3,5								

SVVBN	2020 K 16	20	20	10,0	125	34	3,0+3,5	1604	3716	BCL7	123511P	5515P	
SVVBN	2525 M 16	25	25	12,5	150	42	3,0+3,5						
SVVBN	3225 P 16	32	25	12,5	170	42	3,0+3,5						

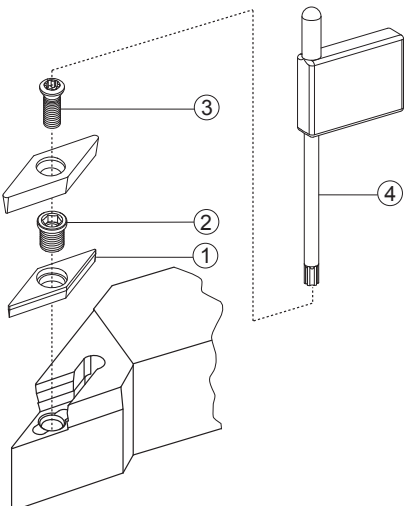

CAMPI D'IMPIEGO DEGLI INSERTI PER TORNITURA
FIELDS OF APPLICATION FOR TURNING INSERTS
EINSATZGEBIETE FÜR DREHPLATTEN
CHAMPS D'USINAGE DES PLAQUETTES POUR TOURNAGE

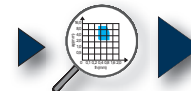

PAG. 226

VELOCITÀ DI TAGLIO Vc
Vc. CUTTING SPEED
Vc. SCHNITTGESCHWINDIGKEIT
Vc. VITESSE DE COUPE



PAG. 222

DETTAGLIO RICAMBI
SPARE PARTS DETAILS
DETAILS ZU DEN ERSATZTEILEN
DÉTAIL DE PIÈCES DE RECHANGE



PAG. 1103

DATI TECNICI E CONSIGLI
TECHNICAL DATA AND SUGGESTIONS
TECHNISCHE DATEN UND EMPFEHLUNGEN
DONNÉES TECHNIQUES ET CONSEILS



PAG. 1126

CKJNR/L

∅ 20x20 - 32x32

93°

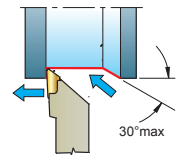
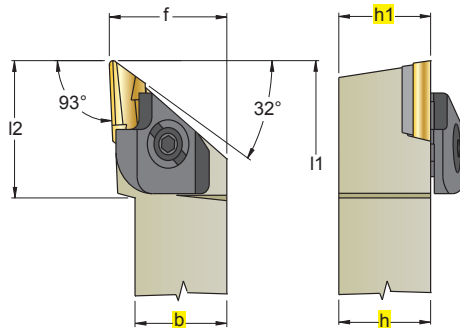

KNUX



C



In figura utensile destro - Right-hand shown

											 INSERTI - INSERTS PAG. 196	
.G69												

ART.		(mm)							①	②	③	④	⑤	⑥	⑦	⊙
R L		h=h1	b	f	l1	l2										
CKJNR	2020 K 16	20	20	30	125	32	1604..-R	2316	3226	4012	1614	4295	4204	5004		
CKJNR	2525 M 16	25	25	32	150	32										
CKJNR	3232 P 16	32	32	40	170	32										
CKJNL	2020 K 16	20	20	30	125	32	1604..-L	2326	3236	4012	1614	4295	4204	5004		
CKJNL	2525 M 16	25	25	32	150	32										
CKJNL	3232 P 16	32	32	40	170	32										

PER UTENSILE R MONTARE INSERTO R , PER UTENSILE L MONTARE INSERTO L
 FOR R TOOL FIT INSERT R, FOR L TOOL FIT INSERT L
 FÜR DAS WERKZEUG R DIE WENDEPLATTE R EINSETZEN; FÜR DAS WERKZEUG L DIE WENDEPLATTE L
 DANS LE CAS DE L'OUTIL R MONTER LA PLAQUETTE R, DANS LE CAS DE L'OUTIL L MONTER LA PLAQUETTE L

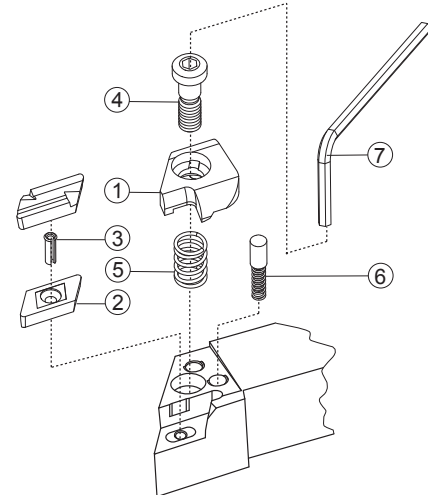

- CAMPI D'IMPIEGO DEGLI INSERTI PER TORNITURA
 - FIELDS OF APPLICATION FOR TURNING INSERTS
 - EINSATZGEBIETE FÜR DREHPLATTEN
 - CHAMPS D'USINAGE DES PLAQUETTES POUR TOURNAGE
-
- VELOCITÀ DI TAGLIO Vc
 - Vc. CUTTING SPEED
 - Vc. SCHNITTGESCHWINDIGKEIT
 - Vc. VITESSE DE COUPE
-
- DETTAGLIO RICAMBI
 - SPARE PARTS DETAILS
 - DETAILS ZU DEN ERSATZTEILEN
 - DÉTAIL DE PIÈCES DE RECHANGE
-
- DATI TECNICI E CONSIGLI
 - TECHNICAL DATA AND SUGGESTIONS
 - TECHNISCHE DATEN UND EMPFEHLUNGEN
 - DONNÉES TECHNIQUES ET CONSEILS

- PAG. 226**
- PAG. 222**
- PAG. 1103**
- PAG. 1126**

PCLNR/L..TTS

∅ 20x20 - 32x32

95°

RANGE DI UTILIZZO
15+80 bar
APPLICATION RANGE
15+80 bar

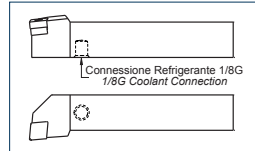
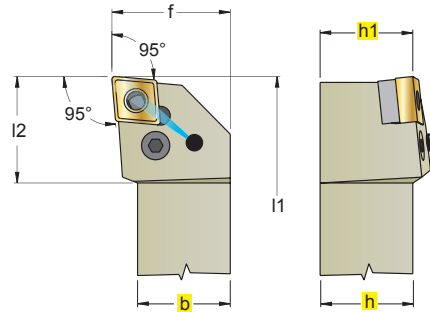

CNMA	
CNMG	
CNMM	
P	

In figura utensile destro - Right-hand shown

																		 INSERTI - INSERTS PAG. 193										
.G23	.G61	.F71	.X47	.G39	.G42	.F51	.G52	.G53	.G55	.G56	.K57P	.F61	.G62	.G63	.G68	.G72	.G34W											
ART.																												
(mm)																												
PCLNR/L 2020 K 12 TTS																	20	20	25	125	28	1204	8012	1608	5003	3612	4112	0012
PCLNR/L 2525 M 12 TTS																	25	25	32	150	33							
PCLNR/L 3225 P 12 TTS																	32	25	32	170	28							
PCLNR/L 3232 P 12 TTS																	32	32	40	170	30							

Accessori per connessione Utensili TTS - Accessories for tool connection - Zubehör zur werkzeugverbindung - Accessoires pour connexion outils TTS

 • Tubo dritto raccordato <i>Fitted hose, straight</i> PAG. 1096	 • Tubo dritto raccordato <i>Fitted hose, straight</i> PAG. 1096	 • Tubo dritto raccordato <i>Fitted hose, straight</i> PAG. 1096	 • Ogiva lubrorefrigerante <i>Cooling lubricant nose cone</i> PAG. 1097
 • Raccordo dritto <i>Straight fitting</i> PAG. 1096	 • Riduzione <i>Adapter</i> PAG. 1096	 • Raccordo 90° <i>90° Fitting</i> PAG. 1097	 • B-SEAL M10 PAG. 1097

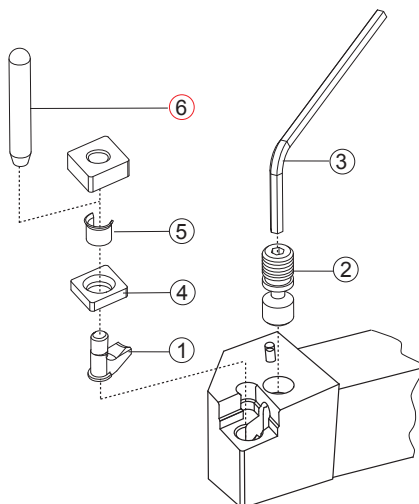

CAMPI D'IMPIEGO DEGLI INSERTI PER TORNITURA
 FIELDS OF APPLICATION FOR TURNING INSERTS
 EINSATZGEBIETE FÜR DREHPLATTEN
 CHAMPS D'USINAGE DES PLAQUETTES POUR TOURNAGE

VELOCITÀ DI TAGLIO Vc
 Vc. CUTTING SPEED
 Vc. SCHNITTGESCHWINDIGKEIT
 Vc. VITESSE DE COUPE

DETTAGLIO RICAMBI
 SPARE PARTS DETAILS
 DETAILS ZU DEN ERSATZTEILEN
 DÉTAIL DE PIÈCES DE RECHANGE

DATI TECNICI E CONSIGLI
 TECHNICAL DATA AND SUGGESTIONS
 TECHNISCHE DATEN UND EMPFEHLUNGEN
 DONNÉES TECHNIQUES ET CONSEILS

PAG. 226

PAG. 222

PAG. 1103

PAG. 1126

PDJNR/L..TTS

∅ 20x20 - 32x32

93°

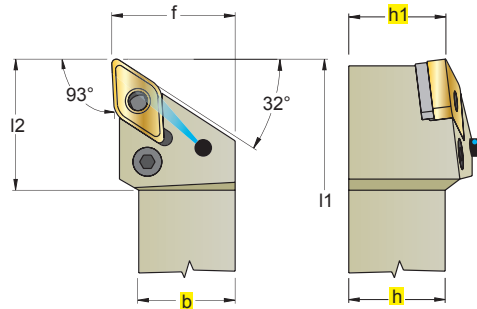

RANGE DI UTILIZZO
15÷80 bar
APPLICATION RANGE
15-80 bar

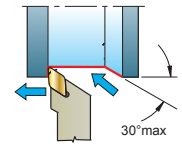

DNMA	
DNMG	
DNMM	

P

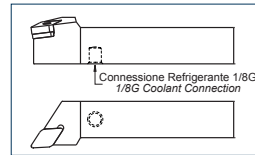

In figura utensile destro - Right-hand shown

			NEW 					NEW 						 INSERTI - INSERTS PAG. 195		
.G23	.G39	.G42	.F51	.G52	.G53	.G55	.G56	.F61	.G62	.G63	.G68	.G72	.G34W			
ART.		(mm)								①	②	③	④	⑤	⑥	
		h=h1	b	f	l1	l2										
PDJNR/L	2020	K	15	TTS	20	20	25	125	35	1506	8415	1638	5003	3715	4112	0012
PDJNR/L	2525	M	15	TTS	25	25	32	150	35							
PDJNR/L	3225	P	15	TTS	32	25	32	170	35							
PDJNR/L	3232	P	15	TTS	32	32	40	170	36							

Accessori per connessione Utensili TTS - Accessories for tool connection - Zubehör zur werkzeugverbindung - Accessoires pour connexion outils TTS

 • Tubo dritto raccordato Fitted hose, straight 150mm PAG. 1096	 • Tubo dritto raccordato Fitted hose, straight 225mm PAG. 1096	 • Tubo dritto raccordato Fitted hose, straight 300mm PAG. 1096	 • Ogiva lubrorefrigerante Cooling lubricant nose cone PAG. 1097
 • Raccordo dritto Straight fitting PAG. 1096	 • Riduzione Adapter PAG. 1096	 • Raccordo 90° 90° Fitting PAG. 1097	 • B-SEAL M10 PAG. 1097

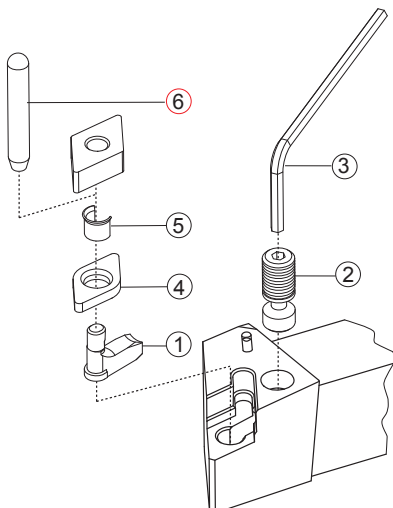

CAMPI D'IMPIEGO DEGLI INSERTI PER TORNITURA
 FIELDS OF APPLICATION FOR TURNING INSERTS
 EINSATZGEBIETE FÜR DREHPLATTEN
 CHAMPS D'USINAGE DES PLAQUETTES POUR TOURNAGE

VELOCITÀ DI TAGLIO Vc
 Vc. CUTTING SPEED
 Vc. SCHNITTGESCHWINDIGKEIT
 Vc. VITESSE DE COUPE

DETTAGLIO RICAMBI
 SPARE PARTS DETAILS
 DETAILS ZU DEN ERSATZTEILEN
 DÉTAIL DE PIÈCES DE RECHANGE

DATI TECNICI E CONSIGLI
 TECHNICAL DATA AND SUGGESTIONS
 TECHNISCHE DATEN UND EMPFEHLUNGEN
 DONNÉES TECHNIQUES ET CONSEILS

PAG. 226

PAG. 222

PAG. 1103

PAG. 1126

SCLCR/L..TTS

∅ 20x20 - 25x25

95°

RANGE DI UTILIZZO
15+80 bar
APPLICATION RANGE
15+80 bar

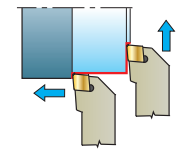
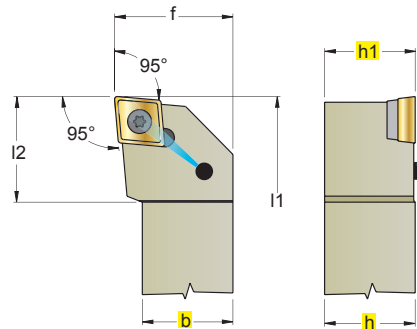

CC.T



CC.W



S

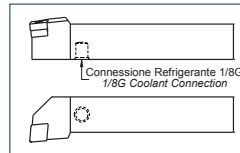

In figura utensile destro - Right-hand shown



NEW

INSERTI - INSERTS
PAG. 201

ART.		(mm)							Nm	1	2	3	4	5
R	L	h=h1	b	f	l1	l2								
SCLCR/L	2020 K 12 TTS	20	20	25	125	20	4,0+5,0	1204	3611	BCL15	124513P	5520P		
SCLCR/L	2525 M 12 TTS	25	25	32	150	20	4,0+5,0							

- PER UTENSILE R MONTARE INSERTO CCET..R.B22, PER UTENSILE L MONTARE INSERTO CCET..L.B22
- FOR R TOOL FIT INSERT CCET..R.B22, FOR L TOOL FIT INSERT CCET..L.B22
- FÜR DAS WERKZEUG R DIE WENDEPLATTE CCET..R.B22 EINSETZEN; FÜR DAS WERKZEUG L DIE WENDEPLATTE CCET..L.B22...
- DANS LE CAS DE L'OUTIL R MONTER LA PLAQUETTE CCET..R.B22, DANS LE CAS DE L'OUTIL L MONTER LA PLAQUETTE CCET..L.B22

Accessori per connessione Utensili TTS - Accessories for tool connection - Zubehör zur werkzeugverbindung - Accessoires pour connexion outils TTS

<p>• Tubo dritto raccordato Fitted hose, straight</p> <p>PAG. 1096</p>	<p>• Tubo dritto raccordato Fitted hose, straight</p> <p>PAG. 1096</p>	<p>• Tubo dritto raccordato Fitted hose, straight</p> <p>PAG. 1096</p>	<p>• Ogiva lubrorefrigerante Cooling lubricant nose cone</p> <p>PAG. 1097</p>
<p>• Raccordo dritto Straight fitting</p> <p>PAG. 1096</p>	<p>• Riduzione Adapter</p> <p>PAG. 1096</p>	<p>• Raccordo 90° 90° Fitting</p> <p>PAG. 1097</p>	<p>• B-SEAL M10</p> <p>PAG. 1097</p>

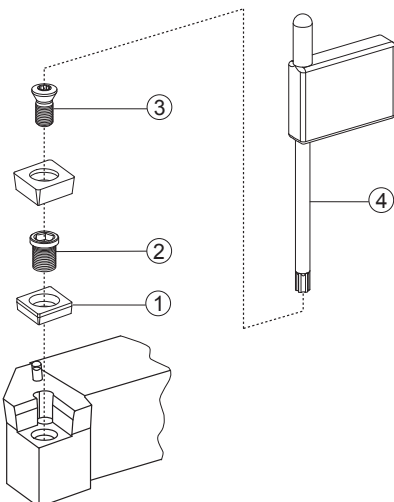

CAMPI D'IMPIEGO DEGLI INSERTI PER TORNITURA
FIELDS OF APPLICATION FOR TURNING INSERTS
EINSATZGEBIETE FÜR DREHPLATTEN
CHAMPS D'USINAGE DES PLAQUETTES POUR TOURNAGE

VELOCITÀ DI TAGLIO Vc
Vc. CUTTING SPEED
Vc. SCHNITTGESCHWINDIGKEIT
Vc. VITESSE DE COUPE

DETTAGLIO RICAMBI
SPARE PARTS DETAILS
DETAILS ZU DEN ERSATZTEILEN
DÉTAIL DE PIÉCES DE RECHANGE

DATI TECNICI E CONSIGLI
TECHNICAL DATA AND SUGGESTIONS
TECHNISCHE DATEN UND EMPFEHLUNGEN
DONNÉES TECHNIQUES ET CONSEILS

PAG. 226

PAG. 222

PAG. 1103

PAG. 1126

SDJCR/L..TTS

∅ 20x20 - 25x25

93°

RANGE DI UTILIZZO
15+80 bar
APPLICATION RANGE
15-80 bar

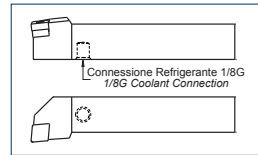
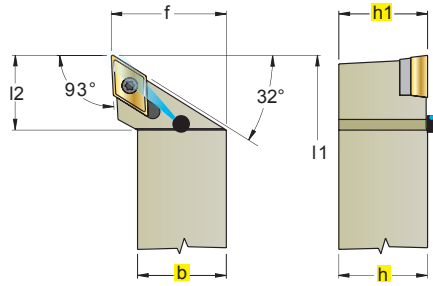
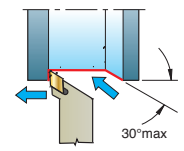

DC.T

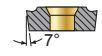

DC.W



S



In figura utensile destro - Right-hand shown

															 INSERTI - INSERTS PAG. 203		
.G13	L.F45	R.F45	.F46	.F47	.B53	.G57P	.X47	.F32	.F33	.G39	.G42	.F51	.G52	.G32W			
ART.		(mm)											①	②	③	④	○
		h=h1	b	f	l1	l2	Nm										
SDJCR/L	2020 K 11 TTS	20	20	25	125	23	3,0+3,5	11T3	3711	BCL7	123511P	5515P					
SDJCR/L	2525 M 11 TTS	25	25	32	150	27	3,0+3,5										

Accessori per connessione Utensili TTS - Accessories for tool connection - Zubehör zur werkzeugverbindung - Accessoires pour connexion outils TTS

 • Tubo dritto raccordato Fitted hose, straight 150mm PAG. 1096	 • Tubo dritto raccordato Fitted hose, straight 225mm PAG. 1096	 • Tubo dritto raccordato Fitted hose, straight 300mm PAG. 1096	 • Ogiva lubrorefrigerante Cooling lubricant nose cone PAG. 1097
 • Raccordo dritto Straight fitting PAG. 1096	 • Riduzione Adapter PAG. 1096	 • Raccordo 90° 90° Fitting PAG. 1097	 • B-SEAL M10 PAG. 1097

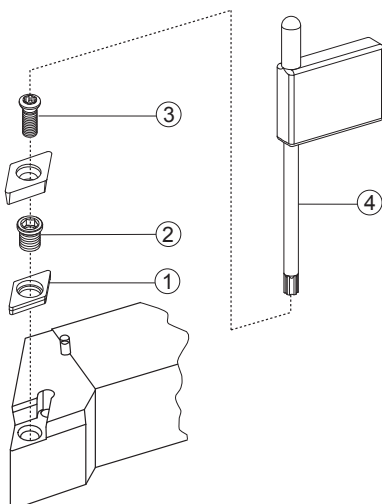

CAMPI D'IMPIEGO DEGLI INSERTI PER TORNITURA
 FIELDS OF APPLICATION FOR TURNING INSERTS
 EINSATZGEBIETE FÜR DREHPLATTEN
 CHAMPS D'USINAGE DES PLAQUETTES POUR Tournage

VELOCITÀ DI TAGLIO Vc
 Vc. CUTTING SPEED
 Vc. SCHNITTGESCHWINDIGKEIT
 Vc. VITESSE DE COUPE

DETTAGLIO RICAMBI
 SPARE PARTS DETAILS
 DETAILS ZU DEN ERSATZTEILEN
 DÉTAIL DE PIÈCES DE RECHANGE

DATI TECNICI E CONSIGLI
 TECHNICAL DATA AND SUGGESTIONS
 TECHNISCHE DATEN UND EMPFEHLUNGEN
 DONNÉES TECHNIQUES ET CONSEILS

PAG. 226

PAG. 222

PAG. 1103

PAG. 1126

FM PTGNR/L

∅ 16x16

90°

NEW

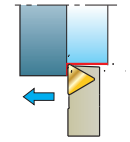
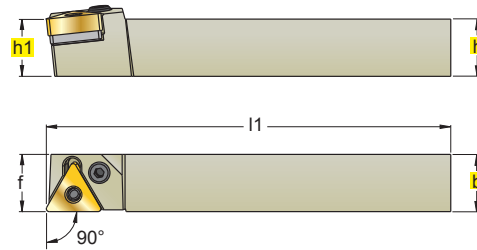

TNMA



TNMG



TNMM



P



In figura utensile destro - Right-hand shown

										INSERTI - INSERTS PAG. 197					
										1	2	3	4	5	6
ART. (mm)										Nm					
h=h1 b f l1															
.G61	.G71	.F32	.F51	.G52	.G53	.G55	.G56	.G62	.G63						
FM PTGNR/L 1616 K 16										8009	1606	5025	3416	4109	0009

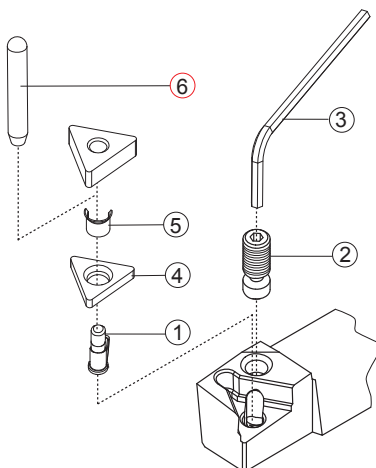

CAMPI D'IMPIEGO DEGLI INSERTI PER TORNITURA
 FIELDS OF APPLICATION FOR TURNING INSERTS
 EINSATZGEBIETE FÜR DREHPLATTEN
 CHAMPS D'USINAGE DES PLAQUETTES POUR TOURNAGE

PAG. 226

VELOCITÀ DI TAGLIO Vc
 Vc. CUTTING SPEED
 Vc. SCHNITTGESCHWINDIGKEIT
 Vc. VITESSE DE COUPE

Vc **PAG. 222**

DETTAGLIO RICAMBI
 SPARE PARTS DETAILS
 DETAILS ZU DEN ERSATZTEILEN
 DÉTAIL DE PIÈCES DE RECHANGE

PAG. 1103

DATI TECNICI E CONSIGLI
 TECHNICAL DATA AND SUGGESTIONS
 TECHNISCHE DATEN UND EMPFEHLUNGEN
 DONNÉES TECHNIQUES ET CONSEILS

PAG. 1126

FM SCLCR/L

Ø 10x10 - 16x16

95° NEW

In figura utensile destro - Right-hand shown

FM SCACR/L

Ø 10x10 - 16x16

100° NEW

In figura utensile destro - Right-hand shown

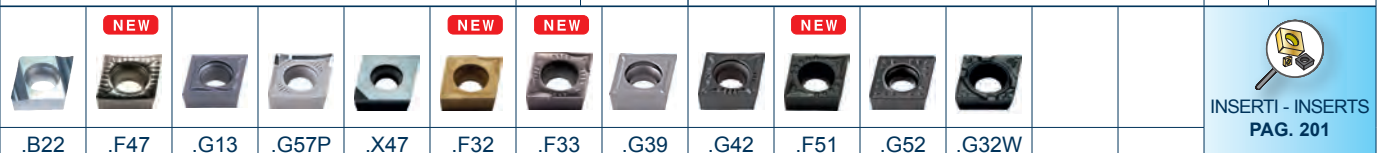

ART.	(mm)				Nm	0602	1	2
	h=h1	b	f	l1				
FM SCLCR/L 1010 K 06	10	10	10	125	1,1+1,3	0602	12256P	5508P
FM SCLCR/L 1212 K 06	12	12	12	125	1,1+1,3			
FM SCLCR/L 1616 K 06	16	16	16	125	1,1+1,3			
FM SCLCR/L 1212 K 09	12	12	12	125	3,8+5,0	09T3	12409P	5515P
FM SCLCR/L 1616 K 09	16	16	16	125	3,8+5,0			

- PER UTENSILE R MONTARE INSERTO CCET..R.B22 , PER UTENSILE L MONTARE INSERTO CCET..L.B22
 - FOR R TOOL FIT INSERT CCET..R.B22, FOR L TOOL FIT INSERT CCET..L.B22
 - FÜR DAS WERKZEUG R DIE WENDEPLATTE CCET..R.B22 EINSETZEN; FÜR DAS WERKZEUG L DIE WENDEPLATTE CCET..L.B22...
 - DANS LE CAS DE L'OUTIL R MONTER LA PLAQUETTE CCET..R.B22, DANS LE CAS DE L'OUTIL L MONTER LA PLAQUETTE CCET..L.B22

FM SCACR/L 1010 K 06	10	10	10	125	1,1+1,3	0602	12256P	5508P
FM SCACR/L 1212 K 06	12	12	12	125	1,1+1,3			
FM SCACR/L 1212 K 09	12	12	12	125	3,8+5,0	09T3	12409P	5515P
FM SCACR/L 1616 K 09	16	16	16	125	3,8+5,0			

- PER UTENSILE R MONTARE INSERTO CCET..R.B22 , PER UTENSILE L MONTARE INSERTO CCET..L.B22
 - FOR R TOOL FIT INSERT CCET..R.B22, FOR L TOOL FIT INSERT CCET..L.B22
 - FÜR DAS WERKZEUG R DIE WENDEPLATTE CCET..R.B22 EINSETZEN; FÜR DAS WERKZEUG L DIE WENDEPLATTE CCET..L.B22...
 - DANS LE CAS DE L'OUTIL R MONTER LA PLAQUETTE CCET..R.B22, DANS LE CAS DE L'OUTIL L MONTER LA PLAQUETTE CCET..L.B22

- CAMPI D'IMPIEGO DEGLI INSERTI PER TORNATURA**
 FIELDS OF APPLICATION FOR TURNING INSERTS
 EINSATZGEBIETE FÜR DREHPLATTEN
 CHAMPS D'USINAGE DES PLAQUETTES POUR TOURNAGE
- VELOCITÀ DI TAGLIO Vc**
 Vc. CUTTING SPEED
 Vc. SCHNITTGESCHWINDIGKEIT
 Vc. VITESSE DE COUPE
- DETTAGLIO RICAMBI**
 SPARE PARTS DETAILS
 DETAILS ZU DEN ERSATZTEILEN
 DÉTAIL DE PIÈCES DE RECHANGE
- DATI TECNICI E CONSIGLI**
 TECHNICAL DATA AND SUGGESTIONS
 TECHNISCHE DATEN UND EMPFEHLUNGEN
 DONNÉES TECHNIQUES ET CONSEILS

PAG. 226

PAG. 222

PAG. 1103

PAG. 1126

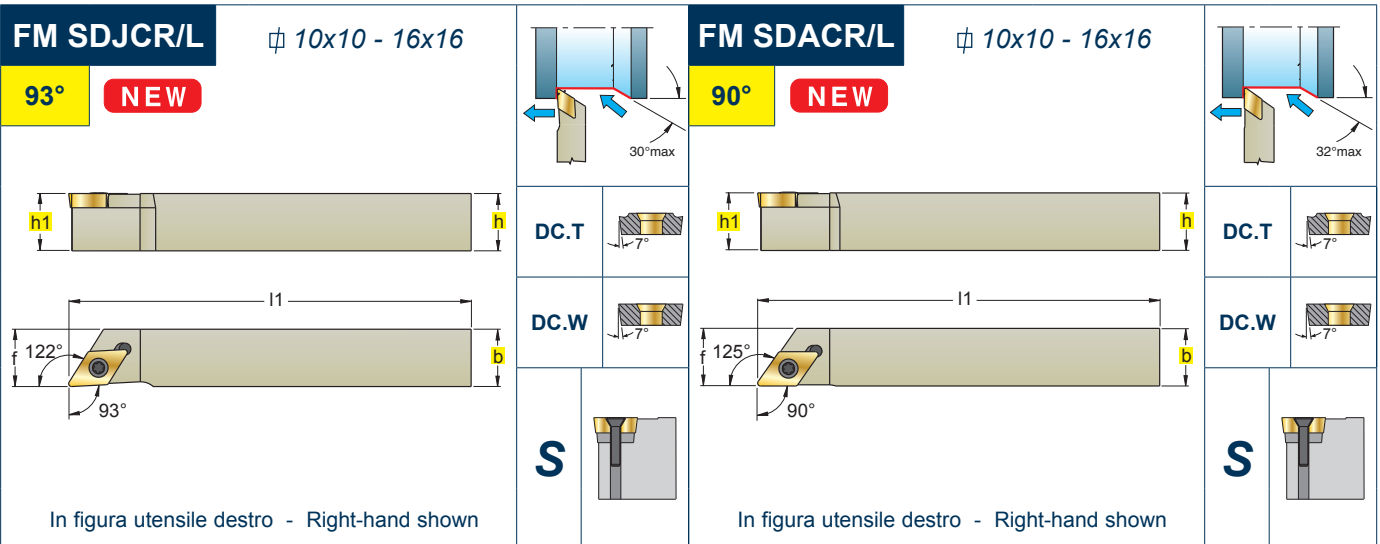

ART.	(mm)				Nm	0702	1		2		12256P	5508P
	h=h1	b	f	l1			1	2				
FM SDJCR/L 1010 K 07	10	10	10	125	1,1+1,3	0702	12256P	5508P				
FM SDJCR/L 1212 K 07	12	12	12	125	1,1+1,3							
FM SDJCR/L 1616 K 07	16	16	16	125	1,1+1,3							
FM SDJCR/L 1212 K 11	12	12	12	125	3,8+5,0	11T3	12409P	5515P				
FM SDJCR/L 1616 K 11	16	16	16	125	3,8+5,0							

FM SDACR/L 1010 K 07	10	10	10	125	1,1+1,3	0702	12256P	5508P				
FM SDACR/L 1212 K 07	12	12	12	125	1,1+1,3							
FM SDACR/L 1212 K 11	12	12	12	125	3,8+5,0	11T3	12409P	5515P				
FM SDACR/L 1616 K 11	16	16	16	125	3,8+5,0							

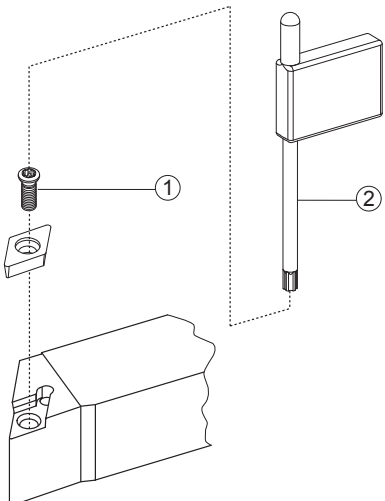

CAMPI D'IMPIEGO DEGLI INSERTI PER TORNITURA
 FIELDS OF APPLICATION FOR TURNING INSERTS
 EINSATZGEBIETE FÜR DREHPLATTEN
 CHAMPS D'USINAGE DES PLAQUETTES POUR TOURNAGE

VELOCITÀ DI TAGLIO Vc
 Vc. CUTTING SPEED
 Vc. SCHNITTGESCHWINDIGKEIT
 Vc. VITESSE DE COUPE

DETTAGLIO RICAMBI
 SPARE PARTS DETAILS
 DETAILS ZU DEN ERSATZTEILEN
 DÉTAIL DE PIÈCES DE RECHANGE

DATI TECNICI E CONSIGLI
 TECHNICAL DATA AND SUGGESTIONS
 TECHNISCHE DATEN UND EMPFEHLUNGEN
 DONNÉES TECHNIQUES ET CONSEILS



<p>FM SVJCR/L \varnothing 10x10 - 16x16</p> <p>93° NEW</p> <p>VC.T </p> <p>VC.W </p> <p>S </p> <p>In figura utensile destro - Right-hand shown</p>	<p>FM SVACR/L \varnothing 10x10 - 16x16</p> <p>90° NEW</p> <p>VC.T </p> <p>VC.W </p> <p>S </p> <p>In figura utensile destro - Right-hand shown</p>
---	---



ART.	(mm)				Nm		①		②	
		h=h1	b	f			l1			
FM SVJCR/L 1010 K 11		10	10	10	125	1,1+1,3	1103	12256P	5508P	
FM SVJCR/L 1212 K 11		12	12	12	125	1,1+1,3				
FM SVJCR/L 1616 K 11		16	16	16	125	1,1+1,3				
FM SVJCR/L 1212 K 16		12	12	12	125	3,0+3,5	1604	123509P	5515P	
FM SVJCR/L 1616 K 16		16	16	16	125	3,0+3,5				
FM SVACR/L 1010 K 11		10	10	10	125	1,1+1,3	1103	12256P	5508P	
FM SVACR/L 1212 K 11		12	12	12	125	1,1+1,3				
FM SVACR/L 1616 K 11		16	16	16	125	1,1+1,3				
FM SVACR/L 1212 K 16		12	12	12	125	3,0+3,5	1604	123509P	5515P	
FM SVACR/L 1616 K 16		16	16	16	125	3,0+3,5				

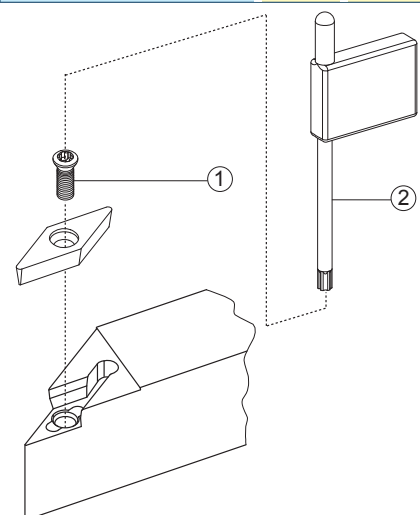

CAMPI D'IMPIEGO DEGLI INSERTI PER TORNATURA
 FIELDS OF APPLICATION FOR TURNING INSERTS
 EINSATZGEBIETE FÜR DREHPLATTEN
 CHAMPS D'USINAGE DES PLAQUETTES POUR TOURNAGE

VELOCITÀ DI TAGLIO Vc
 Vc. CUTTING SPEED
 Vc. SCHNITTGESCHWINDIGKEIT
 Vc. VITESSE DE COUPE

DETTAGLIO RICAMBI
 SPARE PARTS DETAILS
 DETAILS ZU DEN ERSATZTEILEN
 DÉTAIL DE PIÈCES DE RECHANGE

DATI TECNICI E CONSIGLI
 TECHNICAL DATA AND SUGGESTIONS
 TECHNISCHE DATEN UND EMPFEHLUNGEN
 DONNÉES TECHNIQUES ET CONSEILS

PAG. 226

Vc **PAG. 222**

PAG. 1103

PAG. 1126

D 	P 	M 	M 	S 
A..DCLNR/L Pag.102	A..PCLNR/L Pag.104	A..MTFNR/L Pag.109	A..MCLNR/L Pag.111	A..SWUCR/L Pag.115
				
$\text{ØDmin } 32,0$	$\text{ØDmin } 25,0$	$\text{ØDmin } 32,0$	$\text{ØDmin } 32,0$	$\text{ØDmin } 5,8$
 CNM. 1204.. 1606..	 CNM. 0903../1204.. 1606../1906..	 TNM. 1604.. 2204..	 CNM. 1204.. 1606.. 1906..	 WC.. 0201..
A..DDUNR/L Pag.103	A..PDUNR/L Pag.105	A..MWLNR/L Pag.110	A..MDUNR/L Pag.112	E..SWUCR/L..N Pag.115
				
$\text{ØDmin } 40,0$	$\text{ØDmin } 27,0$	$\text{ØDmin } 25,0$	$\text{ØDmin } 32,0$	$\text{ØDmin } 5,8$
 DNM. 1506..	 DNM. 1104.. 1506..	 WNM. 0604.. 0804..	 DNM. 1506..	 WC.. 0201..
	A..PSKNR/L Pag.106		A..MVPNR/L Pag.113	A..SCUPR/L Pag.116
				
	$\text{ØDmin } 32,0$		$\text{ØDmin } 32,0$	$\text{ØDmin } 8,0$
	 SNM. 1204..		 VNM. 1604..	 CP.. 05T1..
	A..PTFNR/L Pag.107		A..MVUNR/L Pag.113	E..SCUPR/L..N Pag.116
				
	$\text{ØDmin } 21,0$		$\text{ØDmin } 32,0$	$\text{ØDmin } 8,0$
	 TNM. 1103.. 1604.. 2204..		 VNM. 1604..	 CP.. 05T1..
	A..PWLNR/L Pag.108		A..MVZNR/L Pag.114	
				
	$\text{ØDmin } 21,0$		$\text{ØDmin } 48,0$	
	 WNM. 0604.. 0804..		 VNM. 1604..	

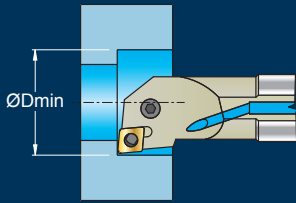

- UTENSILI CON STELO IN METALLO DURO
- TOOLS WITH CARBIDE SHAFT
- WERKZEUGE MIT HM-SCHAFT
- OUTILS AVEC QUEUE EN METAL DUR

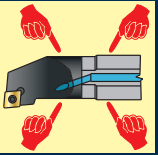

S 	S 	S 	S 	S
A..SCLCR/L Pag.117	A..SDUCR/L Pag.121	A..SDQCR/L Pag.126	A..SVOCR/L Pag.131	A..SSKCR/L Pag.135
$\varnothing D_{min} 8,5$	$\varnothing D_{min} 12,5$	$\varnothing D_{min} 16,0$	$\varnothing D_{min} 16,0$	$\varnothing D_{min} 20,0$
CC.. 0602..	DC.. 0702..	DC.. 0702.. 11T3..	VC.. 1103.. 1604..	SC.. 09T3.. 1204..
S..SCLCR/L Pag.117	S..SDUCR/L Pag.121	E..SDQCR/L..N Pag.126	A..SVUCR/L Pag.132	
$\varnothing D_{min} 8,5$	$\varnothing D_{min} 12,5$	$\varnothing D_{min} 13,0$	$\varnothing D_{min} 21,0$	
CC.. 0602..	DC.. 0702..	DC.. 0702.. 11T3..	VC.. 1103.. 1604..	
A..SCLCR/L Pag.118	A..SDUCR/L Pag.122	A..SDNCR/L Pag.127	E..SVUCR/L..N Pag.132	
$\varnothing D_{min} 10,0$	$\varnothing D_{min} 13,0$	$\varnothing D_{min} 20,0$	$\varnothing D_{min} 21,0$	
CC.. 0602.. 09T3.. 1204..	DC.. 0702.. 11T3..	DC.. 0702.. 11T3..	VC.. 1103..	
E..SCLCR/L..N Pag.119	E..SDUCR/L..N Pag.123	A..SDXCR/L Pag.128	A..SVXCR/L Pag.133	
$\varnothing D_{min} 10,0$	$\varnothing D_{min} 12,5$	$\varnothing D_{min} 16,0$	$\varnothing D_{min} 20,0$	
CC.. 0602.. 09T3.. 1204..	DC.. 0702.. 11T3..	DC.. 0702.. 11T3..	VC.. 1103.. 1604..	
B..SCLCR/L Pag.120	B..SDUCR/L Pag.124	A..STUCR/L Pag.129	A..SVQCR/L Pag.133	
$\varnothing D_{min} 09,0$	$\varnothing D_{min} 13,0$	$\varnothing D_{min} 16,0$	$\varnothing D_{min} 20,0$	
CC.. 0602.. 09T3..	DC.. 0702.. 11T3..	TC.. 1102.. 16T3..	VC.. 1103.. 1604..	
	A..SDQCR/L Pag.125	A..STFCR/L Pag.129	A..SVQBR/L Pag.134	
	$\varnothing D_{min} 12,5$	$\varnothing D_{min} 12,0$	$\varnothing D_{min} 32,0$	
	DC.. 0702..	TC.. 0902.. 1102.. 16T3..	VB.. 1604..	
	S..SDQCR/L Pag.125	E..STFCR/L..N Pag.130	A..SVJBR/L Pag.134	
	$\varnothing D_{min} 12,5$	$\varnothing D_{min} 12,0$	$\varnothing D_{min} 32,0$	
	DC.. 0702..	TC.. 0902.. 1102.. 16T3..	VB.. 1604..	

A..DCLNR/L

Ø25 - Ø50

95°

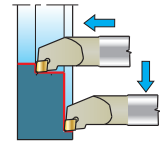
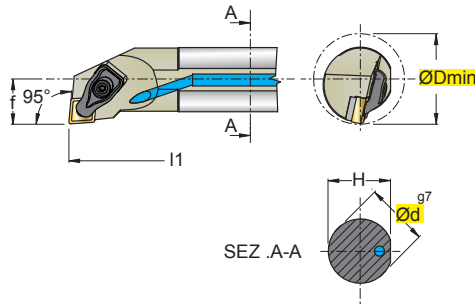

CNMA	
CNMG	
CNMM	

D

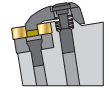

In figura utensile destro - Right-hand shown

																			 INSERTI - INSERTS PAG. 193
.G23	.G61	.F71	.X47	.G39	.G42	.F51	.G52	.G53	.G55	.G56	.K57P	.F61	.G62	.G63	.G68	.G72	.G82	.G34W	
ART.		(mm)																	
		ØDmin	Ød	f	H	L1	Nm	1			2	3	4	5					
A25R	DCLNR/L	12	32	25	17	24	200	3,9	1204	100-21	5415	3612	125009	5420					
A32S	DCLNR/L	12	40	32	22	31	250	3,9	1204	100-21	5415	3612	125011	5420					
A40T	DCLNR/L	12	50	40	27	38	300	3,9											
A50U	DCLNR/L	12	63	50	35	48	350	3,9											
A50U	DCLNR/L	16	63	50	35	48	350	6,4	1606	100-31	5420	3616	126011	5425					

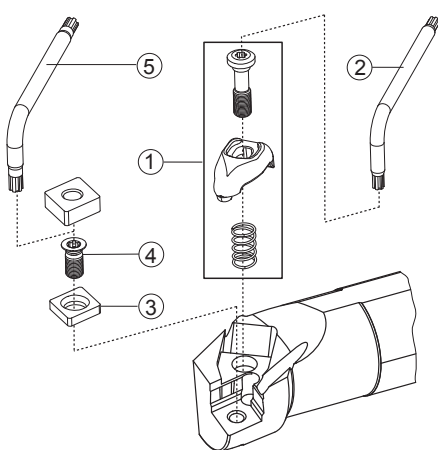

CAMPI D'IMPIEGO DEGLI INSERTI PER TORNITURA
 FIELDS OF APPLICATION FOR TURNING INSERTS
 EINSATZGEBIETE FÜR DREHPLATTEN
 CHAMPS D'USINAGE DES PLAQUETTES POUR TOURNAGE

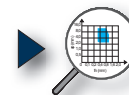

PAG. 226

VELOCITÀ DI TAGLIO Vc
 Vc. CUTTING SPEED
 Vc. SCHNITTGESCHWINDIGKEIT
 Vc. VITESSE DE COUPE



PAG. 222

DETTAGLIO RICAMBI
 SPARE PARTS DETAILS
 DETAILS ZU DEN ERSATZTEILEN
 DÉTAIL DE PIÈCES DE RECHANGE



PAG. 1103

DATI TECNICI E CONSIGLI
 TECHNICAL DATA AND SUGGESTIONS
 TECHNISCHE DATEN UND EMPFEHLUNGEN
 DONNÉES TECHNIQUES ET CONSEILS



PAG. 1126

A..DDUNR/L

Ø32 - Ø50

93°

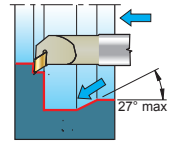
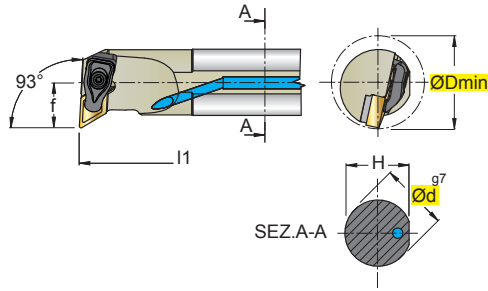

DNMA



DNMG



DNMM



D

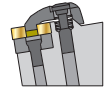

in figura utensile destro - right-hand shown

															NEW																	NEW		INSERTI - INSERTS PAG. 195					
ART.		(mm)									1						2		3		4		5																
		ØDmin	Ød	f	H	l1	Nm			1						2		3		4		5																	
A32S	DDUNR/L	15	40	32	22	31,0	250	3,9	1506	100-21						5415		3715		125011		5420																	
A40T	DDUNR/L	15	50	40	27	38,5	300	3,9																															
A50U	DDUNR/L	15	63	50	35	48,0	350	3,9																															

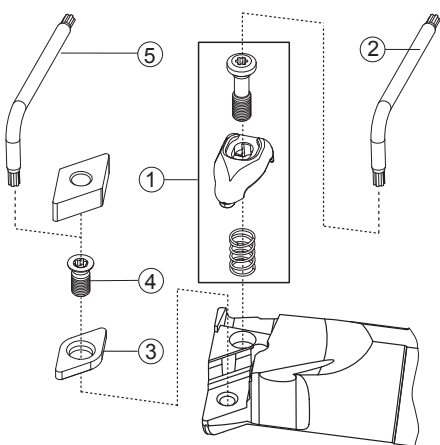

CAMPI D'IMPIEGO DEGLI INSERTI PER TORNITURA
 FIELDS OF APPLICATION FOR TURNING INSERTS
 EINSATZGEBIETE FÜR DREHPLATTEN
 CHAMPS D'USINAGE DES PLAQUETTES POUR TOURNAGE

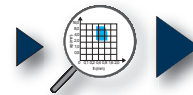

PAG. 226

VELOCITÀ DI TAGLIO Vc
 Vc. CUTTING SPEED
 Vc. SCHNITTGESCHWINDIGKEIT
 Vc. VITESSE DE COUPE



PAG. 222

DETTAGLIO RICAMBI
 SPARE PARTS DETAILS
 DETAILS ZU DEN ERSATZTEILEN
 DÉTAIL DE PIÈCES DE RECHANGE



PAG. 1103

DATI TECNICI E CONSIGLI
 TECHNICAL DATA AND SUGGESTIONS
 TECHNISCHE DATEN UND EMPFEHLUNGEN
 DONNÉES TECHNIQUES ET CONSEILS



PAG. 1126

A..PCLNR/L

Ø20 - Ø50

95°

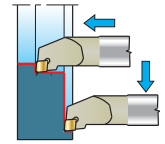
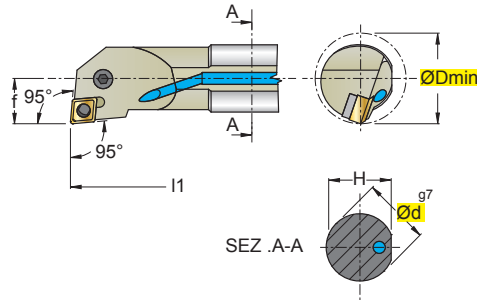

CNMA	
CNMG	
CNMM	

P



in figura utensile destro - right-hand shown

NEW																	INSERTI - INSERTS PAG. 193	
.G23	.G61	.F71	.X47	.G39	.G42	.F51	.G52	.G53	.G55	.G56	.K57P	.F61	.G62	.G63	.G68	.G72		.G82
ART. (mm)									1	2	3	4	5	6				
ØDmin	Ød	f	H	l1														
A20Q	PCLNR/L	09	25	20	13	19,0	180	0903	8010	1603	5002	-	-	-				
A25R	PCLNR/L	09	32	25	17	24,0	200	0903	8410	1604	5025	3610	4108	0009				
A25R	PCLNR/L	12	32	25	17	24,0	200	1204	8012	1648	5003	3612	4112	0012				
A32S	PCLNR/L	12	40	32	22	31,0	250	1204	8012	1608	5003	3612	4112	0012				
A40T	PCLNR/L	12	50	40	27	38,5	300	1606	8016	1618	5003	3616	4115	0015				
A50U	PCLNR/L	12	63	50	35	48,0	350											
A40T	PCLNR/L	16	50	40	27	38,5	300											
A50U	PCLNR/L	16	63	50	35	48,0	350	1906	8019	1610	5004	3619	4119	0019				
A50U	PCLNR/L	19	63	50	35	48,0	350											

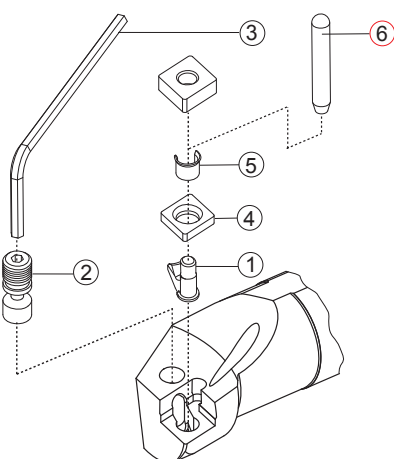

CAMPI D'IMPIEGO DEGLI INSERTI PER TORNITURA
 FIELDS OF APPLICATION FOR TURNING INSERTS
 EINSATZGEBIETE FÜR DREHPLATTEN
 CHAMPS D'USINAGE DES PLAQUETTES POUR TOURNAGE

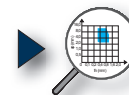

PAG. 226

VELOCITÀ DI TAGLIO Vc
 Vc. CUTTING SPEED
 Vc. SCHNITTGESCHWINDIGKEIT
 Vc. VITESSE DE COUPE



PAG. 222

DETTAGLIO RICAMBI
 SPARE PARTS DETAILS
 DETAILS ZU DEN ERSATZTEILEN
 DÉTAIL DE PIÈCES DE RECHANGE



PAG. 1103

DATI TECNICI E CONSIGLI
 TECHNICAL DATA AND SUGGESTIONS
 TECHNISCHE DATEN UND EMPFEHLUNGEN
 DONNÉES TECHNIQUES ET CONSEILS



PAG. 1126

A..PDUNR/L

Ø20 - Ø50

93°

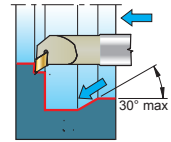
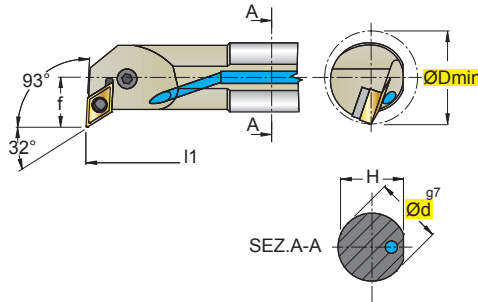

DNMA	
DNMG	
DNMM	

P



In figura utensile destro - Right-hand shown

			NEW 					NEW 								 INSERTI - INSERTS PAG. 195
.G23	.G39	.G42	.F51	.G52	.G53	.G55	.G56	.F61	.G62	.G63	.G68	.G72	.G34W			
ART.		(mm)							①	②	③	④	⑤	⑥		
		ØDmin	Ød	f	H	L1										
A20Q	PDUNR/L	11	27	20	16	18,0	180	1104	8410	1604	5025	—	—	—		
A25R	PDUNR/L	11	32	25	17	23,0	200	1104	8411	1606	5025	3710	4108	0009		
A32S	PDUNR/L	11	40	32	22	31,0	250									
A32S	PDUNR/L	15	40	32	22	31,0	250	1506	8415	1638	5003	3715	4112	0012		
A40T	PDUNR/L	15	50	40	27	38,5	300									
A50U	PDUNR/L	15	63	50	35	48,0	350									

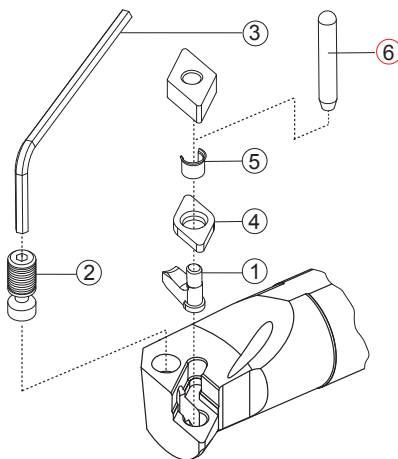

- CAMPI D'IMPIEGO DEGLI INSERTI PER TORNITURA
- FIELDS OF APPLICATION FOR TURNING INSERTS
- EINSATZGEBIETE FÜR DREHPLATTEN
- CHAMPS D'USINAGE DES PLAQUETTES POUR TOURNAGE

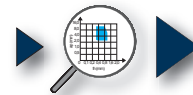

PAG. 226

- VELOCITÀ DI TAGLIO Vc
- Vc. CUTTING SPEED
- Vc. SCHNITTGESCHWINDIGKEIT
- Vc. VITESSE DE COUPE



PAG. 222

- DETTAGLIO RICAMBI
- SPARE PARTS DETAILS
- DETAILS ZU DEN ERSATZTEILEN
- DÉTAIL DE PIÈCES DE RECHANGE



PAG. 1103

- DATI TECNICI E CONSIGLI
- TECHNICAL DATA AND SUGGESTIONS
- TECHNISCHE DATEN UND EMPFEHLUNGEN
- DONNÉES TECHNIQUES ET CONSEILS



PAG. 1126

A..PSKNR/L

Ø25 - Ø40

75°

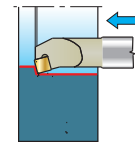
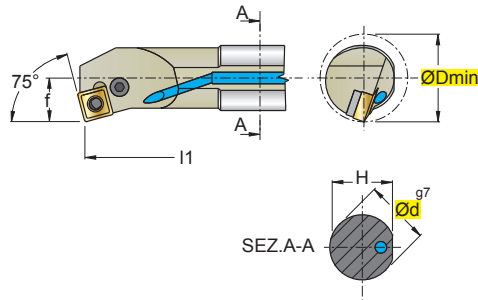

SNMA	
SNMG	
SNMM	

P



In figura utensile destro - Right-hand shown

														 INSERTI - INSERTS PAG. 196		
ART. (mm)																
			ØDmin	Ød	f	H	l1									
A25R	PSKNR/L	12	32	25	17	24,0	200		1204	8012	1648	5003	3512	4112	0012	
A32S	PSKNR/L	12	40	32	22	31,0	250									
A40T	PSKNR/L	12	50	40	27	38,5	300		1204	8012	1608	5003	3512	4112	0012	

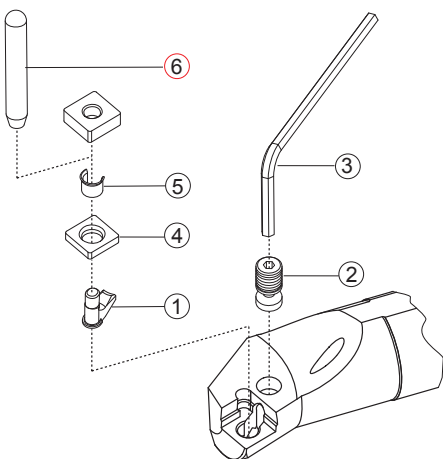

CAMPI D'IMPIEGO DEGLI INSERTI PER TORNITURA
 FIELDS OF APPLICATION FOR TURNING INSERTS
 EINSATZGEBIETE FÜR DREHPLATTEN
 CHAMPS D'USINAGE DES PLAQUETTES POUR TOURNAGE

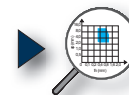

PAG. 226

VELOCITÀ DI TAGLIO Vc
 Vc. CUTTING SPEED
 Vc. SCHNITTGESCHWINDIGKEIT
 Vc. VITESSE DE COUPE



PAG. 222

DETTAGLIO RICAMBI
 SPARE PARTS DETAILS
 DETAILS ZU DEN ERSATZTEILEN
 DÉTAIL DE PIÈCES DE RECHANGE



PAG. 1103

DATI TECNICI E CONSIGLI
 TECHNICAL DATA AND SUGGESTIONS
 TECHNISCHE DATEN UND EMPFEHLUNGEN
 DONNÉES TECHNIQUES ET CONSEILS



PAG. 1126

A..PTFNR/L

Ø16 - Ø40

90°

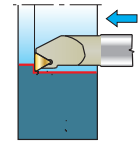
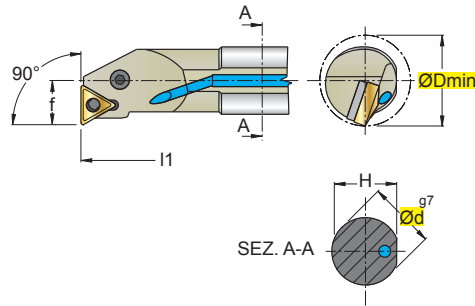

TNMA	
TNMG	
TNMM	

P



In figura utensile destro - Right-hand shown

																					INSERTI - INSERTS PAG. 197	
.G61	.G71	.F32	.F51	.G52	.G53	.G55	.G56	.G62	.G63													
ART.		(mm)								1	2	3	4	5	6							
		ØDmin	Ød	f	H	I1																
A16M	PTFNR/L 11	21	16	11	15,25	150		1103	8008	1603	5002	-	-	-								
A20Q	PTFNR/L 11	25	20	13	19,0	180		1604	8009	1606	5025	3416	4109	0009								
A25R	PTFNR/L 16	32	25	17	24,0	200		1604	8009	1606	5025	3416	4109	0009								
A32S	PTFNR/L 16	40	32	22	31,0	250		2204	8012	1608	5003	3422	4112	0012								
A32S	PTFNR/L 22	40	32	22	31,0	250		2204	8012	1608	5003	3422	4112	0012								
A40T	PTFNR/L 22	50	40	27	38,5	300		2204	8012	1608	5003	3422	4112	0012								

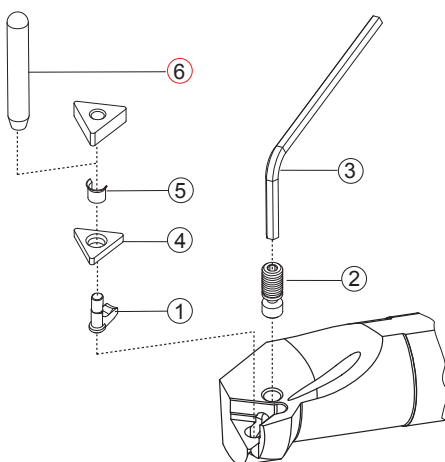

CAMPI D'IMPIEGO DEGLI INSERTI PER TORNITURA
 FIELDS OF APPLICATION FOR TURNING INSERTS
 EINSATZGEBIETE FÜR DREHPLATTEN
 CHAMPS D'USINAGE DES PLAQUETTES POUR TOURNAGE

VELOCITÀ DI TAGLIO Vc
 Vc. CUTTING SPEED
 Vc. SCHNITTGESCHWINDIGKEIT
 Vc. VITESSE DE COUPE

DETTAGLIO RICAMBI
 SPARE PARTS DETAILS
 DETAILS ZU DEN ERSATZTEILEN
 DÉTAIL DE PIÈCES DE RECHANGE

DATI TECNICI E CONSIGLI
 TECHNICAL DATA AND SUGGESTIONS
 TECHNISCHE DATEN UND EMPFEHLUNGEN
 DONNÉES TECHNIQUES ET CONSEILS

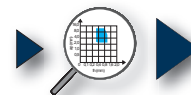

PAG. 226



PAG. 222



PAG. 1103



PAG. 1126

A..PWLNR/L

Ø16 - Ø40

95°

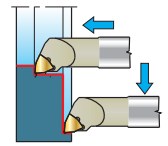
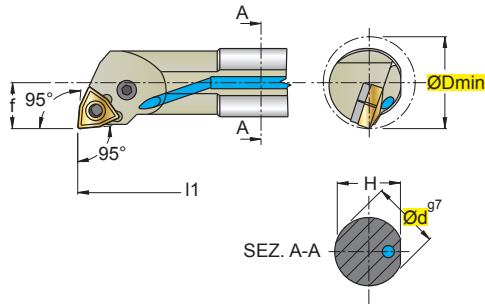

WNMA	
WNMG	
WNMM	

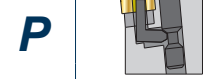

In figura utensile destro - Right-hand shown

		NEW		NEW						NEW				 INSERTI - INSERTS PAG. 199		
.G23	.G61	.F71	.G42	.F51	.G52	.G53	.G55	.G56	.K57P	.F61	.G62	.G63	.G34W			
ART. (mm)											①	②	③	④	⑤	⑥
			ØDmin	Ød	f	H	l1									
A16M	PWLNR/L	06	21	16	11	15,25	150	0604	8216	1605	5002	-	-	-	-	
A20Q	PWLNR/L	06	25	20	13	19,0	180	0604	8009	1606	5025	3306	4109	0009		
A25R	PWLNR/L	06	32	25	17	24,0	200		8012	1608	5003	3308M	4112	0012		
A32S	PWLNR/L	06	40	32	22	31,0	250	0804	8012	1608	5003	3308M	4112	0012		
A25R	PWLNR/L	08	32	25	17	24,0	200		8012	1608	5003	3308M	4112	0012		
A32S	PWLNR/L	08	40	32	22	31,0	250	0804	8012	1608	5003	3308M	4112	0012		
A40T	PWLNR/L	08	50	40	27	38,5	300									

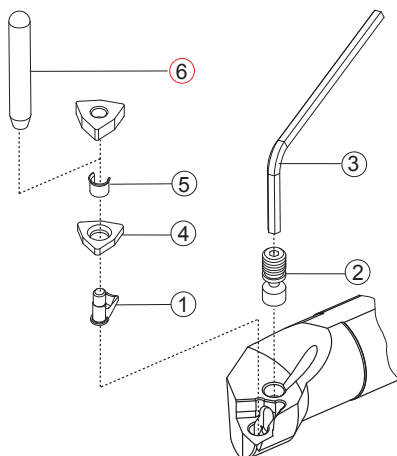

CAMPI D'IMPIEGO DEGLI INSERTI PER TORNITURA
 FIELDS OF APPLICATION FOR TURNING INSERTS
 EINSATZGEBIETE FÜR DREHPLATTEN
 CHAMPS D'USINAGE DES PLAQUETTES POUR TOURNAGE



VELOCITÀ DI TAGLIO Vc
 Vc. CUTTING SPEED
 Vc. SCHNITTGESCHWINDIGKEIT
 Vc. VITESSE DE COUPE



DETTAGLIO RICAMBI
 SPARE PARTS DETAILS
 DETAILS ZU DEN ERSATZTEILEN
 DÉTAIL DE PIÈCES DE RECHANGE



DATI TECNICI E CONSIGLI
 TECHNICAL DATA AND SUGGESTIONS
 TECHNISCHE DATEN UND EMPFEHLUNGEN
 DONNÉES TECHNIQUES ET CONSEILS



A..MTFNR/L

Ø25 - Ø50

91°

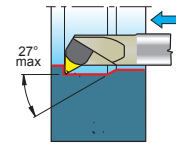
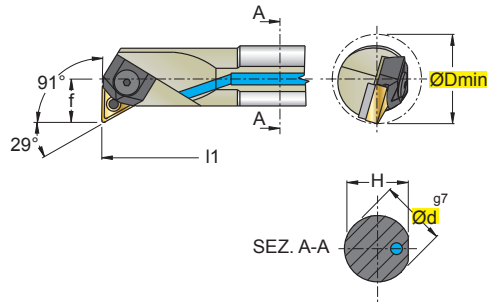

TNMA	
TNMG	
TNMM	

M

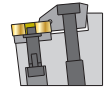

in figura utensile destro - right-hand shown

																				INSERTI - INSERTS PAG. 197
.G61	.G71	.F32	.F51	.G52	.G53	.G55	.G56	.G62	.G63											
ART. (mm)										1	2	3	4	5	6					
A25R	MTFNR/L	16	32	25	17	24,0	200	1604	100-50	—	4187	100-86P	5025							
A32S	MTFNR/L	16	40	32	22	31,0	250	1604	100-50	3216	4188	100-86P	5025							
A40T	MTFNR/L	16	50	40	27	38,5	300													
A50U	MTFNR/L	16	63	50	35	48,0	350													
A40T	MTFNR/L	22	50	40	27	38,5	300	2204	100-51	3222	4190	100-87P	5003							
A50U	MTFNR/L	22	63	50	35	48,0	350													

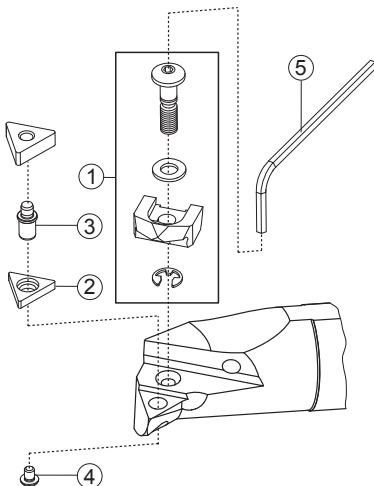

CAMPI D'IMPIEGO DEGLI INSERTI PER TORNITURA
 FIELDS OF APPLICATION FOR TURNING INSERTS
 EINSATZGEBIETE FÜR DREHPLATTEN
 CHAMPS D'USINAGE DES PLAQUETTES POUR TOURNAGE

VELOCITÀ DI TAGLIO Vc
 Vc. CUTTING SPEED
 Vc. SCHNITTGESCHWINDIGKEIT
 Vc. VITESSE DE COUPE

DETTAGLIO RICAMBI
 SPARE PARTS DETAILS
 DETAILS ZU DEN ERSATZTEILEN
 DÉTAIL DE PIÈCES DE RECHANGE

DATI TECNICI E CONSIGLI
 TECHNICAL DATA AND SUGGESTIONS
 TECHNISCHE DATEN UND EMPFEHLUNGEN
 DONNÉES TECHNIQUES ET CONSEILS

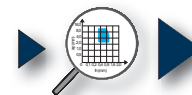

PAG. 226



PAG. 222



PAG. 1103



PAG. 1126

A..MWLNR/L..N

Ø20 - Ø50

95°

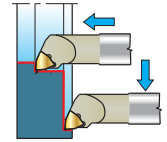
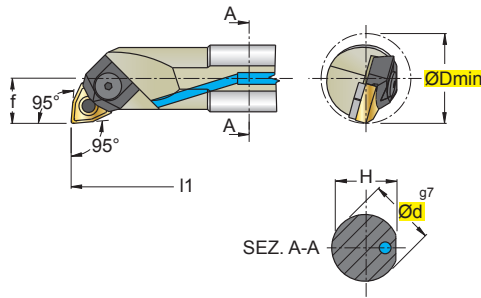





WNMA	
WNMG	
WNMM	





M

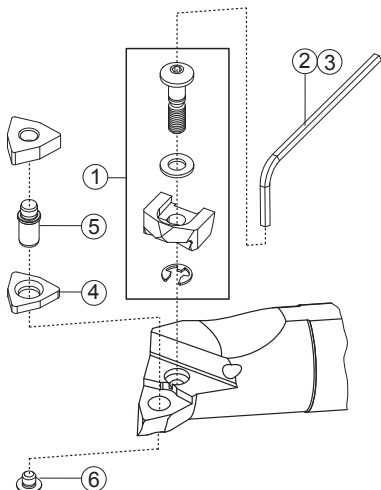

In figura utensile destro - Right-hand shown

														 INSERTI - INSERTS PAG. 199						
ART.														①	②	③	④	⑤	⑥	⊙
(mm)																				
 (mm)																				
ØDmin	Ød	f	H	l1																
A20Q	MWLNR/L 06	25	20	13	19,0	180	0604	100-53	5510	-	-	4184	-	-						
A25R	MWLNR/L 06	32	25	17	24,0	200	0604	100-53	5510	-	3306	4188	-	-						
A32S	MWLNR/L 06	40	32	22	31,0	250														
A25R	MWLNR/L 08N	32	25	17	24,0	200	0804	100-52	-	5025	3308M	4185	100-87P							
A32S	MWLNR/L 08N	40	32	22	31,0	250	0804	100-52	-	5025	3308M	4190	100-87P							
A40T	MWLNR/L 08N	50	40	27	38,5	300														
S50U	MWLNR/L 08N	63	50	35	47,0	350	0804	100-52	-	5025	3308M	4190	100-87P							
 = SENZA FORO DI REFRIGERAZIONE / WITHOUT COOLANT BORE / OHNE KUEHLMITTELBOHRUNG / SANS TROUS DE RÉFRIGÉRATION																				







 CAMPI D'IMPIEGO DEGLI INSERTI PER TORNITURA
 FIELDS OF APPLICATION FOR TURNING INSERTS
 EINSATZGEBIETE FÜR DREHPLATTEN
 CHAMPS D'USINAGE DES PLAQUETTES POUR TOURNAGE

 PAG. 226

 VELOCITÀ DI TAGLIO Vc
 Vc. CUTTING SPEED
 Vc. SCHNITTGESCHWINDIGKEIT
 Vc. VITESSE DE COUPE

 PAG. 222

 DETTAGLIO RICAMBI
 SPARE PARTS DETAILS
 DETAILS ZU DEN ERSATZTEILEN
 DÉTAIL DE PIÈCES DE RECHANGE

 PAG. 1103

 DATI TECNICI E CONSIGLI
 TECHNICAL DATA AND SUGGESTIONS
 TECHNISCHE DATEN UND EMPFEHLUNGEN
 DONNÉES TECHNIQUES ET CONSEILS

 PAG. 1126

A..MCLNR/L

Ø25 - Ø50

95°

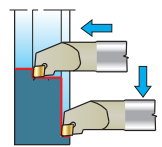
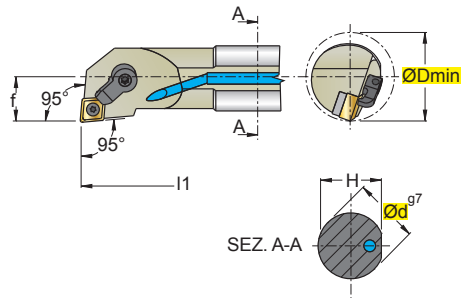

CNMA



CNMG



CNMM



M



In figura utensile destro - Right-hand shown

NEW													NEW													NEW													INSERTI - INSERTS PAG. 193
.G23	.G61	.F71	.X47	.G39	.G42	.F51	.G52	.G53	.G55	.G56	.K57P	.F61	.G62	.G63	.G68	.G72	.G82	.G34W	①	②	③	④	⑤	⑥	⑦														
ART.		(mm)																																					
		ØDmin	Ød	f	H	l1																																	
A25R	MCLNR/L 12	32	25	17	24,0	200	1204						KLM 44		CKM 21		STCM 20		5415																				
A32S	MCLNR/L 12	40	32	22	31,0	250	1204	KCN 433					KLM 46		CKM 21		STCM 20		5415		KMS 4		RCN1225																
A40T	MCLNR/L 12	50	40	27	38,5	300	1606																																
A50U	MCLNR/L 12	63	50	35	48,0	350																																	
A40T	MCLNR/L 16	50	40	27	38,5	300		KCN 533					KLM 58		CKM 21		STCM 20		5415		KMS 5																		
A50U	MCLNR/L 16	63	50	35	48,0	350	1906																																
A50U	MCLNR/L 19	63	50	35	48,0	350		KCN 633					KLM 68		CKM 12		STCM 4		5425		KMS 6																		

ART.	DIMENSIONI MEASURES ABMESSUNGEN DIMENSIONES	INSERTO INSERT WENDEPLATTEN PLAQUETTES
RCN 1225	<p>L 10,7 H 2,5 R 2,3</p>	<p>CN.. 1204..</p>

- VITE DI FISSAGGIO DEL SOTTOPLACCHETTA PER INSERTI SENZA FORO
 - SHIM CLAMPING SCREW FOR INSERTS WITHOUT BORE
 - UNTERLEGPLATTENBEFESTIGUNGSSCHRAUBE FÜR WENDEPLATTEN OHNE BOHRUNG
 - VIS DE FIXAGE DE SOUS-PLAQUETTE POUR PLAQUETTES SANS TROU

- ROMPIRUCIOLO PER INSERTI CERAMICI E SENZA FORO
 - CHIP BREAKER FOR CERAMIC INSERTS AND FOR INSERTS WITHOUT BORE
 - SPANBRECHER FÜR KERAMISCHE WENDEPLATTEN UND FÜR WENDEPLATTEN OHNE KUEHLMITTELBOHRUNG
 - BRISE-CPEAUX POUR PLAQUETTES CERAMIQUES ET POUR PLAQUETTES SANS TROU

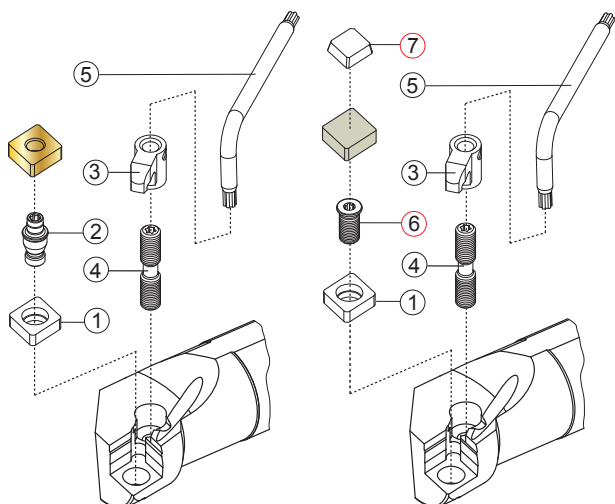

- CAMPI D'IMPIEGO DEGLI INSERTI PER TORNITURA
 - FIELDS OF APPLICATION FOR TURNING INSERTS
 - EINSATZGEBIETE FÜR DREHPLATTEN
 - CHAMPS D'USINAGE DES PLAQUETTES POUR Tournage

PAG. 226

- VELOCITÀ DI TAGLIO Vc
 - Vc. CUTTING SPEED
 - Vc. SCHNITTGESCHWINDIGKEIT
 - Vc. VITESSE DE COUPE

Vc **PAG. 222**

- DETTAGLIO RICAMBI
 - SPARE PARTS DETAILS
 - DETAILS ZU DEN ERSATZTEILEN
 - DÉTAIL DE PIÈCES DE RECHANGE

PAG. 1103

- DATI TECNICI E CONSIGLI
 - TECHNICAL DATA AND SUGGESTIONS
 - TECHNISCHE DATEN UND EMPFEHLUNGEN
 - DONNÉES TECHNIQUES ET CONSEILS

PAG. 1126

A..MDUNR/L

Ø25 - Ø40

93°

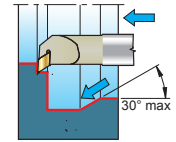
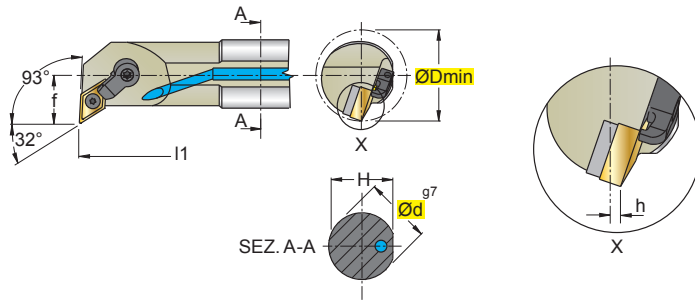

DNMA	
DNMG	
DNMM	

M



In figura utensile destro - Right-hand shown

			NEW 					NEW 							 INSERTI - INSERTS PAG. 195
.G23	.G39	.G42	.F51	.G52	.G53	.G55	.G56	.F61	.G62	.G63	.G68	.G72	.G34W		
ART.		(mm)								①	②	③	④	⑤	⑥
		ØDmin	Ød	f	H	l1	h								
A25R	MDUNR/L	15	32	25	17	24,0	200	1,5	1506	KDN433	KLM 46	CKM 22	STCM20	5415	KMS 4
A32S	MDUNR/L	15	40	32	22	31,0	250	1,5	1506	KDN433	KLM 46L	CKM 22	STCM20	5415	KMS 4
A40T	MDUNR/L	15	50	40	27	38,5	300	0							

- VITE DI FISSAGGIO DEL SOTTOPLACCHETTA PER INSERTI SENZA FORO
 - SHIM CLAMPING SCREW FOR INSERTS WITHOUT BORE
 - UNTERLEGPLATTENBEFESTIGUNGSSCHRAUBE FÜR WENDEPLATTEN OHNE BOHRUNG
 - VIS DE FIXAGE DE SOUS-PLAQUETTE POUR PLAQUETTES SANS TROU

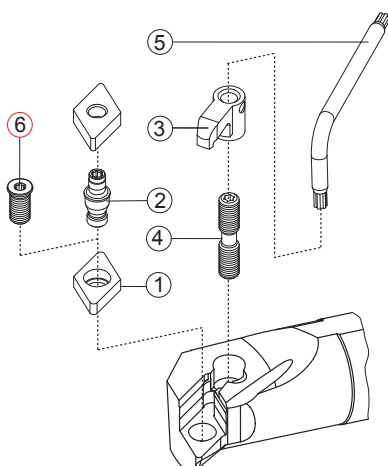

CAMPI D'IMPIEGO DEGLI INSERTI PER TORNITURA
 FIELDS OF APPLICATION FOR TURNING INSERTS
 EINSATZGEBIETE FÜR DREHPLATTEN
 CHAMPS D'USINAGE DES PLAQUETTES POUR TOURNAGE

VELOCITÀ DI TAGLIO Vc
 Vc. CUTTING SPEED
 Vc. SCHNITTGESCHWINDIGKEIT
 Vc. VITESSE DE COUPE

DETTAGLIO RICAMBI
 SPARE PARTS DETAILS
 DETAILS ZU DEN ERSATZTEILEN
 DÉTAIL DE PIÈCES DE RECHANGE

DATI TECNICI E CONSIGLI
 TECHNICAL DATA AND SUGGESTIONS
 TECHNISCHE DATEN UND EMPFEHLUNGEN
 DONNÉES TECHNIQUES ET CONSEILS

PAG. 226

Vc **PAG. 222**

PAG. 1103

PAG. 1126

A..MVPNR/L

Ø25 - Ø40

In figura utensile destro - Right-hand shown

A..MVUNR/L

Ø25 - Ø40

93°

In figura utensile destro - Right-hand shown

ART. (mm)								INSERTI - INSERTS						
		ØDmin	Ød	f	H	l1		1	2	3	4	5	6	7
A25R	MVPNR/L 16	32	25	17	24,0	200	1604	KVN323	KLM34L	5508	CKM21	STCM25	5415	KMS3
A32S	MVPNR/L 16	40	32	22	31,0	250	1604	KVN323	KLM34L	5508	CKM22	STCM25	5415	KMS3
A40T	MVPNR/L 16	50	40	27	38,5	300	1604	KVN323	KLM34L	5508	CKM22	STCM20	5415	KMS3
<p> - VITE DI FISSAGGIO DEL SOTTOPLACCHETTA PER INSERTI SENZA FORO - SHIM CLAMPING SCREW FOR INSERTS WITHOUT BORE - UNTERLEGPLATTENBEFESTIGUNGSSCHRAUBE FÜR WENDEPLATTEN OHNE BOHRUNG - VIS DE FIXAGE DE SOUS-PLAQUETTE POUR PLAQUETTES SANS TROU </p>														
A25R	MVUNR/L 16	32	25	17	24,0	200	1604	KVN323	KLM34L	5508	CKM21	STCM25	5415	KMS3
A32S	MVUNR/L 16	40	32	22	31,0	250	1604	KVN323	KLM34L	5508	CKM21	STCM25	5415	KMS3
A40T	MVUNR/L 16	50	40	27	38,5	300	1604	KVN323	KLM34L	5508	CKM21	STCM20	5415	KMS3
<p> - VITE DI FISSAGGIO DEL SOTTOPLACCHETTA PER INSERTI SENZA FORO - SHIM CLAMPING SCREW FOR INSERTS WITHOUT BORE - UNTERLEGPLATTENBEFESTIGUNGSSCHRAUBE FÜR WENDEPLATTEN OHNE BOHRUNG - VIS DE FIXAGE DE SOUS-PLAQUETTE POUR PLAQUETTES SANS TROU </p>														

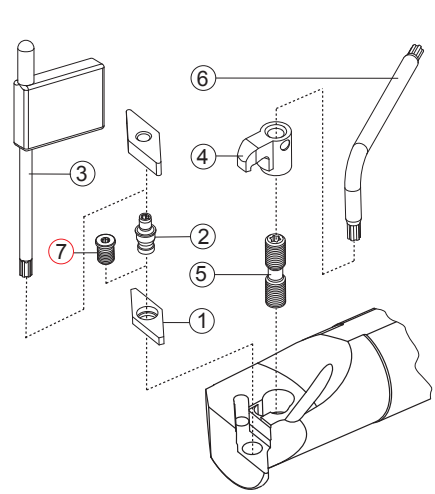

- CAMPI D'IMPIEGO DEGLI INSERTI PER TORNITURA
- FIELDS OF APPLICATION FOR TURNING INSERTS
- EINSATZGEBIETE FÜR DREHPLATTEN
- CHAMPS D'USINAGE DES PLAQUETTES POUR TOURNAGE

- VELOCITÀ DI TAGLIO Vc
- Vc. CUTTING SPEED
- Vc. SCHNITTGESCHWINDIGKEIT
- Vc. VITESSE DE COUPE

- DETTAGLIO RICAMBI
- SPARE PARTS DETAILS
- DETAILS ZU DEN ERSATZTEILEN
- DÉTAIL DE PIÈCES DE RECHANGE

- DATI TECNICI E CONSIGLI
- TECHNICAL DATA AND SUGGESTIONS
- TECHNISCHE DATEN UND EMPFEHLUNGEN
- DONNÉES TECHNIQUES ET CONSEILS

PAG. 226

PAG. 222

PAG. 1103

PAG. 1126

A..MVZNR/L

Ø32 - Ø40

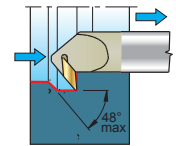
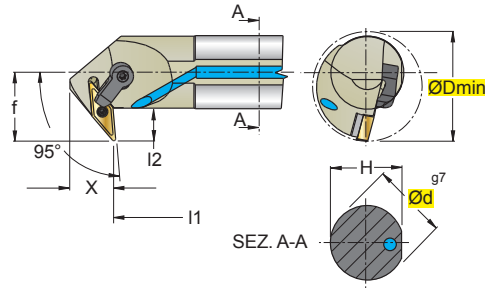

VNMG



M



In figura utensile destro - Right-hand shown



.G23 .G42 .G52 .G53 .G55

ART.

(mm)



ØDmin Ød f H I1 I2 X

A32S	MVZNR/L	16	48	32	30	31,0	250	14	18
A40T	MVZNR/L	16	57	40	35	38,5	300	15	20

1	2	3	4	5	6	7
KVN323	KLM34L	5508	CKM22	STCM25	5415	KMS3

INSERTI - INSERTS
PAG. 198

- VITE DI FISSAGGIO DEL SOTTOPLACCHETTA PER INSERTI SENZA FORO
 - SHIM CLAMPING SCREW FOR INSERTS WITHOUT BORE
 - UNTERLEGPLATTENBEFESTIGUNGSSCHRAUBE FÜR WENDEPLATTEN OHNE BOHRUNG
 - VIS DE FIXAGE DE SOUS-PLAQUETTE POUR PLAQUETTES SANS TROU

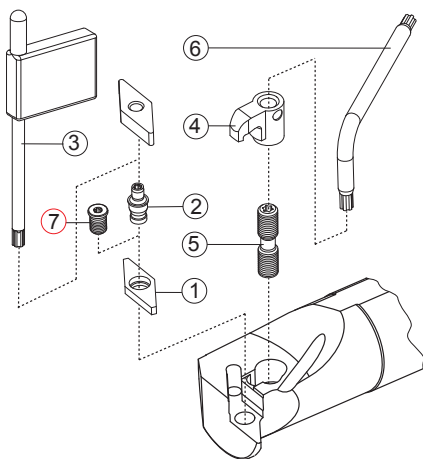

CAMPI D'IMPIEGO DEGLI INSERTI PER TORNITURA
 FIELDS OF APPLICATION FOR TURNING INSERTS
 EINSATZGEBIETE FÜR DREHPLATTEN
 CHAMPS D'USINAGE DES PLAQUETTES POUR TOURNAGE

VELOCITÀ DI TAGLIO Vc
 Vc. CUTTING SPEED
 Vc. SCHNITTGESCHWINDIGKEIT
 Vc. VITESSE DE COUPE

DETTAGLIO RICAMBI
 SPARE PARTS DETAILS
 DETAILS ZU DEN ERSATZTEILEN
 DÉTAIL DE PIÈCES DE RECHANGE

DATI TECNICI E CONSIGLI
 TECHNICAL DATA AND SUGGESTIONS
 TECHNISCHE DATEN UND EMPFEHLUNGEN
 DONNÉES TECHNIQUES ET CONSEILS

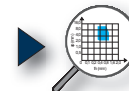

PAG. 226



PAG. 222



PAG. 1103



PAG. 1126

A..SWUCR/L

Ø8

93°

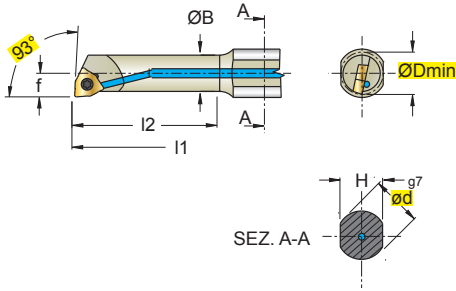

In figura utensile destro - Right-hand shown

E..SWUCR/L..N

Ø5 - Ø8

93°

NEW

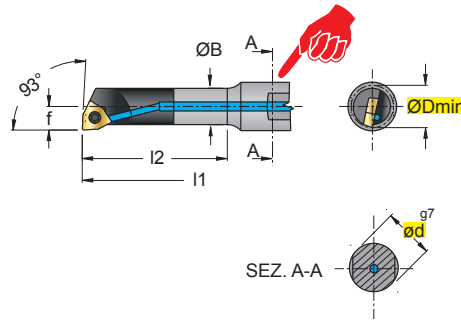

In figura utensile destro - Right-hand shown

WC.T

S

WC.T

S



ART.

(mm)



1	2		

ART.		ØDmin	Ød	ØB	f	H	l1	l2	Nm
A0508H	SWUCR/L 02	5,8	8	5	2,9	7	100	16	0,5+0,6
A0608H	SWUCR/L 02	7,8	8	6	3,9	7	100	24	0,5+0,6

PER UTENSILE R MONTARE INSERTO **WCGT..L.B22** , PER UTENSILE L MONTARE INSERTO **WCGT..R.B22**
 FOR R TOOL FIT INSERT **WCGT..L.B22**, FOR L TOOL FIT INSERT **WCGT..R.B22**
 FÜR DAS WERKZEUG R DIE WENDEPLATTE **WCGT..L.B22** EINSETZEN; FÜR DAS WERKZEUG L DIE WENDEPLATTE **WCGT..R.B22**
 DANS LE CAS DE L'OUTIL R MONTER LA PLAQUETTE **WCGT..L.B22**, DANS LE CAS DE L'OUTIL L MONTER LA PLAQUETTE **WCGT..R.B22**

E05F	SWUCR/L 02N	5,8	5	-	2,9	-	85	-	0,5+0,6	0201	12203	5506
E06G	SWUCR/L 02N	7,8	6	-	3,9	-	95	-	0,5+0,6			
E0508H	SWUCR/L 02N	5,8	8	5	2,9	-	100	24	0,5+0,6	0201	12203	5506
E0608H	SWUCR/L 02N	7,8	8	6	3,9	-	100	32	0,5+0,6			

PER UTENSILE R MONTARE INSERTO **WCGT..L.B22** , PER UTENSILE L MONTARE INSERTO **WCGT..R.B22**
 FOR R TOOL FIT INSERT **WCGT..L.B22**, FOR L TOOL FIT INSERT **WCGT..R.B22**
 FÜR DAS WERKZEUG R DIE WENDEPLATTE **WCGT..L.B22** EINSETZEN; FÜR DAS WERKZEUG L DIE WENDEPLATTE **WCGT..R.B22**
 DANS LE CAS DE L'OUTIL R MONTER LA PLAQUETTE **WCGT..L.B22**, DANS LE CAS DE L'OUTIL L MONTER LA PLAQUETTE **WCGT..R.B22**

UTENSILI CON STELO IN METALLO DURO
TOOLS WITH CARBIDE SHAFT
WERKZEUGE MIT HM-SCHAFT
OUTILS AVEC QUEUE EN METAL DUR

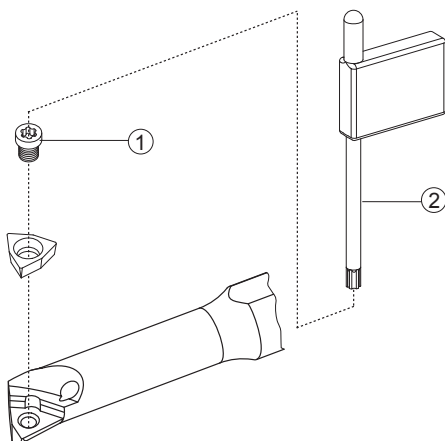

CAMPI D'IMPIEGO DEGLI INSERTI PER TORNITURA
FIELDS OF APPLICATION FOR TURNING INSERTS
EINSATZGEBIETE FÜR DREHPLATTEN
CHAMPS D'USINAGE DES PLAQUETTES POUR TOURNAGE

VELOCITÀ DI TAGLIO Vc
Vc. CUTTING SPEED
Vc. SCHNITTGESCHWINDIGKEIT
Vc. VITESSE DE COUPE

DETTAGLIO RICAMBI
SPARE PARTS DETAILS
DETAILS ZU DEN ERSATZTEILEN
DÉTAIL DE PIÈCES DE RECHANGE

DATI TECNICI E CONSIGLI
TECHNICAL DATA AND SUGGESTIONS
TECHNISCHE DATEN UND EMPFEHLUNGEN
DONNÉES TECHNIQUES ET CONSEILS

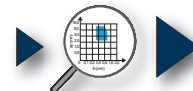

A..SCUPR/L

Ø8 - Ø16

93°

In figura utensile destro - Right-hand shown

E..SCUPR/L..N

Ø8 - Ø16

93° NEW

In figura utensile destro - Right-hand shown

CP.T

CP.W

S

.D34	.D42	.E42	

INSERTI - INSERTS
PAG. 202

ART.		(mm)									1 2			
		ØDmin	Ød	ØB	f	H	l1	l2	Nm					
A0608H	SCUPR/L 05	8,0	8	6	4,5	7	100	20	0,9±1,0	05T1	12224	5507		
A0810J	SCUPR/L 05	10,5	10	8	6,0	9	110	26	0,9±1,0					
A1012K	SCUPR/L 05	12,5	12	10	7,0	11	125	32	0,9±1,0					
A1216M	SCUPR/L 05	15,5	16	12	9,0	15	150	40	0,9±1,0					

E0608H	SCUPR/L 05N	8	8	6	4,5	-	100	28	0,9±1,0	05T1	12224	5507		
E0810J	SCUPR/L 05N	11	10	8	6,0	-	110	36	0,9±1,0					
E1012K	SCUPR/L 05N	13	12	10	7,0	-	125	44	0,9±1,0					
E1216M	SCUPR/L 05N	16	16	12	9,0	-	150	55	0,9±1,0					

UTENSILI CON STELO IN METALLO DURO

TOOLS WITH CARBIDE SHAFT

WERKZEUGE MIT HM-SCHAFT

OUTILS AVEC QUEUE EN METAL DUR

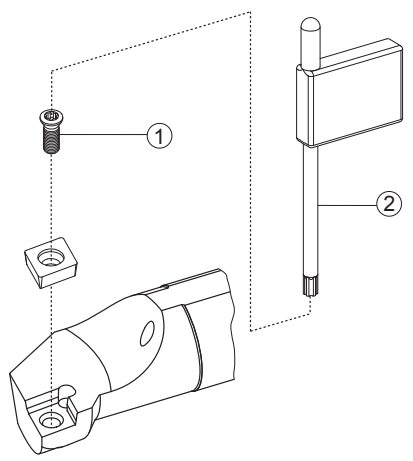

CAMPI D'IMPIEGO DEGLI INSERTI PER TORNITURA
FIELDS OF APPLICATION FOR TURNING INSERTS
EINSATZGEBIETE FÜR DREHPLATTEN
CHAMPS D'USINAGE DES PLAQUETTES POUR TOURNAGE

PAG. 226

VELOCITÀ DI TAGLIO Vc
Vc. CUTTING SPEED
Vc. SCHNITTGESCHWINDIGKEIT
Vc. VITESSE DE COUPE

Vc **PAG. 222**

DETTAGLIO RICAMBI
SPARE PARTS DETAILS
DETAILS ZU DEN ERSATZTEILEN
DÉTAIL DE PIÈCES DE RECHANGE

PAG. 1103

DATI TECNICI E CONSIGLI
TECHNICAL DATA AND SUGGESTIONS
TECHNISCHE DATEN UND EMPFEHLUNGEN
DONNÉES TECHNIQUES ET CONSEILS

PAG. 1126

A..SCLCR/L

Ø8 - Ø16

95°

In figura utensile destro - Right-hand shown

S..SCLCR/L

Ø8 - Ø16

95°

In figura utensile destro - Right-hand shown

NEW

.B22

NEW

.F47

NEW

.G13

NEW

.G57P

NEW

.X47

NEW

.F32

NEW

.F33

NEW

.G39

NEW

.G42

NEW

.F51

NEW

.G52

NEW

.G32W

INSERTI - INSERTS
PAG. 201

ART.		(mm)														
		ØDmin	Ød	ØB	f	H	l1	l2	Nm		1	2				
A0608H	SCLCR/L 06	8,5	8	6	4	7	100	20	1,0+1,2	0602	12254P	5507P				
A0810J	SCLCR/L 06	10,5	10	8	6	9	110	26	1,0+1,2							
A1012K	SCLCR/L 06	12,5	12	10	7	11	125	32	1,0+1,2							
A1216M	SCLCR/L 06	15,5	16	12	9	15	150	40	1,0+1,2							

PER UTENSILE R MONTARE INSERTO **CCET..L.B22** , PER UTENSILE L MONTARE INSERTO **CCET..R.B22**
 FOR R TOOL FIT INSERT **CCET..L.B22**, FOR L TOOL FIT INSERT **CCET..R.B22**
 FÜR DAS WERKZEUG R DIE WENDEPLATTE **CCET..L.B22** EINSETZEN; FÜR DAS WERKZEUG L DIE WENDEPLATTE **CCET..R.B22**
 DANS LE CAS DE L'OUTIL R MONTER LA PLAQUETTE **CCET..L.B22**, DANS LE CAS DE L'OUTIL L MONTER LA PLAQUETTE **CCET..R.B22**

S0608H	SCLCR/L 06	8,5	8	6	4	7	100	20	1,0+1,2	0602	12254P	5507P				
S0810J	SCLCR/L 06	10,5	10	8	6	9	110	26	1,0+1,2							
S1012K	SCLCR/L 06	12,5	12	10	7	11	125	32	1,0+1,2							
S1216M	SCLCR/L 06	15,5	16	12	9	15	150	40	1,0+1,2							

PER UTENSILE R MONTARE INSERTO **CCET..L.B22** , PER UTENSILE L MONTARE INSERTO **CCET..R.B22**
 FOR R TOOL FIT INSERT **CCET..L.B22**, FOR L TOOL FIT INSERT **CCET..R.B22**
 FÜR DAS WERKZEUG R DIE WENDEPLATTE **CCET..L.B22** EINSETZEN; FÜR DAS WERKZEUG L DIE WENDEPLATTE **CCET..R.B22**
 DANS LE CAS DE L'OUTIL R MONTER LA PLAQUETTE **CCET..L.B22**, DANS LE CAS DE L'OUTIL L MONTER LA PLAQUETTE **CCET..R.B22**

SENZA FORO DI ADDUZIONE REFRIGERANTE
 WITHOUT COOLANT FEED
 OHNE KÜLMITTELZUFUHR
 SANS ABDUCTION DU RÉFRIGÉRANTE

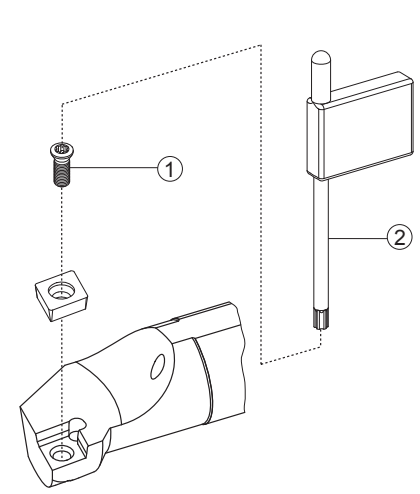

- CAMPI D'IMPIEGO DEGLI INSERTI PER TORNITURA
 - FIELDS OF APPLICATION FOR TURNING INSERTS
 - EINSATZGEBIETE FÜR DREHPLATTEN
 - CHAMPS D'USINAGE DES PLAQUETTES POUR TOURNAGE
-
- VELOCITÀ DI TAGLIO Vc
 - Vc. CUTTING SPEED
 - Vc. SCHNITTGESCHWINDIGKEIT
 - Vc. VITESSE DE COUPE
-
- DETTAGLIO RICAMBI
 - SPARE PARTS DETAILS
 - DETAILS ZU DEN ERSATZTEILEN
 - DÉTAIL DE PIÈCES DE RECHANGE
-
- DATI TECNICI E CONSIGLI
 - TECHNICAL DATA AND SUGGESTIONS
 - TECHNISCHE DATEN UND EMPFEHLUNGEN
 - DONNÉES TECHNIQUES ET CONSEILS

PAG. 226

PAG. 222

PAG. 1103

PAG. 1126

A..SCLCR/L

Ø8 - Ø40

95°

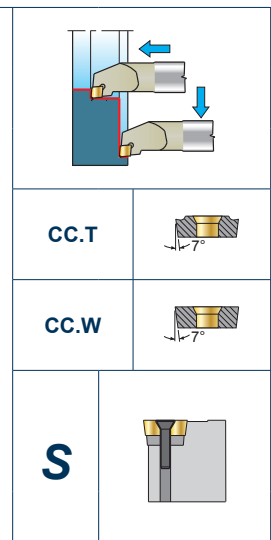
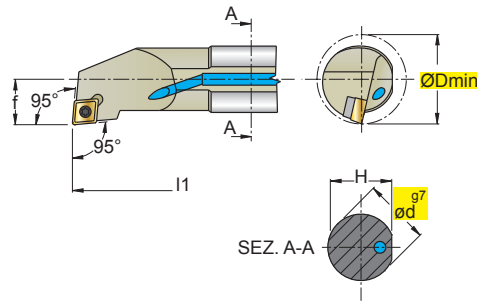

In figura utensile destro - Right-hand shown

ART.	NEW											INSERTI - INSERTS PAG. 201				
	(mm)											1	2	3	4	
	R	ØDmin		Ød	f	H	l1	Nm								
A08F	SCLCR/L	06	10	8	5	7,60	80	1,0+1,2	0602	-	-	12254P	5507P			
A10H	SCLCR/L	06	12	10	7	9,50	100	1,1+1,3	0602	-	-	12256P	5508P			
A12K	SCLCR/L	06	16	12	9	11,50	125	1,1+1,3								
A16M	SCLCR/L	09	20	16	11	15,25	150	3,8+5,0	09T3	-	-	12409P	5515P			
A20Q	SCLCR/L	09	25	20	13	19,00	180	3,8+5,0								
A25R	SCLCR/L	09	32	25	17	24,00	200	3,8+5,0	09T3	-	-	1240P	5515P			
A25R	SCLCR/L	12	32	25	17	24,00	200	4,0+5,0	1204	-	-	124510P	5520P			
A32S	SCLCR/L	12	40	32	22	31,00	250	4,0+5,0	1204	3611	BCL15	124513P	5520P			
A40T	SCLCR/L	12	50	40	27	38,50	300	4,0+5,0								

PER UTENSILE R MONTARE INSERTO **CCET..L.B22** , PER UTENSILE L MONTARE INSERTO **CCET..R.B22**
 FOR R TOOL FIT INSERT **CCET..L.B22** , FOR L TOOL FIT INSERT **CCET..R.B22**
 FÜR DAS WERKZEUG R DIE WENDEPLATTE **CCET..L.B22** EINSETZEN; FÜR DAS WERKZEUG L DIE WENDEPLATTE **CCET..R.B22**
 DANS LE CAS DE L'OUTIL R MONTER LA PLAQUETTE **CCET..L.B22** , DANS LE CAS DE L'OUTIL L MONTER LA PLAQUETTE **CCET..R.B22**

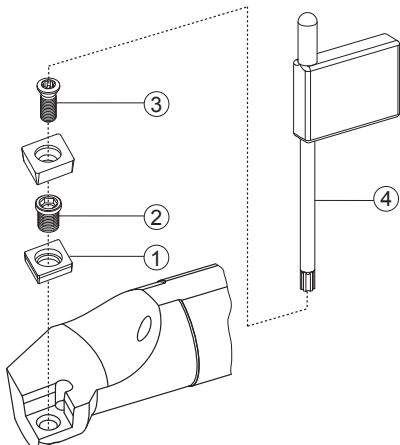

CAMPI D'IMPIEGO DEGLI INSERTI PER TORNATURA
 FIELDS OF APPLICATION FOR TURNING INSERTS
 EINSATZGEBIETE FÜR DREHPLATTEN
 CHAMPS D'USINAGE DES PLAQUETTES POUR TOURNAGE

VELOCITÀ DI TAGLIO Vc
 Vc. CUTTING SPEED
 Vc. SCHNITTGESCHWINDIGKEIT
 Vc. VITESSE DE COUPE

DETTAGLIO RICAMBI
 SPARE PARTS DETAILS
 DETAILS ZU DEN ERSATZTEILEN
 DÉTAIL DE PIÈCES DE RECHANGE

DATI TECNICI E CONSIGLI
 TECHNICAL DATA AND SUGGESTIONS
 TECHNISCHE DATEN UND EMPFEHLUNGEN
 DONNÉES TECHNIQUES ET CONSEILS

PAG. 226

PAG. 222

PAG. 1103

PAG. 1126

E..SCLCR/L..N

Ø8 - Ø25

95°

NEW

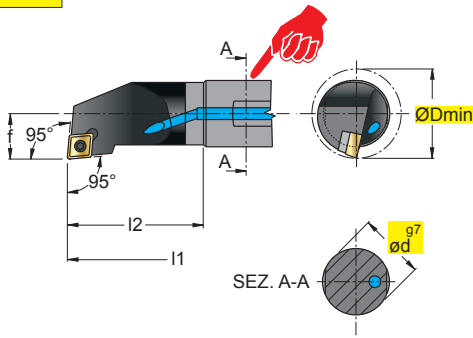

In figura utensile destro - Right-hand shown

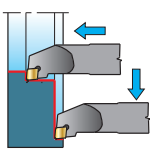

SET ECL 0812 R 06N

NEW



Contenuto del Set - Set Content
N.1 E08K SCLCR 06N
N.1 E10K SCLCR 06N
N.1 E12M SCLCR 06N

SET ECL 0812 L 06N

NEW



Contenuto del Set - Set Content
N.1 E08K SCLCL 06N
N.1 E10K SCLCL 06N
N.1 E12M SCLCL 06N



ART.		(mm)					Nm		1	2	○	○	○
		ØDmin	Ød	f	l1	l2							
E08K	SCLCR/L 06N	10	8	5	125	10	1,0+1,2	0602	12254P	5507P			
E10K	SCLCR/L 06N	12	10	6	125	10	1,1+1,3						
E12M	SCLCR/L 06N	14	12	8	150	10	1,1+1,3						
E16R	SCLCR/L 09N	18	16	10	200	16	3,8+5,0	09T3	12409P	5515P			
E20S	SCLCR/L 09N	23	20	12	250	16	3,8+5,0						
E25S	SCLCR/L 12N	30	25	15	250	16	4,0+5,0	1204	124510P	5520P			

UTENSILI CON STELO IN METALLO DURO
TOOLS WITH CARBIDE SHAFT
WERKZEUGE MIT HM-SCHAFT
OUTILS AVEC QUEUE EN METAL DUR

PER UTENSILE R MONTARE INSERTO CCET..L.B22 , PER UTENSILE L MONTARE INSERTO CCET..R.B22
FOR R TOOL FIT INSERT CCET..L.B22, FOR L TOOL FIT INSERT CCET..R.B22
FÜR DAS WERKZEUG R DIE WENDEPLATTE CCET..L.B22 EINSETZEN; FÜR DAS WERKZEUG L DIE WENDEPLATTE CCET..R.B22
DANS LE CAS DE L'OUTIL R MONTER LA PLAQUETTE CCET..L.B22, DANS LE CAS DE L'OUTIL L MONTER LA PLAQUETTE CCET..R.B22

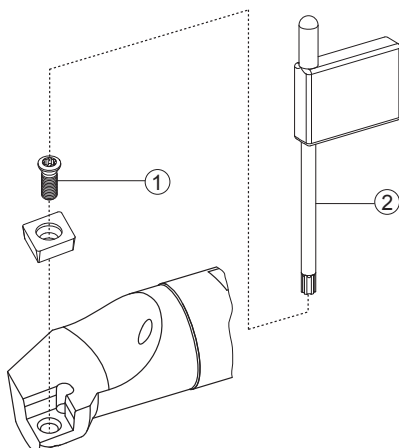

CAMPI D'IMPIEGO DEGLI INSERTI PER TORNITURA
FIELDS OF APPLICATION FOR TURNING INSERTS
EINSATZGEBIETE FÜR DREHPLATTEN
CHAMPS D'USINAGE DES PLAQUETTES POUR TOURNAGE

VELOCITÀ DI TAGLIO Vc
Vc. CUTTING SPEED
Vc. SCHNITTGESCHWINDIGKEIT
Vc. VITESSE DE COUPE

DETTAGLIO RICAMBI
SPARE PARTS DETAILS
DETAILS ZU DEN ERSATZTEILEN
DÉTAIL DE PIÈCES DE RECHANGE

DATI TECNICI E CONSIGLI
TECHNICAL DATA AND SUGGESTIONS
TECHNISCHE DATEN UND EMPFEHLUNGEN
DONNÉES TECHNIQUES ET CONSEILS

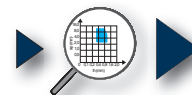

PAG. 226



PAG. 222



PAG. 1103



PAG. 1126

B..SCLCR/L

Ø20 - Ø32

95°

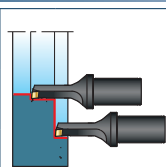
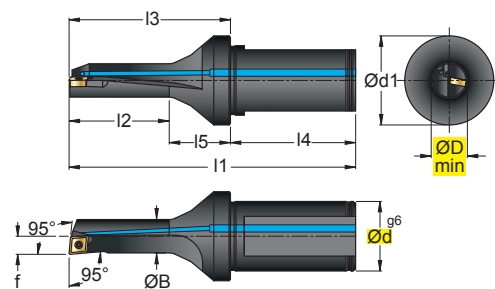

CC.T



CC.W



S

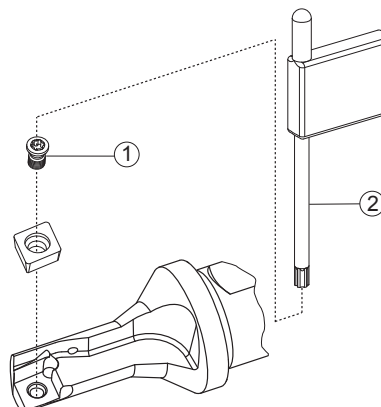

PAG. 226



PAG. 222



PAG. 1103



PAG. 1126

In figura utensile destro - Right-hand shown

.B22	.F47	.G13	.G57P	.X47	.F32	.F33	.G39	.G42	.F51	.G52	.G32W			INSERTI - INSERTS PAG. 201

ART.	(mm)														①			②		
		ØDmin	Ød	ØB	Ød1	f	l1	l2	l3	l4	l5	Nm								
B 20 0816 SCLCR/L 06		9	20	8	26	4,5	76	16	36	40	20	1,0+1,2	0602	12253	5507					
B 20 0824 SCLCR/L 06		9	20	8	26	4,5	84	24	44	40	20	1,0+1,2								
B 20 1020 SCLCR/L 06		11	20	10	26	5,5	80	20	40	40	20	1,0+1,2	0602	12254P	5507P					
B 20 1030 SCLCR/L 06		11	20	10	26	5,5	90	30	50	40	20	1,0+1,2								
B 20 1224 SCLCR/L 06		13	20	12	26	6,5	84	24	44	40	20	1,1+1,3	0602	12256P	5508P					
B 20 1236 SCLCR/L 06		13	20	12	26	6,5	96	36	56	40	20	1,1+1,3								
B 20 1428 SCLCR/L 06		15	20	14	26	7,5	88	28	48	40	20	1,1+1,3								
B 20 1442 SCLCR/L 06		15	20	14	26	7,5	102	42	62	40	20	1,1+1,3								
B 20 1428 SCLCR/L 09		15	20	14	26	7,5	88	28	48	40	20	3,5+4,0	09T3	1440	5515					
B 20 1442 SCLCR/L 09		15	20	14	26	7,5	102	42	62	40	20	3,5+4,0								
B 20 1632 SCLCR/L 09		17	20	16	26	8,5	92	32	52	40	20	3,5+4,0								
B 20 1648 SCLCR/L 09		17	20	16	26	8,5	108	48	68	40	20	3,5+4,0								
B 25 0816 SCLCR/L 06		9	25	8	32	4,5	83	16	38	45	22	1,0+1,2	0602	12253	5507					
B 25 0824 SCLCR/L 06		9	25	8	32	4,5	91	24	46	45	22	1,0+1,2								
B 25 1020 SCLCR/L 06		11	25	10	32	5,5	87	20	42	45	22	1,0+1,2	0602	12254P	5507P					
B 25 1030 SCLCR/L 06		11	25	10	32	5,5	97	30	52	45	22	1,0+1,2								
B 25 1224 SCLCR/L 06		13	25	12	32	6,5	91	24	46	45	22	1,1+1,3	0602	12256P	5508P					
B 25 1236 SCLCR/L 06		13	25	12	32	6,5	103	36	58	45	22	1,1+1,3								
B 25 1428 SCLCR/L 06		15	25	14	32	7,5	95	28	50	45	22	1,1+1,3								
B 25 1442 SCLCR/L 06		15	25	14	32	7,5	109	42	64	45	22	1,1+1,3								
B 25 1428 SCLCR/L 09		15	25	14	32	7,5	95	28	50	45	22	3,5+4,0	09T3	1440	5515					
B 25 1442 SCLCR/L 09		15	25	14	32	7,5	109	42	64	45	22	3,5+4,0								
B 25 1632 SCLCR/L 09		17	25	16	32	8,5	99	32	54	45	22	3,5+4,0								
B 25 1648 SCLCR/L 09		17	25	16	32	8,5	115	48	70	45	22	3,5+4,0								
B 25 2040 SCLCR/L 09		21	25	20	32	10,5	107	40	62	45	22	3,8+5,0	09T3	12409P	5515					
B 25 2060 SCLCR/L 09		21	25	20	32	10,5	127	60	82	45	22	3,8+5,0								
B 32 0816 SCLCR/L 06		9	32	8	43	4,5	88	16	40	48	24	1,0+1,2	0602	12253	5507					
B 32 0824 SCLCR/L 06		9	32	8	43	4,5	96	24	48	48	24	1,0+1,2								
B 32 1020 SCLCR/L 06		11	32	10	43	5,5	92	20	44	48	24	1,0+1,2	0602	12254P	5507P					
B 32 1030 SCLCR/L 06		11	32	10	43	5,5	102	30	54	48	24	1,0+1,2								
B 32 1224 SCLCR/L 06		13	32	12	43	6,5	96	24	48	48	24	1,1+1,3	0602	12256P	5508P					
B 32 1236 SCLCR/L 06		13	32	12	43	6,5	108	36	60	48	24	1,1+1,3								
B 32 1428 SCLCR/L 06		15	32	14	43	7,5	100	28	52	48	24	1,1+1,3								
B 32 1442 SCLCR/L 06		15	32	14	43	7,5	114	42	66	48	24	1,1+1,3								
B 32 1428 SCLCR/L 09		15	32	14	43	7,5	100	28	52	48	24	3,5+4,0	09T3	1440	5515					
B 32 1442 SCLCR/L 09		15	32	14	43	7,5	114	42	66	48	24	3,5+4,0								
B 32 1632 SCLCR/L 09		17	32	16	43	8,5	104	32	56	48	24	3,5+4,0								
B 32 1648 SCLCR/L 09		17	32	16	43	8,5	120	48	72	48	24	3,5+4,0								
B 32 2040 SCLCR/L 09		21	32	20	43	10,5	112	40	64	48	24	3,8+5,0	09T3	12409P	5515					
B 32 2060 SCLCR/L 09		21	32	20	43	10,5	132	60	84	48	24	3,8+5,0								
B 32 2550 SCLCR/L 09		26	32	25	43	13,0	122	50	74	48	24	3,8+5,0								
B 32 2575 SCLCR/L 09		26	32	25	43	13,0	147	75	99	48	24	3,8+5,0								

A..SDUCR/L

Ø10 - Ø16

93°

in figura utensile destro - right-hand shown

S..SDUCR/L

Ø10 - Ø16

93°

In figura utensile destro - Right-hand shown

DC.T

DC.W

S

NEW

NEW

NEW

NEW

NEW

NEW

NEW

NEW

INSERTI - INSERTS
PAG. 203

ART.		(mm)								Nm	1		2	
		ØDmin	Ød	f	a	H	l1	l2						
A0810H	SDUCR/L 07	12,5	10	7	4	9	100	22	1,0+1,2	0702	12254P	5507P		
A1012K	SDUCR/L 07	15,5	12	9	5	11	125	28	1,0+1,2					
A1216M	SDUCR/L 07	19,5	16	11	5	15	150	36	1,0+1,2					

S0810H	SDUCR/L 07	12,5	10	7	4	9	100	22	1,0+1,2	0702	12254P	5507P		
S1012K	SDUCR/L 07	15,5	12	9	5	11	125	28	1,0+1,2					
S1216M	SDUCR/L 07	19,5	16	11	5	15	150	36	1,0+1,2					

SENZA FORO DI ADDUZIONE REFRIGERANTE
WITHOUT COOLANT FEED
OHNE KÜLMITTELZUFUHR
SANS ABDUCTION DU RÉFRIGÉRANTE

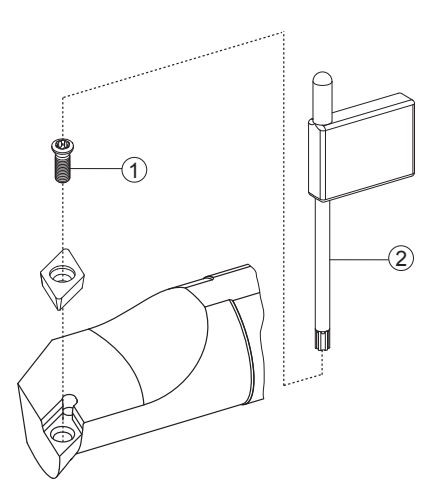

- CAMPI D'IMPIEGO DEGLI INSERTI PER TORNITURA
FIELDS OF APPLICATION FOR TURNING INSERTS
EINSATZGEBIETE FÜR DREHPLATTEN
CHAMPS D'USINAGE DES PLAQUETTES POUR TOURNAGE
- VELOCITÀ DI TAGLIO Vc
Vc. CUTTING SPEED
Vc. SCHNITTGESCHWINDIGKEIT
Vc. VITESSE DE COUPE
- DETTAGLIO RICAMBI
SPARE PARTS DETAILS
DETAILS ZU DEN ERSATZTEILEN
DÉTAIL DE PIÈCES DE RECHANGE
- DATI TECNICI E CONSIGLI
TECHNICAL DATA AND SUGGESTIONS
TECHNISCHE DATEN UND EMPFEHLUNGEN
DONNÉES TECHNIQUES ET CONSEILS

PAG. 226

PAG. 222

PAG. 1103

PAG. 1126

A..SDUCR/L

Ø10 - Ø40

93°

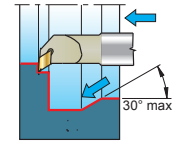
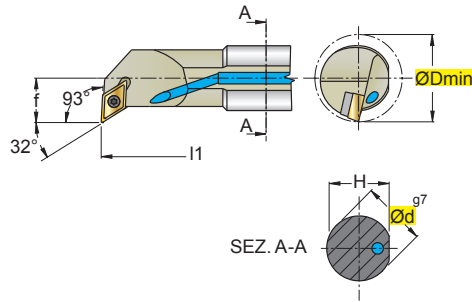

DC.T



DC.W



S



in figura utensile destro - right-hand shown

															INSERTI - INSERTS PAG. 203				
															1	2	2	4	○
ART.	(mm)						Nm												
	ØDmin	Ød	f	H	L1														
A10H	SDUCR/L 07	13	10	8	9,50	100	1,1+1,3	0702											
A12K	SDUCR/L 07	16	12	9	11,50	125	1,1+1,3												
A16M	SDUCR/L 07	20	16	11	15,25	150	1,1+1,3												
A20Q	SDUCR/L 07	25	20	13	19,00	180	1,1+1,3												
A20Q	SDUCR/L 11	25	20	13	19,00	180	3,8+5,0	11T3											
A25R	SDUCR/L 11	32	25	17	24,00	200	3,8+5,0	11T3											
A32S	SDUCR/L 11	40	32	22	31,00	250	3,0+3,5	11T3	3711	BCL7	123511P	5515P							
A40T	SDUCR/L 11	49	40	27	38,50	300	3,0+3,5												

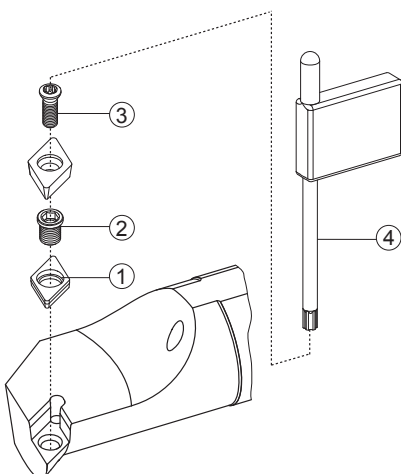

CAMPI D'IMPIEGO DEGLI INSERTI PER TORNITURA
 FIELDS OF APPLICATION FOR TURNING INSERTS
 EINSATZGEBIETE FÜR DREHPLATTEN
 CHAMPS D'USINAGE DES PLAQUETTES POUR TOURNAGE

VELOCITÀ DI TAGLIO Vc
 Vc. CUTTING SPEED
 Vc. SCHNITTGESCHWINDIGKEIT
 Vc. VITESSE DE COUPE

DETTAGLIO RICAMBI
 SPARE PARTS DETAILS
 DETAILS ZU DEN ERSATZTEILEN
 DÉTAIL DE PIÈCES DE RECHANGE

DATI TECNICI E CONSIGLI
 TECHNICAL DATA AND SUGGESTIONS
 TECHNISCHE DATEN UND EMPFEHLUNGEN
 DONNÉES TECHNIQUES ET CONSEILS

PAG. 226

PAG. 222

PAG. 1103

PAG. 1126

E..SDUCR/L..N

Ø10 - Ø20

93°

NEW

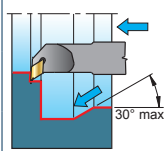
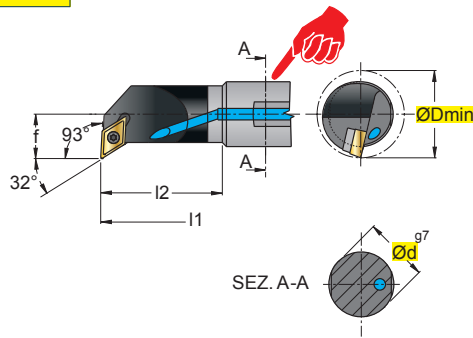

In figura utensile destro - Right-hand shown

SET EDU 1012 R 07N

NEW



Contenuto del Set - Set Content
N.1 E10K SDUCR 07N
N.1 E12M SDUCR 07N

SET EDU 1012 L 07N

NEW



Contenuto del Set - Set Content
N.1 E10K SDUCL 07N
N.1 E12M SDUCL 07N

															 INSERTI - INSERTS PAG. 203
.G13	L.F45	R.F45	.F46	.F47	.B53	.G57P	.X47	.F32	.F33	.G39	.G42	.F51	.G52	.G32W	

ART.		(mm)					Nm		① ② ● ● ●						
		ØDmin	Ød	f	L1	L2									
E10K	SDUCR/L 07N	12,5	10	7,0	125	10,0	1,1+1,3	0702							
E12M	SDUCR/L 07N	15,0	12	9,0	150	12,5	1,1+1,3								
E16R	SDUCR/L 07N	19,0	16	11,0	200	16,5	1,1+1,3								
E20S	SDUCR/L 11N	23,5	20	12,5	250	20,5	3,8+5,0								

- UTENSILI CON STELO IN METALLO DURO
- TOOLS WITH CARBIDE SHAFT
- WERKZEUGE MIT HM-SCHAFT
- OUTILS AVEC QUEUE EN METAL DUR

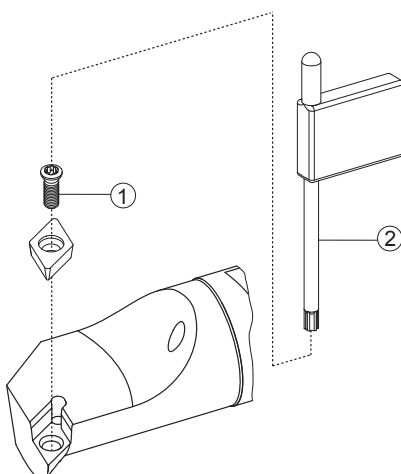

- CAMPI D'IMPIEGO DEGLI INSERTI PER TORNITURA
- FIELDS OF APPLICATION FOR TURNING INSERTS
- EINSATZGEBIETE FÜR DREHPLATTEN
- CHAMPS D'USINAGE DES PLAQUETTES POUR TOURNAGE

- VELOCITÀ DI TAGLIO Vc
- Vc. CUTTING SPEED
- Vc. SCHNITTGESCHWINDIGKEIT
- Vc. VITESSE DE COUPE

- DETTAGLIO RICAMBI
- SPARE PARTS DETAILS
- DETAILS ZU DEN ERSATZTEILEN
- DÉTAIL DE PIÈCES DE RECHANGE

- DATI TECNICI E CONSIGLI
- TECHNICAL DATA AND SUGGESTIONS
- TECHNISCHE DATEN UND EMPFEHLUNGEN
- DONNÉES TECHNIQUES ET CONSEILS

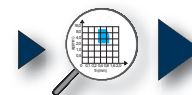

PAG. 226



PAG. 222



PAG. 1103



PAG. 1126

B..SDUCR/L

Ø20 - Ø32

93°

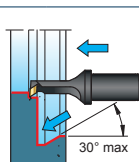
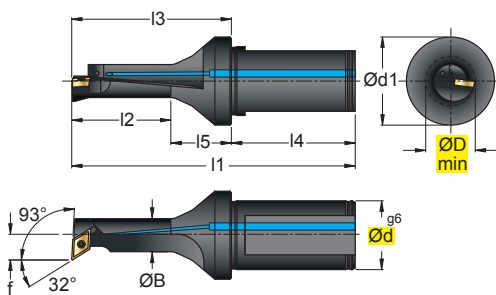

DC.T



DC.W



S

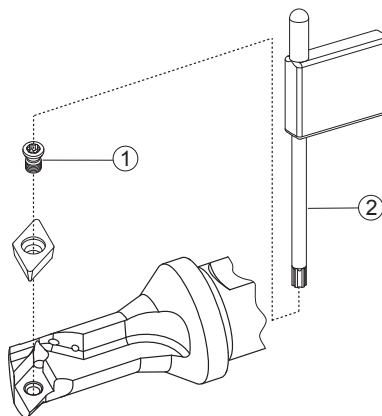

PAG. 226



PAG. 222



PAG. 1103



PAG. 1126

In figura utensile destro - Right-hand shown

															 INSERTI - INSERTS PAG. 203
.G13	L.F45	R.F45	.F46	.F47	.B53	.G57P	.X47	.F32	.F33	.G39	.G42	.F51	.G52	.G32W	

ART.	(mm)																①			②		
		ØDmin	Ød	ØB	Ød1	f	l1	l2	l3	l4	l5	Nm										
B 20 1020 SDUCR/L 07		13	20	10	26	7	80	20	40	40	20	1,0+1,2	0702	12254P	5507P							
B 20 1030 SDUCR/L 07		13	20	10	26	7	90	30	50	40	20	1,0+1,2										
B 20 1224 SDUCR/L 07		16	20	12	26	9	84	24	44	40	20	1,1+1,3	0702	12256P	5508P							
B 20 1236 SDUCR/L 07		16	20	12	26	9	96	36	56	40	20	1,1+1,3										
B 20 1428 SDUCR/L 07		18	20	14	26	10	88	28	48	40	20	1,1+1,3										
B 20 1442 SDUCR/L 07		18	20	14	26	10	102	42	62	40	20	1,1+1,3										
B 20 1632 SDUCR/L 07		20	20	16	26	11	92	32	52	40	20	1,1+1,3										
B 20 1648 SDUCR/L 07		20	20	16	26	11	108	48	68	40	20	1,1+1,3										
B 20 1632 SDUCR/L 11		20	20	16	26	11	92	32	52	40	20	3,5+4,0	11T3	1440	5515							
B 20 1648 SDUCR/L 11		20	20	16	26	11	108	48	68	40	20	3,5+4,0										
B 25 1020 SDUCR/L 07		13	25	10	32	7	87	20	42	45	22	1,0+1,2	0702	12254P	5507P							
B 25 1030 SDUCR/L 07		13	25	10	32	7	97	30	52	45	22	1,0+1,2										
B 25 1224 SDUCR/L 07		16	25	12	32	9	91	24	46	45	22	1,1+1,3	0702	12256P	5508P							
B 25 1236 SDUCR/L 07		16	25	12	32	9	103	36	58	45	22	1,1+1,3										
B 25 1428 SDUCR/L 07		18	25	14	32	10	95	28	50	45	22	1,1+1,3										
B 25 1442 SDUCR/L 07		18	25	14	32	10	109	42	64	45	22	1,1+1,3										
B 25 1632 SDUCR/L 07		20	25	16	32	11	99	32	54	45	22	1,1+1,3										
B 25 1648 SDUCR/L 07		20	25	16	32	11	115	48	70	45	22	1,1+1,3										
B 25 1632 SDUCR/L 11		20	25	16	32	11	99	32	54	45	22	3,5+4,0	11T3	1440	5515							
B 25 1648 SDUCR/L 11		20	25	16	32	11	115	48	70	45	22	3,5+4,0										
B 25 2040 SDUCR/L 11		24	25	20	32	13	107	40	62	45	22	3,8+5,0	11T3	12409P	5515							
B 25 2060 SDUCR/L 11		24	25	20	32	13	127	60	82	45	22	3,8+5,0										
B 32 1020 SDUCR/L 07		13	32	10	43	7	92	20	44	48	24	1,0+1,2	0702	12254P	5507P							
B 32 1030 SDUCR/L 07		13	32	10	43	7	102	30	54	48	24	1,0+1,2										
B 32 1224 SDUCR/L 07		16	32	12	43	9	96	24	48	48	24	1,1+1,3	0702	12256P	5508P							
B 32 1236 SDUCR/L 07		16	32	12	43	9	108	36	60	48	24	1,1+1,3										
B 32 1428 SDUCR/L 07		18	32	14	43	10	100	28	52	48	24	1,1+1,3										
B 32 1442 SDUCR/L 07		18	32	14	43	10	114	42	66	48	24	1,1+1,3										
B 32 1632 SDUCR/L 07		20	32	16	43	11	104	32	56	48	24	1,1+1,3										
B 32 1648 SDUCR/L 07		20	32	16	43	11	120	48	72	48	24	1,1+1,3										
B 32 1632 SDUCR/L 11		20	32	16	43	11	104	32	56	48	24	3,5+4,0	11T3	1440	5515							
B 32 1648 SDUCR/L 11		20	32	16	43	11	120	48	72	48	24	3,5+4,0										
B 32 2040 SDUCR/L 11		24	32	20	43	13	112	40	64	48	24	3,8+5,0	11T3	12409P	5515							
B 32 2060 SDUCR/L 11		24	32	20	43	13	132	60	84	48	24	3,8+5,0										
B 32 2550 SDUCR/L 11		31	32	25	43	17	122	50	74	48	24	3,8+5,0										
B 32 2575 SDUCR/L 11		31	32	25	43	17	147	75	99	48	24	3,8+5,0										

A..SDQCR/L

Ø10 - Ø16

107,5°

In figura utensile destro - Right-hand shown

S..SDQCR/L

Ø10 - Ø16

107,5°

In figura utensile destro - Right-hand shown



ART.	(mm)										Nm	1		2	
	ØDmin	Ød	f	a	H	l1	l2	1	2	1		2			
A0810H SDQCR/L 07	12,5	10	7	3	9	100	22	1,0+1,2	0702	12254P	5507P				
A1012K SDQCR/L 07	15,5	12	9	4	11	125	28	1,0+1,2							
A1216M SDQCR/L 07	19,5	16	11	5	15	150	36	1,0+1,2							

S0810H SDQCR/L 07	12,5	10	7	3	9	100	22	1,0+1,2	0702	12254P	5507P		
S1012K SDQCR/L 07	15,5	12	9	4	11	125	28	1,0+1,2					
S1216M SDQCR/L 07	19,5	16	11	5	15	150	36	1,0+1,2					

SENZA FORO DI ADDUZIONE REFRIGERANTE
 WITHOUT COOLANT FEED
 OHNE KÜLMITTELZUFUHR
 SANS ABDUCTION DU RÉFRIGÉRANTE

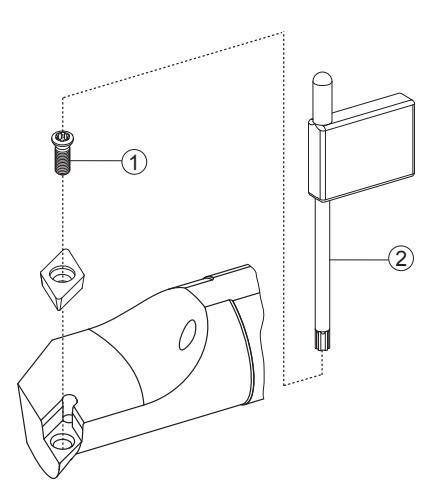

- CAMPI D'IMPIEGO DEGLI INSERTI PER TORNITURA
 - FIELDS OF APPLICATION FOR TURNING INSERTS
 - EINSATZGEBIETE FÜR DREHPLATTEN
 - CHAMPS D'USINAGE DES PLAQUETTES POUR TOURNAGE
-
- VELOCITÀ DI TAGLIO Vc
 - Vc. CUTTING SPEED
 - Vc. SCHNITTGESCHWINDIGKEIT
 - Vc. VITESSE DE COUPE
-
- DETTAGLIO RICAMBI
 - SPARE PARTS DETAILS
 - DETAILS ZU DEN ERSATZTEILEN
 - DÉTAIL DE PIÈCES DE RECHANGE
-
- DATI TECNICI E CONSIGLI
 - TECHNICAL DATA AND SUGGESTIONS
 - TECHNISCHE DATEN UND EMPFEHLUNGEN
 - DONNÉES TECHNIQUES ET CONSEILS

PAG. 226

PAG. 222

PAG. 1103

PAG. 1126

A..SDQCR/L

Ø12 - Ø32

107,5°

SEZ. A-A

In figura utensile destro - Right-hand shown

E..SDQCR/L..N

Ø10 - Ø20

107,5° NEW

SEZ. A-A

In figura utensile destro - Right-hand shown

DC.T

DC.W

S

																			 INSERTI - INSERTS PAG. 203
.G13	L.F45	R.F45	.F46	.F47	.B53	.G57P	.X47	.F32	.F33	.G39	.G42	.F51	.G52	.G32W					

ART.		(mm)									① ② ③ ④				
		ØDmin	Ød	f	H	l1	Nm								
A12K	SDQCR/L 07	16	12	9	11,50	125	1,1+1,3	0702	-	-	12256P	5508P			
A16M	SDQCR/L 07	20	16	11	15,25	150	1,1+1,3								
A20Q	SDQCR/L 07	25	20	13	19,00	180	1,1+1,3								
A20Q	SDQCR/L 11	25	20	13	19,00	180	3,8+5,0	11T3	-	-	12409P	5515P			
A25R	SDQCR/L 11	32	25	17	24,00	200	3,8+5,0	11T3	-	-	1240P	5515P			
A32S	SDQCR/L 11	40	32	22	31,00	250	3,0+3,5	11T3	3711	BCL7	123511P	5515P			

E10K	SDQCR/L 07N	13	10	7,0	-	125	10,0	1,1+1,3	0702	-	-	12256P	5508P	
E12M	SDQCR/L 07N	16	12	8,5	-	150	12,5	1,1+1,3						
E16R	SDQCR/L 07N	20	16	10,0	-	200	16,5	1,1+1,3						
E20S	SDQCR/L 11N	25	20	12,5	-	250	13,0	3,8+5,0	11T3	-	-	12409P	5515P	

UTENSILI CON STELO IN METALLO DURO
 TOOLS WITH CARBIDE SHAFT
 WERKZEUGE MIT HM-SCHAFT
 OUTILS AVEC QUEUE EN METAL DUR

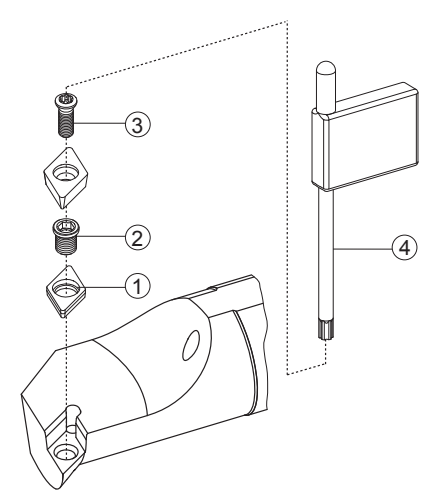

- CAMPI D'IMPIEGO DEGLI INSERTI PER TORNITURA
 - FIELDS OF APPLICATION FOR TURNING INSERTS
 - EINSATZGEBIETE FÜR DREHPLATTEN
 - CHAMPS D'USINAGE DES PLAQUETTES POUR TOURNAGE
-
- VELOCITÀ DI TAGLIO Vc
 - Vc. CUTTING SPEED
 - Vc. SCHNITTGESCHWINDIGKEIT
 - Vc. VITESSE DE COUPE
-
- DETTAGLIO RICAMBI
 - SPARE PARTS DETAILS
 - DETAILS ZU DEN ERSATZTEILEN
 - DÉTAIL DE PIÈCES DE RECHANGE
-
- DATI TECNICI E CONSIGLI
 - TECHNICAL DATA AND SUGGESTIONS
 - TECHNISCHE DATEN UND EMPFEHLUNGEN
 - DONNÉES TECHNIQUES ET CONSEILS

PAG. 226

PAG. 222

PAG. 1103

PAG. 1126

A..SDNCR/L

Ø16 - Ø25

63°

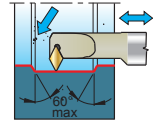
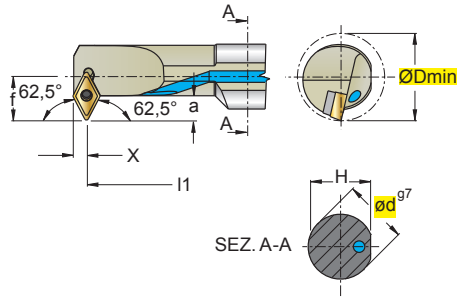

DC.T



DC.W



S



In figura utensile destro - Right-hand shown

ART.	(mm)										1	2	●	●	●					
	NEW	NEW	NEW	NEW				NEW	NEW											
	.G13	L.F45	R.F45	.F46	.F47	.B53	.G57P	.X47	.F32	.F33	.G39	.G42	.F51	.G52	.G32W	INSERTI - INSERTS PAG. 203				
											1	2	●	●	●					
											1	2	●	●	●					
											1	2	●	●	●					
											1	2	●	●	●					
A16M	SDNCR/L	07	20	16	11	6	15,25	150	3,50	1,1+1,3	0702	12256P	5508P							
A20Q	SDNCR/L	11	25	20	15	9	19,00	180	5,25	3,8+5,0	11T3	12409P	5515P							
A25R	SDNCR/L	11	32	25	17	9	24,00	200	5,25	3,8+5,0	11T3	1240P	5515P							

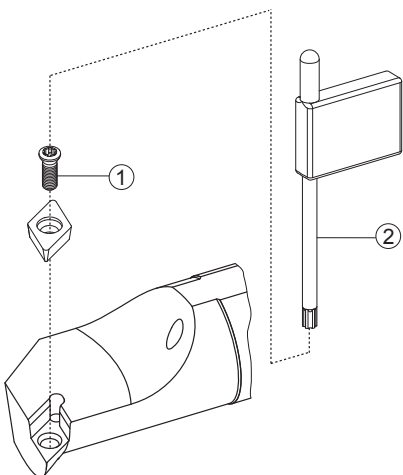

CAMPI D'IMPIEGO DEGLI INSERTI PER TORNITURA
 FIELDS OF APPLICATION FOR TURNING INSERTS
 EINSATZGEBIETE FÜR DREHPLATTEN
 CHAMPS D'USINAGE DES PLAQUETTES POUR TOURNAGE

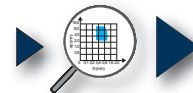

PAG. 226

VELOCITÀ DI TAGLIO Vc
 Vc. CUTTING SPEED
 Vc. SCHNITTGESCHWINDIGKEIT
 Vc. VITESSE DE COUPE



PAG. 222

DETTAGLIO RICAMBI
 SPARE PARTS DETAILS
 DETAILS ZU DEN ERSATZTEILEN
 DÉTAIL DE PIÈCES DE RECHANGE



PAG. 1103

DATI TECNICI E CONSIGLI
 TECHNICAL DATA AND SUGGESTIONS
 TECHNISCHE DATEN UND EMPFEHLUNGEN
 DONNÉES TECHNIQUES ET CONSEILS



PAG. 1126

A..SDXCR/L

Ø12 - Ø25

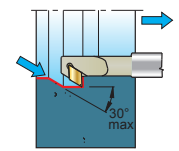
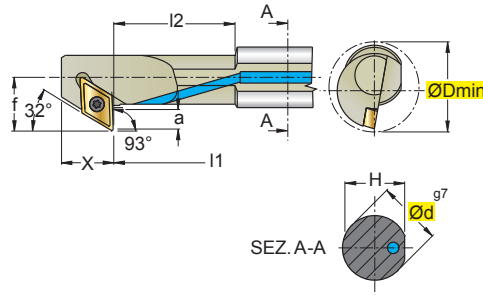

DC.T



DC.W

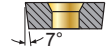

S



In figura utensile destro - Right-hand shown

																	INSERTI - INSERTS PAG. 203
.G13	L.F45	R.F45	.F46	.F47	.B53	.G57P	.X47	.F32	.F33	.G39	.G42	.F51	.G52	.G32W			

ART.	ØDmin	Ød	f	a	H	l1	l2	X	Nm		①		②			
A12K SDXCR/L 07	16	12	11,0	5,0	11,50	125	25	11	1,1+1,3	0702		12256P	5508P			
A16M SDXCR/L 07	20	16	13,0	5,0	15,25	150	35	11	1,1+1,3							
A20Q SDXCR/L 11	25	20	16,5	6,5	19,00	180	40	15	3,8+5,0	11T3		12409P	5515P			
A25R SDXCR/L 11	32	25	19,0	6,5	24,00	200	50	15	3,8+5,0							

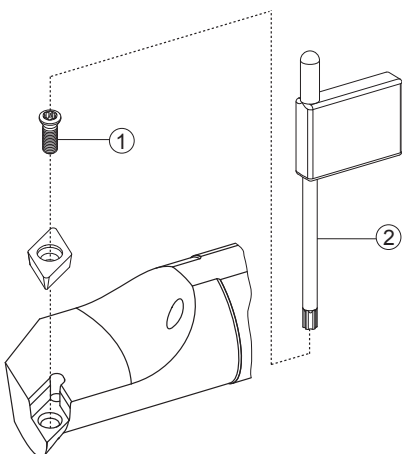

CAMPI D'IMPIEGO DEGLI INSERTI PER TORNITURA
 FIELDS OF APPLICATION FOR TURNING INSERTS
 EINSATZGEBIETE FÜR DREHPLATTEN
 CHAMPS D'USINAGE DES PLAQUETTES POUR TOURNAGE

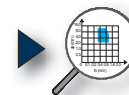

PAG. 226

VELOCITÀ DI TAGLIO Vc
 Vc. CUTTING SPEED
 Vc. SCHNITTGESCHWINDIGKEIT
 Vc. VITESSE DE COUPE



PAG. 222

DETTAGLIO RICAMBI
 SPARE PARTS DETAILS
 DETAILS ZU DEN ERSATZTEILEN
 DÉTAIL DE PIÈCES DE RECHANGE



PAG. 1103

DATI TECNICI E CONSIGLI
 TECHNICAL DATA AND SUGGESTIONS
 TECHNISCHE DATEN UND EMPFEHLUNGEN
 DONNÉES TECHNIQUES ET CONSEILS



PAG. 1126

A..STUCR/L							A..STFCR/L						
Ø12 - Ø32							Ø10 - Ø40						
93°							90°						
TC.T							TC.T						
TC.W							TC.W						
S							S						
In figura utensile destro - Right-hand shown							In figura utensile destro - Right-hand shown						
.G39 .G57P .X37 .X47 .G39 .S42 .G52							INSERTI - INSERTS PAG. 206						
ART.		(mm)					Nm		1	2	3	4	5
		ØDmin	Ød	f	H	l1							
A12K	STUCR/L	11	16	12	9	11,50	125	1,1+1,3	1102	-	-	12256P	5508P
A16M	STUCR/L	16	20	16	11	15,25	150	3,8+5,0	16T3	-	-	12409P	5515P
A20Q	STUCR/L	16	25	20	13	19,00	180	3,8+5,0	16T3	-	-	1240P	5515P
A25R	STUCR/L	16	32	25	17	24,00	200	3,8+5,0					
A32S	STUCR/L	16	40	32	22	31,00	250	3,0+3,5	16T3	3415	BCL7	123511P	5515P
A10H	STFCR/L	09	12	10	7	9,50	100	0,9+1,0	0902	-	-	12225P	5507P
A10H	STFCR/L	11	12	10	7	9,50	100	1,1+1,3	1102	-	-	12256P	5508P
A12K	STFCR/L	11	16	12	9	11,50	125	1,1+1,3					
A16M	STFCR/L	11	20	16	11	15,25	150	1,1+1,3					
A16M	STFCR/L	16	20	16	11	15,25	150	3,8+5,0	16T3	-	-	12409P	5515P
A20Q	STFCR/L	16	25	20	13	19,00	180	3,8+5,0	16T3	-	-	1240P	5515P
A25R	STFCR/L	16	32	25	17	24,00	200	3,8+5,0					
A32S	STFCR/L	16	40	32	22	31,00	250	3,0+3,5	16T3	3415	BCL7	123511P	5515P
A40T	STFCR/L	16	50	40	27	38,50	300	3,0+3,5					

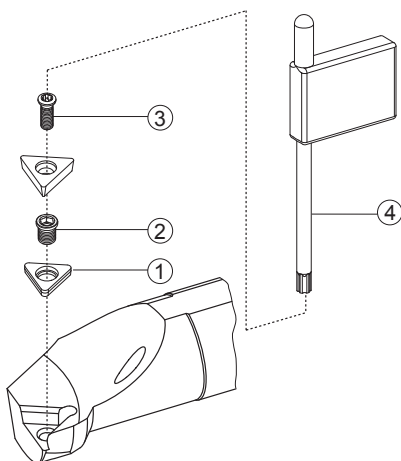

CAMPI D'IMPIEGO DEGLI INSERTI PER TORNITURA
 FIELDS OF APPLICATION FOR TURNING INSERTS
 EINSATZGEBIETE FÜR DREHPLATTEN
 CHAMPS D'USINAGE DES PLAQUETTES POUR TOURNAGE

VELOCITÀ DI TAGLIO Vc
 Vc. CUTTING SPEED
 Vc. SCHNITTGESCHWINDIGKEIT
 Vc. VITESSE DE COUPE

DETTAGLIO RICAMBI
 SPARE PARTS DETAILS
 DETAILS ZU DEN ERSATZTEILEN
 DÉTAIL DE PIÈCES DE RECHANGE

DATI TECNICI E CONSIGLI
 TECHNICAL DATA AND SUGGESTIONS
 TECHNISCHE DATEN UND EMPFEHLUNGEN
 DONNÉES TECHNIQUES ET CONSEILS

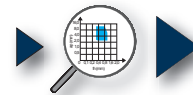

PAG. 226



PAG. 222



PAG. 1103



PAG. 1126

E..STFCR/L..N

Ø10 - Ø20

90°

NEW

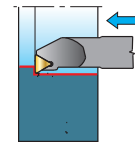
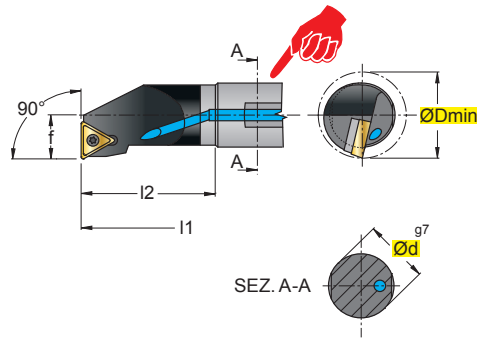

TC.T



TC.W

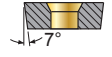

S



In figura utensile destro - Right-hand shown

																INSERTI - INSERTS PAG. 206
.G39	.G57P	.X37	.X47	.G39	.S42	.G52										

ART.	(mm)							Nm			
		ØDmin	Ød	f	l1	l2	1			2	
E10K STFCR/L 11N		12	10	6	125	16	1,1+1,3	1102	12256P	5508P	
E12M STFCR/L 11N		15	12	8	150	20	1,1+1,3				
E16R STFCR/L 11N		19	16	10	200	25	1,1+1,3				
E20S STFCR/L 16N		24	20	12	250	32	3,8+5,0	16T3	1240P	5515P	

UTENSILI CON STELO IN METALLO DURO
TOOLS WITH CARBIDE SHAFT
WERKZEUGE MIT HM-SCHAFT
OUTILS AVEC QUEUE EN METAL DUR

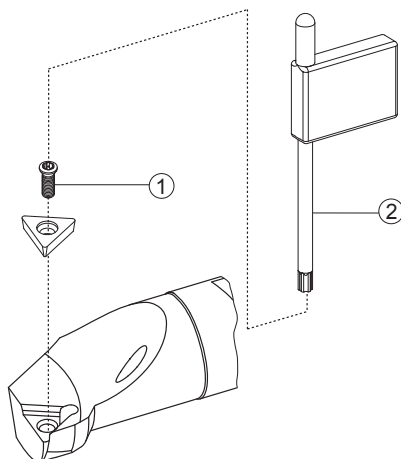

CAMPI D'IMPIEGO DEGLI INSERTI PER TORNITURA
FIELDS OF APPLICATION FOR TURNING INSERTS
EINSATZGEBIETE FÜR DREHPLATTEN
CHAMPS D'USINAGE DES PLAQUETTES POUR TOURNAGE

PAG. 226

VELOCITÀ DI TAGLIO Vc
Vc. CUTTING SPEED
Vc. SCHNITTGESCHWINDIGKEIT
Vc. VITESSE DE COUPE

PAG. 222

DETTAGLIO RICAMBI
SPARE PARTS DETAILS
DETAILS ZU DEN ERSATZTEILEN
DÉTAIL DE PIÈCES DE RECHANGE

PAG. 1103

DATI TECNICI E CONSIGLI
TECHNICAL DATA AND SUGGESTIONS
TECHNISCHE DATEN UND EMPFEHLUNGEN
DONNÉES TECHNIQUES ET CONSEILS

PAG. 1126

A..SVOCR/L

Ø12 - Ø25

140°

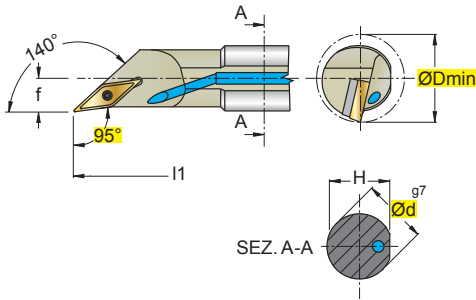

In figura utensile destro - Right-hand shown

.G13	.G57P	.F46	.F47	.X47	.F32	.F33	.G42	.G52													INSERTI - INSERTS PAG. 207	
ART.		(mm)																				
		ØDmin	Ød	f	H	l1	Nm			1	2	3	4	5								
A12K	SVOCR/L	11	16	12	9	11,5	125	1,1+1,3	1103	-	-	12256P	5508P									
A16M	SVOCR/L	11	20	16	11	15	150	1,1+1,3														
A20Q	SVOCR/L	16	23	20	12,5	19	180	3,0+3,5	1604	-	-	123509P	5515P									
A25R	SVOCR/L	16	30	25	16,5	24	200	3,0+3,5														

Lavorazione senza preforo
Machining a workpiece without prepared hole.

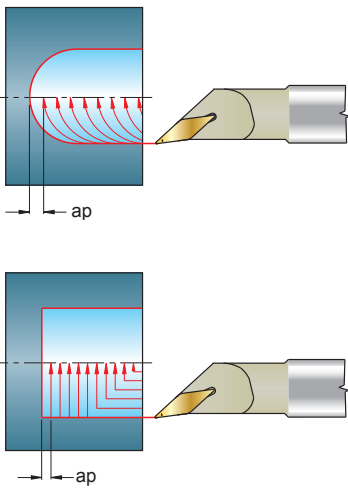

Lavorazione con preforo
Machining a workpiece with prepared hole.

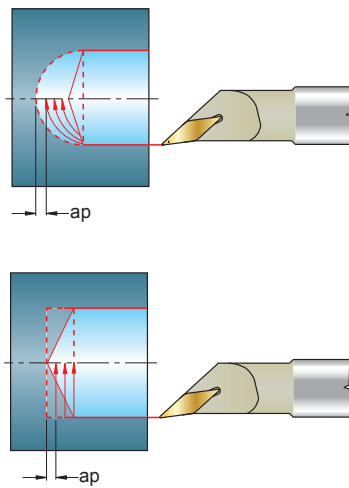

Fate attenzione che il tagliente non superi l'asse di rotazione X
Make sure the cutting edge does not surpass the X rotation axis

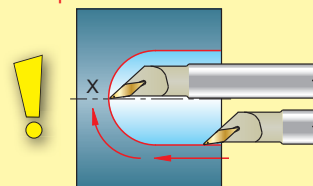

La profondità di passata ap deve essere inferiore al raggio inserto
Cutting depth ap must be lower than insert radius

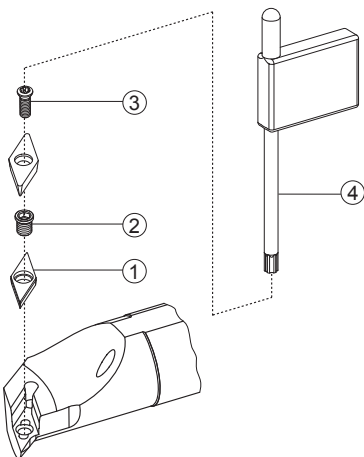
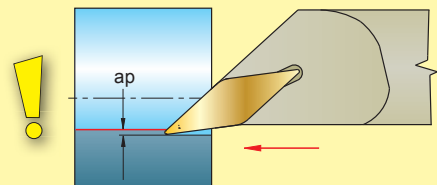

CAMPI D'IMPIEGO DEGLI INSERTI PER TORNITURA
 FIELDS OF APPLICATION FOR TURNING INSERTS
 EINSATZGEBIETE FÜR DREHPLATTEN
 CHAMPS D'USINAGE DES PLAQUETTES POUR TOURNAGE

VELOCITÀ DI TAGLIO Vc
 Vc. CUTTING SPEED
 Vc. SCHNITTGESCHWINDIGKEIT
 Vc. VITESSE DE COUPE

DETTAGLIO RICAMBI
 SPARE PARTS DETAILS
 DETAILS ZU DEN ERSATZTEILEN
 DÉTAIL DE PIÈCES DE RECHANGE

DATI TECNICI E CONSIGLI
 TECHNICAL DATA AND SUGGESTIONS
 TECHNISCHE DATEN UND EMPFEHLUNGEN
 DONNÉES TECHNIQUES ET CONSEILS

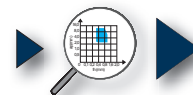

PAG. 226



PAG. 222



PAG. 1103



PAG. 1126

A..SVUCR/L

Ø16 - Ø40

93°

In figura utensile destro - Right-hand shown

E..SVUCR/L..N

Ø16 - Ø20

93° NEW

In figura utensile destro - Right-hand shown

VC.T

VC.W

S

INSERTI - INSERTS
PAG. 207

ART.		(mm)												
ØDmin	Ød	f	H	l1	l2	Nm	1	2	3	4				
.G13	.G57P	NEW .F46	NEW .F47	.X47	NEW .F32	NEW .F33	.G42	.G52						
A16M	SVUCR/L	11	21	16	12	15,25	150	-	1,1+1,3	1103	-	-	12256P	5508P
A20Q	SVUCR/L	11	25	20	13	19,00	180	-	1,1+1,3					
A25R	SVUCR/L	16	32	25	17	24,00	200	-	3,0+3,5	1604	-	-	123509P	5515P
A32S	SVUCR/L	16	40	32	22	31,00	250	-	3,0+3,5	1604	3716	BCL7	123511P	5515P
A40T	SVUCR/L	16	50	40	27	38,50	300	-	3,0+3,5					
E16R	SVUCR/L	11N	21	16	11	-	200	16,5	1,1+1,3	1103	-	-	12256P	5508P
E20S	SVUCR/L	11N	25	20	13	-	250	20,5	1,1+1,3					

UTENSILI CON STELO IN METALLO DURO
 TOOLS WITH CARBIDE SHAFT
 WERKZEUGE MIT HM-SCHAFT
 OUTILS AVEC QUEUE EN METAL DUR

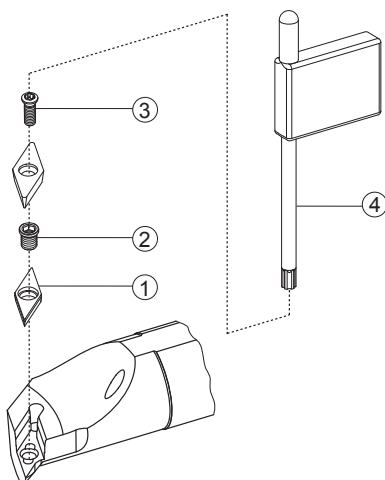

CAMPI D'IMPIEGO DEGLI INSERTI PER TORNITURA
 FIELDS OF APPLICATION FOR TURNING INSERTS
 EINSATZGEBIETE FÜR DREHPLATTEN
 CHAMPS D'USINAGE DES PLAQUETTES POUR TOURNAGE

VELOCITÀ DI TAGLIO Vc
 Vc. CUTTING SPEED
 Vc. SCHNITTGESCHWINDIGKEIT
 Vc. VITESSE DE COUPE

DETTAGLIO RICAMBI
 SPARE PARTS DETAILS
 DETAILS ZU DEN ERSATZTEILEN
 DÉTAIL DE PIÈCES DE RECHANGE

DATI TECNICI E CONSIGLI
 TECHNICAL DATA AND SUGGESTIONS
 TECHNISCHE DATEN UND EMPFEHLUNGEN
 DONNÉES TECHNIQUES ET CONSEILS

PAG. 226

PAG. 222

PAG. 1103

PAG. 1126

A..SVXCR/L										A..SVQCR/L									
Ø16 - Ø25										Ø16 - Ø40									
In figura utensile destro - Right-hand shown										In figura utensile destro - Right-hand shown									
.G13 .G57P .F46 .F47 .X47 .F32 .F33 .G42 .G52										 INSERTI - INSERTS PAG. 207									
ART.																			
(mm)																			
ØDmin										Ød									
f										H									
l1										Nm									
1										2									
3										4									
A16M SVXCR/L 11										20 16 11 15,25 150 1,1+1,3 1103									
A20Q SVXCR/L 11										25 20 13 19,00 180 1,1+1,3 1103									
A25R SVXCR/L 16										32 25 17 24,00 200 3,0+3,5 1604									
A16M SVQCR/L 11										20 16 11 15,25 150 1,1+1,3 1103									
A20Q SVQCR/L 11										25 20 13 19,00 180 1,1+1,3 1103									
A25R SVQCR/L 16										32 25 17 24,00 200 3,0+3,5 1604									
A32S SVQCR/L 16										40 32 22 31,00 250 3,0+3,5 1604									
A40T SVQCR/L 16										50 40 27 38,50 300 3,0+3,5 1604									

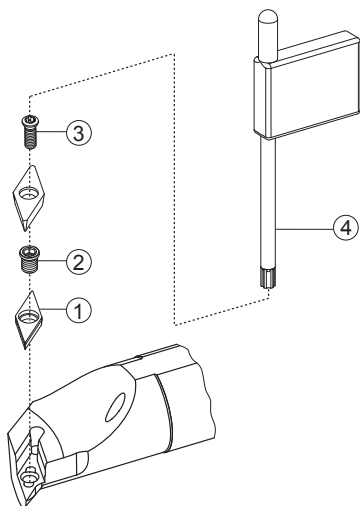

CAMPI D'IMPIEGO DEGLI INSERTI PER TORNITURA
 FIELDS OF APPLICATION FOR TURNING INSERTS
 EINSATZGEBIETE FÜR DREHPLATTEN
 CHAMPS D'USINAGE DES PLAQUETTES POUR TOURNAGE

VELOCITÀ DI TAGLIO Vc
 Vc. CUTTING SPEED
 Vc. SCHNITTGESCHWINDIGKEIT
 Vc. VITESSE DE COUPE

DETTAGLIO RICAMBI
 SPARE PARTS DETAILS
 DETAILS ZU DEN ERSATZTEILEN
 DÉTAIL DE PIÈCES DE RECHANGE

DATI TECNICI E CONSIGLI
 TECHNICAL DATA AND SUGGESTIONS
 TECHNISCHE DATEN UND EMPFEHLUNGEN
 DONNÉES TECHNIQUES ET CONSEILS

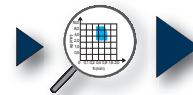

PAG. 226



PAG. 222



PAG. 1103



PAG. 1126

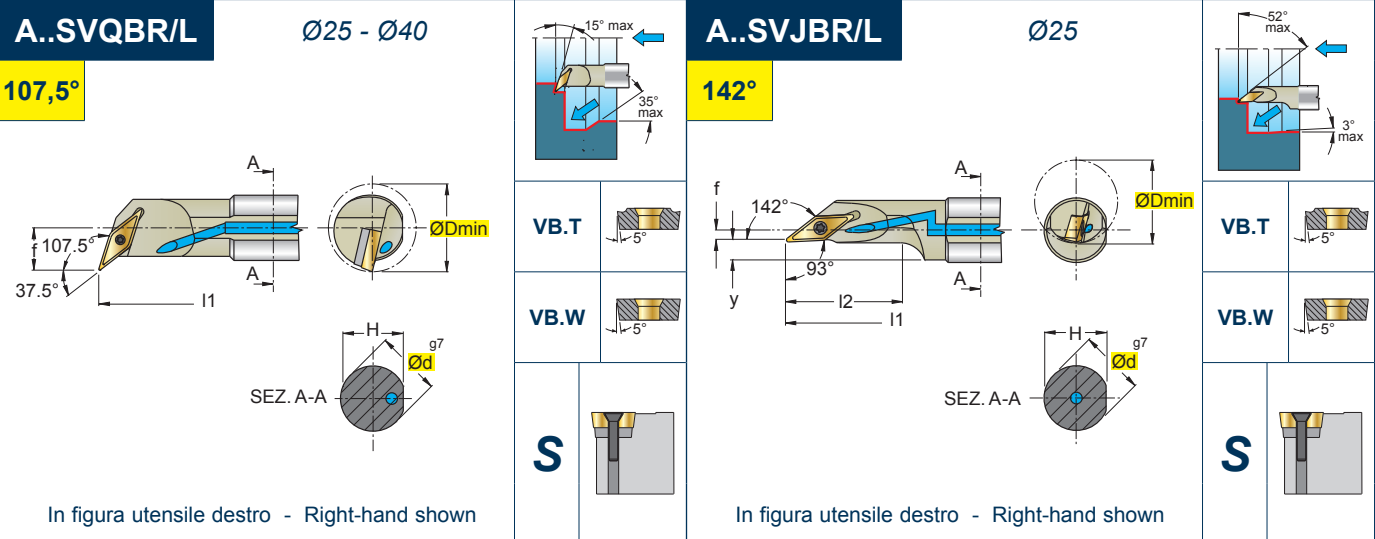

																					INSERTI - INSERTS PAG. 207		
ART. (mm)																			1	2	3	4	
A25R	SVQBR/L	16	32	25	17	24,0	200	-	-	3,0+3,5	1604	-	-	123509P	5515P								
A32S	SVQBR/L	16	40	32	22	31,0	250	-	-	3,0+3,5	1604	3716	BCL7	123511P	5515P								
A40T	SVQBR/L	16	50	40	27	38,5	300	-	-	3,0+3,5													
A25R	SVJBR/L	16	32	25	4,6	24	200	44	7	1,1+1,3	1604	-	-	123509P	5515P								

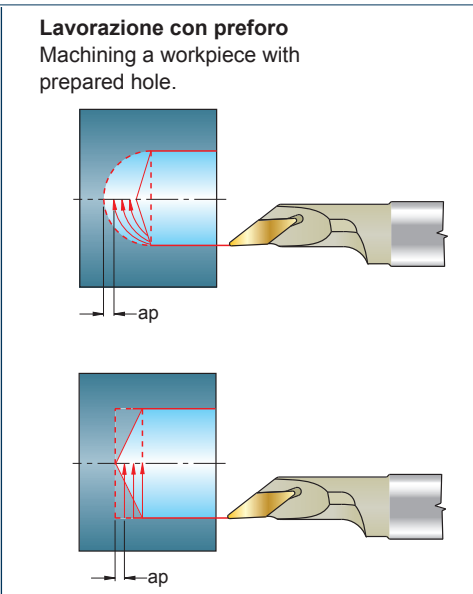
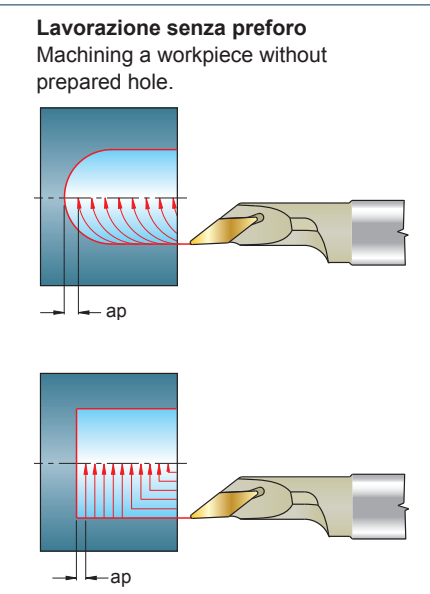

Fate attenzione che il tagliente non superi l'asse di rotazione X
Make sure the cutting edge does not surpass the X rotation axis

La profondità di passata ap deve essere inferiore al raggio inserto
Cutting depth ap must be lower than insert radius

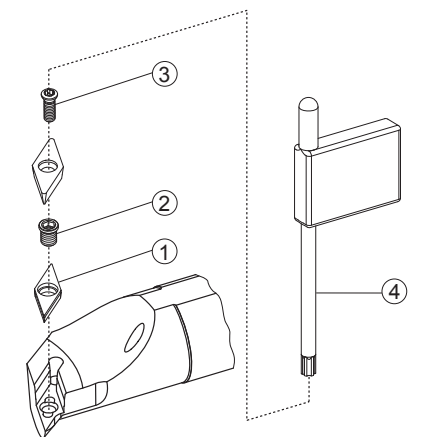

- CAMPI D'IMPIEGO DEGLI INSERTI PER TORNITURA
FIELDS OF APPLICATION FOR TURNING INSERTS
EINSATZGEBIETE FÜR DREHPLATTEN
CHAMPS D'USINAGE DES PLAQUETTES POUR TOURNAGE
- VELOCITÀ DI TAGLIO Vc
Vc. CUTTING SPEED
Vc. SCHNITTGESCHWINDIGKEIT
Vc. VITESSE DE COUPE
- DETTAGLIO RICAMBI
SPARE PARTS DETAILS
DETAILS ZU DEN ERSATZTEILEN
DÉTAIL DE PIÈCES DE RECHANGE
- DATI TECNICI E CONSIGLI
TECHNICAL DATA AND SUGGESTIONS
TECHNISCHE DATEN UND EMPFEHLUNGEN
DONNÉES TECHNIQUES ET CONSEILS

PAG. 226

Vc **PAG. 222**

PAG. 1103

PAG. 1126

A..SSKCR/L

Ø16 - Ø25

75°

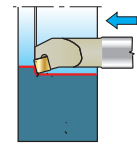
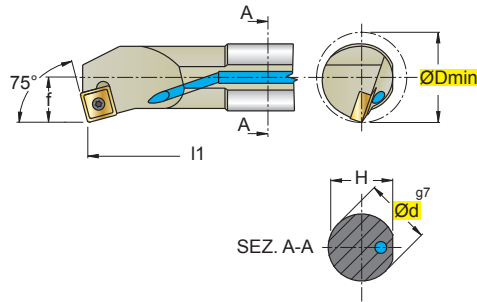

SC.T

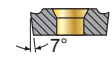

SC.W

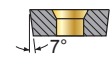

S







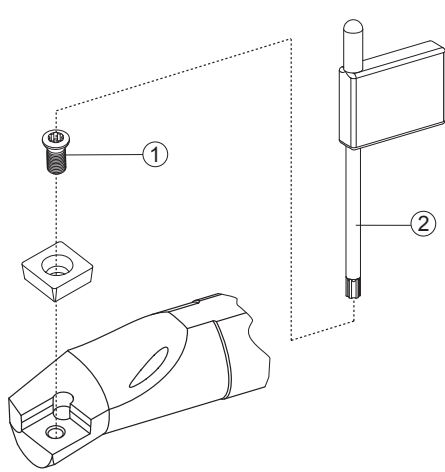













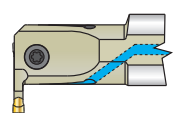
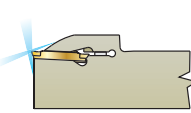
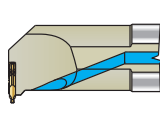



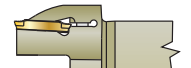

In figura utensile destro - Right-hand shown

NEW		NEW																		 INSERTI - INSERTS PAG. 205	
.F51		.G57		.G57P		.G52															
ART.		(mm)																			
A16M	SSKCR/L	09	20	16	11	15,25	150	3,8+5,0	09T3	12409P	5515P										
A20Q	SSKCR/L	09	25	20	13	19,00	180	3,8+5,0	09T3	12409P	5515P										
A25R	SSKCR/L	12	32	25	17	24,00	200	4,0+5,0	1204	124510P	5520P										

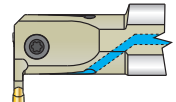



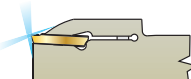



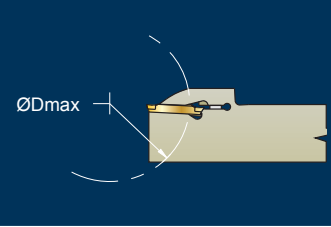
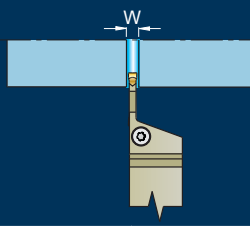
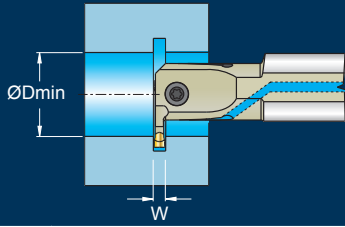

- CAMPI D'IMPIEGO DEGLI INSERTI PER TORNITURA
 FIELDS OF APPLICATION FOR TURNING INSERTS
 EINSATZGEBIETE FÜR DREHPLATTEN
 CHAMPS D'USAGE DES PLAQUETTES POUR TOURNAGE
- VELOCITÀ DI TAGLIO Vc
 Vc. CUTTING SPEED
 Vc. SCHNITTGESCHWINDIGKEIT
 Vc. VITESSE DE COUPE
- DETTAGLIO RICAMBI
 SPARE PARTS DETAILS
 DETAILS ZU DEN ERSATZTEILEN
 DÉTAIL DE PIÈCES DE RECHANGE
- DATI TECNICI E CONSIGLI
 TECHNICAL DATA AND SUGGESTIONS
 TECHNISCHE DATEN UND EMPFEHLUNGEN
 DONNÉES TECHNIQUES ET CONSEILS

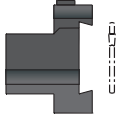
- PAG. 226
- PAG. 222
- PAG. 1103
- PAG. 1126

TRL Pag.138		TRCR/L Pag.140		TRWR/L Pag.144		STGR/L Pag.154	
							
ØDmax = 70 - 100		□ 16x16 - 25x25		□ 20x20 - 25x25		□ 20x20 - 25x25	
	TRL..N W=3,0-4,0		G..N14,5 W=2-4		G..N14,5 W=2-4		154.. W=1,1-4,15
		TRIR/L Pag.140		TRWR/L Pag.146		A..STIR/L Pag.154	
							
		ØDmin = 20 - 25		□ 20x20 - 25x25		ØDmin = 20 - 40	
			G..N14,5 W=2-4		GM25 W=3		154.. W=1,1-4,15
			G..N25 W=3-6		G..N25 W=3-6		
		TRCR/L Pag.142		TRFR/L Pag.148			
							
		□ 20x20 - 32x32		□ 25x25			
			GM25 W=3		GM25 W=3		
			G..N25 W=3-6		G..N25 W=3-6		
		TRIR/L Pag.142		TRCXR/L Pag.150			
							
		ØDmin = 32 - 57		□ 20x20 - 25x25			
			GM25 W=3		GM25 W=3		
			G..N25 W=3-6				
				TRWXR/L Pag.152			
							
				□ 20x20 - 25x25			
					GM25 W=3		



THE..-THS.. Pag.156		SCTFPR/L Pag.160		SGTBU Pag.162					
 <p>IN ESAURIMENTO END OF STOCK AUSLAUFEND EN ÉPUISEMENT</p>									
□ 8x8 - 25x25		□ 25x25							
	GIE../GP SG/GR/GW W=0,5-3,0		TPMR 1103 TPMR 1603 W=11 W=16,5		TRL				
THI.. Pag.158									
 <p>IN ESAURIMENTO END OF STOCK AUSLAUFEND EN ÉPUISEMENT</p>									
ØDmin = 38,10									
	GIE../GP SG/GR/GW W=0,5-3,0								

TRL

26 - 32

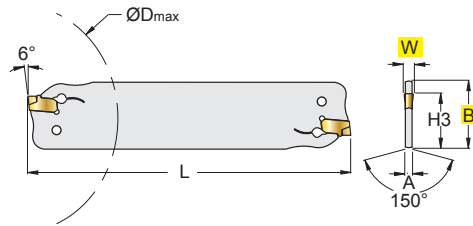
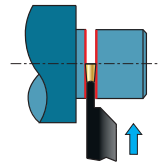
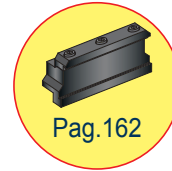

TRLN..



INSERTI - INSERTS
PAG. 239

.G52		.G56		.G57P																			
ART. (mm)																		○		○		○	
		W +0,1		B		A		ØDmax		L		H3											
TRL	26-30	3,0	26	2,4	70	110	21,4			3,0									CH-TRL30-40				
TRL	26-40	4,0	26	3,2	80	110	21,4			4,0									CH-TRL30-40				
TRL	32-30	3,0	32	2,4	100	150	25,0			3,0									CH-TRL30-40				
TRL	32-40	4,0	32	3,2	100	150	25,0			4,0									CH-TRL30-40				

CAMPI D'IMPIEGO DEGLI INSERTI PER TAGLIO-SCANALATURA
 FIELDS OF APPLICATION FOR PARTING AND GROOVING INSERTS
 EINSATZBEREICH FÜR ABSTECH- UND NUTENDREHWENDEPLATTEN
 CHAMPS D'USINAGE DES PLAQUETTES POUR TRONÇONNAGE-GORGES

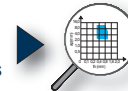

PAG. 250

VELOCITÀ DI TAGLIO Vc
 Vc. CUTTING SPEED
 Vc. SCHNITTGESCHWINDIGKEIT
 Vc. VITESSE DE COUPE



PAG. 248

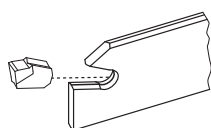

DETTAGLIO RICAMBI
 SPARE PARTS DETAILS
 DETAILS ZU DEN ERSATZTEILEN
 DÉTAIL DE PIÈCES DE RECHANGE



PAG. 1103

DATI TECNICI E CONSIGLI
 TECHNICAL DATA AND SUGGESTIONS
 TECHNISCHE DATEN UND EMPFEHLUNGEN
 DONNÉES TECHNIQUES ET CONSEILS



PAG. 1129

SCELTA VELOCE - QUICK PICK																				HT		HW	HC																	
Tenacità + ↑ ↑ Toughness - ↓ ↓ Pag. 242																				CERMET	NON RIV. CEMENTED CARBIDE GRADES	RIVESTITI COATED GRADES BESCHICHTET RECOUVERTS					W	r	a°											
																						T116	F4645	T5235																
COD.		P			M			K			N			S			H																							
		F	M	R	F	M	R	F	M	R	F	M	R	F	M	R	F	M	R	F	M	R																		
TRLN 3.00-0.20N .G52		○	●	●																			3,0*	0,2	0°															
TRLN 4.00-0.30N .G52		○	●	●																			4,0*	0,3	0°															
TRLN 3.00-0.30N .G56		○	●	●																			3,0*	0,3	0°															
TRLN 4.00-0.40N .G56		○	●	●																			4,0*	0,4	0°															
TRLN 3.00-0.30N .G57P											●	●	○										3,0*	0,3	0°															
TRLN 4.00-0.40N .G57P											●	●	○										4,0*	0,4	0°															
CON ADDUZIONE LUBROREFRIGERANTE - WITH COOLANT SUPPLY																				●	●	●																		
SENZA ADDUZIONE LUBROREFRIGERANTE - WITHOUT COOLANT SUPPLY																				○																				

MATERIALI - MATERIALS Pag. 1199		VDI 3323 GR.	HB Rm ⁽¹⁾ HRC ⁽²⁾	Vc m/min Pag. 248				
				T116	F4645	T5235		
P	ACCIAIO NON LEGATO - NOT ALLOY STEEL	1-5	125-300		130	150		
	ACCIAIO POCO LEGATO - LOW ALLOY STEEL	6-9	180-350		120	140		
	ACCIAIO ALTO LEGATO - ALLOY STEEL	10-11	200-325		90	130		
	INOX MARTENS. - STAINLESS STEEL MART	12-13	200-240		90	115		
M	INOX AUST. DUPLEX - STAINLESS STEEL AUST	14.1-14.2	180-230					
K	GHISA GRIGIA - GREY CAST IRON	15-16	180-260			130		
	GHISA SFEROIDALE - SPHEROIDAL GRAPHITE	17-18	160-250			120		
	GHISA MALLEABILE - MALLEABLE CAST IRON	19-20	130-230			130		
N	ALLUMINIO E SUE LEGHE - ALUMINIUM	21-25	60-130	600				
	RAME E SUE LEGHE - COPPER	26-28	90-110	400				
	NON METALLICI - PLASTICS	29-30	/	450				
S	LEGHE RESIST. CALORE - HIG. TEMP. ALLOY	31-35	200-320					
	TITANIO E SUE LEGHE - TITANIUM	36-37	400-1050 ⁽¹⁾					
H	ACCIAIO TEMPRATO - HARDENED STEEL	38-41	45-60 ⁽²⁾					

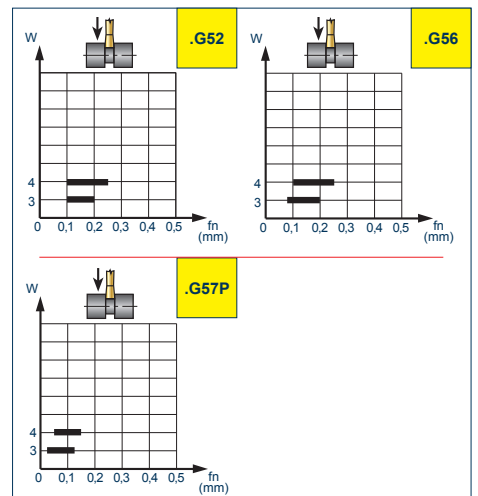

= SCANALATURA - GROOVING

- Vc = m/min VELOCITÀ DI TAGLIO - CUTTING SPEED
- n = giri/min (min⁻¹) NUMERO DI GIRI - NUMBER OF REVOLUTIONS
- fn = mm AVANZAMENTO AL GIRO - FEED / REVOLUTION
- Vf = mm/min VELOCITÀ DI AVANZAMENTO - FEED SPEED
- W = mm LARGHEZZA TAGLIANTE - CUTTING EDGE WIDTH

$$n = \frac{Vc \cdot 1000}{\varnothing D \cdot 3,14} = \text{giri/min (min}^{-1}\text{)}$$

$$Vf = fn \cdot n = \text{mm/min}$$

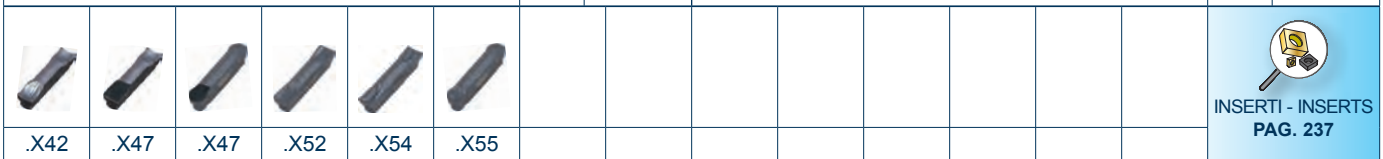
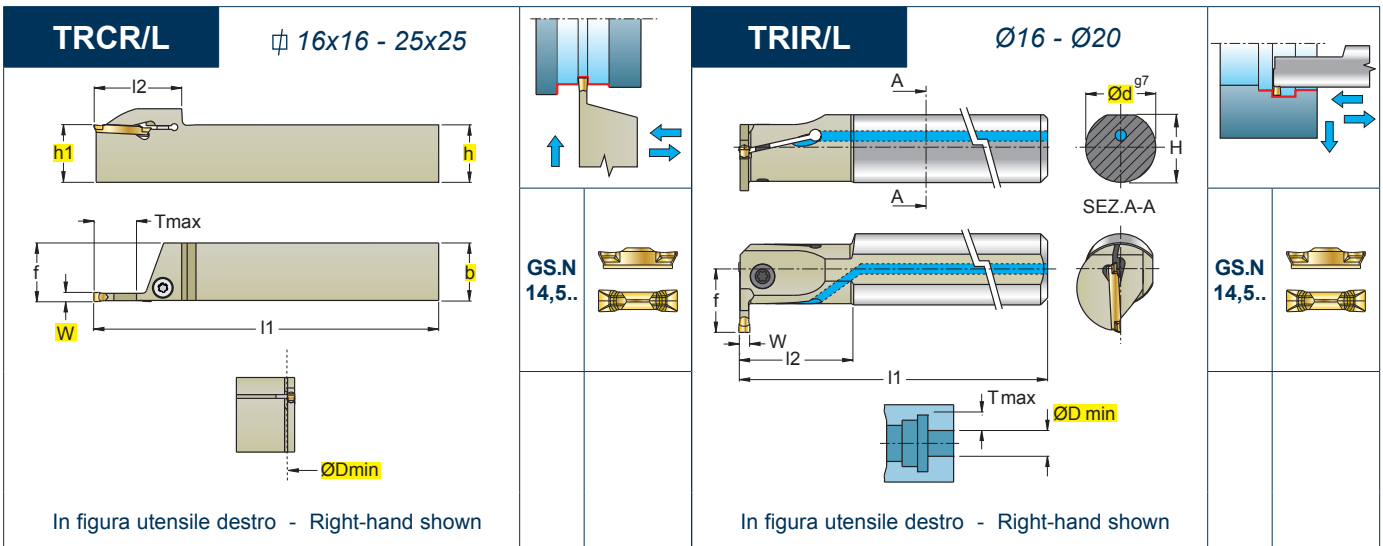

ART.		(mm)										①	②
		W	h=h1	b	ØDmin	f	Tmax	l1	l2	Nm			
TRCR/L	1616 14-2	2	16	16	800	16,3	12,5	125	31,5	5,0+6,0	GS..14.5.-2	VBZ 0412	5003
TRCR/L	1616 14-3	3	16	16	800	16,5	12,5	125	31,5	5,0+6,0	GS..14.5.-3	VBZ 0412	5003
TRCR/L	2020 14-2	2	20	20	1100	20,3	12,5	125	33,5	5,0+6,0	GS..14.5.-2	VBZ 0516	5004
TRCR/L	2020 14-3	3	20	20	1100	20,5	12,5	125	33,5	5,0+6,0	GS..14.5.-3	VBZ 0516	5004
TRCR/L	2020 14-4	4	20	20	1100	20,5	12,5	125	33,5	5,0+6,0	GS..14.5.-4	VBZ 0516	5004
TRCR/L	2525 14-2	2	25	25	1600	25,3	12,5	150	33,5	5,0+6,0	GS..14.5.-2	VBZ 0516	5004
TRCR/L	2525 14-3	3	25	25	1600	25,5	12,5	150	33,5	5,0+6,0	GS..14.5.-3	VBZ 0516	5004
TRCR/L	2525 14-4	4	25	25	1600	25,5	12,5	150	33,5	5,0+6,0	GS..14.5.-4	VBZ 0516	5004
ART.		(mm)										①	②
		W	Ød	ØDmin	f	H	Tmax	l1	l2	Nm			
TRIR/L	16 14-2	2	16	20	13,0	15,0	5,0	150,0	30	5,0+6,0	GS..14.5.-2	SM 523	5520
TRIR/L	16 14-3	3	16	20	13,0	15,0	5,0	150,0	30	5,0+6,0	GS..14.5.-3	SM 523	5520
TRIR/L	20 14-2	2	20	25	15,5	19,0	5,5	180,5	35	5,0+6,0	GS..14.5.-2	SM 521	5420
TRIR/L	20 14-3	3	20	25	15,5	19,0	5,5	180,5	35	5,0+6,0	GS..14.5.-3	SM 521	5420
TRIR/L	20 14-4	4	20	25	15,5	19,0	5,5	180,5	35	5,0+6,0	GS..14.5.-4	SM 521	5420

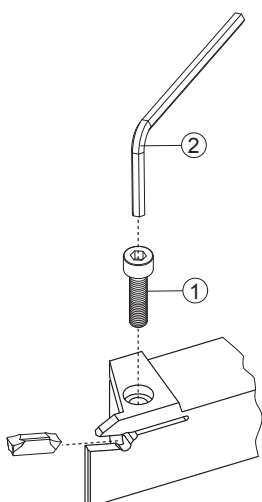

CAMPI D'IMPIEGO DEGLI INSERTI PER TAGLIO-SCANALATURA
 FIELDS OF APPLICATION FOR PARTING AND GROOVING INSERTS
 EINSATZBEREICH FÜR ABSTECH- UND NUTENDREHWENDEPLATTEN
 CHAMPS D'USINAGE DES PLAQUETTES POUR TRONÇONNAGE-GORGES



VELOCITÀ DI TAGLIO Vc
 Vc. CUTTING SPEED
 Vc. SCHNITTGESCHWINDIGKEIT
 Vc. VITESSE DE COUPE



DETTAGLIO RICAMBI
 SPARE PARTS DETAILS
 DETAILS ZU DEN ERSATZTEILEN
 DÉTAIL DE PIÈCES DE RECHANGE



DATI TECNICI E CONSIGLI
 TECHNICAL DATA AND SUGGESTIONS
 TECHNISCHE DATEN UND EMPFEHLUNGEN
 DONNÉES TECHNIQUES ET CONSEILS



SCelta VELOCE - QUICK PICK



Pag. 242

COD.	P		M		K		N		S		H		HT CERMET	HW NON RIV. CEMENTED CARBIDE GRADES	HC RIVESTITI COATED GRADES BESCHICHTET RECOUVERTS			DP PCD																				
	F	M	R	F	M	R	F	M	R	F	M	R			F	M	R		F	M	R	W	r	l	T	a°												
GMGN 14.5-0.2-2 .X47	●						●	●													2,0	0,2	14,5	1,5	8°													
GMGN 14.5-0.2-3 .X47	●						●	●													3,0	0,2	14,5	2,2	8°													
GMGN 14.5-0.4-4 .X47	●						●	●													4,0	0,4	14,5	3,2	8°													
GMGN 14.5R1.0-2 .X47	●						●	●													2,0	1,0	14,5	1,5	8°													
GMGN 14.5R1.5-3 .X47	●						●	●													3,0	1,5	14,5	2,2	8°													
GMGN 14.5R2.0-4 .X47	●						●	●													4,0	2,0	14,5	3,2	8°													
GSGN 14.5-0.2-2 .X42	○	●		○	●		○	○													2,0	0,2	14,5	1,5	10°													
GSGN 14.5-0.2-3 .X42	○	●		○	●		○	○													3,0	0,2	14,5	2,2	10°													
GSGN 14.5-0.4-4 .X42	○	●		○	●		○	○													4,0	0,4	14,5	3,2	10°													
GSGN 14.5-0.2-2 .X52	○	●		○	○		○	○													2,0	0,2	14,5	1,5	10°													
GSGN 14.5-0.2-3 .X52	○	●		○	○		○	○													3,0	0,2	14,5	2,2	10°													
GSGN 14.5-0.4-4 .X52	○	●		○	○		○	○													4,0	0,4	14,5	3,2	10°													
GSTN 14.5-0.2-2 .X54	○	●		○	○		○	○													2,0	0,2	14,5	1,5	10°													
GSTN 14.5-0.2-3 .X54	○	●		○	○		○	○													3,0	0,2	14,5	2,2	11°													
GSTN 14.5-0.3-4 .X54	○	●		○	○		○	○													4,0	0,3	14,5	3,2	11°													
GSTN 14.5R1.0-2 .X55	○	●		○	○		○	○													2,0	1,0	14,5	1,5	8°													
GSTN 14.5R1.5-3 .X55	○	●		○	○		○	○													3,0	1,5	14,5	2,2	8°													
GSTN 14.5R2.0-4 .X55	○	●		○	○		○	○													4,0	2,0	14,5	3,2	8°													
CON ADDUZIONE LUBROREFRIGERANTE - WITH COOLANT SUPPLY																																						
SENZA ADDUZIONE LUBROREFRIGERANTE - WITHOUT COOLANT SUPPLY																																						

MATERIALI - MATERIALS Pag. 1199		VDI 3323 GR.	HB Rm ¹⁾ HRC ²⁾	Vc m/min Pag. 248			
				D3007	F4530	T5735	F4645
P	ACCIAIO NON LEGATO - NOT ALLOY STEEL	1-5	125-300	140	150	130	
	ACCIAIO POCO LEGATO - LOW ALLOY STEEL	6-9	180-350	130	140	120	
	ACCIAIO ALTO LEGATO - ALLOY STEEL	10-11	200-325	100	115	90	
	INOX MARTENS. - STAINLESS STEEL MART	12-13	200-240	150	160	90	
M	INOX AUST. DUPLEX - STAINLESS STEEL AUST	14.1-14.2	180-230	100	120	100	
	GHISA GRIGIA - GREY CAST IRON	15-16	180-260	160	140		
	GHISA SFEROIDALE - SPHEROIDAL GRAPHITE	17-18	160-250	140	130		
K	GHISA MALLEABILE - MALLEABLE CAST IRON	19-20	130-230	140	115		
	ALUMINIO E SUE LEGHE - ALUMINIUM	21-25	60-130	700			
N	RAME E SUE LEGHE - COPPER	26-28	90-110	600			
	NON METALLICI - PLASTICS	29-30	/	800			

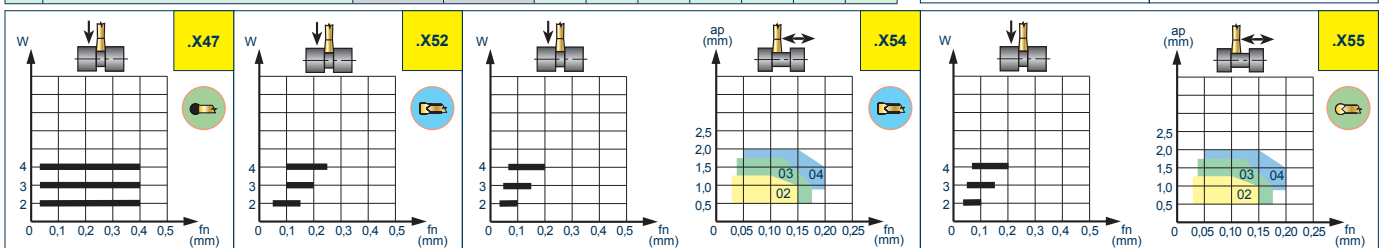
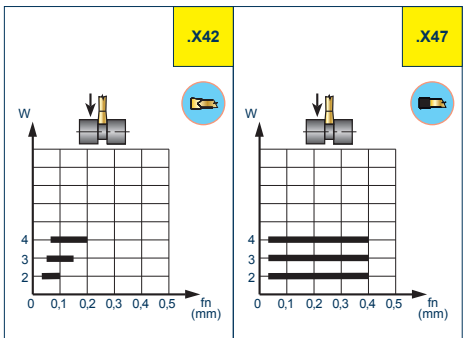

= SCANALATURA - GROOVING
Vc = m/min VELOCITÀ DI TAGLIO - CUTTING SPEED
n = giri/min (min⁻¹) NUMERO DI GIRI - NUMBER OF REVOLUTIONS
fn = mm AVANZAMENTO AL GIRO - FEED / REVOLUTION
Vf = mm/min VELOCITÀ DI AVANZAMENTO - FEED SPEED
W = mm LARGHEZZA TAGLIANTE - CUTTING EDGE WIDTH

TRCR/L

Ø 20x20 - 32x32

In figura utensile destro - Right-hand shown

TRIR/L

Ø25 - Ø40

In figura utensile destro - Right-hand shown

GM..
25..

GS.N
25..



ART.		(mm)												1	2
		W	h=h1	b	ØDmin	f	Tmax	l1	l2	Nm					
TRCR/L	2020 25-3	3	20	20	1100	20,5	22	125	38,5	5,0+6,0	GS..25..-3	VBZ 0516	5004		
TRCR/L	2020 25-4	4	20	20	1100	20,5	22	125	40,5	5,0+6,0	GS..25..-4	VBZ 0516	5004		
TRCR/L	2525 25-3	3	25	25	1600	25,5	22	150	38,5	5,0+6,0	GS..25..-3	VBZ 0516	5004		
TRCR/L	2525 25-4	4	25	25	1600	25,5	22	150	38,5	5,0+6,0	GS..25..-4	VBZ 0516	5004		
TRCR/L	2525 25-5	5	25	25	1600	25,5	22	150	38,5	5,0+6,0	GS..25..-5	VBZ 0516	5004		
TRCR/L	2525 25-6	6	25	25	1600	25,6	22	150	38,5	5,0+6,0	GS..25..-6	VBZ 0516	5004		
TRCR/L	3232 25-4	4	32	32	3000	32,5	22	170	40,5	5,0+6,0	GS..25..-4	VBZ 0516	5004		
TRCR/L	3232 25-5	5	32	32	3000	32,5	22	170	40,5	5,0+6,0	GS..25..-5	VBZ 0516	5004		
TRCR/L	3232 25-6	6	32	32	3000	32,6	22	170	40,5	5,0+6,0	GS..25..-6	VBZ 0516	5004		

ART.		(mm)											1	2
		W	Ød	ØDmin	f	H	Tmax	l1	l2	Nm				
TRIR/L	25 25-3	3	25	32	22,5	24,0	10,0	200,5	39,0	5,0+6,0	GS..25..-3	SM 522	5420	
TRIR/L	25 25-4	4	25	32	22,5	24,0	10,0	200,5	39,0	5,0+6,0	GS..25..-4	SM 522	5420	
TRIR/L	25 25-5	5	25	32	22,5	24,0	10,0	200,5	39,0	5,0+6,0	GS..25..-5	SM 522	5420	
TRIR/L	25 25-6	6	25	32	22,5	24,0	10,0	200,5	39,0	5,0+6,0	GS..25..-6	SM 522	5420	
TRIR/L	32 25-3	3	32	42	27,5	31,0	11,0	250,0	51,5	5,0+6,0	GS..25..-3	SM 522	5420	
TRIR/L	32 25-4	4	32	42	27,5	31,0	11,0	250,0	51,5	5,0+6,0	GS..25..-4	SM 522	5420	
TRIR/L	32 25-5	5	32	42	27,5	31,0	11,0	250,0	51,5	5,0+6,0	GS..25..-5	SM 522	5420	
TRIR/L	32 25-6	6	32	47	34,4	31,0	17,5	250,0	52,0	5,0+6,0	GS..25..-6	SM 522	5420	
TRIR/L	40 25-4	4	40	53	32,5	38,5	12,0	300,0	63,0	5,0+6,0	GS..25..-4	SM 522	5420	
TRIR/L	40 25-5	5	40	53	32,5	38,5	12,0	300,0	64,0	5,0+6,0	GS..25..-5	SM 522	5420	
TRIR/L	40 25-6	6	40	57	34,4	38,5	17,5	300,0	65,0	5,0+6,0	GS..25..-6	SM 522	5420	

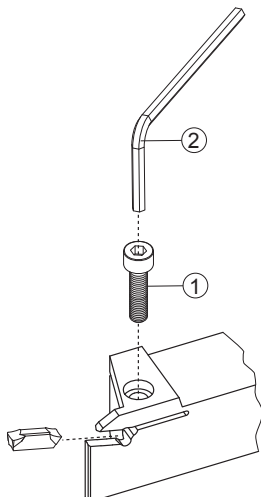

CAMPI D'IMPIEGO DEGLI INSERTI PER TAGLIO-SCANALATURA
 FIELDS OF APPLICATION FOR PARTING AND GROOVING INSERTS
 EINSATZBEREICH FÜR ABSTECH- UND NUTENDREHWENDEPLATTEN
 CHAMPS D'USINAGE DES PLAQUETTES POUR TRONÇONNAGE-GORGES

VELOCITÀ DI TAGLIO Vc
 Vc. CUTTING SPEED
 Vc. SCHNITTGESCHWINDIGKEIT
 Vc. VITESSE DE COUPE

DETTAGLIO RICAMBI
 SPARE PARTS DETAILS
 DETAILS ZU DEN ERSATZTEILEN
 DÉTAIL DE PIÈCES DE RECHANGE

DATI TECNICI E CONSIGLI
 TECHNICAL DATA AND SUGGESTIONS
 TECHNISCHE DATEN UND EMPFEHLUNGEN
 DONNÉES TECHNIQUES ET CONSEILS

PAG. 250

Vc **PAG. 248**

PAG. 1103

PAG. 1129

SCELTA VELOCE - QUICK PICK

Tenacità + ↑

Toughness - ↓

Pag. 242

COD.	P				M				K				N				S				H				HT	HW	HC				DP	GM..										
	F	M	R		F	M	R		F	M	R		F	M	R		F	M	R		F	M	R				F	M	R			F	M	R		F4530	F4730	T5735	F4645	D3007	W	r
GMGN 25-0.2-3 .X47																																					3,0	0,2	25	2,2	8°	-
GMGN 25-0.4-4 .X47																																					4,0	0,4	25	3,2	8°	-
GMGN 25-0.4-5 .X47																																					5,0	0,4	25	4,1	8°	-
GMGN 25R1.5-3 .X47																																					3,0	1,5	25	2,2	8°	-
GMGN 25R2.0-4 .X47																																					4,0	2,0	25	3,2	8°	-
GMGN 25R2.5-5 .X47																																					5,0	2,5	25	4,1	8°	-
GSGN 25-0.2-3 .X42																																					3,0	0,2	25	2,2	11°	-
GSGN 25-0.4-4 .X42																																					4,0	0,4	25	3,2	11°	-
GSGN 25-0.4-5 .X42																																					5,0	0,4	25	4,1	10°	-
GSGN 25-0.4-6 .X42																																					6,0	0,4	25	5,0	10°	-
GMGL 25-0.2-3 .X52																																					3,0	0,2	25	2,2	10°	6
GMGL 25-0.3-4 .X52																																					4,0	0,3	25	3,2	10°	6
GMGN 25-0.2-3 .X52																																					3,0	0,2	25	2,2	10°	-
GMGN 25-0.3-4 .X52																																					4,0	0,3	25	3,2	10°	-
GMGR 25-0.2-3 .X52																																					3,0	0,2	25	2,2	10°	6
GMGR 25-0.3-4 .X52																																					4,0	0,3	25	3,2	10°	6
GSGN 25-0.2-3 .X52																																					3,0	0,2	25	2,2	11°	-
GSGN 25-0.4-4 .X52																																					4,0	0,4	25	3,2	11°	-
GSGN 25-0.4-5 .X52																																					5,0	0,4	25	4,1	10°	-
GSGN 25-0.4-6 .X52																																					6,0	0,4	25	5,0	10°	-
GSTN 25-0.2-3 .X54																																					3,0	0,2	25	2,2	11°	-
GSTN 25-0.3-4 .X54																																					4,0	0,3	25	3,2	11°	-
GSTN 25-0.3-5 .X54																																					5,0	0,3	25	4,1	10°	-
GSTN 25-0.3-6 .X54																																					6,0	0,3	25	5,0	10°	-
GSTN 25R1.5-3 .X55																																					3,0	1,5	25	2,2	8°	-
GSTN 25R2.0-4 .X55																																					4,0	2,0	25	3,2	8°	-
GSTN 25R2.5-5 .X55																																					5,0	2,5	25	4,1	8°	-
GSTN 25R3.0-6 .X55																																					6,0	3,0	25	5,0	8°	-

CON ADDUZIONE LUBROREFRIGERANTE - WITH COOLANT SUPPLY

SENZA ADDUZIONE LUBROREFRIGERANTE - WITHOUT COOLANT SUPPLY

GS..

MATERIALI - MATERIALS Pag. 1199		VDI 3323 GR.	HB Rm ¹⁾ HRC ²⁾	Vc m/min Pag. 248				
				D3007	F4530	F4730	T5735	F4645
P	ACCIAIO NON LEGATO - NOT ALLOY STEEL	1-5	125-300	140	140	150	130	
	ACCIAIO POCO LEGATO - LOW ALLOY STEEL	6-9	180-350	130	130	140	120	
	ACCIAIO ALTO LEGATO - ALLOY STEEL	10-11	200-325	100	100	115	90	
	INOX MARTENS. - STAINLESS STEEL MART	12-13	200-240	150	150	160	90	
M	INOX AUST. DUPLEX - STAINLESS STEEL AUST	14.1-14.2	180-230	100	100	120	100	
	GHISA GRIGIA - GREY CAST IRON	15-16	180-260	160	160	140		
K	GHISA SFEROIDALE - SPHEROIDAL GRAPHITE	17-18	160-250	140	140	130		
	GHISA MALLEABILE - MALLEABLE CAST IRON	19-20	130-230	140	140	115		
N	ALLUMINIO E SUE LEGHE - ALUMINIUM	21-25	60-130	700				
	RAME E SUE LEGHE - COPPER	26-28	90-110	600				
	NON METALLICI - PLASTICS	29-30	/	800				

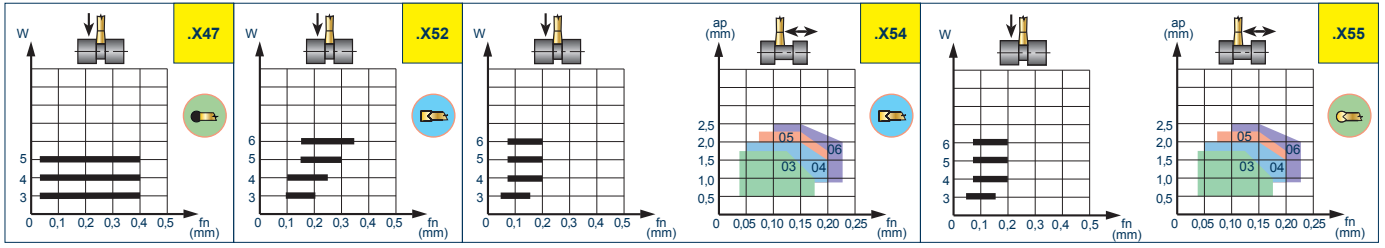
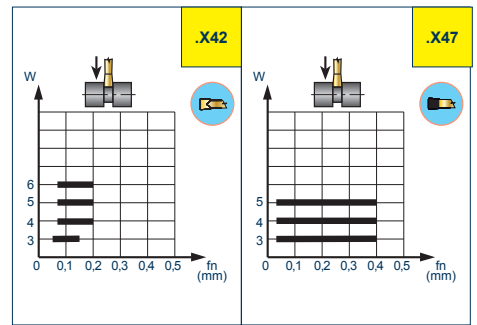

TRWR/L

∅ 20x20 - 25x25

ADDUZIONE REFRIGERANTE DIRETTA SULL'INSERTO
DIRECT COOLANT SUPPLY TO THE INSERT
DIREKTE ZUFÜHRUNG DES SCHMIERSTOFFS AN DIE PLATTE
ADDUCTION REFRIGERANT DIRECTE SUR LA PLAQUETTE

RANGE DI UTILIZZO
 20+80 bar
APPLICATION RANGE
 20+80 bar

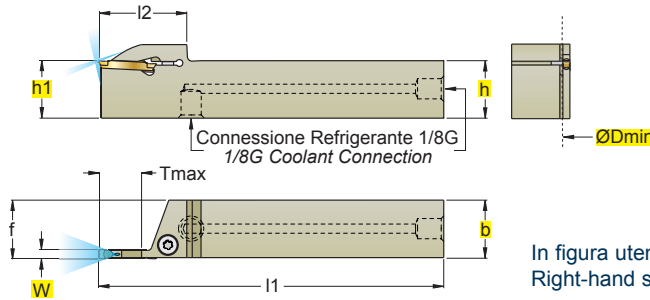

In figura utensile destro
 Right-hand shown

IL VANTAGGIO DI PERFORMANCE SI OTTIENE SOLO CON L'ALTA PRESSIONE DEL REFRIGERANTE 20+80 bar, LE POMPE UTILIZZATE DEVONO AVERE UN FILTRAGGIO DEL LIQUIDO DI RITORNO.
THE PERFORMANCE ADVANTAGE CAN BE ACHIEVED ONLY WITH HIGH COOLANT PRESSURE (20+80 BAR), THE PUMPS USED MUST BE EQUIPPED WITH RETURN-FLOW FILTRATION

DER LEISTUNGSVORTEIL IST NUR BEI HOHEM KÜHLMITTELDRUCK (20+80 BAR) ERZIELBAR. DIE EINGESETZTEN PUMPEN MÜSSEN MIT EINER RÜCKLAUFFILTERUNG AUSGESTATTET SEIN

L'AVANTAGE DE PERFORMANCE NE S'OBTIENT QUE PAR LA HAUTE PRESSION DU REFRIGERANT 20+80 bars, LES POMPES UTILISEES DOIVENT ETRE DOTEES D'UN FILTRE DU LIQUIDE DE RETOUR.

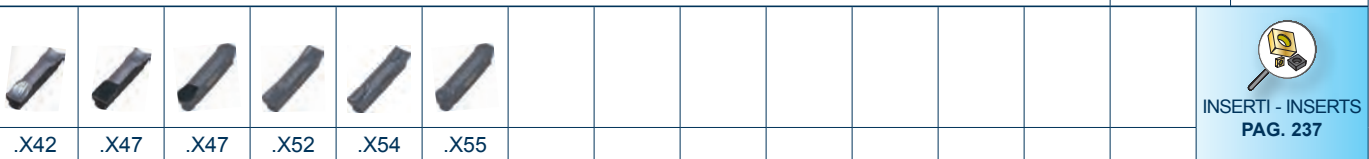

ART.	(mm)	W	h=h1	b	ØDmin	f	Tmax	l1	l2	Nm	1	2	3
TRWR/L 2020 14-2	2	20	20	1100	20,3	12,5	125	35,5	5,0+6,0	GS..14.5.-2	VBZ 0516	5004	218-1814
TRWR/L 2020 14-3	3	20	20	1100	20,5	12,5	125	35,5	5,0+6,0	GS..14.5.-3	VBZ 0516	5004	218-1814
TRWR/L 2020 14-4	4	20	20	1100	20,5	12,5	125	35,5	5,0+6,0	GS..14.5.-4	VBZ 0516	5004	218-1814
TRWR/L 2525 14-2	2	25	25	1600	25,3	12,5	150	36,0	5,0+6,0	GS..14.5.-2	VBZ 0516	5004	218-1814
TRWR/L 2525 14-3	3	25	25	1600	25,5	12,5	150	36,0	5,0+6,0	GS..14.5.-3	VBZ 0516	5004	218-1814
TRWR/L 2525 14-4	4	25	25	1600	25,5	12,5	150	36,0	5,0+6,0	GS..14.5.-4	VBZ 0516	5004	218-1814

Accessori per connessione Utensili - Accessories for tool connection - Zubehör zur werkzeugverbindung - Accessoires pour connexion outils



• Tubo dritto raccordato
Fitted hose, straight

PAG. 1096



• Tubo dritto raccordato
Fitted hose, straight

PAG. 1096



• Tubo dritto raccordato
Fitted hose, straight

PAG. 1096



• Ogiva lubrorefrigerante
Cooling lubricant nose cone

PAG. 1097



• Raccordo dritto
Straight fitting

PAG. 1096



• Riduzione
Adapter

PAG. 1096



• Raccordo 90°
90° Fitting

PAG. 1097



• B-SEAL M10

PAG. 1097

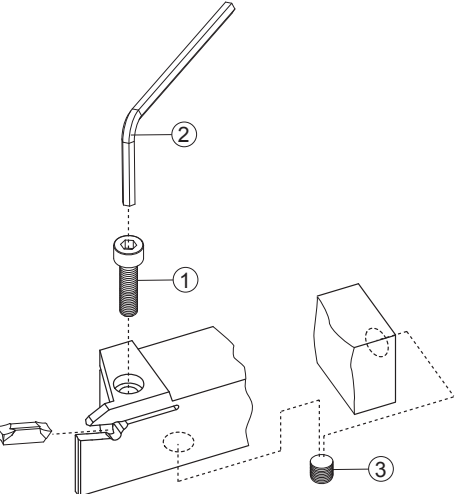





CAMPI D'IMPIEGO DEGLI INSERTI PER TAGLIO-SCANALATURA
FIELDS OF APPLICATION FOR PARTING AND GROOVING INSERTS



EINSATZBEREICH FÜR ABSTECH- UND NUTENDREHWENDEPLATTEN

CHAMPS D'USINAGE DES PLAQUETTES POUR TRONÇONNAGE-GORGES

 **PAG. 250**

VELOCITÀ DI TAGLIO Vc
Vc. CUTTING SPEED

Vc. SCHNITTGESCHWINDIGKEIT

Vc. VITESSE DE COUPE

 **PAG. 248**

DETTAGLIO RICAMBI
SPARE PARTS DETAILS

DETAILS ZU DEN ERSATZTEILEN

DÉTAIL DE PIÈCES DE RECHANGE

 **PAG. 1103**

DATI TECNICI E CONSIGLI
TECHNICAL DATA AND SUGGESTIONS

TECHNISCHE DATEN UND EMPFEHLUNGEN

DONNÉES TECHNIQUES ET CONSEILS

 **PAG. 1129**

SCelta VELOCE - QUICK PICK



Pag. 242

COD.	P		M		K		N		S		H		HT	HW	HC			DP	W	r	l	T	a°	
	F	M	R	F	M	R	F	M	R	F	M	R			F	M	R							F
GMGN 14.5-0.2-2 .X47	●						●	●										■	2,0	0,2	14,5	1,5	8°	
GMGN 14.5-0.2-3 .X47	●						●	●										■	3,0	0,2	14,5	2,2	8°	
GMGN 14.5-0.4-4 .X47	●						●	●										■	4,0	0,4	14,5	3,2	8°	
GMGN 14.5R1.0-2 .X47	●						●	●										■	2,0	1,0	14,5	1,5	8°	
GMGN 14.5R1.5-3 .X47	●						●	●										■	3,0	1,5	14,5	2,2	8°	
GMGN 14.5R2.0-4 .X47	●						●	●										■	4,0	2,0	14,5	3,2	8°	
GSGN 14.5-0.2-2 .X42	○	●		○	●		○	○										■	2,0	0,2	14,5	1,5	10°	
GSGN 14.5-0.2-3 .X42	○	●		○	●		○	○										■	3,0	0,2	14,5	2,2	10°	
GSGN 14.5-0.4-4 .X42	○	●		○	●		○	○										■	4,0	0,4	14,5	3,2	10°	
GSGN 14.5-0.2-2 .X52	○	●		○	○		○	○										■	2,0	0,2	14,5	1,5	10°	
GSGN 14.5-0.2-3 .X52	○	●		○	○		○	○										■	3,0	0,2	14,5	2,2	10°	
GSGN 14.5-0.4-4 .X52	○	●		○	○		○	○										■	4,0	0,4	14,5	3,2	10°	
GSTN 14.5-0.2-2 .X54	○	●		○	○		○	○										■	2,0	0,2	14,5	1,5	10°	
GSTN 14.5-0.2-3 .X54	○	●		○	○		○	○										■	3,0	0,2	14,5	2,2	11°	
GSTN 14.5-0.3-4 .X54	○	●		○	○		○	○										■	4,0	0,3	14,5	3,2	11°	
GSTN 14.5R1.0-2 .X55	○	●		○	○		○	○										■	2,0	1,0	14,5	1,5	8°	
GSTN 14.5R1.5-3 .X55	○	●		○	○		○	○										■	3,0	1,5	14,5	2,2	8°	
GSTN 14.5R2.0-4 .X55	○	●		○	○		○	○										■	4,0	2,0	14,5	3,2	8°	
CON ADDUZIONE LUBROREFRIGERANTE - WITH COOLANT SUPPLY																								
SENZA ADDUZIONE LUBROREFRIGERANTE - WITHOUT COOLANT SUPPLY																								

MATERIALI - MATERIALS Pag. 1199		VDI 3323 GR.	HB Rm ¹⁾ HRC ²⁾	Vc m/min Pag. 248			
				D3007	F4530	T5735	F4645
P	ACCIAIO NON LEGATO - NOT ALLOY STEEL	1--5	125-300		140	150	130
	ACCIAIO POCO LEGATO - LOW ALLOY STEEL	6--9	180-350		130	140	120
	ACCIAIO ALTO LEGATO - ALLOY STEEL	10-11	200-325		100	115	90
	INOX MARTENS. - STAINLESS STEEL MART	12-13	200-240		150	160	90
M	INOX AUST. DUPLEX - STAINLESS STEEL AUST	14.1-14.2	180-230		100	120	100
	GHISA GRIGIA - GREY CAST IRON	15-16	180-260		160	140	
K	GHISA SFEROIDALE - SPHEROIDAL GRAPHITE	17-18	160-250		140	130	
	GHISA MALLEABILE - MALLEABLE CAST IRON	19-20	130-230		140	115	
	ALLUMINIO E SUE LEGHE - ALUMINIUM	21--25	60-130	700			
N	RAME E SUE LEGHE - COPPER	26--28	90-110	600			
	NON METALLICI - PLASTICS	29-30	/	800			

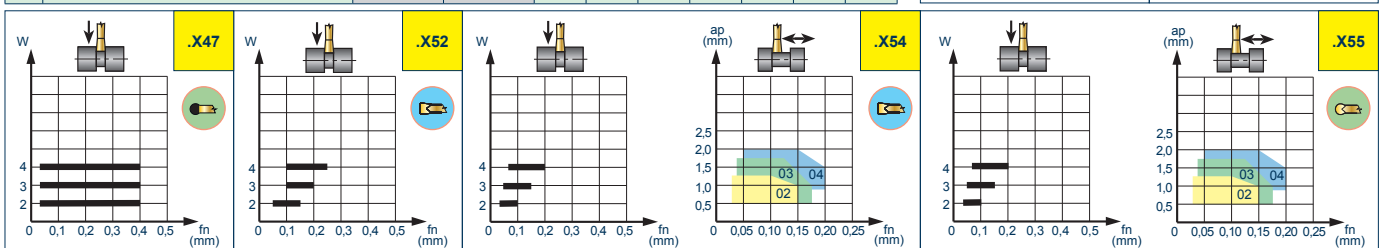
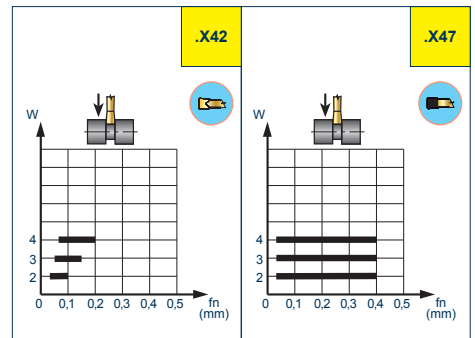

= SCANALATURA - GROOVING
Vc = m/min VELOCITÀ DI TAGLIO - CUTTING SPEED **n** = giri/min (min⁻¹) NUMERO DI GIRI - NUMBER OF REVOLUTIONS
fn = mm AVANZAMENTO AL GIRO - FEED / REVOLUTION **Vf** = mm/min VELOCITÀ DI AVANZAMENTO - FEED SPEED **W** = mm LARGHEZZA TAGLIANTE - CUTTING EDGE WIDTH

TRWR/L

∅ 20x20 - 25x25

ADDUZIONE REFRIGERANTE DIRETTA SULL'INSERTO
DIRECT COOLANT SUPPLY TO THE INSERT
DIREKTE ZUFÜHRUNG DES SCHMIERSTOFFS AN DIE PLATTE
ADDITION REFRIGÉRANT DIRECTE SUR LA PLAQUETTE

RANGE DI UTILIZZO
 20+80 bar
APPLICATION RANGE
 20+80 bar

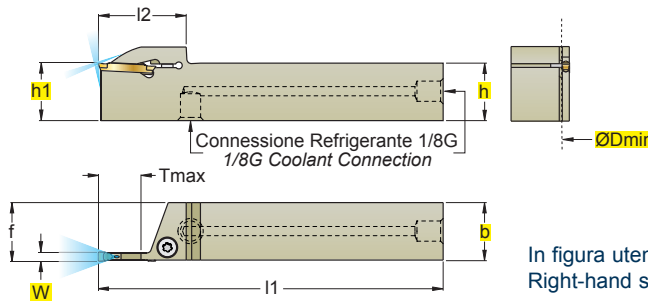

In figura utensile destro
 Right-hand shown



IL VANTAGGIO DI PERFORMANCE SI OTTIENE SOLO CON L'ALTA PRESSIONE DEL REFRIGERANTE 20+80 bar, LE POMPE UTILIZZATE DEVONO AVERE UN FILTRAGGIO DEL LIQUIDO DI RITORNO.
THE PERFORMANCE ADVANTAGE CAN BE ACHIEVED ONLY WITH HIGH COOLANT PRESSURE (20+80 BAR). THE PUMPS USED MUST BE EQUIPPED WITH RETURN-FLOW FILTRATION

DER LEISTUNGSVORTEIL IST NUR BEI HOHEM KÜHLMITTELDRUCK (20+80 BAR) ERZIELBAR. DIE EINGESETZTEN PUMPEN MÜSSEN MIT EINER RÜCKLAUFFILTERUNG AUSGESTATTET SEIN

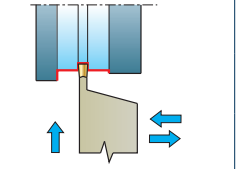
L'AVANTAGE DE PERFORMANCE NE S'OBTIENT QUE PAR LA HAUTE PRESSION DU REFRIGÉRANT 20+80 bars, LES POMPES UTILISÉES DOIVENT ÊTRE DOTÉES D'UN FILTRE DU LIQUIDE DE RETOUR.

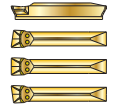

GM..
25..



GS.N
25..





INSERTI - INSERTS
PAG. 238

ART.	(mm)	W	h=h1	b	ØDmin	f	Tmax	l1	l2	Nm	1	2	3
TRWR/L 2020 25-3	3	20	20	1100	20,5	22	125	38,5	5,0+6,0	GS..25..-3	VBZ 0516	5004	218-1814
TRWR/L 2020 25-4	4	20	20	1100	20,5	22	125	40,5	5,0+6,0	GS..25..-4	VBZ 0516	5004	218-1814
TRWR/L 2525 25-3	3	25	25	1600	25,5	22	150	41,0	5,0+6,0	GS..25..-3	VBZ 0516	5004	218-1814
TRWR/L 2525 25-4	4	25	25	1600	25,5	22	150	41,0	5,0+6,0	GS..25..-4	VBZ 0516	5004	218-1814
TRWR/L 2525 25-5	5	25	25	1600	25,5	22	150	41,0	5,0+6,0	GS..25..-5	VBZ 0516	5004	218-1814
TRWR/L 2525 25-6	6	25	25	1600	25,6	22	150	41,0	5,0+6,0	GS..25..-6	VBZ 0516	5004	218-1814

Accessori per connessione Utensili - Accessories for tool connection - Zubehör zur werkzeugverbindung - Accessoires pour connexion outils

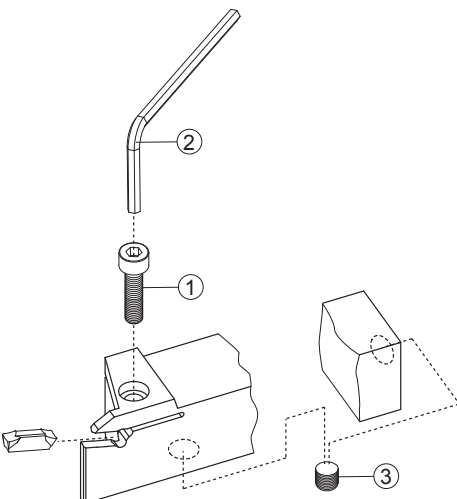
 <p>• Tubo dritto raccordato Fitted hose, straight</p> <p>PAG. 1096</p>	 <p>• Tubo dritto raccordato Fitted hose, straight</p> <p>PAG. 1096</p>	 <p>• Tubo dritto raccordato Fitted hose, straight</p> <p>PAG. 1096</p>	 <p>• Ogiva lubrificante Cooling lubricant nose cone</p> <p>PAG. 1097</p>
 <p>• Raccordo dritto Straight fitting</p> <p>PAG. 1096</p>	 <p>• Riduzione Adapter</p> <p>PAG. 1096</p>	 <p>• Raccordo 90° 90° Fitting</p> <p>PAG. 1097</p>	 <p>• B-SEAL M10</p> <p>PAG. 1097</p>







CAMPI D'IMPIEGO DEGLI INSERTI PER TAGLIO-SCANALATURA
FIELDS OF APPLICATION FOR PARTING AND GROOVING INSERTS



EINSATZBEREICH FÜR ABSTECH- UND NUTDREHWENDEPLATTEN

CHAMPS D'USAGE DES PLAQUETTES POUR TRONÇONNAGE-GORGES

PAG. 250

VELOCITÀ DI TAGLIO Vc
Vc. CUTTING SPEED

Vc. SCHNITTGESCHWINDIGKEIT

Vc. VITESSE DE COUPE

PAG. 248

DETTAGLIO RICAMBI
SPARE PARTS DETAILS

DETAILS ZU DEN ERSATZTEILEN

DÉTAIL DE PIÈCES DE RECHANGE

PAG. 1103

DATI TECNICI E CONSIGLI
TECHNICAL DATA AND SUGGESTIONS

TECHNISCHE DATEN UND EMPFEHLUNGEN

DONNÉES TECHNIQUES ET CONSEILS

PAG. 1129

SCelta VELOCE - QUICK PICK



COD.	P		M		K		N		S		H		HT	HW	HC			DP	GM..	W	r	l	T	a°	b°
	F	M	R	F	M	R	F	M	R	F	M	R	F	M	R	F	M	R							
GMGN 25-0.2-3 .X47	●						●	●												3,0	0,2	25	2,2	8°	-
GMGN 25-0.4-4 .X47	●						●	●												4,0	0,4	25	3,2	8°	-
GMGN 25-0.4-5 .X47	●						●	●												5,0	0,4	25	4,1	8°	-
GMGN 25R1.5-3 .X47	●						●	●												3,0	1,5	25	2,2	8°	-
GMGN 25R2.0-4 .X47	●						●	●												4,0	2,0	25	3,2	8°	-
GMGN 25R2.5-5 .X47	●						●	●												5,0	2,5	25	4,1	8°	-
GSGN 25-0.2-3 .X42	○	●					○	○												3,0	0,2	25	2,2	11°	-
GSGN 25-0.4-4 .X42	○	●					○	○												4,0	0,4	25	3,2	11°	-
GSGN 25-0.4-5 .X42	○	●					○	○												5,0	0,4	25	4,1	10°	-
GSGN 25-0.4-6 .X42	○	●					○	○												6,0	0,4	25	5,0	10°	-
GMGL 25-0.2-3 .X52	○	○					○	○												3,0	0,2	25	2,2	10°	6
GMGL 25-0.3-4 .X52	○	○					○	○												4,0	0,3	25	3,2	10°	6
GMGN 25-0.2-3 .X52	○	○					○	○												3,0	0,2	25	2,2	10°	-
GMGN 25-0.3-4 .X52	○	○					○	○												4,0	0,3	25	3,2	10°	-
GMGR 25-0.2-3 .X52	○	○					○	○												3,0	0,2	25	2,2	10°	6
GMGR 25-0.3-4 .X52	○	○					○	○												4,0	0,3	25	3,2	10°	6
GSGN 25-0.2-3 .X52	○	○					○	○												3,0	0,2	25	2,2	11°	-
GSGN 25-0.4-4 .X52	○	○					○	○												4,0	0,4	25	3,2	11°	-
GSGN 25-0.4-5 .X52	○	○					○	○												5,0	0,4	25	4,1	10°	-
GSGN 25-0.4-6 .X52	○	○					○	○												6,0	0,4	25	5,0	10°	-
GSTN 25-0.2-3 .X54	○	○					○	○												3,0	0,2	25	2,2	11°	-
GSTN 25-0.3-4 .X54	○	○					○	○												4,0	0,3	25	3,2	11°	-
GSTN 25-0.3-5 .X54	○	○					○	○												5,0	0,3	25	4,1	10°	-
GSTN 25-0.3-6 .X54	○	○					○	○												6,0	0,3	25	5,0	10°	-
GSTN 25R1.5-3 .X55	○	○					○	○												3,0	1,5	25	2,2	8°	-
GSTN 25R2.0-4 .X55	○	○					○	○												4,0	2,0	25	3,2	8°	-
GSTN 25R2.5-5 .X55	○	○					○	○												5,0	2,5	25	4,1	8°	-
GSTN 25R3.0-6 .X55	○	○					○	○												6,0	3,0	25	5,0	8°	-

CON ADDUZIONE LUBROREFRIGERANTE - WITH COOLANT SUPPLY
SENZA ADDUZIONE LUBROREFRIGERANTE - WITHOUT COOLANT SUPPLY

MATERIALI - MATERIALS Pag. 1199		VDI 3323 GR.	HB Rm ¹ HRC ²	Vc m/min Pag. 248				
P	ACCIAIO NON LEGATO - NOT ALLOY STEEL	1-5	125-300	140	140	150	130	
		M	ACCIAIO POCO LEGATO - LOW ALLOY STEEL	6-9	180-350	130	130	140
K	ACCIAIO ALTO LEGATO - ALLOY STEEL			10-11	200-325	100	100	115
		N	INOX MARTENS. - STAINLESS STEEL MART	12-13	200-240	150	150	160
M	INOX AUST. DUPLEX - STAINLESS STEEL AUST			14.1-14.2	180-230	100	100	120
		K	GHISA GRIGIA - GREY CAST IRON	15-16	180-260	160	160	140
N	GHISA SFEROIDALE - SPHEROIDAL GRAPHITE			17-18	160-250	140	140	130
		N	GHISA MALLEABILE - MALLEABLE CAST IRON	19-20	130-230	140	140	115
N	ALLUMINIO E SUE LEGHE - ALUMINIUM			21-25	60-130	700		
		N	RAME E SUE LEGHE - COPPER	26-28	90-110	600		
N	NON METALLICI - PLASTICS			29-30	/	800		

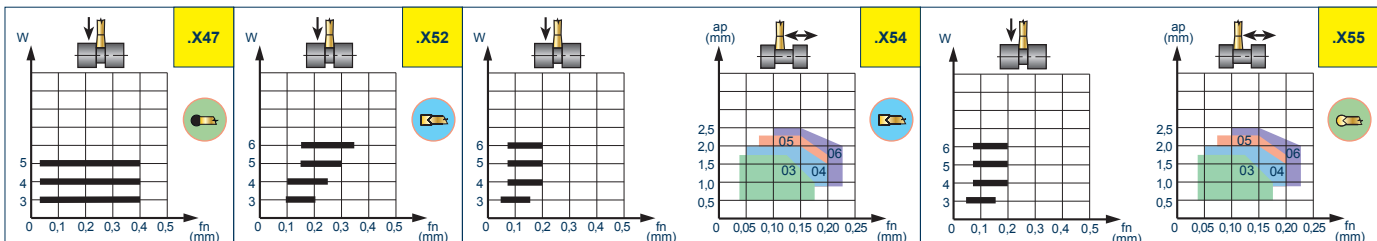
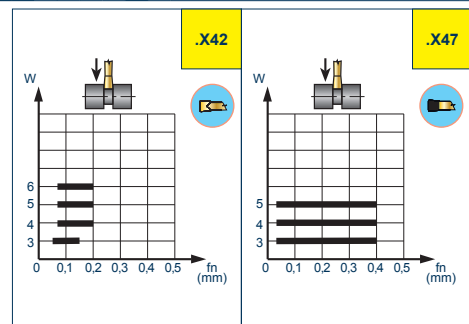

TRFR/L

∅ 25x25

UTENSILE PER SCANALATURA FRONTALE
TOOLHOLDER FOR FACE GROOVING
AXIALEINSTECHWERKZEUG
OUTIL POUR GORGES FRONTALES

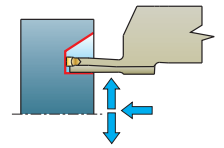
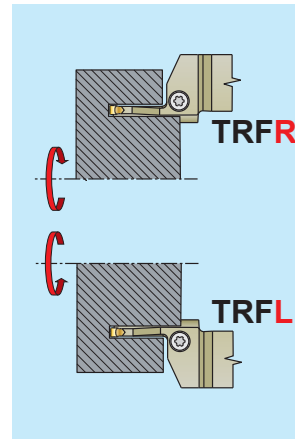
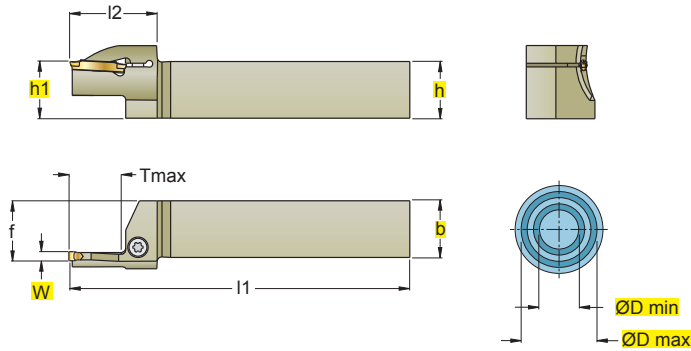

GM..
25..

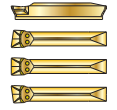

GS.N
25..



In figura utensile destro - Right-hand shown

ART. (mm)													1		2	
W h=h1 b ØDmin ØDmax f Tmax l1 l2 Nm													1		2	
TRFR/L 2525 25-3 35-50	3	25	25	35	50	26,5	13	150	39	5,0+6,0	GS..25..-3	VBZ 0516	5004			
TRFR/L 2525 25-3 50-75	3	25	25	50	75	26,5	22	150	39	5,0+6,0	GS..25..-3	VBZ 0516	5004			
TRFR/L 2525 25-3 75-100	3	25	25	75	100	26,5	22	150	39	5,0+6,0	GS..25..-3	VBZ 0516	5004			
TRFR/L 2525 25-3 100-150	3	25	25	100	150	26,5	22	150	39	5,0+6,0	GS..25..-3	VBZ 0516	5004			
TRFR/L 2525 25-3 150-350	3	25	25	150	350	26,5	22	150	39	5,0+6,0	GS..25..-3	VBZ 0516	5004			
TRFR/L 2525 25-4 35-50	4	25	25	35	50	27,0	13	150	39	5,0+6,0	GS..25..-4	VBZ 0516	5004			
TRFR/L 2525 25-4 50-75	4	25	25	50	75	27,0	22	150	39	5,0+6,0	GS..25..-4	VBZ 0516	5004			
TRFR/L 2525 25-4 75-100	4	25	25	75	100	27,0	22	150	39	5,0+6,0	GS..25..-4	VBZ 0516	5004			
TRFR/L 2525 25-4 100-150	4	25	25	100	150	27,0	22	150	39	5,0+6,0	GS..25..-4	VBZ 0516	5004			
TRFR/L 2525 25-4 150-350	4	25	25	150	350	27,0	22	150	39	5,0+6,0	GS..25..-4	VBZ 0516	5004			
TRFR/L 2525 25-5 35-50	5	25	25	35	50	27,5	13	150	39	5,0+6,0	GS..25..-5	VBZ 0516	5004			
TRFR/L 2525 25-5 50-75	5	25	25	50	75	27,5	22	150	39	5,0+6,0	GS..25..-5	VBZ 0516	5004			
TRFR/L 2525 25-5 75-100	5	25	25	75	100	27,5	22	150	39	5,0+6,0	GS..25..-5	VBZ 0516	5004			
TRFR/L 2525 25-5 100-150	5	25	25	100	150	27,5	22	150	39	5,0+6,0	GS..25..-5	VBZ 0516	5004			
TRFR/L 2525 25-5 150-350	5	25	25	150	350	27,5	22	150	39	5,0+6,0	GS..25..-5	VBZ 0516	5004			
TRFR/L 2525 25-6 35-50	6	25	25	35	50	28,0	13	150	39	5,0+6,0	GS..25..-6	VBZ 0516	5004			
TRFR/L 2525 25-6 50-75	6	25	25	50	75	28,0	22	150	39	5,0+6,0	GS..25..-6	VBZ 0516	5004			
TRFR/L 2525 25-6 75-100	6	25	25	75	100	28,0	22	150	39	5,0+6,0	GS..25..-6	VBZ 0516	5004			
TRFR/L 2525 25-6 100-150	6	25	25	100	150	28,0	22	150	39	5,0+6,0	GS..25..-6	VBZ 0516	5004			
TRFR/L 2525 25-6 150-350	6	25	25	150	350	28,0	22	150	39	5,0+6,0	GS..25..-6	VBZ 0516	5004			

INSERTI - INSERTS
 PAG. 238

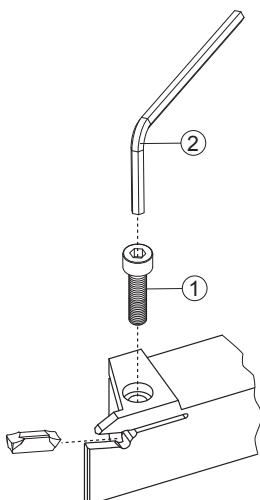

CAMPI D'IMPIEGO DEGLI INSERTI PER TAGLIO-SCANALATURA
FIELDS OF APPLICATION FOR PARTING AND GROOVING INSERTS
EINSATZBEREICH FÜR ABSTECH- UND NUTENDREHWENDEPLATTEN
CHAMPS D'USINAGE DES PLAQUETTES POUR TRONÇONNAGE-GORGES

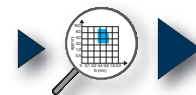

PAG. 250

VELOCITÀ DI TAGLIO Vc
Vc. CUTTING SPEED
Vc. SCHNITTGESCHWINDIGKEIT
Vc. VITESSE DE COUPE



PAG. 248

DETTAGLIO RICAMBI
SPARE PARTS DETAILS
DETAILS ZU DEN ERSATZTEILEN
DÉTAIL DE PIÈCES DE RECHANGE



PAG. 1103

DATI TECNICI E CONSIGLI
TECHNICAL DATA AND SUGGESTIONS
TECHNISCHE DATEN UND EMPFEHLUNGEN
DONNÉES TECHNIQUES ET CONSEILS



PAG. 1129

TRCXR/L

∅ 20x20 - 25x25

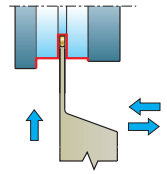
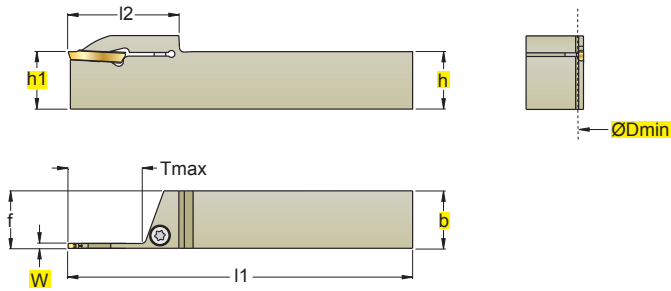

GM..
25..



INSERTI - INSERTS
 PAG. 238

ART. (mm)											1		2	
R L		W	h=h1	b	∅Dmin	f	Tmax	l1	l2	Nm	1		2	
TRCXR/L	2020 25-3	3	20	20	1100	20,5	32,5	125	50,0	5,0+6,0	GM..25..-3	VBZ 0516	5004	
TRCXR/L	2525 25-3	3	25	25	1600	25,5	32,5	150	48,5	5,0+6,0	GM..25..-3	VBZ 0516	5004	
TRCXR/L	2020 25-4 New	4	20	20	1100	20,0	32,5	125	50,0	5,0+6,0	GM..25..-4	VBZ 0516	5004	
TRCXR/L	2525 25-4 New	4	25	25	1600	25,0	32,5	150	48,5	5,0+6,0	GM..25..-4	VBZ 0516	5004	

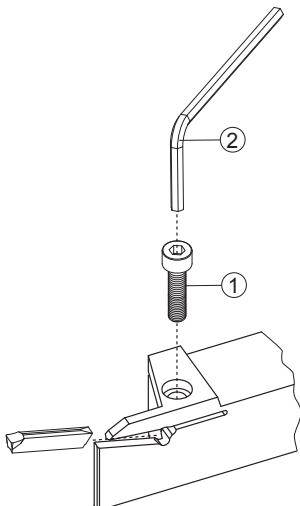

■ CAMPI D'IMPIEGO DEGLI INSERTI PER TAGLIO-SCANALATURA
 ■ FIELDS OF APPLICATION FOR PARTING AND GROOVING INSERTS
 ■ EINSATZBEREICH FÜR ABSTECH- UND NUTENDREHWENDEPLATTEN
 ■ CHAMPS D'USINAGE DES PLAQUETTES POUR TRONÇONNAGE-GORGES

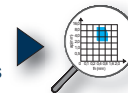

PAG. 250

■ VELOCITÀ DI TAGLIO Vc
 ■ Vc. CUTTING SPEED
 ■ Vc. SCHNITTGESCHWINDIGKEIT
 ■ Vc. VITESSE DE COUPE



PAG. 248

■ DETTAGLIO RICAMBI
 ■ SPARE PARTS DETAILS
 ■ DETAILS ZU DEN ERSATZTEILEN
 ■ DÉTAIL DE PIÈCES DE RECHANGE



PAG. 1103

■ DATI TECNICI E CONSIGLI
 ■ TECHNICAL DATA AND SUGGESTIONS
 ■ TECHNISCHE DATEN UND EMPFEHLUNGEN
 ■ DONNÉES TECHNIQUES ET CONSEILS



PAG. 1129

SCELTA VELOCE - QUICK PICK

Tenacità + ↑

Toughness - ↓

Pag. 242

COD.	Material Groups												HT	HW	HC						Geometric Parameters											
	P			M			K			N			S			H			CERMET	NON RIV. CEMENTED CARBIDE GRADES	RIVESTITI COATED GRADES BESCHICHTET RECOUVERTS						GM..					
	F	M	R	F	M	R	F	M	R	F	M	R	F	M	R	F	M	R			F4530	F4730							W	r	l	T
GMGL 25-0.2-3 .X52	●	○		○	○		○	○		○	○		○	○		○	○		○	○	■	■	■	■	■	■	3,0	0,2	25	2,2	10°	6
GMGL 25-0.3-4 .X52	●	○		○	○		○	○		○	○		○	○		○	○		○	○	■	■	■	■	■	■	4,0	0,3	25	3,2	10°	6
GMGN 25-0.2-3 .X52	●	○		○	○		○	○		○	○		○	○		○	○		○	○	■	■	■	■	■	■	3,0	0,2	25	2,2	10°	-
GMGN 25-0.3-4 .X52	●	○		○	○		○	○		○	○		○	○		○	○		○	○	■	■	■	■	■	■	4,0	0,3	25	3,2	10°	-
GMGR 25-0.2-3 .X52	●	○		○	○		○	○		○	○		○	○		○	○		○	○	■	■	■	■	■	■	3,0	0,2	25	2,2	10°	6
GMGR 25-0.3-4 .X52	●	○		○	○		○	○		○	○		○	○		○	○		○	○	■	■	■	■	■	■	4,0	0,3	25	3,2	10°	6

CON ADDUZIONE LUBROREFRIGERANTE - WITH COOLANT SUPPLY

SENZA ADDUZIONE LUBROREFRIGERANTE - WITHOUT COOLANT SUPPLY

MATERIALI - MATERIALS Pag. 1199		VDI 3323 GR.	HB Rm ¹⁾ HRC ²⁾	Vc m/min Pag. 248							
				F4530	F4730						
P	ACCIAIO NON LEGATO - NOT ALLOY STEEL	1-5	125-300	140	140						
	ACCIAIO POCO LEGATO - LOW ALLOY STEEL	6-9	180-350	130	130						
	ACCIAIO ALTO LEGATO - ALLOY STEEL	10-11	200-325	100	100						
M	INOX MARTENS. - STAINLESS STEEL MART	12-13	200-240	150	150						
	INOX AUST. DUPLEX - STAINLESS STEEL AUST	14.1-14.2	180-230	100	100						
K	GHISA GRIGIA - GREY CAST IRON	15-16	180-260	160	160						
	GHISA SFEROIDALE - SPHEROIDAL GRAPHITE	17-18	160-250	140	140						
N	GHISA MALLEABILE - MALLEABLE CAST IRON	19-20	130-230	140	140						
	ALLUMINIO E SUE LEGHE - ALUMINIUM	21-25	60-130								
S	RAME E SUE LEGHE - COPPER	26-28	90-110								
	NON METALLICI - PLASTICS	29-30	/								
H	LEGHE RESIST. CALORE - HIG. TEMP. ALLOY	31-35	200-320								
	TITANIO E SUE LEGHE - TITANIUM	36-37	400-1050 ¹⁾								
	ACCIAIO TEMPRATO - HARDENED STEEL	38-41	45-60 ²⁾								

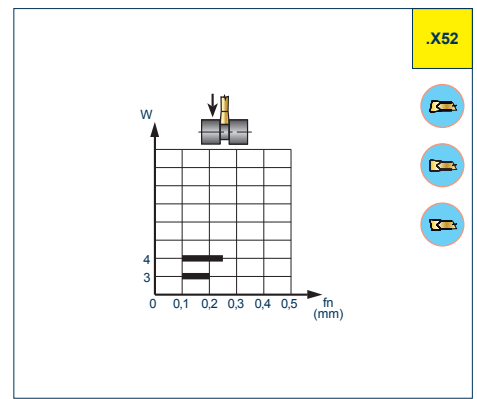

= SCANALATURA - GROOVING

- Vc = m/min VELOCITÀ DI TAGLIO - CUTTING SPEED
- n = giri/min (min⁻¹) NUMERO DI GIRI - NUMBER OF REVOLUTIONS
- fn = mm AVANZAMENTO AL GIRO - FEED / REVOLUTION
- Vf = mm/min VELOCITÀ DI AVANZAMENTO - FEED SPEED
- W = mm LARGHEZZA TAGLIENTE - CUTTING EDGE WIDTH
- ap = mm PROFONDITÀ DI TAGLIO - CUTTING DEPTH

$$n = \frac{Vc \cdot 1000}{\varnothing D \cdot 3,14} = \text{giri/min (min}^{-1}\text{)}$$

$$Vf = fn \cdot n = \text{mm/min}$$

TRWXR/L

∅ 20x20 - 25x25

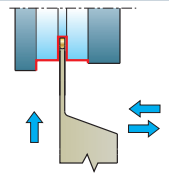
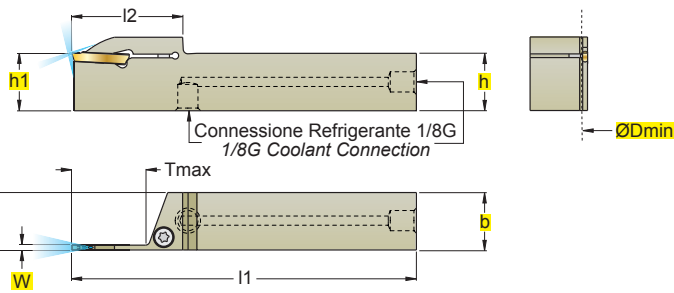

GM..
25..

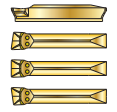

INSERTI - INSERTS
PAG. 238

ART. (mm)											1 2 3			
..L.. X52 ..N.. X52 ..R.. X52		W	h=h1	b	∅Dmin	f	Tmax	l1	l2	Nm				
TRWXR/L	2020 25-3	3	20	20	1100	20,5	32,5	125	52,0	5,0+6,0	GM..25..-3	VBZ 0516	5004	218-1814
TRWXR/L	2525 25-3	3	25	25	1600	25,5	32,5	150	50,5	5,0+6,0	GM..25..-3	VBZ 0516	5004	218-1814
TRWXR/L	2020 25-4 New	4	20	20	1100	20,0	32,5	125	52,0	5,0+6,0	GM..25..-4	VBZ 0516	5004	218-1814
TRWXR/L	2525 25-4 New	4	25	25	1600	25,0	32,5	150	50,5	5,0+6,0	GM..25..-4	VBZ 0516	5004	218-1814

Accessori per connessione Utensili - Accessories for tool connection - Zubehör zur werkzeugverbindung - Accessoires pour connexion outils

<p>• Tubo dritto raccordato <i>Fitted hose, straight</i></p> <p>PAG. 1096</p>	<p>• Tubo dritto raccordato <i>Fitted hose, straight</i></p> <p>PAG. 1096</p>	<p>• Tubo dritto raccordato <i>Fitted hose, straight</i></p> <p>PAG. 1096</p>	<p>• Ogiva lubrorefrigerante <i>Cooling lubricant nose cone</i></p> <p>PAG. 1097</p>
<p>• Raccordo dritto <i>Straight fitting</i></p> <p>PAG. 1096</p>	<p>• Riduzione <i>Adapter</i></p> <p>PAG. 1096</p>	<p>• Raccordo 90° <i>90° Fitting</i></p> <p>PAG. 1097</p>	<p>• B-SEAL M10</p> <p>PAG. 1097</p>

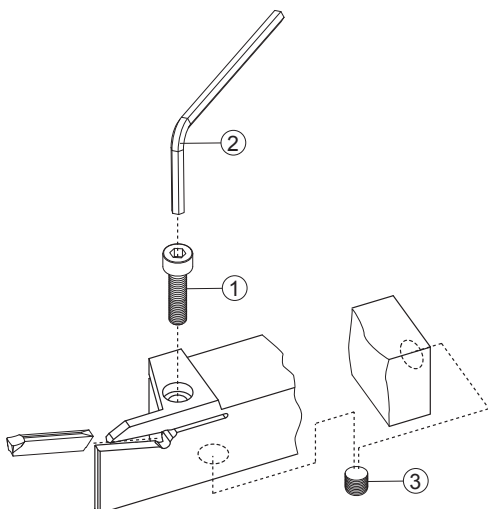

CAMPI D'IMPIEGO DEGLI INSERTI PER TAGLIO-SCANALATURA
FIELDS OF APPLICATION FOR PARTING AND GROOVING INSERTS
EINSATZBEREICH FÜR ABSTECH- UND NUTENDREHWENDEPLATTEN
CHAMPS D'USINAGE DES PLAQUETTES POUR TRONÇONNAGE-GORGES

PAG. 250

VELOCITÀ DI TAGLIO Vc
Vc. CUTTING SPEED
Vc. SCHNITTGESCHWINDIGKEIT
Vc. VITESSE DE COUPE

Vc **PAG. 248**

DETTAGLIO RICAMBI
SPARE PARTS DETAILS
DETAILS ZU DEN ERSATZTEILEN
DÉTAIL DE PIÈCES DE REMPLACEMENT

PAG. 1103

DATI TECNICI E CONSIGLI
TECHNICAL DATA AND SUGGESTIONS
TECHNISCHE DATEN UND EMPFEHLUNGEN
DONNÉES TECHNIQUES ET CONSEILS

PAG. 1129

SCelta VELOCE - QUICK PICK		Tenacità + ↑		Toughness - ↓		Pag. 242		HT	HW	HC												
		CERMET		NON RIV. CEMENTED CARBIDE GRADES		RIVESTITI COATED GRADES BESCHICHTET RECOUVERTS																
COD.	P		M		K		N		S		H		GM..		W	r	l	T	a°	b°		
	F	M	R	F	M	R	F	M	R	F	M	R	F	M	R							
GMGL 25-0.2-3 .X52	●	○		○	○	●	○								3,0	0,2	25	2,2	10°	6		
GMGL 25-0.3-4 .X52	●	○		○	○	●	○								4,0	0,3	25	3,2	10°	6		
GMGN 25-0.2-3 .X52	●	○		○	○	●	○								3,0	0,2	25	2,2	10°	-		
GMGN 25-0.3-4 .X52	●	○		○	○	●	○								4,0	0,3	25	3,2	10°	-		
GMGR 25-0.2-3 .X52	●	○		○	○	●	○								3,0	0,2	25	2,2	10°	6		
GMGR 25-0.3-4 .X52	●	○		○	○	●	○								4,0	0,3	25	3,2	10°	6		
CON ADDUZIONE LUBROREFRIGERANTE - WITH COOLANT SUPPLY																						
SENZA ADDUZIONE LUBROREFRIGERANTE - WITHOUT COOLANT SUPPLY																						

MATERIALI - MATERIALS		VDI 3323 GR.	HB Rm ¹⁾ HRC ²⁾	Vc m/min		Pag. 248			
Pag. 1199				F4530	F4730				
P	ACCIAIO NON LEGATO - NOT ALLOY STEEL	1-5	125-300	140	140				
	ACCIAIO POCO LEGATO - LOW ALLOY STEEL	6-9	180-350	130	130				
	ACCIAIO ALTO LEGATO - ALLOY STEEL	10-11	200-325	100	100				
M	INOX MARTENS. - STAINLESS STEEL MART	12-13	200-240	150	150				
	INOX AUST. DUPLEX - STAINLESS STEEL AUST	14.1-14.2	180-230	100	100				
K	GHISA GRIGIA - GREY CAST IRON	15-16	180-260	160	160				
	GHISA SFEROIDALE - SPHEROIDAL GRAPHITE	17-18	160-250	140	140				
N	GHISA MALLEABILE - MALLEABLE CAST IRON	19-20	130-230	140	140				
	ALLUMINIO E SUE LEGHE - ALUMINIUM	21-25	60-130						
S	RAME E SUE LEGHE - COPPER	26-28	90-110						
	NON METALLICI - PLASTICS	29-30	/						
H	LEGHE RESIST. CALORE - HIG. TEMP. ALLOY	31-35	200-320						
	TITANIO E SUE LEGHE - TITANIUM	36-37	400-1050 ¹⁾						
	ACCIAIO TEMPRATO - HARDENED STEEL	38-41	45-60 ²⁾						

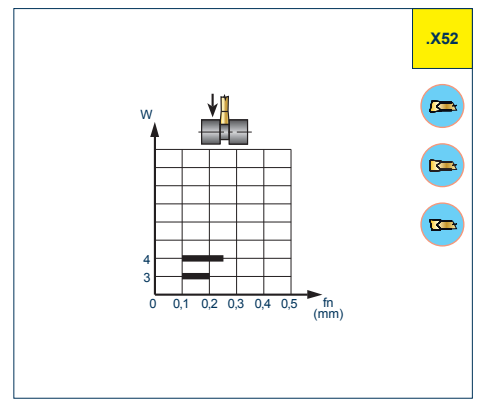

- Vc = m/min VELOCITÀ DI TAGLIO - CUTTING SPEED
- n = giri/min (min⁻¹) NUMERO DI GIRI - NUMBER OF REVOLUTIONS
- fn = mm AVANZAMENTO AL GIRO - FEED / REVOLUTION
- Vf = mm/min VELOCITÀ DI AVANZAMENTO - FEED SPEED
- W = mm LARGHEZZA TAGLIENTE - CUTTING EDGE WIDTH
- ap = mm PROFONDITÀ DI TAGLIO - CUTTING DEPTH

$$n = \frac{Vc \cdot 1000}{\varnothing D \cdot 3,14} = \text{giri/min (min}^{-1}\text{)}$$

$$Vf = fn \cdot n = \text{mm/min}$$

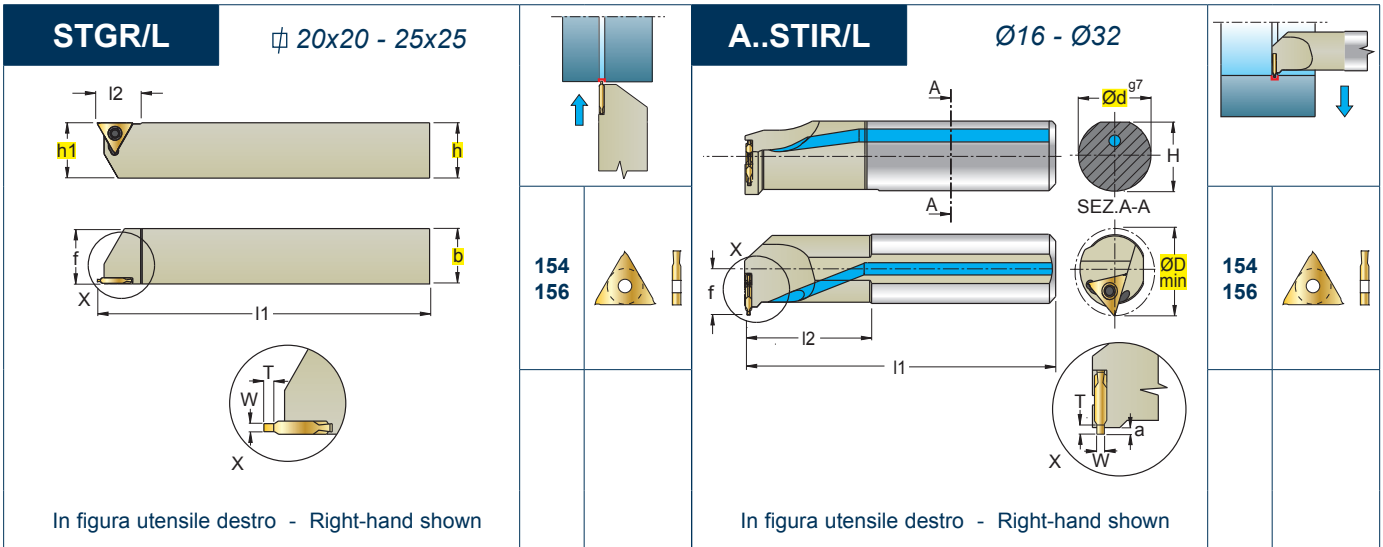

In figura utensile destro - Right-hand shown

In figura utensile destro - Right-hand shown

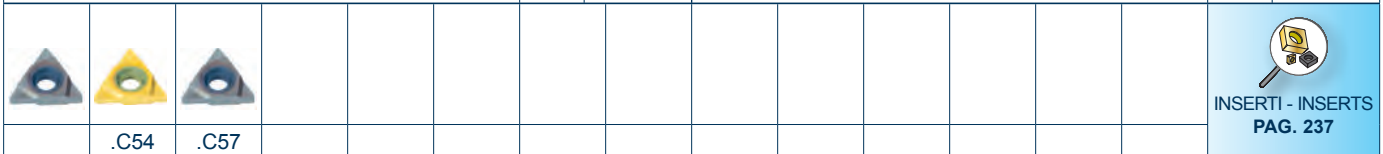

ART.		(mm)											1		2	
R	L	h=h1	b	Ød	ØDmin	f	H	Tmax(*)	a	l1	l2	Nm	W	Key	Key	
STGR/L	2020 K 16-3	20	20	-	-	20	-	-	-	125	20	3,5+4,0	1,1+4,15	124095P	5515P	
STGR/L	2525 M 16-3	25	25	-	-	25	-	-	-	150	20	3,5+4,0		124095P	5515P	

A16M	STIR/L 16-3	-	-	16	20	11	15,25	-	2	150	35	3,5+4,0	1,1+4,15	124095P	5515P
A20Q	STIR/L 16-3	-	-	20	25	13	19,00	-	2	180	40	3,5+4,0		124095P	5515P
A25R	STIR/L 16-3	-	-	25	32	17	24,00	-	3	200	50	3,5+4,0		124095P	5515P
A32S	STIR/L 16-3	-	-	32	40	22	31,00	-	3	250	55	3,5+4,0		124095P	5515P

Tmax(*) VEDI PAGINA INSERTI
 Tmax(*) SEE PAGE OF INSERTS
 Tmax(*) SIEHE WENDESCHNEIDPLATTENSEITE
 Tmax(*) VOIR PAGE DES PLAQUETTES

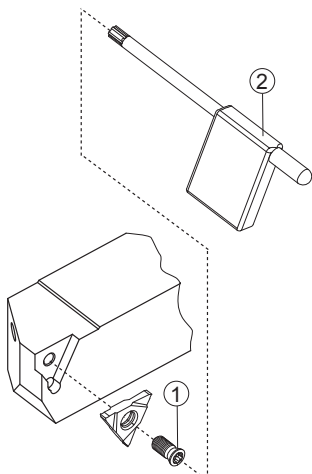

CAMPI D'IMPIEGO DEGLI INSERTI PER TAGLIO-SCANALATURA
 FIELDS OF APPLICATION FOR PARTING AND GROOVING INSERTS
 EINSATZBEREICH FÜR ABSTECH- UND NUTENDREHWENDEPLATTEN
 CHAMPS D'USINAGE DES PLAQUETTES POUR TRONÇONNAGE-GORGES

VELOCITÀ DI TAGLIO Vc
 Vc. CUTTING SPEED
 Vc. SCHNITTGESCHWINDIGKEIT
 Vc. VITESSE DE COUPE

DETTAGLIO RICAMBI
 SPARE PARTS DETAILS
 DETAILS ZU DEN ERSATZTEILEN
 DÉTAIL DE PIÈCES DE RECHANGE

DATI TECNICI E CONSIGLI
 TECHNICAL DATA AND SUGGESTIONS
 TECHNISCHE DATEN UND EMPFEHLUNGEN
 DONNÉES TECHNIQUES ET CONSEILS

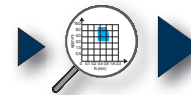

PAG. 250



PAG. 248



PAG. 1103



PAG. 1129

SCELTA VELOCE - QUICK PICK												Toughness		Pag. 242		HT	HW	HC									
COD.	P			M			K			N			S			H			N3440	F4340	W	s	l	d	T	d1	
	F	M	R	F	M	R	F	M	R	F	M	R	F	M	R	F	M	R									
154.15-16110	●	●	●	●	●	●	●	●	●	●	●	●	●	●	●				■		1,25	2,5	16	9,52	1,2	4,5	
154.15-16130	●	●	●	●	●	●	●	●	●	●	●	●	●	●	●				■		1,45	2,5	16	9,52	1,5	4,5	
154.15-16160	●	●	●	●	●	●	●	●	●	●	●	●	●	●	●				■		1,80	2,5	16	9,52	1,8	4,5	
154.15-16185	●	●	●	●	●	●	●	●	●	●	●	●	●	●	●				■		2,00	2,5	16	9,52	3	4,5	
154.15-16215	●	●	●	●	●	●	●	●	●	●	●	●	●	●	●				■		2,30	2,8	16	9,52	3	4,5	
154.15-16265	●	●	●	●	●	●	●	●	●	●	●	●	●	●	●				■		2,80	3,3	16	9,52	3	4,5	
154.15-16315	●	●	●	●	●	●	●	●	●	●	●	●	●	●	●				■		3,35	3,8	16	9,52	3	4,5	
CON ADDUZIONE LUBROREFRIGERANTE - WITH COOLANT SUPPLY												●	●														
SENZA ADDUZIONE LUBROREFRIGERANTE - WITHOUT COOLANT SUPPLY																											

- SI POSSONO UTILIZZARE GLI INSERTI DI PRECISIONE 156... VEDI PAG 237
- PRECISION INSERTS 156... (SEE PAGE 237) CAN BE USED
- DIE PRÄZISIONSWENDESCHNEIDPLATTEN 156... (s.SEITE 237) KÖNNEN EINGESETZT WERDEN.
- ON PEUT UTILISER LES PLAQUETTES DE PRECISION 156... VOIR PAGE 237

MATERIALI - MATERIALS Pag. 1199		VDI 3323 GR.	HB Rm ¹⁾ HRC ²⁾	fn mm			Vc m/min		Pag. 248						
				F	M	R	N3440	F4340							
P	ACCIAIO NON LEGATO - NOT ALLOY STEEL	1-5	125-300	0,06	0,12	0,26		240							
	ACCIAIO POCO LEGATO - LOW ALLOY STEEL	6-9	180-350	0,05	0,1	0,25		190							
	ACCIAIO ALTO LEGATO - ALLOY STEEL	10-11	200-325	0,05	0,1	0,25		150							
	INOX MARTENS. - STAINLESS STEEL MART	12-13	200-240	0,05	0,1	0,25		120							
M	INOX AUST. DUPLEX - STAINLESS STEEL AUST	14.1-14.2	180-230	0,05	0,1	0,25		120							
K	GHISA GRIGIA - GREY CAST IRON	15-16	180-260	0,06	0,12	0,25	180								
	GHISA SFEROIDALE - SPHEROIDAL GRAPHITE	17-18	160-250	0,05	0,1	0,25	150								
	GHISA MALLEABILE - MALLEABLE CAST IRON	19-20	130-230	0,05	0,1	0,25	160								
N	ALLUMINIO E SUE LEGHE - ALUMINIUM	21-25	60-130	0,06	0,1	0,25	650								
	RAME E SUE LEGHE - COPPER	26-28	90-110	0,05	0,1	0,25	500								
	NON METALLICI - PLASTICS	29-30	/	0,05	0,1	0,25	700								
S	LEGHE RESIST. CALORE - HIG. TEMP. ALLOY	31-35	200-320												
	TITANIO E SUE LEGHE - TITANIUM	36-37	400-1050 ¹⁾												
H	ACCIAIO TEMPRATO - HARDENED STEEL	38-41	45-60 ²⁾												

- = SCANALATURA - GROOVING
- Vc = m/min VELOCITÀ DI TAGLIO - CUTTING SPEED
- n = giri/min (min⁻¹) NUMERO DI GIRI - NUMBER OF REVOLUTIONS
- fn = mm AVANZAMENTO AL GIRO - FEED / REVOLUTION
- Vf = mm/min VELOCITÀ DI AVANZAMENTO - FEED SPEED
- W = mm LARGHEZZA TAGLIANTE - CUTTING EDGE WIDTH

$$n = \frac{Vc \cdot 1000}{\varnothing D \cdot 3,14} = \text{giri/min (min}^{-1}\text{)}$$

$$Vf = fn \cdot n = \text{mm/min}$$

- DISPONIBILI - IN STOCK - LIEFERBAR - DISPONIBLES / ■ NEW
- APPLICAZIONE CONSIGLIATA-RECOMMENDED APPLICATION
- A RICHIESTA - ON REQUEST - AUF ANFRAGE - SUR DEMANDE / □ NEW
- APPLICAZIONE POSSIBILE - POSSIBLE APPLICATION
- MÖGLICHE ANWENDUNG - APPLICATION POSSIBLE

THE - 7 - .. R/L
THS - 7 - .. R/L

∅ 8x8 - 25x25

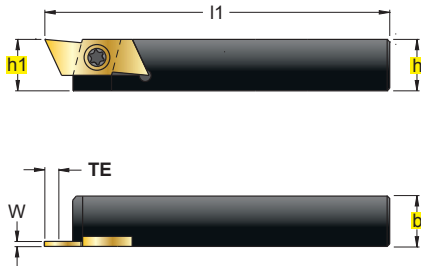

**IN ESAURIMENTO
END OF STOCK
AUSLAUFEND
EN ÉPUISEMENT**

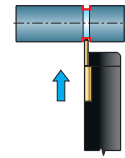

GIE-7-..

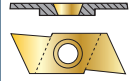

In figura utensile destro - Right-hand shown

ART.									①		②		③	
									123008P		5508P			
ART.				(mm)			Nm		w					
-GP/-ST	-SG	-GR	-GW											
THE - 7 - 0808 R / L				08	08	100	1,2+1,5	0,5-3,0						
THE - 7 - 1010 R / L				10	10	120	1,2+1,5							
THE - 7 - 1212 R / L				12	12	120	1,2+1,5							
THE - 7 - 1616 R / L				16	16	125	1,2+1,5							
THE - 7 - 2020 R / L				20	20	125	1,2+1,5							
THE - 7 - 2525 R / L				25	25	125	1,2+1,5							
UTENSILI PER MACCHINE A FANTINA MOBILE - TOOLS FOR SLIDING HEADSTOCK MACHINES														
THS - 7 - 0808 R / L				08	08	140	1,2+1,5	0,5-3,0						
THS - 7 - 1010 R / L				10	10	150	1,2+1,5							

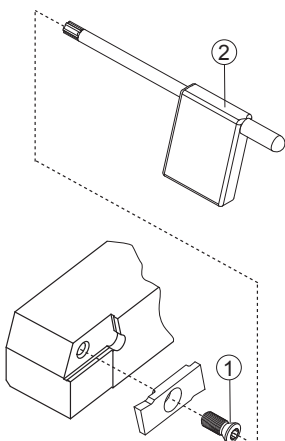
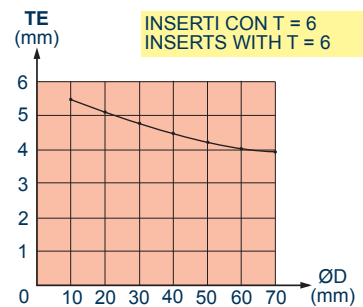
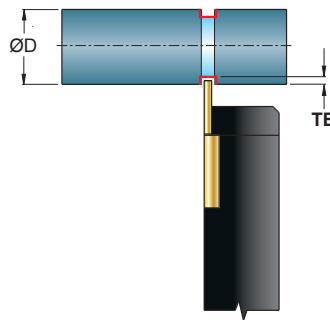
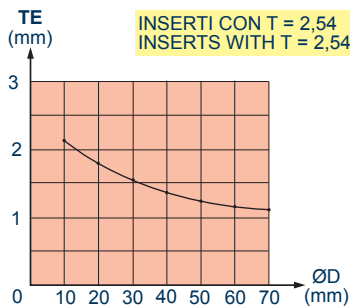

■ CAMPI D'IMPIEGO DEGLI INSERTE PER TAGLIO-SCANALATURA
■ FIELDS OF APPLICATION FOR PARTING AND GROOVING INSERTS
■ EINSATZBEREICH FÜR ABSTECH- UND NUTDREHWENDEPLATTEN
■ CHAMPS D'USINAGE DES PLAQUETTES POUR TRONÇONNAGE-GORGES

■ VELOCITÀ DI TAGLIO Vc
■ Vc. CUTTING SPEED
■ Vc. SCHNITTGESCHWINDIGKEIT
■ Vc. VITESSE DE COUPE

■ DETTAGLIO RICAMBI
■ SPARE PARTS DETAILS
■ DETAILS ZU DEN ERSATZTEILEN
■ DÉTAIL DE PIÈCES DE RECHANGE

■ DATI TECNICI E CONSIGLI
■ TECHNICAL DATA AND SUGGESTIONS
■ TECHNISCHE DATEN UND EMPFEHLUNGEN
■ DONNÉES TECHNIQUES ET CONSEILS

PAG. 250

PAG. 248

PAG. 1103

PAG. 1129

SCelta VELOCE - QUICK PICK

Tenacità + ↑
Toughness - ↓

Pag. 242

COD.	P	M	K	N	S	H	HT	HW	HC	C5PV	W	β	R	T	H	S	L
GIE - 7 - GP - 1.0 R - N	●	●								■	1,0	-	-	6,0	7	2	17
GIE - 7 - GP - 1.0 L - N	●	●								■	1,0	-	-	6,0	7	2	17
GIE - 7 - GP - 1.5 R - N	●	●								■	1,5	-	-	6,0	7	2	17
GIE - 7 - GP - 1.5 R - R	●	●								■	1,5	-	-	6,0	7	2	17
GIE - 7 - GP - 1.5 L - N	●	●								■	1,5	-	-	6,0	7	2	17
GIE - 7 - GP - 1.5 L - R	●	●								■	1,5	-	-	6,0	7	2	17
GIE - 7 - GP - 1.5 L - L	●	●								■	1,5	-	-	6,0	7	2	17
GIE - 7 - GP - 2.0 R - N	●	●								■	2,0	-	-	6,0	7	2	17
GIE - 7 - GP - 2.0 R - R	●	●								■	2,0	-	-	6,0	7	2	17
GIE - 7 - GP - 2.0 L - N	●	●								■	2,0	-	-	6,0	7	2	17
GIE - 7 - ST - 3.0 R	●	●								□	3,17	-	-	-	7	3,17	17
GIE - 7 - ST - 3.0 L	●	●								□	3,17	-	-	-	7	3,17	17
GIE - 7 - SG - 0.5 R	●	●								■	0,50	-	-	2,54	7	2	17
GIE - 7 - SG - 0.5 L	●	●								■	0,50	-	-	2,54	7	2	17
GIE - 7 - SG - 0.7 R	●	●								■	0,70	-	-	2,54	7	2	17
GIE - 7 - SG - 0.7 L	●	●								■	0,70	-	-	2,54	7	2	17
GIE - 7 - SG - 0.8 R	●	●								■	0,80	-	-	2,54	7	2	17
GIE - 7 - SG - 0.8 L	●	●								□	0,80	-	-	2,54	7	2	17
GIE - 7 - SG - 0.9 R	●	●								■	0,90	-	-	2,54	7	2	17
GIE - 7 - SG - 0.9 L	●	●								■	0,90	-	-	2,54	7	2	17
GIE - 7 - SG - 1.1 R	●	●								■	1,10	-	-	6,00	7	2	17
GIE - 7 - SG - 1.1 L	●	●								□	1,10	-	-	6,00	7	2	17
GIE - 7 - SG - 1.3 R	●	●								■	1,30	-	-	6,00	7	2	17
GIE - 7 - SG - 1.3 L	●	●								□	1,30	-	-	6,00	7	2	17
GIE - 7 - SG - 1.6 R	●	●								■	1,60	-	-	6,00	7	2	17
GIE - 7 - SG - 1.6 L	●	●								■	1,60	-	-	6,00	7	2	17
GIE - 7 - SG - 1.85 R	●	●								■	1,85	-	-	6,00	7	2	17
GIE - 7 - SG - 1.85 L	●	●								□	1,85	-	-	6,00	7	2	17
GIE - 7 - GR - 1.0 R	●	●								■	1,0	-	0,50	6	7	2	17
GIE - 7 - GR - 1.0 L	●	●								□	1,0	-	0,50	6	7	2	17
GIE - 7 - GR - 1.5 R	●	●								■	1,5	-	0,75	6	7	2	17
GIE - 7 - GR - 1.5 L	●	●								■	1,5	-	0,75	6	7	2	17
GIE - 7 - GR - 2.0 R	●	●								■	2,0	-	1,00	6	7	2	17
GIE - 7 - GR - 2.0 L	●	●								■	2,0	-	1,00	6	7	2	17
GIE - 7 - GW - 60 R	●	●								■	-	60°	0,10	-	7	2	17
GIE - 7 - GW - 60 L	●	●								■	-	60°	0,10	-	7	2	17
GIE - 7 - GW - 55 R	●	●								■	-	55°	0,12	-	7	2	17
GIE - 7 - GW - 55 L	●	●								□	-	55°	0,12	-	7	2	17

CON ADDUZIONE LUBROREFRIGERANTE - WITH COOLANT SUPPLY

SENZA ADDUZIONE LUBROREFRIGERANTE - WITHOUT COOLANT SUPPLY

**IN ESAURIMENTO
END OF STOCK
AUSLAUFEND
EN ÉPUISEMENT**

MATERIALI - MATERIALS Pag. 1199	VDI 3323 GR.	HB Rm ¹⁾ HRC ²⁾	fn mm			C5PV	Vc m/min Pag. 248										
			F	M	R												
P ACCIAIO NON LEGATO - NOT ALLOY STEEL	1--5	125-300	0,03	0,05	0,10	140											
	6--9	180-350	0,03	0,05	0,10	105											
	10-11	200-325	0,03	0,05	0,10	105											
	INOX MARTENS. - STAINLESS STEEL MART	12-13	200-240	0,03	0,05	0,10	120										
M INOX AUST. DUPLEX - STAINLESS STEEL AUST	14.1-14.2	180-230	0,03	0,05	0,10	105											
K GHISA GRIGIA - GREY CAST IRON	15-16	180-260															
	GHISA SFEROIDALE - SPHEROIDAL GRAPHITE	17-18	160-250														
	GHISA MALLEABILE - MALLEABLE CAST IRON	19-20	130-230														
N ALLUMINIO E SUE LEGHE - ALUMINIUM	21--25	60-130															
	RAME E SUE LEGHE - COPPER	26--28	90-110														
	NON METALLICI - PLASTICS	29-30	/														
S LEGHE RESIST. CALORE - HIG. TEMP. ALLOY	31--35	200-320															
	TITANIO E SUE LEGHE - TITANIUM	36-37	400-1050 ¹⁾														
H ACCIAIO TEMPRATO - HARDENED STEEL	38--41	45-60 ²⁾															

= SCANALATURA - GROOVING

- Vc = m/min VELOCITÀ DI TAGLIO - CUTTING SPEED
- n = giri/min (min⁻¹) NUMERO DI GIRI - NUMBER OF REVOLUTIONS
- fn = mm AVANZAMENTO AL GIRO - FEED / REVOLUTION
- Vf = mm/min VELOCITÀ DI AVANZAMENTO - FEED SPEED
- W = mm LARGHEZZA TAGLIANTE - CUTTING EDGE WIDTH

$$n = \frac{Vc \cdot 1000}{\varnothing D \cdot 3,14} = \text{giri/min (min}^{-1}\text{)}$$

$$Vf = fn \cdot n = \text{mm/min}$$

THI - 7 - .. R/L

Ø20 - Ø32

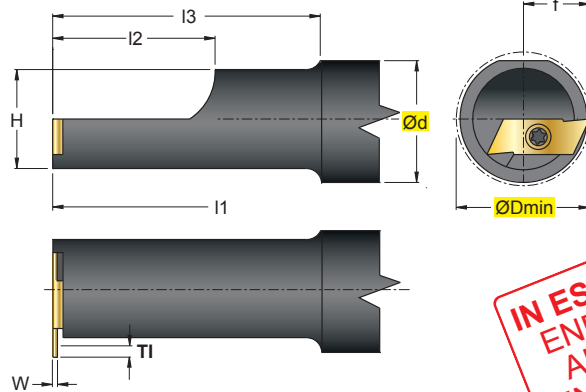

**IN ESAURIMENTO
END OF STOCK
AUSLAUFEND
EN ÉPUISEMENT**

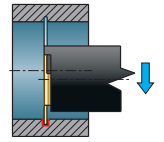

GIE-7-..

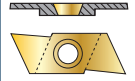

In figura utensile destro - Right-hand shown

																			INSERTI - INSERTS PAG. 240
-GP/-ST	-SG	-GR	-GW																

ART.	(mm)												①	②	③
	ØDmin	Ød	f	H	l1	l2	l3				Nm	w			
THI - 7 - 20 R / L	38,10	20	13,34	19,05	140	25	50				1,2÷1,5	0,5-3,0			123008P 5508P
THI - 7 - 25 R / L	38,10	25	13,34	19,05	150	32	63				1,2÷1,5				
THI - 7 - 32 R / L	38,10	32	13,34	19,05	150	32	63				1,2÷1,5				

PER UTENSILI DESTRI (R) INSERTO SINISTRO (L) - PER UTENSILI SINISTRI (L) INSERTO DESTRO (R)
 FOR RIGHT TOOLS (R) LEFT INSERT (L) - FOR LEFT TOOLS (L) RIGHT INSERT (R)
 FÜR RECHTE WERKZEUGE (R) LINKE PLATTEN (L) - FÜR LINKE WERKZEUGE (L) RECHTE PLATTEN (R)
 POUR OUTILS DROITS (R) PLAQUETTE GAUCHE (L) - POUR OUTILS GAUCHES (L) PLAQUETTE DROITE (R)

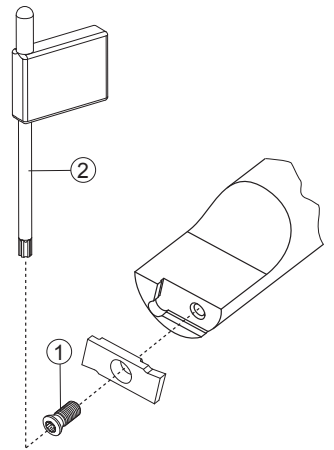
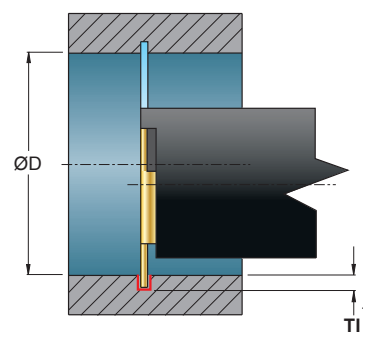
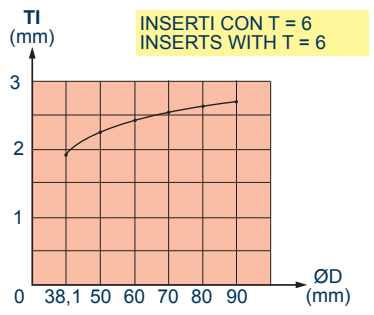

- CAMPI D'IMPIEGO DEGLI INSERTI PER TAGLIO-SCANALATURA
FIELDS OF APPLICATION FOR PARTING AND GROOVING INSERTS
EINSATZBEREICH FÜR ABSTECH- UND NUTDREHWENDEPLATTEN
CHAMPS D'USINAGE DES PLAQUETTES POUR TRONÇONNAGE-GORGES **PAG. 250**
- VELOCITÀ DI TAGLIO Vc
Vc. CUTTING SPEED
Vc. SCHNITTGESCHWINDIGKEIT
Vc. VITESSE DE COUPE **PAG. 248**
- DETTAGLIO RICAMBI
SPARE PARTS DETAILS
DETAILS ZU DEN ERSATZTEILEN
DÉTAIL DE PIÈCES DE RECHANGE **PAG. 1103**
- DATI TECNICI E CONSIGLI
TECHNICAL DATA AND SUGGESTIONS
TECHNISCHE DATEN UND EMPFEHLUNGEN
DONNÉES TECHNIQUES ET CONSEILS **PAG. 1129**

SCelta VELOCE - QUICK PICK

Tenacità + ↑
Toughness - ↓

Pag. 242

COD.	P	M	K	N	S	H	HT	HW	HC	C5PV	W	β	R	T	H	S	L	Diagram	
																		GIE...GP...	GIE...ST...
GIE - 7 - GP - 1.0 R - N	●	●									1,0	-	-	6,0	7	2	17		
GIE - 7 - GP - 1.0 L - N	●	●									1,0	-	-	6,0	7	2	17		
GIE - 7 - GP - 1.5 R - N	●	●									1,5	-	-	6,0	7	2	17		
GIE - 7 - GP - 1.5 R - R	●	●									1,5	-	-	6,0	7	2	17		
GIE - 7 - GP - 1.5 L - N	●	●									1,5	-	-	6,0	7	2	17		
GIE - 7 - GP - 1.5 L - R	●	●									1,5	-	-	6,0	7	2	17		
GIE - 7 - GP - 1.5 L - L	●	●									1,5	-	-	6,0	7	2	17		
GIE - 7 - GP - 2.0 R - N	●	●									2,0	-	-	6,0	7	2	17		
GIE - 7 - GP - 2.0 R - R	●	●									2,0	-	-	6,0	7	2	17		
GIE - 7 - GP - 2.0 L - N	●	●									2,0	-	-	6,0	7	2	17		
GIE - 7 - ST - 3.0 R	●	●									3,17	-	-	-	7	3,17	17		
GIE - 7 - ST - 3.0 L	●	●									3,17	-	-	-	7	3,17	17		
GIE - 7 - SG - 0.5 R	●	●									0,50	-	-	2,54	7	2	17		
GIE - 7 - SG - 0.5 L	●	●									0,50	-	-	2,54	7	2	17		
GIE - 7 - SG - 0.7 R	●	●									0,70	-	-	2,54	7	2	17		
GIE - 7 - SG - 0.7 L	●	●									0,70	-	-	2,54	7	2	17		
GIE - 7 - SG - 0.8 R	●	●									0,80	-	-	2,54	7	2	17		
GIE - 7 - SG - 0.8 L	●	●									0,80	-	-	2,54	7	2	17		
GIE - 7 - SG - 0.9 R	●	●									0,90	-	-	2,54	7	2	17		
GIE - 7 - SG - 0.9 L	●	●									0,90	-	-	2,54	7	2	17		
GIE - 7 - SG - 1.1 R	●	●									1,10	-	-	6,00	7	2	17		
GIE - 7 - SG - 1.1 L	●	●									1,10	-	-	6,00	7	2	17		
GIE - 7 - SG - 1.3 R	●	●									1,30	-	-	6,00	7	2	17		
GIE - 7 - SG - 1.3 L	●	●									1,30	-	-	6,00	7	2	17		
GIE - 7 - SG - 1.6 R	●	●									1,60	-	-	6,00	7	2	17		
GIE - 7 - SG - 1.6 L	●	●									1,60	-	-	6,00	7	2	17		
GIE - 7 - SG - 1.85 R	●	●									1,85	-	-	6,00	7	2	17		
GIE - 7 - SG - 1.85 L	●	●									1,85	-	-	6,00	7	2	17		
GIE - 7 - GR - 1.0 R	●	●									1,0	-	0,50	6	7	2	17		
GIE - 7 - GR - 1.0 L	●	●									1,0	-	0,50	6	7	2	17		
GIE - 7 - GR - 1.5 R	●	●									1,5	-	0,75	6	7	2	17		
GIE - 7 - GR - 1.5 L	●	●									1,5	-	0,75	6	7	2	17		
GIE - 7 - GR - 2.0 R	●	●									2,0	-	1,00	6	7	2	17		
GIE - 7 - GR - 2.0 L	●	●									2,0	-	1,00	6	7	2	17		
GIE - 7 - GW - 60 R	●	●									-	60°	0,10	-	7	2	17		
GIE - 7 - GW - 60 L	●	●									-	60°	0,10	-	7	2	17		
GIE - 7 - GW - 55 R	●	●									-	55°	0,12	-	7	2	17		
GIE - 7 - GW - 55 L	●	●									-	55°	0,12	-	7	2	17		

CON ADDUZIONE LUBROREFRIGERANTE - WITH COOLANT SUPPLY

SENZA ADDUZIONE LUBROREFRIGERANTE - WITHOUT COOLANT SUPPLY

**IN ESAURIMENTO
END OF STOCK
AUSLAUFEND
EN ÉPUISEMENT**

MATERIALI - MATERIALS Pag. 1199	VDI 3323 GR.	HB Rm ¹⁾ HRC ²⁾	fn mm			C5PV	Vc m/min Pag. 248													
			F	M	R															
P ACCIAIO NON LEGATO - NOT ALLOY STEEL	1-5	125-300	0,03	0,05	0,10	140														
P ACCIAIO POCO LEGATO - LOW ALLOY STEEL	6-9	180-350	0,03	0,05	0,10	105														
P ACCIAIO ALTO LEGATO - ALLOY STEEL	10-11	200-325	0,03	0,05	0,10	105														
P INOX MARTENS. - STAINLESS STEEL MART	12-13	200-240	0,03	0,05	0,10	120														
M INOX AUST. DUPLEX - STAINLESS STEEL AUST	14.1-14.2	180-230	0,03	0,05	0,10	105														
K GHISA GRIGIA - GREY CAST IRON	15-16	180-260																		
K GHISA SFEROIDALE - SPHEROIDAL GRAPHITE	17-18	160-250																		
K GHISA MALLEABILE - MALLEABLE CAST IRON	19-20	130-230																		
N ALLUMINIO E SUE LEGHE - ALUMINIUM	21-25	60-130																		
N RAME E SUE LEGHE - COPPER	26-28	90-110																		
N NON METALLICI - PLASTICS	29-30	/																		
S LEGHE RESIST. CALORE - HIG. TEMP. ALLOY	31-35	200-320																		
S TITANIO E SUE LEGHE - TITANIUM	36-37	400-1050 ¹⁾																		
H ACCIAIO TEMPRATO - HARDENED STEEL	38-41	45-60 ²⁾																		

= SCANALATURA - GROOVING

- Vc = m/min VELOCITÀ DI TAGLIO - CUTTING SPEED
- n = giri/min (min⁻¹) NUMERO DI GIRI - NUMBER OF REVOLUTIONS
- fn = mm AVANZAMENTO AL GIRO - FEED / REVOLUTION
- Vf = mm/min VELOCITÀ DI AVANZAMENTO - FEED SPEED
- W = mm LARGHEZZA TAGLIANTE - CUTTING EDGE WIDTH

$$n = \frac{Vc \cdot 1000}{\varnothing D \cdot 3,14} = \text{giri/min (min}^{-1}\text{)}$$

$$Vf = fn \cdot n = \text{mm/min}$$

■ DISPONIBILI - IN STOCK - LIEFERBAR - DISPONIBLES / ■ NEW
●● APPLICAZIONE CONSIGLIATA-RECOMMENDED APPLICATION
EMPFÖHLENER EINSATZ - APPLICATION CONSEILLÉE

□ A RICHIESTA - ON REQUEST - AUF ANFRAGE - SUR DEMANDE / □ NEW
○● APPLICAZIONE POSSIBILE - POSSIBLE APPLICATION
MÖGLICHE ANWENDUNG - APPLICATION POSSIBLE

SCTFPR/L

∅ 25x25

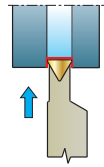
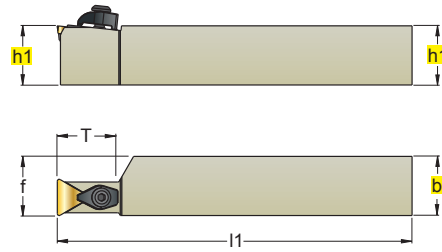









TPMR



C



In figura utensile destro - Right-hand shown

											 INSERTI - INSERTS PAG. 206				
.S44															
ART. (mm)															
											1	2	3	4	5
															
											h1	b	f	l1	T
SCTFPR/L	2525	M 11	25	25	25	150	22	1103	2304C	5025	-	-			
SCTFPR/L	2525	M 16	25	25	25	150	25	1603	2305C	5003	3116	4002			

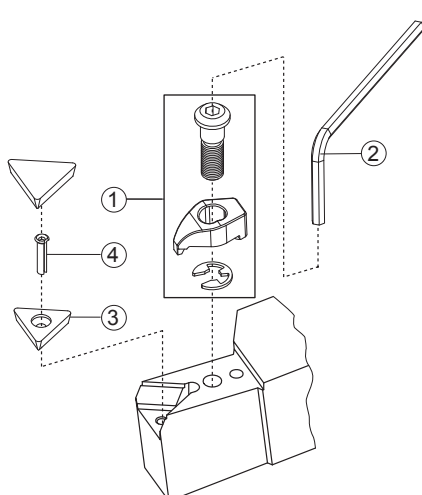





 CAMPI D'IMPIEGO DEGLI INSERTI PER TAGLIO-SCANALATURA
 FIELDS OF APPLICATION FOR PARTING AND GROOVING INSERTS
 EINSATZBEREICH FÜR ABSTECH- UND NUTENDREHWENDEPLATTEN
 CHAMPS D'USINAGE DES PLAQUETTES POUR TRONÇONNAGE-GORGES





 **PAG. 250**

 VELOCITÀ DI TAGLIO Vc
 Vc. CUTTING SPEED
 Vc. SCHNITTGESCHWINDIGKEIT
 Vc. VITESSE DE COUPE

 **PAG. 248**

 DETTAGLIO RICAMBI
 SPARE PARTS DETAILS
 DETAILS ZU DEN ERSATZTEILEN
 DÉTAIL DE PIÈCES DE RECHANGE

 **PAG. 1103**

 DATI TECNICI E CONSIGLI
 TECHNICAL DATA AND SUGGESTIONS
 TECHNISCHE DATEN UND EMPFEHLUNGEN
 DONNÉES TECHNIQUES ET CONSEILS

 **PAG. 1129**

SCELTA VELOCE - QUICK PICK



COD.	MATERIALI												HT	HW	HC					I	d	s	d1	r	a°			
	P			M			K			N					S			H										
	F	M	R	F	M	R	F	M	R	F	M	R			F	M	R	F	M							R		
TPMR 110304 .S44	●	●	○	○	○	○	○	○	○	○	○	○	○	○	○	○	○	○										
TPMR 110308 .S44	●	○	○	○	○	○	○	○	○	○	○	○	○	○	○	○	○	○										
TPMR 160304 .S44	●	○	○	○	○	○	○	○	○	○	○	○	○	○	○	○	○	○										
TPMR 160308 .S44	●	○	○	○	○	○	○	○	○	○	○	○	○	○	○	○	○	○										

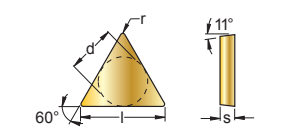

CON ADDUZIONE LUBROREFRIGERANTE - WITH COOLANT SUPPLY																	
SENZA ADDUZIONE LUBROREFRIGERANTE - WITHOUT COOLANT SUPPLY																	

MATERIALI - MATERIALS Pag. 1199	VDI 3323 GR.	HB Rm ¹⁾ HRC ²⁾	Vc m/min Pag. 222				
			T1625	T7725			
P ACCIAIO NON LEGATO - NOT ALLOY STEEL	1--5	125-300	380	300			
ACCIAIO POCO LEGATO - LOW ALLOY STEEL	6--9	180-350	300	230			
ACCIAIO ALTO LEGATO - ALLOY STEEL	10-11	200-325	220	180			
INOX MARTENS. - STAINLESS STEEL MART	12-13	200-240	200	200			
M INOX AUST. DUPLEX - STAINLESS STEEL AUST	14.1-14.2	180-230	200	195			
K GHISA GRIGIA - GREY CAST IRON	15-16	180-260	180	160			
GHISA SFEROIDALE - SPHEROIDAL GRAPHITE	17-18	160-250	130	130			
GHISA MALLEABILE - MALLEABLE CAST IRON	19-20	130-230	150	150			
N ALLUMINIO E SUE LEGHE - ALUMINIUM	21--25	60-130					
RAME E SUE LEGHE - COPPER	26--28	90-110					
NON METALLICI - PLASTICS	29-30	/					
S LEGHE RESIST. CALORE - HIG. TEMP. ALLOY	31--35	200-320					
TITANIO E SUE LEGHE - TITANIUM	36-37	400-1050 ¹⁾					
H ACCIAIO TEMPRATO - HARDENED STEEL	38--41	45-60 ²⁾					

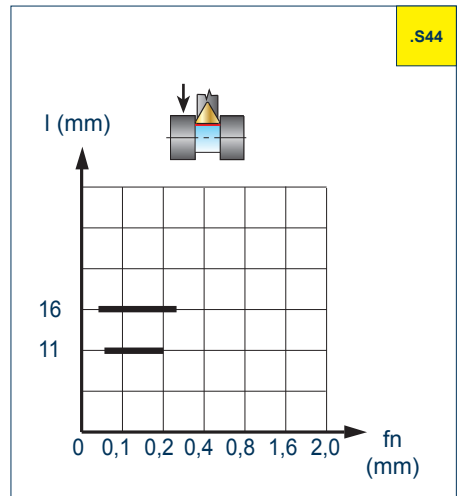

= SCANALATURA - GROOVING
Vc = m/min VELOCITÀ DI TAGLIO - CUTTING SPEED
n = giri/min (min⁻¹) NUMERO DI GIRI - NUMBER OF REVOLUTIONS
fn = mm AVANZAMENTO AL GIRO - FEED / REVOLUTION
Vf = mm/min VELOCITÀ DI AVANZAMENTO - FEED SPEED
l = mm LARGHEZZA TAGLIANTE - CUTTING EDGE WIDTH

$Vf = fn \cdot n = \text{mm/min}$

$$n = \frac{Vc \cdot 1000}{\varnothing D \cdot 3,14} = \text{giri/min (min}^{-1}\text{)}$$

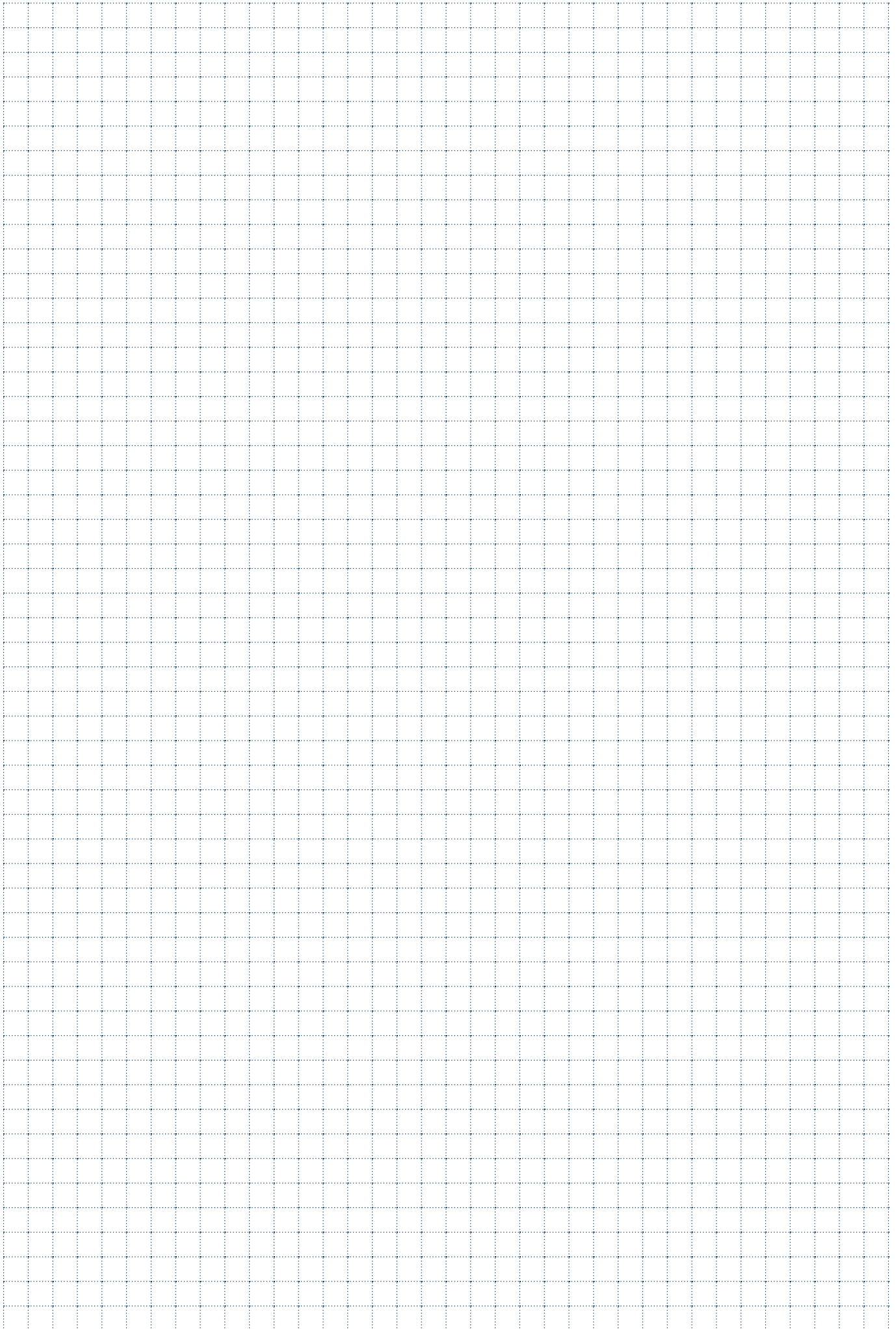

D 		D 		P 		S 		S 	
SC.. DCLNR/L Pag.166		SC63 DCMNN Pag.168		SC.. PCLNR/L Pag.170		SC.. SCLCR/L Pag.173		SC63 SCMNC Pag.177	
									
CNM. 1204..		CNM. 1204..		CNM. 1204..		CC.. 1204..		CC.. 1204..	
<i>PSC50 - PSC63</i>		<i>PSC63</i>		<i>PSC40 - PSC50 - PSC63</i>		<i>PSC40 - PSC50 - PSC63</i>		<i>PSC63</i>	
SC.. DWLNR/L Pag.167		SC63 DDMNL Pag.169		SC.. PDJNR/L Pag.171		SC.. SDJCR/L Pag.174		SC63 SVMBL Pag.178	
									
WNM. 0804..		DNM. 1506..		DNM. 1506..		DC.. 11T3..		VB.. 1604..	
<i>PSC50 - PSC63</i>		<i>PSC63</i>		<i>PSC50 - PSC63</i>		<i>PSC40 - PSC50 - PSC63</i>		<i>PSC63</i>	
				SC.. PWLNR/L Pag.172		SC.. SVHBR/L Pag.175			
									
				WNM. 0804..		VB.. 1604..			
				<i>PSC40 - PSC50 - PSC63</i>		<i>PSC40 - PSC50 - PSC63</i>			
						SC.. SVJBR/L Pag.176			
									
						VB.. 1604..			
						<i>PSC40 - PSC50 - PSC63</i>			
								PSC.C63.1PAR/L Pag.1043	
									
								PSC.C63.U45 Pag.1043	
									

SC.. DWLNR/L

93°

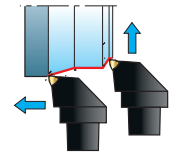
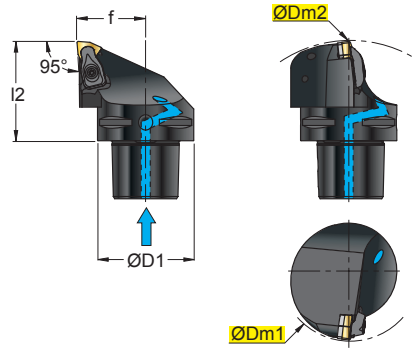

WNMA	
WNMG	
WNMM	



In figura utensile destro - Right-hand shown

		NEW 		NEW 						NEW 				 INSERTI - INSERTS PAG. 199	
.G23	.G61	.F71	.G42	.F51	.G52	.G53	.G55	.G56	.K57P	.F61	.G62	.G63	.G34W		
ART.		(mm)													
			ØDm1	ØDm2	ØD1	f	l2	Nm							
SC50 DWLNR/L 35060-08	PSC50	80	165	50	35	60	3,9	0804	100-21	5415	3308M	125011	5420		
SC63 DWLNR/L 45065-08	PSC63	100	190	63	45	65	3,9								

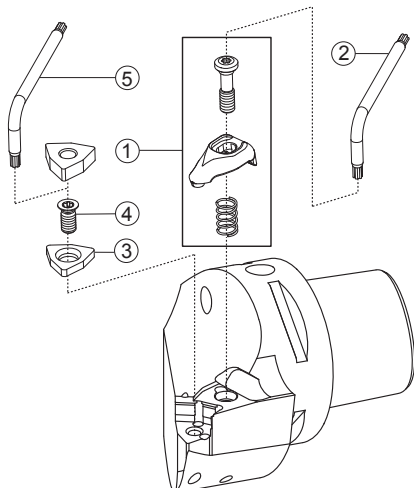

CAMPI D'IMPIEGO DEGLI INSERTI PER TORNITURA
 FIELDS OF APPLICATION FOR TURNING INSERTS
 EINSATZGEBIETE FÜR DREHPLATTEN
 CHAMPS D'USINAGE DES PLAQUETTES POUR TOURNAGE

VELOCITÀ DI TAGLIO Vc
 Vc. CUTTING SPEED
 Vc. SCHNITTGESCHWINDIGKEIT
 Vc. VITESSE DE COUPE

DETTAGLIO RICAMBI
 SPARE PARTS DETAILS
 DETAILS ZU DEN ERSATZTEILEN
 DÉTAIL DE PIÈCES DE RECHANGE

DATI TECNICI E CONSIGLI
 TECHNICAL DATA AND SUGGESTIONS
 TECHNISCHE DATEN UND EMPFEHLUNGEN
 DONNÉES TECHNIQUES ET CONSEILS

PAG. 226

PAG. 222

PAG. 1103

PAG. 1126

SC63 DCMNN

50°

95°

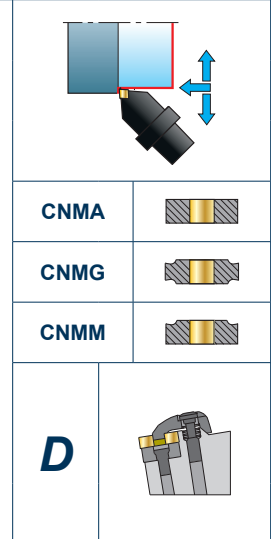
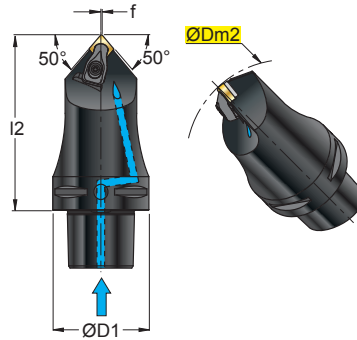

INSERTI - INSERTS
 PAG. 193

ART.	R	I	(mm)					Nm	1204	① ② ③ ④ ⑤					
			ØDm2	ØD1	f	l2									
SC63 DCMNN 00090-12			PSC63	190	63	0	90	3,9		100-21	5415	3612	125011	5420	
SC63 DCMNN 00115-12			PSC63	190	63	0	115	3,9							

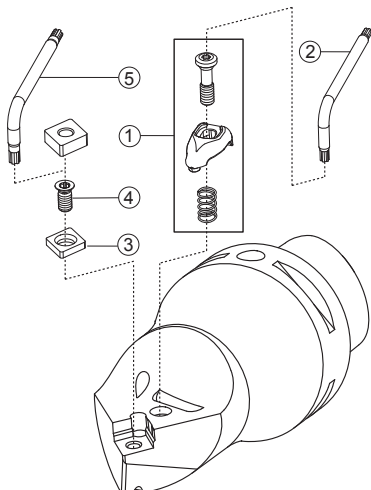

CAMPI D'IMPIEGO DEGLI INSERTI PER TORNATURA
 FIELDS OF APPLICATION FOR TURNING INSERTS
 EINSATZGEBIETE FÜR DREHPLATTEN
 CHAMPS D'USINAGE DES PLAQUETTES POUR TOURNAGE

PAG. 226

VELOCITÀ DI TAGLIO Vc
 Vc. CUTTING SPEED
 Vc. SCHNITTGESCHWINDIGKEIT
 Vc. VITESSE DE COUPE

PAG. 222

DETTAGLIO RICAMBI
 SPARE PARTS DETAILS
 DETAILS ZU DEN ERSATZTEILEN
 DÉTAIL DE PIÈCES DE RECHANGE

PAG. 1103

DATI TECNICI E CONSIGLI
 TECHNICAL DATA AND SUGGESTIONS
 TECHNISCHE DATEN UND EMPFEHLUNGEN
 DONNÉES TECHNIQUES ET CONSEILS

PAG. 1126

SC63 DDMNL

48° 93°

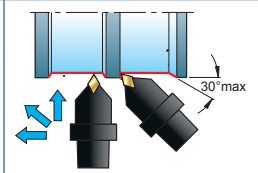
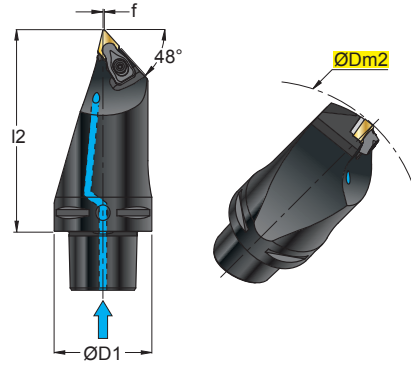

DNMA	
DNMG	
DNMM	

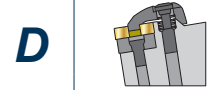

In figura utensile sinistro - Left-hand shown

			NEW 					NEW 						 INSERTI - INSERTS PAG. 195
.G23	.G39	.G42	.F51	.G52	.G53	.G55	.G56	.F61	.G62	.G63	.G68	.G72	.G34W	
ART.				(mm)					①	②	③	④	⑤	○
			ØDm2	ØD1	f	l2	Nm							
SC63 DDMNL 00130-15			PSC63	190	63	0	130	3,9	1506	100-21	5415	3715	125011	5420

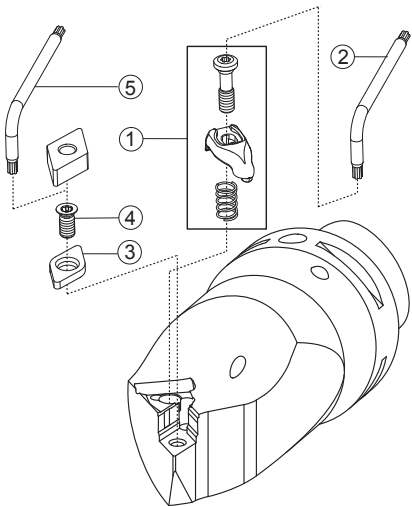

CAMPI D'IMPIEGO DEGLI INSERTI PER TORNITURA
 FIELDS OF APPLICATION FOR TURNING INSERTS
 EINSATZGEBIETE FÜR DREHPLATTEN
 CHAMPS D'USINAGE DES PLAQUETTES POUR TOURNAGE

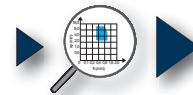

PAG. 226

VELOCITÀ DI TAGLIO Vc
 Vc. CUTTING SPEED
 Vc. SCHNITTGESCHWINDIGKEIT
 Vc. VITESSE DE COUPE



PAG. 222

DETTAGLIO RICAMBI
 SPARE PARTS DETAILS
 DETAILS ZU DEN ERSATZTEILEN
 DÉTAIL DE PIÈCES DE RECHANGE



PAG. 1103

DATI TECNICI E CONSIGLI
 TECHNICAL DATA AND SUGGESTIONS
 TECHNISCHE DATEN UND EMPFEHLUNGEN
 DONNÉES TECHNIQUES ET CONSEILS



PAG. 1126

SC.. PCLNR/L

95°

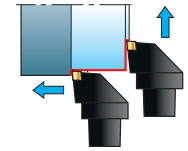
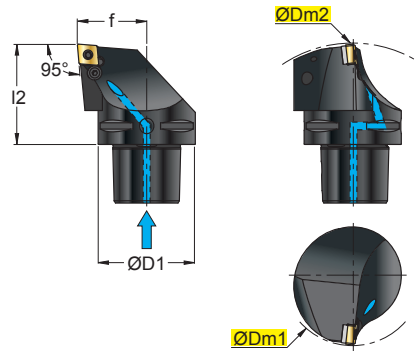

CNMA	
CNMG	
CNMM	

P



In figura utensile destro - Right-hand shown

		NEW				NEW						NEW						 INSERTI - INSERTS PAG. 193
.G23	.G61	.F71	.X47	.G39	.G42	.F51	.G52	.G53	.G55	.G56	.K57P	.F61	.G62	.G63	.G68	.G72	.G34W	

ART.		(mm)							① ② ③ ④ ⑤ ⑥					
		ØDm1	ØDm2	ØD1	f	l2								
SC40 PCLNR/L 27050-12	PSC40	70	140	40	27	50	1204	8012	1608	5003	3612	4112	0012	
SC50 PCLNR/L 35060-12	PSC50	80	165	50	35	60								
SC63 PCLNR/L 45065-12	PSC63	100	190	63	45	65								
SC63 PCLNR/L 45065-16	PSC63	100	190	63	45	65	1604	8016	1618	5003	3616	4115	0015	

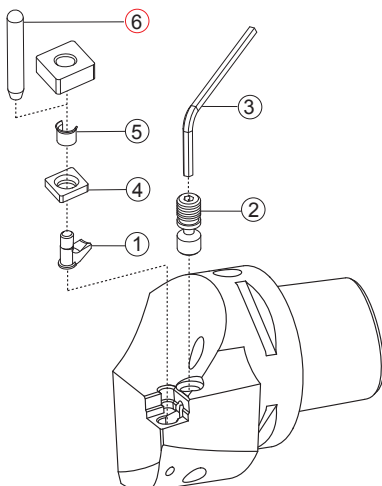

CAMPI D'IMPIEGO DEGLI INSERTI PER TORNITURA
 FIELDS OF APPLICATION FOR TURNING INSERTS
 EINSATZGEBIETE FÜR DREHPLATTEN
 CHAMPS D'USINAGE DES PLAQUETTES POUR TOURNAGE



VELOCITÀ DI TAGLIO Vc
 Vc. CUTTING SPEED
 Vc. SCHNITTGESCHWINDIGKEIT
 Vc. VITESSE DE COUPE



DETTAGLIO RICAMBI
 SPARE PARTS DETAILS
 DETAILS ZU DEN ERSATZTEILEN
 DÉTAIL DE PIÈCES DE RECHANGE



DATI TECNICI E CONSIGLI
 TECHNICAL DATA AND SUGGESTIONS
 TECHNISCHE DATEN UND EMPFEHLUNGEN
 DONNÉES TECHNIQUES ET CONSEILS



SC.. PDJNR/L

93°

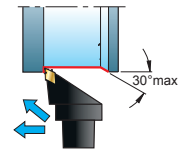
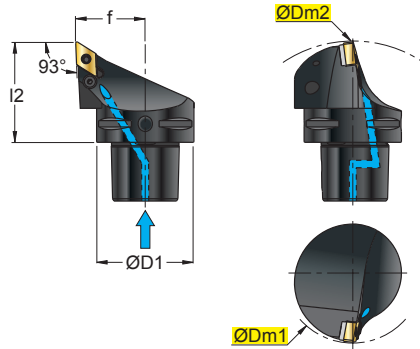

DNMA	
DNMG	
DNMM	

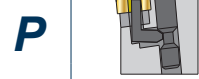

In figura utensile destro - Right-hand shown

			NEW 					NEW 						 INSERTI - INSERTS PAG. 195	
.G23	.G39	.G42	.F51	.G52	.G53	.G55	.G56	.F61	.G62	.G63	.G68	.G72	.G34W		
ART.			(mm)												
			ØDm1	ØDm2	ØD1	f	l2			1	2	3	4	5	6
SC50 PDJNR/L 35060-15			PSC50	80	165	50	35	60	1506	8415	1638	5003	3715	4112	0012
SC63 PDJNR/L 45065-15			PSC63	100	190	63	45	65							

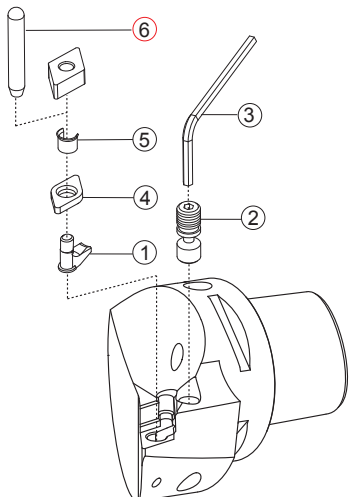

CAMPI D'IMPIEGO DEGLI INSERTI PER TORNITURA
 FIELDS OF APPLICATION FOR TURNING INSERTS
 EINSATZGEBIETE FÜR DREHPLATTEN
 CHAMPS D'USINAGE DES PLAQUETTES POUR TOURNAGE

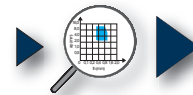

PAG. 226

VELOCITÀ DI TAGLIO Vc
 Vc. CUTTING SPEED
 Vc. SCHNITTGESCHWINDIGKEIT
 Vc. VITESSE DE COUPE



PAG. 222

DETTAGLIO RICAMBI
 SPARE PARTS DETAILS
 DETAILS ZU DEN ERSATZTEILEN
 DÉTAIL DE PIÈCES DE RECHANGE



PAG. 1103

DATI TECNICI E CONSIGLI
 TECHNICAL DATA AND SUGGESTIONS
 TECHNISCHE DATEN UND EMPFEHLUNGEN
 DONNÉES TECHNIQUES ET CONSEILS



PAG. 1126

SC.. PWLNR/L

95°

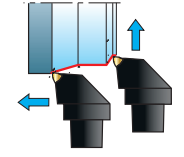
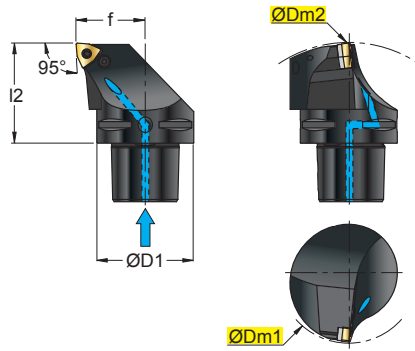

WNMA	
WNMG	
WNMM	

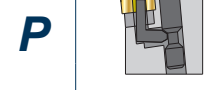

In figura utensile destro - Right-hand shown

		NEW 		NEW 						NEW 				 INSERTI - INSERTS PAG. 199							
.G23	.G61	.F71	.G42	.F51	.G52	.G53	.G55	.G56	.K57P	.F61	.G62	.G63	.G34W								
ART.										(mm)											
										ØDm1	ØDm2	ØD1	f	l2							
SC40 PWLNR/L 27050-08										PSC40	70	140	40	27	50						
SC50 PWLNR/L 35060-08										PSC50	80	165	50	35	60						
SC63 PWLNR/L 45065-08										PSC63	100	190	63	45	65						

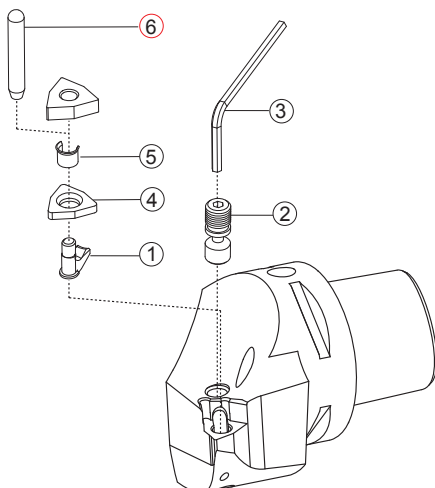

CAMPI D'IMPIEGO DEGLI INSERTI PER TORNITURA
 FIELDS OF APPLICATION FOR TURNING INSERTS
 EINSATZGEBIETE FÜR DREHPLATTEN
 CHAMPS D'USINAGE DES PLAQUETTES POUR TOURNAGE



VELOCITÀ DI TAGLIO Vc
 Vc. CUTTING SPEED
 Vc. SCHNITTGESCHWINDIGKEIT
 Vc. VITESSE DE COUPE



DETTAGLIO RICAMBI
 SPARE PARTS DETAILS
 DETAILS ZU DEN ERSATZTEILEN
 DÉTAIL DE PIÈCES DE RECHANGE



DATI TECNICI E CONSIGLI
 TECHNICAL DATA AND SUGGESTIONS
 TECHNISCHE DATEN UND EMPFEHLUNGEN
 DONNÉES TECHNIQUES ET CONSEILS



SC.. SCLCR/L

95°

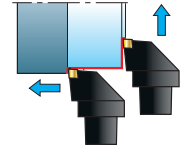
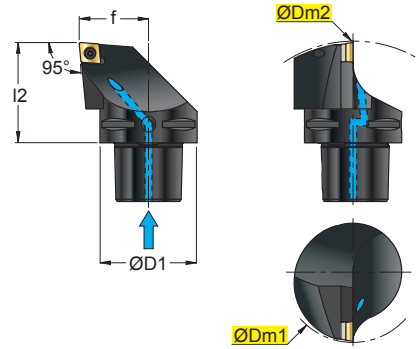

CC.T

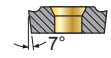

CC.W

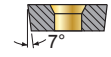

S



In figura utensile destro - Right-hand shown

													 INSERTI - INSERTS PAG. 201					
.G57P	.X47	.G42	.F51	.G52														
ART.		(mm)																
SC40 SCLCR/L 27050-12	PSC40	90	140	40	27	50	4,0+5,0	1204		3611	BCL15	124513P	5520P					
SC50 SCLCR/L 35060-12	PSC50	100	165	50	35	60	4,0+5,0											
SC63 SCLCR/L 45065-12	PSC63	110	190	63	45	65	4,0+5,0											

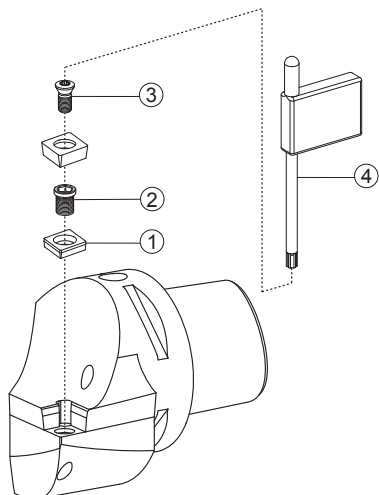

- CAMPI D'IMPIEGO DEGLI INSERTI PER TORNITURA
- FIELDS OF APPLICATION FOR TURNING INSERTS
- EINSATZGEBIETE FÜR DREHPLATTEN
- CHAMPS D'USINAGE DES PLAQUETTES POUR TOURNAGE

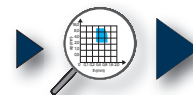

PAG. 226

- VELOCITÀ DI TAGLIO Vc
- Vc. CUTTING SPEED
- Vc. SCHNITTGESCHWINDIGKEIT
- Vc. VITESSE DE COUPE



PAG. 222

- DETTAGLIO RICAMBI
- SPARE PARTS DETAILS
- DETAILS ZU DEN ERSATZTEILEN
- DÉTAIL DE PIÈCES DE RECHANGE



PAG. 1103

- DATI TECNICI E CONSIGLI
- TECHNICAL DATA AND SUGGESTIONS
- TECHNISCHE DATEN UND EMPFEHLUNGEN
- DONNÉES TECHNIQUES ET CONSEILS



PAG. 1126

SC.. SDJCR/L

93°

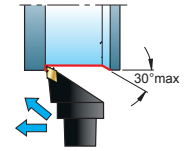
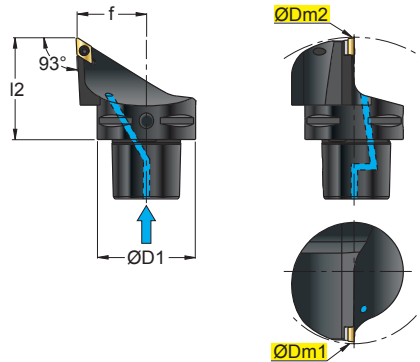

DC.T



DC.W



S



In figura utensile destro - Right-hand shown

															<p>INSERTI - INSERTS PAG. 203</p>			
ART.		(mm)							Nm	11T3	①	②	③	④	○			
		PSC40	80	140	40	27	50	3,0+3,5										
SC40 SDJCR/L 27050-11		PSC40	80	140	40	27	50	3,0+3,5	11T3	3711	BCL7	123511P	5515P					
SC50 SDJCR/L 35060-11		PSC50	100	165	50	35	60	3,0+3,5										
SC63 SDJCR/L 45065-11		PSC63	150	190	63	45	65	3,0+3,5										

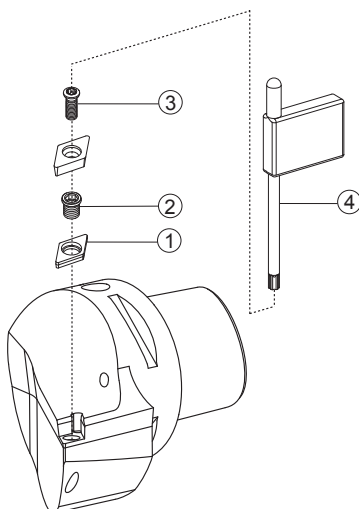

CAMPI D'IMPIEGO DEGLI INSERTI PER TORNITURA
 FIELDS OF APPLICATION FOR TURNING INSERTS
 EINSATZGEBIETE FÜR DREHPLATTEN
 CHAMPS D'USINAGE DES PLAQUETTES POUR TOURNAGE

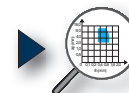

PAG. 226

VELOCITÀ DI TAGLIO Vc
 Vc. CUTTING SPEED
 Vc. SCHNITTGESCHWINDIGKEIT
 Vc. VITESSE DE COUPE



PAG. 222

DETTAGLIO RICAMBI
 SPARE PARTS DETAILS
 DETAILS ZU DEN ERSATZTEILEN
 DÉTAIL DE PIÈCES DE RECHANGE



PAG. 1103

DATI TECNICI E CONSIGLI
 TECHNICAL DATA AND SUGGESTIONS
 TECHNISCHE DATEN UND EMPFEHLUNGEN
 DONNÉES TECHNIQUES ET CONSEILS



PAG. 1126

SC.. SVHBR/L

107,5°

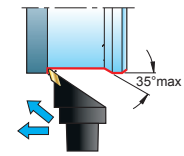
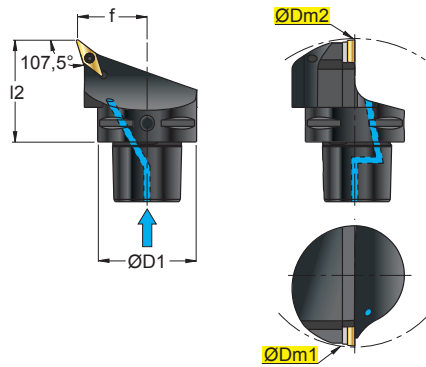

VB.T



VB.W



S



In figura utensile destro - Right-hand shown



INSERTI - INSERTS
 PAG. 207

ART.	 	 (mm)	ØDm1	ØDm2	ØD1	f	l2	Nm	 1604	①	②	③	④	○
										 3716	 BCL7	 123511P	 5515P	
SC40 SVHBR/L 27050-16		PSC40	120	140	40	27	50	3,0+3,5	1604	3716	BCL7	123511P	5515P	
SC50 SVHBR/L 35060-16		PSC50	120	165	50	35	60	3,0+3,5						
SC63 SVHBR/L 45065-16		PSC63	120	190	63	45	65	3,0+3,5						

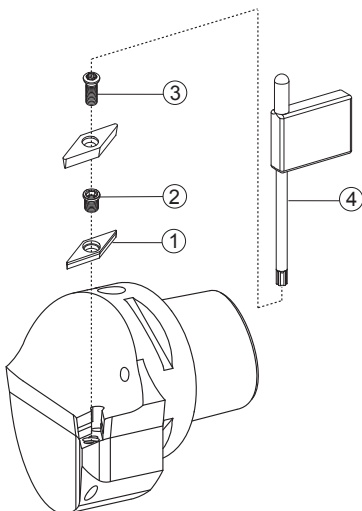

CAMPI D'IMPIEGO DEGLI INSERTI PER TORNITURA
 FIELDS OF APPLICATION FOR TURNING INSERTS
 EINSATZGEBIETE FÜR DREHPLATTEN
 CHAMPS D'USINAGE DES PLAQUETTES POUR TOURNAGE

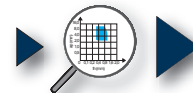

PAG. 226

VELOCITÀ DI TAGLIO Vc
 Vc. CUTTING SPEED
 Vc. SCHNITTGESCHWINDIGKEIT
 Vc. VITESSE DE COUPE



PAG. 222

DETTAGLIO RICAMBI
 SPARE PARTS DETAILS
 DETAILS ZU DEN ERSATZTEILEN
 DÉTAIL DE PIÈCES DE RECHANGE



PAG. 1103

DATI TECNICI E CONSIGLI
 TECHNICAL DATA AND SUGGESTIONS
 TECHNISCHE DATEN UND EMPFEHLUNGEN
 DONNÉES TECHNIQUES ET CONSEILS



PAG. 1126

SC.. SVJBR/L

93°

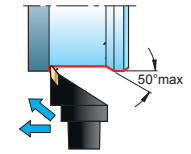
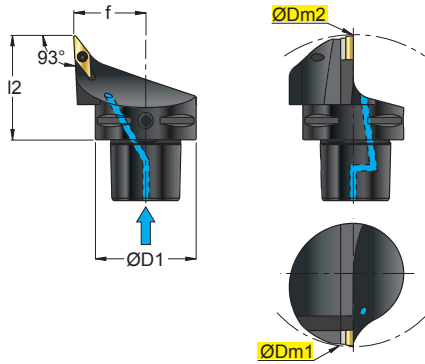

VB.T



VB.W



S



In figura utensile destro - Right-hand shown

ART.				(mm)					Nm	1604	1	2	3	4	○
				ØDm1	ØDm2	ØD1	f	l2							
.X47	.G42	.G52	.G58												
SC40 SVJBR/L 27050-16	PSC40	120	140	40	27	50	3,0+3,5	1604	3716	BCL7	123511P	5515P			
SC50 SVJBR/L 35060-16	PSC50	120	165	50	35	60	3,0+3,5								
SC63 SVJBR/L 45065-16	PSC63	120	190	63	45	65	3,0+3,5								

INSERTI - INSERTS
 PAG. 207

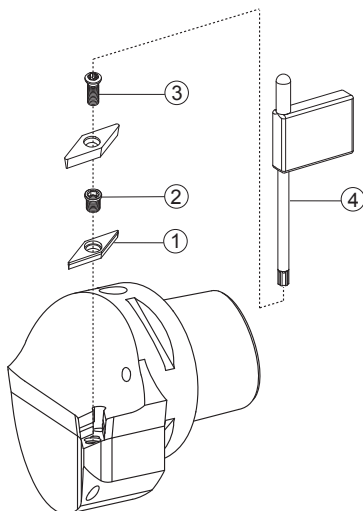

CAMPI D'IMPIEGO DEGLI INSERTI PER TORNITURA
 FIELDS OF APPLICATION FOR TURNING INSERTS
 EINSATZGEBIETE FÜR DREHPLATTEN
 CHAMPS D'USINAGE DES PLAQUETTES POUR TOURNAGE

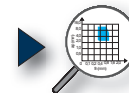

PAG. 226

VELOCITÀ DI TAGLIO Vc
 Vc. CUTTING SPEED
 Vc. SCHNITTGESCHWINDIGKEIT
 Vc. VITESSE DE COUPE



PAG. 222

DETTAGLIO RICAMBI
 SPARE PARTS DETAILS
 DETAILS ZU DEN ERSATZTEILEN
 DÉTAIL DE PIÈCES DE RECHANGE



PAG. 1103

DATI TECNICI E CONSIGLI
 TECHNICAL DATA AND SUGGESTIONS
 TECHNISCHE DATEN UND EMPFEHLUNGEN
 DONNÉES TECHNIQUES ET CONSEILS



PAG. 1126

SC63 SCMCN

50° 95°

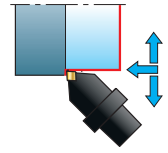
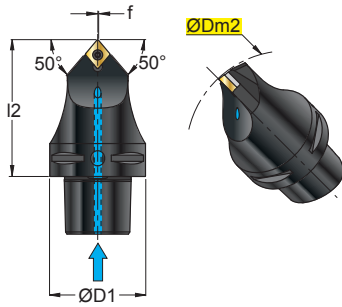

CC.T



CC.W

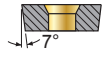

S



			NEW 																	 INSERTI - INSERTS PAG. 201	
ART.				(mm)																	
					ØDm2	ØD1	f	l2	Nm		①	②	③	④	○						
SC63 SCMCN 00090-12			PSC63	190	63	0	90	4,0+5,0	1204		3611	BCL15	124513P	5520P							

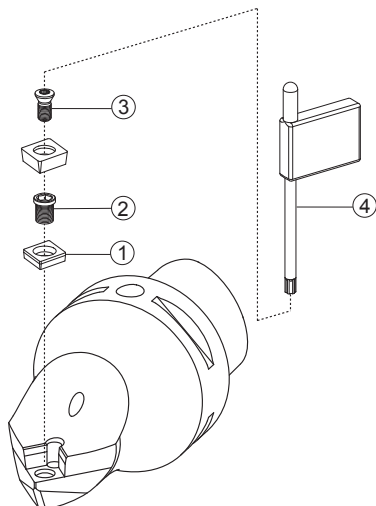

CAMPI D'IMPIEGO DEGLI INSERTI PER TORNITURA
 FIELDS OF APPLICATION FOR TURNING INSERTS
 EINSATZGEBIETE FÜR DREHPLATTEN
 CHAMPS D'USINAGE DES PLAQUETTES POUR TOURNAGE

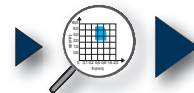

PAG. 226

VELOCITÀ DI TAGLIO Vc
 Vc. CUTTING SPEED
 Vc. SCHNITTGESCHWINDIGKEIT
 Vc. VITESSE DE COUPE



PAG. 222

DETTAGLIO RICAMBI
 SPARE PARTS DETAILS
 DETAILS ZU DEN ERSATZTEILEN
 DÉTAIL DE PIÈCES DE RECHANGE



PAG. 1103

DATI TECNICI E CONSIGLI
 TECHNICAL DATA AND SUGGESTIONS
 TECHNISCHE DATEN UND EMPFEHLUNGEN
 DONNÉES TECHNIQUES ET CONSEILS



PAG. 1126

SC63 SVMBL

50°

95°

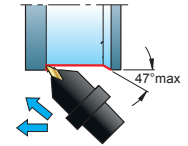
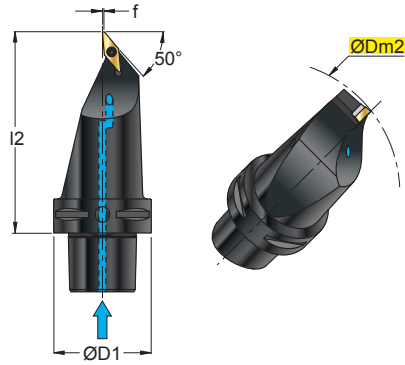

VB.T



VB.W



S



In figura utensile sinistro - Left-hand shown



.X47 .G42 .G52 .G58

INSERTI - INSERTS
 PAG. 207

ART.		(mm)					Nm		① ② ③ ④				
		ØDm2	ØD1	f	l2			1	2	3	4		
SC63 SVMBL 00130-16		PSC63	190	63	0	130	3,0+3,5		1604	3716	BCL7	123511P	5515P

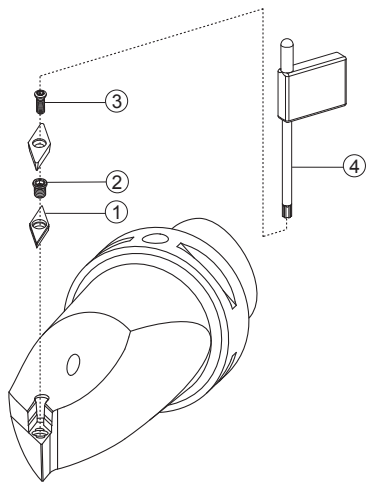

CAMPI D'IMPIEGO DEGLI INSERTI PER TORNATURA
 FIELDS OF APPLICATION FOR TURNING INSERTS
 EINSATZGEBIETE FÜR DREHPLATTEN
 CHAMPS D'USINAGE DES PLAQUETTES POUR TOURNAGE

PAG. 226

VELOCITÀ DI TAGLIO Vc
 Vc. CUTTING SPEED
 Vc. SCHNITTGESCHWINDIGKEIT
 Vc. VITESSE DE COUPE

PAG. 222

DETTAGLIO RICAMBI
 SPARE PARTS DETAILS
 DETAILS ZU DEN ERSATZTEILEN
 DÉTAIL DE PIÈCES DE RECHANGE

PAG. 1103

DATI TECNICI E CONSIGLI
 TECHNICAL DATA AND SUGGESTIONS
 TECHNISCHE DATEN UND EMPFEHLUNGEN
 DONNÉES TECHNIQUES ET CONSEILS

PAG. 1126

SC.. PCLNR/L

95°

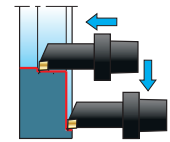
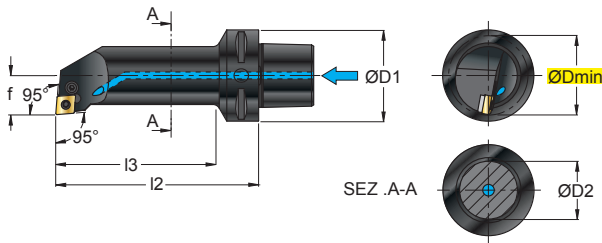

CNMA	
CNMG	
CNMM	

P



in figura utensile destro - right-hand shown

																		 INSERTI - INSERTS PAG. 193
.G23	.G61	.F71	.X47	.G39	.G42	.F51	.G52	.G53	.G55	.G56	.K57P	.F61	.G62	.G63	.G68	.G72	.G34W	
ART.		L		R		(mm)			1204		1	2	3	4	5	6		
SC40 PCLNR/L 22110-12	PSC40	39	40	32	22	110	87	1204	8012	1608	5003	3612	4112	0012				
SC50 PCLNR/L 22110-12	PSC50	39	50	32	22	110	87											
SC63 PCLNR/L 27140-12	PSC63	48	63	40	27	140	111											

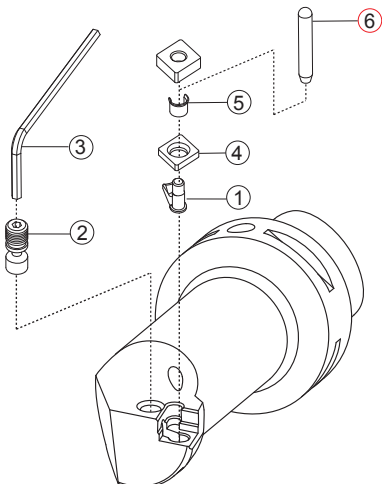

CAMPI D'IMPIEGO DEGLI INSERTI PER TORNATURA
 FIELDS OF APPLICATION FOR TURNING INSERTS
 EINSATZGEBIETE FÜR DREHPLATTEN
 CHAMPS D'USINAGE DES PLAQUETTES POUR TOURNAGE

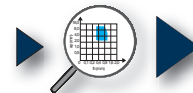

PAG. 226

VELOCITÀ DI TAGLIO Vc
 Vc. CUTTING SPEED
 Vc. SCHNITTGESCHWINDIGKEIT
 Vc. VITESSE DE COUPE



PAG. 222

DETTAGLIO RICAMBI
 SPARE PARTS DETAILS
 DETAILS ZU DEN ERSATZTEILEN
 DÉTAIL DE PIÈCES DE RECHANGE



PAG. 1103

DATI TECNICI E CONSIGLI
 TECHNICAL DATA AND SUGGESTIONS
 TECHNISCHE DATEN UND EMPFEHLUNGEN
 DONNÉES TECHNIQUES ET CONSEILS



PAG. 1126

SC.. PWLNR/L

95°

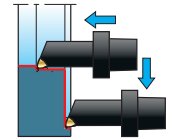
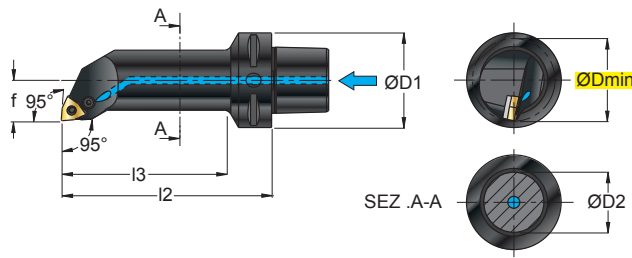

WNMA	
WNMG	
WNMM	



In figura utensile destro - Right-hand shown

		NEW 		NEW 						NEW 				 INSERTI - INSERTS PAG. 199	
.G23	.G61	.F71	.G42	.F51	.G52	.G53	.G55	.G56	.K57P	.F61	.G62	.G63	.G34W		
ART.															
										(mm)					
										①	②	③	④	⑤	⑥
SC40 PWLNR/L 22110-08	PSC40	39	40	32	22	110	87	0804							
SC50 PWLNR/L 22110-08	PSC50	39	50	32	22	110	87								
SC63 PWLNR/L 27140-08	PSC63	48	63	40	27	140	111								

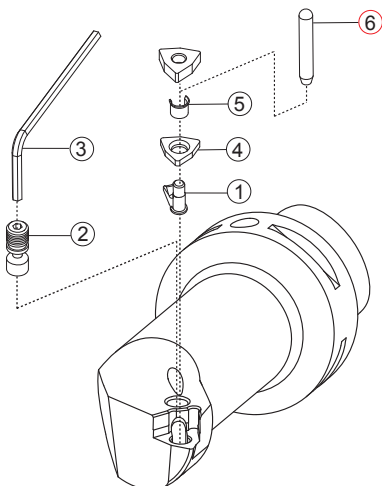

CAMPI D'IMPIEGO DEGLI INSERTI PER TORNITURA
 FIELDS OF APPLICATION FOR TURNING INSERTS
 EINSATZGEBIETE FÜR DREHPLATTEN
 CHAMPS D'USINAGE DES PLAQUETTES POUR TOURNAGE



VELOCITÀ DI TAGLIO Vc
 Vc. CUTTING SPEED
 Vc. SCHNITTGESCHWINDIGKEIT
 Vc. VITESSE DE COUPE



DETTAGLIO RICAMBI
 SPARE PARTS DETAILS
 DETAILS ZU DEN ERSATZTEILEN
 DÉTAIL DE PIÈCES DE RECHANGE



DATI TECNICI E CONSIGLI
 TECHNICAL DATA AND SUGGESTIONS
 TECHNISCHE DATEN UND EMPFEHLUNGEN
 DONNÉES TECHNIQUES ET CONSEILS



SC.. SCLCR/L

95°

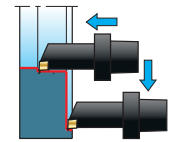
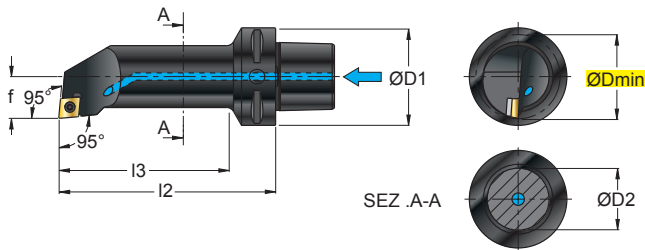

CC.T



CC.W



S



In figura utensile destro - Right-hand shown

												 INSERTI - INSERTS PAG. 201						
.B22	.F47	.G13	.G57P	.X47	.F32	.F33	.G39	.G42	.F51	.G52	.G32W							
ART.				(mm)									1	2	3	4		
				ØDmin	ØD1	ØD2	f	l2	l3	Nm								
SC40 SCLCR/L 11070-09			PSC40	20	40	16	11	70	47	3,8+5,0	09T3				12409P	5515P		
SC40 SCLCR/L 13080-09			PSC40	25	40	20	13	80	58	3,8+5,0								
SC40 SCLCR/L 17090-12			PSC40	30	40	25	17	90	68	4,0+5,0	1204				124510P	5520P		
SC40 SCLCR/L 22110-12			PSC40	39	40	32	22	110	87	4,0+5,0	1204	3611	BCL15	124513P	5520P			
SC50 SCLCR/L 17090-12			PSC50	30	50	25	17	90	68	4,0+5,0	1204				124510P	5520P		
SC50 SCLCR/L 22110-12			PSC50	39	50	32	22	110	87	4,0+5,0	1204	3611	BCL15	124513P	5520P			
SC63 SCLCR/L 22125-12			PSC63	39	63	32	22	125	102	4,0+5,0								
SC63 SCLCR/L 22160-12			PSC63	39	63	32	22	160	132	4,0+5,0								
SC63 SCLCR/L 27140-12			PSC63	48	63	40	27	140	111	4,0+5,0								
SC63 SCLCR/L 27180-12			PSC63	48	63	40	27	180	151	4,0+5,0								

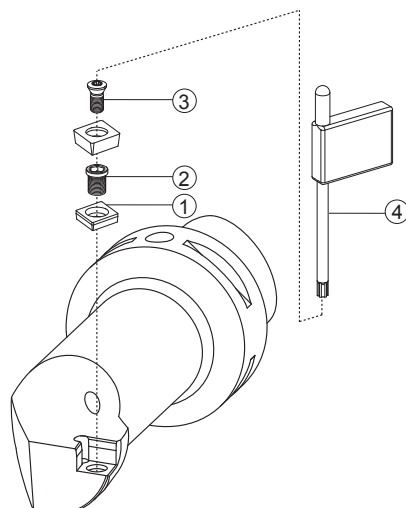

CAMPI D'IMPIEGO DEGLI INSERTI PER TORNITURA
 FIELDS OF APPLICATION FOR TURNING INSERTS
 EINSATZGEBIETE FÜR DREHPLATTEN
 CHAMPS D'USINAGE DES PLAQUETTES POUR TORNAGE

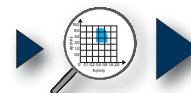

PAG. 226

VELOCITÀ DI TAGLIO Vc
 Vc. CUTTING SPEED
 Vc. SCHNITTGESCHWINDIGKEIT
 Vc. VITESSE DE COUPE



PAG. 222

DETTAGLIO RICAMBI
 SPARE PARTS DETAILS
 DETAILS ZU DEN ERSATZTEILEN
 DÉTAIL DE PIÈCES DE RECHANGE



PAG. 1103

DATI TECNICI E CONSIGLI
 TECHNICAL DATA AND SUGGESTIONS
 TECHNISCHE DATEN UND EMPFEHLUNGEN
 DONNÉES TECHNIQUES ET CONSEILS



PAG. 1126

SC.. SDUCR/L

93°

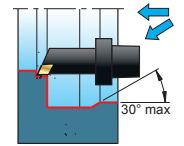
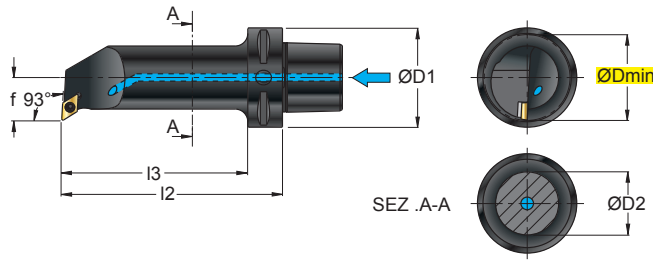

DC.T	
DC.W	
S	

in figura utensile destro - right-hand shown

ART.		(mm)														INSERITI - INSERTS PAG. 203	
L R		ØDmin	ØD1	ØD2	f	I2	I3	Nm		①	②	②	④				
SC40 SDUCR/L	11070-07	PSC40	20	40	16	11	70	47	1,1+1,3	0702	-	-	12256P	5508P			
SC40 SDUCR/L	13080-11	PSC40	25	40	20	13	80	58	3,8+5,0	11T3	-	-	12409P	5515P			
SC40 SDUCR/L	17090-11	PSC40	30	40	25	17	90	68	3,0+3,5	11T3	-	-	1240P	5515P			
SC40 SDUCR/L	22110-11	PSC40	39	40	32	22	110	87	3,0+3,5	11T3	3711	BCL7	123511P	5515P			
SC50 SDUCR/L	17090-11	PSC50	30	50	25	17	90	68	3,0+3,5	11T3	-	-	1240P	5515P			
SC50 SDUCR/L	22110-11	PSC50	39	50	32	22	110	87	3,0+3,5	11T3	3711	BCL7	123511P	5515P			
SC63 SDUCR/L	22125-11	PSC63	39	63	32	22	125	102	3,0+3,5								
SC63 SDUCR/L	22160-11	PSC63	39	63	32	22	160	132	3,0+3,5								
SC63 SDUCR/L	27140-11	PSC63	48	63	40	27	140	111	3,0+3,5								
SC63 SDUCR/L	27180-11	PSC63	48	63	40	27	180	151	3,0+3,5								

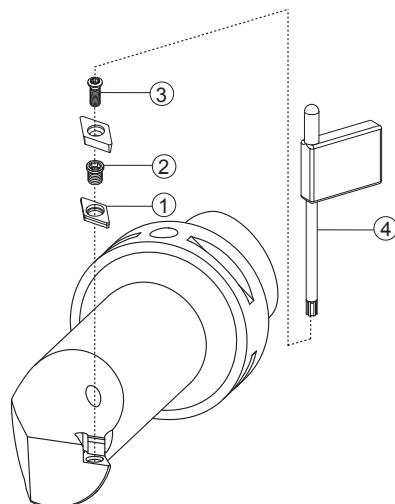

CAMPI D'IMPIEGO DEGLI INSERITI PER TORNITURA
 FIELDS OF APPLICATION FOR TURNING INSERTS
 EINSATZGEBIETE FÜR DREHPLATTEN
 CHAMPS D'USINAGE DES PLAQUETTES POUR TOURNAGE



VELOCITÀ DI TAGLIO Vc
 Vc. CUTTING SPEED
 Vc. SCHNITTGESCHWINDIGKEIT
 Vc. VITESSE DE COUPE



DETTAGLIO RICAMBI
 SPARE PARTS DETAILS
 DETAILS ZU DEN ERSATZTEILEN
 DÉTAIL DE PIÈCES DE RECHANGE



DATI TECNICI E CONSIGLI
 TECHNICAL DATA AND SUGGESTIONS
 TECHNISCHE DATEN UND EMPFEHLUNGEN
 DONNÉES TECHNIQUES ET CONSEILS



SC.. SVQBR/L

107,5°

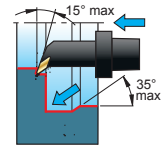
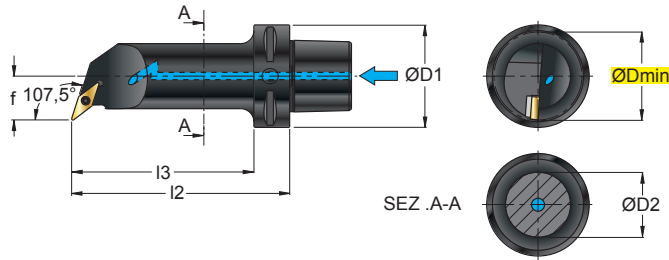

VB.T

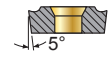

VB.W

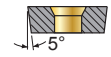

S



In figura utensile destro - Right-hand shown

.X47 .G42 .G52 .G58				INSERTI - INSERTS PAG. 207																		
ART.		(mm)		ØDmin		ØD1		ØD2		f		l2		l3		Nm		1	2	3	4	5
SC50 SVQBR/L 17090-16	PSC50	30	50	25	17	90	65	3,0±3,5	1604	-	-	123509P	5515P									
SC63 SVQBR/L 22125-16	PSC63	39	63	32	22	125	95	3,0±3,5	1604	3716	BCL7	123511P	5515P									
SC63 SVQBR/L 27180-16	PSC63	48	63	40	27	180	150	3,0±3,5														

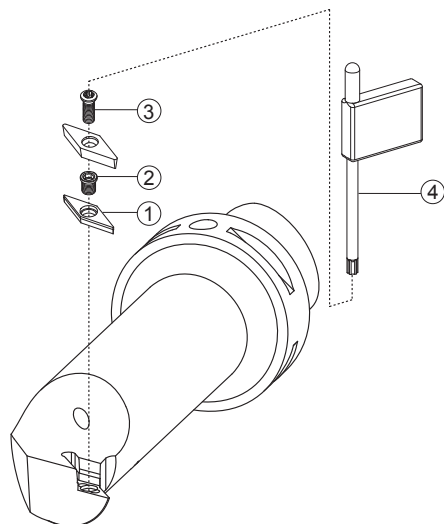

CAMPI D'IMPIEGO DEGLI INSERTI PER TORNITURA
 FIELDS OF APPLICATION FOR TURNING INSERTS
 EINSATZGEBIETE FÜR DREHPLATTEN
 CHAMPS D'USINAGE DES PLAQUETTES POUR TOURNAGE

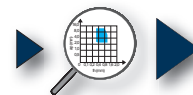

PAG. 226

VELOCITÀ DI TAGLIO Vc
 Vc. CUTTING SPEED
 Vc. SCHNITTGESCHWINDIGKEIT
 Vc. VITESSE DE COUPE



PAG. 222

DETTAGLIO RICAMBI
 SPARE PARTS DETAILS
 DETAILS ZU DEN ERSATZTEILEN
 DÉTAIL DE PIÈCES DE RECHANGE



PAG. 1103

DATI TECNICI E CONSIGLI
 TECHNICAL DATA AND SUGGESTIONS
 TECHNISCHE DATEN UND EMPFEHLUNGEN
 DONNÉES TECHNIQUES ET CONSEILS



PAG. 1126

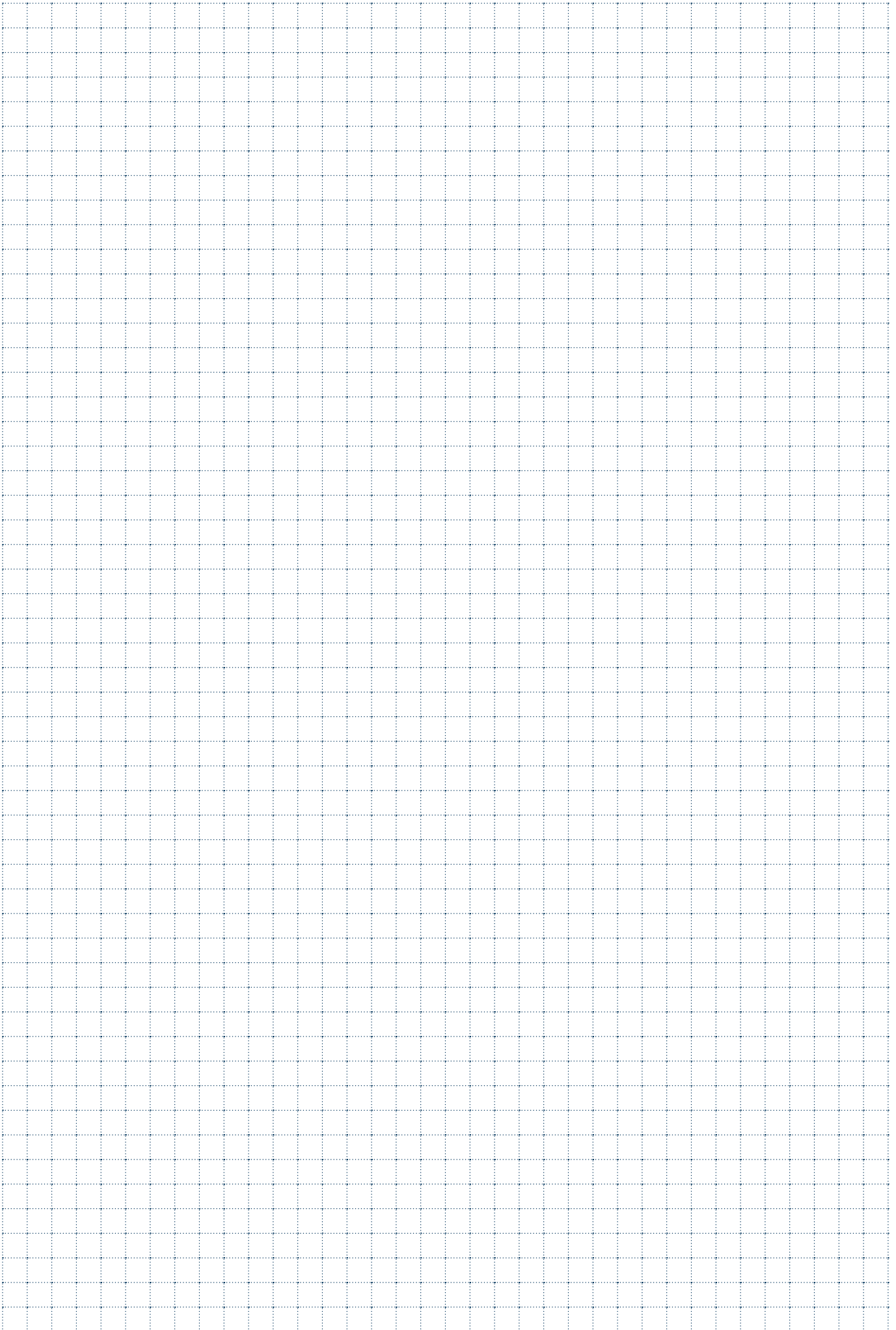



S686 ... Pag.186		S686-D ... Pag.188			
					
<i>ØDmin 9,5</i>		<i>Ød 25 - 32</i>			
	SLT.		S686 ...		

S686 ...

Ø 25-32

NEW

SLT ...

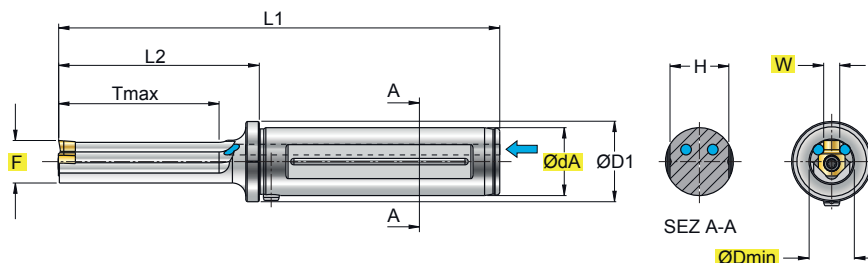

INSERTI - INSERTS
PAG. 209

ART.	(mm)									kg	Nm				
	W	F	ØDmin	ØdA	ØD1	Tmax	L1	L2	H						
S686.030.030.025	3	9,0	9,5	25	30	30	133	43	22	0,36	1+1,2	030-0604	122510P	5607P	903.006.016.M40
S686.030.040.025	3	9,0	9,5	25	30	40	143	53	22	0,37	1+1,2				
S686.030.030.032	3	9,0	9,5	32	37	30	143	43	29	0,65	1+1,2				
S686.030.040.032	3	9,0	9,5	32	37	40	153	53	29	0,66	1+1,2				
S686.040-050.040.025	04-05	10,0	10,9-11,2	25	30	40	143	53	22	0,37	1+1,2	040-0604/ 050-0604	122510P	5607P	903.006.016.M40
S686.040-050.060.025	04-05	10,0	10,9-11,2	25	30	60	163	73	22	0,38	1+1,2				
S686.040-050.040.032	04-05	10,0	10,9-11,2	32	37	40	153	53	29	0,66	1+1,2				
S686.040-050.060.032	04-05	10,0	10,9-11,2	32	37	60	173	73	29	0,67	1+1,2				
S686.060-080.060.025	06-08	15,9	17-17,5	25	30	60	165	75	22	0,42	3,8+5	060-1006/ 080-1006	124015P	5615P	903.006.016.M40
S686.060-080.100.025	06-08	15,9	17-17,5	25	30	100	205	115	22	0,47	3,8+5				
S686.060-080.060.032	06-08	15,9	17-17,5	32	37	60	175	75	29	0,72	3,8+5				
S686.060-080.100.032	06-08	15,9	17-17,5	32	37	100	215	115	29	0,76	3,8+5				
S686.100-120.080.025	10-12	22,4	24-24,5	25	30	80	185	95	22	0,53	7,5+9	100-1309/ 120-1309	126018P	5625P	903.006.016.M40
S686.100-120.140.025	10-12	22,4	24-24,5	25	30	140	245	155	22	0,67	7,5+9				
S686.100-120.080.032	10-12	22,4	24-24,5	32	37	80	195	95	29	0,82	7,5+9				
S686.100-120.140.032	10-12	22,4	24-24,5	32	37	140	255	155	29	0,95	7,5+9				

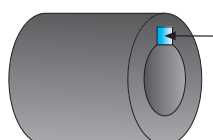

SCelta VELOCE - QUICK PICK



COD.	TOLL.	P		M		K		N		S		H		HT	HW	HC	HSS	W	s	s1	l	T	d1										
		F	M	R	F	M	R	F	M	R	F	M	R											F	M	R							
SLT 030-0604 H7	(3,000-3,010)	●	●	●	●	●	●	●	●	●	●	●	●																				
SLT 030-0604 D10	(3,020-3,060)	●	●	●	●	●	●	●	●	●	●	●	●																				
SLT 030-0604 C11	(3,060-3,120)	●	●	●	●	●	●	●	●	●	●	●	●																				
SLT 040-0604 H7	(4,000-4,012)	●	●	●	●	●	●	●	●	●	●	●	●																				
SLT 040-0604 D10	(4,030-4,078)	●	●	●	●	●	●	●	●	●	●	●	●																				
SLT 040-0604 C11	(4,070-4,145)	●	●	●	●	●	●	●	●	●	●	●	●																				
SLT 050-0604 H7	(5,000-5,012)	●	●	●	●	●	●	●	●	●	●	●	●																				
SLT 050-0604 D10	(5,030-5,078)	●	●	●	●	●	●	●	●	●	●	●	●																				
SLT 050-0604 C11	(5,070-5,145)	●	●	●	●	●	●	●	●	●	●	●	●																				
SLT 060-1006 H7	(6,000-6,012)	●	●	●	●	●	●	●	●	●	●	●	●																				
SLT 060-1006 D10	(6,030-6,078)	●	●	●	○	●	●	●	●	●	●	●	●																				
SLT 060-1006 C11	(6,070-6,145)	●	●	●	○	●	●	●	●	●	●	●	●																				
SLT 080-1006 H7	(8,000-8,015)	●	●	●	○	●	●	●	●	●	●	●	●																				
SLT 080-1006 D10	(8,040-8,098)	●	●	●	○	●	●	●	●	●	●	●	●																				
SLT 080-1006 C11	(8,080-8,170)	●	●	●	○	●	●	●	●	●	●	●	●																				
SLT 100-1309 H7	(10,000-10,015)	●	●	●	○	●	●	●	●	●	●	●	●																				
SLT 100-1309 D10	(10,040-10,098)	●	●	●	○	●	●	●	●	●	●	●	●																				
SLT 100-1309 C11	(10,080-10,170)	●	●	●	○	●	●	●	●	●	●	●	●																				
SLT 120-1309 H7	(12,000-12,018)	●	●	●	○	●	●	●	●	●	●	●	●																				
SLT 120-1309 D10	(12,050-12,120)	●	●	●	○	●	●	●	●	●	●	●	●																				
SLT 120-1309 C11	(12,095-12,205)	●	●	●	○	●	●	●	●	●	●	●	●																				
CON ADDUZIONE LUBROREFRIGERANTE - WITH COOLANT SUPPLY																	●																
SENZA ADDUZIONE LUBROREFRIGERANTE - WITHOUT COOLANT SUPPLY																	○																

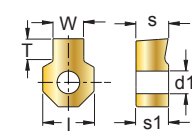

PER INSERTI SPECIALI VEDERE TERZA DI COPERTINA
 FOR SPECIAL INSERTS, SEE THE BACK COVER
 FÜR SONDERWENDEPLATTEN SIEHE DIE RÜCKSEITE
 POUR DES PLAQUETTES SPÉCIAUX, VOIR LA TROISIÈME DE COUVERTURE

F7230

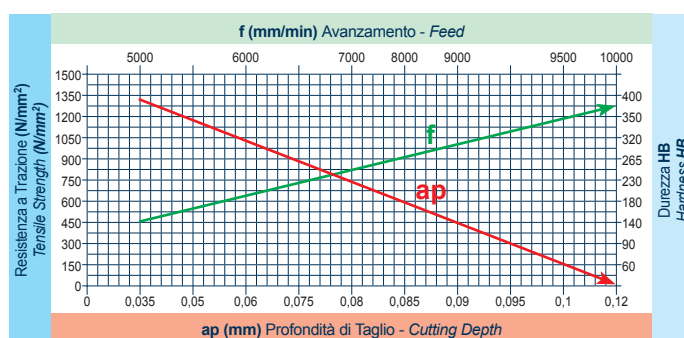

f (mm/min)	5000	5500	6000	6500	7000	8000	8500	9000	9500	10000
ap (mm)	0,035	0,05	0,06	0,075	0,08	0,085	0,09	0,095	0,1	0,12
HB	400	350	320	265	230	180	140	120	90	60
N/mm ²	1350	1200	1100	900	750	600	450	400	300	200

HSS33

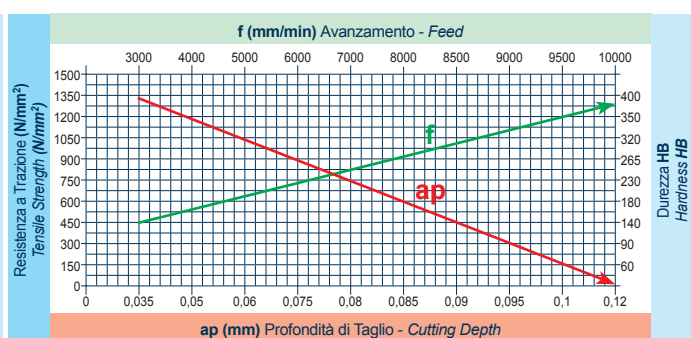

f (mm/min)	3000	4000	5000	6000	7000	8000	8500	9000	9500	10000
ap (mm)	0,035	0,05	0,06	0,075	0,08	0,085	0,09	0,095	0,1	0,12
HB	400	350	320	265	230	180	140	120	90	60
N/mm ²	1350	1200	1100	900	750	600	450	400	300	200

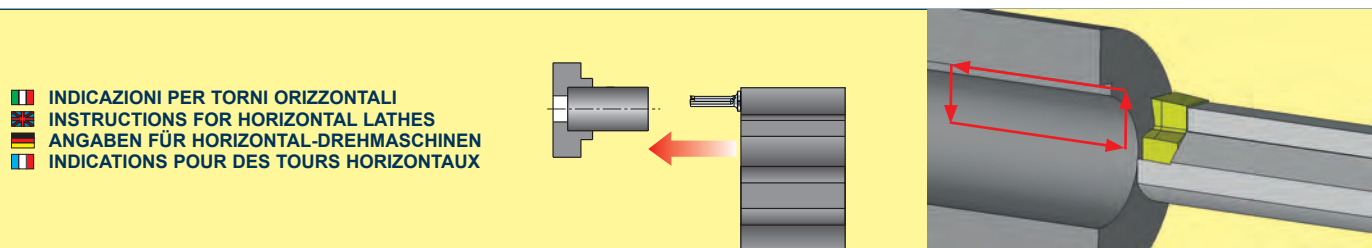

INDICAZIONI PER TORNI ORIZZONTALI
 INSTRUCTIONS FOR HORIZONTAL LATHES
 ANGABEN FÜR HORIZONTAL-DREHMASCHINEN
 INDICATIONS POUR DES TOURS HORIZONTAUX



S686-D ...

Ø 25-32

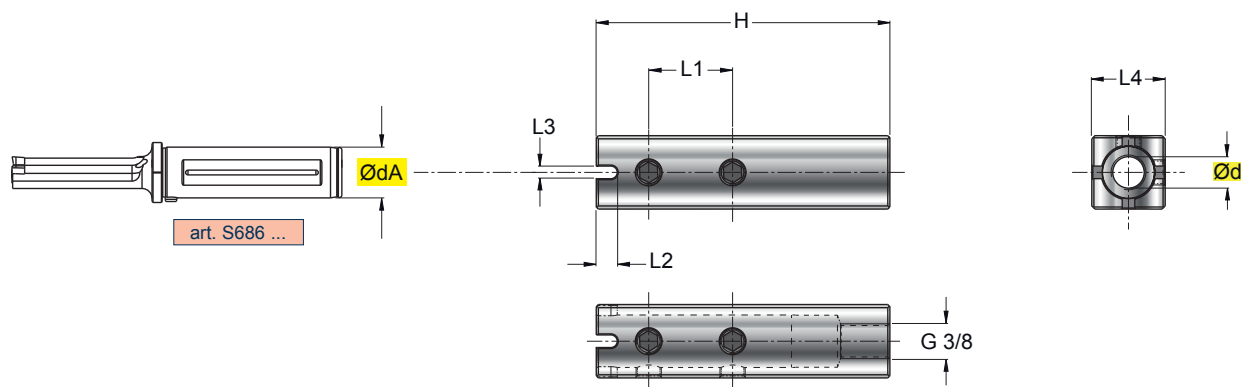
NEW



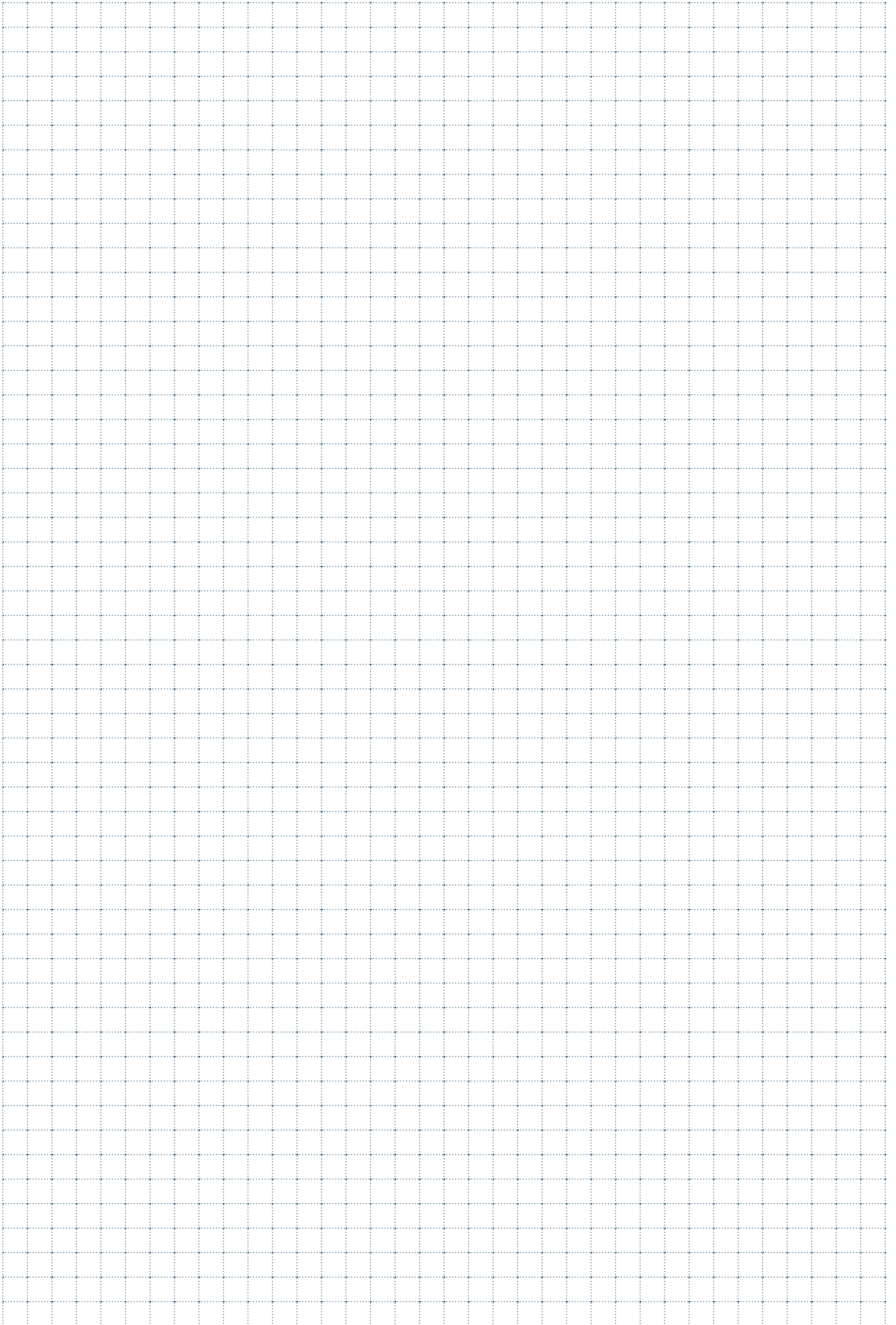

ADATTATORI QUADRI PER UTENSILI PER STOZZATURA
 SQUARE ADAPTERS FOR SLOTTING TOOLS
 VIERKANTADAPTER FÜR STOSSWERKZEUGE
 ADAPTATEUR CARRE POUR OUTILS A BROCHER

ART.	(mm)											
	Ød	H	L1	L2	L3	L4						
S686-D25	25	140	40	10	6	35	n°2 GR1208	5006	260Z 3/8-12			
S686-D32	32	140	50	10	6	40	n°2 GR1208	5006	260Z 3/8-12			



	DENOMINAZIONI DEGLI INSERTI PER TORNITURA	Pag. 192
	CATALOGO DISPONIBILITÀ INSERTI	Pag. 193
	COME SCEGLIERE I PARAMETRI DI LAVORO	Pag. 211
	PANORAMICA QUALITÀ DI TORNITURA	Pag. 213
	IMPIEGO DELLE QUALITÀ DI TORNITURA	Pag. 214
	VELOCITÀ DI TAGLIO DELLE QUALITÀ DI TORNITURA	Pag. 222
	CAMPI DI IMPIEGO DEI ROMPIRUCIOLI PER TORNITURA	Pag. 226

	INSERTS DESIGNATION FOR TURNING	Pag. 192
	INSERTS STOCK CATALOGUE	Pag. 193
	HOW TO CHOOSE CUTTING DATA	Pag. 211
	GENERAL VIEW OF THE TURNING GRADE	Pag. 213
	APPLICATION OF THE TURNING GRADE	Pag. 214
	CUTTING SPEED OF TURNING GRADES	Pag. 222
	FIELDS OF APPLICATION FOR CHIP BREAKERS	Pag. 226

	BEZEICHNUNG DER WENDEPLATTEN ZUM DREHEN	Pag. 192
	WENDEPLATTENBESTAND-KATALOG	Pag. 193
	EINSTELLUNG DER SCHNITTDATEN	Pag. 211
	DREHEN-ÜBERSICHT	Pag. 213
	EINSATZ DER DREHEN	Pag. 214
	SCHNITTGESCHWINDIGKEIT DREHSORTEN (VC)	Pag. 222
	EINSATZGEBIETE DER SPANBRECHER	Pag. 226

	DÉNOMINATION DES LES PLAQUETTES POUR LE TOURNAGE	Pag. 192
	CATALOGUE DE DISPONIBILITÉ PLAQUETTES	Pag. 193
	COMMENT CHOISIR LES PARAMETRES DE SERVICE	Pag. 211
	VUE D' ENSEMBLE QUALITÉ DE TOURNAGE	Pag. 213
	UTILISATION DE LES QUALITÉES DE TOURNAGE	Pag. 214
	VITESSE DE COUPE DE LA QUALITÉ DE PLAQUETTES DE TOURNAGE	Pag. 222
	CHAMPS D'USINAGE DE LE BRISE-COPEAUX	Pag. 226



INSERTI PER TORNITURA

TURNING INSERTS / WENDEPLATTEN ZUM DREHEN / PLAQUÉTTES DE TOURNAGE
PLAQUITAS DE TORNEADO



C	N	M	G
1	2	3	4

12	04	08
5	6	7

-	-
8	9

W	5	2	P
10	11	12	13

1 FORMA INSERTO
SHAPE OF INSERT

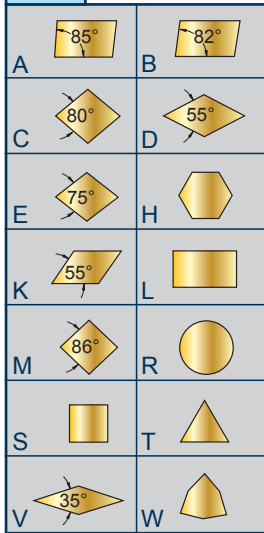

2 SPOGLIA INFER.
RELIEF ANGLE

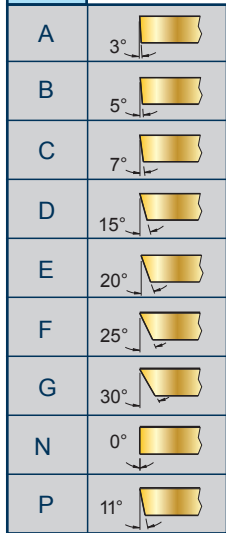

3 TOLLERANZA +/- (mm)
TOLERANCE +/- (mm)

	m	s	d
A	+/-0,005	+/-0,025	+/-0,025
C	+/-0,013	+/-0,025	+/-0,025
E	+/-0,025	+/-0,025	+/-0,025
F	+/-0,005	+/-0,025	+/-0,013
G	+/-0,025	+/-0,05 +/-0,13	+/-0,025
H	+/-0,013	+/-0,025	+/-0,013
J	+/-0,005	+/-0,025	+/-0,05 +/-0,13
K	+/-0,013	+/-0,025	+/-0,05 +/-0,13
L	+/-0,05	+/-0,013	+/-0,025
M	+/-0,08 +/-0,18	+/-0,13	+/-0,05 +/-0,18
N	+/-0,08 +/-0,18	+/-0,025	+/-0,05 +/-0,13
U	+/-0,13 +/-0,38	+/-0,05 +/-0,13	+/-0,08 +/-0,32

4 TIPO INSERTO
TYPE OF INSERT

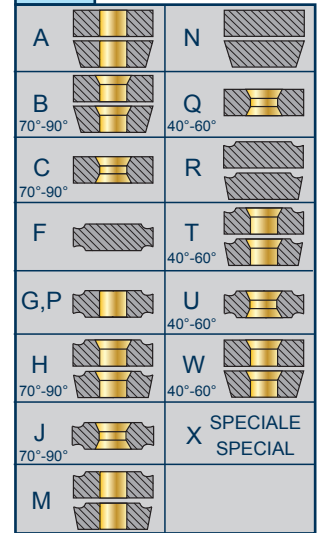

5 LUNGHEZZA TAGLIANTE
CUTTING EDGE LENGTH

Ød CERCHIO INSCRITTO INSCRIBED CIRCLE	A	C	D	E	K	L	M	R	S	T	V	W
3,97												02
4,76										08		02-03
5,56		05								09		
6,00												03
6,35		06	07	06			06	06	11	11		04
6,70	10											
7,94								07				
8,00				08			08					05
9,45	16											
9,52	15-16	09	11	09	16	15	09		09	16	16	06
10,00								10				06
11,00									11			
11,50						12						
12,00								12				07
12,62						18						
12,70		12	15	12	15-20			12	22			08
15,87		16							15			
19,05		19							19			
25,40		25							25			

6 SPESSORE
THICKNESS

S	mm
01	1,59
T1	1,97
02	2,38
T2	2,78
03	3,18
T3	3,97
04	4,76
05	5,56
06	6,35
07	7,94
09	9,52

7 RAGGIO
RADIUS

MO (mm)	r (mm)
00	r ≤ 0,05
01	r = 0,1
02	r = 0,2
04	r = 0,4
05	r = 0,5
06	r = 0,6
08	r = 0,8
10	r = 1,0
12	r = 1,2
16	r = 1,6
24	r = 2,4
32	r = 3,2

8

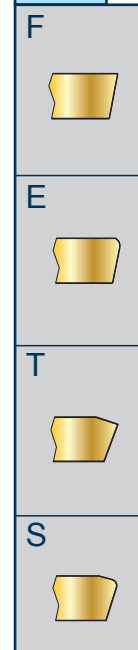

9

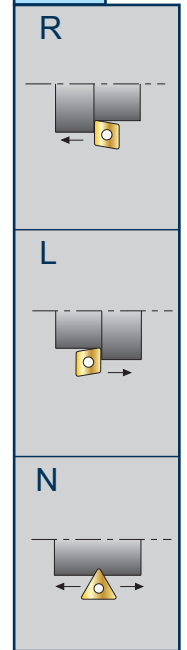

10 LETTERA DI IDENTIF.
IDENTIFICATION LETTER

A	N
C	P
D	R
E	S
H	T
I	U
J	W
K	X
L	Y
M	Z

11 CAMPO DI LAVORAZIONE
MACHINING TYPES

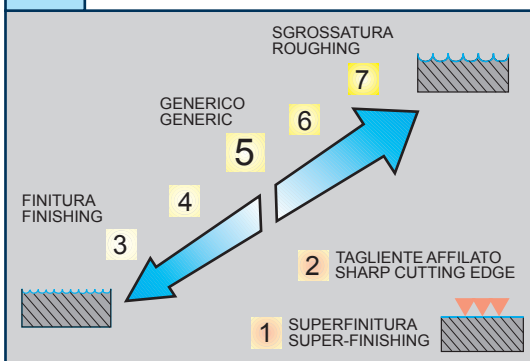

12 PREPARAZIONE TAGLIANTE
CUTTING EDGE PREPARATION

1 =	SPECIFICO PER GHISA SPECIFIC FOR CAST IRON
3 =	SPECIFICO PER ACCIAIO INOX SPECIFIC FOR STAINLESS STEEL
7 =	SPECIFICO PER LEGHE DI ALLUMINIO SPECIFIC FOR ALUMINIUM ALLOYS
9 =	SPECIFICO PER ACCIAIO SPECIFIC FOR STEEL
2 =	
4 =	
5 =	INTERMEDI DI USO GENERIC INTERMEDIATE FOR GENERAL USE
6 =	
8 =	

13

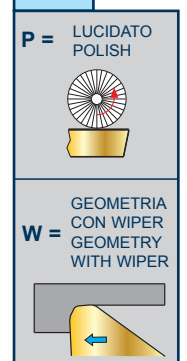

CNGP CNMA CNMG							HT	HW	HC										DP											
							CERMET	NON RIVESTITI CEMENTED CARBIDE GRADES	RIVESTITI COATED GRADES BESCHICHTET RECOUVERTS										PCD											
INSERTI NEGATIVI - NEGATIVE INSERTS - NEGATIVE WENDEPLATTEN - PLAQUÛTTES NEGATIVES											C4010								F2120	F2425	T1126	T1415	T1425	T3111	T3112	T3121	T3220	T1435	T2120	D3010
ART.	COD.	l	d	s	d1	r																								
	CNGP 120402 .G23	12,9	12,7	4,76	5,16	0,2																								
	CNGP 120404 .G23	12,9	12,7	4,76	5,16	0,4																								
	CNGP 120408 .G23	12,9	12,7	4,76	5,16	0,8																								
	CNMA 120408 .G61	12,9	12,7	4,76	5,16	0,8																								
	CNMA 120412 .G61	12,9	12,7	4,76	5,16	1,2																								
	CNMA 120416 .G61	12,9	12,7	4,76	5,16	1,6																								
	CNMA 120408 .F71	12,9	12,7	4,76	5,16	0,8																								
	CNMA 120412 .F71	12,9	12,7	4,76	5,16	1,2																								
	CNMA 090304 .X47	9,52	9,52	3,18	3,81	0,4																								
	CNMA 090308 .X47	9,52	9,52	3,18	3,81	0,8																								
	CNMA 120404 .X47	12,9	12,7	4,76	5,16	0,4																								
	CNMA 120408 .X47	12,9	12,7	4,76	5,16	0,8																								
	CNMG 120404 .G39	12,9	12,7	4,76	5,16	0,4	■																							
	CNMG 120408 .G39	12,9	12,7	4,76	5,16	0,8	■																							
	CNMG 090304 .G42	9,52	9,52	3,18	3,81	0,4																								
	CNMG 120404 .G42	12,9	12,7	4,76	5,16	0,4																								
	CNMG 120408 .G42	12,9	12,7	4,76	5,16	0,8																								
	CNMG 120404 .F51	12,9	12,7	4,76	5,16	0,4																								
	CNMG 120408 .F51	12,9	12,7	4,76	5,16	0,8																								
	CNMG 120412 .F51	12,9	12,7	4,76	5,16	1,2																								
	CNMG 120404 .G52	12,9	12,7	4,76	5,16	0,4																								
	CNMG 120408 .G52	12,9	12,7	4,76	5,16	0,8																								
	CNMG 120412 .G52	12,9	12,7	4,76	5,16	1,2																								
	CNMG 160608 .G52	16,1	15,87	6,35	6,35	0,8																								
	CNMG 160616 .G52	16,1	15,87	6,35	6,35	1,6																								
	CNMG 090304 .G53	9,52	9,52	3,18	3,81	0,4																								
	CNMG 090308 .G53	9,52	9,52	3,18	3,81	0,8																								
	CNMG 120404 .G53	12,9	12,7	4,76	5,16	0,4																								
	CNMG 120408 .G53	12,9	12,7	4,76	5,16	0,8																								
MATERIALE - MATERIAL - MATERIALIEN - MATÉRIAUX											C4010								F2120	F2425	T1126	T1415	T1425	T3111	T3112	T3121	T3220	T1435	T2120	D3010
P	ACCIAIO - STEEL - STAHL - ACIER										○									○	●	●	●	○						
M	ACCIAIO INOX - STAINLESS STEEL - ROSTFREIER STAHL - ACIER INOXIDABLE										●									●	●	●	○							
K	GHISA - CAST IRON - GRAUGUSS - FONTE GRISE										○								○	●	○	○	●	●	●	●				
N	LEGHE DI ALLUMINIO - ALUMINIUM ALLOYS - ALUMINIUM-LEGIERUNGEN - ALLIAGES D'ALUMINIUM																			○									●	
S	LEGHE RESISTENTI AL CALORE - HEAT RESISTANT ALLOYS - WÄRMEBESTÄNDIGE LEGIERUNGEN - ALLIAGES RÉISTANTES À LA CHALEUR																		○											
H	MATERIALI DURI E TEMPRATI - HARD AND HARDENED MATERIAL - HARTE UND GEHÄRTETE MATERIALIEN - MATÉRIAUX DURS ET TREMPÉS																													

■ DISPONIBILI - IN STOCK - LIEFERBAR - DISPONIBLES / NEW
 ● APPLICAZIONE CONSIGLIATA-RECOMMENDED APPLICATION-
 EMPFOHLENER EINSATZ - APPLICATION CONSEILLÉE

□ A RICHIESTA - ON REQUEST - AUF ANFRAGE - SUR DEMANDE / NEW
 ○ APPLICAZIONE POSSIBILE - POSSIBLE APPLICATION -
 MÖGLICHE ANWENDUNG - APPLICATION POSSIBLE

CNMG CNMM							HT	HW	HC										DP			
							CERMET	NON RIVESTITI CEMENTED CARBIDE GRADES	RIVESTITI COATED GRADES BESCHICHTET RECOUVERTS										PCD			
INSERTI NEGATIVI - NEGATIVE INSERTS - NEGATIVE WENDEPLATTEN - PLAQUÉTTES NEGATIVES																						
ART.	COD.	l	d	s	d1	r	T110	F2425	T1126	F8410	T1415	T1425	T3111	T3112 ϵ mz	T3121 ϵ mz	T3210	T3220	T1435	F8315	T2120		
.G55	CNMG 120404 .G55	12,9	12,7	4,76	5,16	0,4					■									■		
	CNMG 120408 .G55	12,9	12,7	4,76	5,16	0,8					■										■	
.G56	CNMG 120408 .G56	12,9	12,7	4,76	5,16	0,8			■		■	■										
	CNMG 120412 .G56	12,9	12,7	4,76	5,16	1,2					■	■										
.K57P	CNMG 120404 .K57P	12,9	12,7	4,76	5,16	0,4	■															
	CNMG 120408 .K57P	12,9	12,7	4,76	5,16	0,8	■															
.F61	CNMG 120408 .F61	12,9	12,7	4,76	5,16	0,8								■	■							
	CNMG 120412 .F61	12,9	12,7	4,76	5,16	1,2								■	■							
	CNMG 120416 .F61	12,9	12,7	4,76	5,16	1,6								■	■							
	CNMG 160612 .F61	16,1	15,87	6,35	6,35	1,2								■	■							
	CNMG 160616 .F61	16,1	15,87	6,35	6,35	1,6								■	■							
	NEW																					
.G62	CNMG 120408 .G62	12,9	12,7	4,76	5,16	0,8					■	■	■									
	CNMG 120412 .G62	12,9	12,7	4,76	5,16	1,2					■	■						■				
	CNMG 120416 .G62	12,9	12,7	4,76	5,16	1,6												■				
	CNMG 160608 .G62	16,1	15,87	6,35	6,35	0,8													■	■		
	CNMG 160612 .G62	16,1	15,87	6,35	6,35	1,2						■						■	■			
	CNMG 160616 .G62	16,1	15,87	6,35	6,35	1,6							■					■	■			
	CNMG 190612 .G62	19,3	19,05	6,35	7,94	1,2						■						■	■			
	CNMG 190616 .G62	19,3	19,05	6,35	7,94	1,6						■						■	■			
.G63	CNMG 120408 .G63	12,9	12,7	4,76	5,16	0,8			■													■
	CNMG 120412 .G63	12,9	12,7	4,76	5,16	1,2			■													
.G68	CNMM 120408 .G68	12,9	12,7	4,76	5,16	0,8					■	■										■
.G72	CNMM 120412 .G72	12,9	12,7	4,76	5,16	1,2					■	■										■
	CNMM 120416 .G72	12,9	12,7	4,76	5,16	1,6						■										■
	CNMM 160612 .G72	16,1	15,87	6,35	6,35	1,2					■	■										■
	CNMM 190612 .G72	19,3	19,05	6,35	7,94	1,2					■	■										
	CNMM 190616 .G72	19,3	19,05	6,35	7,94	1,6						■										
	CNMM 250724 .G72	25,80	25,40	7,94	9,12	2,4							□									
CNMM 250924 .G72	25,80	25,40	9,52	9,12	2,4								□									
MATERIALE - MATERIAL - MATERIALIEN - MATÉRIAUX							T110	F2425	T1126	F8410	T1415	T1425	T3111	T3112 ϵ mz	T3121 ϵ mz	T3210	T3220	T1435	F8315	T2120		
P	ACCIAIO - STEEL - STAHL - ACIER							○	●		●	●	○								○	
M	ACCIAIO INOX - STAINLESS STEEL - ROSTFREIER STAHL - ACIER INOXYDABLE									●	●	○	○						○		○	●
K	GHISA - CAST IRON - GRAUGUSS - FONTE GRISE									●		○	○	●	●	●	●	●				
N	LEGHE DI ALLUMINIO - ALUMINIUM ALLOYS - ALUMINIUM-LEGIERUNGEN - ALLIAGES D'ALUMINIUM						●															
S	LEGHE RESISTENTI AL CALORE - HEAT RESISTANT ALLOYS - WÄRMEBESTÄNDIGE LEGIERUNGEN - ALLIAGES RÉISTANTES À LA CHALEUR										●										●	
H	MATERIALI DURI E TEMPRATI - HARD AND HARDENED MATERIAL - HARTE UND GEHÄRTETE MATERIALIEN - MATERIAUX DURS ET TREMPÉS																					

■ DISPONIBILI - IN STOCK - LIEFERBAR - DISPONIBLES / ■ NEW
● APPLICAZIONE CONSIGLIATA-RECOMMENDED APPLICATION- EMPFOHLENER EINSATZ - APPLICATION CONSEILLÉE

□ A RICHIESTA - ON REQUEST - AUF ANFRAGE - SUR DEMANDE / □ NEW
○ APPLICAZIONE POSSIBILE - POSSIBLE APPLICATION - MÖGLICHE ANWENDUNG - APPLICATION POSSIBLE

CNMM CNMX	DNGP DNMG	HT					HW					HC					DP									
		CERMET					NON RIVESTITI CEMENTED CARBIDE GRADES					RIVESTITI COATED GRADES BESCHICHTET RECOUVERTS					PCD									
INSERTI NEGATIVI - NEGATIVE INSERTS - NEGATIVE WENDEPLATTEN - PLAQUÉTTES NEGATIVES																										
ART.	COD.	l	d	s	d1	r	C4010						F2120	F2425	T1126	F8410	T1415	T1425	T3112	T3121	T3220	T1435	F8315	T2120		
 .G82	CNMM 190616 .G82	19,3	19,05	6,35	7,94	1,6																				
	CNMM 190624 .G82	19,3	19,05	6,35	7,94	2,4																				
	CNMM 250924 .G82	25,80	25,40	9,52	9,12	2,4																				
	CNMM 250932 .G82	25,80	25,40	9,52	9,12	3,2																				
 .G34W	CNMX 120408 .G34W	12,9	12,7	4,76	5,16	0,8																				
 .G23	DNGP 110404 .G23	11,6	9,52	4,76	3,81	0,4																				
	DNGP 150602 .G23	15,5	12,7	6,35	5,16	0,2																				
	DNGP 150604 .G23	15,5	12,7	6,35	5,16	0,4																				
	DNGP 150608 .G23	15,5	12,7	6,35	5,16	0,8																				
 .G39	DNMG 150604 .G39	15,5	12,7	6,35	5,16	0,4																				
 .G42	DNMG 110404 .G42	11,6	9,52	4,76	3,81	0,4																				
	DNMG 150604 .G42	15,5	12,7	6,35	5,16	0,4																				
 .F51	DNMG 150608 .F51	15,5	12,7	6,35	5,16	0,8																				
 .G52	DNMG 110404 .G52	11,6	9,52	4,76	3,81	0,4																				
	DNMG 110408 .G52	11,6	9,52	4,76	3,81	0,8																				
	DNMG 150604 .G52	15,5	12,7	6,35	5,16	0,4																				
	DNMG 150608 .G52	15,5	12,7	6,35	5,16	0,8																				
	DNMG 150612 .G52	15,5	12,7	6,35	5,16	1,2																				
 .G53	DNMG 110404 .G53	11,6	9,52	4,76	3,81	0,4																				
	DNMG 110408 .G53	11,6	9,52	4,76	3,81	0,8																				
	DNMG 150604 .G53	15,5	12,7	6,35	5,16	0,4																				
	DNMG 150608 .G53	15,5	12,7	6,35	5,16	0,8																				
 .G55	DNMG 150608 .G55	15,5	12,7	6,35	5,16	0,8																				
 .G56	DNMG 150608 .G56	15,5	12,7	6,35	5,16	0,8																				
	DNMG 150612 .G56	15,5	12,7	6,35	5,16	1,2																				
MATERIALE - MATERIAL - MATERIALIEN - MATÉRIAUX							C4010						F2120	F2425	T1126	F8410	T1415	T1425	T3112	T3121	T3220	T1435	F8315	T2120		
P	ACCIAIO - STEEL - STAHL - ACIER						○							○	●	○	●	●			○	●		○		
M	ACCIAIO INOX - STAINLESS STEEL - ROSTFREIER STAHL - ACIER INOXYDABLE						●						●	●	●	○		○				○		○	●	
K	GHISA - CAST IRON - GRAUGUSS - FONTE GRISE						○						○	●	○	○	●	●								
N	LEGHE DI ALLUMINIO - ALUMINIUM ALLOYS - ALUMINIUM-LEGIERUNGEN - ALLIAGES D'ALUMINIUM												○													
S	LEGHE RESISTENTI AL CALORE - HEAT RESISTANT ALLOYS - WÄRMEBESTÄNDIGE LEGIERUNGEN - ALLIAGES RÉSISTANTES À LA CHALEUR												○			●								●		
H	MATERIALI DURI E TEMPRATI - HARD AND HARDENED MATERIAL - HARTE UND GEHÄRTETE MATERIALIEN - MATERIAUX DURS ET TREMPÉS																									

● DISPONIBILI - IN STOCK - LIEFERBAR - DISPONIBLES / NEW
 ○ APPLICAZIONE CONSIGLIATA-RECOMMENDED APPLICATION-
 EMPFOHLENER EINSATZ - APPLICATION CONSEILLÉE

○ A RICHIESTA - ON REQUEST - AUF ANFRAGE - SUR DEMANDE / NEW
 ○ APPLICAZIONE POSSIBILE - POSSIBLE APPLICATION -
 MÖGLICHE ANWENDUNG - APPLICATION POSSIBLE

DNMG DNMM DNMX		KNUX		SNMA SNMG		HT	HW	HC									DP								
						CERMET	NON RIVESTITI CEMENTED CARBIDE GRADES	RIVESTITI COATED GRADES BESCHICHTET RECOUVERTS									PCD								
INSERTI POSITIVI - POSITIVE INSERTS - POSITIVE WENDEPLATTEN - PLAQUÉTTES POSITIVES																									
ART.	COD.		l	d	s	d1	r				F2425	T1126	F8410	T1415	T1425	T3111	T3112 EMZ	T3121 EMZ	T3220	T1435	F8315	T2120			
	DNMG 150608 .F61		15,5	12,7	6,35	5,16	0,8																		
	DNMG 150612 .F61 NEW		15,5	12,7	6,35	5,16	1,2																		
	DNMG 150608 .G62		15,5	12,7	6,35	5,16	0,8																		
	DNMG 150608 .G63		15,5	12,7	6,35	5,16	0,8																		
	DNMG 150612 .G63		15,5	12,7	6,35	5,16	1,2																		
	DNMM 150608 .G68		15,5	12,7	6,35	5,16	0,8																		
	DNMM 150612 .G72		15,5	12,7	6,35	5,16	1,2																		
	DNMX 150608 .G34W		15,5	12,7	6,35	5,16	0,8																		
	KNUX 160405EL .G69		16,0	9,52	4,76	-	0,5																		
	KNUX 160405ER .G69		16,0	9,52	4,76	-	0,5																		
	KNUX 160410EL .G69		16,0	9,52	4,76	-	1,0																		
	KNUX 160410ER .G69		16,0	9,52	4,76	-	1,0																		
	SNMA 120408 .G61		12,7	12,7	4,76	5,16	0,8																		
	SNMA 120408 .F71		12,7	12,7	4,76	5,16	0,8																		
	NEW																								
	SNMG 120412 .F51		12,7	12,7	4,76	5,16	1,2																		
	NEW																								
	SNMG 120408 .G52		12,7	12,7	4,76	5,16	0,8																		
	SNMG 120412 .G52		12,7	12,7	4,76	5,16	1,2																		
	SNMG 120408 .G53		12,7	12,7	4,76	5,16	0,8																		
	SNMG 120408 .G55		12,7	12,7	4,76	5,16	0,8																		
MATERIALE - MATERIAL - MATERIALIEN - MATÉRIAUX											F2425	T1126	F8410	T1415	T1425	T3111	T3112 EMZ	T3121 EMZ	T3220	T1435	F8315	T2120			
P	ACCIAIO - STEEL - STAHL - ACIER											○	●		●	●	○			○	●		○		
M	ACCIAIO INOX - STAINLESS STEEL - ROSTFREIER STAHL - ACIER INOXYDABLE											●	●	○	○						○	○	●		
K	GHISA - CAST IRON - GRAUGUSS - FONTE GRISE											●			○	○	●	●	●						
N	LEGHE DI ALLUMINIO - ALUMINIUM ALLOYS - ALUMINIUM-LEGIERUNGEN - ALLIAGES D'ALUMINIUM																								
S	LEGHE RESISTENTI AL CALORE - HEAT RESISTANT ALLOYS - WÄRMEBESTÄNDIGE LEGIERUNGEN - ALLIAGES RÉSISTANTES À LA CHALEUR														●								●		
H	MATERIALI DURI E TEMPRATI - HARD AND HARDENED MATERIAL - HARTE UND GEHÄRTETE MATERIALIEN - MATERIAUX DURS ET TREMPÉS																								

SNMG SNMM		TNMA TNMG		HT		HW		HC						DP						
				CERMET		NON RIVESTITI CEMENTED CARBIDE GRADES		RIVESTITI COATED GRADES BESCHICHTET RECOUVERTS						PCD						
INSERTI NEGATIVI - NEGATIVE INSERTS - NEGATIVE WENDEPLATTEN - PLAQUÉTTES NEGATIVES													T1425	T3111	T3112 \leq mZ	T3121 \leq mZ	T3220	T1435	T1215 \leq mZ	T1225 \leq mZ
ART.	COD.	l	d	s	d1	r														
	SNMG 120408 .G56	12,7	12,7	4,76	5,16	0,8							■							
	SNMG 120412 .G56	12,7	12,7	4,76	5,16	1,2							■							
	SNMG 120408 .F61	12,7	12,7	4,76	5,16	0,8														
	SNMG 150612 .F61	15,87	15,87	6,35	6,35	1,2								■						
	SNMG 120408 .G62	12,7	12,7	4,76	5,16	0,8														
	SNMG 120412 .G62	12,7	12,7	4,76	5,16	1,2							■							
	SNMG 150612 .G62	15,87	15,87	6,35	6,35	1,2							■							
	SNMG 190612 .G62	19,05	19,05	6,35	7,94	1,2								■						
	SNMM 190616 .G54	19,05	19,05	6,35	7,94	1,6														
	SNMM 250924 .G54	25,40	25,40	9,52	9,12	2,4														
	SNMM 190612 .G72	19,05	19,05	6,35	7,94	1,2														
	SNMM 190616 .G72	19,05	19,05	6,35	7,94	1,6														
	SNMM 250724 .G72	25,40	25,40	7,94	9,12	2,4														
	SNMM 250924 .G72	25,40	25,40	9,52	9,12	2,4														
	SNMM 190616 .G82	19,05	19,05	6,35	7,94	1,6														
	SNMM 190624 .G82	19,05	19,05	6,35	7,94	2,4														
	SNMM 250924 .G82	25,40	25,40	9,52	9,12	2,4														
	SNMM 250932 .G82	25,40	25,40	9,52	9,12	3,2														
	TNMA 160408 .G61	16,5	9,52	4,76	3,81	0,8														
	TNMA 160408 .F71	16,5	9,52	4,76	3,81	0,8														
	TNMA 160412 .F71	16,5	9,52	4,76	3,81	1,2														
	TNMG 160404 .F32	16,5	9,52	4,76	3,81	0,4														
	TNMG 160408 .F32	16,5	9,52	4,76	3,81	0,8														
	TNMG 160408 .F51	16,5	9,52	4,76	3,81	0,8														
MATERIALE - MATERIAL - MATERIALIEN - MATÉRIAUX													T1425	T3111	T3112 \leq mZ	T3121 \leq mZ	T3220	T1435	T1215 \leq mZ	T1225 \leq mZ
P	ACCIAIO - STEEL - STAHL - ACIER												●	○						
M	ACCIAIO INOX - STAINLESS STEEL - ROSTFREIER STAHL - ACIER INOXYDABLE												○							
K	GHISA - CAST IRON - GRAUGUSS - FONTE GRISE												○	●	●	●	○			
N	LEGHE DI ALLUMINIO - ALUMINIUM ALLOYS - ALUMINIUM-LEGIERUNGEN - ALLIAGES D'ALUMINIUM																			
S	LEGHE RESISTENTI AL CALORE - HEAT RESISTANT ALLOYS - WÄRMEBESTÄNDIGE LEGIERUNGEN - ALLIAGES RÉISTANTES À LA CHALEUR																			
H	MATERIALI DURI E TEMPRATI - HARD AND HARDENED MATERIAL - HARTE UND GEHÄRTETE MATERIALIEN - MATÉRIAUX DURS ET TREMPÉS																			

■ DISPONIBILI - IN STOCK - LIEFERBAR - DISPONIBLES / ■ NEW
 ● APPLICAZIONE CONSIGLIATA-RECOMMENDED APPLICATION-
 EMPFOHLENER EINSATZ - APPLICATION CONSEILLÉE

□ A RICHIESTA - ON REQUEST - AUF ANFRAGE - SUR DEMANDE / □ NEW
 ○ APPLICAZIONE POSSIBILE - POSSIBLE APPLICATION -
 MÖGLICHE ANWENDUNG - APPLICATION POSSIBLE

TNMG			VNGP VNMG				HT	HW	HC								DP					
							CERMET	NON RIVESTITI CEMENTED CARBIDE GRADES	RIVESTITI COATED GRADES BESCHICHTET RECOUVERTS								PCD					
INSERTI NEGATIVI - NEGATIVE INSERTS - NEGATIVE WENDEPLATTEN - PLAQUÉTTES NEGATIVES											F2120	F2425	T1126	F8410	T1415	T1425	T3220	T1435	F8315			
ART.	COD.		l	d	s	d1	r															
 .G52	TNMG 160404 .G52		16,5	9,52	4,76	3,81	0,4															
	TNMG 160408 .G52		16,5	9,52	4,76	3,81	0,8															
	TNMG 160412 .G52		16,5	9,52	4,76	3,81	1,2															
	TNMG 220404 .G52		22,0	12,70	4,76	5,16	0,4															
	TNMG 220408 .G52		22,0	12,70	4,76	5,16	0,8															
 .G53	TNMG 160404 .G53		16,5	9,52	4,76	3,81	0,4															
	TNMG 160408 .G53		16,5	9,52	4,76	3,81	0,8															
 .G55	TNMG 160408 .G55		16,5	9,52	4,76	3,81	0,8															
 .G56	TNMG 160408 .G56		16,5	9,52	4,76	3,81	0,8															
	TNMG 160412 .G56		16,5	9,52	4,76	3,81	1,2															
 .G62	TNMG 160408 .G62		16,5	9,52	4,76	3,81	0,8															
 .G63	TNMG 160408 .G63		16,5	9,52	4,76	3,81	0,8															
	TNMG 160412 .G63		16,5	9,52	4,76	3,81	1,2															
 .G23	VNGP 160402 .G23		16,6	9,52	4,76	3,81	0,2															
	VNGP 160404 .G23		16,6	9,52	4,76	3,81	0,4															
 .G42	VNMG 160404 .G42		16,6	9,52	4,76	3,81	0,4															
 .G52	VNMG 160404 .G52		16,6	9,52	4,76	3,81	0,4															
	VNMG 160408 .G52		16,6	9,52	4,76	3,81	0,8															
 .G53	VNMG 160408 .G53		16,6	9,52	4,76	3,81	0,8															
 .G55	VNMG 160408 .G55		16,6	9,52	4,76	3,81	0,8															
MATERIALE - MATERIAL - MATERIALIEN - MATÉRIAUX											F2120	F2425	T1126	F8410	T1415	T1425	T3220	T1435	F8315			
P	ACCIAIO - STEEL - STAHL - ACIER											○	●	●	●	○		●				
M	ACCIAIO INOX - STAINLESS STEEL - ROSTFREIER STAHL - ACIER INOXYDABLE										●	●	●	○	○			○	○			
K	GHISA - CAST IRON - GRAUGUSS - FONTE GRISE										○	●	○	○	●							
N	LEGHE DI ALLUMINIO - ALUMINIUM ALLOYS - ALUMINIUM-LEGIERUNGEN - ALLIAGES D'ALUMINIUM											○										
S	LEGHE RESISTENTI AL CALORE - HEAT RESISTANT ALLOYS - WÄRMEBESTÄNDIGE LEGIERUNGEN - ALLIAGES RÉSIDANTES À LA CHALEUR										○		●						●			
H	MATERIALI DURI E TEMPRATI - HARD AND HARDENED MATERIAL - HARTE UND GEHÄRTETE MATERIALIEN - MATERIAUX DURS ET TREMPÉS																					

WNGP WNMA WNMG								HT	HW	HC										DP		
								CERMET	NON RIVESTITI CEMENTED CARBIDE GRADES	RIVESTITI COATED GRADES BESCHICHTET RECOUVERTS										PCD		
INSERTI NEGATIVI - NEGATIVE INSERTS - NEGATIVE WENDEPLATTEN - PLAQUÉTTES NEGATIVES																						
ART.	COD.	l	d	s	d1	r		T110	F2120	F2425	T1126	F8410	T1415	T1425	T3111	T3112	T3121	T3220	T1435	F8315	T2120	
 .G23	WNGP 080404 .G23	8,7	12,7	4,76	5,16	0,4																
	WNGP 080408 .G23	8,7	12,7	4,76	5,16	0,8																
 .G61	WNMA 080408 .G61	8,7	12,7	4,76	5,16	0,8																
	WNMA 080412 .G61	8,7	12,7	4,76	5,16	1,2																
 .F71	WNMA 080408 .F71	8,6	12,7	4,76	5,16	0,8																
	WNMA 080412 .F71	8,6	12,7	4,76	5,16	1,2																
 .G42	WNMG 060404 .G42	6,5	9,52	4,76	3,81	0,4																
	WNMG 080404 .G42	8,7	12,7	4,76	5,16	0,4																
 .F51	WNMG 080408 .F51	8,6	12,7	4,76	5,16	0,8																
	WNMG 080412 .F51	8,6	12,7	4,76	5,16	1,2																
 .G52	WNMG 060404 .G52	6,5	9,52	4,76	3,81	0,4																
	WNMG 060408 .G52	6,5	9,52	4,76	3,81	0,8																
	WNMG 080404 .G52	8,7	12,7	4,76	5,16	0,4																
	WNMG 080408 .G52	8,7	12,7	4,76	5,16	0,8																
	WNMG 080412 .G52	8,7	12,7	4,76	5,16	1,2																
 .G53	WNMG 060404 .G53	6,5	9,52	4,76	3,81	0,4																
	WNMG 060408 .G53	6,5	9,52	4,76	3,81	0,8																
	WNMG 080404 .G53	8,7	12,7	4,76	5,16	0,4																
	WNMG 080408 .G53	8,7	12,7	4,76	5,16	0,8																
 .G55	WNMG 080408 .G55	8,7	12,7	4,76	5,16	0,8																
 .G56	WNMG 080408 .G56	8,7	12,7	4,76	5,16	0,8																
	WNMG 080412 .G56	8,7	12,7	4,76	5,16	1,2																
 .K57P	WNMG 080404 .K57P	8,7	12,7	4,76	5,16	0,4																
	WNMG 080408 .K57P	8,7	12,7	4,76	5,16	0,8																
 .F61	WNMG 080408 .F61	8,6	12,7	4,76	5,16	0,8																
	WNMG 080412 .F61	8,6	12,7	4,76	5,16	1,2																
MATERIALE - MATERIAL - MATERIALIEN - MATÉRIAUX																						
P	ACCIAIO - STEEL - STAHL - ACIER																					
M	ACCIAIO INOX - STAINLESS STEEL - ROSTFREIER STAHL - ACIER INOXYDABLE																					
K	GHISA - CAST IRON - GRAUGUSS - FONTE GRISE																					
N	LEGHE DI ALLUMINIO - ALUMINIUM ALLOYS - ALUMINIUM-LEGIERUNGEN - ALLIAGES D'ALUMINIUM																					
S	LEGHE RESISTENTI AL CALORE - HEAT RESISTANT ALLOYS - WÄRMEBESTÄNDIGE LEGIERUNGEN - ALLIAGES RÉISTANTES À LA CHALEUR																					
H	MATERIALI DURI E TEMPRATI - HARD AND HARDENED MATERIAL - HARTE UND GEHÄRTETE MATERIALIEN - MATÉRIAUX DURS ET TREMPÉS																					

■ DISPONIBILI - IN STOCK - LIEFERBAR - DISPONIBLES / ■ NEW
 ● APPLICAZIONE CONSIGLIATA-RECOMMENDED APPLICATION-
 EMPFOHLENER EINSATZ - APPLICATION CONSEILLÉE

□ A RICHIESTA - ON REQUEST - AUF ANFRAGE - SUR DEMANDE / □ NEW
 ○ APPLICAZIONE POSSIBILE - POSSIBLE APPLICATION -
 MÖGLICHE ANWENDUNG - APPLICATION POSSIBLE

WNMG WNMX							HT	HW	HC					DP					
							CERMET	NON RIVESTITI CEMENTED CARBIDE GRADES	RIVESTITI COATED GRADES BESCHICHTET RECOUVERTS					PCD					
INSERTI NEGATIVI - NEGATIVE INSERTS - NEGATIVE WENDEPLATTEN - PLAQUÉTTES NEGATIVES											F2425	T1415	T1425	T3111	T3220				
ART.	COD.	l	d	s	d1	r													
 .G62	WNMG 080408 .G62	8,7	12,7	4,76	5,16	0,8							■	■	■	■			
	WNMG 080412 .G62	8,7	12,7	4,76	5,16	1,2								■	■	■	■		
 .G63	WNMG 080408 .G63	8,7	12,7	4,76	5,16	0,8							■						
	WNMG 080412 .G63	8,7	12,7	4,76	5,16	1,2								■					
 .G34W	WNMX 080408 .G34W	8,7	12,7	4,76	5,16	0,8								■					
MATERIALE - MATERIAL - MATERIALIEN - MATÉRIAUX											F2425	T1415	T1425	T3111	T3220				
P	ACCIAIO - STEEL - STAHL - ACIER												○	●	●	○	○		
M	ACCIAIO INOX - STAINLESS STEEL - ROSTFREIER STAHL - ACIER INOXYDABLE												●		○				
K	GHISA - CAST IRON - GRAUGUSS - FONTE GRISE													○	○	●	●		
N	LEGHE DI ALLUMINIO - ALUMINIUM ALLOYS - ALUMINIUM-LEGIERUNGEN - ALLIAGES D'ALUMINIUM																		
S	LEGHE RESISTENTI AL CALORE - HEAT RESISTANT ALLOYS - WÄRMEBESTÄNDIGE LEGIERUNGEN - ALLIAGES RÉSISTANTES À LA CHALEUR																		
H	MATERIALI DURI E TEMPRATI - HARD AND HARDENED MATERIAL - HARTE UND GEHÄRTETE MATERIALIEN - MATERIAUX DURS ET TREMPÉS																		







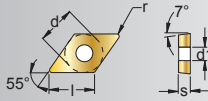

CCET CCGT CCGW CCMT							HT		HW			HC					DP					
							CERMET		NON RIVESTITI CEMENTED CARBIDE GRADES			RIVESTITI COATED GRADES BESCHICHTET RECOUVERTS					PCD					
INSERTI POSITIVI - POSITIVE INSERTS - POSITIVE WENDEPLATTEN - PLAQUÉTTES POSITIVES																						
ART.	COD.	l	d	s	d1	r	C4010	DT63	T115			T3310 $\leq mZ$	F2120	F2326 $\leq mZ$	T531				T1215 $\leq mZ$	T1225 $\leq mZ$	D3010	
	CCET 060202 L .B22	6,5	6,35	2,38	2,8	0,2	■															
	CCET 060204 L .B22	6,5	6,35	2,38	2,8	0,4	■															
	CCET 09T304 L .B22	9,7	9,52	3,97	4,4	0,4	■															
	CCGT 060202 .F47	6,5	6,35	2,38	2,8	0,2						■										
	CCGT 060204 .F47	6,5	6,35	2,38	2,8	0,4						■										
	CCGT 09T302 .F47	9,7	9,52	3,97	4,4	0,2						■										
	CCGT 09T304 .F47	9,7	9,52	3,97	4,4	0,4						■										
	CCGT 09T308 .F47	9,7	9,52	3,97	4,4	0,8						■										
	CCGT 120404 .F47	12,9	12,7	4,76	5,5	0,4						■										
	CCGT 120408 .F47	12,9	12,7	4,76	5,5	0,8						■										
	NEW																					
	CCGT 060200 .G13	6,5	6,35	2,38	2,8	0,0							■									
	CCGT 060201 .G13	6,5	6,35	2,38	2,8	0,1							■									
	CCGT 09T300 .G13	9,7	9,52	3,97	4,4	0,0							■									
	CCGT 09T301 .G13	9,7	9,52	3,97	4,4	0,1							■									
	CCGT 060201 .G57P	6,5	6,35	2,38	2,8	0,1			■													
	CCGT 060202 .G57P	6,5	6,35	2,38	2,8	0,2			■													
	CCGT 060204 .G57P	6,5	6,35	2,38	2,8	0,4			■													
	CCGT 09T302 .G57P	9,7	9,52	3,97	4,4	0,2			■													
	CCGT 09T304 .G57P	9,7	9,52	3,97	4,4	0,4			■													
	CCGT 09T308 .G57P	9,7	9,52	3,97	4,4	0,8			■													
	CCGT 120404 .G57P	12,9	12,7	4,76	5,5	0,4			■													
CCGT 120408 .G57P	12,9	12,7	4,76	5,5	0,8			■														
	CCGW 060202 .X47	6,5	6,35	2,38	2,8	0,2																■
	CCGW 060204 .X47	6,5	6,35	2,38	2,8	0,4																■
	CCGW 09T302 .X47	9,7	9,52	3,97	4,4	0,2																■
	CCGW 09T304 .X47	9,7	9,52	3,97	4,4	0,4																■
	CCGW 09T308 .X47	9,7	9,52	3,97	4,4	0,8																■
	CCGW 120404 .X47	12,9	12,7	4,76	5,5	0,4																■
	CCGW 120408 .X47	12,9	12,7	4,76	5,5	0,8																■
	CCMT 060202 .F32	6,5	6,35	2,38	2,8	0,2															■	■
	CCMT 060204 .F32	6,5	6,35	2,38	2,8	0,4															■	■
	CCMT 060208 .F32	6,5	6,35	2,38	2,8	0,8															■	■
	CCMT 09T304 .F32	9,7	9,52	3,97	4,4	0,4															■	■
	CCMT 09T308 .F32	9,7	9,52	3,97	4,4	0,8															■	■
	NEW																					
	CCMT 060202 .F33	6,5	6,35	2,38	2,8	0,2							■									
	CCMT 060204 .F33	6,5	6,35	2,38	2,8	0,4							■									
	CCMT 09T304 .F33	9,7	9,52	3,97	4,4	0,4							■									
	NEW																					
	CCMT 060204 .G39	6,5	6,35	2,38	2,8	0,4	■															
	CCMT 09T304 .G39	9,7	9,52	3,97	4,4	0,4	■															
MATERIALE - MATERIAL - MATERIALIEN - MATÉRIAUX							C4010	DT63	T115			T3310 $\leq mZ$	F2120	F2326 $\leq mZ$	T531				T1215 $\leq mZ$	T1225 $\leq mZ$	D3010	
P	ACCIAIO - STEEL - STAHL - ACIER						●	●				○	○	○	○					●	●	
M	ACCIAIO INOX - STAINLESS STEEL - ROSTFREIER STAHL - ACIER INOXYDABLE						●	●				○	●	●	●					○	○	
K	GHISA - CAST IRON - GRAUGUSS - FONTE GRISE						○	●	○			○	○							○		
N	LEGHE DI ALLUMINIO - ALUMINIUM ALLOYS - ALUMINIUM-LEGIERUNGEN - ALLIAGES D'ALUMINIUM								●			●	○									●
S	LEGHE RESISTENTI AL CALORE - HEAT RESISTANT ALLOYS - WÄRMEBESTÄNDIGE LEGIERUNGEN - ALLIAGES RÉISTANTES À LA CHALEUR								○			○										
H	MATERIALI DURI E TEMPRATI - HARD AND HARDENED MATERIAL - HARTE UND GEHÄRTETE MATERIALIEN - MATERIAUX DURS ET TREMPÉS																					

■ DISPONIBILI - IN STOCK - LIEFERBAR - DISPONIBLES / ■ NEW
 ● APPLICAZIONE CONSIGLIATA-RECOMMENDED APPLICATION-
 EMPFOHLENER EINSATZ - APPLICATION CONSEILLÉE

○ A RICHIESTA - ON REQUEST - AUF ANFRAGE - SUR DEMANDE / ○ NEW
 ○ APPLICAZIONE POSSIBILE - POSSIBLE APPLICATION -
 MÖGLICHE ANWENDUNG - APPLICATION POSSIBLE

CCMT CCMX		CPGT CPMT		HT CERMET		HW NON RIVESTITI CEMENTED CARBIDE GRADES		HC RIVESTITI COATED GRADES BESCHICHTET RECOUVERTS							DP PCD										
INSERTI POSITIVI - POSITIVE INSERTS - POSITIVE WENDEPLATTEN - PLAQUÉTTES POSITIVES												DT61T	T120	F2425	T1126	F2435	T1415	T1425	T3112 EMZ	T3121 EMZ	T3220	T1435			
ART.	COD.	l	d	s	d1	r																			
 G42	CCMT 060202 .G42	6,5	6,35	2,38	2,8	0,2																			
	CCMT 060204 .G42	6,5	6,35	2,38	2,8	0,4																			
	CCMT 09T302 .G42	9,7	9,52	3,97	4,4	0,2																			
	CCMT 09T304 .G42	9,7	9,52	3,97	4,4	0,4																			
	CCMT 09T308 .G42	9,7	9,52	3,97	4,4	0,8																			
	CCMT 120404 .G42	12,9	12,7	4,76	5,5	0,4																			
 F51	CCMT 09T304 .F51	9,7	9,52	3,97	4,4	0,4																			
	CCMT 09T308 .F51	9,7	9,52	3,97	4,4	0,8																			
	CCMT 120408 .F51	12,9	12,7	4,76	5,5	0,8																			
	NEW																								
 G52	CCMT 060204 .G52	6,5	6,35	2,38	2,8	0,4																			
	CCMT 060208 .G52	6,5	6,35	2,38	2,8	0,8																			
	CCMT 09T304 .G52	9,7	9,52	3,97	4,4	0,4																			
	CCMT 09T308 .G52	9,7	9,52	3,97	4,4	0,8																			
	CCMT 120404 .G52	12,9	12,7	4,76	5,5	0,4																			
	CCMT 120408 .G52	12,9	12,7	4,76	5,5	0,8																			
	CCMT 120412 .G52	12,9	12,7	4,76	5,5	1,2																			
 G32W	CCMX 09T304 .G32W	9,7	9,52	3,97	4,4	0,4																			
 D34	CPGT 05T102 EN .D34	5,6	5,56	1,97	2,5	0,2	■																		
	CPGT 05T104 EN .D34	5,6	5,56	1,97	2,5	0,4	■																		
 D42	CPGT 05T102 FN .D42	5,6	5,56	1,97	2,5	0,2		■																	
	CPGT 05T104 FN .D42	5,6	5,56	1,97	2,5	0,4		■																	
 G42	CPMT 05T102 EN .G42	5,6	5,56	1,97	2,5	0,2																			
	CPMT 05T104 EN .G42	5,6	5,56	1,97	2,5	0,4																			
MATERIALE - MATERIAL - MATERIALIEN - MATÉRIAUX							DT61T	T120	F2425	T1126	F2435	T1415	T1425	T3112 EMZ	T3121 EMZ	T3220	T1435								
P	ACCIAIO - STEEL - STAHL - ACIER						●			○	●	○	●	●											
M	ACCIAIO INOX - STAINLESS STEEL - ROSTFREIER STAHL - ACIER INOXYDABLE						●		○	●	●		○									○			
K	GHISA - CAST IRON - GRAUGUSS - FONTE GRISE						○		●		●		○	○	●	●	●								
N	LEGHE DI ALLUMINIO - ALUMINIUM ALLOYS - ALUMINIUM-LEGIERUNGEN - ALLIAGES D'ALUMINIUM						○		○																
S	LEGHE RESISTENTI AL CALORE - HEAT RESISTANT ALLOYS - WÄRMEBESTÄNDIGE LEGIERUNGEN - ALLIAGES RÉSISTANTES À LA CHALEUR																								
H	MATERIALI DURI E TEMPRATI - HARD AND HARDENED MATERIAL - HARTE UND GEHÄRTETE MATERIALIEN - MATERIAUX DURS ET TREMPÉS																								

DCGT DCGW							HT	HW	HC						DP									
							CERMET	NON RIVESTITI CEMENTED CARBIDE GRADES	RIVESTITI COATED GRADES BESCHICHTET RECOUVERTS						PCD									
INSERTI POSITIVI - POSITIVE INSERTS - POSITIVE WENDEPLATTEN - PLAQUÉTTES POSITIVES													T115	T3310 <input checked="" type="checkbox"/>	F8116 <input checked="" type="checkbox"/>	F2120							F8120	D3010
ART.	COD.	l	d	s	d1	r																		
 F M R .G13	DCGT 070200 .G13	7,8	6,35	2,38	2,8	0,0																		
	DCGT 070201 .G13	7,8	6,35	2,38	2,8	0,1																		
	DCGT 11T300 .G13	11,6	9,52	3,97	4,4	0,0																		
	DCGT 11T301 .G13	11,6	9,52	3,97	4,4	0,1																		
 F M R L .F45 R .F45	DCGT 0702008 L .F45	7,8	6,35	2,38	2,8	0,08																		
	DCGT 0702008 R .F45	7,8	6,35	2,38	2,8	0,08																		
	DCGT 0702015 L .F45	7,8	6,35	2,38	2,8	0,15																		
	DCGT 0702015 R .F45	7,8	6,35	2,38	2,8	0,15																		
	DCGT 11T3015 L .F45	11,6	9,52	3,97	4,4	0,15																		
	DCGT 11T3015 R .F45	11,6	9,52	3,97	4,4	0,15																		
	DCGT 11T3035 L .F45	11,6	9,52	3,97	4,4	0,35																		
	DCGT 11T3035 R .F45	11,6	9,52	3,97	4,4	0,35																		
NEW																								
 F M R .F46	DCGT 0702008 .F46	7,8	6,35	2,38	2,8	0,08																		
	DCGT 0702015 .F46	7,8	6,35	2,38	2,8	0,15																		
	DCGT 11T3015 .F46	11,6	9,52	3,97	4,4	0,15																		
	DCGT 11T3035 .F46	11,6	9,52	3,97	4,4	0,35																		
NEW																								
 F M R .F47	DCGT 070202 .F47	7,8	6,35	2,38	2,8	0,2																		
	DCGT 070204 .F47	7,8	6,35	2,38	2,8	0,4																		
	DCGT 11T302 .F47	11,6	9,52	3,97	4,4	0,2																		
	DCGT 11T304 .F47	11,6	9,52	3,97	4,4	0,4																		
	DCGT 11T308 .F47	11,6	9,52	3,97	4,4	0,8																		
NEW																								
 F M R .B53	DCGT 070202 .B53	7,8	6,35	2,38	2,8	0,2																		
	DCGT 070204 .B53	7,8	6,35	2,38	2,8	0,4																		
	DCGT 11T302 .B53	11,6	9,52	3,97	4,4	0,2																		
	DCGT 11T304 .B53	11,6	9,52	3,97	4,4	0,4																		
 F M R .G57P	DCGT 070201 .G57P	7,8	6,35	2,38	2,8	0,1																		
	DCGT 070202 .G57P	7,8	6,35	2,38	2,8	0,2																		
	DCGT 070204 .G57P	7,8	6,35	2,38	2,8	0,4																		
	DCGT 070208 .G57P	7,8	6,35	2,38	2,8	0,8																		
	DCGT 11T302 .G57P	11,6	9,52	3,97	4,4	0,2																		
	DCGT 11T304 .G57P	11,6	9,52	3,97	4,4	0,4																		
 F M R .X47	DCGW 070202 .X47	7,8	6,35	2,38	2,8	0,2																		
	DCGW 070204 .X47	7,8	6,35	2,38	2,8	0,4																		
	DCGW 11T302 .X47	11,6	9,52	3,97	4,4	0,2																		
	DCGW 11T304 .X47	11,6	9,52	3,97	4,4	0,4																		
MATERIALE - MATERIAL - MATERIALIEN - MATÉRIAUX													T115	T3310 <input checked="" type="checkbox"/>	F8116 <input checked="" type="checkbox"/>	F2120							F8120	D3010
P	ACCIAIO - STEEL - STAHL - ACIER																							
M	ACCIAIO INOX - STAINLESS STEEL - ROSTFREIER STAHL - ACIER INOXYDABLE																							
K	GHISA - CAST IRON - GRAUGUSS - FONTE GRISE																							
N	LEGHE DI ALLUMINIO - ALUMINIUM ALLOYS - ALUMINIUM-LEGIERUNGEN - ALLIAGES D'ALUMINIUM																							
S	LEGHE RESISTENTI AL CALORE - HEAT RESISTANT ALLOYS - WÄRMEBESTÄNDIGE LEGIERUNGEN - ALLIAGES RÉSISTANTES À LA CHALEUR																							
H	MATERIALI DURI E TEMPRATI - HARD AND HARDENED MATERIAL - HARTE UND GEHÄRTETE MATERIALIEN - MATERIAUX DURS ET TREMPÉS																							

DCMT DCMX							HT	HW	HC										DP						
							CERMET	NON RIVESTITI CEMENTED CARBIDE GRADES	RIVESTITI COATED GRADES BESCHICHTET RECOUVERTS										PCD						
ART.	COD.	l	d	s	d1	r	C4010					F2425	F2326	F2435	T1415	T1425	T3111	T3121	T3220	T1435	T1215	T1225			
 .F32	DCMT 070202 .F32	7,8	6,35	2,38	2,8	0,2																			
	DCMT 070204 .F32	7,8	6,35	2,38	2,8	0,4																			
	DCMT 11T302 .F32	11,6	9,52	3,97	4,4	0,2																			
	DCMT 11T304 .F32	11,6	9,52	3,97	4,4	0,4																			
	NEW																								
 .F33	DCMT 070202 .F33	7,8	6,35	2,38	2,8	0,2																			
	DCMT 070204 .F33	7,8	6,35	2,38	2,8	0,4																			
	DCMT 11T302 .F33	11,6	9,52	3,97	4,4	0,2																			
	DCMT 11T304 .F33	11,6	9,52	3,97	4,4	0,4																			
	NEW																								
 .G39	DCMT 070204 .G39	7,8	6,35	2,38	2,8	0,4	■																		
	DCMT 11T304 .G39	11,6	9,52	3,97	4,4	0,4	■																		
 .G42	DCMT 070202 .G42	7,8	6,35	2,38	2,8	0,2						■													
	DCMT 070204 .G42	7,8	6,35	2,38	2,8	0,4						■			■	■									
	DCMT 11T302 .G42	11,6	9,52	3,97	4,4	0,2						■													
	DCMT 11T304 .G42	11,6	9,52	3,97	4,4	0,4						■													
	DCMT 11T308 .G42	11,6	9,52	3,97	4,4	0,8						■													
 .F51	DCMT 070204 .F51	7,7	6,35	2,38	2,8	0,4																			
	DCMT 11T304 .F51	11,6	9,52	3,97	4,4	0,4																			
	DCMT 11T308 .F51	11,6	9,52	3,97	4,4	0,8																			
	NEW																								
 .G52	DCMT 070204 .G52	7,8	6,35	2,38	2,8	0,4						■													
	DCMT 070208 .G52	7,8	6,35	2,38	2,8	0,8						■													
	DCMT 11T304 .G52	11,6	9,52	3,97	4,4	0,4						■	■		■	■									
	DCMT 11T308 .G52	11,6	9,52	3,97	4,4	0,8						■	■		■	■									
 .G32W	DCMX 11T304 .G32W	11,6	9,52	3,97	4,4	0,4																			
MATERIALE - MATERIAL - MATERIALIEN - MATÉRIAUX							C4010					F2425	F2326	F2435	T1415	T1425	T3111	T3121	T3220	T1435	T1215	T1225			
P	ACCIAIO - STEEL - STAHL - ACIER						●						○	○	○	●	●	○		○	●	○	○	○	
M	ACCIAIO INOX - STAINLESS STEEL - ROSTFREIER STAHL - ACIER INOXYDABLE						●						●	●	●		○				○			○	
K	GHISA - CAST IRON - GRAUGUSS - FONTE GRISE						○									○	○	●	●	●		○			
N	LEGHE DI ALLUMINIO - ALUMINIUM ALLOYS - ALUMINIUM-LEGIERUNGEN - ALLIAGES D'ALUMINIUM																								
S	LEGHE RESISTENTI AL CALORE - HEAT RESISTANT ALLOYS - WÄRMEBESTÄNDIGE LEGIERUNGEN - ALLIAGES RÉSISSANTES À LA CHALEUR																								
H	MATERIALI DURI E TEMPRATI - HARD AND HARDENED MATERIAL - HARTE UND GEHÄRTETE MATERIALIEN - MATERIAUX DURS ET TREMPÉS																								

RCGT RCMT			SCGT SCMT			HT		HW		HC					DP												
						CERMET		NON RIVESTITI CEMENTED CARBIDE GRADES		RIVESTITI COATED GRADES BESCHICHTET RECOUVERTS					PCD												
INSERTI POSITIVI - POSITIVE INSERTS - POSITIVE WENDEPLATTEN - PLAQUÉTTES POSITIVES																											
ART.	COD.		l	d	s	d1	r		T110	T115	F2115 $\leq mZ$	F2425	T1126	T1425	T3121 $\leq mZ$	T3220		T1435									
 .Z57	RCGT 0602MO FN .Z57		-	6	2,38	2,8	-		■																		
	RCGT 0803MO FN .Z57		-	8	3,18	3,4	-		■																		
	RCGT 1003MO FN .Z57		-	10	3,18	4,0	-		■																		
 .G52	RCMT 0602MO .G52		-	6	2,38	2,8	-																			■	
	RCMT 0803MO .G52		-	8	3,18	3,4	-																				■
	RCMT 1003MO .G52		-	10	3,18	4,0	-																				■
 .G57	SCGT 120408 .G57		12,7	12,7	4,76	5,3	0,8				■																
	NEW																										
 .G57P	SCGT 09T304 .G57P		9,52	9,52	3,97	4,4	0,4		■																		
	SCGT 09T308 .G57P		9,52	9,52	3,97	4,4	0,8		■																		
 .F51	SCMT 120408 .F51		12,7	12,7	4,76	5,3	0,8									■											
	NEW																										
 .G52	SCMT 09T304 .G52		9,52	9,52	3,97	4,4	0,4					■		■													
	SCMT 09T308 .G52		9,52	9,52	3,97	4,4	0,8					■	■	■		■											
	SCMT 120404 .G52		12,7	12,7	4,76	5,3	0,4					■		■													
	SCMT 120408 .G52		12,7	12,7	4,76	5,3	0,8					■		■		■											■
	SCMT 120412 .G52		12,7	12,7	4,76	5,3	1,2					■		■													■
MATERIALE - MATERIAL - MATERIALIEN - MATÉRIAUX									T110	T115	F2115 $\leq mZ$	F2425	T1126	T1425	T3121 $\leq mZ$	T3220		T1435									
P	ACCIAIO - STEEL - STAHL - ACIER											○	●	●	○	○			●								
M	ACCIAIO INOX - STAINLESS STEEL - ROSTFREIER STAHL - ACIER INOXYDABLE											●	●	○					○								
K	GHISA - CAST IRON - GRAUGUSS - FONTE GRISE								○	○			●	○	●	●											
N	LEGHE DI ALLUMINIO - ALUMINIUM ALLOYS - ALUMINIUM-LEGIERUNGEN - ALLIAGES D'ALUMINIUM								●	●	●																
S	LEGHE RESISTENTI AL CALORE - HEAT RESISTANT ALLOYS - WÄRMEBESTÄNDIGE LEGIERUNGEN - ALLIAGES RÉSISTANTES À LA CHALEUR								○	○	●																
H	MATERIALI DURI E TEMPRATI - HARD AND HARDENED MATERIAL - HARTE UND GEHÄRTETE MATERIALIEN - MATERIAUX DURS ET TREMPÉS																										

■ DISPONIBILI - IN STOCK - LIEFERBAR - DISPONIBLES / ■ NEW
 ● APPLICAZIONE CONSIGLIATA-RECOMMENDED APPLICATION-
 EMPFOHLENER EINSATZ - APPLICATION CONSEILLÉE

□ A RICHIESTA - ON REQUEST - AUF ANFRAGE - SUR DEMANDE / □ NEW
 ○ APPLICAZIONE POSSIBILE - POSSIBLE APPLICATION -
 MÖGLICHE ANWENDUNG - APPLICATION POSSIBLE

TCGT TCGW TCMT	TPMR						HT	HW		HC							DP								
	CERMET		NON RIVESTITI CEMENTED CARBIDE GRADES		RIVESTITI COATED GRADES BESCHICHTET RECOUVERTS							PCD													
INSERTI POSITIVI - POSITIVE INSERTS - POSITIVE WENDEPLATTEN - PLAQUÉTTES POSITIVES													C4010	T115	T120	T1625	F2425	T7725 $\leq m/z$	F2435	T1415	T1425	T3220	T1435	T540	D3010
ART.	COD.	l	d	s	d1	r																			
.G39	TCGT 110202 .G39	11,0	6,35	2,38	2,8	0,2	■																		
.G57P	TCGT 090202 .G57P	9,6	5,56	2,38	2,5	0,2		■																	
	TCGT 090204 .G57P	9,6	5,56	2,38	2,5	0,4		■																	
	TCGT 110204 .G57P	11,0	6,35	2,38	2,8	0,4		■																	
	TCGT 16T304 .G57P	16,5	9,52	3,97	4,4	0,4		■																	
	TCGT 16T308 .G57P	16,5	9,52	3,97	4,4	0,8		■																	
.X47	TCGW 090202 .X47 / .X37	9,6	5,56	2,38	2,5	0,2																			
	TCGW 090204 .X47 / .X37	9,6	5,56	2,38	2,5	0,4																			
	TCGW 110202 .X47 / .X37	11,0	6,35	2,38	2,8	0,2																			
	TCGW 110204 .X47 / .X37	11,0	6,35	2,38	2,8	0,4																			
.X37	TCGW 16T304 .X47 / .X37	16,5	9,52	3,97	4,4	0,4																			
.G39	TCMT 110204 .G39	11,0	6,35	2,38	2,8	0,4	■																		
.S42	TCMT 110202 .S42	11,0	6,35	2,38	2,8	0,2																			
	TCMT 110204 .S42	11,0	6,35	2,38	2,8	0,4			■																
	TCMT 16T304 .S42	16,5	9,52	3,97	4,4	0,4			■																
	TCMT 16T308 .S42	16,5	9,52	3,97	4,4	0,8			■																
	TCMT 220404 .S42	22,0	12,7	4,76	5,6	0,4			■																
.G52	TCMT 090204 .G52	9,6	5,56	2,38	2,5	0,4					■														
	TCMT 110204 .G52	11,0	6,35	2,38	2,8	0,4					■		■									■			
	TCMT 110208 .G52	11,0	6,35	2,38	2,8	0,8					■		■									■			
	TCMT 16T304 .G52	16,5	9,52	3,97	4,4	0,4					■											■			
	TCMT 16T308 .G52	16,5	9,52	3,97	4,4	0,8					■											■			
	TCMT 16T312 .G52	16,5	9,52	3,97	4,4	1,2					■											■			
.S44	TPMR 110304 .S44	11,0	6,35	3,18	-	0,4						■													
	TPMR 110308 .S44	11,0	6,35	3,18	-	0,8						■													
	TPMR 160304 .S44	16,5	9,52	3,18	-	0,4																			
	TPMR 160308 .S44	16,5	9,52	3,18	-	0,8																			
MATERIALE - MATERIAL - MATERIALIEN - MATÉRIAUX							C4010	T115	T120	T1625	F2425	T7725 $\leq m/z$	F2435	T1415	T1425	T3220	T1435	T540	D3010						
P	ACCIAIO - STEEL - STAHL - ACIER						●				●	●	●	●	○			●	●						
M	ACCIAIO INOX - STAINLESS STEEL - ROSTFREIER STAHL - ACIER INOXYDABLE						●		○		○	○	●	○	○			○	●						
K	GHISA - CAST IRON - GRAUGUSS - FONTE GRISE						○		○	●	○	○	○	○	○	●									
N	LEGHE DI ALLUMINIO - ALUMINIUM ALLOYS - ALUMINIUM-LEGIERUNGEN - ALLIAGES D'ALUMINIUM								●	○												○	●		
S	LEGHE RESISTENTI AL CALORE - HEAT RESISTANT ALLOYS - WÄRMEBESTÄNDIGE LEGIERUNGEN - ALLIAGES RÉISTANTES À LA CHALEUR								○	○												○			
H	MATERIALI DURI E TEMPRATI - HARD AND HARDENED MATERIAL - HARTE UND GEHÄRTETE MATERIALIEN - MATERIAUX DURS ET TREMPÉS																								

VBGW VBMT			VCGT VCGW			HT	HW	HC								DP		
	COD.	l		d	s	d1	r	T115	T3310 $\leq m/z$	F8116 $\leq m/z$	F2120	F2425	F2435	T1415	T1425	T1435	D3010	
 .X47	VBGW 160402 .X47	16,5	9,52	4,76	4,4	0,2												
	VBGW 160404 .X47	16,5	9,52	4,76	4,4	0,4												
 .G42	VBMT 160404 .G42	16,5	9,52	4,76	4,4	0,4												
	VBMT 160408 .G42	16,5	9,52	4,76	4,4	0,8												
 .G52	VBMT 160404 .G52	16,5	9,52	4,76	4,4	0,4												
	VBMT 160408 .G52	16,5	9,52	4,76	4,4	0,8												
 .G58	VBMT 160404 .G58	16,5	9,52	4,76	4,4	0,4												
	VBMT 160408 .G58	16,5	9,52	4,76	4,4	0,8												
 .G13	VCGT 110300 .G13	11,1	6,35	3,18	2,9	0,0												
	VCGT 110301 .G13	11,1	6,35	3,18	2,9	0,1												
	VCGT 160400 .G13	16,5	9,52	4,76	4,4	0,0												
	VCGT 160401 .G13	16,5	9,52	4,76	4,4	0,1												
 .G57P	VCGT 110302 .G57P	11,1	6,35	3,18	2,9	0,2												
	VCGT 110304 .G57P	11,1	6,35	3,18	2,9	0,4												
	VCGT 160404 .G57P	16,5	9,52	4,76	4,4	0,4												
	VCGT 160408 .G57P	16,5	9,52	4,76	4,4	0,8												
	VCGT 160412 .G57P	16,5	9,52	4,76	4,4	1,2												
 .F46	VCGT 1103008 .F46	11,1	6,35	3,18	2,9	0,08												
	VCGT 1103015 .F46	11,1	6,35	3,18	2,9	0,15												
 .F47	VCGT 110302 .F47	11,1	6,35	3,18	2,9	0,2												
	VCGT 110304 .F47	11,1	6,35	3,18	2,9	0,4												
	VCGT 160402 .F47	16,5	9,52	4,76	4,4	0,2												
	VCGT 160404 .F47	16,5	9,52	4,76	4,4	0,4												
	VCGT 160408 .F47	16,5	9,52	4,76	4,4	0,8												
	VCGT 160412 .F47	16,5	9,52	4,76	4,4	1,2												
 .X47	VCGW 160404 .X47	16,5	9,52	4,76	4,4	0,4												
MATERIALE - MATERIAL - MATERIALIEN - MATÉRIAUX								T115										
P	ACCIAIO - STEEL - STAHL - ACIER																	
M	ACCIAIO INOX - STAINLESS STEEL - ROSTFREIER STAHL - ACIER INOXYDABLE																	
K	GHISA - CAST IRON - GRAUGUSS - FONTE GRISE																	
N	LEGHE DI ALLUMINIO - ALUMINIUM ALLOYS - ALUMINIUM-LEGIERUNGEN - ALLIAGES D'ALUMINIUM																	
S	LEGHE RESISTENTI AL CALORE - HEAT RESISTANT ALLOYS - WÄRMEBESTÄNDIGE LEGIERUNGEN - ALLIAGES RÉISTANTES À LA CHALEUR																	
H	MATERIALI DURI E TEMPRATI - HARD AND HARDENED MATERIAL - HARTE UND GEHÄRTETE MATERIALIEN - MATERIAUX DURS ET TREMPÉS																	

DISPONIBILI - IN STOCK - LIEFERBAR - DISPONIBLES / NEW
 APPLICAZIONE CONSIGLIATA-RECOMMENDED APPLICATION- EMPFOHLENER EINSATZ - APPLICATION CONSEILLÉE

A RICHIESTA - ON REQUEST - AUF ANFRAGE - SUR DEMANDE / NEW
 APPLICAZIONE POSSIBILE - POSSIBLE APPLICATION - MÖGLICHE ANWENDUNG - APPLICATION POSSIBLE

VCMT			WCGT WCGT			HT		HW		HC							DP												
						CERMET		NON RIVESTITI CEMENTED CARBIDE GRADES		RIVESTITI COATED GRADES BESCHICHTET RECOUVERTS							PCD												
INSERTI POSITIVI - POSITIVE INSERTS - POSITIVE WENDEPLATTEN - PLAQUÉTTES POSITIVES														C4010	DT63														
ART.	COD.		l	d	s	d1	r					F2425	F2326 ⊗	F2435	T1415	T1425			T1435			T1215 ⊗	T1225 ⊗	T2335					
 .F32	VCMT 110302 .F32		11,1	6,35	3,18	2,9	0,2																						
	VCMT 110304 .F32		11,1	6,35	3,18	2,9	0,4																						
	VCMT 160404 .F32		16,5	9,52	4,76	4,4	0,4																						
	NEW																												
 .F33	VCMT 110302 .F33		11,1	6,35	3,18	2,9	0,2																						
	VCMT 110304 .F33		11,1	6,35	3,18	2,9	0,4																						
 .G42	VCMT 110302 .G42		11,1	6,35	3,18	2,9	0,2																						
	VCMT 110304 .G42		11,1	6,35	3,18	2,9	0,4																						
	VCMT 160404 .G42		16,5	9,52	4,76	4,4	0,4																						
 .G52	VCMT 110304 .G52		11,1	6,35	3,18	2,9	0,4																						
	VCMT 110308 .G52		11,1	6,35	3,18	2,9	0,8																						
	VCMT 160404 .G52		16,5	9,52	4,76	4,4	0,4																						
	VCMT 160408 .G52		16,5	9,52	4,76	4,4	0,8																						
 .B22	WCGT 020102 L .B22		2,62	3,97	1,59	2,3	0,2																						
	WCGT 020102 R .B22		2,62	3,97	1,59	2,3	0,2																						
	WCGT 020104 L .B22		2,62	3,97	1,59	2,3	0,4																						
 .G39	WCGT 020102 .G39		2,62	3,97	1,59	2,3	0,2																						
 .B56	WCGT 020102 .B56		2,62	3,97	1,59	2,3	0,2																						
	WCGT 020104 .B56		2,62	3,97	1,59	2,3	0,4																						
MATERIALE - MATERIAL - MATERIALIEN - MATÉRIAUX								C4010	DT63																				
P	ACCIAIO - STEEL - STAHL - ACIER							●	●					○	○	○	○			○		○	○	○					
M	ACCIAIO INOX - STAINLESS STEEL - ROSTFREIER STAHL - ACIER INOXYDABLE							●	●				●	●	●	○			○		○		○	○	●				
K	GHISA - CAST IRON - GRAUGUSS - FONTE GRISE							○	●						○	○						○							
N	LEGHE DI ALLUMINIO - ALUMINIUM ALLOYS - ALUMINIUM-LEGIERUNGEN - ALLIAGES D'ALUMINIUM																												
S	LEGHE RESISTENTI AL CALORE - HEAT RESISTANT ALLOYS - WÄRMEBESTÄNDIGE LEGIERUNGEN - ALLIAGES RÉSISTANTES À LA CHALEUR																												
H	MATERIALI DURI E TEMPRATI - HARD AND HARDENED MATERIAL - HARTE UND GEHÄRTETE MATERIALIEN - MATERIAUX DURS ET TREMPÉS																												

SLT										HT	HW	HC			HSS		
										CERMET	NON RIVESTITI CEMENTED CARBIDE GRADES	RIVESTITI COATED GRADES BESCHICHTET RECOUVERTS			ACCIAIO SUPER RAPIDO HIGH SPEED STEEL HOCHSCHNELLSTAHL ACIER SUPER RAPIDE		
INSERTI POSITIVI - POSITIVE INSERTS - POSITIVE WENDEPLATTEN - PLAQUÉTTES POSITIVES											F7230			HSS33			
ART.	COD.	TOLL.	W	s	s1	l	T	d1									
	SLT 030-0604 H7	(3,000-3,010)	3	4,66	4,76	6	1,5	2,8									
	SLT 030-0604 D10	(3,020-3,060)	3	4,66	4,76	6	1,5	2,8									
	SLT 030-0604 C11	(3,060-3,120)	3	4,66	4,76	6	1,5	2,8									
	SLT 040-0604 H7	(4,000-4,012)	4	4,66	4,76	6	2,5	2,8									
	SLT 040-0604 D10	(4,030-4,078)	4	4,66	4,76	6	2,5	2,8									
	SLT 040-0604 C11	(4,070-4,145)	4	4,66	4,76	6	2,5	2,8									
	SLT 050-0604 H7	(5,000-5,012)	5	4,66	4,76	6	3,0	2,8									
	SLT 050-0604 D10	(5,030-5,078)	5	4,66	4,76	6	3,0	2,8									
	SLT 050-0604 C11	(5,070-5,145)	5	4,66	4,76	6	3,0	2,8									
	SLT 060-1006 H7	(6,000-6,012)	6	6,25	6,35	10	4,0	4,4									
	SLT 060-1006 D10	(6,030-6,078)	6	6,25	6,35	10	4,0	4,4									
	SLT 060-1006 C11	(6,070-6,145)	6	6,25	6,35	10	4,0	4,4									
	SLT 080-1006 H7	(8,000-8,015)	8	6,25	6,35	10	5,0	4,4									
	SLT 080-1006 D10	(8,040-8,098)	8	6,25	6,35	10	5,0	4,4									
	SLT 080-1006 C11	(8,080-8,170)	8	6,25	6,35	10	5,0	4,4									
	SLT 100-1309 H7	(10,000-10,015)	10	9,40	9,60	13	6,0	6,5									
	SLT 100-1309 D10	(10,040-10,098)	10	9,40	9,60	13	6,0	6,5									
	SLT 100-1309 C11	(10,080-10,170)	10	9,40	9,60	13	6,0	6,5									
	SLT 120-1309 H7	(12,000-12,018)	12	9,40	9,60	13	7,0	6,5									
	SLT 120-1309 D10	(12,050-12,120)	12	9,40	9,60	13	7,0	6,5									
SLT 120-1309 C11	(12,095-12,205)	12	9,40	9,60	13	7,0	6,5										
MATERIALE - MATERIAL - MATERIALIEN - MATÉRIAUX											F7230			HSS33			
P	ACCIAIO - STEEL - STAHL - ACIER										●			●			
M	ACCIAIO INOX - STAINLESS STEEL - ROSTFREIER STAHL - ACIER INOXYDABLE										●			○			
K	GHISA - CAST IRON - GRAUGUSS - FONTE GRISE										●			●			
N	LEGHE DI ALLUMINIO - ALUMINIUM ALLOYS - ALUMINIUM-LEGIERUNGEN - ALLIAGES D'ALUMINIUM										●			●			
S	LEGHE RESISTENTI AL CALORE - HEAT RESISTANT ALLOYS - WÄRMEBESTÄNDIGE LEGIERUNGEN - ALLIAGES RÉISTANTES À LA CHALEUR										●			●			
H	MATERIALI DURI E TEMPRATI - HARD AND HARDENED MATERIAL - HARTE UND GEHÄRTETE MATERIALIEN - MATERIAUX DURS ET TREMPÉS										●			●			

● DISPONIBILI - IN STOCK - LIEFERBAR - DISPONIBLES / NEW
 ● APPLICAZIONE CONSIGLIATA-RECOMMENDED APPLICATION-
 EMPFOHLENER EINSATZ - APPLICATION CONSEILLÉE

□ A RICHIESTA - ON REQUEST - AUF ANFRAGE - SUR DEMANDE / NEW
 ○ APPLICAZIONE POSSIBILE - POSSIBLE APPLICATION -
 MÖGLICHE ANWENDUNG - APPLICATION POSSIBLE

SCelta VELOCE QUICK PICK

Tenacità + ↑
Toughness - ↓

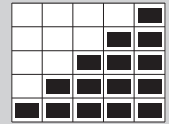

- METODO PER LA SCELTA VELOCE DEL GRADO DI METALLO DURO PIÙ IDONEO. CONTARE IL NUMERO DI RETTANGOLI COLORATI
- METHOD FOR A QUICK CHOICE OF THE MOST SUITABLE SOLID CARBIDE GRADE. COUNT THE NUMBER OF COLORED RECTANGLES
- METHODE ZUR RASCHEN AUSWAHL DER GEEIGNETSTEN HARTMETALLSORTE. DIE ANZAHL DER BUNTEN RECH TECKEZHLEN
- METHODE POUR CHOISIR RAPIDEMENT LE DEGRÉ LE PLUS APPROPRIÉ DU METAL DUR. COMPTER LES RECTANGLES EN COULEURS
- METODO PARA LA ELECCION RAPIDA DE EL GRADO MAS ADECUADO DE METAL DURO. CONTAR LOS NUMEROS DE RECTANGULOS COLORAEDOS

- GRADO MOLTO RESISTENTE ALL'USURA, SOLO PER FINITURA, LAVORAZIONI AD ALTE VELOCITÀ DI TAGLIO E CONDIZIONI MOLTO RIGIDE E STABILI
- GRADE WITH HIGH RESISTANCE TO WEAR; ONLY FOR FINISHING, MACHINING AT HIGH CUTTING SPEEDS, AND VERY RIGID AND STABLE CONDITIONS
- GRADO CON ALTA RESISTENZA ALL'USURA, DISCRETA TENACITÀ PER LAVORAZIONI A VELOCITÀ MEDIO ALTE ED AVANZAMENTI MEDI, IN CONDIZIONI NORMALI
- GRADE WITH HIGH RESISTANCE TO WEAR, GOOD TOUGHNESS, FOR MEDIUM-HIGH MACHINING AND MEDIUM FEED UNDER NORMAL CONDITIONS
- GRADO CON BUONA RESISTENZA ALL'USURA UNITA A BUONA TENACITÀ, PER LAVORAZIONI GENERICHE IN CONDIZIONI NORMALI
- GRADE WITH GOOD RESISTANCE TO WEAR; COMBINED WITH A GOOD DEGREE OF TOUGHNESS, FOR GENERAL MACHINING UNDER NORMAL CONDITIONS
- GRADO CON OTTIMA TENACITÀ PER LAVORAZIONI MEDIO PESANTI O IN CONDIZIONI POCO STABILI
- GRADE WITH EXCELLENTE TOUGHNESS, FOR MEDIUM HEAVY MACHINING OR MACHINING UNDER CONDITIONS OF LOW STABILITY
- GRADO CON ECCEZIONALE TENACITÀ PER LAVORAZIONI PESANTI CON BASSE VELOCITÀ DI TAGLIO, ALTI AVANZAMENTI O IN CONDIZIONI SFAVOREVOLI
- GRADE WITH EXCELLENTE TOUGHNESS, FOR HEAVY MACHINING WITH LOW CUTTING SPEEDS, HIGH FEED, OR UNDER UNFAVORABLE CONDITIONS

GUIDA FACILE EASY GUIDE

CNMG 120408 .G63
F2425

F	M	R
		● P
		○ M
		K
		N
		S
		H

fn = 0,25-0,50 mm

Vc = 130-200 m/min

Vc = 100-250 m/min

CNMG 120408 .G53 - F2425

P30-P40/M15-35

- GUIDA ALL'USO DELL'INSERTO. PRESENTE ANCHE SU OGNI ETICHETTA
- GUIDE FOR THE USE OF THE INSERT. ALSO LISTED ON EACH LABEL
- LEITFADEN ZUR VERWENDUNG DER WENDEPLATTE, AUCH AUF JEDEM AUFKLEBER VORHANDEN
- INSTRUCTIONS POUR L'UTILISATION DE LA PLAQUETTE. SE TROUVANT EGALEMENT SUR CHAQUE ETIQUETTE
- GUIA POR EL UTILIZO DE LA PLAQUITA, PRESENTE TAMBIEN EN CADA ETIQUETA

GR. VDI 3323 MATERIALI MATERIALS Pag. 1199	6	P	= ACCIAIO BASSO LEGATO HB 180	- LOW STEEL ALLOY
	14.1	M	= ACCIAIO INOSSIDABILE AUSTENITICO HB 180	- AUSTENITIC STAINLESS STEEL HB 180
	16	K	= GHISA GRIGIA HB 260	- GRAY CAST IRON HB 260
	21	N	= LEGHE DI ALLUMINIO HB 60	- ALUMINUM ALLOYS HB 60
	33	S	= LEGHE RESISTENTI AL CALORE (INCONEL) HB 250	- HEAT RESISTANT ALLOYS (INCONEL) HB 250
	38	H	= ACCIAIO TEMPRATO HRC 55	- TEMPERED STEEL HRC 55

F	= FINITURA, LAVORAZIONI LEGGERE	- FINISHING, LIGHT MACHINING
M	= LAVORAZIONI MEDIE, IMPIEGO GENERICO	- MEDIUM MACHINING, GENERAL USE
R	= SGROSSATURA, LAVORAZIONI PESANTI	- ROUGHING, HEAVY MACHINING

fn (mm)	= AVANZAMENTO PER TORNITURA	- FEED FOR TURNING
fz (mm/z)	= AVANZAMENTO PER FRESATURA	- FEED FOR MILLING
Vc (m/min)	= VELOCITÀ DI TAGLIO	- CUTTING SPEED
●	= APPLICAZIONE CONSIGLIATA	- RECOMMENDED APPLICATION
○	= APPLICAZIONE POSSIBILE	- POSSIBLE APPLICATION

COME SCEGLIERE I PARAMETRI DI LAVORO
HOW TO CHOOSE CUTTING DATA
EINSTELLUNG DER SCHNITTDATEN
COMMENT CHOISIR LES PARAMETRES DE SERVICE

FASE 1 - PHASE 1

SCelta GR. VDI in funzione del materiale
CHOICE OF VDI GR. DEPENDING ON MATERIAL
WAHL VDI-SORTE JE NACH WERKSTOFF
CHOIX GR. VDI EN FONCTION DU MATERIEL

Tabella comparativa dei materiali - Materials comparison table
 Material vergleichstabelle - Tableau comparatif des matériaux

UNI	WISTOFF	DIN	SAISI	BS	AFNOR	JIS	kt.1	mc	VDI 3323 GR.
ACCIAIO NON LEGATO RICOTTO									
ANNEALED NOT-ALLOY STEEL									
C < 0,15% 125 HB									
CF 10 SPB 20	1.0722	10 SPB 20	11 L 08	-	10 PBF 2	-	-	1350	0,22
CF 8 SMM 28	1.0715	8 SMM 28	12 L 13	240 M 07	S 250	-	-	1350	0,22
CF 8 SMM 36	1.0735	8 SMM 36	12 L 15	240 M 07	S 300	-	-	1450	0,22
CF 8 SMMFB 28	1.0718	8 SMMFB 28	12 L 13	-	S 250 P8	-	-	1450	0,22
CF 8 SMMFB 36	1.0737	8 SMMFB 36	12 L 14	-	S 300 P8	-	-	1450	0,22
C15 C16	1.0401	C 15	1015	080 M 15	AF 7 C 12 XC 18	-	-	1600	0,22
C20 C21	1.0402	C 20	1020	080 A 20	AF 8 C 20	-	-	1600	0,22
C 35	1.1141	Ck 35	1015	080 M 15	XC 16, XC 18	-	-	1600	0,22
ACCIAIO NON LEGATO RICOTTO									
ANNEALED NOT-ALLOY STEEL									
C 0,15-0,55% 180 HB									
-	-	1330	150 M 28	20 M 5	-	-	-	1600	0,22
-	-	1140	212 M 36	35 MF 4	-	-	-	1600	0,22
-	-	1039	150 M 36	35 M 5	-	-	-	1600	0,22
-	-	1035	080 A 35	AF 65 C 35	-	-	-	1600	0,22
-	-	1045	080 M 46	AF 65 C 45	-	-	-	1600	0,22
-	-	1045	080 M 46	XC 42	-	-	-	1600	0,22
-	-	1045	080 M 46	XC 42	-	-	-	1600	0,22
-	-	1045	080 M 46	XC 42	-	-	-	1600	0,22
-	-	1045	080 M 46	XC 42	-	-	-	1600	0,22
ACCIAIO NON LEGATO RICOTTO									
ANNEALED NOT-ALLOY STEEL									
C 0,15-0,55% 250 HB									
-	-	1330	150 M 28	20 M 5	-	-	-	1700	0,24
-	-	1140	212 M 36	35 MF 4	-	-	-	1700	0,24
-	-	1039	150 M 36	35 M 5	-	-	-	1700	0,24
-	-	1035	080 A 35	AF 65 C 35	-	-	-	1700	0,24
-	-	1045	080 M 46	AF 65 C 45	-	-	-	1700	0,24
-	-	1045	080 M 46	XC 42	-	-	-	1700	0,24
-	-	1045	080 M 46	XC 42	-	-	-	1700	0,24
-	-	1045	080 M 46	XC 42	-	-	-	1700	0,24
-	-	1045	080 M 46	XC 42	-	-	-	1700	0,24
ACCIAIO DEBOLMENTE LEGATO RICOTTO									
ANNEALED LOW-ALLOY STEEL									
C > 0,55% 300 HB									
-	-	1330	150 M 28	20 M 5	-	-	-	1700	0,24
-	-	1140	212 M 36	35 MF 4	-	-	-	1700	0,24
-	-	1039	150 M 36	35 M 5	-	-	-	1700	0,24
-	-	1035	080 A 35	AF 65 C 35	-	-	-	1700	0,24
-	-	1045	080 M 46	AF 65 C 45	-	-	-	1700	0,24
-	-	1045	080 M 46	XC 42	-	-	-	1700	0,24
-	-	1045	080 M 46	XC 42	-	-	-	1700	0,24
-	-	1045	080 M 46	XC 42	-	-	-	1700	0,24
-	-	1045	080 M 46	XC 42	-	-	-	1700	0,24

FASE 2 - PHASE 2

SCelta inserto in funzione del materiale
CHOICE OF INSERT DEPENDING ON MATERIAL
WAHL DER WENDEPLATTE JE NACH WERKSTOFF
CHOIX PLAQUETTE EN FONCTION DU MATERIEL

Tornitura - Turning - Drehen - Tournage - Torneado

	HT	VERMET
	VERMET	VERMET
FNMG 120404	12,9	12,7
FNMG 120408	12,7	12,5
FNMG 120412	12,5	12,3
FNMG 160608	12,9	12,7
FNMG 160612	12,9	12,7
FNMG 160616	12,9	12,7
FNMG 160620	12,9	12,7
FNMG 160625	12,9	12,7
FNMG 160630	12,9	12,7
FNMG 160635	12,9	12,7
FNMG 160640	12,9	12,7
FNMG 160645	12,9	12,7
FNMG 160650	12,9	12,7
FNMG 160655	12,9	12,7
FNMG 160660	12,9	12,7
FNMG 160665	12,9	12,7
FNMG 160670	12,9	12,7
FNMG 160675	12,9	12,7
FNMG 160680	12,9	12,7
FNMG 160685	12,9	12,7
FNMG 160690	12,9	12,7
FNMG 160695	12,9	12,7
FNMG 160700	12,9	12,7
FNMG 160705	12,9	12,7
FNMG 160710	12,9	12,7
FNMG 160715	12,9	12,7
FNMG 160720	12,9	12,7
FNMG 160725	12,9	12,7
FNMG 160730	12,9	12,7
FNMG 160735	12,9	12,7
FNMG 160740	12,9	12,7
FNMG 160745	12,9	12,7
FNMG 160750	12,9	12,7
FNMG 160755	12,9	12,7
FNMG 160760	12,9	12,7
FNMG 160765	12,9	12,7
FNMG 160770	12,9	12,7
FNMG 160775	12,9	12,7
FNMG 160780	12,9	12,7
FNMG 160785	12,9	12,7
FNMG 160790	12,9	12,7
FNMG 160795	12,9	12,7
FNMG 160800	12,9	12,7
FNMG 160805	12,9	12,7
FNMG 160810	12,9	12,7
FNMG 160815	12,9	12,7
FNMG 160820	12,9	12,7
FNMG 160825	12,9	12,7
FNMG 160830	12,9	12,7
FNMG 160835	12,9	12,7
FNMG 160840	12,9	12,7
FNMG 160845	12,9	12,7
FNMG 160850	12,9	12,7
FNMG 160855	12,9	12,7
FNMG 160860	12,9	12,7
FNMG 160865	12,9	12,7
FNMG 160870	12,9	12,7
FNMG 160875	12,9	12,7
FNMG 160880	12,9	12,7
FNMG 160885	12,9	12,7
FNMG 160890	12,9	12,7
FNMG 160895	12,9	12,7
FNMG 160900	12,9	12,7
FNMG 160905	12,9	12,7
FNMG 160910	12,9	12,7
FNMG 160915	12,9	12,7
FNMG 160920	12,9	12,7
FNMG 160925	12,9	12,7
FNMG 160930	12,9	12,7
FNMG 160935	12,9	12,7
FNMG 160940	12,9	12,7
FNMG 160945	12,9	12,7
FNMG 160950	12,9	12,7
FNMG 160955	12,9	12,7
FNMG 160960	12,9	12,7
FNMG 160965	12,9	12,7
FNMG 160970	12,9	12,7
FNMG 160975	12,9	12,7
FNMG 160980	12,9	12,7
FNMG 160985	12,9	12,7
FNMG 160990	12,9	12,7
FNMG 160995	12,9	12,7
FNMG 161000	12,9	12,7
FNMG 161005	12,9	12,7
FNMG 161010	12,9	12,7
FNMG 161015	12,9	12,7
FNMG 161020	12,9	12,7
FNMG 161025	12,9	12,7
FNMG 161030	12,9	12,7
FNMG 161035	12,9	12,7
FNMG 161040	12,9	12,7
FNMG 161045	12,9	12,7
FNMG 161050	12,9	12,7
FNMG 161055	12,9	12,7
FNMG 161060	12,9	12,7
FNMG 161065	12,9	12,7
FNMG 161070	12,9	12,7
FNMG 161075	12,9	12,7
FNMG 161080	12,9	12,7
FNMG 161085	12,9	12,7
FNMG 161090	12,9	12,7
FNMG 161095	12,9	12,7
FNMG 161100	12,9	12,7
FNMG 161105	12,9	12,7
FNMG 161110	12,9	12,7
FNMG 161115	12,9	12,7
FNMG 161120	12,9	12,7
FNMG 161125	12,9	12,7
FNMG 161130	12,9	12,7
FNMG 161135	12,9	12,7
FNMG 161140	12,9	12,7
FNMG 161145	12,9	12,7
FNMG 161150	12,9	12,7
FNMG 161155	12,9	12,7
FNMG 161160	12,9	12,7
FNMG 161165	12,9	12,7
FNMG 161170	12,9	12,7
FNMG 161175	12,9	12,7
FNMG 161180	12,9	12,7
FNMG 161185	12,9	12,7
FNMG 161190	12,9	12,7
FNMG 161195	12,9	12,7
FNMG 161200	12,9	12,7

FASE 3 - PHASE 3

SCelta dell'Avanzamento
 CHOICE OF FEED
 EINSTELLUNG DES VORSCHUBS
 CHOIX DE L'AVANCEMENT

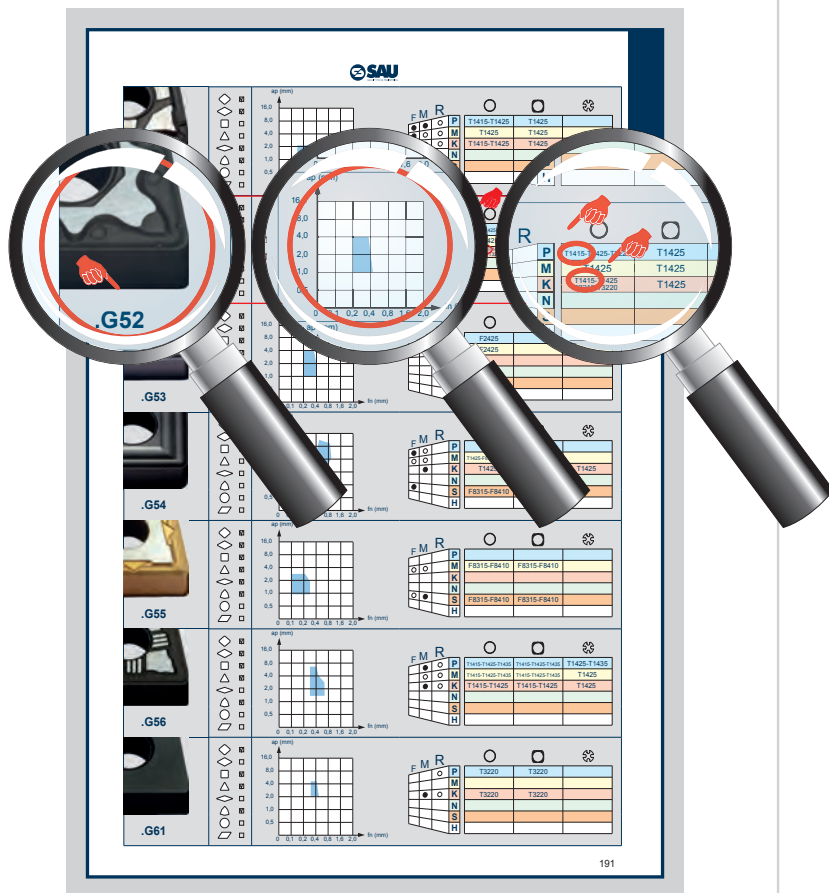

FASE 4 - PHASE 4

SCelta di VC in funzione del GR. VDI
 CHOICE OF VC DEPENDING ON VDI GR.
 WAHL VC JE NACH WERKSTOFF
 CHOIX DE VC EN FONCTION DU GR. VDI

VC(m/min)

VDI	HB	HRC	Rm	T1425	T3210	T3220	T1126	T531	F8120	T1435	F8315
1	125	220-400		170-240	250-550	200-340	170-240	200-300	170-190		
2	180	220-400		170-240	250-550	200-340	170-240	180-280	170-190		
3	250	220-400		170-240	250-550	200-340	170-240		170-190		
4	220	220-400		170-240	250-550	200-340	170-240		170-190		
5	300	220-400		170-240	250-550	200-340	170-240		170-190		
10	350	180-320		130-210	170-300	150-290	130-210		120-200		
11	350	180-320		130-210	170-300	150-290	130-210		120-200		
12	200	200-320		180-320	160-290	130-220	130-180		140-180		
13	330	200-320		180-320	160-290	130-220	100-140		140-200		
M	14.1	180	140-230		100-210	100-160	100-140		100-190	120-220	
M	14.2	230-280	65-100		70-100	80-120	75-120		50-150	50-90	
K	15	180	140-370		250-550	130-210			130-210		
K	16	280	140-370		220-420	130-210			130-210		
K	17	180	190-430		220-420	120-240			200-450	120-240	
K	18	250	190-430		200-350	200-350			200-450	120-240	
K	19	130	180-520		220-400	150-250			200-550	150-250	
K	20	230	180-520		180-350	150-250			200-550	150-250	
N	21	60									
N	22	100									
N	23	75									
N	24	90									
N	25	130									
N	26	110									
N	27	90									
N	28	100									
N	29										
N	30										
S	31	200	80-120					20-40	40-75	80-120	
S	32	380	60-100					15-35	40-60	60-100	
S	33	250	35-60					10-30	30-60	35-60	
S	34	350	30-60					5-16	20-35	30-60	
S	35	320	30-60					5-16	15-30	30-60	
S	36	Pa=420	70-120					80-130	25-45	70-120	
S	37	Pa=1050	70-120					20-40	15-35	70-120	
H	38	55HRC									
H	39	60HRC									
H	40	400									
H	41	55HRC									

DIN ISO 513	P ACCIAI STEEL STAHL ACIERS					M ACCIAI INOSSIDABILI STAINLESS STEELS ROSTFREIER STAHL ACIER INOXYDABLE				K GHISE CAST IRON GRAUGUSS FONTE GRISE					N NON FERROSI NONFERROUS NICHTEISENMA PAS FERREUX				S MAT.DIFFICILI DIFFICULT MATERIAL SCHWIERIGE MATERIEN MAT.DIFICILES					H MATERIALI DURI HARD MATERIALS HARTE MATERIEN MATERIAUX DURS							
	01	10	20	30	40	50	10	20	30	40	01	10	20	30	40	01	10	20	30	01	10	20	30	40	01	10	20	30			
HT	C4010					C4010				C4010																					
	DT61T					DT61T				DT61T																					
	DT63					DT63				DT63																					
HW										T110					T115				T115												
						T120				T120																					
HC	T3210									T3210					T3310				F8410												
	T3111					F8410				T3111					NEW				F8410												
	T1415									T3112					NEW																
	T1215									T1415					NEW																
						F8315									F2115				F2115					NEW							
						F8116													F8116					NEW							
						F2120				F2120																					
	T3220					T2120				T2120					T3220								F8120								
						F8120									T3121				NEW												
						T1225				NEW					T1625																
						T1625									T1425																
						T1425									T7725				NEW												
						F2425									T1126				NEW												
						F2326				NEW					F7230				NEW												
						F7230									T531																
						T531									T1435																
						T1435									T2335																
					F2435									F2435																	
					T540									T540																	
DP															D3010																
TENACITÀ - TOUGHNESS - ZÄHIGKEIT - TÉNACITÉ																															
→					←				→					←				→					←								
RESISTENZA ALL'USURA - RESISTANCE TO WEAR - VERSCHLEISSFESTIGKEIT - RÉSISTANCE À L'USURE																															
AVANZAMENTO - FEED - VORSCHUB - AVANCE																															
→					←				→					←				→					←								
VELOCITÀ - SPEED - GESCHWINDIGKEIT - VITESSE																															
HT	CERMET					HW	METALLO DURO NON RICOPERTO UNCOATED CARBIDE UNBESCHICHTETES HARTMETALL MÉTAL DUR PAS RECOUVERT				HC	METALLO DURO RICOPERTO COATED CARBIDE BESCHICHTETES HARTMETALL MÉTAL DUR RECOUVERT					DP	DIAMANTE POLICRISTALLINO (PCD) POLYCRYSTALLINE DIAMOND (PCD) POLYKRISTALLINER DIAMANT (PCD) DIAMANT POLYCRISTALLIN (PCD)													

SAU	DIN ISO 513	MATERIALE - MATERIAL MATERIALIEN - MATÉRIEAUX PAG. 1199						QUICK PICK PAG. 210	 Tenacità + Toughness -	 	 INDICAZIONI - USO
		P	M	K	N	S	H				
		ACCIAI STEELS STAHL ACIER	ACCIAI INOX STAINLESS STEELS ROSTFREIER STAHL ACIER INOXYDABLE	GHISA CAST IRON GRAUGUSS FONTE GRISE	MATTONI FERROSI NON FERROSI MAT. NICHT-EISENMATERIALIEN MAT. FERREUX	MAT. DIFFICILI DIFFICULT MATERIAL SCHWERE MATERIALIEN MAT. DIFICILES	MATERIALI DURI HARTE MATERIALIEN MATERIAUX DURS				
C4010	HT	P10-20 M05-15 K05-15	●	●	○					- QUALITÀ UNIVERSALE - ALTA RESISTENZA AL CALORE E ALL'USURA, BUONA TENACITÀ - INDICATO PER LE ALTE VELOCITÀ DI TAGLIO	
DT61T	HT	P05-30 M05-30 K05-30	●	●	○	○				- ALTA RESISTENZA ALL' USURA E BUONA TENACITA' - INDICATO PER ALTE VELOCITA' DI TAGLIO IN SEMIFINITURA E FINITURA	
DT63	HT	P05-25 M05-25 K05-25	●	●	●					- QUALITA' MICROGRANO MOLTO RESISTENTE ALLA ROTTURA ED ALL'USURA - INDICATO PER MEDIO-ALTE VELOCITA' DI TAGLIO IN FINITURA.	
T110	HW	K05-15			○	●	○			- ALTA RESISTENZA ALL' USURA , ELEVATA STABILITA' DEL FILO TAGLIANTE, BASSA TENDENZA ALL'INCOLLAMENTO - INDICATO PER MEDIE VELOCITA' DI TAGLIO SU GHISA GRIGIA E ALTE PER MATERIALI NON FERROSI PER ASPORTAZIONI MEDIE IN SGROSSATURA	
T115	HW	K10-20 N10-20 S10-20			○	●	○			- QUALITÀ MICROGRANO CON BUONA RESISTENZA ALL' USURA ELEVATA STABILITÀ DEL FILO TAGLIANTE, BASSA TENDENZA ALL'INCOLLAMENTO - INDICATO PER MEDIO-BASSE VELOCITÀ DI TAGLIO SU GHISA GRIGIA E ALTE PER MATERIALI NON FERROSI	
T120	HW	M10-20 K10-25		○	●	●				- QUALITA' MICROGRANO CON BUONA TENACITA' - INDICATO PER MEDIO-BASSE VELOCITA' DI TAGLIO E ALTI AVANZAMENTI. PER ASPORTAZIONI MEDIE IN SGROSSATURA	
T3310 NEW	HC CVD	N05-20	○	○	○	●				- QUALITA' MICROGRANO CON ALTA RESISTENZA ALL' USURA - INDICATO PER MEDIE VELOCITA' DI TAGLIO IL SUO RIVESTIMENTO PERMETTE DI GARANTIRE OTTIME FINITURE SU MATERIALI ISO M-S -OTTIMA APPLICAZIONE SU FINITURE DI TUTTI GLI ALTRI MATERIALI	
F2115 NEW	HC PVD	N10-20 S10-20				●	●			- QUALITA' MICROGRANO CON ALTA RESISTENZA ALL' USURA - INDICATO PER MEDIO-BASSE VELOCITA' DI TAGLIO SU MATERIALI ISO M-N-S	
F8116 NEW	HC PVD	M05-20 S05-20		○			●			- QUALITA' MICROGRANO CON ALTA RESISTENZA ALL' USURA - INDICATO PER MEDIE VELOCITA' DI TAGLIO IL SUO RIVESTIMENTO PERMETTE DI GARANTIRE OTTIME FINITURE SU MATERIALI ISO M-S	
F2120	HC PVD	M15-25 K15-25		●	○	○	○			- QUALITÀ SPECIFICA PER LA LAVORAZIONE DEGLI ACCIAI INOX, PARTICOLARMENTE ADATTO ALLE LAVORAZIONI DI SUPER FINITURA - PUÒ ESSERE IMPIEGATO NELLE LAVORAZIONI DI GHISA, ALLUMINIO E LEGHE RESISTENTI AL CALORE	

● APPLICAZIONE CONSIGLIATA
RECOMMENDED APPLICATION
EMPFOHLENER EINSATZ
APPLICATION CONSEILLÉE

○ APPLICAZIONE POSSIBILE
POSSIBLE APPLICATION
MÖGLICHE ANWENDUNG
APPLICATION POSSIBLE

● APPLICAZIONE CONSIGLIATA
RECOMMENDED APPLICATION
EMPFOHLENER EINSATZ
APPLICATION CONSEILLÉE

○ APPLICAZIONE POSSIBILE
POSSIBLE APPLICATION
MÖGLICHE ANWENDUNG
APPLICATION POSSIBLE

 INDICATIONS - USE	 GEBRAUCHSANWEISUNGEN	 INDICATION - USAGE
<ul style="list-style-type: none"> - UNIVERSAL GRADE - HIGH HEAT AND WEAR RESISTANCE, GOOD TOUGHNESS - SUITABLE FOR HIGH CUTTING SPEEDS 	<ul style="list-style-type: none"> - UNIVERSALSORTE - HOHE HITZE- UND VERSCHLEISSBESTÄNDIGKEIT, GUTE ZÄHIGKEIT - FÜR HOHE SCHNITTGESCHWINDIGKEITEN GEEIGNET 	<ul style="list-style-type: none"> - QUALITE UNIVERSELLE - HAUTE RESISTANCE A LA CHALEUR ET A L'USURE, BONNE TENACITE - INDIQUE POUR LES HAUTES VITESSES DE COUPE
<ul style="list-style-type: none"> -HIGH RESISTANCE TO WEAR AND GOOD TOUGHNESS -SUITABLE FOR HIGH CUTTING SPEEDS FOR SEMI-FINISHING AND FINISHING 	<ul style="list-style-type: none"> -HÖHE VERSCHLEISSFESTIGKEIT UND GUTE ZÄHIGKEIT -FÜR HOHE SCHNITTGESCHWINDIGKEITEN BEIM HALBSCHLICHTEN UND SCHLICHTEN 	<ul style="list-style-type: none"> -HAUTE RÉSISTANCE À L'USURE ET BONNE TENACITÉ -INDIQUÉ POUR HAUTE VITESSE DE COUPE EN SEMIFINISSAGE ET FINISSAGE
<ul style="list-style-type: none"> -MICROGRAIN GRADE WITH VERY HIGH ULTIMATE STRENGTH AND RESISTANCE TO WEAR -SUITABLE FOR MEDIUM-HIGH CUTTING SPEEDS FOR FINISHING 	<ul style="list-style-type: none"> -MIKROKORNSORTE MIT SEHR HOHER BRUCH- UND VERSCHLEISSFESTIGKEIT -FÜR HOHE SCHNITTGESCHWINDIGKEITEN BEIM SCHLICHTEN GEEIGNET 	<ul style="list-style-type: none"> -QUALITÉ DE MICROGRAIN TRÈS RÉSIDANT À LA RUPTURE ET À L'USURE -INDIQUÉ POUR HAUTE VITESSE DE COUPE EN FINISSAGE
<ul style="list-style-type: none"> -HIGH RESISTANCE TO WEAR, HIGH STABILITY OF THE CUTTING EDGE, LOW TENDENCY TO STICKING -SUITABLE FOR MEDIUM CUTTING SPEEDS ON GRAY IRON AND HIGH CUTTING SPEEDS AND NONFERROUS MATERIALS.FOR ROUGHING WITH MEDIUM REMOVAL OF MATERIAL 	<ul style="list-style-type: none"> -HOHE VERSCHLEISSFESTIGKEIT, HOHE STABILITÄT DER SCHNEIDE, NIEDRIGE NEIGUNG ZUR VERLEBUNG -FÜR MITTEL-NIEDRIGE SCHNITTGESCHWINDIGKEITEN BEI GRAUGUSS UND NE MATERIALIEN FÜR MITTLERE ZERSPANNUNG BEIM SCHRUPPEN GEEIGNET 	<ul style="list-style-type: none"> -HAUTE RÉSISTANCE A L'USURE, STABILITÉ ELEVÉE DU TRANCHANT, BASSE TENDANCE AU ENCOLLAGE -INDIQUÉE POUR MOYENNE-FAIBLE VITESSE DE COUPE SUR FONTE GRISE ET MATERIAL NON FERROUX, POUR MOYEN EMPORTATION EN ÉBAUCHAGE
<ul style="list-style-type: none"> - MICROGRAIN GRADE WITH GOOD WEAR RESISTANCE, HIGH CUTTING EDGE STABILITY, LOW TENDENCY TO STICKING - SUITABLE FOR LOW-MEDIUM CUTTING SPEEDS ON GREY CAST IRON AND OTHER NON-FERROUS MATERIALS 	<ul style="list-style-type: none"> - FEINKORNSORTE MIT GUTER VERSCHLEISSBESTÄNDIGKEIT, HOHE ECKENSTABILITÄT, GERINGERE NEIGUNG ZUM KLEBEN - FÜR MITTLERE BIS NIEDRIGE SCHNITTGESCHWINDIGKEITEN FÜR GUSS UND ANDERE NICHEISENMATERIALIEN GEEIGNET 	<ul style="list-style-type: none"> - QUALITE MICROGRAIN AVEC BONNE RESISTANCE A L'USURE ELEVEE, STABILITE DU FIL TRANCHANT, FAIBLE TENDANCE A L'ADHERENCE - INDIQUE POUR DES VITESSES HAUTES-MOYENNES DE COUPE SUR FONTE GRISE ET VITESSES HAUTES POUR DES MATERIAUX NON FERREUX
<ul style="list-style-type: none"> - MICROGRAIN GRADE WITH GOOD TOUGHNESS -SUITABLE FOR MEDIUM CUTTING SPEEDS AND HIGH FEED FOR ROUGHING WITH MEDIUM REMOVAL OF MATERIAL 	<ul style="list-style-type: none"> -MIKROKORN SORTE MIT GUTER ZÄHIGKEIT -FÜR MITTEL-NIEDRIGE SCHNITTGESCHWINDIGKEITEN GROSSE VORSCHÜBE FÜR MITTLERE ZERSPANNUNG BEIM SCHRUPPEN GEEIGNET 	<ul style="list-style-type: none"> -QUALITÉ DE MICROGRAIN AVEC BONNE TENACITE -INDIQUÉE POUR MOYENNE-FAIBLE VITESSE DE COUPE ET HAUTE DÉPLACEMENT POUR MOYEN EMPORTATION EN ÉBAUCHAGE
<ul style="list-style-type: none"> - MICROGRAIN GRADE WITH HIGH RESISTANCE TO WEAR - SUITABLE FOR MEDIUM CUTTING SPEEDS. ITS COATING ALLOWS FOR EXCELLENT FINISHES ON ISO M-S MATERIALS - EXCELLENT FOR FINISHING APPLICATIONS ON ALL OTHER MATERIALS 	<ul style="list-style-type: none"> - MIKROKORN-SORTE MIT HOHER VERSCHLEISSFESTIGKEIT - GEEIGNET FÜR MITTLERE SCHNITTGESCHWINDIGKEITEN. HERRVORAGENDE OBERFLÄCHENGÜTE AUF ISO – M-S-MATERIALIEN DANK DER BESONDEREN BESCHICHTUNG - HERRVORAGEND ZUM SCHLICHTEN AUF ALLEN ANDEREN MATERIALIEN 	<ul style="list-style-type: none"> - QUALITÉ MICROGRAIN AVEC HAUTE RÉSISTANCE À L'USURE - INDIQUÉ POUR DES VITESSES DE DÉCOUPE MOYENNES, SON REVÊTEMENT PERMET DE GARANTIR DES FINITIONS PARFAITES SUR DES MATÉRIAUX ISO M-S - APPLICATION PARFAITE SUR LES FINITIONS DE TOUS LES AUTRES MATÉRIAUX
<ul style="list-style-type: none"> - MICROGRAIN GRADE WITH HIGH RESISTANCE TO WEAR - SUITABLE FOR MEDIUM TO LOW CUTTING SPEEDS ON ISO M-S MATERIALS 	<ul style="list-style-type: none"> - MIKROKORN-SORTE MIT HOHER VERSCHLEISSFESTIGKEIT - GEEIGNET FÜR MITTLERE BIS NIEDRIGE SCHNITTGESCHWINDIGKEITEN AUF ISO-M-S-MATERIALIEN. 	<ul style="list-style-type: none"> - QUALITÉ MICROGRAIN AVEC HAUTE RÉSISTANCE À L'USURE - INDIQUÉ POUR VITESSE DE DÉCOUPE FAIBLE À MOYENNE SUR MATÉRIAUX ISO M-N-S
<ul style="list-style-type: none"> - MICROGRAIN GRADE WITH HIGH RESISTANCE TO WEAR - SUITABLE FOR MEDIUM CUTTING SPEEDS. ITS COATING ALLOWS FOR EXCELLENT FINISHING APPLICATIONS ON ISO M-S MATERIALS. 	<ul style="list-style-type: none"> - MIKROKORN-SORTE MIT HOHER VERSCHLEISSFESTIGKEIT - GEEIGNET FÜR MITTLERE SCHNITTGESCHWINDIGKEITEN. HERRVORAGENDE OBERFLÄCHENGÜTE AUF ISO – M-S-MATERIALIEN DANK DER BESONDEREN BESCHICHTUNG 	<ul style="list-style-type: none"> - QUALITÉ MICROGRAIN AVEC HAUTE RÉSISTANCE À L'USURE - INDIQUÉ POUR DES VITESSES DE DÉCOUPE MOYENNES, SON REVÊTEMENT PERMET DE GARANTIR DES FINITIONS PARFAITES SUR DES MATÉRIAUX ISO M-S
<ul style="list-style-type: none"> - SPECIFIC GRADE FOR INOX STEEL, PARTICULARLY SUITABLE FOR SUPER-FINISHING - IT CAN BE USED FOR CAST IRON, ALUMINIUM AND HEAT-RESISTANT ALLOYS 	<ul style="list-style-type: none"> - SPEZIALSORTE FÜR INOX-STAHL, BESONDERS ZUM FEIN-SCHLICHTEN GEEIGNET -EINSETZBAR FÜR GUSS, ALUMINIUM UND HITZEBESTÄNDIGE LEGIERUNGEN 	<ul style="list-style-type: none"> - QUALITE SPECIFIQUE POUR L'USINAGE DES ACIERS INOX. SPECIALEMENT PREVUE POUR LES USINAGES DE SUPER FINITION - PEUT ETRE EMPLOYEE DANS LES USINAGES DE FONTE, ALUMINIUM ET ALLIAGES RESISTANTS A LA CHALEUR

HT CERMET

HW



METALLO DURO NON RICOPERTO
UNCOATED CARBIDE
UNBESCHICHTETES HARTMETALL
MÉTAL DUR PAS RECOUVERT

HC

METALLO DURO RICOPERTO
COATED CARBIDE
BESCHICHTETES HARTMETALL
MÉTAL DUR RECOUVERT

DP

DIAMANTE POLICRISTALLINO (PCD)
POLYCRYSTALLINE DIAMOND (PCD)
POLYKRISTALLINER DIAMANT (PCD)
DIAMANT POLYCRISTALLIN (PCD)

SAU	DIN ISO 513	MATERIALE - MATERIAL MATERIALIEN - MATÉRIAUX PAG. 1199						QUICK PICK PAG. 210	 INDICAZIONI - USO	
		P	M	K	N	S	H			
		ACCIAI STEELS STAHL ACIER	ACCIAI INOX STAINLESS STEELS ROSTFREIER STAHL ACIER INOXYDABLE	GHISA CAST IRON GRAUGUSS FONTE GRISE	MAT NON FERROSI NON FERROUS MAT. NICHTEISENMATERIALIEN MAT. FERREUX	MAT DIFFICILI DIFFICULT MATERIAL SCHWERIGE MATERIALIEN MAT. DIFICILES	MATERIALI DURI HARD MATERIALS HARTE MATERIALIEN MATERIAUX DURS			
T1625	HC P10-40 M05-25 K10-40 CVD	●	○	○				 Tenacità + Toughness -		- QUALITÀ PER UNA VASTA GAMMA DI MATERIALI - ADATTO PER LE LAVORAZIONI DI SGROSSATURA E FINITURA
F2425	HC P30-40 M15-35 PVD	○	●							- SUBSTRATO DI CARBURO APPOSITAMENTE SVILUPPATO, RIVESTIMENTO IN PVD INNOVATIVO. - QUALITÀ CON UN'ECCELLENTI ROBUSTEZZA SENZA PREGIUDICARE LA DUREZZA A CALDO E LA RESISTENZA ALL'USURA SIA A BASSE CHE AD ALTE VELOCITÀ DI TAGLIO
T7725 NEW	HC P15-35 M10-30 K15-35 CVD	●	○	○						- QUALITÀ UNIVERSALE - ALTA RESISTENZA ALL'USURA E TAGLIANTE TENACE PER TORNITURA DI ACCIAI, INDICATA ANCHE PER GLI ACCIAI INOSSIDABILI E GHISE. - AFFIDABILE PER LAVORAZIONE CON VELOCITÀ DI TAGLIO LIMITATE
T1126	HC P15-35 M10-25 K25-35 CVD	●	●	●						- SUBSTRATO MIGLIORATO CON BUONA RESISTENZA ALL'USURA E ALL'ABRASIONE - ADATTO PERE LAVORAZIONI SENZA L'AUSILIO DEL LUBROREFRIGERANTE.
F2326 NEW	HC P15-30 M15-30 PVD	○	●							- QUALITÀ MICR OGRANO CON ALTA RESISTENZA ALL' USURA E BUONA TENACITÀ - OTTIMA APPLICAZIONE PER LAVORI DI FINITURA SU ISO M-S
F2435	HC P35-45 M25-45 PVD	○	●							- SUBSTRATO DI CARBURO APPOSITAMENTE SVILUPPATO - RIVESTIMENTO IN PVD INNOVATIVO, FORNISCE UN'ECCELLENTI ROBUSTEZZA E OTTIMA TENACITÀ SENZA PREGIUDICARE LA DUREZZA A CALDO SIA A BASSE CHE AD ALTE VELOCITÀ DI TAGLIO
F8410	HC M05-20 PVD S05-20		○			●				- ECCELLENTE RESISTENZA AL CALORE E ALL'USURA - IDEALE PER LAVORAZIONI DELLE SUPERLEGHE
T3111	HC P01-20 CVD K05-20	○		●						- GRADO DI TORNITURA SPECIFICO PER LA LAVORAZIONE DELLA GHISA - OTTIMA RESISTENZA ALL'USURA
T1415	HC P05-25 CVD K10-35	●		○						- GRADO INSERTO IDEALE PER LA PRODUZIONE AD ALTO VOLUME - BUONA RESISTENZA AL CALORE CHE LO RENDE PERFETTAMENTE ADATTO PER LA LAVORAZIONE A SECCO ANCHE AD ALTE VELOCITÀ DI TAGLIO
T1425	HC P15-35 M10-25 K25-35 CVD	●	○	○						- VASTA GAMMA DI IMPIEGHI, IDEAELE PER TUTTE LE LEGHE DI ACCIAIO E GHISA, BUONE PRESTAZIONI ANCHE SU INOX

● APPLICAZIONE CONSIGLIATA
RECOMMENDED APPLICATION
EMPFOHLENER EINSATZ
APPLICATION CONSEILLÉE

○ APPLICAZIONE POSSIBILE
POSSIBLE APPLICATION
MÖGLICHE ANWENDUNG
APPLICATION POSSIBLE

● APPLICAZIONE CONSIGLIATA
RECOMMENDED APPLICATION
EMPFOHLENER EINSATZ
APPLICATION CONSEILLÉE

○ APPLICAZIONE POSSIBILE
POSSIBLE APPLICATION
MÖGLICHE ANWENDUNG
APPLICATION POSSIBLE

 INDICATIONS - USE	 GEBRAUCHSANWEISUNGEN	 INDICATION - USAGE
<ul style="list-style-type: none"> - GRADE FOR A WIDE RANGE OF MATERIALS - SUITABLE FOR ROUGHING AND FINISHING 	<ul style="list-style-type: none"> - SORTE FÜR EINE VIELZAHL VON MATERIALIEN - FÜR SCRUPPEN UND SCHLICHTEN GEEIGNET 	<ul style="list-style-type: none"> - QUALITE POUR UNE VASTE GAMME DE MATERIAUX - PREVU POUR LES USINAGES DE DEGROSSISSAGE ET DE FINITION
<ul style="list-style-type: none"> - SPECIALLY DEVELOPED CARBIDE SUBSTRATE, INNOVATIVE PVD COATING - GRADE WITH EXCELLENT TOUGHNESS WHICH DOES NOT AFFECT RED HARDNESS AND WEAR RESISTANCE, AT BOTH LOW AND HIGH CUTTING SPEEDS 	<ul style="list-style-type: none"> - SPEZIELL ENTWICKELTES KARBIDSUBSTRAT, INNOVATIVE PVD-BESCHICHTUNG. - SORTE MIT HERVORRAGENDER ROBUSTHEIT BEI UNVERÄNDERTER WARMHÄRTE UND VERSCHLEISSBESTÄNDIGKEIT SOWOHL MIT NIEDRIGEN ALS AUCH MIT HOHEN SCHNITTGESCHWINDIGKEITEN 	<ul style="list-style-type: none"> - SUBSTRAT DE CARBURE SPÉCIALEMENT DÉVELOPPÉ, REVÊTEMENT EN PVD INNOVANT. - QUALITÉ AVEC UNE ROBUSTESSE EXCELLENTE SANS PORTER PRÉJUDICE À LA DURETÉ À CHAUD ET À LA RÉSISTANCE À L'USURE À BASSES VITESSES COMME À HAUTES VITESSES DE COUPE
<ul style="list-style-type: none"> - UNIVERSAL GRADE - HIGH RESISTANCE TO WEAR AND TOUGH CUTTING EDGE FOR STEEL TURNING, ALSO SUITABLE FOR STAINLESS STEEL AND CAST IRON. - RELIABLE FOR MACHINING AT LIMITED CUTTING SPEED 	<ul style="list-style-type: none"> - UNIVERSALSORTE - HOHE VERSCHLEISSFESTIGKEIT UND ZÄHE SCHNEIDKANTE ZUM STAHL DREHEN, AUCH FÜR INOX UND GUSSEISEN GEEIGNET. - ZUVERLÄSSIG FÜR BEARBEITUNGEN MIT BEGRENZTER SCHNITTGESCHWINDIGKEIT 	<ul style="list-style-type: none"> - QUALITÉ UNIVERSELLE - HAUTE RÉSISTANCE À L'USURE ET ARÊTE DE COUPE RÉSISTANTE POUR TOURNAGE DES ACIERS, CONVIENT AUSSI AUX ACIERS INOXYDABLES ET FONTES. - FIABLE EN CAS D'USINAGE AVEC VITESSES DE DÉCOUPE LIMITÉES
<ul style="list-style-type: none"> - IMPROVED SUBSTRATE WITH GOOD RESISTANCE TO WEAR AND ABRASION - SUITABLE FOR MACHINING WITHOUT COOLING LUBRICANT 	<ul style="list-style-type: none"> - VERBESSERTES SUBSTRAT MIT GUTER VERSCHLEISSBESTÄNDIGKEIT UND ABRIEBFESTIGKEIT - ZUR BEARBEITUNG OHNE KÜHLSCHMIERSTOFF GEEIGNET 	<ul style="list-style-type: none"> - SUBSTRAT AMÉLIORÉ AVEC BONNE RÉSISTANCE À L'USURE ET À L'ABRASION - SPÉCIALEMENT PRÉVU POUR LES USINAGES SANS LUBRIFIANT-RÉFRIGÉRANT.
<ul style="list-style-type: none"> - MICROGRAIN GRADE WITH HIGH RESISTANCE TO WEAR AND GOOD TOUGHNESS - EXCELLENT FOR FINISHING APPLICATIONS ON ISO M-S MATERIALS 	<ul style="list-style-type: none"> - MIKROKORN-SORTE MIT HOHER VERSCHLEISSFESTIGKEIT UND GUTER ZÄHIGKEIT - HERVORRAGEND ZUM SCHLICHTEN AUF ISO-M-S-MATERIALIEN 	<ul style="list-style-type: none"> - QUALITÉ MICROGRAIN AVEC HAUTE RÉSISTANCE À L'USURE ET BONNE DURETÉ - APPLICATION PARFAITE POUR TRAVAUX DE FINITION SUR ISO M-S
<ul style="list-style-type: none"> - SPECIALLY DEVELOPED CARBIDE SUBSTRATE - INNOVATIVE PVD COATING PROVIDING EXCELLENT STRENGTH AND VERY GOOD TOUGHNESS WITHOUT AFFECTING RED HARDNESS AT BOTH LOW AND HIGH CUTTING SPEED 	<ul style="list-style-type: none"> - SPEZIELL ENTWICKELTES KARBID-SUBSTRAT - INNOVATIVE PVD-BESCHICHTUNG FÜR EXCELLENTE ROBUSTHEIT UND OPTIMALE ZÄHIGKEIT OHNE BEEINTRÄCHTIGUNG DER WARMHÄRTE BEI SOWOHL HOHEN ALS AUCH NIEDRIGEN SCHNITTGESCHWINDIGKEITEN 	<ul style="list-style-type: none"> - SUBSTRAT DE CARBURE SPÉCIALEMENT DÉVELOPPÉ - REVÊTEMENT EN PVD INNOVANT, FOURNIT UNE ROBUSTESSE ET TENACITÉ EXCELLENTE, SANS POUR AUTANT PORTER PRÉJUDICE À LA DURETÉ À CHAUD A DE BASSES COMME A DE HAUTES VITESSES DE COUPE.
<ul style="list-style-type: none"> - EXCELLENT HEAT AND WEAR RESISTANCE - IDEAL FOR SUPER-ALLOYS 	<ul style="list-style-type: none"> - EXCELLENTE HITZE- UND VERSCHLEISSBESTÄNDIGKEIT - IDEAL FÜR SUPER-LEGIERUNGEN 	<ul style="list-style-type: none"> - RESISTANCE EXCELLENTE A LA CHALEUR ET A L'USURE - IDEAL POUR LES USINAGES DES SUPER-ALLIAGES
<ul style="list-style-type: none"> - TURNING GRADE SPECIALLY DESIGNED FOR CAST IRON - EXCELLENT RESISTANCE TO WEAR 	<ul style="list-style-type: none"> - DREHSORTE, SPEZIELL FÜR GUSS ENTWICKELT - HERVORRAGENDE VERSCHLEISSBESTÄNDIGKEIT 	<ul style="list-style-type: none"> - DEGRÉ DE TOURNAGE SPÉCIFIQUE POUR L'USINAGE DE LA FONTE - RÉSISTANCE À L'USURE EXCELLENTE
<ul style="list-style-type: none"> - IDEAL GRADE FOR HIGH VOLUME MACHINING - GOOD HEAT RESISTANCE AND THEREFORE PERFECTLY SUITABLE FOR DRY MACHINING, EVEN AT HIGH CUTTING SPEEDS 	<ul style="list-style-type: none"> - IDEALE SORTE FÜR HOCHVOLUMENFERTIGUNG - GUTE HITZEBESTÄNDIGKEIT UND DAHER PERFEKT FÜR DIE TROCKENBEARBEITUNG, AUCH MIT HOHEN SCHNITTGESCHWINDIGKEITEN 	<ul style="list-style-type: none"> - DEGRÉ PLAQUETTE IDÉAL POUR LA PRODUCTION À HAUT VOLUME - BONNE RÉSISTANCE À LA CHALEUR, QUI LE REND PARFAITEMENT INDICQUÉ POUR L'USINAGE À SEC MEME A DE HAUTES VITESSES DE COUPE
<ul style="list-style-type: none"> - WIDE RANGE OF APPLICATIONS, IDEAL FOR ALL STEEL AND CAST IRON ALLOYS, GOOD PERFORMANCE ALSO ON INOX 	<ul style="list-style-type: none"> - HOHE VIELSEITIGKEIT, IDEAL FÜR ALLE STAHL- UND GUSSEISENLEGIERUNGEN, GUTE LEISTUNG AUCH MIT INOXSTAHL 	<ul style="list-style-type: none"> - VASTE GAMME D'EMPLOIS, IDÉAL POUR TOUS LES ALLIAGES EN ACIER ET FONTE, BONNES PERFORMANCES MÊME SUR INOX

HT CERMET

HW





















METALLO DURO NON RICOPERTO
UNCOATED CARBIDE
UNBESCHICHTETES HARTMETALL
MÉTAL DUR PAS RECOUVERT

HC

METALLO DURO RICOPERTO
COATED CARBIDE
BESCHICHTETES HARTMETALL
MÉTAL DUR RECOUVERT

DP

DIAMANTE POLICRISTALLINO (PCD)
POLYCRYSTALLINE DIAMOND (PCD)
POLYKRISTALLINER DIAMANT (PCD)
DIAMANT POLYCRISTALLIN (PCD)



SAU	DIN ISO 513	MATERIALE - MATERIAL MATERIALEN - MATÉRIAUX PAG. 1199						QUICK PICK PAG. 210	 INDICAZIONI - USO		
		P	M	K	N	S	H				
		ACCIAI STEELS STAHL ACIER	ACCIAI INOX STAINLESS STEELS ROSTFREIER STAHL ACIER INOXYDABLE	GHISA CAST IRON GRAUGUSS	MAT. NON FERROSI NON FERROUS MAT. NICHT-EISENMATERIALIEN MAT. FERREUX	MAT. DIFFICILI DIFFICULT MATERIAL SCHWERIGE MATERIALIEN MAT. DIFCILES	MATERIALI DURI HARD MATERIALS HARTE MATERIALIEN MATERIAUX DURS				
T3210	HC	P01-10	○		●				 Tenacità + Toughness -		- GRADO DA TORNITURA PER LA LAVORAZIONE DELLA GHISA GRIGIA E SFEROIDALE CON ELEVATA RESISTENZA ALL'USURA AD ELEVATE VELOCITÀ DI TAGLIO CON TAGLIO CONTINUO
	CVD	K5-15									
T3112 NEW	HC	K05-20			●						- ALTA RESISTENZA ALL'USURA, ADATTO PER LAVORAZIONI DI SPIANATURA IN CONDIZIONI STABILI
	CVD										
T3220	HC	P01-20	○		●						- GRADO DA TORNITURA PER LA LAVORAZIONE DELLA GHISA GRIGIA E SFEROIDALE
	CVD	K10-30									
T3121 NEW	HC	K10-25			●						- GRADO SPECIFICO PER LAVORAZIONE DI GHISA. PER LAVORAZIONI IN GENERE ANCHE PER TAGLIO INTERROTTO, IDEALE PER GHISE GRIGIE E SFEROIDALI
	CVD										
F7230 NEW	HC	P30	●	●	●	●	●	●			- INSERTO AD ALTA TENACITA' PER LAVORAZIONI CON MEDIO-BASSE VELOCITA' DI TAGLIO - INDICATO PER LAVORAZIONI DI STOZZATURA ANCHE IN CONDIZIONI NON OTTIMALI
	PVD	M30 K30									
T531	HC	P15-30	○	●							- QUALITA' MICROGRANO TENACE CON BUONA RESISTENZA AGLI URTI ED AGLI SHOCK TERMICI - INDICATO PER MEDIE E MEDIO-BASSE VELOCITA' DI TAGLIO
	CVD	M20-40									
F8120	HC	M15-35 S10-30		○				●			- QUALITA' RESISTENTE ALL'USURA, IDEALE PER LAVORAZIONI A TAGLIO INTERROTTO - INDICATO PER MATERIALI RESISTENTI AL CALORE E INOX
	PVD										
T1435	HC	P25-45	●	○							- GRADO INSERTO TENACE PER LAVORAZIONI DIFFICILI CON CONDIZIONI INSTABILI E A TAGLIO INTERROTTO
	CVD	M20-30									
T1215 NEW	HC	P10-25	●		○						- QUALITÀ PER MASSIMA VELOCITÀ DI TAGLIO CON TORNITURA DA LEGGERA A MEDIA, GRAZIE ALLO SPECIALE RIVESTIMENTO QUESTO TIPO E' ESTREMAMENTE RESISTENTE ALL'USURA
	CVD	K10-25									
F8315	HC	M05-25 S05-25		○				●			- QUALITÀ MICROGRANO IN PVD - ADATTO PER LA LAVORAZIONE DELLE SUPERLEGHE
	PVD										

● APPLICAZIONE CONSIGLIATA
RECOMMENDED APPLICATION
EMPFOHLENER EINSATZ
APPLICATION CONSEILLÉE

○ APPLICAZIONE POSSIBILE
POSSIBLE APPLICATION
MÖGLICHE ANWENDUNG
APPLICATION POSSIBLE

● APPLICAZIONE CONSIGLIATA
RECOMMENDED APPLICATION
EMPFOHLENER EINSATZ
APPLICATION CONSEILLÉE

○ APPLICAZIONE POSSIBILE
POSSIBLE APPLICATION
MÖGLICHE ANWENDUNG
APPLICATION POSSIBLE

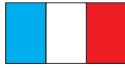
 INDICATIONS - USE	 GEBRAUCHSANWEISUNGEN	 INDICATION - USAGE
- TURNING GRADE FOR THE MACHINING OF GREY AND NODULAR CAST IRON WITH HIGH WEAR RESISTANCE AT HIGH CUTTING SPEEDS WITH CONTINUOUS CUT	- DREHSORTE ZUR BEARBEITUNG VON GRAU- UND GRAPHITGUSS MIT HOHEM VERSCHLEISSWIDERSTAND BEI HOHEN SCHNITTGESCHWINDIGKEITEN MIT KONTINUIERLICHEM SCHNITT	- DEGRE DE TOURNAGE POUR LE TRAITEMENT DE LA FONTE GRISE ET SPHEROIDALE AVEC UNE RESISTANCE ELEVEE A L'USURE A DE HAUTES VITESSES DE COUPE AVEC COUPE CONTINUE
- HIGH RESISTANCE TO WEAR, SUITABLE FOR FACING UNDER STABLE CONDITIONS	- HOHE VERSCHLEISSFESTIGKEIT, ZUR PLANBEARBEITUNG UNTER STABILEN BEDINGUNGEN GEEIGNET	- HAUTE RESISTANCE A L'USURE, INDIQUE POUR LES OPERATIONS DE SURFAÇAGE DANS DES CONDITIONS STABLES.
- TURNING GRADE FOR GREY CAST IRON AND NODULAR CAST IRON	- DREHSORTE FÜR DIE BEARBEITUNG VON GUSS UND SPHÄROGUSS	- DEGRE DE TOURNAGE POUR L'USINAGE DE LA FONTE GRISE ET SPHEROIDALE
- CAST IRON-SPECIFIC INSERT GRADE FOR GENERAL PURPOSE, ALSO FOR INTERRUPTED CUTTING. BEST SUITED FOR GREY AND NODULAR CAST IRON	- SPEZIFISCHE SORTE FÜR GUSSEISEN ALLGEMEIN EINSETZBAR, AUCH FÜR UNTERBROCHENEN SCHNITT, IDEAL FÜR GRAU- UND SPHÄROGUSS	- DEGRÉ SPÉCIFIQUE POUR L'USINAGE DE LA FONTE. POUR LES EXECUTIONS EN GÉNÉRAL MÊME EN CAS DE DÉCOUPAGE INTERROMPU, PARFAIT POUR LES FONTES GRISSES ET SPHÉROÏDALES
- VERY TOUGH INSERTS FOR MEDIUM TO LOW CUTTING SPEEDS - SUITABLE FOR SLOTTING, ALSO UNDER NON-OPTIMAL CONDITIONS	- SEHR ZÄHE WENDEPLATTE FÜR MITTLEREN BIS NIEDRIGEN SCHNITTGESCHWINDIGKEITEN - GEEIGNET FÜR STOSSBEARBEITUNGEN, AUCH UNTER NICHT OPTIMALEN BEDINGUNGEN	- PLAQUETTE À HAUTE RESISTANCE POUR DES USINAGES À VITESSE DE DÉCOUPE FAIBLE À MOYENNE - INDIQUÉ POUR DES USINAGES DE MORTAISAGE MÊME DANS DES CONDITIONS NON OPTIMALES
- TOUGH MICROGRAIN GRADE WITH HIGH RESISTANCE TO SHOCK AND THERMAL SHOCK. - SUITABLE FOR MEDIUM AND MEDIUM-LOW CUTTING SPEEDS	- MIKROKORNSORTE MIT HOHER STOSSFESTIGKEIT UND TEMPERATURWECHSELBESTÄNDIGKEIT - FÜR MITTLERE UND MITTEL-NIEDRIGE SCHNITTGESCHWINDIGKEITEN GEEIGNET	- QUALITÉ DE MICROGRAIN TENACE AVEC BONNE RESISTANCE AU COUPS ET AU SHOCKS THERMIQUES. - INDIQUÉE POUR MOYENNE ET MOYENNE-FAIBLE VITESSE DE COUPE
- WEAR-RESISTANT GRADE, IDEAL FOR INTERRUPTED CUTTING - SUITABLE FOR HEAT-RESISTANT MATERIALS AND STAINLESS STEEL	- VERSCHLEISSFESTE SORTE, IDEAL FÜR UNTERBROCHENEN SCHNITT - FÜR HITZEBESTÄNDIGE MATERIALIEN UND INOX-STAHL GEEIGNET	- QUALITÉ RESISTANTE À L'USURE, IDEAL POUR USINAGE À COUPE INTERROMPU - INDIQUÉE POUR MATERIAUX RESISTANTES À LA CHALEUR ET INOX
- TOUGH DEGREE FOR DIFFICULT MACHINING UNDER UNSTABLE CONDITIONS AND WITH INTERRUPTED CUT	- ZÄHE SORTE FÜR SCHWERE BEARBEITUNGEN UNTER UNSTABILEN BEDINGUNGEN UND MIT UNTERBROCHENEM SCHNITT	- DEGRÉ PLAQUETTE TENACE POUR USINAGES DIFFICILES DANS DES CONDITIONS INSTABLES ET À COUPE INTERROMPUE
- GRADE FOR MAXIMUM CUTTING SPEED IN LIGHT TO MEDIUM TURNING OPERATIONS. THANKS TO ITS SPECIAL COATING, IT IS EXTREMELY RESISTANT TO WEAR	- SORTE FÜR MAXIMALE SCHNITTGESCHWINDIGKEIT BEI LEICHTEN BIS MITTLEREN DREHANWENDUNGEN. ÄUSSERST VERSCHLEISSFEST DANK SEINER SPEZIELLEN BESCHICHTUNG.	- QUALITÉ POUR UNE VITESSE DE DÉCOUPE MAXIMUM AVEC TOURNAGE DE LÉGER À MOYEN, GRÂCE AU REVÊTEMENT SPÉCIAL CE TYPE EST EXTRÊMEMENT RÉSISTANT À L'USURE.
- MICROGRAIN GRADE, PVD-COATED - SUITABLE FOR SUPER-ALLOYS	- MIKROKORNSORTE, PVD-BESCHICHTET - ZUR BEARBEITUNG VON SUPER-LEGIERUNGEN GEEIGNET	- QUALITE MICROGRAIN EN PVD - PREVUE POUR L'USINAGE DES SUPER-ALLIAGES

HT CERMET

HW

METALLO DURO NON RICOPERTO
UNCOATED CARBIDE
UNBESCHICHTETES HARTMETALL
MÉTAL DUR PAS RECOUVERT

HC

METALLO DURO RICOPERTO
COATED CARBIDE
BESCHICHTETES HARTMETALL
MÉTAL DUR RECOUVERT

DP

DIAMANTE POLICRISTALLINO (PCD)
POLYCRYSTALLINE DIAMOND (PCD)
POLYKRISTALLINER DIAMANT (PCD)
DIAMANT POLYCRISTALLIN (PCD)



SAU	DIN ISO 513	MATERIALE - MATERIAL MATERIALEN - MATÉRIAUX						QUICK PICK PAG. 210	 INDICAZIONI - USO	
		P	M	K	N	S	H			
		ACCIAI STEELS STAHL ACIER	ACCIAI INOX STAINLESS STEELS ROSTFREIER STAHL ACIER INOXYDABLE	GHISA CAST IRON GRAUGUSS	MAT. NON FERROSI NON FERROUS MAT. NICHTEISENMATERIALIEN	MAT. FERREUX	MAT. DIFFICILI DIFFICULT MATERIAL SCHWERIGE MATERIALIEN			MATERIALI DURI HARTE MATERIALIEN MATÉRIAUX DURS
T2120	HC	P30-40	○	●				 Tenacità + Toughness -		<ul style="list-style-type: none"> - SUBSTRATO DI CARBURO APPPOSITAMENTE SVILUPPATO E RIVESTITO IN CVD INNOVATIVO - QUALITÀ CON UN'ECCELLENTI ROBUSTEZZA SENZA PREGIUDICARE LA DUREZZA A CALDO E LA RESISTENZA ALL'USURA.
	CVD	M15-35								
T1225 NEW	HC	P15-35	●	○						<ul style="list-style-type: none"> - QUESTA VARIETÀ MULTI-GAMMA È CARATTERIZZATA DA ELEVATA RESISTENZA ALL'USURA ED ECCELLENTI PROPRIETÀ DI TENACITÀ A UNA VASTA GAMMA DI APPLICAZIONI.
	CVD	M15-35								
T2335	HC	M25-45		●						<ul style="list-style-type: none"> - BUONA TENACITÀ E RESISTENZA ALL'USURA. - QUALITÀ, IDEALE PER LA TORNITURA DI ACCIAI AUSTENITICI INOSSIDABILI.
	CVD									
T540	HC	P25-45	●	●		○	○			<ul style="list-style-type: none"> - ALTA TENACITÀ, BUONA RESISTENZA ALL'USURA E ALLO SHOCK TERMICO - INDICATO PER BASSE VELOCITÀ DI TAGLIO E ALTI AVANZAMENTI IN SGROSSATURA PESANTE ANCHE IN CONDIZIONI PRECARIE.
	CVD	M25-40								
D3010	DP	N01-10				●				<ul style="list-style-type: none"> - GRADO INDICATO PER LA TORNITURA DI MATERIALI NON FERROSI, ES. LEGHE DI ALLUMINIO, MEGLIO SE AD ALTO TENORE DI SILICIO, RAME, BRONZO TERMOPLASTICI RINFORZATI E COMPOSITI. - OTTIMA FINITURA E VITA UTENSILE.

● APPLICAZIONE CONSIGLIATA
RECOMMENDED APPLICATION
EMPFOHLENER EINSATZ
APPLICATION CONSEILLÉE

○ APPLICAZIONE POSSIBILE
POSSIBLE APPLICATION
MÖGLICHE ANWENDUNG
APPLICATION POSSIBLE

● APPLICAZIONE CONSIGLIATA
RECOMMENDED APPLICATION
EMPFOHLENER EINSATZ
APPLICATION CONSEILLÉE

○ APPLICAZIONE POSSIBILE
POSSIBLE APPLICATION
MÖGLICHE ANWENDUNG
APPLICATION POSSIBLE

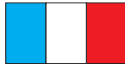
 INDICATIONS - USE	 GEBRAUCHSANWEISUNGEN	 INDICATION - USAGE
<ul style="list-style-type: none"> - SPECIALLY DEVELOPED CARBIDE SUBSTRATE, INNOVATIVE CVD COATING - GRADE WITH EXCELLENT TOUGHNESS WHICH DOES NOT AFFECT RED HARDNESS AND WEAR RESISTANCE 	<ul style="list-style-type: none"> - SPEZIELL ENTWICKELTES KARBIDSUBSTRAT, INNOVATIVE CVD-BESCHICHTUNG. - SORTE MIT HERVORRAGENDER ROBUSTHEIT BEI UNVERÄNDERTER WÄRMHÄRTE UND VERSCHLEISSBESTÄNDIGKEIT 	<ul style="list-style-type: none"> - SUBSTRAT DE CARBURE SPÉCIALEMENT DÉVELOPPÉ, REVÊTEMENT EN CVD INNOVANT. - QUALITÉ AVEC UNE ROBUSTESSE EXCELLENTE SANS PORTER PRÉJUDICE À LA DURETÉ À CHAUD ET À LA RÉSISTANCE À L'USURE
<ul style="list-style-type: none"> - THIS MULTI-RANGE GRADE FEATURES HIGH RESISTANCE TO WEAR AND OUTSTANDING TOUGHNESS FOR A BROAD SPECTRUM OF APPLICATIONS 	<ul style="list-style-type: none"> - DIESE MEHRBEREICHSSORTE ZEICHNET SICH DURCH HOHE VERSCHLEISSFESTIGKEIT UND HERVORRAGENDE ZÄHIGKEITSEIGENSCHAFTEN FÜR EINE VIELZAHL VON ANWENDUNGEN AUS 	<ul style="list-style-type: none"> - CETTE VARIÉTÉ MULTI-GAMME SE CARACTÉRISE PAR UNE RÉSISTANCE ÉLEVÉE À L'USURE ET DES PROPRIÉTÉS DE DURETÉ EXCELLENTE S'ÉTENDANT À UNE VASTE GAMME D'APPLICATIONS.
<ul style="list-style-type: none"> -GOOD TOUGHNESS AND WEAR RESISTANCE -IDEAL GRADE FOR AUSTENITIC STAINLESS STEEL. 	<ul style="list-style-type: none"> -GUTE ZÄHIGLEIT UND VERSCHLEISSFESTIGKEIT -IDEALE SORTE ZUM DREHEN VON AUSTENITISCHEM ROSTFREIEM STAHL 	<ul style="list-style-type: none"> -BONNE TENACITÉ ET RESISTANCE À L'USURE -QUALITÉ IDEALE POUR LE TOURNAGE DES ACIERS AUSTENITICI INOXIDABLES
<ul style="list-style-type: none"> -HIGH TOUGHNESS, RESISTANCE TO WEAR AND TO THERMAL SHOCK -SUITABLE FOR LOW CUTTING SPEEDS AND HIGH FEED FOR ROUGHING AND HEAVY ROUGHING, EVEN UNDER UNSTABLE CONDITIONS 	<ul style="list-style-type: none"> -FÜR MITTEL-HOHE SCHNITTGESCHWINDIGKEITEN UND BEI MITTLEREN VORSCHÜBEN UNTER NORMALEN BEDINGUNGEN GEEIGNET -FÜR NIEDRIGE SCHNITTGESCHWINDIGKEITEN UND GROSSVORSCHÜBE BEIM SCHRUPPEN UND STARKEN SCHRUPPEN, AUCH UNTER UNSTABILEN BEDINGUNGEN, GEEIGNET. 	<ul style="list-style-type: none"> -HAUTE TENACITÉ, RÉSISTANCE À L'USURE ET AU SHOCK THERMIQUE -INDIQUÉE POUR FAIBLE VITESSE DE COUPE ET HAUT DÉPLACEMENT POUR ÉBAUCHAGE ET ÉBAUCHAGE LOURD, MÊME AVEC CONDITIONS INSTABLES.
<ul style="list-style-type: none"> - TURNING GRADE FOR NON-FERROUS MATERIALS, SUCH AS ALUMINUM ALLOYS, PREFERABLY WITH HIGH SILICON, COPPER, BRONZE CONTENT, REINFORCED THERMOPLASTIC MATERIALS AND COMPOUNDS - EXCELLENT FINISHING AND TOOL LIFE 	<ul style="list-style-type: none"> - SORTE ZUM DREHEN FÜR NICHT-EISENMATERIALIEN, Z.B. ALUMINIUM-LEGIERUNGEN, VORZUGSWEISE MIT HOHEM SILIZIUM-, KUPFER- UND BRONZEHALT, VERSTÄRKTE THERMOPLASTE UND VERBUNDMATERIALIEN. - HERVORRAGENDE OBERFLÄCHENGÜTE UND WERKZEUGSTANDZEIT 	<ul style="list-style-type: none"> - DEGRÉ INDIQUÉ POUR LE TOURNAGE DE MATÉRIAUX NON FERREUX, TELS QUE ALLIAGES D'ALUMINIUM, AUTANT QUE POSSIBLE À TENEUR ÉLEVÉE DE SILICIUM, CUIVRE, BRONZE, THERMOPLASTIQUES RENFORCÉS ET COMPOSÉS. - FINITION ET VIE DE L'OUTIL EXCELLENTE.

HT CERMET

HW

METALLO DURO NON RICOPERTO
UNCOATED CARBIDE
UNBESCHICHTETES HARTMETALL
MÉTAL DUR PAS RECOUVERT

HC

METALLO DURO RICOPERTO
COATED CARBIDE
BESCHICHTETES HARTMETALL
MÉTAL DUR RECOUVERT

DP

DIAMANTE POLICRISTALLINO (PCD)
POLYCRYSTALLINE DIAMOND (PCD)
POLYKRISTALLINER DIAMANT (PCD)
DIAMANT POLYCRISTALLIN (PCD)

MATERIALE MATERIAL MATERIALIEN MATERIAUX PAG 1199	VDI 3323 GR.	HB HRC Rm	C4010	DT61T	DT63	T110	T115	T120	T3310 NEW	F2115 NEW	F8116 NEW	F2120	T1625
P ACCIAI STEELS STAHL ACIER	1	125	230-270	320-600	310-400								450-680
	2	180	230-270	300-560	260-350								450-680
	3	250	230-270	270-430	220-300								450-680
	4	220	230-270	300-450	220-330								300-500
	5	300	230-270	220-340	180-280								300-500
	6	180	230-270	250-420	250-350								200-450
	7-8	250-300	180-230	160-300	200-300								200-450
	9	350	180-230	130-200	150-220								200-450
	10	200	160-200	150-310	200-350								200-400
	11	350	160-200	130-200	150-220								200-400
	12	200	230-270	260-320	180-300			80-150					200-400
	13	330	170-240	160-240	150-250			40-70					200-400
	M ACCIAI INOX STAINLESS STEELS ROSTFREIER STAHL ACIER INOXYDABLE	14.1	180	170-240	180-280	180-280			50-100			60-140	120-200
14.2		230-260	130-160	130-230	100-150			50-90			60-140	60-160	160-260
K GHISA CAST IRON GRAUGUSS FONTE GRISE	15	180	200-300	220-260	200-300	120-160	120-160	100-150				120-160	110-180
	16	260	200-300	130-170	150-260	90-140	120-160	70-120				120-160	110-180
	17	160	220-300	200-240	180-300	130-170	130-170	100-140				120-160	110-180
	18	250	220-300	150-200	150-240	90-130	130-170	80-120				120-160	110-180
	19	130	250-350	230-300	170-280	140-200	140-200	120-180				140-220	110-180
	20	230	250-350	130-170	150-220	120-160	140-200	70-120				120-160	110-180
N MAT NON FERROSI NON FERROUS MAT NICHT-EISENMATERIALIEN MAT. FERREUX	21	60		500-900		300-950	100-950	300-800	450-950	100-950		100-400	
	22	100		500-900		300-950	100-950	300-800	450-950	100-950		100-400	
	23	75		500-900		400-950	100-950	300-800	450-950	100-950		100-400	
	24	90		500-900		400-950	100-950	300-800	450-950	100-950		100-400	
	25	130		500-900		200-800	100-800	300-800	450-950	100-950		100-400	
	26	110		500-900		250-600	100-800	400-550	250-950	100-500		100-400	
	27	90				200-600	100-300	400-550	250-950	100-500		100-400	
	28	100				150-400	100-300	200-400	250-950	100-500		100-400	
	29					80-180	100-950		250-950	100-300		100-600	
	30					100-250	100-950		250-950	100-300		100-600	
S MAT DIFFICILI DIFFICULT MATERIAL SCHWIERIGE MATERIALIEN MAT. DIFFICILES	31	200					30-45			30-45	30-70	20-50	
	32	280					20-35			20-35	30-70	20-50	
	33	250					20-35			20-35	30-70	15-40	
	34	350					18-30			20-35	30-70	20-35	
	35	320					18-30			15-30	30-70	20-35	
	36	Rm400				60-120	60-120			40-60	40-90	80-140	
	37	Rm1050				30-60	60-120			30-50	40-90	80-140	
H MATERIALI DURI HARD MATERIALS HARTE MATERIALIEN MATERIAUX DURS	38	55HRC											
	39	60HRC											
	40	400											
	41	55HRC											

MATERIALE MATERIAL MATERIALIEN MATÉRIAUX PAG 1199	VDI 3323 GR.	HB HRC Rm	F2425	T7725 NEW	T1126	F2326 NEW	F2435	F8410	T3111	T1415	T1425	T3210	T3112 NEW
P ACCIAI STEELS STAHL ACIER	1	125	130-250	170-450	170-240	130-200	170-190		250-550	220-400	170-240	250-550	
	2	180	130-250	170-450	170-240	130-200	170-190		250-550	220-400	170-240	250-550	
	3	250	130-250	170-450	170-240	130-200	170-190		250-550	220-400	170-240	250-550	
	4	220	130-250	170-450	170-240	130-200	170-190		250-550	220-400	170-240	250-550	
	5	300	130-250	130-330	170-240	130-200	170-190		250-550	220-400	170-240	250-550	
	6	180	130-250	130-330	170-240		90-150		250-400	220-400	170-240	250-400	
	7-8	250-300	60-180	130-330	100-190		90-150		220-340	200-320	100-190	220-340	
	9	350	60-180	130-330	130-210		90-150		170-300	200-320	130-210	170-300	
	10	200	80-200	130-230	130-210		120-200		200-350	180-320	130-210	200-350	
	11	350	80-200	130-230	130-220		120-200		150-300	180-320	130-220	150-300	
	12	200	120-250	130-270	130-220		140-180		180-320	200-320	130-220	180-320	
	13	330	120-250	130-270	130-220		140-180		180-320	200-320	130-220	180-320	
	M ACCIAI INOX STAINLESS STEELS ROSTFREIER STAHL ACIER INOXYDABLE	14.1	180	100-250	160-260	100-210	130-200	110-200	140-230			100-210	
14.2		230-260	40-160	130-210	70-100	100-180	55-150	60-100			70-100		
K GHISA CAST IRON GRAUGUSS FONTE GRISE	15	180		110-210	130-210				250-550	140-370	130-210	250-550	210-500
	16	260		110-210	130-210				220-400	140-370	130-210	220-400	140-270
	17	160		80-180	120-240				220-420	190-430	120-240	220-420	150-300
	18	250		80-180	120-240				200-350	190-430	120-240	200-350	110-200
	19	130		90-210	150-250				220-400	180-520	150-250	220-400	200-330
	20	230		90-210	150-250				180-350	180-520	150-250	180-350	100-240
N MAT NON FERROSI NON FERROUS MAT. NICHT-EISENMATERIALIEN MAT. FERREUX	21	60											
	22	100											
	23	75											
	24	90											
	25	130											
	26	110											
	27	90											
	28	100											
	29												
	30												
S MAT DIFFICILI DIFFICULT MATERIAL SCHWIERIGE MATERIALIEN MAT. DIFICILES	31	200						80-120					
	32	280						60-100					
	33	250						35-90					
	34	350						30-50					
	35	320						30-50					
	36	Rm400						70-120					
	37	Rm1050						70-120					
H MATERIALI DURI HARD MATERIALS HARTE MATERIALIEN MATÉRIAUX DURS	38	55HRC											
	39	60HRC											
	40	400											
	41	55HRC											



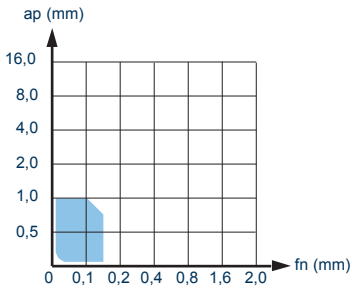

MATERIALE MATERIAL MATERIALIEN MATERIAUX PAG 1199	VDI 3323 GR.	HB HRC Rm	T3220	T3121 NEW	T531	F8120	T1435	T1215 NEW	F8315	T2120	T1225 NEW	T2335	T540	
P ACCIAI STEELS STAHL ACIER	1	125	200-340		200-300		170-190	140-360		130-250	100-250		170-250	
	2	180	200-340		180-280		170-190	140-360		130-250	100-250		140-200	
	3	250	200-340				170-190	140-360		130-250	100-250		120-150	
	4	220	200-340				170-190	140-360		130-250	100-250		110-150	
	5	300	200-340				170-190	130-260		130-250	100-180		100-120	
	6	180	200-340				170-190	130-260		130-250	100-180		140-200	
	7-8	250-300	150-290				90-150	130-260		60-180	100-180		100-140	
	9	350	150-290				120-200	130-260		60-180	100-180		70-100	
	10	200	160-290				120-200	110-210		80-200	80-160		90-130	
	11	350	160-290				140-180	110-210		80-200	80-160		60-100	
	12	200	160-290			130-180		140-180	110-210		120-250	80-160		120-170
	13	330	160-290			100-140		140-200	110-210		120-250	80-160		80-130
	M ACCIAI INOX STAINLESS STEELS ROSTFREIER STAHL ACIER INOXYDABLE	14.1	180			100-160	100-140	100-190		120-220	100-250	100-130	80-120	70-180
14.2		230-260			80-120	75-120	50-150		50-90	40-160	100-130	70-100	60-130	
K GHISA CAST IRON GRAUGUSS FONTE GRISE	15	180	150-400	200-400				110-360						
	16	260	150-400	140-270				110-360						
	17	160	200-450	120-300				110-360						
	18	250	200-450	100-200				110-360						
	19	130	200-550	180-320				110-210						
	20	230	200-550	100-240				110-210						
N MAT NON FERROSI NON FERROUS MAT NICHT-EISENMATERIALIEN MAT. FERREUX	21	60											300-950	
	22	100											300-700	
	23	75											300-700	
	24	90											300-500	
	25	130											250-350	
	26	110											400-500	
	27	90											250-350	
	28	100												
	29													
	30													
S MAT DIFFICILI DIFFICULT MATERIAL SCHWIERIGE MATERIALIEN MAT. DIFFICILES	31	200			20-40	40-75			80-120				35-100	
	32	280			15-35	40-60			60-100				35-70	
	33	250			10-30	30-50			35-90					
	34	350			5-18	20-35			30-50				20-60	
	35	320			5-18	15-30			30-50				40-60	
	36	Rm400			80-130	25-45			70-120				40-60	
	37	Rm1050			20-40	15-35			70-120					
H MATERIALI DURI HARD MATERIALS HARTE MATERIALIEN MATERIAUX DURS	38	55HRC												
	39	60HRC												
	40	400												
	41	55HRC												







MATERIALE MATERIAL MATERIALIEN MATÉRIAUX PAG 1199	VDI 3323 GR.	HB HRC Rm	D3010									
P ACCIAI STEELS STAHL ACIER	1	125										
	2	180										
	3	250										
	4	220										
	5	300										
	6	180										
	7-8	250-300										
	9	350										
	10	200										
	11	350										
	12	200										
	13	330										
	M ACCIAI INOX STAINLESS STEELS ROSTFREIER STAHL ACIER INOXYDABLE	14.1	180									
14.2		230-260										
K GHISA CAST IRON GRAUGUSS FONTE GRISE	15	180										
	16	260										
	17	160										
	18	250										
	19	130										
	20	230										
N MAT/NON FERROSI NONFERROUS MAT. NICHT-EISENMATERIALIEN MAT. FERREUX	21	60	300-950									
	22	100	300-950									
	23	75	200-950									
	24	90	200-950									
	25	130	180-500									
	26	110	180-350									
	27	90	180-350									
	28	100	200-950									
	29		300-950									
	30		300-950									
S MAT/DIFFICILI DIFFICULT MATERIAL SCHWIERIGE MATERIALIEN MAT. DIFCILES	31	200										
	32	280										
	33	250										
	34	350										
	35	320										
	36	Rm400										
	37	Rm1050										
H MATERIALI DURI HARD MATERIALS HARTE MATERIALIEN MATÉRIAUX DURS	38	55HRC										
	39	60HRC										
	40	400										
	41	55HRC										





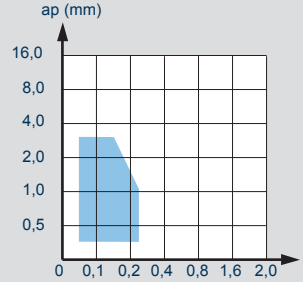
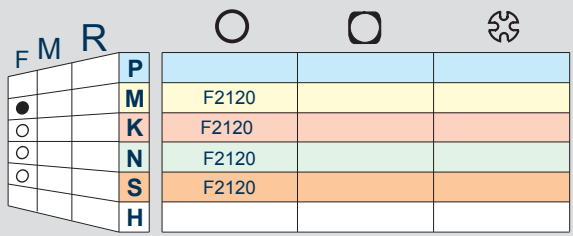

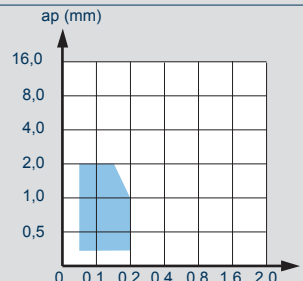
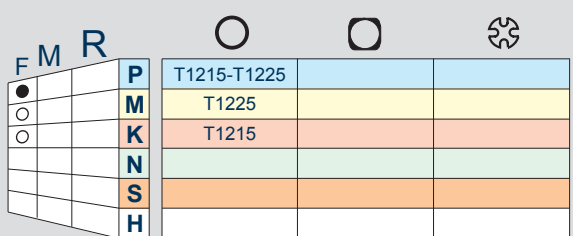

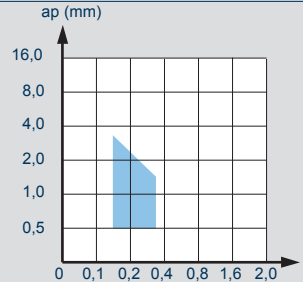
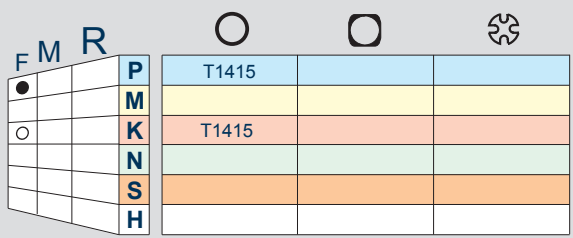

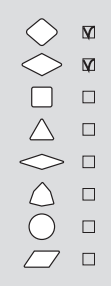
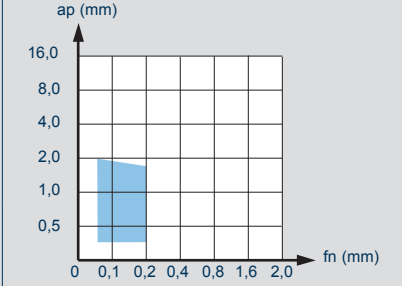
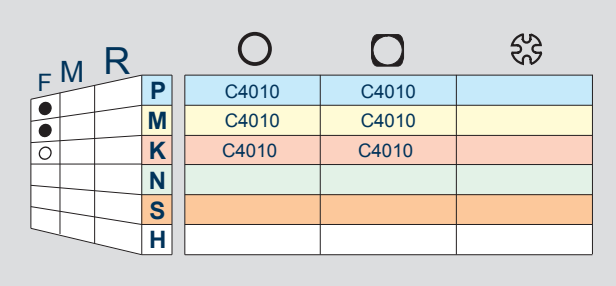

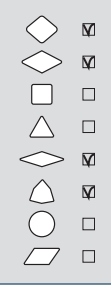
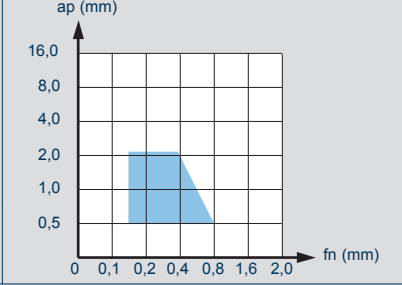
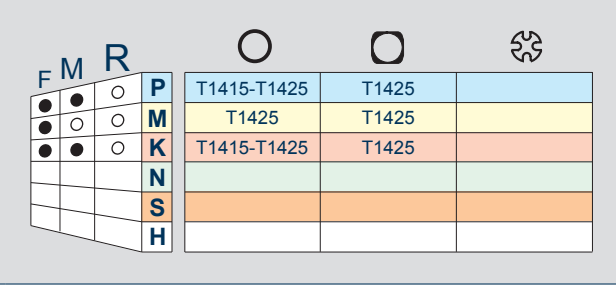
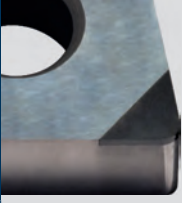
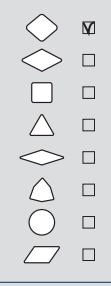
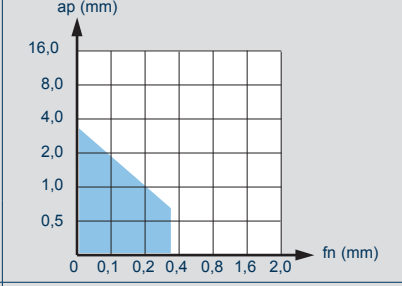
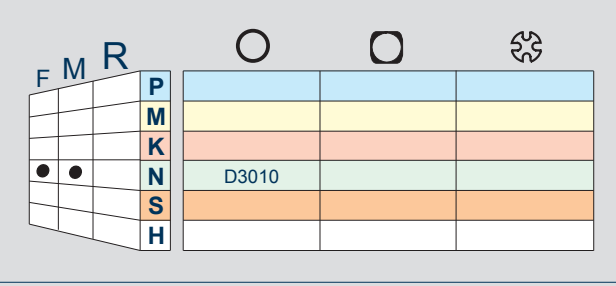

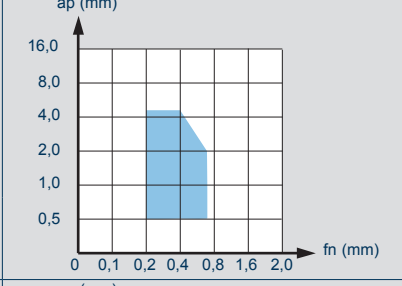
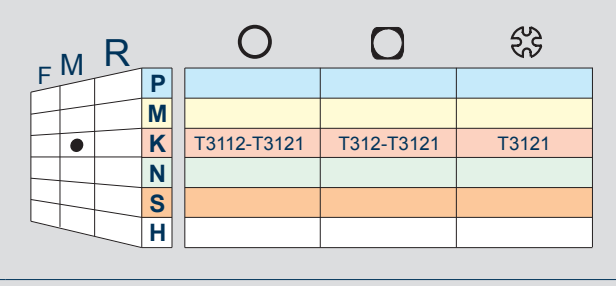

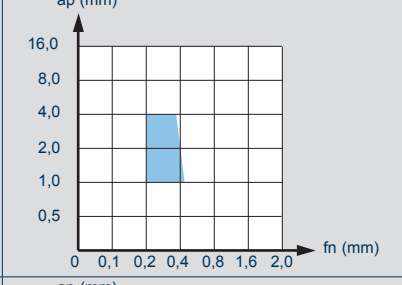
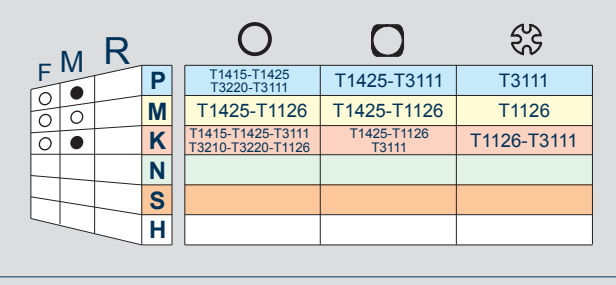

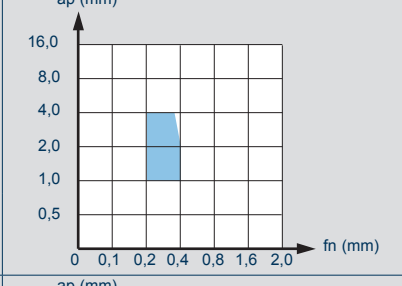
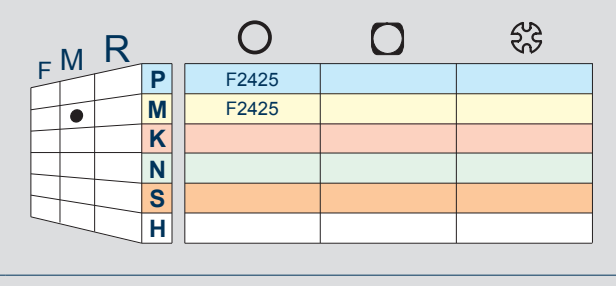

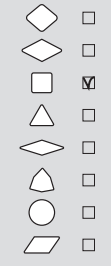
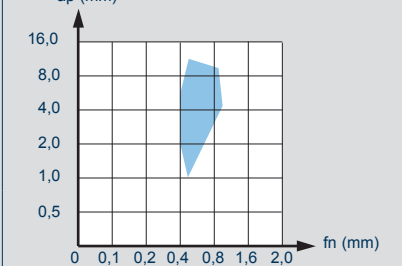
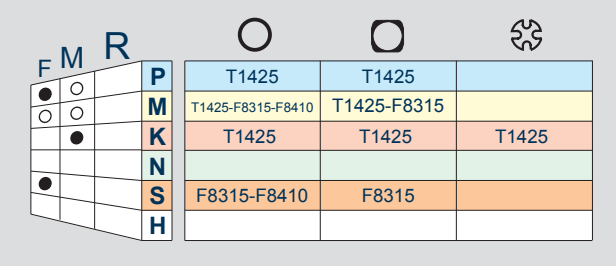



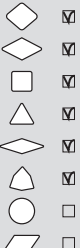
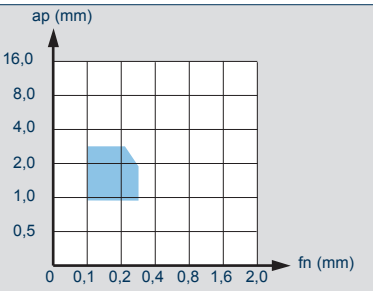
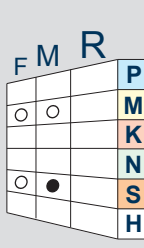

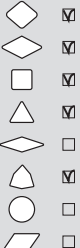
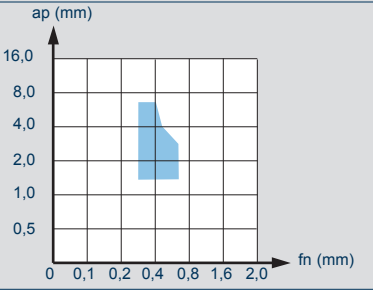
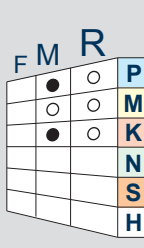
F	M	R				
			P			
			M	DT61T		
			K	DT61T		
			N	T120		
			S	T120		
			H			

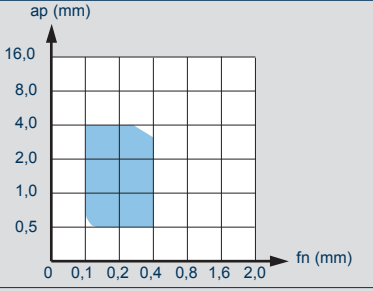
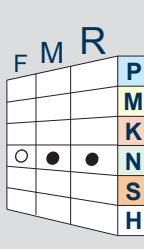

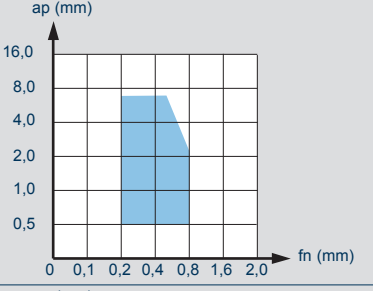
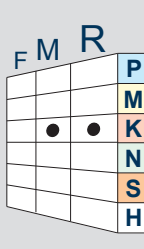

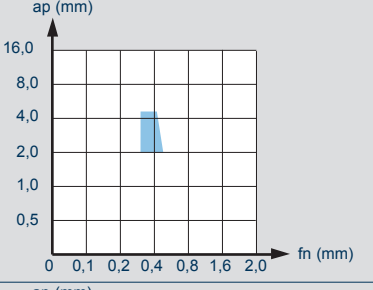
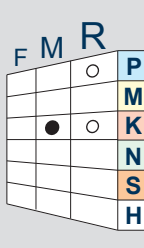

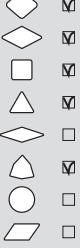
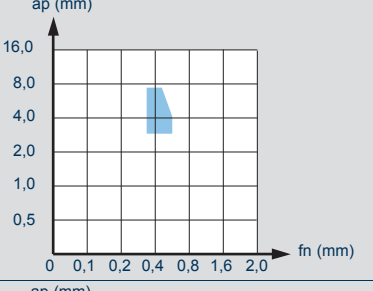
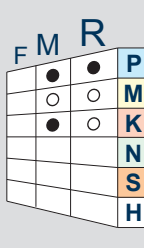

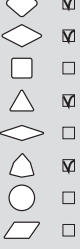
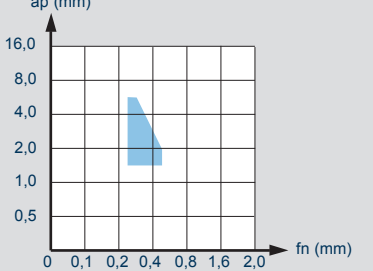
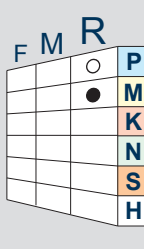

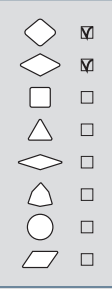
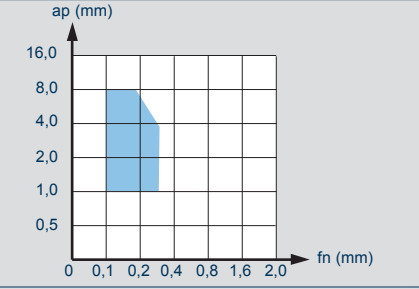
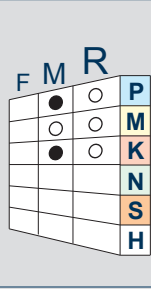

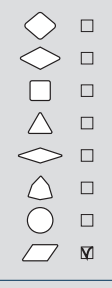
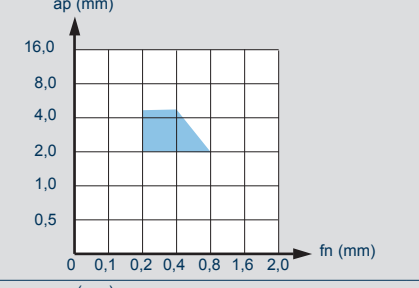
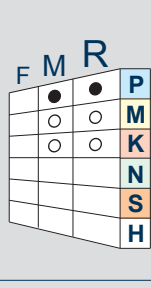
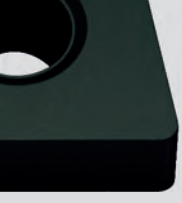
GRADI CONSIGLIATI
 RECOMMENDED GRADES
 EMPFOHLENE SORTEN
 DEGRÉS CONSEILLÉS

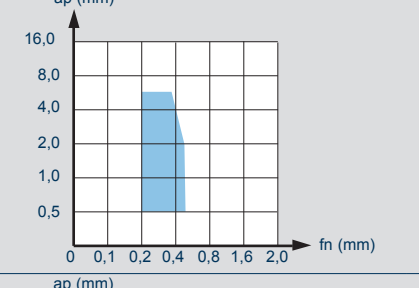
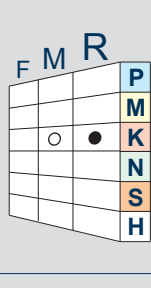

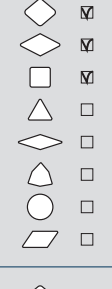
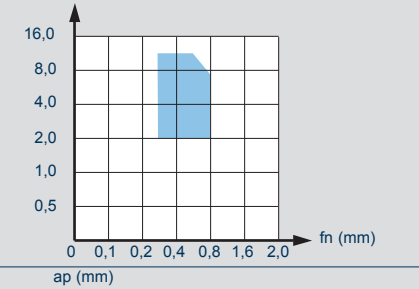
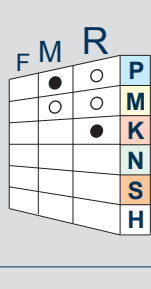

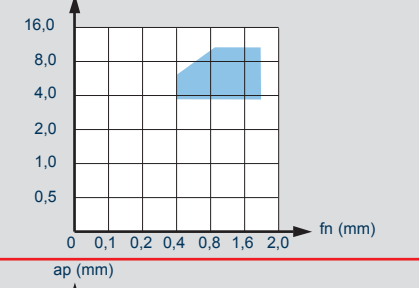
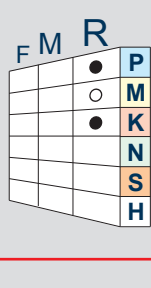

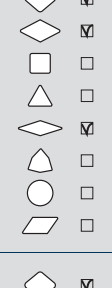
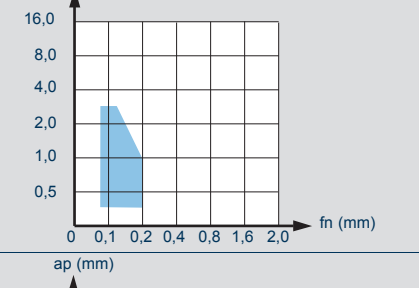
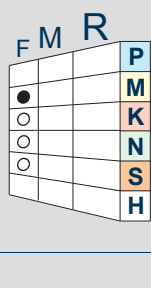
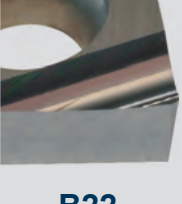

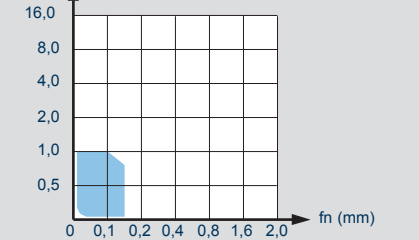
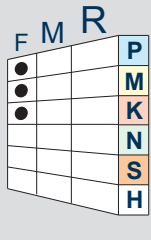



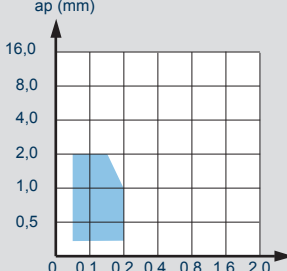
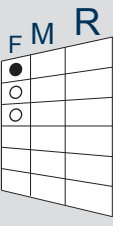
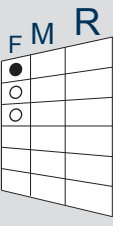
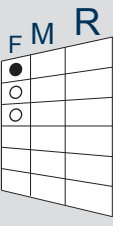

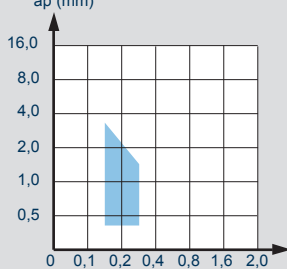
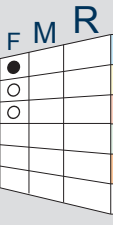
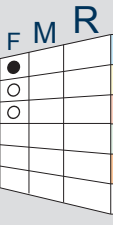
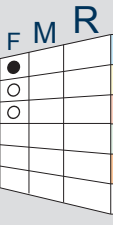
				
F =	FINITURA, LAV. LEGGERE	FINISHING, LIGHT MACHINING	SCHLICHTEN, LEICHTE BEARBEITUNG	FINISSAGE USINAGES LÉGÈRES
M =	GENERIC, LAV. MEDIE	GENERIC MEDIUM MACHINING	ALLGEMEIN, MITTELSCHWERE BEARBEITUNG	GENERAL USINAGES MOYENS
R =	SGROSSATURA, LAV. PESANTI	ROUGHING, HEAVY MACHINING	SCHRUPPEN, SCHWERE BEARBEITUNG	DEGROSSISAGES, USINAGES LOURDS
P,M,K,N,S,H =	MATERIALI ISO PAG 1199	ISO MATERIALS PAGE 1199	ISO-MATERIEALIEN, SEITE 1199	MATERIAUX ISO PAG 1199
	TAGLIO CONTINUO	CONTINUOUS CUT	KONTINUIERLICHER SCHNITT	TRONÇONNAGE CONTINU
	TAGLIO DISCONTINUO	DISCONTINUOUS CUT	DISKONTINUIERLICHER SCHNITT	TRONÇONNAGE DISCONTINU
	TAGLIO INTERROTTO	INTERRUPTED CUT	UNTERBROCHENER SCHNITT	TRONÇONNAGE INTERROMPU
	APPLICAZIONE CONSIGLIATA	RECOMMENDED APPLICATION	EMPFOHLENER EINSATZ	APPLICATION CONSEILLÉE
	APPLICAZIONE POSSIBILE	POSSIBLE APPLICATION	MOGLICHE ANWENDUNG	APPLICATION POSSIBLE
ap (mm) =	PROFONDITÀ DI PASSATA	DEPTH OF CUT	GANGTIEFE	PROFONDEUR DE PASSE
fn (mm) =	AVANZAMENTO AL GIRO	FEED/REVOLUTION	VORSCHUB PRO UMDREHUNG	DÉPLACEMENT AU TOUR

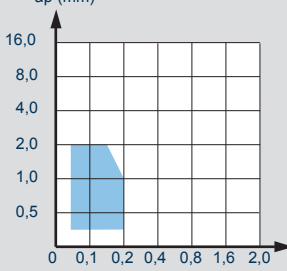
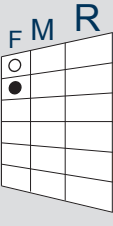
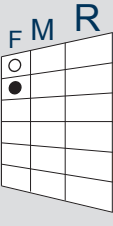
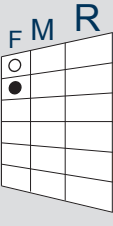
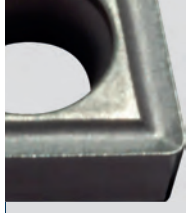

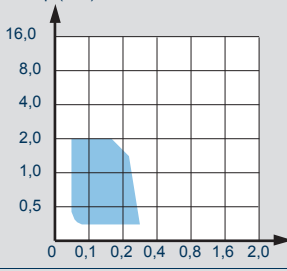
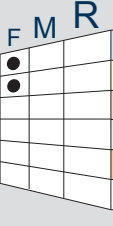
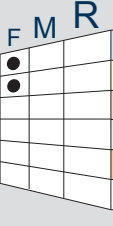
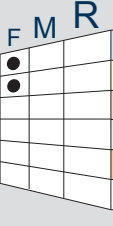
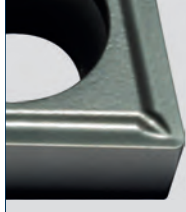

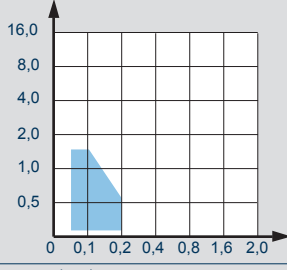
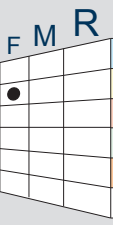
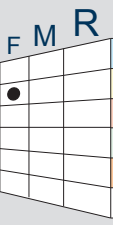
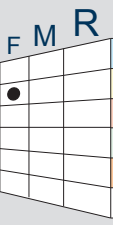
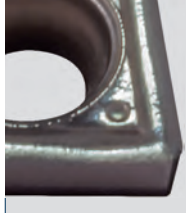

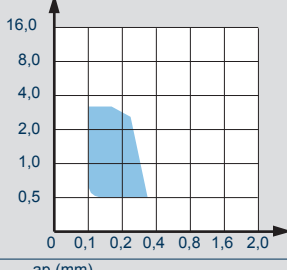
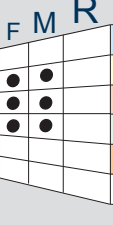
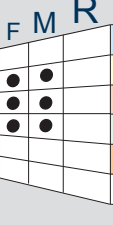
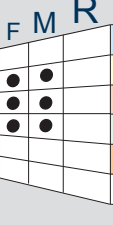

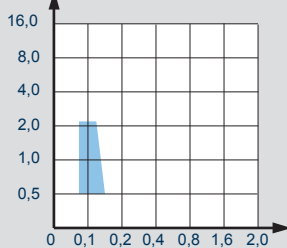
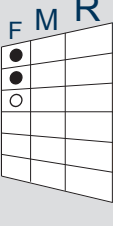
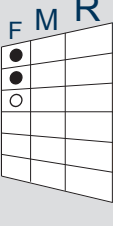
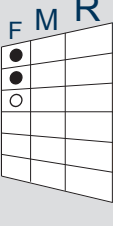



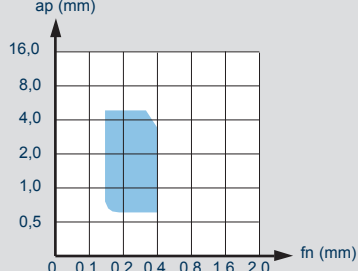
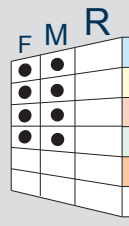
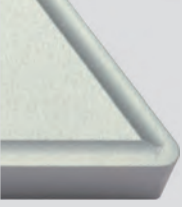

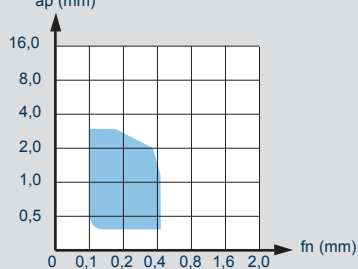
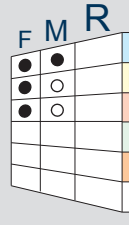
 .G23			
 .F32 NEW			
 .G34W			

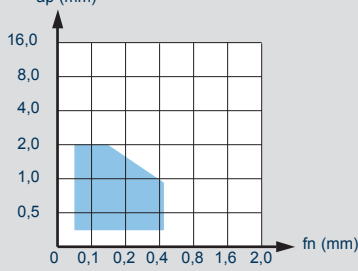
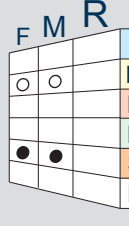

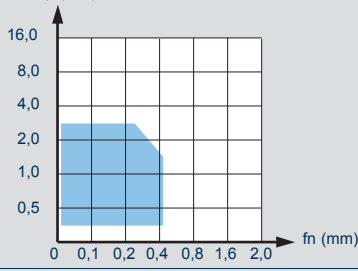
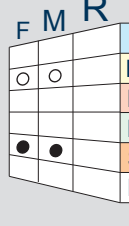
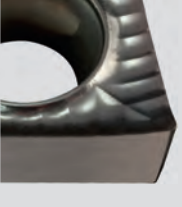

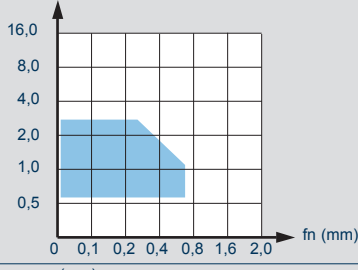
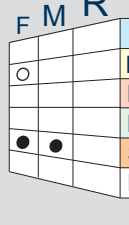

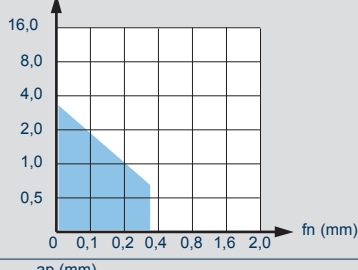
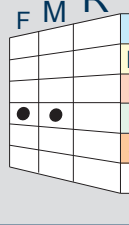

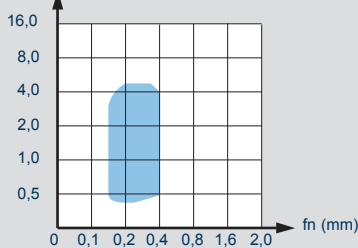
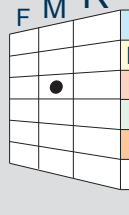



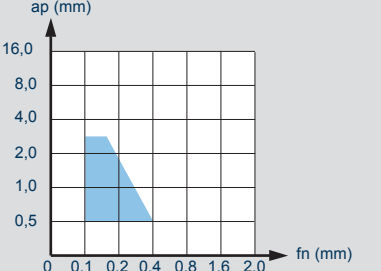
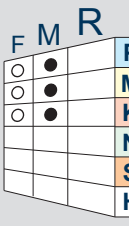
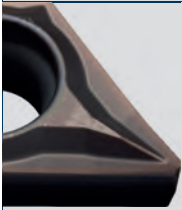

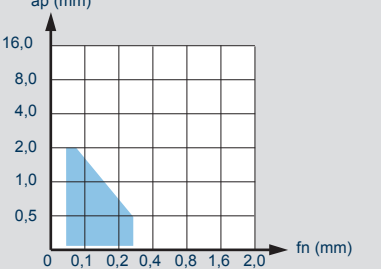

 <p>.G39</p>			
 <p>.G42</p>			
 <p>.X47</p>			
 <p>.F51 NEW</p>			
 <p>.G52</p>			
 <p>.G53</p>			
 <p>.G54</p>			

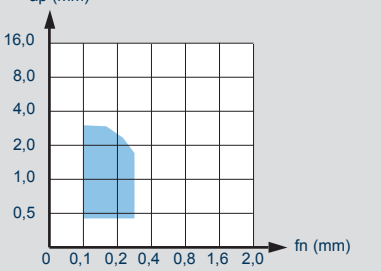
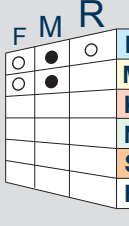
 <p>.G55</p>			 <table border="1" data-bbox="1053 168 1476 414"> <tr> <td></td> <td>○</td> <td>○</td> <td>⊗</td> </tr> <tr> <td>P</td> <td></td> <td></td> <td></td> </tr> <tr> <td>M</td> <td>F8315-F8410</td> <td>F8315-F8410</td> <td></td> </tr> <tr> <td>K</td> <td></td> <td></td> <td></td> </tr> <tr> <td>N</td> <td></td> <td></td> <td></td> </tr> <tr> <td>S</td> <td>F8315-F8410</td> <td>F8315-F8410</td> <td></td> </tr> <tr> <td>H</td> <td></td> <td></td> <td></td> </tr> </table>		○	○	⊗	P				M	F8315-F8410	F8315-F8410		K				N				S	F8315-F8410	F8315-F8410		H			
	○	○	⊗																												
P																															
M	F8315-F8410	F8315-F8410																													
K																															
N																															
S	F8315-F8410	F8315-F8410																													
H																															
 <p>.G56</p>			 <table border="1" data-bbox="1053 456 1476 703"> <tr> <td></td> <td>○</td> <td>○</td> <td>⊗</td> </tr> <tr> <td>P</td> <td>T1415-T1425 T1435-T3111</td> <td>T1415-T1425 T1435-T3111</td> <td>T1425-T1435-T3111</td> </tr> <tr> <td>M</td> <td>T1415-T1425 T1126-T1435</td> <td>T1415-T1425 T1126-T1435</td> <td>T1425-T1126</td> </tr> <tr> <td>K</td> <td>T1415-T1425 T1126-T3111</td> <td>T1415-T1425 T1126-T3111</td> <td>T1425-T1126-T3111</td> </tr> <tr> <td>N</td> <td></td> <td></td> <td></td> </tr> <tr> <td>S</td> <td></td> <td></td> <td></td> </tr> <tr> <td>H</td> <td></td> <td></td> <td></td> </tr> </table>		○	○	⊗	P	T1415-T1425 T1435-T3111	T1415-T1425 T1435-T3111	T1425-T1435-T3111	M	T1415-T1425 T1126-T1435	T1415-T1425 T1126-T1435	T1425-T1126	K	T1415-T1425 T1126-T3111	T1415-T1425 T1126-T3111	T1425-T1126-T3111	N				S				H			
	○	○	⊗																												
P	T1415-T1425 T1435-T3111	T1415-T1425 T1435-T3111	T1425-T1435-T3111																												
M	T1415-T1425 T1126-T1435	T1415-T1425 T1126-T1435	T1425-T1126																												
K	T1415-T1425 T1126-T3111	T1415-T1425 T1126-T3111	T1425-T1126-T3111																												
N																															
S																															
H																															
 <p>.K57P</p>			 <table border="1" data-bbox="1053 745 1476 992"> <tr> <td></td> <td>○</td> <td>○</td> <td>⊗</td> </tr> <tr> <td>P</td> <td></td> <td></td> <td></td> </tr> <tr> <td>M</td> <td></td> <td></td> <td></td> </tr> <tr> <td>K</td> <td></td> <td></td> <td></td> </tr> <tr> <td>N</td> <td>T110</td> <td>T110</td> <td></td> </tr> <tr> <td>S</td> <td></td> <td></td> <td></td> </tr> <tr> <td>H</td> <td></td> <td></td> <td></td> </tr> </table>		○	○	⊗	P				M				K				N	T110	T110		S				H			
	○	○	⊗																												
P																															
M																															
K																															
N	T110	T110																													
S																															
H																															
 <p>.F61 NEW</p>			 <table border="1" data-bbox="1053 1034 1476 1281"> <tr> <td></td> <td>○</td> <td>○</td> <td>⊗</td> </tr> <tr> <td>P</td> <td></td> <td></td> <td></td> </tr> <tr> <td>M</td> <td></td> <td></td> <td></td> </tr> <tr> <td>K</td> <td>T3112-T3121</td> <td>T3112-T3121</td> <td>T3121</td> </tr> <tr> <td>N</td> <td></td> <td></td> <td></td> </tr> <tr> <td>S</td> <td></td> <td></td> <td></td> </tr> <tr> <td>H</td> <td></td> <td></td> <td></td> </tr> </table>		○	○	⊗	P				M				K	T3112-T3121	T3112-T3121	T3121	N				S				H			
	○	○	⊗																												
P																															
M																															
K	T3112-T3121	T3112-T3121	T3121																												
N																															
S																															
H																															
 <p>.G61</p>			 <table border="1" data-bbox="1053 1323 1476 1570"> <tr> <td></td> <td>○</td> <td>○</td> <td>⊗</td> </tr> <tr> <td>P</td> <td>T3220-T3111</td> <td>T3220-T3111</td> <td>T3111</td> </tr> <tr> <td>M</td> <td></td> <td></td> <td></td> </tr> <tr> <td>K</td> <td>T3220-T3111-T1126</td> <td>T3220-T3111-T1126</td> <td>T1126-T3111</td> </tr> <tr> <td>N</td> <td></td> <td></td> <td></td> </tr> <tr> <td>S</td> <td></td> <td></td> <td></td> </tr> <tr> <td>H</td> <td></td> <td></td> <td></td> </tr> </table>		○	○	⊗	P	T3220-T3111	T3220-T3111	T3111	M				K	T3220-T3111-T1126	T3220-T3111-T1126	T1126-T3111	N				S				H			
	○	○	⊗																												
P	T3220-T3111	T3220-T3111	T3111																												
M																															
K	T3220-T3111-T1126	T3220-T3111-T1126	T1126-T3111																												
N																															
S																															
H																															
 <p>.G62</p>			 <table border="1" data-bbox="1053 1612 1476 1859"> <tr> <td></td> <td>○</td> <td>○</td> <td>⊗</td> </tr> <tr> <td>P</td> <td>T1415-T1425-T1435 T3220-T3111</td> <td>T1425-T1435-T3111</td> <td>T1435-T3111</td> </tr> <tr> <td>M</td> <td>T1415-T1425 T1126-T1435</td> <td>T1425-T1435-T1126</td> <td>T1126</td> </tr> <tr> <td>K</td> <td>T1415-T1425-T1126 T3111-T3220</td> <td>T1425-T1126 T3220-T3111</td> <td>T1425-T1126-T3111</td> </tr> <tr> <td>N</td> <td></td> <td></td> <td></td> </tr> <tr> <td>S</td> <td></td> <td></td> <td></td> </tr> <tr> <td>H</td> <td></td> <td></td> <td></td> </tr> </table>		○	○	⊗	P	T1415-T1425-T1435 T3220-T3111	T1425-T1435-T3111	T1435-T3111	M	T1415-T1425 T1126-T1435	T1425-T1435-T1126	T1126	K	T1415-T1425-T1126 T3111-T3220	T1425-T1126 T3220-T3111	T1425-T1126-T3111	N				S				H			
	○	○	⊗																												
P	T1415-T1425-T1435 T3220-T3111	T1425-T1435-T3111	T1435-T3111																												
M	T1415-T1425 T1126-T1435	T1425-T1435-T1126	T1126																												
K	T1415-T1425-T1126 T3111-T3220	T1425-T1126 T3220-T3111	T1425-T1126-T3111																												
N																															
S																															
H																															
 <p>.G63</p>			 <table border="1" data-bbox="1053 1901 1476 2148"> <tr> <td></td> <td>○</td> <td>○</td> <td>⊗</td> </tr> <tr> <td>P</td> <td>F2425</td> <td>F2425</td> <td></td> </tr> <tr> <td>M</td> <td>F2425</td> <td>F2425</td> <td></td> </tr> <tr> <td>K</td> <td></td> <td></td> <td></td> </tr> <tr> <td>N</td> <td></td> <td></td> <td></td> </tr> <tr> <td>S</td> <td></td> <td></td> <td></td> </tr> <tr> <td>H</td> <td></td> <td></td> <td></td> </tr> </table>		○	○	⊗	P	F2425	F2425		M	F2425	F2425		K				N				S				H			
	○	○	⊗																												
P	F2425	F2425																													
M	F2425	F2425																													
K																															
N																															
S																															
H																															

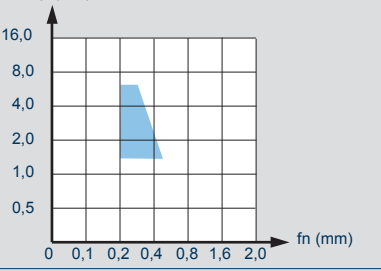
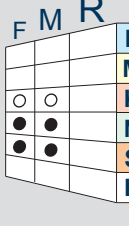
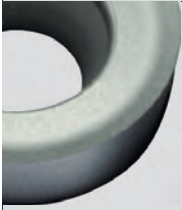
 <p>.G68</p>			 <table border="1" data-bbox="1034 152 1477 439"> <thead> <tr> <th></th> <th>○</th> <th>□</th> <th>⊗</th> </tr> </thead> <tbody> <tr> <th>P</th> <td>T1425</td> <td>T1425</td> <td></td> </tr> <tr> <th>M</th> <td>T1425</td> <td>T1425</td> <td></td> </tr> <tr> <th>K</th> <td>T1425</td> <td>T1425</td> <td></td> </tr> <tr> <th>N</th> <td></td> <td></td> <td></td> </tr> <tr> <th>S</th> <td></td> <td></td> <td></td> </tr> <tr> <th>H</th> <td></td> <td></td> <td></td> </tr> </tbody> </table>		○	□	⊗	P	T1425	T1425		M	T1425	T1425		K	T1425	T1425		N				S				H			
	○	□	⊗																												
P	T1425	T1425																													
M	T1425	T1425																													
K	T1425	T1425																													
N																															
S																															
H																															
 <p>.G69</p>			 <table border="1" data-bbox="1034 445 1477 732"> <thead> <tr> <th></th> <th>○</th> <th>□</th> <th>⊗</th> </tr> </thead> <tbody> <tr> <th>P</th> <td>T1425</td> <td>T1425</td> <td>T1425</td> </tr> <tr> <th>M</th> <td>T1425</td> <td>T1425</td> <td>T1425</td> </tr> <tr> <th>K</th> <td>T1425</td> <td>T1425</td> <td>T1425</td> </tr> <tr> <th>N</th> <td></td> <td></td> <td></td> </tr> <tr> <th>S</th> <td></td> <td></td> <td></td> </tr> <tr> <th>H</th> <td></td> <td></td> <td></td> </tr> </tbody> </table>		○	□	⊗	P	T1425	T1425	T1425	M	T1425	T1425	T1425	K	T1425	T1425	T1425	N				S				H			
	○	□	⊗																												
P	T1425	T1425	T1425																												
M	T1425	T1425	T1425																												
K	T1425	T1425	T1425																												
N																															
S																															
H																															
 <p>.F71 NEW</p>			 <table border="1" data-bbox="1034 739 1477 1025"> <thead> <tr> <th></th> <th>○</th> <th>□</th> <th>⊗</th> </tr> </thead> <tbody> <tr> <th>P</th> <td></td> <td></td> <td></td> </tr> <tr> <th>M</th> <td></td> <td></td> <td></td> </tr> <tr> <th>K</th> <td>T3112-T3121</td> <td>T3112-T3121</td> <td>T3121</td> </tr> <tr> <th>N</th> <td></td> <td></td> <td></td> </tr> <tr> <th>S</th> <td></td> <td></td> <td></td> </tr> <tr> <th>H</th> <td></td> <td></td> <td></td> </tr> </tbody> </table>		○	□	⊗	P				M				K	T3112-T3121	T3112-T3121	T3121	N				S				H			
	○	□	⊗																												
P																															
M																															
K	T3112-T3121	T3112-T3121	T3121																												
N																															
S																															
H																															
 <p>.G72</p>			 <table border="1" data-bbox="1034 1032 1477 1319"> <thead> <tr> <th></th> <th>○</th> <th>□</th> <th>⊗</th> </tr> </thead> <tbody> <tr> <th>P</th> <td>T1415-T1425-T1435</td> <td>T1415-T1425-T1435</td> <td>T1425-T1435</td> </tr> <tr> <th>M</th> <td>T1415-T1425-T1435</td> <td>T1415-T1425-T1435</td> <td>T1425-T1435</td> </tr> <tr> <th>K</th> <td>T1415-T1425-T1435</td> <td>T1415-T1425-T1435</td> <td>T1425-T1435</td> </tr> <tr> <th>N</th> <td></td> <td></td> <td></td> </tr> <tr> <th>S</th> <td></td> <td></td> <td></td> </tr> <tr> <th>H</th> <td></td> <td></td> <td></td> </tr> </tbody> </table>		○	□	⊗	P	T1415-T1425-T1435	T1415-T1425-T1435	T1425-T1435	M	T1415-T1425-T1435	T1415-T1425-T1435	T1425-T1435	K	T1415-T1425-T1435	T1415-T1425-T1435	T1425-T1435	N				S				H			
	○	□	⊗																												
P	T1415-T1425-T1435	T1415-T1425-T1435	T1425-T1435																												
M	T1415-T1425-T1435	T1415-T1425-T1435	T1425-T1435																												
K	T1415-T1425-T1435	T1415-T1425-T1435	T1425-T1435																												
N																															
S																															
H																															
 <p>.G82</p>			 <table border="1" data-bbox="1034 1326 1477 1612"> <thead> <tr> <th></th> <th>○</th> <th>□</th> <th>⊗</th> </tr> </thead> <tbody> <tr> <th>P</th> <td>T1425</td> <td>T1425</td> <td>T1425</td> </tr> <tr> <th>M</th> <td>T1425</td> <td>T1425</td> <td>T1425</td> </tr> <tr> <th>K</th> <td>T1425</td> <td>T1425</td> <td>T1425</td> </tr> <tr> <th>N</th> <td></td> <td></td> <td></td> </tr> <tr> <th>S</th> <td></td> <td></td> <td></td> </tr> <tr> <th>H</th> <td></td> <td></td> <td></td> </tr> </tbody> </table>		○	□	⊗	P	T1425	T1425	T1425	M	T1425	T1425	T1425	K	T1425	T1425	T1425	N				S				H			
	○	□	⊗																												
P	T1425	T1425	T1425																												
M	T1425	T1425	T1425																												
K	T1425	T1425	T1425																												
N																															
S																															
H																															
 <p>.G13</p>			 <table border="1" data-bbox="1034 1619 1477 1906"> <thead> <tr> <th></th> <th>○</th> <th>□</th> <th>⊗</th> </tr> </thead> <tbody> <tr> <th>P</th> <td></td> <td></td> <td></td> </tr> <tr> <th>M</th> <td>F2120</td> <td>F2120</td> <td></td> </tr> <tr> <th>K</th> <td>F2120</td> <td>F2120</td> <td></td> </tr> <tr> <th>N</th> <td>F2120</td> <td>F2120</td> <td></td> </tr> <tr> <th>S</th> <td>F2120</td> <td>F2120</td> <td></td> </tr> <tr> <th>H</th> <td></td> <td></td> <td></td> </tr> </tbody> </table>		○	□	⊗	P				M	F2120	F2120		K	F2120	F2120		N	F2120	F2120		S	F2120	F2120		H			
	○	□	⊗																												
P																															
M	F2120	F2120																													
K	F2120	F2120																													
N	F2120	F2120																													
S	F2120	F2120																													
H																															
 <p>.B22</p>			 <table border="1" data-bbox="1034 1912 1477 2199"> <thead> <tr> <th></th> <th>○</th> <th>□</th> <th>⊗</th> </tr> </thead> <tbody> <tr> <th>P</th> <td>DT63</td> <td></td> <td></td> </tr> <tr> <th>M</th> <td>DT63-T531</td> <td>T531</td> <td>T531</td> </tr> <tr> <th>K</th> <td>DT63</td> <td></td> <td></td> </tr> <tr> <th>N</th> <td></td> <td></td> <td></td> </tr> <tr> <th>S</th> <td></td> <td></td> <td></td> </tr> <tr> <th>H</th> <td></td> <td></td> <td></td> </tr> </tbody> </table>		○	□	⊗	P	DT63			M	DT63-T531	T531	T531	K	DT63			N				S				H			
	○	□	⊗																												
P	DT63																														
M	DT63-T531	T531	T531																												
K	DT63																														
N																															
S																															
H																															

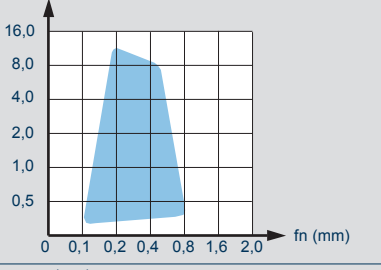
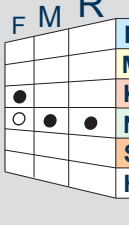
 <p>.F32 NEW</p>		<p>ap (mm)</p>  <p>fn (mm)</p>	<table border="1"> <tr> <td rowspan="6">  </td> <td></td> <td>○</td> <td>○</td> <td>⊗</td> </tr> <tr> <td>P</td> <td>T1215-T1225</td> <td></td> <td></td> </tr> <tr> <td>M</td> <td>T1225</td> <td></td> <td></td> </tr> <tr> <td>K</td> <td>T1215</td> <td></td> <td></td> </tr> <tr> <td>N</td> <td></td> <td></td> <td></td> </tr> <tr> <td>S</td> <td></td> <td></td> <td></td> </tr> <tr> <td>H</td> <td></td> <td></td> <td></td> </tr> </table>			○	○	⊗	P	T1215-T1225			M	T1225			K	T1215			N				S				H			
		○	○		⊗																											
	P	T1215-T1225																														
	M	T1225																														
	K	T1215																														
	N																															
	S																															
H																																
 <p>.G32W</p>		<p>ap (mm)</p>  <p>fn (mm)</p>	<table border="1"> <tr> <td rowspan="6">  </td> <td></td> <td>○</td> <td>○</td> <td>⊗</td> </tr> <tr> <td>P</td> <td>T1425</td> <td></td> <td></td> </tr> <tr> <td>M</td> <td>T1425</td> <td></td> <td></td> </tr> <tr> <td>K</td> <td>T1425</td> <td></td> <td></td> </tr> <tr> <td>N</td> <td></td> <td></td> <td></td> </tr> <tr> <td>S</td> <td></td> <td></td> <td></td> </tr> <tr> <td>H</td> <td></td> <td></td> <td></td> </tr> </table>			○	○	⊗	P	T1425			M	T1425			K	T1425			N				S				H			
		○	○		⊗																											
	P	T1425																														
	M	T1425																														
	K	T1425																														
	N																															
	S																															
H																																
 <p>.F33 NEW</p>		<p>ap (mm)</p>  <p>fn (mm)</p>	<table border="1"> <tr> <td rowspan="6">  </td> <td></td> <td>○</td> <td>○</td> <td>⊗</td> </tr> <tr> <td>P</td> <td>F2326</td> <td></td> <td></td> </tr> <tr> <td>M</td> <td>F2326</td> <td></td> <td></td> </tr> <tr> <td>K</td> <td></td> <td></td> <td></td> </tr> <tr> <td>N</td> <td></td> <td></td> <td></td> </tr> <tr> <td>S</td> <td></td> <td></td> <td></td> </tr> <tr> <td>H</td> <td></td> <td></td> <td></td> </tr> </table>			○	○	⊗	P	F2326			M	F2326			K				N				S				H			
		○	○		⊗																											
	P	F2326																														
	M	F2326																														
	K																															
	N																															
	S																															
H																																
 <p>.D34</p>		<p>ap (mm)</p>  <p>fn (mm)</p>	<table border="1"> <tr> <td rowspan="6">  </td> <td></td> <td>○</td> <td>○</td> <td>⊗</td> </tr> <tr> <td>P</td> <td>DT61T</td> <td></td> <td></td> </tr> <tr> <td>M</td> <td>DT61T</td> <td></td> <td></td> </tr> <tr> <td>K</td> <td></td> <td></td> <td></td> </tr> <tr> <td>N</td> <td></td> <td></td> <td></td> </tr> <tr> <td>S</td> <td></td> <td></td> <td></td> </tr> <tr> <td>H</td> <td></td> <td></td> <td></td> </tr> </table>			○	○	⊗	P	DT61T			M	DT61T			K				N				S				H			
		○	○		⊗																											
	P	DT61T																														
	M	DT61T																														
	K																															
	N																															
	S																															
H																																
 <p>.G39</p>		<p>ap (mm)</p>  <p>fn (mm)</p>	<table border="1"> <tr> <td rowspan="6">  </td> <td></td> <td>○</td> <td>○</td> <td>⊗</td> </tr> <tr> <td>P</td> <td>C4010</td> <td></td> <td></td> </tr> <tr> <td>M</td> <td>C4010</td> <td></td> <td></td> </tr> <tr> <td>K</td> <td>C4010</td> <td></td> <td></td> </tr> <tr> <td>N</td> <td></td> <td></td> <td></td> </tr> <tr> <td>S</td> <td></td> <td></td> <td></td> </tr> <tr> <td>H</td> <td></td> <td></td> <td></td> </tr> </table>			○	○	⊗	P	C4010			M	C4010			K	C4010			N				S				H			
		○	○		⊗																											
	P	C4010																														
	M	C4010																														
	K	C4010																														
	N																															
	S																															
H																																
 <p>.D42</p>		<p>ap (mm)</p>  <p>fn (mm)</p>	<table border="1"> <tr> <td rowspan="6">  </td> <td></td> <td>○</td> <td>○</td> <td>⊗</td> </tr> <tr> <td>P</td> <td>T120</td> <td>T120</td> <td></td> </tr> <tr> <td>M</td> <td>T120</td> <td>T120</td> <td></td> </tr> <tr> <td>K</td> <td>T120</td> <td>T120</td> <td></td> </tr> <tr> <td>N</td> <td></td> <td></td> <td></td> </tr> <tr> <td>S</td> <td></td> <td></td> <td></td> </tr> <tr> <td>H</td> <td></td> <td></td> <td></td> </tr> </table>			○	○	⊗	P	T120	T120		M	T120	T120		K	T120	T120		N				S				H			
		○	○		⊗																											
	P	T120	T120																													
	M	T120	T120																													
	K	T120	T120																													
	N																															
	S																															
H																																
 <p>.G42</p>		<p>ap (mm)</p>  <p>fn (mm)</p>	<table border="1"> <tr> <td rowspan="6">  </td> <td></td> <td>○</td> <td>○</td> <td>⊗</td> </tr> <tr> <td>P</td> <td>T1415-T1425-F2425</td> <td>T1415-T1425-F2425</td> <td></td> </tr> <tr> <td>M</td> <td>T1425-F2425</td> <td>T1425-F2425</td> <td></td> </tr> <tr> <td>K</td> <td>T1415-T1425</td> <td>T1415-T1425</td> <td></td> </tr> <tr> <td>N</td> <td></td> <td></td> <td></td> </tr> <tr> <td>S</td> <td></td> <td></td> <td></td> </tr> <tr> <td>H</td> <td></td> <td></td> <td></td> </tr> </table>			○	○	⊗	P	T1415-T1425-F2425	T1415-T1425-F2425		M	T1425-F2425	T1425-F2425		K	T1415-T1425	T1415-T1425		N				S				H			
		○	○		⊗																											
	P	T1415-T1425-F2425	T1415-T1425-F2425																													
	M	T1425-F2425	T1425-F2425																													
	K	T1415-T1425	T1415-T1425																													
	N																															
	S																															
H																																

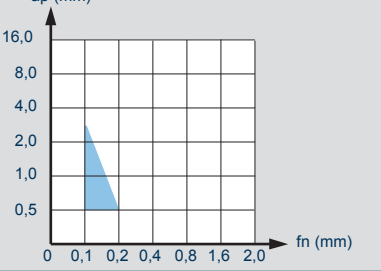
 <p>.S42</p>			 <table border="1" data-bbox="1029 179 1452 414"> <thead> <tr> <th></th> <th>○</th> <th>□</th> <th>⊗</th> </tr> </thead> <tbody> <tr> <td>P</td> <td>T540</td> <td>T540</td> <td>T540</td> </tr> <tr> <td>M</td> <td>T540</td> <td>T540</td> <td>T540</td> </tr> <tr> <td>K</td> <td>T120</td> <td>T120</td> <td>T540</td> </tr> <tr> <td>N</td> <td>T120</td> <td>T120</td> <td>T120</td> </tr> <tr> <td>S</td> <td></td> <td></td> <td></td> </tr> <tr> <td>H</td> <td></td> <td></td> <td></td> </tr> </tbody> </table>		○	□	⊗	P	T540	T540	T540	M	T540	T540	T540	K	T120	T120	T540	N	T120	T120	T120	S				H			
	○	□	⊗																												
P	T540	T540	T540																												
M	T540	T540	T540																												
K	T120	T120	T540																												
N	T120	T120	T120																												
S																															
H																															
 <p>.S44</p>			 <table border="1" data-bbox="1029 470 1452 705"> <thead> <tr> <th></th> <th>○</th> <th>□</th> <th>⊗</th> </tr> </thead> <tbody> <tr> <td>P</td> <td>T7725-T1625</td> <td>T7725-T1625</td> <td></td> </tr> <tr> <td>M</td> <td>T7725-T1625</td> <td>T7725-T1625</td> <td></td> </tr> <tr> <td>K</td> <td>T7725-T1625</td> <td>T7725-T1625</td> <td></td> </tr> <tr> <td>N</td> <td></td> <td></td> <td></td> </tr> <tr> <td>S</td> <td></td> <td></td> <td></td> </tr> <tr> <td>H</td> <td></td> <td></td> <td></td> </tr> </tbody> </table>		○	□	⊗	P	T7725-T1625	T7725-T1625		M	T7725-T1625	T7725-T1625		K	T7725-T1625	T7725-T1625		N				S				H			
	○	□	⊗																												
P	T7725-T1625	T7725-T1625																													
M	T7725-T1625	T7725-T1625																													
K	T7725-T1625	T7725-T1625																													
N																															
S																															
H																															
 <p>.F45 NEW</p>			 <table border="1" data-bbox="1029 761 1452 996"> <thead> <tr> <th></th> <th>○</th> <th>□</th> <th>⊗</th> </tr> </thead> <tbody> <tr> <td>P</td> <td></td> <td></td> <td></td> </tr> <tr> <td>M</td> <td>F8116</td> <td>F8116</td> <td></td> </tr> <tr> <td>K</td> <td></td> <td></td> <td></td> </tr> <tr> <td>N</td> <td></td> <td></td> <td></td> </tr> <tr> <td>S</td> <td>F8116</td> <td>F8116</td> <td></td> </tr> <tr> <td>H</td> <td></td> <td></td> <td></td> </tr> </tbody> </table>		○	□	⊗	P				M	F8116	F8116		K				N				S	F8116	F8116		H			
	○	□	⊗																												
P																															
M	F8116	F8116																													
K																															
N																															
S	F8116	F8116																													
H																															
 <p>.F46 NEW</p>			 <table border="1" data-bbox="1029 1052 1452 1288"> <thead> <tr> <th></th> <th>○</th> <th>□</th> <th>⊗</th> </tr> </thead> <tbody> <tr> <td>P</td> <td></td> <td></td> <td></td> </tr> <tr> <td>M</td> <td>F8116</td> <td>F8116</td> <td></td> </tr> <tr> <td>K</td> <td></td> <td></td> <td></td> </tr> <tr> <td>N</td> <td></td> <td></td> <td></td> </tr> <tr> <td>S</td> <td>F8116</td> <td>F8116</td> <td></td> </tr> <tr> <td>H</td> <td></td> <td></td> <td></td> </tr> </tbody> </table>		○	□	⊗	P				M	F8116	F8116		K				N				S	F8116	F8116		H			
	○	□	⊗																												
P																															
M	F8116	F8116																													
K																															
N																															
S	F8116	F8116																													
H																															
 <p>.F47 NEW</p>			 <table border="1" data-bbox="1029 1344 1452 1579"> <thead> <tr> <th></th> <th>○</th> <th>□</th> <th>⊗</th> </tr> </thead> <tbody> <tr> <td>P</td> <td></td> <td></td> <td></td> </tr> <tr> <td>M</td> <td>T3310</td> <td></td> <td></td> </tr> <tr> <td>K</td> <td></td> <td></td> <td></td> </tr> <tr> <td>N</td> <td></td> <td></td> <td></td> </tr> <tr> <td>S</td> <td>T3310</td> <td>T3310</td> <td></td> </tr> <tr> <td>H</td> <td></td> <td></td> <td></td> </tr> </tbody> </table>		○	□	⊗	P				M	T3310			K				N				S	T3310	T3310		H			
	○	□	⊗																												
P																															
M	T3310																														
K																															
N																															
S	T3310	T3310																													
H																															
 <p>.X37 .X47</p>			 <table border="1" data-bbox="1029 1635 1452 1870"> <thead> <tr> <th></th> <th>○</th> <th>□</th> <th>⊗</th> </tr> </thead> <tbody> <tr> <td>P</td> <td></td> <td></td> <td></td> </tr> <tr> <td>M</td> <td></td> <td></td> <td></td> </tr> <tr> <td>K</td> <td></td> <td></td> <td></td> </tr> <tr> <td>N</td> <td>D3010</td> <td></td> <td></td> </tr> <tr> <td>S</td> <td></td> <td></td> <td></td> </tr> <tr> <td>H</td> <td></td> <td></td> <td></td> </tr> </tbody> </table>		○	□	⊗	P				M				K				N	D3010			S				H			
	○	□	⊗																												
P																															
M																															
K																															
N	D3010																														
S																															
H																															
 <p>.F51 NEW</p>			 <table border="1" data-bbox="1029 1926 1452 2150"> <thead> <tr> <th></th> <th>○</th> <th>□</th> <th>⊗</th> </tr> </thead> <tbody> <tr> <td>P</td> <td></td> <td></td> <td></td> </tr> <tr> <td>M</td> <td></td> <td></td> <td></td> </tr> <tr> <td>K</td> <td>T3112-T3121</td> <td>T3112-T3121</td> <td>T3112-T3121</td> </tr> <tr> <td>N</td> <td></td> <td></td> <td></td> </tr> <tr> <td>S</td> <td></td> <td></td> <td></td> </tr> <tr> <td>H</td> <td></td> <td></td> <td></td> </tr> </tbody> </table>		○	□	⊗	P				M				K	T3112-T3121	T3112-T3121	T3112-T3121	N				S				H			
	○	□	⊗																												
P																															
M																															
K	T3112-T3121	T3112-T3121	T3112-T3121																												
N																															
S																															
H																															

 <p>.G52</p>			 <table border="1" data-bbox="1053 190 1476 414"> <thead> <tr> <th></th> <th>○</th> <th>○</th> <th>⊗</th> </tr> </thead> <tbody> <tr> <td>P</td> <td>F2425-F2435-T1415 T1425-T1435-T3220-T3111</td> <td>F2425-F2435-T1425 T1435-T3220-T3111</td> <td>F2435-T1435-T3111</td> </tr> <tr> <td>M</td> <td>F2425-F2435-T1126 T1425-T1435</td> <td>F2425-F2435-T1126 T1425-T1435</td> <td>F2435-T1435-T1126</td> </tr> <tr> <td>K</td> <td>T3220-T1415-T1425 T3111-T1126</td> <td>T3220-T1425 T3111-T1126</td> <td>T3111-T1126</td> </tr> <tr> <td>N</td> <td></td> <td></td> <td></td> </tr> <tr> <td>S</td> <td></td> <td></td> <td></td> </tr> <tr> <td>H</td> <td></td> <td></td> <td></td> </tr> </tbody> </table>		○	○	⊗	P	F2425-F2435-T1415 T1425-T1435-T3220-T3111	F2425-F2435-T1425 T1435-T3220-T3111	F2435-T1435-T3111	M	F2425-F2435-T1126 T1425-T1435	F2425-F2435-T1126 T1425-T1435	F2435-T1435-T1126	K	T3220-T1415-T1425 T3111-T1126	T3220-T1425 T3111-T1126	T3111-T1126	N				S				H			
	○	○	⊗																												
P	F2425-F2435-T1415 T1425-T1435-T3220-T3111	F2425-F2435-T1425 T1435-T3220-T3111	F2435-T1435-T3111																												
M	F2425-F2435-T1126 T1425-T1435	F2425-F2435-T1126 T1425-T1435	F2435-T1435-T1126																												
K	T3220-T1415-T1425 T3111-T1126	T3220-T1425 T3111-T1126	T3111-T1126																												
N																															
S																															
H																															
 <p>.B53</p>			 <table border="1" data-bbox="1053 481 1476 705"> <thead> <tr> <th></th> <th>○</th> <th>○</th> <th>⊗</th> </tr> </thead> <tbody> <tr> <td>P</td> <td></td> <td></td> <td></td> </tr> <tr> <td>M</td> <td></td> <td></td> <td>F8120</td> </tr> <tr> <td>K</td> <td></td> <td></td> <td>F8120</td> </tr> <tr> <td>N</td> <td></td> <td></td> <td></td> </tr> <tr> <td>S</td> <td></td> <td></td> <td></td> </tr> <tr> <td>H</td> <td></td> <td></td> <td></td> </tr> </tbody> </table>		○	○	⊗	P				M			F8120	K			F8120	N				S				H			
	○	○	⊗																												
P																															
M			F8120																												
K			F8120																												
N																															
S																															
H																															
 <p>.B56</p>			 <table border="1" data-bbox="1053 772 1476 996"> <thead> <tr> <th></th> <th>○</th> <th>○</th> <th>⊗</th> </tr> </thead> <tbody> <tr> <td>P</td> <td>DT63</td> <td></td> <td></td> </tr> <tr> <td>M</td> <td>DT63-T2335</td> <td>T2335</td> <td></td> </tr> <tr> <td>K</td> <td></td> <td></td> <td></td> </tr> <tr> <td>N</td> <td></td> <td></td> <td></td> </tr> <tr> <td>S</td> <td></td> <td></td> <td></td> </tr> <tr> <td>H</td> <td></td> <td></td> <td></td> </tr> </tbody> </table>		○	○	⊗	P	DT63			M	DT63-T2335	T2335		K				N				S				H			
	○	○	⊗																												
P	DT63																														
M	DT63-T2335	T2335																													
K																															
N																															
S																															
H																															
 <p>.G57 .G57P</p>			 <table border="1" data-bbox="1053 1064 1476 1288"> <thead> <tr> <th></th> <th>○</th> <th>○</th> <th>⊗</th> </tr> </thead> <tbody> <tr> <td>P</td> <td></td> <td></td> <td></td> </tr> <tr> <td>M</td> <td></td> <td></td> <td></td> </tr> <tr> <td>K</td> <td>T115</td> <td>T115</td> <td></td> </tr> <tr> <td>N</td> <td>T115-F2115</td> <td>T115-F2115</td> <td></td> </tr> <tr> <td>S</td> <td>T115-F2115</td> <td>T115-F2115</td> <td></td> </tr> <tr> <td>H</td> <td></td> <td></td> <td></td> </tr> </tbody> </table>		○	○	⊗	P				M				K	T115	T115		N	T115-F2115	T115-F2115		S	T115-F2115	T115-F2115		H			
	○	○	⊗																												
P																															
M																															
K	T115	T115																													
N	T115-F2115	T115-F2115																													
S	T115-F2115	T115-F2115																													
H																															
 <p>.Z57</p>			 <table border="1" data-bbox="1053 1355 1476 1579"> <thead> <tr> <th></th> <th>○</th> <th>○</th> <th>⊗</th> </tr> </thead> <tbody> <tr> <td>P</td> <td></td> <td></td> <td></td> </tr> <tr> <td>M</td> <td></td> <td></td> <td></td> </tr> <tr> <td>K</td> <td>T110</td> <td>T110</td> <td>T110</td> </tr> <tr> <td>N</td> <td>T110</td> <td>T110</td> <td>T110</td> </tr> <tr> <td>S</td> <td></td> <td></td> <td></td> </tr> <tr> <td>H</td> <td></td> <td></td> <td></td> </tr> </tbody> </table>		○	○	⊗	P				M				K	T110	T110	T110	N	T110	T110	T110	S				H			
	○	○	⊗																												
P																															
M																															
K	T110	T110	T110																												
N	T110	T110	T110																												
S																															
H																															
 <p>.G58</p>			 <table border="1" data-bbox="1053 1646 1476 1870"> <thead> <tr> <th></th> <th>○</th> <th>○</th> <th>⊗</th> </tr> </thead> <tbody> <tr> <td>P</td> <td>T1425-F2435</td> <td>T1425-F2435</td> <td></td> </tr> <tr> <td>M</td> <td>T1425-F2435</td> <td>T1425-F2435</td> <td></td> </tr> <tr> <td>K</td> <td>T1425-F2435</td> <td>T1425-F2435</td> <td></td> </tr> <tr> <td>N</td> <td></td> <td></td> <td></td> </tr> <tr> <td>S</td> <td></td> <td></td> <td></td> </tr> <tr> <td>H</td> <td></td> <td></td> <td></td> </tr> </tbody> </table>		○	○	⊗	P	T1425-F2435	T1425-F2435		M	T1425-F2435	T1425-F2435		K	T1425-F2435	T1425-F2435		N				S				H			
	○	○	⊗																												
P	T1425-F2435	T1425-F2435																													
M	T1425-F2435	T1425-F2435																													
K	T1425-F2435	T1425-F2435																													
N																															
S																															
H																															



	DENOMINAZIONI DEGLI INSERTI TAGLIO-SCAN.-FILETTATURA	Pag. 236
	CATALOGO DISPONIBILITÀ INSERTI TAGLIO-SCAN.	Pag. 237
	COME SCEGLIERE I PARAMETRI DI LAVORO	Pag. 243
	PANORAMICA QUALITÀ TAGLIO-SCANALATURA	Pag. 245
	IMPIEGO DELLE QUALITÀ TAGLIO-SCANALATURA	Pag. 246
	VELOCITÀ DI TAGLIO DELLE QUALITÀ TAGLIO-SCAN.	Pag. 248
	CAMPI DI IMPIEGO DEI ROMPIRUCIOLI TAGLIO-SCAN.	Pag. 250

	INSERTS DESIGNATION FOR PARTING-GROOVING-THREADING	Pag. 236
	PARTING-GROOVING INSERTS STOCK CATALOGUE	Pag. 237
	HOW TO CHOOSE CUTTING DATA	Pag. 243
	GENERAL VIEW OF THE PARTING-GROOVING GRADE	Pag. 245
	APPLICATION OF THE PARTING-GROOVING GRADE	Pag. 246
	CUTTING SPEED OF PARTING-GROOVING GRADES	Pag. 248
	FIELDS OF APPLICATION FOR CHIP BREAKERS,PARTING-GROOVING	Pag. 250

	BEZEICHNUNG DER WENDEPLATTEN ZUM ABSTECHE NUNTENDREHEN UND GEWINDESCHNEIDEN	Pag. 236
	AB LAGER LIEFERBARE WENDEPLATTEN ZUM STECH-UND NUTENDREHEN	Pag. 237
	EINSTELLUNG DER SCHNITTDATEN	Pag. 243
	ABSTECHE-NUTENDREHEN-ÜBERSICHT	Pag. 245
	EINSATZ DER ABSTECHE-NUTENDREHEN	Pag. 246
	EINSATZBEREICHE DER SPANBRECHER (VC)	Pag. 248
	SCHNITTGESCHWINDIGKEIT ABSTECHE-NUTENDREHEN	Pag. 250

	DÉNOMINATION DE LES PLAQUETTES POUR LE TRONÇONNAGE-GORGES-FILETAGE	Pag. 236
	CATALOGUE DE DISPONIBILITÉ PLAQUETTES DE TRONÇONNAGE-GORGES	Pag. 237
	COMMENT CHOISIR LES PARAMETRES DE SERVICE	Pag. 243
	VUE D' ENSEMBLE QUALITÉ DE TRONÇONNAGE-GORGES	Pag. 245
	UTILISATION DE LES QUALITÉES DE TRONÇONNAGE-GORGES	Pag. 246
	VITESSE DE COUPE DE LA QUALITÉ DE PLAQUETTES DE TRONÇONNAGE-GORGES	Pag. 248
	CHAMPS D'USINAGE DE LE BRISE-COPEAUX TRONÇONNAGE-GORGES	Pag. 250

INSERTI PER TAGLIO SCANALATURA

PARTING-GROOVING INSERTS / WENDEPLATTEN ZUM A BSTECHEN-NUTENDREHEN
PLAQUÉTTES DE TRONÇONNAGE-GORGES / PLAQUITAS DE CORTE-RANURAS



G	S	G	N
1		2	

14.5	-	0.2	-	3
3		4		5

-	-	-	P
6	7	8	9

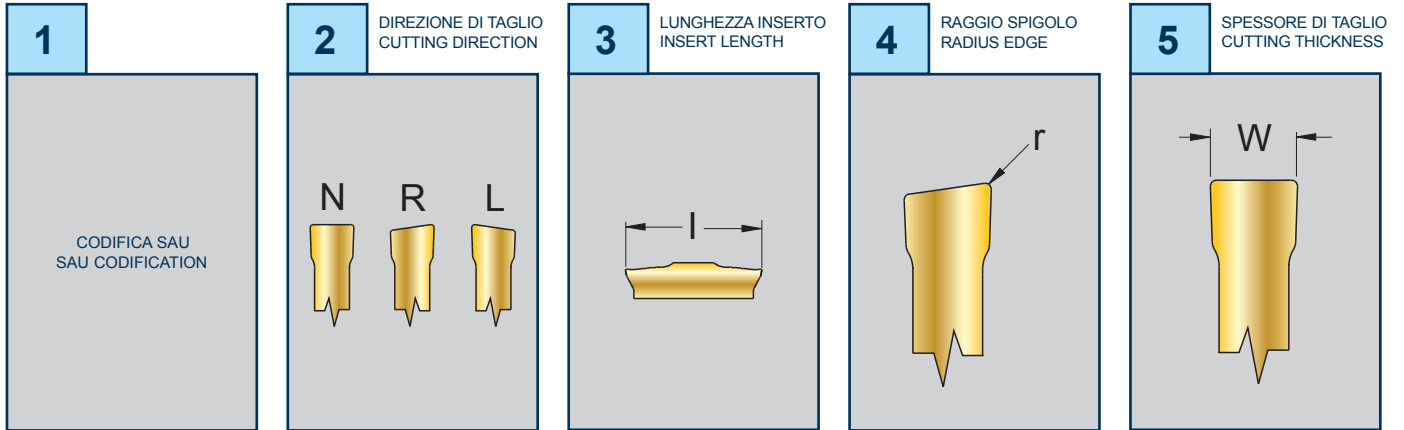

6 LETTERA DI IDENTIF. IDENTIFICATION LETTER

A	N
C	P
D	R
E	S
H	T
I	U
J	W
K	X
L	Y
M	Z

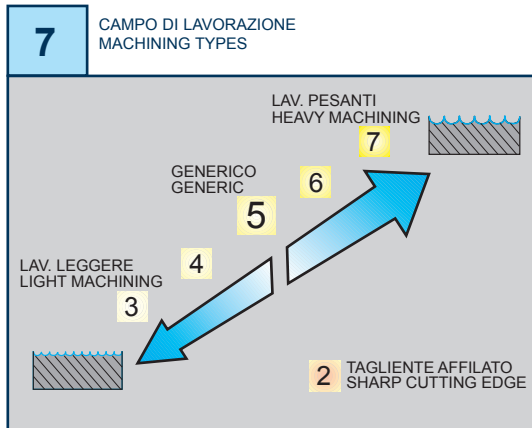

8 PREPARAZIONE TAGLIENTE CUTTING EDGE PREPARATION

1 =	SPECIFICO PER GHISA SPECIFIC FOR CAST IRON
3 =	SPECIFICO PER ACCIAIO INOX SPECIFIC FOR STAINLESS STEEL
7 =	SPECIFICO PER LEGHE DI ALLUMINIO SPECIFIC FOR ALUMINIUM ALLOYS
9 =	SPECIFICO PER ACCIAIO SPECIFIC FOR STEEL
2 =	
4 =	INTERMEDI DI USO GENERICO INTERMEDIATE FOR GENERAL USE
5 =	
6 =	
8 =	

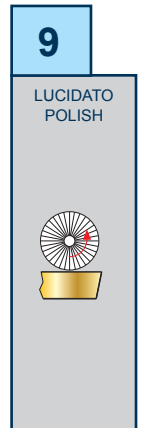

154.15.. 156.15..		G..GN 14,5.. G..TN 14,5..						HW		HC				DP		
								NON RIVESTITI CEMENTED CARBIDE GRADES		RIVESTITI COATED GRADES BESCHICHTET RECOUVERTS				PCD		
ART.	COD.	W	r/s	l	d	M/T	a°/d1	N6315	N3440	F4530	T5735	F4645	F4340	F6315	D3007	
TOLLERANZA W - W TOLERANCE		+0,05 -0,05														
	154.15-16110	1,25	2,5	16,0	9,52	1,2	4,5		■							
	154.15-16130	1,45	2,5	16,0	9,52	1,5	4,5		■							
	154.15-16160	1,80	2,5	16,0	9,52	1,8	4,5		■							
	154.15-16185	2,00	2,5	16,0	9,52	3	4,5		■							
	154.15-16215	2,30	2,8	16,0	9,52	3	4,5		■							
	154.15-16265	2,80	3,3	16,0	9,52	3	4,5		■							
	154.15-16315	3,35	3,8	16,0	9,52	3	4,5		■							
SET 154.15-16110215 N3440		SET 154.15-16110215 F4340														
Contenuto del kit / Content of the kit:		Contenuto del kit / Content of the kit:														
- n°2 154.15-16110 N3440		- n°2 154.15-16110 F4340														
- n°2 154.15-16130 N3440		- n°2 154.15-16130 F4340														
- n°2 154.15-16160 N3440		- n°2 154.15-16160 F4340														
- n°2 154.15-16185 N3440		- n°2 154.15-16185 F4340														
- n°2 154.15-16215 N3440		- n°2 154.15-16215 F4340														
- n°2 154.15-16265 N3440		- n°2 154.15-16265 F4340														
- n°2 154.15-16315 N3440		- n°2 154.15-16315 F4340														
TOLLERANZA W - W TOLERANCE		+0,05 +0,01														
	156.15-16110 .C54	1,10	3	16,0	9,52	3,0	4,5								■	
	156.15-16130 .C54	1,30	3	16,0	9,52	3,0	4,5								■	
	156.15-16160 .C54	1,60	3	16,0	9,52	3,0	4,5								■	
	156.15-16185 .C54	1,85	3	16,0	9,52	3,0	4,5								■	
	156.15-16215 .C54	2,15	3	16,0	9,52	3,0	4,5								■	
	156.15-16265 .C54	2,65	3	16,0	9,52	3,0	4,5								■	
	156.15-16315 .C54	3,15	3,5	16,0	9,52	3,3	4,5								■	
156.15-16415 .C54	4,15	4,5	16,0	9,52	3,3	4,5								■		
	156.15-16110 .C57	1,10	3	16,0	9,52	3,0	4,5	■								
	156.15-16130 .C57	1,30	3	16,0	9,52	3,0	4,5	■								
	156.15-16160 .C57	1,60	3	16,0	9,52	3,0	4,5	■								
	156.15-16185 .C57	1,85	3	16,0	9,52	3,0	4,5	■								
	156.15-16215 .C57	2,15	3	16,0	9,52	3,0	4,5	■								
	156.15-16265 .C57	2,65	3	16,0	9,52	3,0	4,5	■								
	156.15-16315 .C57	3,15	3,5	16,0	9,52	3,3	4,5	■								
156.15-16415 .C57	4,15	4,5	16,0	9,52	3,3	4,5	■									
	GMGN 14.5-0.2-2 .X47	2,0	0,2	14,5	-	1,5	8°								■	
	GMGN 14.5-0.2-3 .X47	3,0	0,2	14,5	-	2,2	8°								■	
	GMGN 14.5-0.4-4 .X47	4,0	0,4	14,5	-	3,2	8°								■	
	GMGN 14.5R1.0-2 .X47	2,0	1,0	14,5	-	1,5	8°								■	
	GMGN 14.5R1.5-3 .X47	3,0	1,5	14,5	-	2,2	8°								■	
	GMGN 14.5R2.0-4 .X47	4,0	2,0	14,5	-	3,2	8°								■	
	GSGN 14.5-0.2-2 .X42	2,0	0,2	14,5	-	1,5	10°			■	■	■				
	GSGN 14.5-0.2-3 .X42	3,0	0,2	14,5	-	2,2	10°			■	■	■				
	GSGN 14.5-0.4-4 .X42	4,0	0,4	14,5	-	3,2	10°			■	■	■				
	GSGN 14.5-0.2-2 .X52	2,0	0,2	14,5	-	1,5	10°			■	■	■				
	GSGN 14.5-0.2-3 .X52	3,0	0,2	14,5	-	2,2	10°			■	■	■				
	GSGN 14.5-0.4-4 .X52	4,0	0,4	14,5	-	3,2	10°			■	■	■				
	GSTN 14.5-0.2-2 .X54	2,0	0,2	14,5	-	1,5	10°			■	■	■				
	GSTN 14.5-0.2-3 .X54	3,0	0,2	14,5	-	2,2	11°			■	■	■				
	GSTN 14.5-0.3-4 .X54	4,0	0,3	14,5	-	3,2	11°			■	■	■				
	GSTN 14.5R1.0-2 .X55	2,0	1,0	14,5	-	1,5	8°			■	■	■				
	GSTN 14.5R1.5-3 .X55	3,0	1,5	14,5	-	2,2	8°			■	■	■				
	GSTN 14.5R2.0-4 .X55	4,0	2,0	14,5	-	3,2	8°			■	■	■				
MATERIALE - MATERIAL - MATERIALIEN - MATÉRIAUX								N6315	N3440	F4530	T5735	F4645	F4340	F6315	D3007	
P	ACCIAIO - STEEL - STAHL - ACIER										●	●	●	●	●	
M	ACCIAIO INOX - STAINLESS STEEL - ROSTFREIER STAHL - ACIER INOXYDABLE										●	○	●	●	●	
K	GHISA - CAST IRON - GRAUGUSS - FONTE GRISE									●	●	●			●	
N	LEGHE DI ALLUMINIO - ALUMINIUM ALLOYS - ALUMINIUM-LEGIERUNGEN - ALLIAGES D'ALUMINIUM								●	●						●
S	LEGHE RESISTENTI AL CALORE - HEAT RESISTANT ALLOYS - WÄRMEBESTÄNDIGE LEGIERUNGEN - ALLIAGES RÉSISSANTES À LA CHALEUR															
H	MATERIALI DURI E TEMPRATI - HARD AND HARDENED MATERIAL - HARTE UND GEHÄRTETE MATERIALIEN - MATERIAUX DURS ET TREMPÉS															

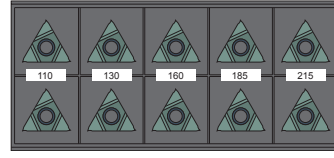

NEW

NEW

GMG.. 25..	ART.	COD.	G..GN 25.. G..TN 25..						HW NON RIVESTITI CEMENTED CARBIDE GRADES				HC RIVESTITI COATED GRADES BESCHICHTET RECOUVERTS				DP PCD											
			W	r	l	T	a°	b°	F4530	F4730 EMZ	T5735	F4645					D3007											
		GMGN 25-0.2-3 .X47	3,0	0,2	25	2,2	8°	-																				
		GMGN 25-0.4-4 .X47	4,0	0,4	25	3,2	8°	-																				
		GMGN 25-0.4-5 .X47	5,0	0,4	25	4,1	8°	-																				
		GMGN 25R1.5-3 .X47	3,0	1,5	25	2,2	8°	-																				
		GMGN 25R2.0-4 .X47	4,0	2,0	25	3,2	8°	-																				
		GMGN 25R2.5-5 .X47	5,0	2,5	25	4,1	8°	-																				
		GMGL 25-0.2-3 .X52	3,0	0,2	25	2,2	10°	6																				
		GMGL 25-0.3-4 .X52 New	4,0	0,3	25	3,2	10°	6																				
		GMGN 25-0.2-3 .X52	3,0	0,2	25	2,2	10°	-																				
		GMGN 25-0.3-4 .X52 New	4,0	0,3	25	3,2	10°	6																				
		GMGR 25-0.2-3 .X52	3,0	0,2	25	2,2	10°	6																				
		GMGR 25-0.3-4 .X52 New	4,0	0,3	25	3,2	10°	6																				
		GSGN 25-0.2-3 .X42	3,0	0,2	25	2,2	11°	-																				
		GSGN 25-0.4-4 .X42	4,0	0,4	25	3,2	11°	-																				
		GSGN 25-0.4-5 .X42	5,0	0,4	25	4,1	10°	-																				
		GSGN 25-0.4-6 .X42	6,0	0,4	25	5,0	10°	-																				
		GSGN 25-0.2-3 .X52	3,0	0,2	25	2,2	11°	-																				
		GSGN 25-0.4-4 .X52	4,0	0,4	25	3,2	11°	-																				
		GSGN 25-0.4-5 .X52	5,0	0,4	25	4,1	10°	-																				
		GSGN 25-0.4-6 .X52	6,0	0,4	25	5,0	10°	-																				
		GSTN 25-0.2-3 .X54	3,0	0,2	25	2,2	11°	-																				
		GSTN 25-0.3-4 .X54	4,0	0,3	25	3,2	11°	-																				
		GSTN 25-0.3-5 .X54	5,0	0,3	25	4,1	10°	-																				
		GSTN 25-0.3-6 .X54	6,0	0,3	25	5,0	10°	-																				
		GSTN 25R1.5-3 .X55	3,0	1,5	25	2,2	8°	-																				
		GSTN 25R2.0-4 .X55	4,0	2,0	25	3,2	8°	-																				
		GSTN 25R2.5-5 .X55	5,0	2,5	25	4,1	8°	-																				
		GSTN 25R3.0-6 .X55	6,0	3,0	25	5,0	8°	-																				
MATERIALE - MATERIAL - MATERIALIEN - MATÉRIAUX																												
P	ACCIAIO - STEEL - STAHL - ACIER																											
M	ACCIAIO INOX - STAINLESS STEEL - ROSTFREIER STAHL - ACIER INOXYDABLE																											
K	GHISA - CAST IRON - GRAUGUSS - FONTE GRISE																											
N	LEGHE DI ALLUMINIO - ALUMINIUM ALLOYS - ALUMINIUM-LEGIERUNGEN - ALLIAGES D'ALUMINIUM																											
S	LEGHE RESISTENTI AL CALORE - HEAT RESISTANT ALLOYS - WÄRMEBESTÄNDIGE LEGIERUNGEN - ALLIAGES RÉSIANTES À LA CHALEUR																											
H	MATERIALI DURI E TEMPRATI - HARD AND HARDENED MATERIAL - HARTE UND GEHÄRTETE MATERIALIEN - MATERIAUX DURS ET TREMPÉS																											

TRLN..									HW		HC	
									NON RIVESTITI CEMENTED CARBIDE GRADES		RIVESTITI COATED GRADES BESCHICHTET RECOUVERTS	
ART.	COD.	W	r	l	T	a°	b°	T116	F4645	T5235		
	TRLN 3.00-0.20N .G52	3,0*	0,2	-	-	0°	-					
	TRLN 4.00-0.30N .G52	4,0*	0,3	-	-	0°	-					
	TRLN 3.00-0.30N .G56	3,0*	0,3	-	-	0°	-					
	TRLN 4.00-0.40N .G56	4,0*	0,4	-	-	0°	-					
	TRLN 3.00-0.30N .G57P	3,0*	0,3	-	-	0°	-	■				
	TRLN 4.00-0.40N .G57P	4,0*	0,4	-	-	0°	-	■				
MATERIALE - MATERIAL - MATERIALIEN - MATÉRIAUX								T116	F4645	T5235		
P	ACCIAIO - STEEL - STAHL - ACIER									●	●	
M	ACCIAIO INOX - STAINLESS STEEL - ROSTFREIER STAHL - ACIER INOXYDABLE									●	○	
K	GHISA - CAST IRON - GRAUGUSS - FONTE GRISE										●	
N	LEGHE DI ALLUMINIO - ALUMINIUM ALLOYS - ALUMINIUM-LEGIERUNGEN - ALLIAGES D'ALUMINIUM								●			
S	LEGHE RESISTENTI AL CALORE - HEAT RESISTANT ALLOYS - WÄRMEBESTÄNDIGE LEGIERUNGEN - ALLIAGES RÉSIDANTES À LA CHALEUR											
H	MATERIALI DURI E TEMPRATI - HARD AND HARDENED MATERIAL - HARTE UND GEHÄRTETE MATERIALIEN - MATERIAUX DURS ET TREMPÉS											

■ DISPONIBILI - IN STOCK - LIEFERBAR - DISPONIBLES / ■ NEW
● APPLICAZIONE CONSIGLIATA-RECOMMENDED APPLICATION-
EMPFOHLENER EINSATZ - APPLICATION CONSEILLÉE

□ A RICHIESTA - ON REQUEST - AUF ANFRAGE - SUR DEMANDE / □ NEW
○ APPLICAZIONE POSSIBILE - POSSIBLE APPLICATION -
MÖGLICHE ANWENDUNG - APPLICATION POSSIBLE

MINI GROOVE (GIE-7..)

IN ESAURIMENTO
END OF STOCK
AUSLAUFEND
EN EPUISEMENT

HW										HC									
NON RIVESTITI CEMENTED CARBIDE GRADES										RIVESTITI COATED GRADES BESCHICHTET RECOUVERTS									

ART.	COD.	W ^{+0,02} ₀	β	R	T	H	S	L											C5PV										
Scanalatura e Taglio Grooving and parting GIE..GP 	GIE - 7 - GP - 1.0 R - N	1,0	-	-	6,0	7	2	17											■										
	GIE - 7 - GP - 1.0 L - N	1,0	-	-	6,0	7	2	17											■										
	GIE - 7 - GP - 1.5 R - N	1,5	-	-	6,0	7	2	17											■										
	GIE - 7 - GP - 1.5 R - R	1,5	-	-	6,0	7	2	17											■										
	GIE - 7 - GP - 1.5 L - N	1,5	-	-	6,0	7	2	17											■										
	GIE - 7 - GP - 1.5 L - R	1,5	-	-	6,0	7	2	17											■										
	GIE - 7 - GP - 1.5 L - L	1,5	-	-	6,0	7	2	17											■										
	GIE - 7 - GP - 2.0 R - N	2,0	-	-	6,0	7	2	17											■										
	GIE - 7 - GP - 2.0 R - R	2,0	-	-	6,0	7	2	17											■										
	GIE - 7 - GP - 2.0 L - N	2,0	-	-	6,0	7	2	17											■										
Tornitura - Turning GIE..ST 	GIE - 7 - ST - 3.0 R	3,17	-	-	-	7	3,17	17											□										
	GIE - 7 - ST - 3.0 L	3,17	-	-	-	7	3,17	17											□										
Scanalatura per anelli Grooving for Rings GIE..SG 	GIE - 7 - SG - 0.5 R	0,50	-	-	2,54	7	2	17											■										
	GIE - 7 - SG - 0.5 L	0,50	-	-	2,54	7	2	17											■										
	GIE - 7 - SG - 0.7 R	0,70	-	-	2,54	7	2	17											■										
	GIE - 7 - SG - 0.7 L	0,70	-	-	2,54	7	2	17											■										
	GIE - 7 - SG - 0.8 R	0,80	-	-	2,54	7	2	17											■										
	GIE - 7 - SG - 0.8 L	0,80	-	-	2,54	7	2	17											□										
	GIE - 7 - SG - 0.9 R	0,90	-	-	2,54	7	2	17											■										
	GIE - 7 - SG - 0.9 L	0,90	-	-	2,54	7	2	17											■										
	GIE - 7 - SG - 1.1 R	1,10	-	-	6,00	7	2	17											■										
	GIE - 7 - SG - 1.1 L	1,10	-	-	6,00	7	2	17											□										
	GIE - 7 - SG - 1.3 R	1,30	-	-	6,00	7	2	17											■										
	GIE - 7 - SG - 1.3 L	1,30	-	-	6,00	7	2	17											■										
	GIE - 7 - SG - 1.6 R	1,60	-	-	6,00	7	2	17											■										
	GIE - 7 - SG - 1.6 L	1,60	-	-	6,00	7	2	17											■										
GIE - 7 - SG - 1.85 R	1,85	-	-	6,00	7	2	17											■											
GIE - 7 - SG - 1.85 L	1,85	-	-	6,00	7	2	17											□											
Scanalatura raggiata e profilatura Radial Grooving and profiling GIE..GR 	GIE - 7 - GR - 1.0 R	1,0	-	0,50	6	7	2	17											■										
	GIE - 7 - GR - 1.0 L	1,0	-	0,50	6	7	2	17											□										
	GIE - 7 - GR - 1.5 R	1,5	-	0,75	6	7	2	17											■										
	GIE - 7 - GR - 1.5 L	1,5	-	0,75	6	7	2	17											■										
	GIE - 7 - GR - 2.0 R	2,0	-	1,00	6	7	2	17											■										
	GIE - 7 - GR - 2.0 L	2,0	-	1,00	6	7	2	17											■										
Filettatura - Threading GIE..GW 	GIE - 7 - GW - 60 R	-	60°	0,10	-	7	2	17											■										
	GIE - 7 - GW - 60 L	-	60°	0,10	-	7	2	17											■										
	GIE - 7 - GW - 55 R	-	55°	0,12	-	7	2	17											■										
	GIE - 7 - GW - 55 L	-	55°	0,12	-	7	2	17											□										

MATERIALE - MATERIAL - MATERIALIEN - MATÉRIAUX

P	ACCIAIO - STEEL - STAHL - ACIER											●										
M	ACCIAIO INOX - STAINLESS STEEL - ROSTFREIER STAHL - ACIER INOXYDABLE											●										
K	GHISA - CAST IRON - GRAUGUSS - FONTE GRISE																					
N	LEGHE DI ALLUMINIO - ALUMINIUM ALLOYS - ALUMINIUM-LEGIERUNGEN - ALLIAGES D'ALUMINIUM																					
S	LEGHE RESISTENTI AL CALORE - HEAT RESISTANT ALLOYS - WÄRMEBESTÄNDIGE LEGIERUNGEN - ALLIAGES RÉSIANTES À LA CHALEUR																					
H	MATERIALI DURI E TEMPRATI - HARD AND HARDENED MATERIAL - HARTE UND GEHÄRTETE MATERIALIEN - MATERIAUX DURS ET TREMPÉS																					

■ DISPONIBILI - IN STOCK - LIEFERBAR - DISPONIBLES / ■ NEW
 ● APPLICAZIONE CONSIGLIATA-RECOMMENDED APPLICATION-
 EMPFOHLENER EINSATZ - APPLICATION CONSEILLÉE

□ A RICHIESTA - ON REQUEST - AUF ANFRAGE - SUR DEMANDE / □ NEW
 ○ APPLICAZIONE POSSIBILE - POSSIBLE APPLICATION -
 MÖGLICHE ANWENDUNG - APPLICATION POSSIBLE

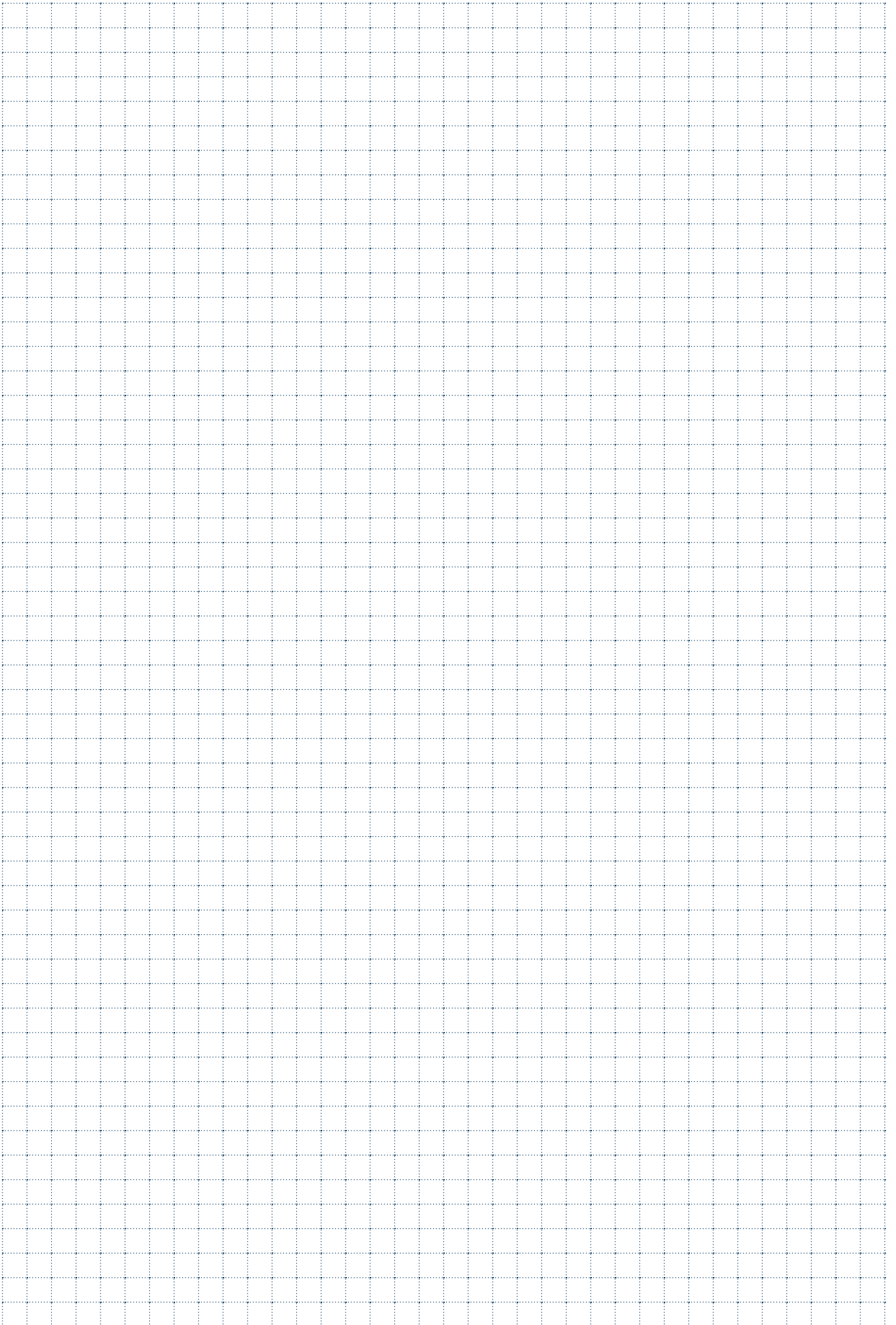

SCelta VELOCE QUICK PICK

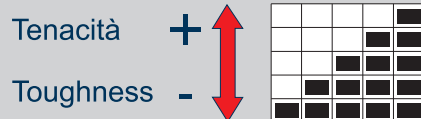

- METODO PER LA SCELTA VELOCE DEL GRADO DI METALLO DURO PIÙ IDONEO. CONTARE IL NUMERO DI RETTANGOLI COLORATI
- METHOD FOR A QUICK CHOICE OF THE MOST SUITABLE SOLID CARBIDE GRADE. COUNT THE NUMBER OF COLORED RECTANGLES
- METHODE ZUR RASCHEN AUSWAHL DER GEEIGNETSTEN HARTMETALLSORTE. DIE ANZAHL DER BUNTEN RECHTECKE ZÄHLEN
- METHODE POUR CHOISIR RAPIDEMENT LE DEGRÉ LE PLUS APPROPRIÉ DU METAL DUR. COMPTER LES RECTANGLES EN COULEURS
- METODO PARA LA ELECCION RAPIDA DE EL GRADO MAS ADECUADO DE METAL DURO. CONTAR LOS NUMEROS DE RECTANGULOS COLORADOS

- GRADO MOLTO RESISTENTE ALL'USURA, SOLO PER FINITURA, LAVORAZIONI AD ALTE VELOCITÀ DI TAGLIO E CONDIZIONI MOLTO RIGIDE E STABILI
- GRADE WITH HIGH RESISTANCE TO WEAR; ONLY FOR FINISHING, MACHINING AT HIGH CUTTING SPEEDS, AND VERY RIGID AND STABLE CONDITIONS
- GRADO CON ALTA RESISTENZA ALL'USURA, DISCRETA TENACITÀ PER LAVORAZIONI A VELOCITÀ MEDIO ALTE ED AVANZAMENTI MEDI, IN CONDIZIONI NORMALI
- GRADE WITH HIGH RESISTANCE TO WEAR, GOOD TOUGHNESS, FOR MEDIUM-HIGH MACHINING AND MEDIUM FEED UNDER NORMAL CONDITIONS
- GRADO CON BUONA RESISTENZA ALL'USURA UNITA A BUONA TENACITÀ, PER LAVORAZIONI GENERICHE IN CONDIZIONI NORMALI
- GRADE WITH GOOD RESISTANCE TO WEAR; COMBINED WITH A GOOD DEGREE OF TOUGHNESS, FOR GENERAL MACHINING UNDER NORMAL CONDITIONS
- GRADO CON OTTIMA TENACITÀ PER LAVORAZIONI MEDIO PESANTI O IN CONDIZIONI POCO STABILI
- GRADE WITH EXCELLENTE TOUGHNESS, FOR MEDIUM HEAVY MACHINING OR MACHINING UNDER CONDITIONS OF LOW STABILITY
- GRADO CON ECCEZIONALE TENACITÀ PER LAVORAZIONI PESANTI CON BASSE VELOCITÀ DI TAGLIO, ALTI AVANZAMENTI O IN CONDIZIONI SFAVOREVOLI
- GRADE WITH EXCELLENTE TOUGHNESS, FOR HEAVY MACHINING WITH LOW CUTTING SPEEDS, HIGH FEED, OR UNDER UNFAVORABLE CONDITIONS

GUIDA FACILE EASY GUIDE

GSTN 25-0.2-3 .X54
F4530

		fn = 0,05-0,15 mm		
		F	M	R
GSTN 25-0.2-3 .X54 F4530		●	○	○
	P	Vc = 80-180 m/min		
	M	Vc = 50-180 m/min		
	K	Vc = 90-160 m/min		
N				
S				
H				

GSTN 25-0.2-3 .X54 - F4530

P25-45 / M25-40 / K25-45

F4530

- GUIDA ALL'USO DELL'INSERTO. PRESENTE ANCHE SU OGNI ETICHETTA
- GUIDE FOR THE USE OF THE INSERT. ALSO LISTED ON EACH LABEL
- LEITFADEN ZUR VERWENDUNG DER WENDEPLATTE, AUCH AUF JEDEM AUFKLEBER VORHANDEN
- INSTRUCTIONS POUR L'UTILISATION DE LA PLAQUETTE. SE TROUVANT EGALEMENT SUR CHAQUE ETIQUETTE
- GUIA POR EL UTILIZO DE LA PLAQUITA, PRESENTE TAMBIEN EN CADA ETIQUETA

GR. VDI 3323 MATERIALI MATERIALS Pag. 1199	6	P	= ACCIAIO BASSO LEGATO HB 180	= LOW STEEL ALLOY
	14.1	M	= ACCIAIO INOSSIDABILE AUSTENITICO HB 180	= AUSTENITIC STAINLESS STEEL HB 180
	16	K	= GHISA GRIGIA HB 260	= GRAY CAST IRON HB 260
	21	N	= LEGHE DI ALLUMINIO HB 60	= ALUMINUM ALLOYS HB 60
	33	S	= LEGHE RESISTENTI AL CALORE (INCONEL) HB 250	= HEAT RESISTANT ALLOYS (INCONEL) HB 250
	38	H	= ACCIAIO TEMPRATO HRC 55	= TEMPERED STEEL HRC 55
	F		= FINITURA, LAVORAZIONI LEGGERE	= FINISHING, LIGHT MACHINING
	M		= LAVORAZIONI MEDIE, IMPIEGO GENERICO	= MEDIUM MACHINING, GENERAL USE
	R		= SGROSSATURA, LAVORAZIONI PESANTI	= ROUGHING, HEAVY MACHINING
	fn (mm)		= AVANZAMENTO PER TORNITURA	= FEED FOR TURNING
	fz (mm/z)		= AVANZAMENTO PER FRESATURA	= FEED FOR MILLING
	Vc (m/min)		= VELOCITÀ DI TAGLIO	= CUTTING SPEED
	●		= APPLICAZIONE CONSIGLIATA	= RECOMMENDED APPLICATION
	○		= APPLICAZIONE POSSIBILE	= POSSIBLE APPLICATION

FASE 3 - PHASE 3

SCelta DELL'AVANZAMENTO
 CHOICE OF FEED
 EINSTELLUNG DES VORSCHUBS
 CHOIX DE L'AVANCEMENT

SAU
 -GMG.. X52
 -GSGN.. X42
 -GMGN.. X47

222

FASE 4 - PHASE 4

SCelta DI VC IN FUNZIONE DEL GR. VDI
 CHOICE OF VC DEPENDING ON VDI GR.
 WAHL VC JE NACH WERKSTOFF
 CHOIX DE VC EN FONCTION DU GR. VDI

SAU
 Vc(m/min)
 Cutting speed of the parting-growing grades
 Vitesse de la vitesse de plaquettes de tronçonnage-gorges

VDI 3323 GR	HB Rm	F4530 T1 NE	N3440	T5735	F4645	F4340	TS235	CSPV	F6315	D3007 NEW
1	125	120-250	110-190	110-190	150-300	130-250	150-180	110-160		
2	180	80-180	110-190	80-150	100-250	110-190	140-190	110-160		
3	250	60-150	110-190	70-140	100-200	70-170	110-130	110-160		
4	220	80-180	110-190	70-140	100-220	120-200	120-190	110-160		
5	300	80-180	110-190	70-140	70-170	110-180	100-120	110-160		
10	200	80-160	110-180	70-120	100-180	110-180	90-120	110-160		
11	350	60-120	110-180	60-100	80-150	90-170	100-130	110-160		
12	200	60-200	120-200	60-100	120-200	120-200	120-140	110-160		
13	330	60-200	200	60-160	60-120	60-100	100-120	110-160		
14.1	180	90-180	70-150	80-160	70-150	100-140	90-120	110-160		
14.2	200-260	60-100	70-150	70-130	70-110	90-120				
15	180	100-200	100-200		90-180	80-120				
16	260	80-160	80-150		80-150	80-120				
17	160	100-180	100-160		100-160	80-120				
18	250	80-160	70-140	100-160	70-140	80-120				
19	130	100-230	80-180	80-150	100-200	80-120				
20	230	80-160	70-160	80-150	80-150	80-120				
21	60	100-800	250-350	100-800					500-950	
22	100	80-800	250-350	80-800					500-950	
23	75	80-500	250-350	80-500					500-950	
24	90		250-350	100-450					400-950	
25	130		250-350	100-450					300-700	
26	110	80-300	250-350	80-400					300-950	
27	90	200-600	250-350	200-600					300-950	
28	100	150-400	250-350	100-300					200-950	
29	90	80-500	250-350	80-500					300-950	
30		100-250	250-350	100-250					300-950	
31	200									
32	280									
33	250									
34	350									
35	320									
36	400									
37	1050									
38	55w/c									
39	60w/c									
40	400									
41	55w/c									

218

DIN ISO 513	P ACCIAI STEELS STAHL ACIERS					M ACCIAI INOSSIDABILI STAINLESS STEELS ROSTFREIER STAHL ACIER INOXYDABLE				K GHISE CAST IRON GRAÜGUSS FONTE GRISE					N NON FERROSI NONFERROUS NICHTEISENMA PAS FERREUX				S MAT.DIFFICILI DIFFICULT MATERIAL SCHWIERIGE MATERIILIEN MAT.DIFICILES					H MATERIALI DURI HARD MATERIALS HARTE MATERIILIEN MATERIAUX DURS								
	01	10	20	30	40	50	10	20	30	40	01	10	20	30	40	01	10	20	30	01	10	20	30	40	01	10	20	30				
HW																																
HC																																
DP																																
TENACITÀ - TOUGHNESS - ZÄHIGKEIT - TÉNACITÉ																																
RESISTENZA ALL'USURA - RESISTANCE TO WEAR - VERSCHLEISSFESTIGKEIT - RÉSISTANCE À L'USURE																																
AVANZAMENTO - FEED - VORSCHUB - AVANCE																																
VELOCITÀ - SPEED - GESCHWINDIGKEIT - VITESSE																																
HT	CERMET					HW				METALLO DURO NON RICOPERTO UNCOATED CARBIDE UNBESCHICHTETES HARTMETALL MÉTAL DUR PAS RECOUVERT					HC				METALLO DURO RICOPERTO COATED CARBIDE BESCHICHTETES HARTMETALL MÉTAL DUR RECOUVERT					DP				DIAMANTE POLICRISTALLINO (PCD) POLYCRYSTALLINE DIAMOND (PCD) POLYKRISTALLINER DIAMANT (PCD) DIAMANT POLYCRISTALLIN (PCD)				



SAU	DIN ISO 513	MATERIALE - MATERIAL MATERIALEN - MATÉRIAUX PAG. 1199						QUICK PICK PAG. 242	 INDICAZIONI - USO
		P	M	K	N	S	H		
		ACCIAI STEELS STAHL ACIER	ACCIAI INOX STAINLESS STEELS ROSTFREIER STAHL ACIER INOXYDABLE	GHISA CAST IRON GRAUGUSS FONTE GRISE	MATERIALI NON FERROSI NON FERROUS MAT. NICHT-EISENMATERIALIEN MAT. FERREUX	MATERIALI DIFFICILI DIFFICULT MATERIAL SCHWERIGE MATERIALIEN MAT. DIFFICILES	MATERIALI DURI HARD MATERIALS HARTE MATERIALIEN MATÉRIAUX DURS		
T116	HW N10-25				●			 Tenacità + Toughness -	 - STRUTTURA OMOGENEA A GRANO FINE - GRANDE STABILITÀ DEL TAGLIENTE - GRANDE RESISTENZA ALL'USURA E ALLA ESCURSIONE TERMICA
N6315	HW N05-25				●			 - QUALITÀ PER LAVORAZIONE DI MATERIALI NON FERROSI	
N3440	HW K20-40 N20-30			●	●			 - QUALITÀ UNIVERSALE PER GHISA E MATERIALI NON FERROSI - OTTIME PRESTAZIONI A UMIDO	
F4530	HC P25-45 M25-40 K25-40 PVD	●	●	●				 - QUALITÀ UNIVERSALE PER VARIE TIPOLOGIE DI MATERIALI - OTTIMO IMPIEGO IN CONDIZIONI DI TAGLIO INTERROTTO O DI LAVORAZIONI IN CONDIZIONI DIFFICILI. - INDICATO PER LAVORAZIONI A BASSE VELOCITÀ DI TAGLIO.	
F4730 NEW	HC P25-45 M25-40 K25-45 PVD	●	○	●				 - QUALITÀ UNIVERSALE PER VARIE TIPOLOGIE DI MATERIALI - OTTIMO IMPIEGO IN CONDIZIONI DI TAGLIO INTERROTTO O DI LAVORAZIONI IN CONDIZIONI DIFFICILI. - INDICATO PER LAVORAZIONI A BASSE VELOCITÀ DI TAGLIO	
T5735	HC P20-45 M20-40 K20-40 CVD	●	○	●				 - RIVESTIMENTO MOLTO RESISTENTE ALL'USURA, EVITA LA FORMAZIONE DI TRUCIOLI DI RIPORTO.	
F4645	HC P20-45 M20-40 PVD	●	●					 - ELEVATA TENACITÀ, PARTICOLARMENTE INDICATO PER LA LAVORAZIONE DI ACCIAIO INOX. - BUON CONTROLLO DELL'USURA E OTTIMO NELL'IMPIEGO DI LAVORAZIONI IN CONDIZIONI DIFFICILI.	
F4340	HC P20-40 M20-30 PVD	●	●					 - PER LA LAVORAZIONE DI ACCIAI E ACCIAI INOSSIDABILI A BASSE VELOCITÀ DI TAGLIO, CON AMPIO CAMPO APPLICATIVO - OTTIME PRESTAZIONI A UMIDO	
T5235	HC P20-45 K20-40 CVD	●		●				 - ALTA RESISTENZA ALL'USURA, ALL'OSSIDAZIONE E BUONA TENACITÀ. - PERFORMANTE ANCHE AD ALTE VELOCITÀ DI TAGLIO	
C5PV	HC P30-45 M30-40 PVD	●	●					 - ELEVATA TENACITÀ - INDICATO PER BASSE VELOCITÀ DI TAGLIO ANCHE NELLA TRONCATURA FINO AL CENTRO E PER LAVORAZIONI A TAGLIO INTERROTTO	
F6315	HC P10-30 M05-25 K05-25 PVD	●	●	●				 - OTTIMA RESISTENZA ALL'USURA - QUALITÀ UNIVERSALE PER VARI TIPI DI MATERIALE - INDICATO PER MEDIE-ALTE VELOCITÀ DI TAGLIO	
D3007	DP N01-10				●			 - GRADO INDICATO PER SCANALATURA SU LAVORAZIONI DI MATERIALI NON FERROSI, ES. LEGHE DI ALLUMINIO, MEGLIO SE AD ALTO TENORE DI SILICIO, RAME, BRONZO TERMOPLASTICI RINFORZATI E COMPOSITI. - OTTIMA FINITURA E VITA UTENSILE.	

● APPLICAZIONE CONSIGLIATA
RECOMMENDED APPLICATION
EMPFOHLENER EINSATZ
APPLICATION CONSEILLÉE

○ APPLICAZIONE POSSIBILE
POSSIBLE APPLICATION
MÖGLICHE ANWENDUNG
APPLICATION POSSIBLE

● APPLICAZIONE CONSIGLIATA
RECOMMENDED APPLICATION
EMPFOHLENER EINSATZ
APPLICATION CONSEILLÉE

○ APPLICAZIONE POSSIBILE
POSSIBLE APPLICATION
MÖGLICHE ANWENDUNG
APPLICATION POSSIBLE

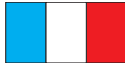
 INDICATIONS - USE	 GEBRAUCHSANWEISUNGEN	 INDICATION - USAGE
<ul style="list-style-type: none"> - HOMOGENEOUS FINE-GRAIN STRUCTURE - HIGH CUTTING-EDGE STABILITY - HIGH WEAR AND THERMAL SHOCK RESISTANCE 	<ul style="list-style-type: none"> - HOMOGENE FEINKORNSTRUKTUR - HOHE STABILITÄT DER SCHNEIDE - HOHER WIDERSTAND GEGEN VERSCHLEISS UND TEMPERATURSCHWANKUNGEN 	<ul style="list-style-type: none"> - STRUCTURE HOMOGENE A GRAIN FIN - GRANDE STABILITE DU TRANCHANT - HAUTE RESISTANCE A L'USURE ET A L'AMPLITUDE THERMIQUE
<ul style="list-style-type: none"> - DEGREE FOR NON-FERROUS MATERIALS 	<ul style="list-style-type: none"> - SORTE FÜR NICHEISENMATERIALIEN 	<ul style="list-style-type: none"> - QUALITE POUR L'USINAGE DE MATERIAUX NON FERREUX
<ul style="list-style-type: none"> - ALL-PURPOSE QUALITY FOR CAST IRON AND NON-FERROUS MATERIALS - EXCELLENT WET PERFORMANCE 	<ul style="list-style-type: none"> - UNIVERSALE QUALITÄT FÜR GUSS UND NICHEISENMATERIALIEN - AUSGEZEICHNETE NASSLEISTUNGEN 	<ul style="list-style-type: none"> - QUALITÉ UNIVERSELLE POUR FONTE ET MATÉRIAUX NON FERREUX - PERFORMANCES EXCEPTIONNELLES À L'EAU
<ul style="list-style-type: none"> - UNIVERSAL GRADE FOR VARIOUS TYPES OF MATERIALS - EXCELLENT PERFORMANCE UNDER INTERRUPTED OR DIFFICULT CUTTING CONDITIONS - SUITABLE FOR MACHINING WITH LOW CUTTING SPEED 	<ul style="list-style-type: none"> - UNIVERSALE SORTE FÜR VERSCHIEDENE MATERIALIEN - SEHR GUTE LEISTUNGSFÄHIGKEIT MIT UNTERBROCHENEM SCHNITT ODER BEARBEITUNG UNTER SCHWIERIGEN BEDINGUNGEN - FÜR BEARBEITUNGEN MIT NIEDRIGEN SCHNITTGESCHWINDIGKEITEN GEEIGNET. 	<ul style="list-style-type: none"> - QUALITÉ UNIVERSELLE POUR DIFFÉRENTES TYPOLOGIES DE MATÉRIAUX - EMPLOI PARFAIT DANS DES CONDITIONS DE COUPE INTERROMPUE OU D'USINAGES DANS DES CONDITIONS DIFFICILES. - INDIQUÉ POUR LES USINAGES À DE FAIBLES VITESSES DE COUPE.
<ul style="list-style-type: none"> - UNIVERSAL GRADE FOR VARIOUS MATERIAL TYPES - EXCELLENT PERFORMANCE IN INTERRUPTED CUTTING OPERATIONS OR UNDER CHALLENGING MACHINING CONDITIONS - SUITABLE FOR LOW CUTTING SPEED 	<ul style="list-style-type: none"> - UNIVERSALSORTE FÜR UNTERSCHIEDLICHE MATERIALTYPEN - BESTENS GEEIGNET FÜR ANWENDUNGEN MIT UNTERBROCHENEM SCHNITT ODER UNTER ANSPRUCHSVOLLEN BEARBEITUNGSBEDINGUNGEN - GEEIGNET FÜR NIEDRIGE SCHNITTGESCHWINDIGKEITEN 	<ul style="list-style-type: none"> - QUALITÉ UNIVERSELLE POUR PLUSIEURS TYPOLOGIES DE MATÉRIAUX - UTILISATION PARFAITE DANS DES CONDITIONS DE COUPE INTERROMPUE OU D'USINAGES DANS DES CONDITIONS DIFFICILES. - INDIQUÉ POUR DES USINAGES À BASSE VITESSE DE COUPE
<ul style="list-style-type: none"> - COATING WITH HIGH RESISTANCE TO WEAR, PREVENTS CHIP BUILD-UP 	<ul style="list-style-type: none"> - BESCHICHTUNG MIT HOHER VERSCHLEISSBESTÄNDIGKEIT, VERMEIDET SPANAUFBAU 	<ul style="list-style-type: none"> - REVETEMENT TRÈS RÉSISTANT A L'USURE, EVITE LA FORMATION DE COPEAUX DE REPORT.
<ul style="list-style-type: none"> - CONSIDERABLE TOUGHNESS, PARTICULARLY SUITABLE FOR STAINLESS STEEL - GOOD WEAR CONTROL AND EXCELLENT PERFORMANCE UNDER DIFFICULT MACHINING CONDITIONS 	<ul style="list-style-type: none"> - HOHE ZÄHIGKEIT, BESONDERS FÜR DIE BEARBEITUNG VON EDELSTAHL GEEIGNET. - GUTE VERSCHLEISSKONTROLLE UND BESTENS GEEIGNET ZUR BEARBEITUNG UNTER SCHWIERIGEN BEDINGUNGEN 	<ul style="list-style-type: none"> - TÉNACITÉ ÉLEVÉE, PARTICULIÈREMENT INDIQUÉ POUR L'USINAGE D'ACIER INOX. - BON CONTRÔLE DE L'USURE ET PARFAIT DANS L'EMPLOI D'USINAGES DANS DES CONDITIONS DIFFICILES.
<ul style="list-style-type: none"> - FOR MACHINING STEELS AND STAINLESS STEELS AT SLOW CUTTING SPEEDS FOR A VAST RANGE OF APPLICATIONS - EXCELLENT WET PERFORMANCE 	<ul style="list-style-type: none"> - FÜR DIE BEARBEITUNG VON STAHL UND EDELSTAHL MIT NIEDRIGER SCHNITTGESCHWINDIGKEIT, GROSSER ANWENDBEREICH - AUSGEZEICHNETE NASSLEISTUNGEN 	<ul style="list-style-type: none"> - POUR L'USINAGE D'ACIERS ET ACIERS INOXYDABLES À DE FAIBLES VITESSES DE COUPE, AVEC AMPLIE PLAGE D'APPLICATION - PERFORMANCES EXCEPTIONNELLES À L'EAU
<ul style="list-style-type: none"> - HIGH RESISTANCE TO WEAR, OXIDATION AND GOOD TOUGHNESS - EXCELLENT PERFORMANCE ALSO WITH HIGH CUTTING SPEED 	<ul style="list-style-type: none"> - HOHE VERSCHLEISS- UND OXIDATIONSFESTIGKEIT UND GUTE ZÄHIGKEIT - HOHE LEISTUNGSFÄHIGKEIT AUCH BEI HOHEN SCHNITTGESCHWINDIGKEITEN 	<ul style="list-style-type: none"> - HAUTE RÉSISTANCE À L'USURE, À L'OXYDATION ET BONNE TÉNACITÉ. - PERFORMANT MÊME À DE HAUTES VITESSES DE COUPE.
<ul style="list-style-type: none"> - HIGH TOUGHNESS - SUITABLE FOR LOW CUTTING SPEEDS EVEN WHEN CUTTING TO THE CENTER AND EVEN FOR DISCONTINUOUS CUTS MACHINING 	<ul style="list-style-type: none"> - HOHE ZÄHIGKEIT - FÜR NIEDRIGE SCHNITTGESCHWINDIGKEITEN, AUCH BEIM TRENNEN BIS ZUM ZENTRUM, GEEIGNET UND GROSSE VORSCHÜBE 	<ul style="list-style-type: none"> - HAUTE TENACITÉ - INDIQUÉE POUR FAIBLE VITESSE DE COUPE, MÊME POUR TRONÇONNAGE JUSQU'AU CENTRE ET POUR COUPE INTERROMPU
<ul style="list-style-type: none"> - EXCELLENT RESISTANCE TO WEAR - UNIVERSAL DEGREE FOR DIFFERENT TYPES OF MATERIALS - SUITABLE FOR MEDIUM TO HIGH CUTTING SPEEDS 	<ul style="list-style-type: none"> - SEHR HOHE VERSCHLEISSFESTIGKEIT - UNIVERSALSORTE FÜR VERSCHIEDENE MATERIALIEN - FÜR MITTLERE BIS HOHE SCHNITTGESCHWINDIGKEITEN GEEIGNET 	<ul style="list-style-type: none"> - RESISTANCE EXCELLENTE A L'USURE - QUALITE UNIVERSELLE POUR DIFFERENTS TYPES DE MATERIAU - INDIQUÉ EN CAS DE VITESSES DE COUPE HAUTES-MOYENNES
<ul style="list-style-type: none"> - GROOVING GRADE FOR NON-FERROUS MATERIALS, SUCH AS ALUMINUM ALLOYS, PREFERABLY WITH HIGH SILICON, COPPER, BRONZE CONTENT, REINFORCED THERMOPLASTIC MATERIALS AND COMPOUNDS - EXCELLENT FINISHING AND TOOL LIFE 	<ul style="list-style-type: none"> - SORTE ZUM NUTENDREHEN FÜR NICHT-EISENMATERIALIEN, Z.B. ALUMINIUM-LEGIERUNGEN, VORZUGSWEISE MIT HOHEM SILIZIUM-, KUPFER- UND BRONZEGEHALT, VERSTÄRKTE THERMOPLASTE UND VERBUNDMATERIALIEN - HERVORRAGENDE OBERFLÄCHENGÜTE UND WERKZEUGSTANDZEIT 	<ul style="list-style-type: none"> - DEGRÉ INDIQUÉ POUR RAINURE SUR USINAGES DE MATÉRIAUX NON FERREUX, TELS QUE ALLIAGES D'ALUMINIUM, AUTANT QUE POSSIBLE À TENEUR ÉLEVÉE DE SILICIUM, CUIVRE, BRONZE, THERMOPLASTIQUES RENFORCÉS ET COMPOSITES. - FINITION ET VIE DE L'OUTIL EXCELLENTE

HT CERMET

HW

METALLO DURO NON RICOPERTO
UNCOATED CARBIDE
UNBESCHICHTETES HARTMETALL
MÉTAL DUR PAS RECOUVERT

HC

METALLO DURO RICOPERTO
COATED CARBIDE
BESCHICHTETES HARTMETALL
MÉTAL DUR RECOUVERT

DP

DIAMANTE POLICRISTALLINO (PCD)
POLYCRYSTALLINE DIAMOND (PCD)
POLYKRISTALLINER DIAMANT (PCD)
DIAMANT POLYCRISTALLIN (PCD)

MATERIALE MATERIAL MATERIALIEN MATERIAUX PAG 1199	VDI 3323 GR.	HB HRC Rm	T116	N6315	N3440	F4530	F4730 NEW	T5735	F4645	F4340	T5235	C5PV	F6315
P ACCIAI STEELS STAHL ACIER	1	125				120-250	120-250	110-190	110-190	150-300	130-250	150-180	110-160
	2	180				80-180	80-180	110-190	80-150	100-250	110-190	140-150	110-160
	3	250				60-150	60-150	110-190	70-140	100-200	70-170	110-130	110-160
	4	220				80-180	80-180	110-190	70-140	100-220	120-200	120-150	110-160
	5	300				80-180	80-180	110-190	70-140	70-170	110-180	100-120	110-160
	6	180				80-180	80-180	110-180	70-140	100-220	120-200	120-130	110-160
	7-8	250-300				60-150	60-150	110-180	70-120	100-180	110-180	90-120	110-160
	9	350				60-120	60-120	110-180	60-120	100-160	70-150	80-90	110-160
	10	200				80-160	80-160	70-160	60-100	90-150	90-170	100-130	110-160
	11	350				50-120	50-120	70-160	60-100	70-150	70-160	80-90	110-160
	12	200				50-200	50-200	120-200	60-100	120-250	120-200	120-140	110-160
	13	330				50-200	50-200	120-200	60-180	60-120	60-100	100-120	110-160
	M ACCIAI INOX STAINLESS STEELS ROSTFREIER STAHL ACIER INOXYDABLE	14.1	180				50-180	50-180	100-200	70-150	80-160		100-140
14.2		230-260				50-100	50-100	60-110	60-110	70-130		70-110	90-120
K GHISA CAST IRON GRAUGUSS FONTE GRISE	15	180			100-200	100-200	100-200	90-180			90-180		80-120
	16	260			90-150	90-160	90-160	90-180			80-150		80-120
	17	160			100-180	100-180	100-180	100-160			100-160		80-120
	18	250			70-140	80-160	80-160	100-160			70-140		80-120
	19	130			90-180	100-230	100-230	80-150			100-200		80-120
	20	230			70-160	80-160	80-160	80-150			80-150		80-120
N MATTONI FERROSI NON FERROUS MAT. NICHT-EISENMATERIALIEN MAT. FERREUX	21	60	100-800	250-350	100-800								
	22	100	80-800	250-350	80-800								
	23	75	80-500	250-350	80-500								
	24	90		250-350	100-450								
	25	130		250-350	100-450								
	26	110	80-300	250-350	80-400								
	27	90	200-600	250-350	200-600								
	28	100	150-400	250-350	100-300								
	29		80-500	250-350	80-500								
	30		100-250	250-350	100-250								
S MAT DIFFICILI DIFFICULT MATERIAL SCHWIERIGE MATERIALIEN MAT. DIFFICILES	31	200											
	32	280											
	33	250											
	34	350											
	35	320											
	36	Rm400											
	37	Rm1050											
H MATERIALI DURI HARD MATERIALS HARTE MATERIALIEN MATERIAUX DURS	38	55HRC											
	39	60HRC											
	40	400											
	41	55HRC											

MATERIALE MATERIAL MATERIALIEN MATÉRIAUX PAG 1199	VDI 3323 GR.	HB HRC Rm	D3007																									
P ACCIAI STEELS STAHL ACIER	1	125																										
	2	180																										
	3	250																										
	4	220																										
	5	300																										
	6	180																										
	7-8	250-300																										
	9	350																										
	10	200																										
	11	350																										
	12	200																										
	13	330																										
	M ACCIAI INOX STAINLESS STEELS ROSTFREIER STAHL ACIER INOXYDABLE	14.1	180																									
14.2		230-260																										
K GHISA CAST IRON GRAUGUSS FONTE GRISE	15	180																										
	16	260																										
	17	160																										
	18	250																										
	19	130																										
	20	230																										
N MAT.NON FERROSI NONFERROUS MAT. NICHT-EISENMATERIALIEN MAT. FERREUX	21	60	500-950																									
	22	100	500-950																									
	23	75	500-950																									
	24	90	400-950																									
	25	130	300-700																									
	26	110	300-950																									
	27	90	300-950																									
	28	100	200-950																									
	29		300-950																									
	30		300-950																									
S MAT.DIFFICILI DIFFICULT MATERIAL SCHWIERIGE MATERIALIEN MAT. DIFICILES	31	200																										
	32	280																										
	33	250																										
	34	350																										
	35	320																										
	36	Rm400																										
	37	Rm1050																										
H MATERIALI DURI HARD MATERIALS HARTE MATERIALIEN MATÉRIAUX DURS	38	55HRC																										
	39	60HRC																										
	40	400																										
	41	55HRC																										

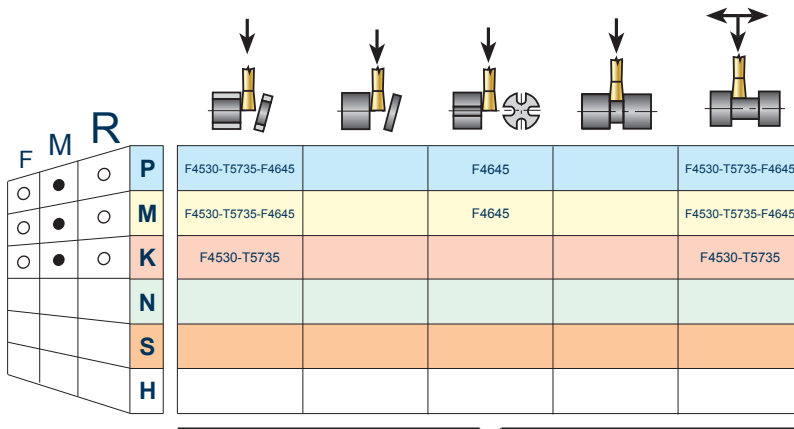
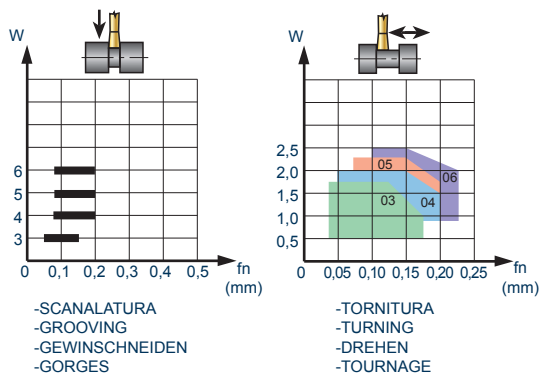

GRADI CONSIGLIATI - RECOMMENDED GRADES - EMPFOHLENE SORTEN - DEGRÉS CONSEILLÉS

F =	FINITURA, LAV. LEGGERE	FINISHING,LIGHT MACHING	SCHLICHTEN,LEICHTE BEARBEITUNG	FINISSAGE,USINAGES LÉGERES
M =	GENERICO, LAV. MEDIE	GENERIC MEDIUM MACHINING	ALLGEMEIN,MITTELSCHWERE BEARBEITUNG	GENERAL,USINAGES MOYENS
R =	SGROSSATURA, LAV. PESANTI	ROUGHING, HEAVY MACHINING	SCHRUPPEN,SCHWERE BEARBEITUNG	DEGROSSISAGES,USINAGES LOURDS
P,M,K,N,S,H =	MATERIALI ISO PAG 1199	ISO MATERIALS PAGE 1199	ISO-MATEREIALIEN, SEITE 1199	MATERIAUX ISO PAG 1199
	TRONCATURA TUBI	PARTING OF PIPES	ROHRABSTECHEN	TRONÇONNAGE TUYAUX
	TRONCATURA BARRE	PARTING OF BARS	STANGENABSTECHEN	TRONÇONNAGE BARRES
	TRONCATURE DIFFICILI	DIFFICULT PARTING OPERATION	SCHWIERIGES ABSTECHEN	TRONÇONNAGE DIFFICILES
	SCANALATURA	GROOVING	NUTENDREHEN	RAINURER
	SCANALATURA-TORNITURA	GROOVING-TURNING	NUTENDREH-DREHWERKZEUGE	RAINURER-TOURNAGE
	APPLICAZIONE CONSIGLIATA	RECOMMENDED APPLICATION	EMPFOHLENER EINSATZ	APPLICATION CONSEILLÉE
	APPLICAZIONE POSSIBILE	POSSIBLE APPLICATION	MOGLICHE ANWENDUNG	APPLICATION POSSIBLE
fn (mm) =	AVANZAMENTO AL GIRO	FEED/REVOLUTION	VORSCHUB PRO UMDREHUNG	DÉPLACEMENT AU TOUR
W (mm) =	LARGHEZZA TAGLIENTE	CUTTING EDGE WIDTH	SCHNITTBREITE	LARGEUR DU TRANCHANT

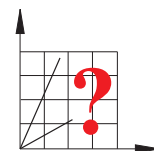

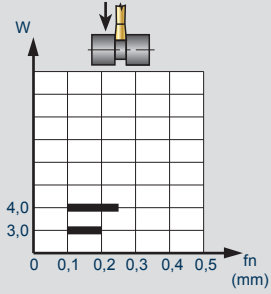

**-TRLN..
.G52**

	F	M	R	
○	●	●		P
				M
○	●	●		K
				N
				S
				H

T5235-F4645	T5235-F4645	T5235-F4645	T5235-F4645	
T5235	T5235	T5235	T5235	

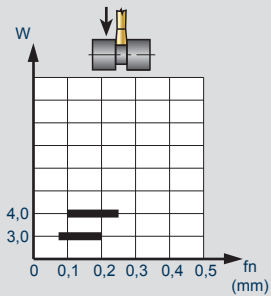
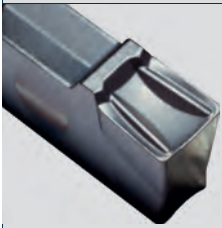

**-TRLN..
.G56**

	F	M	R	
○	●	●		P
				M
○	●	●		K
				N
				S
				H

T5235-F4645	T5235-F4645	T5235-F4645	T5235-F4645	T5235-F4645
T5235	T5235	T5235	T5235	T5235

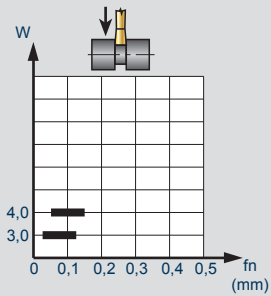
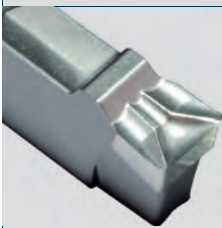

**-TRLN..
.G57P**

	F	M	R	
				P
				M
				K
●	●	○		N
				S
				H

T116	T116	T116	T116	



**-GSGN..
.X42**

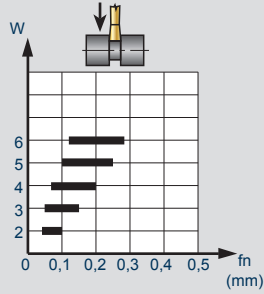

	F	M	R	
P	●	○		
M	●	○		
K	●	○		
N				
S				
H				

F4530-T5735-F4645	F4530-T5735-F4645	F4645	F4530-T5735-F4645	
F4530-T5735-F4645	F4530-T5735-F4645	F4645	F4530-T5735-F4645	
F4530-T5735	F4530-T5735		F4530-T5735	

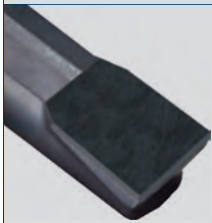

**-GMGN..
.X47**

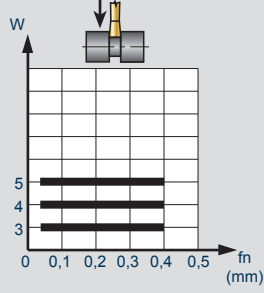

	F	M	R	
P				
M				
K				
N	●	●		
S				
H				

	D3007		D3007	



**-GMG..
.X52**

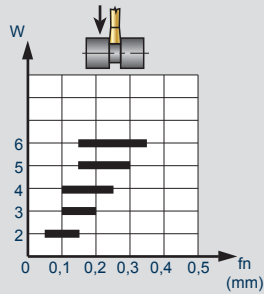

	F	M	R	
P	●	○		
M	●	○		
K	●	○		
N				
S				
H				

F4530-T5735-F4645-F4730	F4530-T5735-F4645-F4730	F4645-F4730	F4530-T5735-F4645-F4730	
F4530-T5735-F4645-F4730	F4530-T5735-F4645-F4730	F4645-F4730	F4530-T5735-F4645-F4730	
F4530-T5735-F4730	F4530-T5735-F4730		F4530-T5735-F4730	

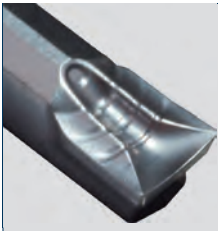

**-GSTN..
.X54**

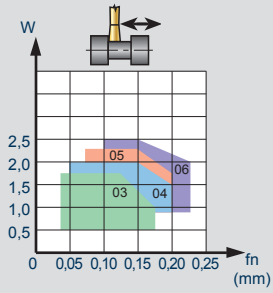
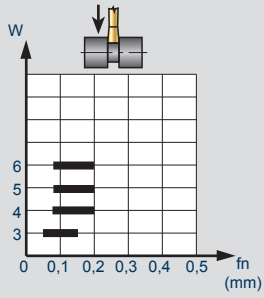

	F	M	R	
○	●	○	○	P
○	●	○	○	M
○	●	○	○	K
				N
				S
				H

			F4645		F4530-T5735-F4645
			F4645		F4530-T5735-F4645
					F4530-T5735

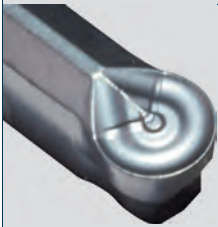

**-GSTN..
.X55**

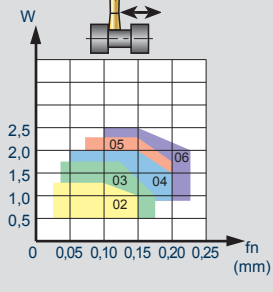
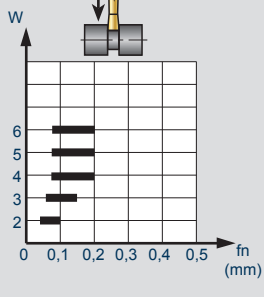

	F	M	R	
○	●	○	○	P
○	●	○	○	M
○	●	○	○	K
				N
				S
				H

				F4530-T5735-F4645	F4530-T5735-F4645
				F4530-T5735-F4645	F4530-T5735-F4645
				F4530-T5735	F4530-T5735

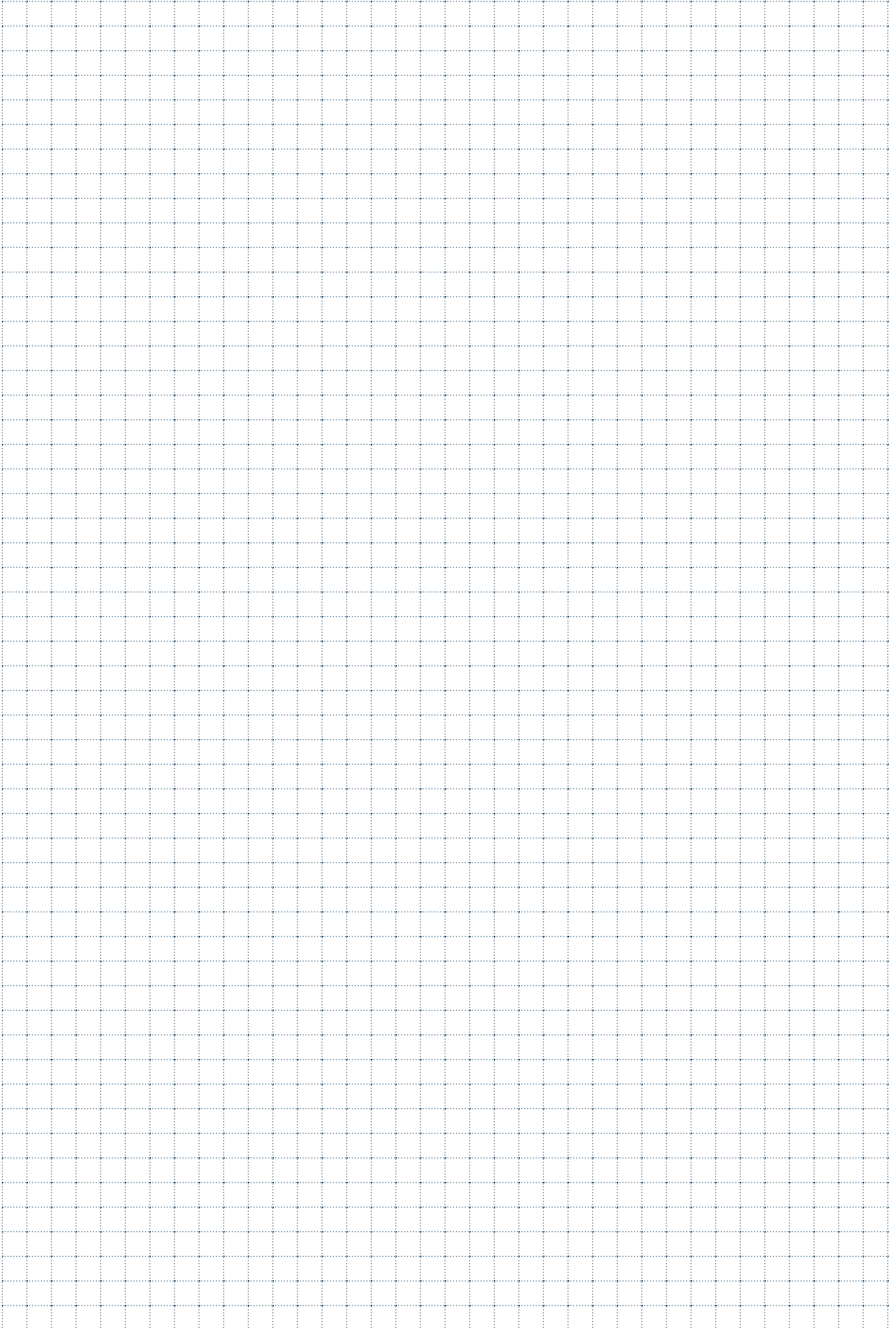















FRESATURA

MILLING / FRÄSEN / FRAISAGE / FRESADO



	FRESE INTEGRALI IN METALLO DURO	
	SOLID CARBIDE MILLING CUTTERS	
	HM FRÄSER	
	FRAISES EN CARBURE MONOBLOC	
	FRESAS INTEGRALES EN METAL DURO	





Pag. 259

	FRESE PER SPIANATURA E SMUSSI	
	FACE AND CHAMFERRING MILLING CUTTERS	
	FRÄSER ZUM PLANEN UND ZUM FASEN	
	FRAISES À SURFACER ET ARRONDIR	
	FRESAS PARA PLANEAR Y BISELES	







Pag. 430

	FRESE PER SPALLAMENTI	
	SHOULDER MILLING CUTTERS	
	ECKFRAESER	
	FRAISES À DRESSER	
	FRESAS PARA ESCUADRAR	





Pag. 446

	ELIFRESE-FRESE PER SCANALATURA FRESE FORANTI	
	HELICAL END MILLS-GROOVING END MILLS DRILLING END MILLS	
	SCHAFTSCHRUPPFÄSER ZUM NUTENFRÄSEN BORHNUTENFRÄSER, SCHEIBENFRÄSER	
	FRAISES HÉLICOÏDALES-FRAISES À CANNELER FRAISES À PERCER	
	FRESA HELICOIDALES-FRESAS PARA RANURAS FRESAS TALADRADORAS	















Pag. 482

	FRESE PER COPIATURA	
	COPY MILLING CUTTERS	
	KOPIERFRAESER	
	FRAISE À COPIAGE	
	FRESAS COPIADORAS	

Pag. 500

	INSERTI PER FRESATURA	
	MILLING INSERTS	
	WENDEPLATTEN ZUM FRÄSEN	
	PLAQUÉTTES DE FRAISAGE	
	PLAQUITAS DE FRESADO	

Pag. 523

	ART.	LUNGHEZZA FRESE MILLING CUTTER LENGTH	SPIGOLO FRESE CORNER SHAPE	ØD	Z	ANGOLO ELICA ANGLE FLUTES	Materiali - Materials Pag. 1199							Pag.
							P	M	K	N	S	H	G	
MICROFRESE - MICRO-MILLS														
BLACK	 ST2201			90°	0,4-3	2	30°	●	○	●	●			266
	 STN2201			90°	0,4-3	2	30°	●	○	●	●			268
BLACK	 ST2205			R	0,4-3	2	30°	●	○	●	○			270
	 STN2205			R	0,4-3	2	30°	●	○	●	○			272
FRESE PER ALLUMINIO - MILLING CUTTERS FOR ALUMINIUM														
	 SM1200			90°	1-6	1	30°			●				276
	 SM1300			90°	2-16	1	30°			●				278
SILVER	 SMW2317			90°	4-20	2	55°			●				280
	 SMW2317..N01			90°	3-20	2	55°			●				282
	 SM2315..N01			R	8-25	2	30°			●				284
SILVER	 SM2417			R	4-12	2	40°			●				286
	 SM2417..01			R	3-12	2	40°			●				288
	 SM3315..N01			R	6-16	3	43°-45°			●				290
SILVER	 SM3417			90°	6-25	3	45°			●				292
	 SM3417..N01			90°	6-25	3	45°			●				294
GOLD	 SMW3414			90°	8-25	3	40°			●				296
	 SMW3414..N01			90°	8-25	3	40°			●				298
HSC	 SM3510			45°	4-20	3	43°-45°			●				300
HSC	 SM3510..N01			45°	4-20	3	43°-45°			●				302

	ART.	LUNGHEZZA FRESA MILLING CUTTER LENGTH	SPIGOLO FRESA CORNER SHAPE	ØD	Z	ANGOLO ELICA ANGLE FLUTES	Materiali - Materials Pag. 1199							Pag.
							P	M	K	N	S	H	G	
2 TAGLI - 2 CUTTINGS														
	BLACK		SMW2200		90°	2-20	2	30°	●	●	●		○	306
	BLACK		SMW2300		90°	2-20	2	30°	●	●	●		○	308
	BLACK		SMW2203		R	2,5-20	2	30°	●	●	●		○	310
	BLACK		SM2203		R	2,5-20	2	30°	●	●	●		○	312
HSC	GRAY		SM2424		R	2-12	2	30°	●	●	●	●	○	314
3 TAGLI - 3 CUTTINGS														
	BLACK		SMW3100		90°	2-20	3	30°	●	●	●		○	318
WMN	BLACK		SM3100		90°	2-20	3	30°	●	●	●		○	320
	RED		SMW3231		90°	2-20	3	30°	●	●	●		○	322
	BLACK		SMW3300		90°	2-20	3	30°	●	●	●		○	324
4/6/8 TAGLI - 4/6/8 CUTTINGS														
	BLACK		SMW4300		90°	5,5-20	4	30°	●	●	●		○	328
	BLACK		SM4300		90°	2-20	4	30°	●	●	●		○	330
	BLACK		SMW4400		90°	3-20	4	30°	●	●	●		○	332
	BLACK		SMW4402		45°	2-20	4	45°	●	●	●		○	334
HSC	GRAY		SM4330		45°	4-20	4	52°	●	●	●	●	○	336
	GRAY		SMW4304		90°	3-20	4	25°	●	●	●			338
	GRAY		SMW3304		90°	4-25	3-4 5-6	45°	●	●	●	●		340
	GRAY		SMW4404		90°	6-20	4	45°	●	●	●	●		342
	GRAY		SM4325		R	3-20	4	30°	●	○	○		○	344
HSC	GRAY		SM4215		R	2-16	4	30°	●	○	○		○	346

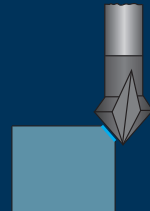

			ART.	LUNGHEZZA FRESE MILLING CUTTER LENGTH	SPIGOLO FRESE CORNER SHAPE	ØD	Z	ANGOLO ELICA ANGLE FLUTES	Materiali - Materials Pag. 1199							Pag.	
									P	M	K	N	S	H	G		
4/6/8 TAGLI - 4/6/8 CUTTINGS																	
	GRAY		SM4525			3-20	4	30°	●	○	○				●	○	348
	BLACK		SMW4403			3-20	4	30°	●	●	●					○	350
	GRAY		SM6402			4-20	6-8	45°	●	●	●	●	●			○	352
	GRAY		SM6502			4-20	6-8	45°	●	●	●	●	●			○	354
	GRAY		SM6432			4-20	6-8	52°	●						●	○	356
	GRAY		SM6532			6-20	6-8	52°	●						●	○	358
	ORANGE		SM7215..TI			6-16	5-9	38°	○	●			●		○		360
ELICA CON ANGOLO VARIABILE - HELIX WITH VARIABLE ANGLE																	
HSC	GRAY		SMW3400			3-20	3	45°-48°	●	○	●				○	○	364
	ORANGE		SMW3400..TI			3-20	3	45°-48°	○	●			●		○		366
HSC	GRAY		SM3415			3-20	3	45°-48°	●	○	●				○	○	368
	ORANGE		SM3415..TI			3-20	3	45°-48°	○	●			●		○		370
	GRAY		SM3515			4-10	3	35°-38°	●	○	●			○	○	○	372
	ORANGE		SM3515..TI			4-10	3	35°-38°	○	●			●		○		374
	GRAY		SM3525			4-10	3	35°-38°	●	○	●			○	○	○	376
	ORANGE		SM3525..TI			4-10	3	35°-38°	○	●			●		○		378
	BLACK		SMW4501			5-20	4	35°-38°	●	○	●			○	○	○	380
	ORANGE		SMW4501..TI			5-20	4	35°-38°	○	●			●		○		382
	BLACK		SMW4502			5-20	4	35°-38°	●	○	●			○	○	○	384
	BLACK		SMW4401			3-25	4	35°-38°	●	○	●			○	○	○	386
	ORANGE		SMW4401..TI			3-25	4	35°-38°	○	●			●		○		388
	BLACK		SM4415			3-25	4	35°-38°	●	○	●			○	○	○	390



		ART.	LUNGHEZZA FRESE MILLING CUTTER LENGTH	SPIGOLO FRESE CORNER SHAPE	ØD	Z	ANGOLO ELICA ANGLE FLUTES	Materiali - Materials Pag. 1199							Pag.	
								P	M	K	N	S	H	G		
ELICA CON ANGOLO VARIABILE - HELIX WITH VARIABLE ANGLE																
	ORANGE		SM4415..TI			45°	3-25	4	35°-38°	○	●	○	○	○	○	392
	GRAY		SMW4305			R	4-20	4	35°-38°	●	○	●	○	○	○	394
	ORANGE		SMW4305..TI			R	4-20	4	35°-38°	○	●	○	○	○	○	396
	ORANGE		SM4314..C			R	6-16	4	35°-38°	●	●	○	○	○	○	398
	GRAY		SM4315			R	4-20	4	35°-38°	●	○	●	○	○	○	400
	ORANGE		SM4315..TI			R	4-20	4	35°-38°	○	●	○	○	○	○	402
	GRAY		SM4313			R	2,5-16	4	35°-38°	●	○	●	○	○	○	404
	ORANGE		SM4313..TI			R	2,5-16	4	35°-38°	○	●	○	○	○	○	406
	GRAY		SM4413..LX			R	3-16	4	35°-38°	●	○	●	○	○	○	408
			SM5215..TI			R	6-16	5	36°-37°	●	●	○	○	○	○	410
			SMW5405..TI			R	8-16	5	36°-37°	●	●	○	○	○	○	412
SEDI CHIAVETTE - KEYSLOTS																
	BLACK		SMW3301			90°	1,8-15,7	3	30°	●	●	●	○	○	○	416
SVASATORI/SMUSSATORI - COUNTERSINK AND CHAMFER MILLS																
	BLACK		SCR0183			60°	4-20	4-6	0°	●	●	●	○	○	○	420
	BLACK		SCR0187			90°	4-20	4-5-6	0°	●	●	●	○	○	○	422
	BLACK		SMR0110			45°	4-16	4	0°	●	●	●	○	○	○	424
			SS230			90°	3-20	2	30°	○	○	○	○	○	○	426
	BLACK		SM4701			R	6-10	4	0°	●	●	●	○	○	○	428

SIMBOLOGIA - SYMBOL - SYMBOLE - SYMBOLES







RIVESTIMENTI - COATED - BESCHICHTUNG - RECOUVREMENT

RIVESTIM. COATED BLACK	BLACK: L'elevata durezza del rivestimento offre una protezione eccellente contro l'usura abrasiva e l'erosione BLACK: The high hardness of the coating offers an excellent protection against abrasive wear and erosion	RIVESTIM. COATED GRAY	GRAY: Le notevoli migliorie di resistenza all'usura, così come la resistenza all'ossidazione e la durezza a caldo, rendono questo rivestimento la scelta naturale per le frese GRAY: A considerably improved resistance to wear, as well as good oxidation stability and hot hardness make this coating ideally suitable for the milling cutters
RIVESTIM. COATED GOLD	GOLD: Rivestimento molto adatto alla lavorazione dell'alluminio e le sue leghe. Permette di utilizzare parametri di taglio più elevati. GOLD: This coating is particularly suitable for aluminum and relevant alloys. It enables the use of higher cutting parameters	RIVESTIM. COATED SILVER	SILVER: Particolarmente indicato per lavorazioni di alluminio, bronzo, ottone e rame. SILVER: Particularly suitable to machining aluminum, bronze and copper.
RIVESTIM. COATED RED	RED: Lavorazione ad alta velocità di materiali difficilmente lavorabili. RED: High speed machining of hardly machinable materials.	RIVESTIM. COATED ORANGE	ORANGE: Rivestimento multistrato ottimizzato per la lavorazione di acciai inossidabili, Titanio, Inconel e superleghe. ORANGE: Optimized multi-layer coating for stainless steel, titanium, inconel and super alloys.

DIREZIONE DI LAVORAZIONE - WORKING DIRECTION - ARBEITSRICHTUNG - ORENTATION D'EXECUTION

	- N2 Direzioni di utilizzo possibili - 2 Possible usage orientation - 2 Mögliche vorschubrichtung - N2 orientations d'usage possibles		- N3 Direzioni di utilizzo possibili - 3 Possible usage orientation - 3 Mögliche vorschubrichtung - N3 orientations d'usage possibles
---	--	---	--



SPIGOLO FRESA - CORNER SHAPE - FRÄSERKANTE - ARETE FRAISE

	- 90°		- Angolo di testa 90° - 90° Head angle - Kopfwinkel 90° - Angle en tete 90°		- Angolo di testa 60° - 60° Head angle - Kopfwinkel 60° - Angle en tete 60°		- Spigolo a 45° - 45° Corner shape - Ecke 45° - Arête 45°
	- Sferico - Spherical - Kugelförmig - Sphérique		- Torico - Toric - Torisch - Torique		- Raggiato - Radius - Mit eckenradius - Radiaire		







DUREZZA MATERIALE - HARDNESS MATERIAL - MATERIALHÄRTE - DURETE MATERIAU

42 HRC	- 42 HRC	52 HRC	- 52 HRC	58 HRC	- 58 HRC	60 HRC	- 60 HRC
62 HRC	- 62 HRC	64 HRC	- 64 HRC	ALU ≤ 5% Si	- Alluminio con Silicio ≤ 5% - Aluminium with silicon ≤ 5% - Aluminium avec silicium ≤ 5% - Aluminium mit Siliziumgehalt ≤ 5%	ALU > 5% Si	- Alluminio con Silicio > 5% - Aluminium with silicon > 5% - Aluminium avec silicium > 5% - Aluminium mit Siliziumgehalt > 5%

LUNGHEZZA FRESA - MILLING CUTTER LENGTH - FRÄSERLÄNGE - LONGUEUR DE LA FRAISE

	- Corta - Short - Kurz - Courte		- Media - Medium - Mittel - Moyenne		- Lunga - Long - Lang - Longue
---	--	---	--	---	---

SIMBOLI GENERALI - GENERAL SYMBOLS - ALLGEMEINE SYMBOLE - SYMBOLES GÉNÉRAUX

	- Per lavorazioni ad alta velocità - For high speed machining - Für hochgeschwindigkeitsbearbeitungen geeignet - Pour usinage à haute vitesse		- Lavorazioni a secco - Dry machining - Trockenbearbeitung - Usinage a sec		- Lavorazioni con refrigerante - Machining operations with coolant - Bearbeitungen mit Kühlmittel - Usinages avec réfrigérant		- Basse vibrazioni - Low vibrations - Vibrationsarm - Faibles vibrations
	- Divisione irregolare - Irregular helix angles - Unregelmäßige Teilung der Schneiden - Division Irrégulière		- Tagliente con romptruciolo speciale - Cutting edge with special chipbreaker - Schneide mit speziellem Spanbrecher - Tranchant avec brise-copeau spécial		- Fresatura Trocoidale - Trochoidal Milling - Trochoides Fräsen - Fraisage Trochoidal		

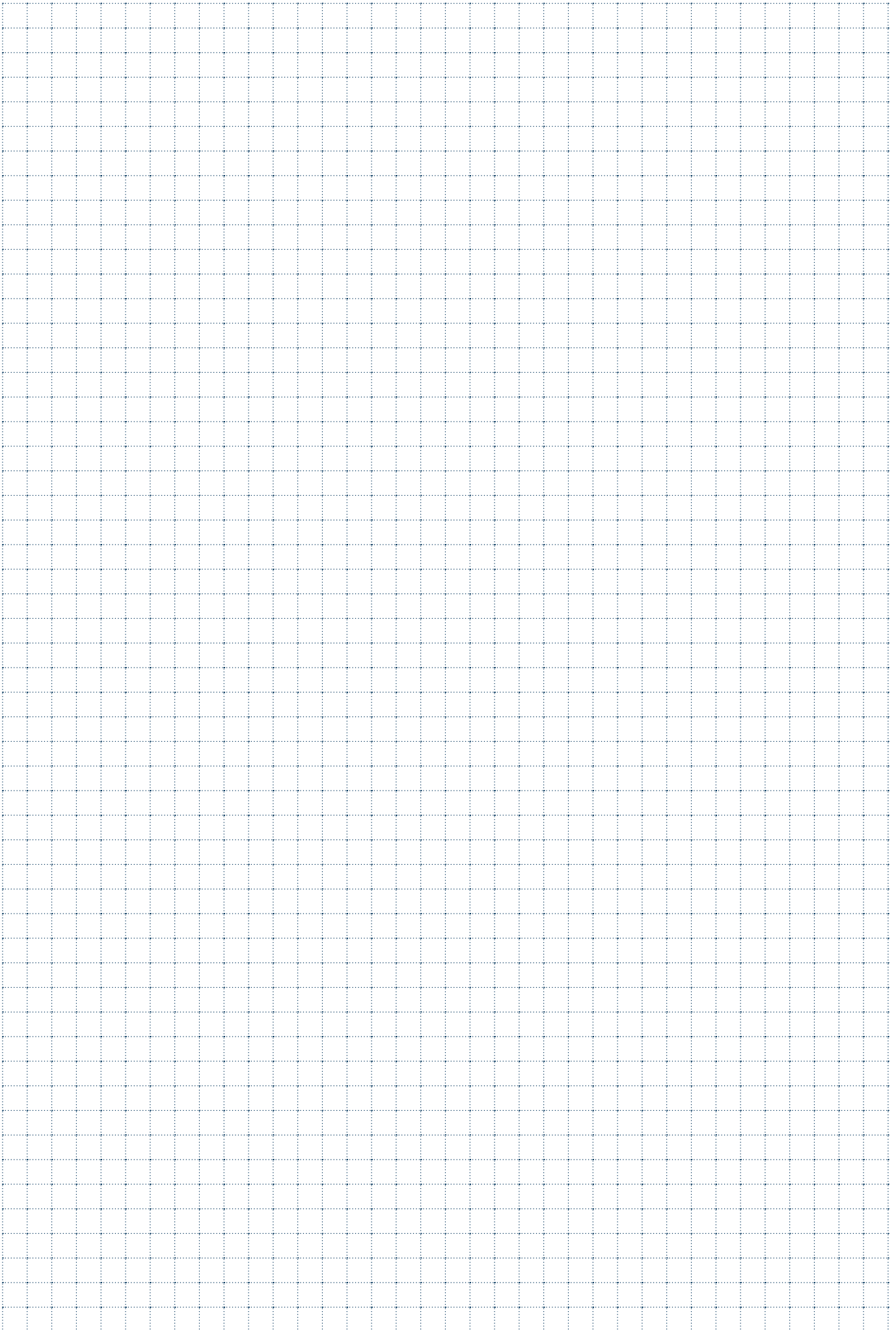



MICROFRESE

MICRO-MILLS / MIKROFRAESER / MICRO-FRAISES / MICROFRESAS

ST2201

$\varnothing D = 0,4 - 3$



Fino a diametro 0,8
 Up to diameter 0,8

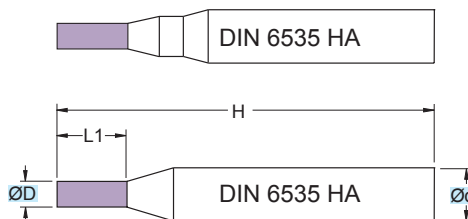

**Microfresa in M.D.I. Micrograno
 Gambo Cilindrico HA**

Micrograin HM Micro-mill
 Cylindrical Shank HA

TOLLERANZE	D	d
TOLERANCE RANGE	h10	h6

RIVESTIM.
 COATED
BLACK



90°

**42
 HRC**



ART.	(mm)				
	$\varnothing D$	$\varnothing d$	L1	H	z
ST2201.040.N00	0,4	3,0	1,5	38	2
ST2201.050.N00	0,5	3,0	1,5	38	2
ST2201.060.N00	0,6	3,0	2,0	38	2
ST2201.070.N00	0,7	3,0	3,0	38	2
ST2201.080.N00	0,8	3,0	3,0	38	2
ST2201.090.N00	0,9	3,0	3,0	38	2
ST2201.100.N00	1,0	3,0	4,0	38	2
ST2201.110.N00	1,1	3,0	4,0	38	2
ST2201.120.N00	1,2	3,0	4,0	38	2
ST2201.130.N00	1,3	3,0	4,0	38	2
ST2201.140.N00	1,4	3,0	4,0	38	2
ST2201.150.N00	1,5	3,0	5,0	38	2
ST2201.160.N00	1,6	3,0	5,0	38	2
ST2201.180.N00	1,8	3,0	5,0	38	2
ST2201.200.N00	2,0	3,0	6,0	38	2
ST2201.250.N00	2,5	3,0	7,0	38	2
ST2201.300.N00	3,0	3,0	8,0	38	2

STN2201

$\varnothing D = 0,4 - 3$



Fino a diametro 0,8
 Up to diameter 0,8

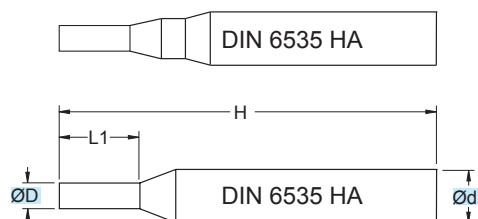

**Microfresa in M.D.I. Micrograno
 Gambo Cilindrico HA**

Micrograin HM Micro-mill
 Cylindrical Shank HA

TOLLERANZE	D	d
TOLLERANCE RANGE	h10	h6

90°	42 HRC

ART.	(mm)				
	ØD	Ød	L1	H	z
STN2201.040.N00	0,4	3,0	1,5	38	2
STN2201.050.N00	0,5	3,0	1,5	38	2
STN2201.060.N00	0,6	3,0	2,0	38	2
STN2201.070.N00	0,7	3,0	3,0	38	2
STN2201.080.N00	0,8	3,0	3,0	38	2
STN2201.090.N00	0,9	3,0	3,0	38	2
STN2201.100.N00	1,0	3,0	4,0	38	2
STN2201.110.N00	1,1	3,0	4,0	38	2
STN2201.120.N00	1,2	3,0	4,0	38	2
STN2201.130.N00	1,3	3,0	4,0	38	2
STN2201.140.N00	1,4	3,0	4,0	38	2
STN2201.150.N00	1,5	3,0	5,0	38	2
STN2201.160.N00	1,6	3,0	5,0	38	2
STN2201.180.N00	1,8	3,0	5,0	38	2
STN2201.200.N00	2,0	3,0	6,0	38	2
STN2201.250.N00	2,5	3,0	7,0	38	2
STN2201.300.N00	3,0	3,0	8,0	38	2

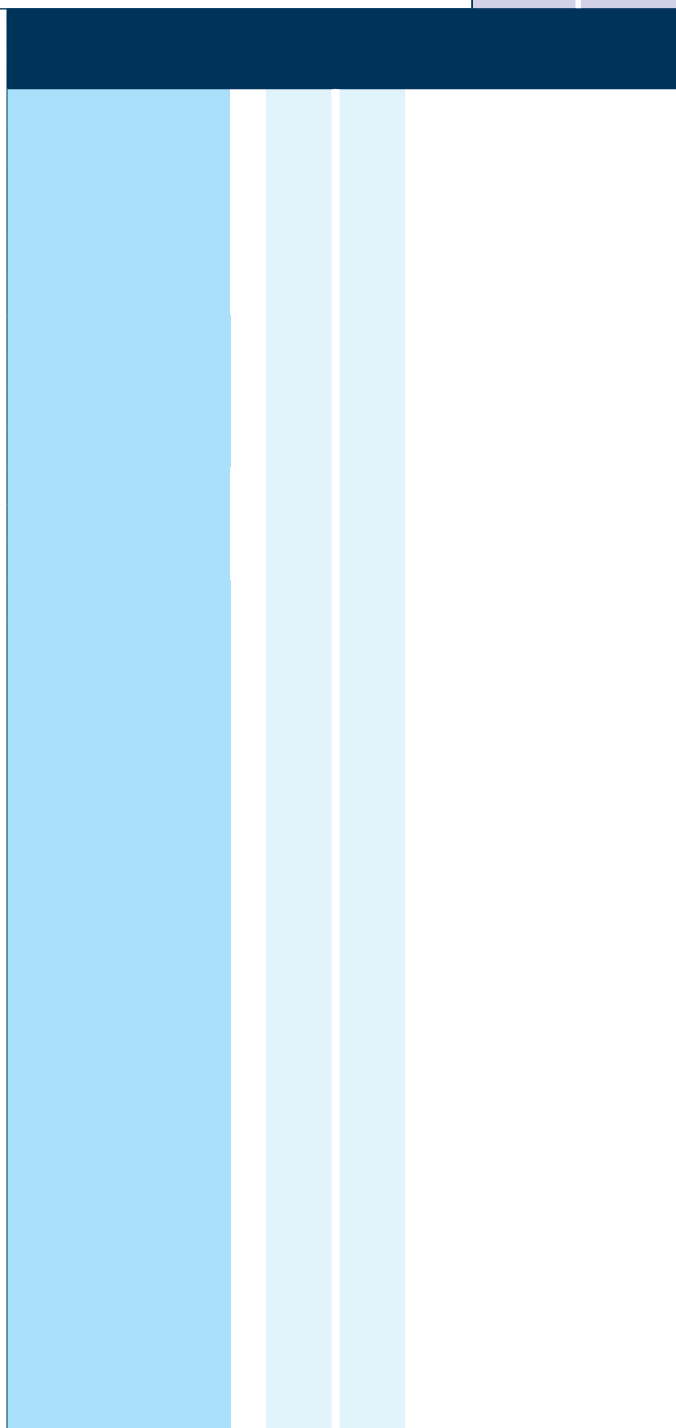

Applicazione - Application

ae →

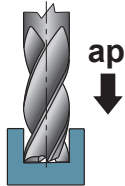

P	M	K	N	S	H	G	(mm) ØD	(m/min) Vc	(mm) fz	(mm) ap	(mm) ae			
												ACCIAIO NON LEGATO NOT ALLOY STEEL	ACCIAIO POCO LEGATO LOW ALLOY STEEL	ACCIAIO ALTO LEGATO ALLOY STEEL
							0,4+0,6	50-80	0,003-0,011	0,5xD	1xD			
							0,6+0,8	50-80	0,003-0,015	0,5xD	1xD			
							0,8+1,0	50-80	0,002-0,017	0,5xD	1xD			
							1,0+1,2	50-80	0,005-0,020	0,5xD	1xD			
							1,2+1,4	50-80	0,007-0,022	0,5xD	1xD			
							1,4+1,6	50-80	0,010-0,025	0,5xD	1xD			
							1,6+2,0	50-80	0,012-0,027	0,5xD	1xD			
							2,0+3,0	50-80	0,015-0,030	0,5xD	1xD			
							0,4+0,6	25-45	0,003-0,011	0,5xD	1xD			
							0,6+0,8	25-45	0,003-0,015	0,5xD	1xD			
							0,8+1,0	25-45	0,002-0,017	0,5xD	1xD			
							1,0+1,2	25-45	0,005-0,020	0,5xD	1xD			
							1,2+1,4	25-45	0,007-0,022	0,5xD	1xD			
							1,4+1,6	25-45	0,010-0,025	0,5xD	1xD			
							1,6+2,0	25-45	0,012-0,027	0,5xD	1xD			
							2,0+3,0	25-45	0,015-0,030	0,5xD	1xD			
							0,4+0,6	65-95	0,003-0,011	0,5xD	1xD			
							0,6+0,8	65-95	0,003-0,015	0,5xD	1xD			
							0,8+1,0	65-95	0,002-0,017	0,5xD	1xD			
							1,0+1,2	65-95	0,005-0,020	0,5xD	1xD			
							1,2+1,4	65-95	0,007-0,022	0,5xD	1xD			
							1,4+1,6	65-95	0,010-0,025	0,5xD	1xD			
							1,6+2,0	65-95	0,012-0,027	0,5xD	1xD			
							2,0+3,0	65-95	0,015-0,030	0,5xD	1xD			
							0,4+0,6	130-320	0,003-0,012	0,5xD	1xD			
							0,6+0,8	130-320	0,005-0,020	0,5xD	1xD			
							0,8+1,0	130-320	0,007-0,022	0,5xD	1xD			
							1,0+1,2	130-320	0,010-0,025	0,5xD	1xD			
							1,2+1,4	130-320	0,012-0,027	0,5xD	1xD			
							1,4+1,6	130-320	0,020-0,035	0,5xD	1xD			
							1,6+2,0	130-320	0,022-0,037	0,5xD	1xD			
							2,0+3,0	130-320	0,025-0,040	0,5xD	1xD			

● APPLICAZIONE CONSIGLIATA-RECOMMENDED APPLICATION
EMPFOLLENER EINSATZ - APPLICATION CONSEILLÉE

○ APPLICAZIONE POSSIBILE - POSSIBLE APPLICATION
MÖGLICHE ANWENDUNG - APPLICATION POSSIBLE

Vc = m/min VELOCITÀ DI TAGLIO - CUTTING SPEED

n = giri/min (min⁻¹) NUMERO DI GIRI - NUMBER OF REVOLUTIONS

fz = mm AVANZAMENTO AL DENTE -TOOTH FEED

fn = mm AVANZAMENTO AL GIRO - FEED / REVOLUTION

Vf = mm/min VELOCITÀ DI AVANZAMENTO - FEED SPEED

$$n = \frac{Vc \cdot 1000}{\text{ØD} \cdot 3,14} = \text{giri/min (min}^{-1}\text{)}$$

$$fn = fz \cdot z = \text{mm}$$

$$Vf = fz \cdot z \cdot n = \text{mm/min}$$

ST2205

$\varnothing D = 0,4 - 3$

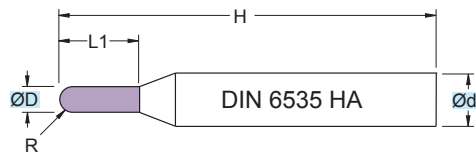

Microfresa in M.D.I. Micrograno
Gambo cilindrico HA

Micrograin HM Micro-mill
 Cylindrical Shank HA

TOLLERANZE	D	d
TOLLERANCE RANGE	h10	h6

RIVESTIM. COATED BLACK	
	42 HRC

ART.	(mm)					
	ØD	Ød	L1	H	R	z
ST2205.040.S020	0,4	3,0	1,5	38	0,20	2
ST2205.050.S025	0,5	3,0	1,5	38	0,25	2
ST2205.060.S030	0,6	3,0	2,0	38	0,30	2
ST2205.070.S035	0,7	3,0	3,0	38	0,35	2
ST2205.080.S040	0,8	3,0	3,0	38	0,40	2
ST2205.090.S045	0,9	3,0	3,0	38	0,45	2
ST2205.100.S050	1,0	3,0	4,0	38	0,50	2
ST2205.110.S055	1,1	3,0	4,0	38	0,55	2
ST2205.120.S060	1,2	3,0	4,0	38	0,60	2
ST2205.130.S065	1,3	3,0	4,0	38	0,65	2
ST2205.140.S070	1,4	3,0	4,0	38	0,70	2
ST2205.150.S075	1,5	3,0	5,0	38	0,75	2
ST2205.160.S080	1,6	3,0	5,0	38	0,80	2
ST2205.180.S090	1,8	3,0	5,0	38	0,90	2
ST2205.200.S100	2,0	3,0	6,0	38	1,00	2
ST2205.250.S125	2,5	3,0	7,0	38	1,25	2
ST2205.300.S150	3,0	3,0	8,0	38	1,50	2

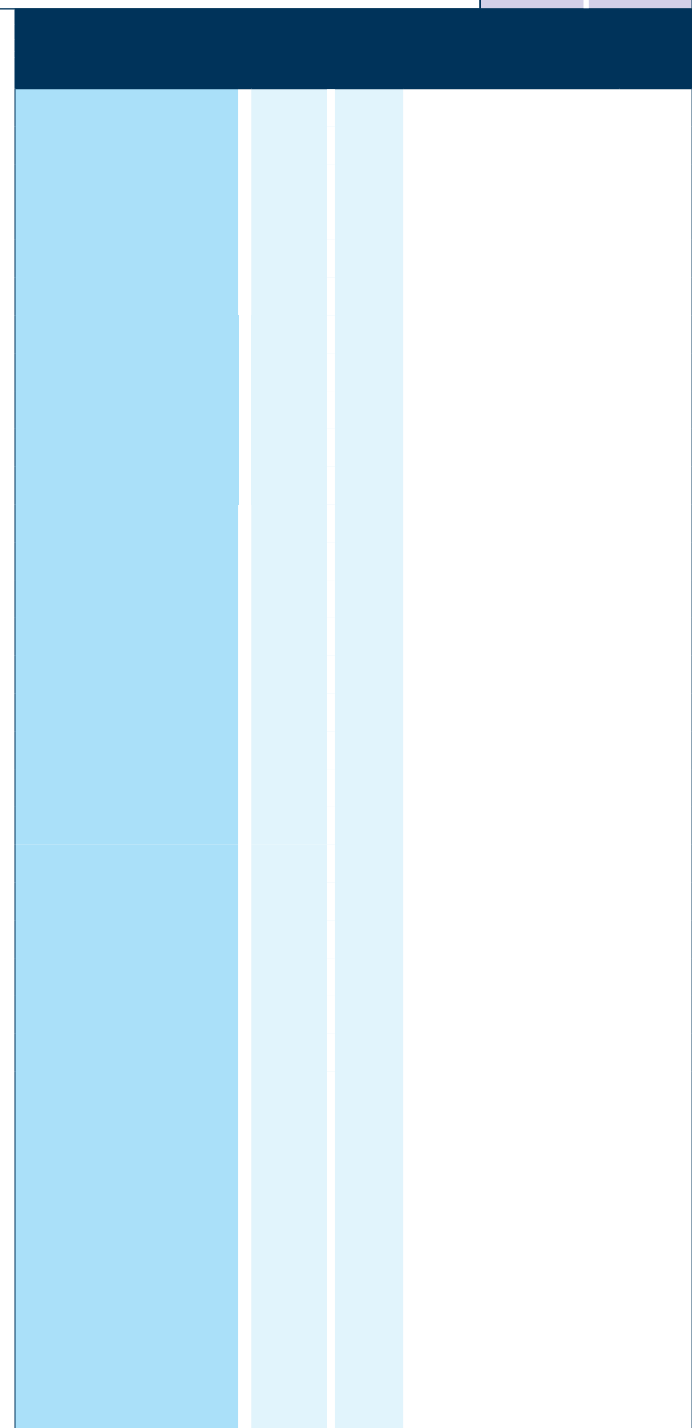

STN2205

$\varnothing D = 0,4 - 3$

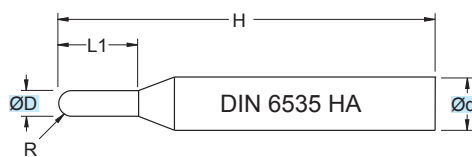

Microfresa in M.D.I. Micrograno
Gambo cilindrico HA

Micrograin HM Micro-mill
 Cylindrical Shank HA

TOLLERANZE	D	d
TOLERANCE RANGE	h10	h6

SAU logo and icons: a double-headed arrow, a curved arrow labeled 'R', a blue water drop icon, and the text '42 HRC'.

ART.	(mm)					
	ØD	Ød	L1	H	R	z
STN2205.040.S020	0,4	3,0	1,5	38	0,20	2
STN2205.050.S025	0,5	3,0	1,5	38	0,25	2
STN2205.060.S030	0,6	3,0	2,0	38	0,30	2
STN2205.070.S035	0,7	3,0	3,0	38	0,35	2
STN2205.080.S040	0,8	3,0	3,0	38	0,40	2
STN2205.090.S045	0,9	3,0	3,0	38	0,45	2
STN2205.100.S050	1,0	3,0	4,0	38	0,50	2
STN2205.110.S055	1,1	3,0	4,0	38	0,55	2
STN2205.120.S060	1,2	3,0	4,0	38	0,60	2
STN2205.130.S065	1,3	3,0	4,0	38	0,65	2
STN2205.140.S070	1,4	3,0	4,0	38	0,70	2
STN2205.150.S075	1,5	3,0	5,0	38	0,75	2
STN2205.160.S080	1,6	3,0	5,0	38	0,80	2
STN2205.180.S090	1,8	3,0	5,0	38	0,90	2
STN2205.200.S100	2,0	3,0	6,0	38	1,00	2
STN2205.250.S125	2,5	3,0	7,0	38	1,25	2
STN2205.300.S150	3,0	3,0	8,0	38	1,50	2

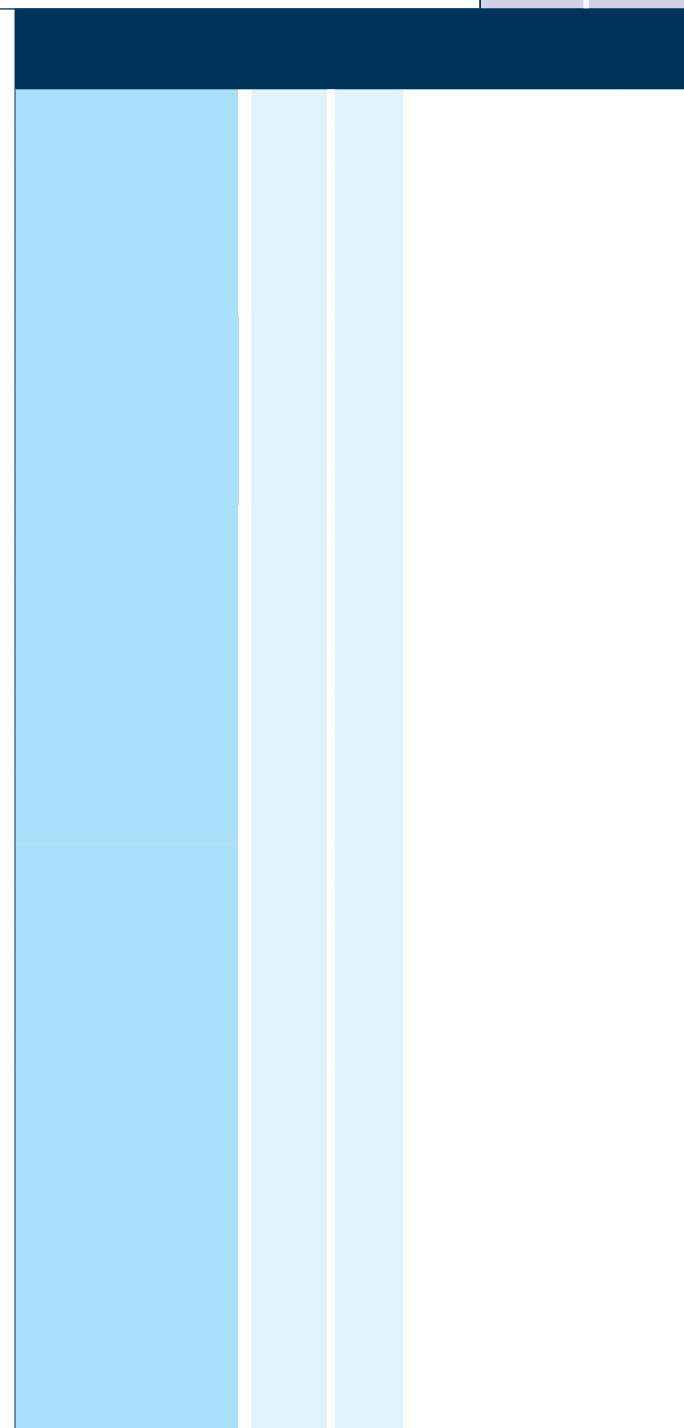

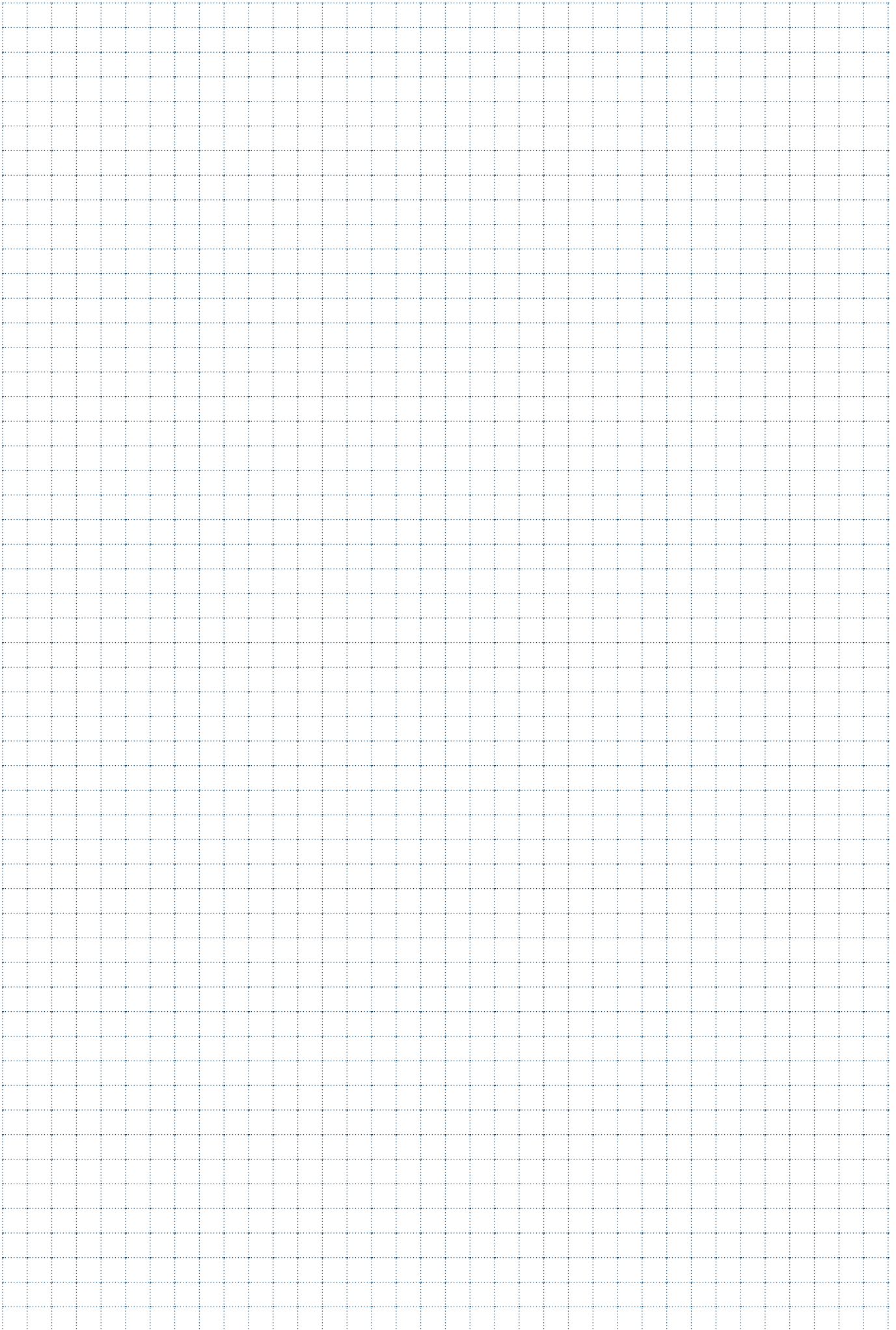



FRESE PER ALLUMINIO

MILLING CUTTERS FOR ALUMINIUM / FRAESER FÜR ALUMINIUM /
FRAISES POUR ALUMINIUM / FRESAS PARA ALUMINIO

SM1200

$\varnothing D = 1 - 6$

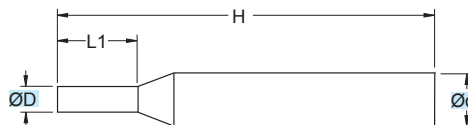

90°	ALU ≤ 5% Si

**Fresa in M.D.I. Micrograno
 Gambo cilindrico HA**

Micrograin HM minimills
 Cylindrical Shank HA

TOLLERANZE	D	d
TOLLERANCE RANGE	h10	h6

ART.	(mm)				
	ØD	Ød	L1	H	z
SM1200.010.N00	1,0	6,0	5	40	1
SM1200.015.N00	1,5	6,0	7	40	1
SM1200.020.N00	2,0	6,0	7	40	1
SM1200.025.N00	2,5	6,0	8	40	1
SM1200.030.N00	3,0	6,0	8	40	1
SM1200.035.N00	3,5	6,0	10	40	1
SM1200.040.N00	4,0	6,0	10	40	1
SM1200.045.N00	4,5	6,0	12	50	1
SM1200.050.N00	5,0	6,0	12	50	1
SM1200.055.N00	5,5	6,0	14	50	1
SM1200.060.N00	6,0	6,0	14	50	1

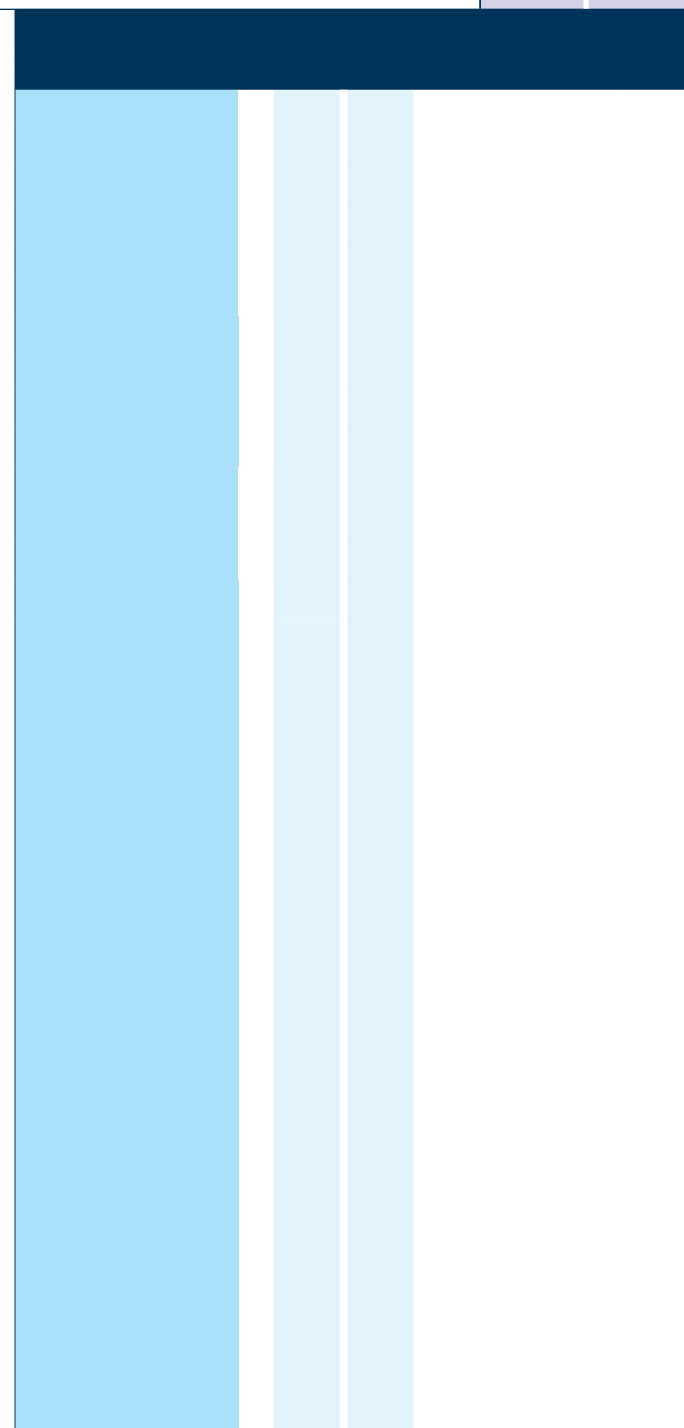

Applicazione - Application

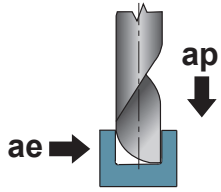

MATERIALI - MATERIALS Pag. 1199											(mm) ØD	(m/min) Vc	(mm) fz	(mm) ap	(mm) ae					
P			M		K			N		S						H	G			
ACCIAIO NON LEGATO NOT ALLOY STEEL	ACCIAIO POCO LEGATO LOW ALLOY STEEL	ACCIAIO ALTO LEGATO ALLOY STEEL	INOX MARTENSITICO STAINLESS STEEL MART.	INOX AUST. DUPLEX STAINLESS STEEL AUST.	GHISA GRIGIA GREY CAST IRON	GHISA SFEROIDALE SPHEROIDAL GRAPHITE	GHISA MALLEABILE MALLEABLE CAST IRON	ALLUMINIO Si ≤ 12% ALUMINIUM 12 ≤ 12%	ALLUMINIO Si > 12% ALUMINIUM 12 > 12%	NON METALLICI PLASTICS	LEGHE RESIST. CALORE HIGH TEMP. ALLOY	TITANIO E SUE LEGHE TITANIUM	ACCIAIO TEMPRATO HARDENED STEEL	GRAFITE GRAPHITE						
															1+2	250-350	0,003-0,010	0,5xD	1xD	
																2+3	250-350	0,005-0,020	0,5xD	1xD
																3+4	250-350	0,015-0,030	0,5xD	1xD
																4+5	250-350	0,020-0,035	0,5xD	1xD
																5+6	250-350	0,025-0,040	0,5xD	1xD

- APPLICAZIONE CONSIGLIATA - RECOMMENDED APPLICATION / EMPFOHLENER EINSATZ - APPLICATION CONSEILLÉE
- APPLICAZIONE POSSIBILE - POSSIBLE APPLICATION / MÖGLICHE ANWENDUNG - APPLICATION POSSIBLE

Vc = m/min VELOCITÀ DI TAGLIO - CUTTING SPEED
 n = giri/min (min⁻¹) NUMERO DI GIRI - NUMBER OF REVOLUTIONS
 fz = mm AVANZAMENTO AL DENTE - TOOTH FEED
 fn = mm AVANZAMENTO AL GIRO - FEED / REVOLUTION
 Vf = mm/min VELOCITÀ DI AVANZAMENTO - FEED SPEED

$$n = \frac{Vc \cdot 1000}{\text{ØD} \cdot 3,14} = \text{giri/min (min}^{-1}\text{)}$$

$$fn = fz \cdot z = \text{mm}$$

$$Vf = fz \cdot z \cdot n = \text{mm/min}$$

SM1300

$\varnothing D = 2 - 16$

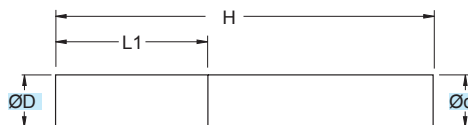

90°	ALU ≤5% Si

Fresa in M.D.I. Micrograno
Gambo cilindrico HA

Micrograin HM minimills
 Cylindrical Shank HA

TOLLERANZE	D	d
TOLLERANCE RANGE	h10	h6

ART.	(mm)				
	ØD	Ød	L1	H	z
SM1300.020.N00	2,0	3,0	10	38	1
SM1300.025.N00	2,5	3,0	12	38	1
SM1300.030.N00	3,0	3,0	12	38	1
SM1300.040.N00	4,0	4,0	15	40	1
SM1300.050.N00	5,0	5,0	16	50	1
SM1300.061.N00	6,0	6,0	18	50	1
SM1300.062.N00	6,0	6,0	25	60	1
SM1300.081.N00	8,0	8,0	22	63	1
SM1300.082.N00	8,0	8,0	40	80	1
SM1300.100.N00	10,0	10,0	30	72	1
SM1300.120.N00	12,0	12,0	30	73	1
SM1300.140.N00	14,0	14,0	30	75	1
SM1300.160.N00	16,0	16,0	35	82	1

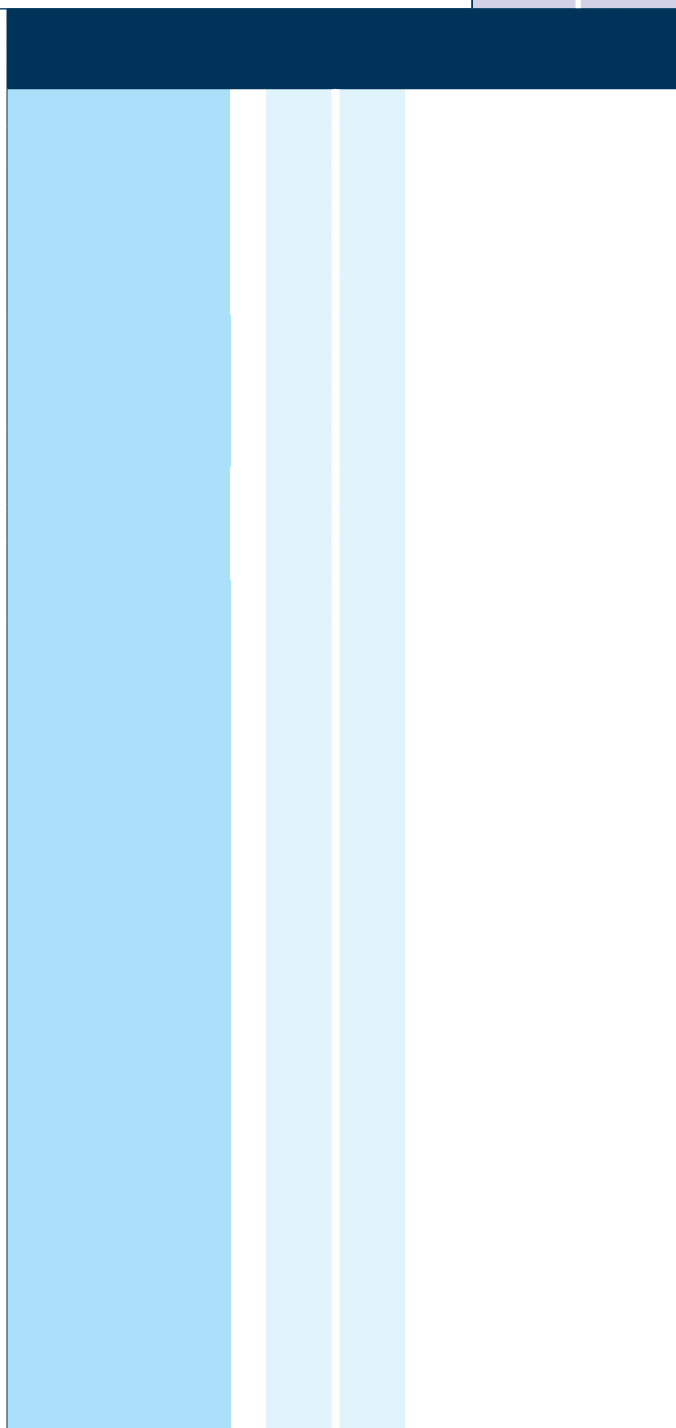

Applicazione - Application	MATERIALI - MATERIALS Pag. 1199											ØD	(m/min) Vc	(mm) fz	(mm) ap	(mm) ae						
	P		M	K			N		S		H						G					
	ACCIAIO NON LEGATO NOT ALLOY STEEL	ACCIAIO POCO LEGATO LOW ALLOY STEEL	ACCIAIO ALTO LEGATO ALLOY STEEL	INOX MARTENSITICO STAINLESS STEEL MART.	INOX AUST. DUPLEX STAINLESS STEEL AUST.	GHISA GRIGIA GREY CAST IRON	GHISA SFEROIDALE SPHEROIDAL GRAPHITE	GHISA MALLEABILE MALLEABLE CAST IRON	ALLUMINIO Si ≤ 12% ALUMINIUM 12 ≤ 12%	ALLUMINIO Si > 12% ALUMINIUM 12 > 12%	NON METALLICI PLASTICS						LEGHE RESIST. CALORE HIGH TEMP. ALLOY	TITANIO E SUE LEGHE TITANIUM	ACCIAIO TEMPRATO HARDENED STEEL	GRAFITE GRAPHITE		
																	2+4	250-350	0,005-0,020	0,5xD	1xD	
																		4+6	250-350	0,015-0,030	0,5xD	1xD
																		6+8	250-350	0,025-0,040	0,5xD	1xD
																		8+10	250-350	0,035-0,050	0,5xD	1xD
																		10+12	250-350	0,045-0,060	0,5xD	1xD
																		12+14	250-350	0,060-0,075	0,5xD	1xD
																		14+16	250-350	0,075-0,090	0,5xD	1xD

● APPLICAZIONE CONSIGLIATA-RECOMMENDED APPLICATION ○ APPLICAZIONE POSSIBILE - POSSIBLE APPLICATION
 EMPFOHLENER EINSATZ - APPLICATION CONSEILLÉE MÖGLICHE ANWENDUNG - APPLICATION POSSIBLE

Vc = m/min VELOCITÀ DI TAGLIO - CUTTING SPEED
 n = giri/min (min⁻¹) NUMERO DI GIRI - NUMBER OF REVOLUTIONS
 fz = mm AVANZAMENTO AL DENTE -TOOTH FEED
 fn = mm AVANZAMENTO AL GIRO - FEED / REVOLUTION
 Vf = mm/min VELOCITÀ DI AVANZAMENTO - FEED SPEED

$$n = \frac{Vc \cdot 1000}{\text{ØD} \cdot 3,14} = \text{giri/min (min}^{-1}\text{)}$$

$$fn = fz \cdot z = \text{mm}$$

$$Vf = fz \cdot z \cdot n = \text{mm/min}$$

SMW2317

$\varnothing D = 4 - 20$

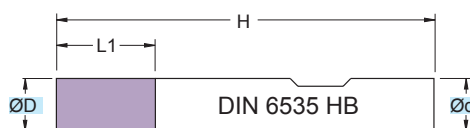

RIVESTIM.
COATED
SILVER



90°

ALU
>5% Si



Fresa in M.D.I. Micrograno
 Gambo sec. DIN 6535 HB

Micrograin HM mills
 DIN 6535 HB Shank

TOLLERANZE	D	d
TOLLERANCE RANGE	h10	h6

ART.	(mm)				
	$\varnothing D$	$\varnothing d$	L1	H	z
SMW2317.040.N00	4	6	11	57	2
SMW2317.050.N00	5	6	13	57	2
SMW2317.060.N00	6	6	13	57	2
SMW2317.080.N00	8	8	19	63	2
SMW2317.100.N00	10	10	22	72	2
SMW2317.120.N00	12	12	26	83	2
SMW2317.140.N00	14	14	26	83	2
SMW2317.160.N00	16	16	32	92	2
SMW2317.180.N00	18	18	32	92	2
SMW2317.200.N00	20	20	38	104	2

Applicazione - Application

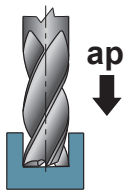

	P		M		K			N			S		H	G	(mm) ØD	(m/min) Vc	(mm) fz	(mm) ap	(mm) ae
	ACCIAIO NON LEGATO NOT ALLOY STEEL	ACCIAIO POCO LEGATO LOW ALLOY STEEL	ACCIAIO ALTO LEGATO ALLOY STEEL	INOX MARTENSITICO STAINLESS STEEL MART.	INOX AUST. DUPLEX STAINLESS STEEL AUST.	GHISA GRIGIA GREY CAST IRON	GHISA SFEROIDALE SPHEROIDAL GRAPHITE	GHISA MALLEABILE MALLEABLE CAST IRON	ALLUMINIO Si ≤ 12% ALUMINIUM 12 ≤ 12%	ALLUMINIO Si > 12% ALUMINIUM 12 > 12%	NON METALLICI PLASTICS	LEGHE RESIST. CALORE HIGH TEMP. ALLOY	TITANIO E SUE LEGHE TITANIUM	ACCIAIO TEMPRATO HARDENED STEEL					
									●						4+6	250-350	0,015-0,030	0,5xD	1xD
									●						6+8	250-350	0,030-0,045	0,5xD	1xD
									●						8+10	250-350	0,040-0,055	0,5xD	1xD
									●						10+12	250-350	0,050-0,065	0,5xD	1xD
									●						12+14	250-350	0,090-0,105	0,5xD	1xD
									●						14+16	250-350	0,110-0,125	0,5xD	1xD
									●						16+18	250-350	0,130-0,145	0,5xD	1xD
									●						18+20	250-350	0,150-0,165	0,5xD	1xD
									●					4+6	130-160	0,015-0,030	0,5xD	1xD	
									●					6+8	130-160	0,030-0,045	0,5xD	1xD	
									●					8+10	130-160	0,040-0,055	0,5xD	1xD	
									●					10+12	130-160	0,050-0,065	0,5xD	1xD	
									●					12+14	130-160	0,090-0,105	0,5xD	1xD	
									●					14+16	130-160	0,110-0,125	0,5xD	1xD	
									●					16+18	130-160	0,130-0,145	0,5xD	1xD	
									●					18+20	130-160	0,150-0,165	0,5xD	1xD	
										●				4+6	80-110	0,030-0,045	0,5xD	1xD	
										●				6+8	80-110	0,045-0,060	0,5xD	1xD	
										●				8+10	80-110	0,060-0,075	0,5xD	1xD	
										●				10+12	80-110	0,080-0,095	0,5xD	1xD	
										●				12+14	80-110	0,100-0,115	0,5xD	1xD	
										●				14+16	80-110	0,130-0,145	0,5xD	1xD	
										●				16+18	80-110	0,150-0,165	0,5xD	1xD	
										●				18+20	80-110	0,170-0,185	0,5xD	1xD	

PER LAVORAZIONI A SPALLAMENTO AUMENTARE I PARAMETRI DEL 20%
 FOR SHOULDER MILLING PARAMETERS SHOULD BE INCREASED BY 20%

- APPLICAZIONE CONSIGLIATA-RECOMMENDED APPLICATION
EMPFOHLENER EINSATZ - APPLICATION CONSEILLÉE
- APPLICAZIONE POSSIBILE - POSSIBLE APPLICATION
MÖGLICHE ANWENDUNG - APPLICATION POSSIBLE

Vc = m/min VELOCITÀ DI TAGLIO - CUTTING SPEED
 n = giri/min (min⁻¹) NUMERO DI GIRI - NUMBER OF REVOLUTIONS
 fz = mm AVANZAMENTO AL DENTE -TOOTH FEED
 fn = mm AVANZAMENTO AL GIRO - FEED / REVOLUTION
 Vf = mm/min VELOCITÀ DI AVANZAMENTO - FEED SPEED

$$n = \frac{Vc \cdot 1000}{\text{ØD} \cdot 3,14} = \text{giri/min (min}^{-1}\text{)}$$

$$fn = fz \cdot z = \text{mm}$$

$$Vf = fz \cdot z \cdot n = \text{mm/min}$$

SMW2317..N01

$\varnothing D = 3 - 20$

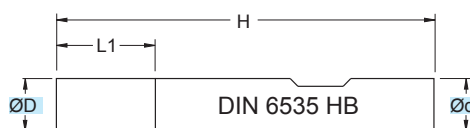

90°
ALU ≤5% Si

Fresa in M.D.I. Micrograno
 Gambo sec. DIN 6535 HB

Micrograin HM mills
 DIN 6535 HB Shank

TOLLERANZE	D	d
TOLERANCE RANGE	h10	h6

ART.	(mm)				
	ØD	Ød	L1	H	z
SMW2317.030.N01	3	6	8	57	2
SMW2317.040.N01	4	6	11	57	2
SMW2317.050.N01	5	6	13	57	2
SMW2317.060.N01	6	6	13	57	2
SMW2317.080.N01	8	8	19	63	2
SMW2317.100.N01	10	10	22	72	2
SMW2317.120.N01	12	12	26	83	2
SMW2317.140.N01	14	14	26	83	2
SMW2317.160.N01	16	16	32	92	2
SMW2317.180.N01	18	18	32	92	2
SMW2317.200.N01	20	20	38	104	2

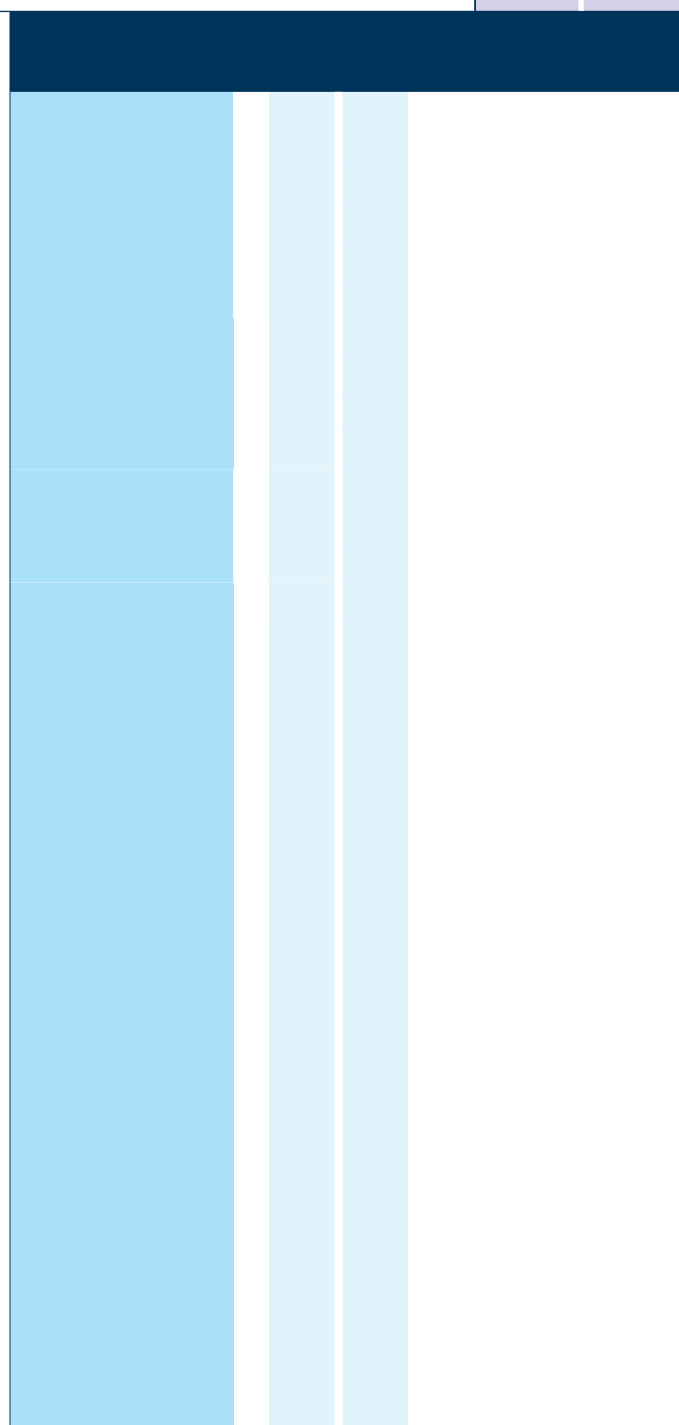

Applicazione - Application

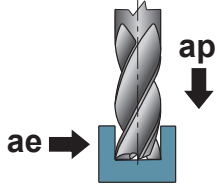

	MATERIALI - MATERIALS											(mm) ØD	(m/min) Vc	(mm) fz	(mm) ap	(mm) ae				
	P			M	K			N		S	H						G			
	ACCIAIO NON LEGATO NOT ALLOY STEEL	ACCIAIO POCO LEGATO LOW ALLOY STEEL	ACCIAIO ALTO LEGATO ALLOY STEEL	INOX MARTENSITICO STAINLESS STEEL MART.	INOX AUST. DUPLEX STAINLESS STEEL AUST.	GHISA GRIGIA GREY CAST IRON	GHISA SFEROIDALE SPHEROIDAL GRAPHITE	GHISA MALLEABILE MALLEABLE CAST IRON	ALLUMINIO Si ≤ 12% ALUMINIUM 12 ≤ 12%	ALLUMINIO Si > 12% ALUMINIUM 12 > 12%	NON METALLICI PLASTICS	LEGHE RESIST. CALORE HIGH TEMP. ALLOY	TITANIO E SUE LEGHE TITANIUM	ACCIAIO TEMPRATO HARDENED STEEL	GRAFITE GRAPHITE					
									●							3	250-350	0,005-0,020	0,5xD	1xD
									●							4+6	250-350	0,015-0,030	0,5xD	1xD
									●							6+8	250-350	0,030-0,045	0,5xD	1xD
									●							8+10	250-350	0,040-0,055	0,5xD	1xD
									●							10+12	250-350	0,050-0,065	0,5xD	1xD
									●							12+14	250-350	0,090-0,105	0,5xD	1xD
									●							14+16	250-350	0,110-0,125	0,5xD	1xD
									●							16+18	250-350	0,130-0,145	0,5xD	1xD
									●							18+20	250-350	0,150-0,165	0,5xD	1xD
									●							3	130-160	0,005-0,020	0,5xD	1xD
									●							4+6	130-160	0,015-0,030	0,5xD	1xD
									●							6+8	130-160	0,030-0,045	0,5xD	1xD
									●							8+10	130-160	0,040-0,055	0,5xD	1xD
									●							10+12	130-160	0,050-0,065	0,5xD	1xD
									●							12+14	130-160	0,090-0,105	0,5xD	1xD
									●							14+16	130-160	0,110-0,125	0,5xD	1xD
									●							16+18	130-160	0,130-0,145	0,5xD	1xD
									●							18+20	130-160	0,150-0,165	0,5xD	1xD
										●						3	80-110	0,015-0,030	0,5xD	1xD
									●							4+6	80-110	0,030-0,045	0,5xD	1xD
									●							6+8	80-110	0,045-0,060	0,5xD	1xD
									●							8+10	80-110	0,060-0,075	0,5xD	1xD
									●							10+12	80-110	0,080-0,095	0,5xD	1xD
									●							12+14	80-110	0,100-0,115	0,5xD	1xD
									●							14+16	80-110	0,130-0,145	0,5xD	1xD
									●							16+18	80-110	0,150-0,165	0,5xD	1xD
									●							18+20	80-110	0,170-0,185	0,5xD	1xD

PER LAVORAZIONI A SPALLAMENTO AUMENTARE I PARAMETRI DEL 20%
FOR SHOULDER MILLING PARAMETERS SHOULD BE INCREASED BY 20%

- APPLICAZIONE CONSIGLIATA-RECOMMENDED APPLICATION
EMPFÖHLENER EINSATZ - APPLICATION CONSEILLÉE
- APPLICAZIONE POSSIBILE - POSSIBLE APPLICATION
MÖGLICHE ANWENDUNG - APPLICATION POSSIBLE

Vc = m/min VELOCITÀ DI TAGLIO - CUTTING SPEED
 n = giri/min (min⁻¹) NUMERO DI GIRI - NUMBER OF REVOLUTIONS
 fz = mm AVANZAMENTO AL DENTE -TOOTH FEED
 fn = mm AVANZAMENTO AL GIRO - FEED / REVOLUTION
 Vf = mm/min VELOCITÀ DI AVANZAMENTO - FEED SPEED

$$n = \frac{Vc \cdot 1000}{\text{ØD} \cdot 3,14} = \text{giri/min (min}^{-1}\text{)}$$

$$fn = fz \cdot z = \text{mm}$$

$$Vf = fz \cdot z \cdot n = \text{mm/min}$$

SM2315..N01

ØD = 8 - 25

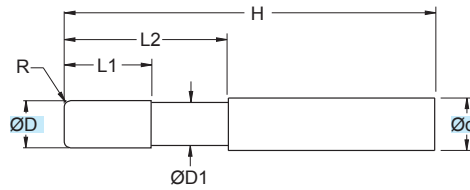

Fresa in M.D.I. Micrograno
 Gambo cilindrico HA

Micrograin HM mills
 Cylindrical Shank HA

TOLLERANZE	D	d
TOLERANCE RANGE	h10	h6

ART.	(mm)							
ART.	ØD	Ød	ØD1	L1	L2	H	R	z
SM2315.0801.R050.N01	8	8	7	8	27	64	0,5	2
SM2315.0802.R250.N01	8	8	7	8	27	64	2,5	2
SM2315.0811.R300.N01	8	8	7	8	27	64	3,0	2
SM2315.0803.R400.N01	8	8	7	8	27	64	4,0	2
SM2315.0813.R050.N01	8	8	7	8	32	70	0,5	2
SM2315.0814.R250.N01	8	8	7	8	32	70	2,5	2
SM2315.0815.R300.N01	8	8	7	8	32	70	3,0	2
SM2315.0816.R400.N01	8	8	7	8	32	70	4,0	2
SM2315.0804.R050.N01	8	8	7	8	38	74	0,5	2
SM2315.0805.R250.N01	8	8	7	8	38	74	2,5	2
SM2315.0855.R300.N01	8	8	7	8	38	74	3,0	2
SM2315.0806.R400.N01	8	8	7	8	38	74	4,0	2
SM2315.1001.R050.N01	10	10	9	10	32	70	0,5	2
SM2315.1002.R250.N01	10	10	9	10	32	70	2,5	2
SM2315.1003.R300.N01	10	10	9	10	32	70	3,0	2
SM2315.1004.R400.N01	10	10	9	10	32	70	4,0	2
SM2315.1005.R050.N01	10	10	9	10	43	80	0,5	2
SM2315.1006.R250.N01	10	10	9	10	43	80	2,5	2
SM2315.1007.R300.N01	10	10	9	10	43	80	3,0	2
SM2315.1008.R400.N01	10	10	9	10	43	80	4,0	2
SM2315.1201.R050.N01	12	12	11	12	30	70	0,5	2
SM2315.1202.R250.N01	12	12	11	12	30	70	2,5	2
SM2315.1203.R300.N01	12	12	11	12	30	70	3,0	2
SM2315.1204.R400.N01	12	12	11	12	30	70	4,0	2
SM2315.1205.R050.N01	12	12	11	12	40	80	0,5	2
SM2315.1206.R250.N01	12	12	11	12	40	80	2,5	2
SM2315.1207.R300.N01	12	12	11	12	40	80	3,0	2
SM2315.1208.R400.N01	12	12	11	12	40	80	4,0	2
SM2315.1209.R050.N01	12	12	11	12	55	95	0,5	2
SM2315.1210.R250.N01	12	12	11	12	55	95	2,5	2
SM2315.1211.R300.N01	12	12	11	12	55	95	3,0	2
SM2315.1212.R400.N01	12	12	11	12	55	95	4,0	2
SM2315.1601.R050.N01	16	16	15	16	41	85	0,5	2
SM2315.1602.R250.N01	16	16	15	16	41	85	2,5	2
SM2315.1603.R300.N01	16	16	15	16	41	85	3,0	2
SM2315.1604.R400.N01	16	16	15	16	41	85	4,0	2
SM2315.1605.R050.N01	16	16	15	16	50	94	0,5	2
SM2315.1606.R250.N01	16	16	15	16	50	94	2,5	2
SM2315.1607.R300.N01	16	16	15	16	50	94	3,0	2
SM2315.1608.R400.N01	16	16	15	16	50	94	4,0	2

ART.	(mm)							
ART.	ØD	Ød	ØD1	L1	L2	H	R	z
SM2315.1609.R050.N01	16	16	15	16	62	106	0,5	2
SM2315.1610.R250.N01	16	16	15	16	62	106	2,5	2
SM2315.1611.R300.N01	16	16	15	16	62	106	3,0	2
SM2315.1612.R400.N01	16	16	15	16	62	106	4,0	2
SM2315.2001.R050.N01	20	20	19	20	45	92	0,5	2
SM2315.2002.R250.N01	20	20	19	20	45	92	2,5	2
SM2315.2003.R300.N01	20	20	19	20	45	92	3,0	2
SM2315.2004.R400.N01	20	20	19	20	45	92	4,0	2
SM2315.2005.R050.N01	20	20	19	20	60	108	0,5	2
SM2315.2006.R250.N01	20	20	19	20	60	108	2,5	2
SM2315.2007.R300.N01	20	20	19	20	60	108	3,0	2
SM2315.2008.R400.N01	20	20	19	20	60	108	4,0	2
SM2315.2009.R050.N01	20	20	19	20	75	123	0,5	2
SM2315.2010.R250.N01	20	20	19	20	75	123	2,5	2
SM2315.2011.R300.N01	20	20	19	20	75	123	3,0	2
SM2315.2012.R400.N01	20	20	19	20	75	123	4,0	2
SM2315.2501.R050.N01	25	25	24	25	55	105	0,5	2
SM2315.2502.R250.N01	25	25	24	25	55	105	2,5	2
SM2315.2503.R300.N01	25	25	24	25	55	105	3,0	2
SM2315.2504.R400.N01	25	25	24	25	55	105	4,0	2
SM2315.2570.R050.N01	25	25	24	25	75	125	0,5	2
SM2315.2592.R250.N01	25	25	24	25	75	125	2,5	2
SM2315.2573.R300.N01	25	25	24	25	75	125	3,0	2
SM2315.2549.R400.N01	25	25	24	25	75	125	4,0	2
SM2315.2548.R050.N01	25	25	24	25	90	140	0,5	2
SM2315.2545.R250.N01	25	25	24	25	90	140	2,5	2
SM2315.2508.R300.N01	25	25	24	25	90	140	3,0	2
SM2315.2538.R400.N01	25	25	24	25	90	140	4,0	2
SM2315.2576.R050.N01	25	25	24	25	110	160	0,5	2
SM2315.2571.R250.N01	25	25	24	25	110	160	2,5	2
SM2315.2559.R300.N01	25	25	24	25	110	160	3,0	2
SM2315.2578.R400.N01	25	25	24	25	110	160	4,0	2
SM2315.2587.R050.N01	25	25	24	25	130	180	0,5	2
SM2315.2593.R250.N01	25	25	24	25	130	180	2,5	2
SM2315.2521.R300.N01	25	25	24	25	130	180	3,0	2
SM2315.2584.R400.N01	25	25	24	25	130	180	4,0	2

SM2417

ØD = 4 - 12

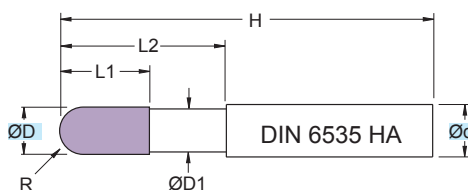

Fresa in M.D.I. Micrograno
Gambo cilindrico HA

Micrograin HM mills
 Cylindrical Shank HA

TOLLERANZE	D	d
TOLLERANCE RANGE	h10	h6

RIVESTIM.
 COATED
SILVER



R

ALU
 >5% Si



(mm)								
ART.	ØD	Ød	ØD1	L1	L2	H	R	z
SM2417.040.S200	4	6	3,7	8	25	70	2,0	2
SM2417.050.S250	5	6	4,6	10	25	70	2,5	2
SM2417.060.S300	6	6	5,5	12	35	80	3,0	2
SM2417.080.S400	8	8	7,4	16	35	80	4,0	2
SM2417.100.S500	10	10	9,2	20	45	90	5,0	2
SM2417.120.S600	12	12	11,0	24	50	100	6,0	2

Applicazione - Application

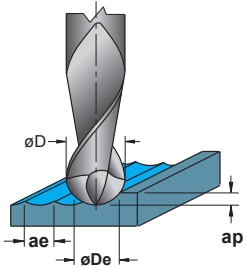

P	M	K	N	S	H	G	(mm) ØDe	(m/min) Vc	(mm) fz	(mm) ap	(mm) ae			
												ACCIAIO NON LEGATO NOT ALLOY STEEL	ACCIAIO POCO LEGATO LOW ALLOY STEEL	ACCIAIO ALTO LEGATO ALLOY STEEL
							4	250-350	0,050-0,065	0,20	0,4			
							5	250-350	0,060-0,075	0,25	0,5			
							6	250-350	0,070-0,085	0,30	0,6			
							8	250-350	0,080-0,095	0,40	0,8			
							10	250-350	0,090-0,105	0,50	1,0			
							12	250-350	0,110-0,125	0,60	1,2			
							4	180-250	0,050-0,065	0,20	0,4			
							5	180-250	0,060-0,075	0,25	0,5			
							6	180-250	0,070-0,085	0,30	0,6			
							8	180-250	0,080-0,095	0,40	0,8			
							10	180-250	0,090-0,105	0,50	1,0			
							12	180-250	0,110-0,125	0,60	1,2			

● APPLICAZIONE CONSIGLIATA-RECOMMENDED APPLICATION
EMPFOLHENER EINSATZ - APPLICATION CONSEILLÉE

○ APPLICAZIONE POSSIBILE - POSSIBLE APPLICATION
MÖGLICHE ANWENDUNG - APPLICATION POSSIBLE

DATI TECNICI LAVORAZIONI PAG. 1152 - 1153
MACHINING TECHNICAL DATA PAGE 1152 - 1153
BEARBEITUNGSSCHNITTDATEN S. 1152 - 1153
DONNEES TECHNIQUES USINAGES PAGES 1152 - 1153

øD = mm DIAMETRO - DIAMETER

øDe = mm DIAMETRO EFFETTIVO - EFFECTIVE DIAMETER

Vc = m/min VELOCITÀ DI TAGLIO - CUTTING SPEED

n = giri/min (min⁻¹) NUMERO DI GIRI - NUMBER OF REVOLUTIONS

fz = mm AVANZAMENTO AL DENTE -TOOTH FEED

fn = mm AVANZAMENTO AL GIRO - FEED / REVOLUTION

Vf = mm/min VELOCITÀ DI AVANZAMENTO - FEED SPEED

$$n = \frac{Vc \cdot 1000}{\text{ØDe} \cdot 3,14} = \text{giri/min (min}^{-1}\text{)}$$

$$fn = fz \cdot z = \text{mm}$$

$$Vf = fz \cdot z \cdot n = \text{mm/min}$$

SM2417..01

ØD = 3 - 12

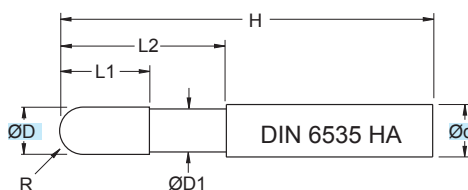

Fresa in M.D.I. Micrograno
 Gambo cilindrico HA

Micrograin HM mills
 Cylindrical Shank HA

TOLLERANZE	D	d
TOLLERANCE RANGE	h10	h6

	ALU ≤5% Si

(mm)								
ART.	ØD	Ød	ØD1	L1	L2	H	R	z
SM2417.030.S150.01	3	6	2,8	6	25	70	1,5	2
SM2417.040.S200.01	4	6	3,7	8	25	70	2,0	2
SM2417.050.S250.01	5	6	4,6	10	25	70	2,5	2
SM2417.060.S300.01	6	6	5,5	12	35	80	3,0	2
SM2417.080.S400.01	8	8	7,4	16	35	80	4,0	2
SM2417.100.S500.01	10	10	9,2	20	45	90	5,0	2
SM2417.120.S600.01	12	12	11,0	24	50	100	6,0	2

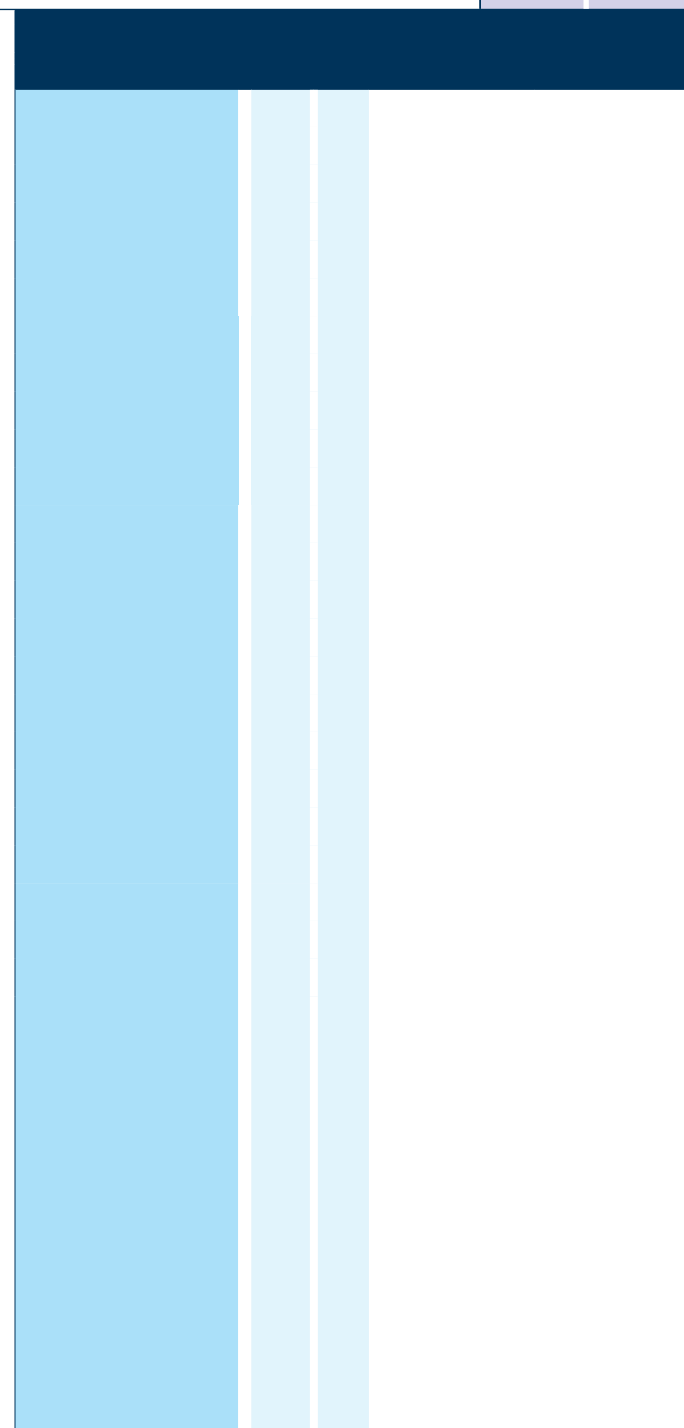

MATERIALI - MATERIALS Pag. 1199

Applicazione - Application

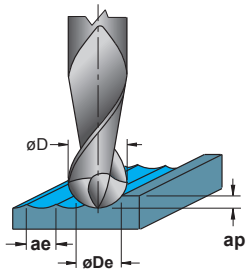

	MATERIALI - MATERIALS											(mm) ØDe	(m/min) Vc	(mm) fz	(mm) ap	(mm) ae
	P	M	K	N		S	H	G								
ACCIAIO NON LEGATO NOT ALLOY STEEL												3	250-350	0,040-0,055	0,15	0,3
ACCIAIO POCO LEGATO LOW ALLOY STEEL												4	250-350	0,050-0,065	0,20	0,4
ACCIAIO ALTO LEGATO ALLOY STEEL												5	250-350	0,060-0,075	0,25	0,5
INOX MARTENSITICO STAINLESS STEEL MART.												6	250-350	0,070-0,085	0,30	0,6
INOX AUST. DUPLEX STAINLESS STEEL AUST.												8	250-350	0,080-0,095	0,40	0,8
GHISA GRIGIA GREY CAST IRON												10	250-350	0,090-0,105	0,50	1,0
GHISA SFEROIDALE SPHEROIDAL GRAPHITE												12	250-350	0,110-0,125	0,60	1,2
GHISA MALLEABILE MALLEABLE CAST IRON																
ALLUMINIO Si ≤ 12% ALUMINIUM 12 ≤ 12%							•									
ALLUMINIO Si > 12% ALUMINIUM 12 > 12%							•									
NON METALLICI PLASTICS																
LEGHE RESIST. CALORE HIGH TEMP. ALLOY																
TITANIO E SUE LEGHE TITANIUM																
ACCIAIO TEMPRATO HARDENED STEEL																
GRAFITE GRAPHITE																

- APPLICAZIONE CONSIGLIATA-RECOMMENDED APPLICATION
EMPFÖHLENER EINSATZ - APPLICATION CONSEILLÉE
- APPLICAZIONE POSSIBILE - POSSIBLE APPLICATION
MÖGLICHE ANWENDUNG - APPLICATION POSSIBLE

DATI TECNICI LAVORAZIONI PAG. 1152 - 1153
MACHINING TECHNICAL DATA PAGE 1152 - 1153
BEARBEITUNGSSCHNITTDATEN S. 1152 - 1153
DONNEES TECHNIQUES USINAGES PAGES 1152 - 1153

- øD = mm DIAMETRO - DIAMETER
- øDe = mm DIAMETRO EFFETTIVO - EFFECTIVE DIAMETER
- Vc = m/min VELOCITÀ DI TAGLIO - CUTTING SPEED
- n = giri/min (min⁻¹) NUMERO DI GIRI - NUMBER OF REVOLUTIONS
- fz = mm AVANZAMENTO AL DENTE -TOOTH FEED
- fn = mm AVANZAMENTO AL GIRO - FEED / REVOLUTION
- Vf = mm/min VELOCITÀ DI AVANZAMENTO - FEED SPEED

$$n = \frac{Vc \cdot 1000}{\delta De \cdot 3,14} = \text{giri/min (min}^{-1}\text{)}$$

$$fn = fz \cdot z = \text{mm}$$

$$Vf = fz \cdot z \cdot n = \text{mm/min}$$

SM3315..N01

ØD = 6 - 16

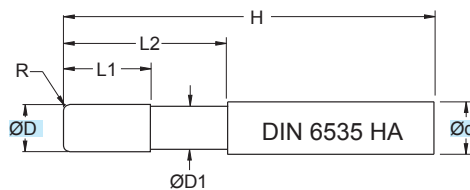

Fresa in M.D.I. Micrograno
 Gambo cilindrico HA

Micrograin HM mills
 Cylindrical Shank HA

TOLLERANZE	D	d
TOLLERANCE RANGE	h10	h6

R	ALU ≤5% Si

(mm)								
ART.	ØD	Ød	ØD1	L1	L2	H	R	z
SM3315.060.R050.N01	6	6	5,5	12	27	63	0,50	3
SM3315.060.R100.N01	6	6	5,5	12	27	63	1,00	3
SM3315.060.R150.N01	6	6	5,5	12	27	63	1,50	3
SM3315.080.R050.N01	8	8	7,4	16	33	70	0,50	3
SM3315.080.R100.N01	8	8	7,4	16	33	70	1,00	3
SM3315.080.R200.N01	8	8	7,4	16	33	70	2,00	3
SM3315.100.R050.N01	10	10	9,2	20	35	75	0,50	3
SM3315.100.R150.N01	10	10	9,2	20	35	75	1,50	3
SM3315.100.R250.N01	10	10	9,2	20	35	75	2,50	3
SM3315.100.R300.N01	10	10	9,2	20	35	75	3,00	3
SM3315.100.R400.N01	10	10	9,2	20	35	75	4,00	3
SM3315.120.R050.N01	12	12	11,0	24	39	84	0,50	3
SM3315.120.R150.N01	12	12	11,0	24	39	84	1,50	3
SM3315.120.R250.N01	12	12	11,0	24	39	84	2,50	3
SM3315.120.R300.N01	12	12	11,0	24	39	84	3,00	3
SM3315.120.R400.N01	12	12	11,0	24	39	84	4,00	3
SM3315.160.R050.N01	16	16	15,0	32	50	100	0,50	3
SM3315.160.R200.N01	16	16	15,0	32	50	100	2,00	3
SM3315.160.R250.N01	16	16	15,0	32	50	100	2,50	3
SM3315.160.R300.N01	16	16	15,0	32	50	100	3,00	3
SM3315.160.R400.N01	16	16	15,0	32	50	100	4,00	3

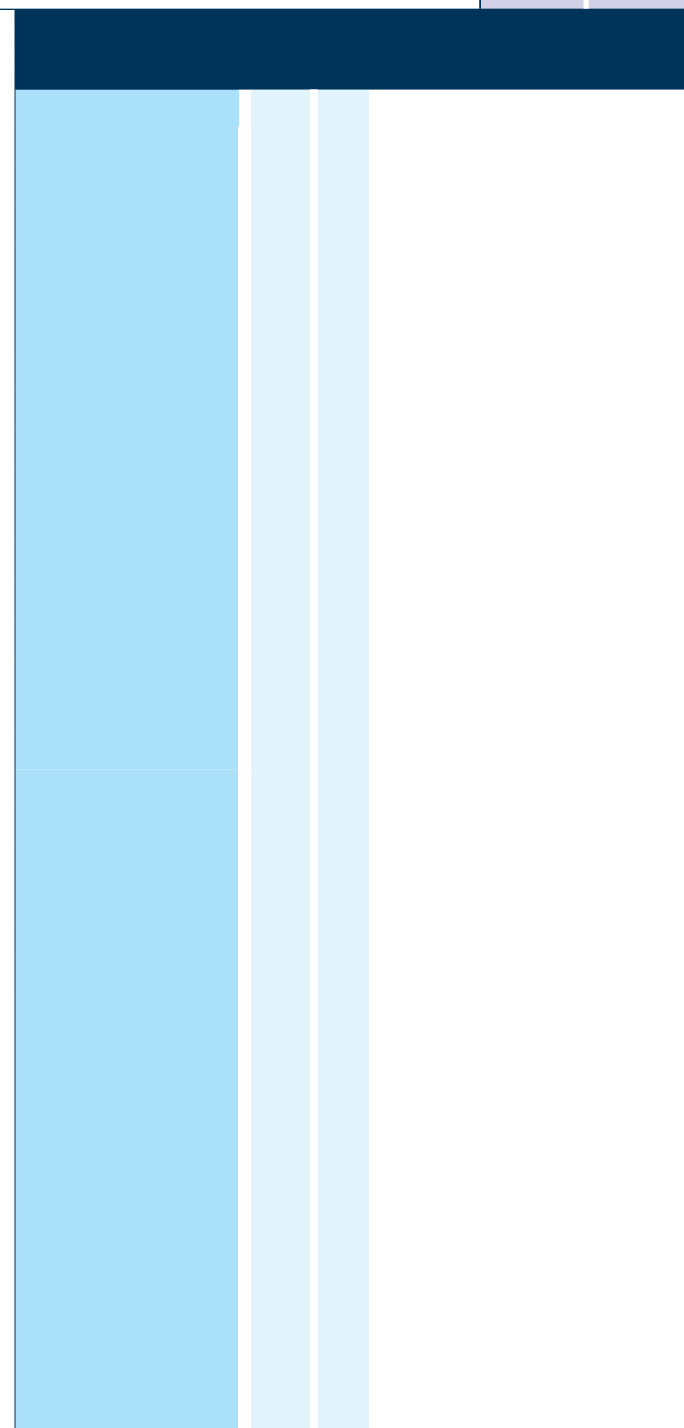

Applicazione - Application

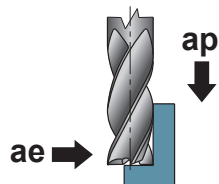

P	M	K	N	S	H	G	(mm) ØD	(m/min) Vc	(mm) fz	(mm) ap	(mm) ae			
												ACCIAIO NON LEGATO NOT ALLOY STEEL	ACCIAIO POCO LEGATO LOW ALLOY STEEL	ACCIAIO ALTO LEGATO ALLOY STEEL
							6	350-480	0,085-0,100	3,6	1,5			
							8	350-480	0,120-0,135	4,8	2,0			
							10	350-480	0,150-0,165	6,0	2,5			
							12	350-480	0,165-0,180	7,2	3,0			
							16	350-480	0,185-0,200	9,6	4,0			
							6	250-350	0,065-0,080	3,6	1,5			
							8	250-350	0,095-0,110	4,8	2,0			
							10	250-350	0,120-0,135	6,0	2,5			
							12	250-350	0,130-0,145	7,2	3,0			
							16	250-350	0,145-0,160	9,6	4,0			
							6	640-760	0,085-0,100	3,6	1,5			
							8	640-760	0,120-0,135	4,8	2,0			
							10	640-760	0,150-0,165	6,0	2,5			
							12	640-760	0,165-0,180	7,2	3,0			
							16	640-760	0,185-0,200	9,6	4,0			

● APPLICAZIONE CONSIGLIATA-RECOMMENDED APPLICATION
EMPFOHLENER EINSATZ - APPLICATION CONSEILLÉE

○ APPLICAZIONE POSSIBILE - POSSIBLE APPLICATION
MÖGLICHE ANWENDUNG - APPLICATION POSSIBLE

Vc = m/min VELOCITÀ DI TAGLIO - CUTTING SPEED

n = giri/min (min⁻¹) NUMERO DI GIRI - NUMBER OF REVOLUTIONS

fz = mm AVANZAMENTO AL DENTE -TOOTH FEED

fn = mm AVANZAMENTO AL GIRO - FEED / REVOLUTION

Vf = mm/min VELOCITÀ DI AVANZAMENTO - FEED SPEED

$$n = \frac{Vc \cdot 1000}{\text{ØD} \cdot 3,14} = \text{giri/min (min}^{-1}\text{)}$$

$$fn = fz \cdot z = \text{mm}$$

$$Vf = fz \cdot z \cdot n = \text{mm/min}$$

SM3417

ØD = 6 - 25

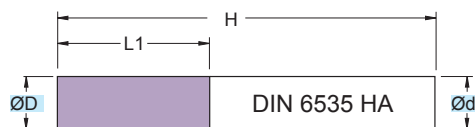

RIVESTIM.
COATED
SILVER



90°

ALU
>5% Si



Fresa in M.D.I. Micrograno
 Gambo cilindrico HA

Micrograin HM mills
 Cylindrical Shank HA

TOLLERANZE	D	d
TOLLERANCE RANGE	h10	h6

ART.	(mm)				
	ØD	Ød	L1	H	z
SM3417.060.N00	6	6	16	60	3
SM3417.080.N00	8	8	25	78	3
SM3417.100.N00	10	10	28	78	3
SM3417.120.N00	12	12	32	89	3
SM3417.140.N00	14	14	32	89	3
SM3417.160.N00	16	16	36	96	3
SM3417.200.N00	20	20	45	111	3
SM3417.250.N00	25	25	50	126	3

Applicazione - Application

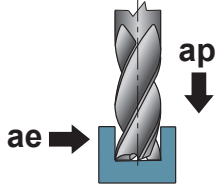

	MATERIALI - MATERIALS													(mm) ØD	(m/min) Vc	(mm) fz	(mm) ap	(mm) ae		
	P			M	K			N			S	H	G							
	ACCIAIO NON LEGATO NOT ALLOY STEEL	ACCIAIO POCO LEGATO LOW ALLOY STEEL	ACCIAIO ALTO LEGATO ALLOY STEEL	INOX MARTENSITICO STAINLESS STEEL MART.	INOX AUST. DUPLEX STAINLESS STEEL AUST.	GHISA GRIGIA GREY CAST IRON	GHISA SFEROIDALE SPHEROIDAL GRAPHITE	GHISA MALLEABILE MALLEABLE CAST IRON	ALLUMINIO Si ≤ 12% ALUMINIUM 12 ≤ 12%	ALLUMINIO Si > 12% ALUMINIUM 12 > 12%	NON METALLICI PLASTICS	LEGHE RESIST. CALORE HIGH TEMP. ALLOY	TITANIO E SUE LEGHE TITANIUM	ACCIAIO TEMPRATO HARDENED STEEL	GRAFITE GRAPHITE					
									●							6+8	250-350	0,030-0,045	0,5xD	1xD
									●							8+10	250-350	0,040-0,055	0,5xD	1xD
									●							10+12	250-350	0,050-0,065	0,5xD	1xD
									●							12+14	250-350	0,090-0,105	0,5xD	1xD
									●							14+16	250-350	0,110-0,125	0,5xD	1xD
									●							16+18	250-350	0,130-0,145	0,5xD	1xD
									●							18+20	250-350	0,150-0,165	0,5xD	1xD
									●							20+25	250-350	0,170-0,185	0,5xD	1xD
									●							6+8	130-160	0,030-0,045	0,5xD	1xD
									●							8+10	130-160	0,040-0,055	0,5xD	1xD
									●							10+12	130-160	0,050-0,065	0,5xD	1xD
									●							12+14	130-160	0,090-0,105	0,5xD	1xD
									●							14+16	130-160	0,110-0,125	0,5xD	1xD
									●							16+18	130-160	0,130-0,145	0,5xD	1xD
									●							18+20	130-160	0,150-0,165	0,5xD	1xD
									●							20+25	130-160	0,170-0,185	0,5xD	1xD
									●							6+8	80-110	0,045-0,060	0,5xD	1xD
									●							8+10	80-110	0,060-0,075	0,5xD	1xD
									●							10+12	80-110	0,080-0,095	0,5xD	1xD
									●							12+14	80-110	0,100-0,115	0,5xD	1xD
									●							14+16	80-110	0,130-0,145	0,5xD	1xD
									●							16+18	80-110	0,150-0,165	0,5xD	1xD
									●							18+20	80-110	0,170-0,185	0,5xD	1xD
									●							20+25	80-110	0,190-0,205	0,5xD	1xD

PER LAVORAZIONI A SPALLAMENTO AUMENTARE I PARAMETRI DEL 20%
FOR SHOULDER MILLING PARAMETERS SHOULD BE INCREASED BY 20%

- APPLICAZIONE CONSIGLIATA-RECOMMENDED APPLICATION
EMPFOHLENER EINSATZ - APPLICATION CONSEILLÉE
- APPLICAZIONE POSSIBILE - POSSIBLE APPLICATION
MÖGLICHE ANWENDUNG - APPLICATION POSSIBLE

Vc = m/min VELOCITÀ DI TAGLIO - CUTTING SPEED
 n = giri/min (min⁻¹) NUMERO DI GIRI - NUMBER OF REVOLUTIONS
 fz = mm AVANZAMENTO AL DENTE -TOOTH FEED
 fn = mm AVANZAMENTO AL GIRO - FEED / REVOLUTION
 Vf = mm/min VELOCITÀ DI AVANZAMENTO - FEED SPEED

$$n = \frac{Vc \cdot 1000}{\varnothing D \cdot 3,14} = \text{giri/min (min}^{-1}\text{)}$$

$$fn = fz \cdot z = \text{mm}$$

$$Vf = fz \cdot z \cdot n = \text{mm/min}$$

SM3417..N01

ØD = 6 - 25

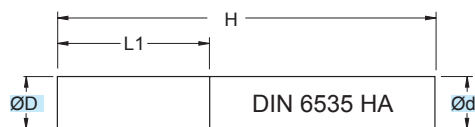

90°	ALU ≤5% Si

Fresa in M.D.I. Micrograno
 Gambo cilindrico HA

Micrograin HM mills
 Cylindrical Shank HA

TOLLERANZE	D	d
TOLERANCE RANGE	h10	h6

ART.	(mm)				
	ØD	Ød	L1	H	z
SM3417.060.N01	6	6	16	60	3
SM3417.080.N01	8	8	25	78	3
SM3417.100.N01	10	10	28	78	3
SM3417.120.N01	12	12	32	89	3
SM3417.140.N01	14	14	32	89	3
SM3417.160.N01	16	16	36	96	3
SM3417.200.N01	20	20	45	111	3
SM3417.250.N01	25	25	50	126	3

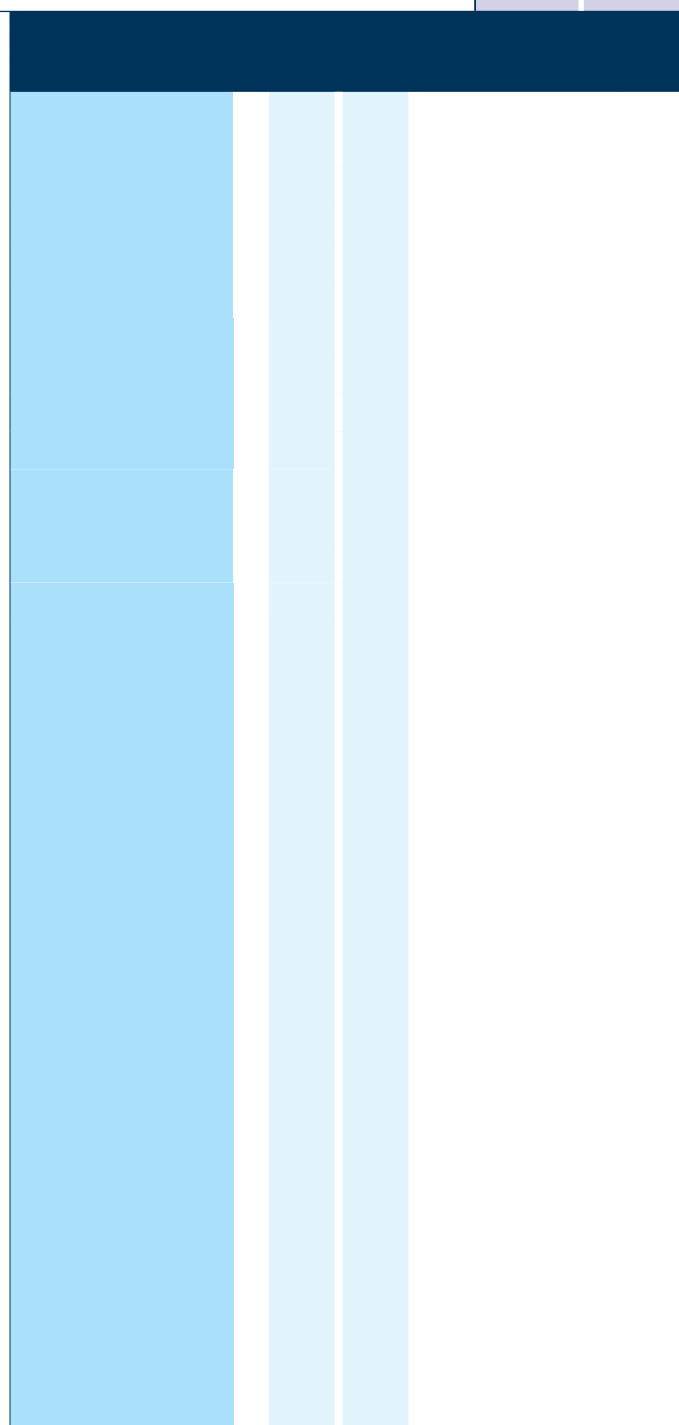

Applicazione - Application

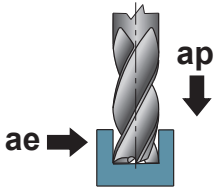

	P		M	K			N		S	H	G	(mm) ØD	(m/min) Vc	(mm) fz	(mm) ap	(mm) ae			
	ACCIAIO NON LEGATO NOT ALLOY STEEL	ACCIAIO POCO LEGATO LOW ALLOY STEEL	ACCIAIO ALTO LEGATO ALLOY STEEL	INOX MARTENSITICO STAINLESS STEEL MART.	INOX AUST. DUPLEX STAINLESS STEEL AUST.	GHISA GRIGIA GREY CAST IRON	GHISA SFEROIDALE SPHEROIDAL GRAPHITE	GHISA MALLEABILE MALLEABLE CAST IRON	ALLUMINIO Si ≤ 12% ALUMINIUM 12 ≤ 12%	ALLUMINIO Si > 12% ALUMINIUM 12 > 12%	NON METALLICI PLASTICS						LEGHE RESIST. CALORE HIGH TEMP. ALLOY	TITANIO E SUE LEGHE TITANIUM	ACCIAIO TEMPRATO HARDENED STEEL
								●							6+8	250-350	0,030-0,045	0,5xD	1xD
								●							8+10	250-350	0,040-0,055	0,5xD	1xD
								●							10+12	250-350	0,050-0,065	0,5xD	1xD
								●							12+14	250-350	0,090-0,105	0,5xD	1xD
								●							14+16	250-350	0,110-0,125	0,5xD	1xD
								●							16+18	250-350	0,130-0,145	0,5xD	1xD
								●							18+20	250-350	0,150-0,165	0,5xD	1xD
								●							20+25	250-350	0,170-0,185	0,5xD	1xD
								●							6+8	130-160	0,030-0,045	0,5xD	1xD
								●							8+10	130-160	0,040-0,055	0,5xD	1xD
								●							10+12	130-160	0,050-0,065	0,5xD	1xD
								●							12+14	130-160	0,090-0,105	0,5xD	1xD
								●							14+16	130-160	0,110-0,125	0,5xD	1xD
								●							16+18	130-160	0,130-0,145	0,5xD	1xD
								●							18+20	130-160	0,150-0,165	0,5xD	1xD
								●							20+25	130-160	0,170-0,185	0,5xD	1xD
										●					6+8	80-110	0,045-0,060	0,5xD	1xD
										●					8+10	80-110	0,060-0,075	0,5xD	1xD
										●					10+12	80-110	0,080-0,095	0,5xD	1xD
										●					12+14	80-110	0,100-0,115	0,5xD	1xD
										●					14+16	80-110	0,130-0,145	0,5xD	1xD
										●					16+18	80-110	0,150-0,165	0,5xD	1xD
										●					18+20	80-110	0,170-0,185	0,5xD	1xD
										●					20+25	80-110	0,190-0,205	0,5xD	1xD

PER LAVORAZIONI A SPALLAMENTO AUMENTARE I PARAMETRI DEL 20%
FOR SHOULDER MILLING PARAMETERS SHOULD BE INCREASED BY 20%

- APPLICAZIONE CONSIGLIATA-RECOMMENDED APPLICATION
EMPFÖHLENER EINSATZ - APPLICATION CONSEILLÉE
- APPLICAZIONE POSSIBILE - POSSIBLE APPLICATION
MÖGLICHE ANWENDUNG - APPLICATION POSSIBLE

Vc = m/min VELOCITÀ DI TAGLIO - CUTTING SPEED
n = giri/min (min⁻¹) NUMERO DI GIRI - NUMBER OF REVOLUTIONS
fz = mm AVANZAMENTO AL DENTE -TOOTH FEED
fn = mm AVANZAMENTO AL GIRO - FEED / REVOLUTION
Vf = mm/min VELOCITÀ DI AVANZAMENTO - FEED SPEED

$$n = \frac{Vc \cdot 1000}{\text{ØD} \cdot 3,14} = \text{giri/min (min}^{-1}\text{)}$$

$$fn = fz \cdot z = \text{mm}$$

$$Vf = fz \cdot z \cdot n = \text{mm/min}$$

SMW3414

ØD = 8 - 25

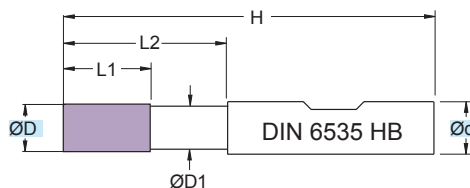

RIVESTIM.
COATED
GOLD



90°

ALU
>5% Si



Fresa in M.D.I. Micrograno
 Gambo sec. DIN 6535 HB

Micrograin HM mills
 DIN 6535 HB Shank

TOLLERANZE	D	d
TOLLERANCE RANGE	h10	h6

(mm)							
ART.	ØD	Ød	ØD1	L1	L2	H	z
SMW3414.080.N00	8	8	7,4	19	35	72	3
SMW3414.100.N00	10	10	9,2	22	43	84	3
SMW3414.120.N00	12	12	11,0	26	51	97	3
SMW3414.160.N00	16	16	15,0	32	59	108	3
SMW3414.200.N00	20	20	19,0	38	71	122	3
SMW3414.250.N00	25	25	24,0	45	87	144	3

Applicazione - Application

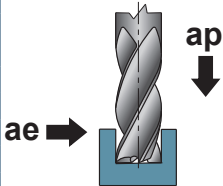

	MATERIALI - MATERIALS													(mm) ØD	(m/min) Vc	(mm) fz	(mm) ap	(mm) ae		
	P			M	K			N			S	H	G							
	ACCIAIO NON LEGATO NOT ALLOY STEEL	ACCIAIO POCO LEGATO LOW ALLOY STEEL	ACCIAIO ALTO LEGATO ALLOY STEEL	INOX MARTENSITICO STAINLESS STEEL MART.	INOX AUST. DUPLEX STAINLESS STEEL AUST.	GHISA GRIGIA GREY CAST IRON	GHISA SFEROIDALE SPHEROIDAL GRAPHITE	GHISA MALLEABILE MALLEABLE CAST IRON	ALLUMINIO E SUE LEGHE ALUMINIUM	RAME E SUE LEGHE COPPER	NON METALLICI PLASTICS	LEGHE RESIST. CALORE HIGH TEMP. ALLOY	TITANIO E SUE LEGHE TITANIUM	ACCIAIO TEMPRATO HARDENED STEEL	GRAFITE GRAPHITE					
									●							8	450-550	0,070-0,085	6,4	1xD
									●							10	450-550	0,090-0,105	8,0	1xD
									●							12	450-550	0,110-0,125	9,6	1xD
									●							16	450-550	0,150-0,165	12,8	1xD
									●							20	450-550	0,190-0,205	16,0	1xD
									●							25	450-550	0,240-0,255	20,0	1xD
									●							8	240-300	0,070-0,085	6,4	1xD
									●							10	240-300	0,090-0,105	8,0	1xD
									●							12	240-300	0,110-0,125	9,6	1xD
									●							16	240-300	0,150-0,165	12,8	1xD
									●							20	240-300	0,190-0,205	16,0	1xD
									●							25	240-300	0,240-0,255	20,0	1xD
											●					8	650-900	0,070-0,085	6,4	1xD
											●					10	650-900	0,090-0,105	8,0	1xD
											●					12	650-900	0,110-0,125	9,6	1xD
											●					16	650-900	0,150-0,165	12,8	1xD
											●					20	650-900	0,190-0,205	16,0	1xD
											●					25	650-900	0,240-0,255	20,0	1xD

PER LAVORAZIONI A SPALLAMENTO AUMENTARE I PARAMETRI DEL 20%
FOR SHOULDER MILLING PARAMETERS SHOULD BE INCREASED BY 20%

- APPLICAZIONE CONSIGLIATA-RECOMMENDED APPLICATION
EMPFOLHENER EINSATZ - APPLICATION CONSEILLÉE
- APPLICAZIONE POSSIBILE - POSSIBLE APPLICATION
MÖGLICHE ANWENDUNG - APPLICATION POSSIBLE

Vc = m/min VELOCITÀ DI TAGLIO - CUTTING SPEED

n = giri/min (min⁻¹) NUMERO DI GIRI - NUMBER OF REVOLUTIONS

fz = mm AVANZAMENTO AL DENTE -TOOTH FEED

fn = mm AVANZAMENTO AL GIRO - FEED / REVOLUTION

Vf = mm/min VELOCITÀ DI AVANZAMENTO - FEED SPEED

$$n = \frac{Vc \cdot 1000}{\text{ØD} \cdot 3,14} = \text{giri/min (min}^{-1}\text{)}$$

$$fn = fz \cdot z = \text{mm}$$

$$Vf = fz \cdot z \cdot n = \text{mm/min}$$

SMW3414..N01

ØD = 8 - 25

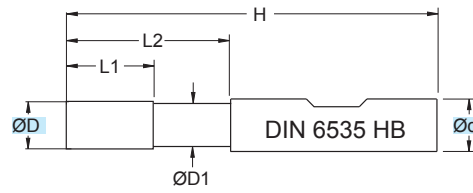

Fresa in M.D.I. Micrograno
 Gambo sec. DIN 6535 HB

Micrograin HM mills
 DIN 6535 HB Shank

TOLLERANZE	D	d
TOLLERANCE RANGE	h10	h6

90°
ALU ≤5% Si

ART.	(mm)						
	ØD	Ød	ØD1	L1	L2	H	z
SMW3414.080.N01	8	8	7,4	19	35	72	3
SMW3414.100.N01	10	10	9,2	22	43	84	3
SMW3414.120.N01	12	12	11,0	26	51	97	3
SMW3414.160.N01	16	16	15,0	32	59	108	3
SMW3414.200.N01	20	20	19,0	38	71	122	3
SMW3414.250.N01	25	25	24,0	45	87	144	3

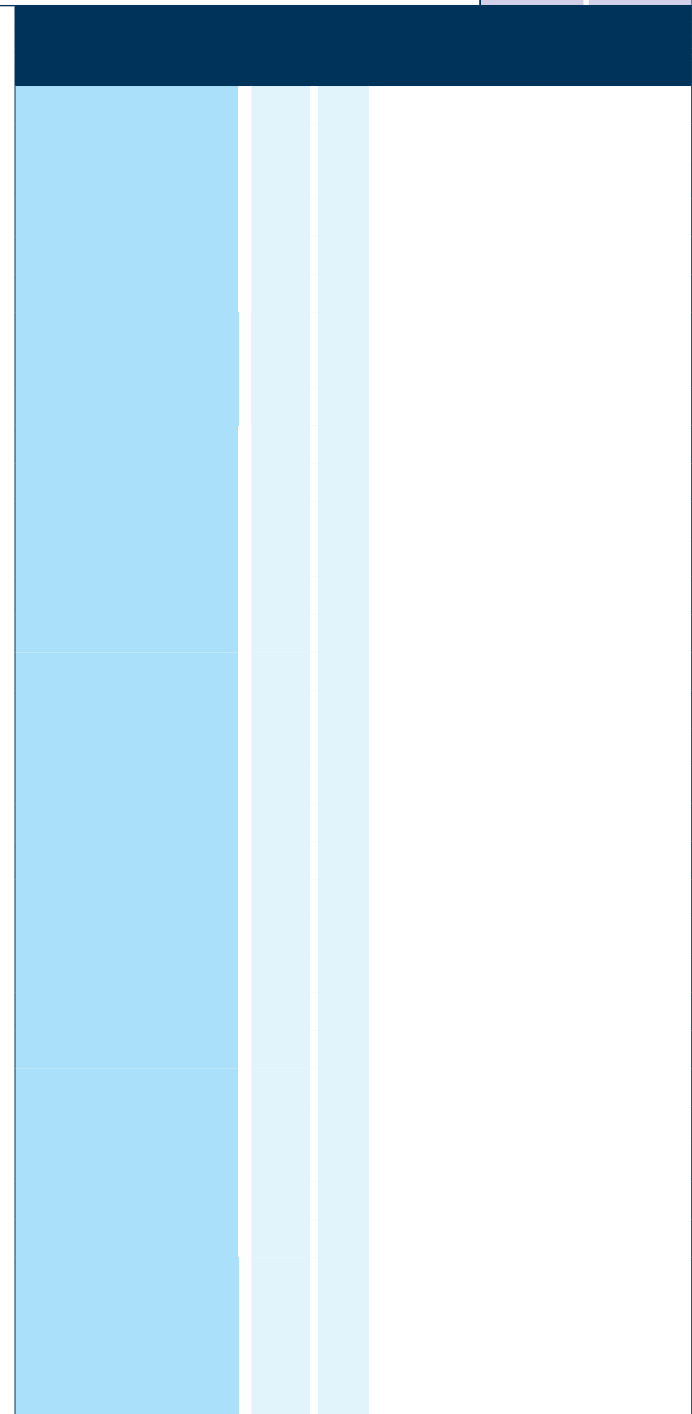

Applicazione - Application

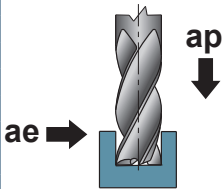

	MATERIALI - MATERIALS											(mm) ØD	(m/min) Vc	(mm) fz	(mm) ap	(mm) ae				
	P	M	K			N			S	H	G									
	ACCIAIO NON LEGATO NOT ALLOY STEEL	ACCIAIO POCO LEGATO LOW ALLOY STEEL	ACCIAIO ALTO LEGATO ALLOY STEEL	INOX MARTENSITICO STAINLESS STEEL MART.	INOX AUST. DUPLEX STAINLESS STEEL AUST.	GHISA GRIGIA GREY CAST IRON	GHISA SFEROIDALE SPHEROIDAL GRAPHITE	GHISA MALLEABILE MALLEABLE CAST IRON	ALLUMINIO E SUE LEGHE ALUMINIUM	RAME E SUE LEGHE COPPER	NON METALLICI PLASTICS	LEGHE RESIST. CALORE HIGH TEMP. ALLOY	TITANIO E SUE LEGHE TITANIUM	ACCIAIO TEMPRATO HARDENED STEEL	GRAFITE GRAPHITE					
●								●								8	450-550	0,070-0,085	6,4	1xD
								●								10	450-550	0,090-0,105	8,0	1xD
								●								12	450-550	0,110-0,125	9,6	1xD
								●								16	450-550	0,150-0,165	12,8	1xD
								●								20	450-550	0,190-0,205	16,0	1xD
								●								25	450-550	0,240-0,255	20,0	1xD
									●							8	240-300	0,070-0,085	6,4	1xD
									●							10	240-300	0,090-0,105	8,0	1xD
									●							12	240-300	0,110-0,125	9,6	1xD
									●							16	240-300	0,150-0,165	12,8	1xD
									●							20	240-300	0,190-0,205	16,0	1xD
									●							25	240-300	0,240-0,255	20,0	1xD
										●						8	650-900	0,070-0,085	6,4	1xD
										●						10	650-900	0,090-0,105	8,0	1xD
										●						12	650-900	0,110-0,125	9,6	1xD
										●						16	650-900	0,150-0,165	12,8	1xD
										●						20	650-900	0,190-0,205	16,0	1xD
										●						25	650-900	0,240-0,255	20,0	1xD

PER LAVORAZIONI A SPALLAMENTO AUMENTARE I PARAMETRI DEL 20%
FOR SHOULDER MILLING PARAMETERS SHOULD BE INCREASED BY 20%

- APPLICAZIONE CONSIGLIATA-RECOMMENDED APPLICATION
EMPFÖHLENER EINSATZ - APPLICATION CONSEILLÉE
- APPLICAZIONE POSSIBILE - POSSIBLE APPLICATION
MÖGLICHE ANWENDUNG - APPLICATION POSSIBLE

Vc = m/min VELOCITÀ DI TAGLIO - CUTTING SPEED

n = giri/min (min⁻¹) NUMERO DI GIRI - NUMBER OF REVOLUTIONS

fz = mm AVANZAMENTO AL DENTE -TOOTH FEED

fn = mm AVANZAMENTO AL GIRO - FEED / REVOLUTION

Vf = mm/min VELOCITÀ DI AVANZAMENTO - FEED SPEED

$$n = \frac{Vc \cdot 1000}{\text{ØD} \cdot 3,14} = \text{giri/min (min}^{-1}\text{)}$$

$$fn = fz \cdot z = \text{mm}$$

$$Vf = fz \cdot z \cdot n = \text{mm/min}$$

SM3510

ØD = 4 - 20



Fresa in M.D.I. Micrograno
 Gambo cilindrico HA/HB

Micrograin HM mills
 Cylindrical Shank HA/HB

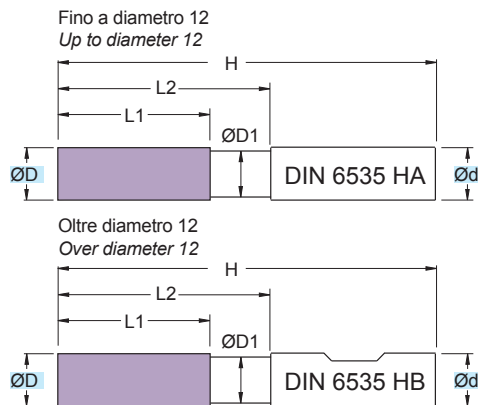

TOLLERANZE TOLERANCE RANGE	D h6	d h6
-------------------------------	---------	---------

RIVESTIM.
COATED
GOLD



45°

ALU
>5% Si



HSC

ART.	(mm)							
	ØD	Ød	ØD1	L1	L2	H	z	45°
SM3510.040.N00	4	6	3,7	11	18	57	3	0,1
SM3510.050.N00	5	6	4,7	13	18	57	3	0,1
SM3510.060.N00	6	6	5,7	13	18	57	3	0,2
SM3510.080.N00	8	8	7,4	21	25	63	3	0,2
SM3510.100.N00	10	10	9,2	22	30	72	3	0,2
SM3510.120.N00	12	12	11,0	26	36	83	3	0,2
SM3510.160.N00	16	16	15,0	36	42	92	3	0,2
SM3510.180.N00	18	18	17,0	36	42	92	3	0,2
SM3510.200.N00	20	20	19,0	41	52	104	3	0,2

SM3510..N01

ØD = 4 - 20



Fresa in M.D.I. Micrograno
 Gambo cilindrico HA/HB

Micrograin HM mills
 Cylindrical Shank HA/HB

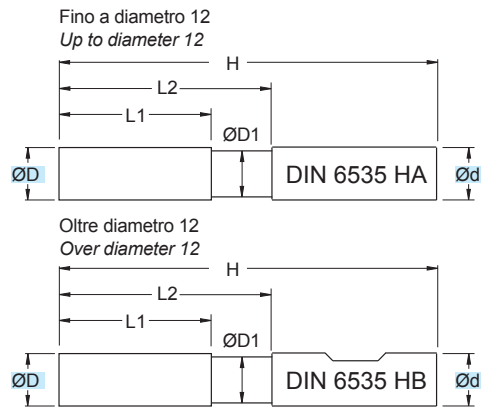

TOLLERANZE	D	d
TOLLERANCE RANGE	h6	h6

45°

ALU
 ≤5% Si

HSC

ART.	(mm)							
	ØD	Ød	ØD1	L1	L2	H	z	45°
SM3510.040.N01	4	6	3,7	11	18	57	3	0,1
SM3510.050.N01	5	6	4,7	13	18	57	3	0,1
SM3510.060.N01	6	6	5,7	13	18	57	3	0,2
SM3510.080.N01	8	8	7,4	21	25	63	3	0,2
SM3510.100.N01	10	10	9,2	22	30	72	3	0,2
SM3510.120.N01	12	12	11,0	26	36	83	3	0,2
SM3510.160.N01	16	16	15,0	36	42	92	3	0,2
SM3510.180.N01	18	18	17,0	36	42	92	3	0,2
SM3510.200.N01	20	20	19,0	41	52	104	3	0,2

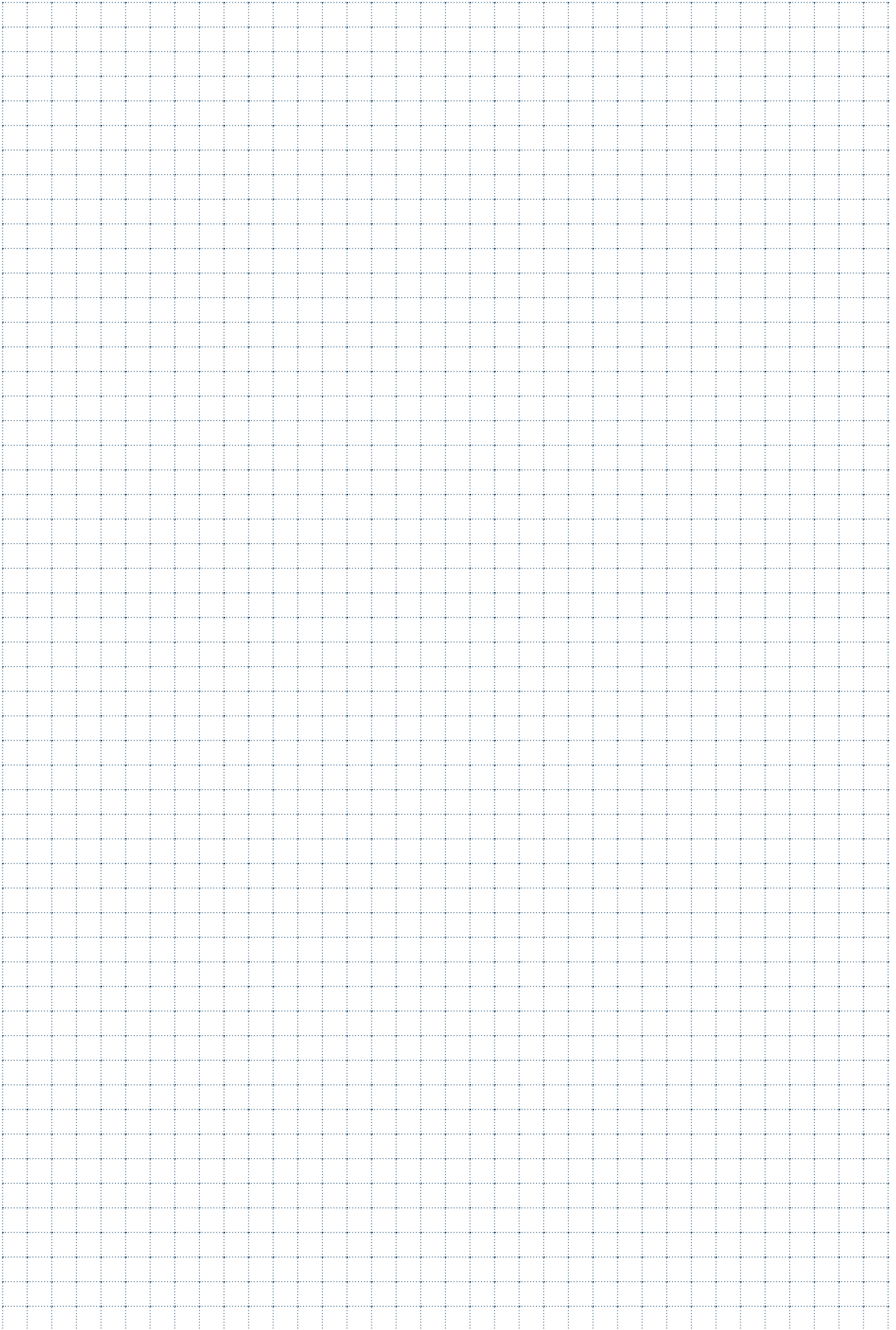



FRESE A 2 TAGLI

MILLING 2 CUTTINGS / ZWEISCHNEIDER / FRAISES A 2 COUPES /
FRESAS DE 2 FILOS

SMW2200

$\varnothing D = 2 - 20$

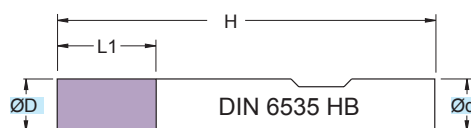
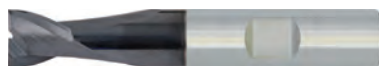

RIVESTIM.
COATED
BLACK



90°

**42
HRC**



Fresa in M.D.I. Micrograno
 Gambo sec. DIN 6535 HB

Micrograin HM mills
 DIN 6535 HB Shank

TOLLERANZE	D	d
TOLLERANCE RANGE	h10	h6

ART.	(mm)				
	$\varnothing D$	$\varnothing d$	L1	H	z
SMW2200.020.N00	2	3	3	38	2
SMW2200.030.N00	3	3	4	38	2
SMW2200.040.N00	4	6	5	54	2
SMW2200.050.N00	5	6	6	54	2
SMW2200.060.N00	6	6	7	54	2
SMW2200.080.N00	8	8	9	58	2
SMW2200.100.N00	10	10	11	66	2
SMW2200.120.N00	12	12	12	73	2
SMW2200.140.N00	14	14	14	75	2
SMW2200.160.N00	16	16	16	82	2
SMW2200.180.N00	18	18	18	84	2
SMW2200.200.N00	20	20	20	92	2

Applicazione - Application

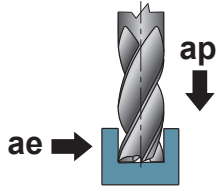

	MATERIALI - MATERIALS										ØD (mm)	Vc (m/min)	fz (mm)	ap (mm)	ae (mm)					
	P	M	K			N			S	H						G				
	ACCIAIO NON LEGATO NOT ALLOY STEEL	ACCIAIO POCO LEGATO LOW ALLOY STEEL	ACCIAIO ALTO LEGATO ALLOY STEEL	INOX MARTENSITICO STAINLESS STEEL MART.	INOX AUST. DUPLEX STAINLESS STEEL AUST.	GHISA GRIGIA GREY CAST IRON	GHISA SFEROIDALE SPHEROIDAL GRAPHITE	GHISA MALLEABILE MALLEABLE CAST IRON	ALLUMINIO E SUE LEGHE ALUMINIUM	RAME E SUE LEGHE COPPER	NON METALLICI PLASTICS	LEGHE RESIST. CALORE HIGH TEMP. ALLOY	TITANIO E SUE LEGHE TITANIUM	ACCIAIO TEMPRATO HARDENED STEEL	GRAFITE GRAPHITE					
●																2	80-110	0,003-0,013	0,5xD	1xD
●																3	80-110	0,003-0,015	0,5xD	1xD
●																4	80-110	0,005-0,020	0,5xD	1xD
●																5	80-110	0,008-0,023	0,5xD	1xD
●																6	80-110	0,010-0,025	0,5xD	1xD
●																8	80-110	0,015-0,030	0,5xD	1xD
●																10	80-110	0,020-0,035	0,5xD	1xD
●																12	80-110	0,025-0,040	0,5xD	1xD
●																14	80-110	0,030-0,045	0,5xD	1xD
●																16	80-110	0,035-0,050	0,5xD	1xD
●																18	80-110	0,040-0,055	0,5xD	1xD
●																20	80-110	0,050-0,065	0,5xD	1xD
○																2	50-80	0,003-0,013	0,5xD	1xD
○																3	50-80	0,003-0,015	0,5xD	1xD
○																4	50-80	0,005-0,020	0,5xD	1xD
○																5	50-80	0,008-0,023	0,5xD	1xD
○																6	50-80	0,010-0,025	0,5xD	1xD
○																8	50-80	0,012-0,027	0,5xD	1xD
○																10	50-80	0,015-0,030	0,5xD	1xD
○																12	50-80	0,020-0,035	0,5xD	1xD
○																14	50-80	0,025-0,040	0,5xD	1xD
○																16	50-80	0,030-0,045	0,5xD	1xD
○																18	50-80	0,035-0,050	0,5xD	1xD
○																20	50-80	0,040-0,055	0,5xD	1xD
○					●											2	25-50	0,003-0,011	0,5xD	1xD
○					●											3	25-50	0,003-0,013	0,5xD	1xD
○					●											4	25-50	0,003-0,015	0,5xD	1xD
○					●											5	25-50	0,002-0,017	0,5xD	1xD
○					●											6	25-50	0,005-0,020	0,5xD	1xD
○					●											8	25-50	0,008-0,023	0,5xD	1xD
○					●											10	25-50	0,010-0,025	0,5xD	1xD
○					●											12	25-50	0,015-0,030	0,5xD	1xD
○					●											14	25-50	0,020-0,035	0,5xD	1xD
○					●											16	25-50	0,025-0,040	0,5xD	1xD
○					●											18	25-50	0,030-0,045	0,5xD	1xD
○					●											20	25-50	0,035-0,050	0,5xD	1xD
○					●	●										2	100-130	0,003-0,013	0,5xD	1xD
○					●	●										3	100-130	0,003-0,015	0,5xD	1xD
○					●	●										4	100-130	0,003-0,015	0,5xD	1xD
○					●	●										5	100-130	0,005-0,020	0,5xD	1xD
○					●	●										6	100-130	0,010-0,025	0,5xD	1xD
○					●	●										8	100-130	0,015-0,030	0,5xD	1xD
○					●	●										10	100-130	0,020-0,035	0,5xD	1xD
○					●	●										12	100-130	0,025-0,040	0,5xD	1xD
○					●	●										14	100-130	0,030-0,045	0,5xD	1xD
○					●	●										16	100-130	0,040-0,055	0,5xD	1xD
○					●	●										18	100-130	0,045-0,060	0,5xD	1xD
○					●	●										20	100-130	0,050-0,065	0,5xD	1xD
○					●	●										2	100-130	0,003-0,013	0,5xD	1xD
○					●	●										3	100-130	0,003-0,015	0,5xD	1xD
○					●	●										4	100-130	0,003-0,015	0,5xD	1xD
○					●	●										5	100-130	0,005-0,020	0,5xD	1xD
○					●	●										6	100-130	0,010-0,025	0,5xD	1xD
○					●	●										8	100-130	0,015-0,030	0,5xD	1xD
○					●	●										10	100-130	0,020-0,035	0,5xD	1xD
○					●	●										12	100-130	0,025-0,040	0,5xD	1xD
○					●	●										14	100-130	0,030-0,045	0,5xD	1xD
○					●	●										16	100-130	0,040-0,055	0,5xD	1xD
○					●	●										18	100-130	0,045-0,060	0,5xD	1xD
○					●	●										20	100-130	0,050-0,065	0,5xD	1xD

● APPLICAZIONE CONSIGLIATA-RECOMMENDED APPLICATION
EMPFOLHENER EINSATZ - APPLICATION CONSEILLÉE

○ APPLICAZIONE POSSIBILE - POSSIBLE APPLICATION
MÖGLICHE ANWENDUNG - APPLICATION POSSIBLE

Vc = m/min VELOCITÀ DI TAGLIO - CUTTING SPEED

n = giri/min (min⁻¹) NUMERO DI GIRI - NUMBER OF REVOLUTIONS

fz = mm AVANZAMENTO AL DENTE -TOOTH FEED

fn = mm AVANZAMENTO AL GIRO - FEED / REVOLUTION

Vf = mm/min VELOCITÀ DI AVANZAMENTO - FEED SPEED

$$n = \frac{Vc \cdot 1000}{\text{ØD} \cdot 3,14} = \text{giri/min (min}^{-1}\text{)}$$

$$fn = fz \cdot z = \text{mm}$$

$$Vf = fz \cdot z \cdot n = \text{mm/min}$$

SMW2300

ØD = 2 - 20

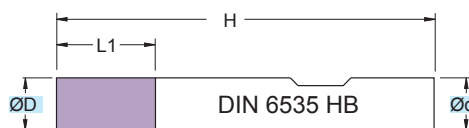

RIVESTIM.
 COATED
BLACK



90°

**42
 HRC**



Fresa in M.D.I. Micrograno
 Gambo sec. DIN 6535 HB

Micrograin HM mills
 DIN 6535 HB Shank

TOLLERANZE	D	d
TOLLERANCE RANGE	h10	h6

ART.	(mm)				
	ØD	Ød	L1	H	z
SMW2300.020.N00	2,0	3	6	38	2
SMW2300.025.N00	2,5	3	6	38	2
SMW2300.030.N00	3,0	3	7	38	2
SMW2300.035.N00	3,5	6	8	57	2
SMW2300.040.N00	4,0	6	8	57	2
SMW2300.045.N00	4,5	6	10	57	2
SMW2300.047.N00	4,7	6	10	57	2
SMW2300.050.N00	5,0	6	10	57	2
SMW2300.055.N00	5,5	6	10	57	2
SMW2300.057.N00	5,7	6	10	57	2
SMW2300.060.N00	6,0	6	10	57	2
SMW2300.070.N00	7,0	8	16	63	2
SMW2300.077.N00	7,7	8	16	63	2
SMW2300.080.N00	8,0	8	16	63	2
SMW2300.097.N00	9,7	10	19	72	2
SMW2300.100.N00	10,0	10	19	72	2
SMW2300.117.N00	11,7	12	22	83	2
SMW2300.120.N00	12,0	12	22	83	2
SMW2300.137.N00	13,7	14	22	83	2
SMW2300.140.N00	14,0	14	22	83	2
SMW2300.157.N00	15,7	16	26	92	2
SMW2300.160.N00	16,0	16	26	92	2
SMW2300.180.N00	18,0	18	26	92	2
SMW2300.200.N00	20,0	20	32	104	2

SMW2203

ØD = 2,5 - 20

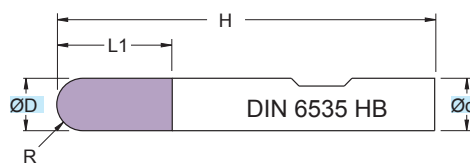
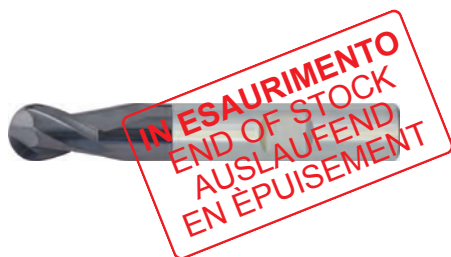

RIVESTIM.
 COATED
BLACK



R

**42
 HRC**



Fresa in M.D.I. Micrograno
 Gambo sec. DIN 6535 HB

Micrograin HM mills
 DIN 6527 Shank HB

TOLLERANZE	D	d
TOLLERANCE RANGE	h10	h6

ART.	(mm)					
	ØD	Ød	L1	H	R	z
SMW2203.025.S012	2,5	6	4	50	1,25	2
SMW2203.030.S015	3,0	6	5	50	1,5	2
SMW2203.035.S017	3,5	6	5	50	1,75	2
SMW2203.040.S020	4,0	6	6	54	2,0	2
SMW2203.045.S022	4,5	6	6	54	2,25	2
SMW2203.050.S025	5,0	6	7	54	2,5	2
SMW2203.060.S030	6,0	6	9	54	3,0	2
SMW2203.080.S040	8,0	8	12	58	4,0	2
SMW2203.100.S050	10,0	10	14	66	5,0	2
SMW2203.120.S060	12,0	12	14	73	6,0	2
SMW2203.140.S070	14,0	14	16	75	7,0	2
SMW2203.160.S080	16,0	16	18	82	8,0	2
SMW2203.180.S090	18,0	18	20	92	9,0	2
SMW2203.200.S100	20,0	20	22	92	10,0	2

Applicazione - Application

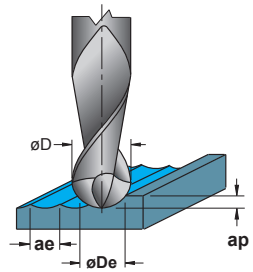

P	M	K	N	S	H	G	(mm) ØDe	(m/min) Vc	(mm) fz	(mm) ap	(mm) ae			
												ACCIAIO NON LEGATO NOT ALLOY STEEL	ACCIAIO POCO LEGATO LOW ALLOY STEEL	ACCIAIO ALTO LEGATO ALLOY STEEL
●							2,5	140-170	0,020-0,035	0,05xD	0,06xD			
●							3-4	140-170	0,035-0,050	0,05xD	0,06xD			
●							4-5	140-170	0,035-0,050	0,05xD	0,06xD			
●							5-8	140-170	0,035-0,050	0,05xD	0,06xD			
●							8-12	140-170	0,040-0,055	0,05xD	0,06xD			
●							12-16	140-170	0,070-0,085	0,05xD	0,06xD			
●							16-20	140-170	0,080-0,095	0,05xD	0,06xD			
	●						2,5	110-140	0,005-0,020	0,05xD	0,06xD			
	●						3-4	110-140	0,020-0,035	0,05xD	0,06xD			
	●						4-5	110-140	0,020-0,035	0,05xD	0,06xD			
	●						5-8	110-140	0,020-0,035	0,05xD	0,06xD			
	●						8-12	110-140	0,030-0,045	0,05xD	0,06xD			
	●						12-16	110-140	0,050-0,065	0,05xD	0,06xD			
	●						16-20	110-140	0,060-0,075	0,05xD	0,06xD			
	●						2,5	50-80	0,003-0,015	0,05xD	0,06xD			
	●						3-4	50-80	0,010-0,025	0,05xD	0,06xD			
	●						4-5	50-80	0,010-0,025	0,05xD	0,06xD			
	●						5-8	50-80	0,010-0,025	0,05xD	0,06xD			
	●						8-12	50-80	0,020-0,035	0,05xD	0,06xD			
	●						12-16	50-80	0,040-0,055	0,05xD	0,06xD			
	●						16-20	50-80	0,050-0,065	0,05xD	0,06xD			
	●						2,5	100-130	0,025-0,040	0,05xD	0,06xD			
	●						3-4	100-130	0,050-0,065	0,05xD	0,06xD			
	●						4-5	100-130	0,050-0,065	0,05xD	0,06xD			
	●						5-8	100-130	0,050-0,065	0,05xD	0,06xD			
	●						8-12	100-130	0,060-0,075	0,05xD	0,06xD			
	●						12-16	100-130	0,110-0,125	0,05xD	0,06xD			
	●						16-20	100-130	0,130-0,145	0,05xD	0,06xD			
	●						2,5	100-130	0,020-0,035	0,05xD	0,06xD			
	●						3-4	100-130	0,035-0,050	0,05xD	0,06xD			
	●						4-5	100-130	0,035-0,050	0,05xD	0,06xD			
	●						5-8	100-130	0,035-0,050	0,05xD	0,06xD			
	●						8-12	100-130	0,040-0,055	0,05xD	0,06xD			
	●						12-16	100-130	0,070-0,085	0,05xD	0,06xD			
	●						16-20	100-130	0,080-0,095	0,05xD	0,06xD			

● APPLICAZIONE CONSIGLIATA-RECOMMENDED APPLICATION
EMPFOLHENER EINSATZ - APPLICATION CONSEILLÉE

○ APPLICAZIONE POSSIBILE - POSSIBLE APPLICATION
MÖGLICHE ANWENDUNG - APPLICATION POSSIBLE

DATI TECNICI LAVORAZIONI PAG. 1152 - 1153
MACHINING TECHNICAL DATA PAGE 1152 - 1153
BEARBEITUNGSSCHNITTDATEN S. 1152 - 1153
DONNEES TECHNIQUES USINAGES PAGES 1152 - 1153

øD = mm DIAMETRO - DIAMETER

øDe = mm DIAMETRO EFFETTIVO - EFFECTIVE DIAMETER

Vc = m/min VELOCITÀ DI TAGLIO - CUTTING SPEED

n = giri/min (min⁻¹) NUMERO DI GIRI - NUMBER OF REVOLUTIONS

fz = mm AVANZAMENTO AL DENTE -TOOTH FEED

fn = mm AVANZAMENTO AL GIRO - FEED / REVOLUTION

Vf = mm/min VELOCITÀ DI AVANZAMENTO - FEED SPEED

$$n = \frac{Vc \cdot 1000}{\varnothing De \cdot 3,14} = \text{giri/min (min}^{-1}\text{)}$$

$$fn = fz \cdot z = \text{mm}$$

$$Vf = fz \cdot z \cdot n = \text{mm/min}$$

SM2203

ØD = 2 - 12

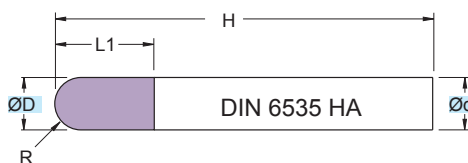

RIVESTIM.
 COATED
BLACK



R

**42
 HRC**



Fresa in M.D.I. Micrograno
 Gambo sec. DIN 6535 HB

Micrograin HM mills
 DIN 6527 Shank HB

TOLLERANZE	D	d
TOLLERANCE RANGE	h10	h6

ART.	(mm)					
	ØD	Ød	L1	H	R	z
SM2203.025.S012	2,5	6	4	50	1,25	2
SM2203.030.S015	3,0	6	5	50	1,5	2
SM2203.035.S017	3,5	6	5	50	1,75	2
SM2203.040.S020	4,0	6	6	54	2,0	2
SM2203.045.S022	4,5	6	6	54	2,25	2
SM2203.050.S025	5,0	6	7	54	2,5	2
SM2203.060.S030	6,0	6	9	54	3,0	2
SM2203.080.S040	8,0	8	12	58	4,0	2
SM2203.100.S050	10,0	10	14	66	5,0	2
SM2203.120.S060	12,0	12	14	73	6,0	2
SM2203.140.S070	14,0	14	16	75	7,0	2
SM2203.160.S080	16,0	16	18	82	8,0	2
SM2203.180.S090	18,0	18	20	92	9,0	2
SM2203.200.S100	20,0	20	22	92	10,0	2

Applicazione - Application

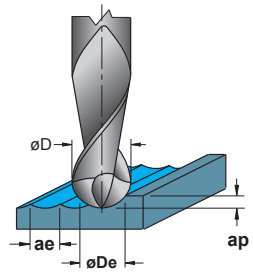

P	M	K	N	S	H	G	(mm) ØDe	(m/min) Vc	(mm) fz	(mm) ap	(mm) ae			
												ACCIAIO NON LEGATO NOT ALLOY STEEL	ACCIAIO POCO LEGATO LOW ALLOY STEEL	ACCIAIO ALTO LEGATO ALLOY STEEL
●							2,5	140-170	0,020-0,035	0,05xD	0,06xD			
●							3-4	140-170	0,035-0,050	0,05xD	0,06xD			
●							4-5	140-170	0,035-0,050	0,05xD	0,06xD			
●							5-8	140-170	0,035-0,050	0,05xD	0,06xD			
●							8-12	140-170	0,040-0,055	0,05xD	0,06xD			
●							12-16	140-170	0,070-0,085	0,05xD	0,06xD			
●							16-20	140-170	0,080-0,095	0,05xD	0,06xD			
	●						2,5	110-140	0,005-0,020	0,05xD	0,06xD			
	●						3-4	110-140	0,020-0,035	0,05xD	0,06xD			
	●						4-5	110-140	0,020-0,035	0,05xD	0,06xD			
	●						5-8	110-140	0,020-0,035	0,05xD	0,06xD			
	●						8-12	110-140	0,030-0,045	0,05xD	0,06xD			
	●						12-16	110-140	0,050-0,065	0,05xD	0,06xD			
	●						16-20	110-140	0,060-0,075	0,05xD	0,06xD			
		●					2,5	50-80	0,003-0,015	0,05xD	0,06xD			
		●					3-4	50-80	0,010-0,025	0,05xD	0,06xD			
		●					4-5	50-80	0,010-0,025	0,05xD	0,06xD			
		●					5-8	50-80	0,010-0,025	0,05xD	0,06xD			
		●					8-12	50-80	0,020-0,035	0,05xD	0,06xD			
		●					12-16	50-80	0,040-0,055	0,05xD	0,06xD			
		●					16-20	50-80	0,050-0,065	0,05xD	0,06xD			
			●				2,5	100-130	0,025-0,040	0,05xD	0,06xD			
			●				3-4	100-130	0,050-0,065	0,05xD	0,06xD			
			●				4-5	100-130	0,050-0,065	0,05xD	0,06xD			
			●				5-8	100-130	0,050-0,065	0,05xD	0,06xD			
			●				8-12	100-130	0,060-0,075	0,05xD	0,06xD			
			●				12-16	100-130	0,110-0,125	0,05xD	0,06xD			
			●				16-20	100-130	0,130-0,145	0,05xD	0,06xD			
				●			2,5	100-130	0,020-0,035	0,05xD	0,06xD			
				●			3-4	100-130	0,035-0,050	0,05xD	0,06xD			
				●			4-5	100-130	0,035-0,050	0,05xD	0,06xD			
				●			5-8	100-130	0,035-0,050	0,05xD	0,06xD			
				●			8-12	100-130	0,040-0,055	0,05xD	0,06xD			
				●			12-16	100-130	0,070-0,085	0,05xD	0,06xD			
				●			16-20	100-130	0,080-0,095	0,05xD	0,06xD			

● APPLICAZIONE CONSIGLIATA-RECOMMENDED APPLICATION
EMPFOLHENER EINSATZ - APPLICATION CONSEILLÉE

○ APPLICAZIONE POSSIBILE - POSSIBLE APPLICATION
MÖGLICHE ANWENDUNG - APPLICATION POSSIBLE

DATI TECNICI LAVORAZIONI PAG. 1152 - 1153
MACHINING TECHNICAL DATA PAGE 1152 - 1153
BEARBEITUNGSSCHNITTDATEN S. 1152 - 1153
DONNEES TECHNIQUES USINAGES PAGES 1152 - 1153

øD = mm DIAMETRO - DIAMETER

øDe = mm DIAMETRO EFFETTIVO - EFFECTIVE DIAMETER

Vc = m/min VELOCITÀ DI TAGLIO - CUTTING SPEED

n = giri/min (min⁻¹) NUMERO DI GIRI - NUMBER OF REVOLUTIONS

fz = mm AVANZAMENTO AL DENTE -TOOTH FEED

fn = mm AVANZAMENTO AL GIRO - FEED / REVOLUTION

Vf = mm/min VELOCITÀ DI AVANZAMENTO - FEED SPEED

$$n = \frac{Vc \cdot 1000}{\varnothing De \cdot 3,14} = \text{giri/min (min}^{-1}\text{)}$$

$$fn = fz \cdot z = \text{mm}$$

$$Vf = fz \cdot z \cdot n = \text{mm/min}$$

SM2424

ØD = 2 - 12

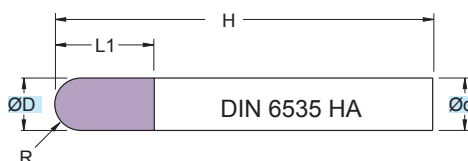

RIVESTIM.
 COATED
GRAY



R

**60
 HRC**

HSC



Fresa in M.D.I. Micrograno
 Gambo Cilindrico HA

Micrograin HM mills
 Cylindrical Shank HA

TOLLERANZE	D	d
TOLLERANCE RANGE	h10	h6

ART.	(mm)					
	ØD	Ød	L1	H	R	z
SM2424.020.S010	2,0	6,0	5	60	1,0	2
SM2424.030.S015	3,0	6,0	7	60	1,5	2
SM2424.040.S020	4,0	6,0	10	75	2,0	2
SM2424.050.S025	5,0	6,0	12	75	2,5	2
SM2424.060.S030	6,0	6,0	12	100	3,0	2
SM2424.080.S040	8,0	8,0	14	100	4,0	2
SM2424.100.S050	10,0	10,0	18	100	5,0	2
SM2424.120.S060	12,0	12,0	22	100	6,0	2

Applicazione - Application

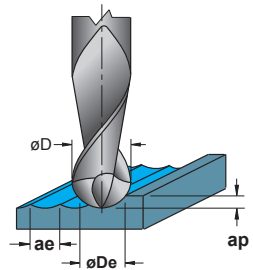

	MATERIALI - MATERIALS											(mm) ØDe	(m/min) Vc	(mm) fz	(mm) ap	(mm) ae				
	P	M	K			N			S	H	G									
	ACCIAIO NON LEGATO NOT ALLOY STEEL	ACCIAIO POCO LEGATO LOW ALLOY STEEL	ACCIAIO ALTO LEGATO ALLOY STEEL	INOX MARTENSITICO STAINLESS STEEL MART.	INOX AUST. DUPLEX STAINLESS STEEL AUST.	GHISA GRIGIA GREY CAST IRON	GHISA SFEROIDALE SPHEROIDAL GRAPHITE	GHISA MALLEABILE MALLEABLE CAST IRON	ALLUMINIO E SUE LEGHE ALUMINIUM	RAME E SUE LEGHE COPPER	NON METALLICI PLASTICS	LEGHE RESIST. CALORE HIGH TEMP. ALLOY	TITANIO E SUE LEGHE TITANIUM	ACCIAIO TEMPRATO HARDENED STEEL	GRAFITE GRAPHITE					
●																2	430-460	0,014-0,029	0,06	0,1
●																3	430-460	0,022-0,037	0,09	0,15
●																4	430-460	0,030-0,045	0,12	0,2
●																6	430-460	0,050-0,065	0,18	0,3
●																8	430-460	0,070-0,085	0,24	0,4
●																10	430-460	0,090-0,105	0,3	0,5
●																12	430-460	0,110-0,125	0,36	0,6
○																2	250-280	0,008-0,023	0,03	0,08
○																3	250-280	0,015-0,030	0,045	0,12
○																4	250-280	0,025-0,040	0,06	0,16
○																6	250-280	0,040-0,055	0,09	0,24
○																8	250-280	0,050-0,065	0,12	0,32
○																10	250-280	0,055-0,070	0,15	0,4
○																12	250-280	0,060-0,075	0,18	0,48
○																2	540-575	0,014-0,029	0,06	0,1
○																3	540-575	0,022-0,037	0,09	0,15
○																4	540-575	0,030-0,045	0,12	0,2
○																6	540-575	0,050-0,065	0,18	0,3
○																8	540-575	0,070-0,085	0,24	0,4
○																10	540-575	0,090-0,105	0,3	0,5
○																12	540-575	0,110-0,125	0,36	0,6
○																2	450-480	0,014-0,029	0,06	0,1
○																3	450-480	0,022-0,037	0,09	0,15
○																4	450-480	0,030-0,045	0,12	0,2
○																6	450-480	0,050-0,065	0,18	0,3
○																8	450-480	0,070-0,085	0,24	0,4
○																10	450-480	0,090-0,105	0,3	0,5
○																12	450-480	0,110-0,125	0,36	0,6
○																2	30-50	0,008-0,023	0,016	0,04
○																3	30-50	0,015-0,030	0,024	0,06
○																4	30-50	0,025-0,040	0,032	0,08
○																6	30-50	0,040-0,055	0,048	0,12
○																8	30-50	0,050-0,065	0,064	0,16
○																10	30-50	0,055-0,070	0,08	0,2
○																12	30-50	0,060-0,075	0,096	0,24
○																2	45-65	0,014-0,029	0,06	0,1
○																3	45-65	0,022-0,037	0,09	0,15
○																4	45-65	0,030-0,045	0,12	0,2
○																6	45-65	0,050-0,065	0,18	0,3
○																8	45-65	0,070-0,085	0,24	0,4
○																10	45-65	0,090-0,105	0,3	0,5
○																12	45-65	0,110-0,125	0,36	0,6
○																2	60-90	0,008-0,023	0,016	0,04
○																3	60-90	0,015-0,030	0,024	0,06
○																4	60-90	0,025-0,040	0,032	0,08
○																6	60-90	0,040-0,055	0,048	0,12
○																8	60-90	0,050-0,065	0,064	0,16
○																10	60-90	0,055-0,070	0,08	0,2
○																12	60-90	0,060-0,075	0,096	0,24

● APPLICAZIONE CONSIGLIATA-RECOMMENDED APPLICATION
EMPFOHLENER EINSATZ - APPLICATION CONSEILLÉE

○ APPLICAZIONE POSSIBILE - POSSIBLE APPLICATION
MÖGLICHE ANWENDUNG - APPLICATION POSSIBLE

øD = mm DIAMETRO - DIAMETER

øDe = mm DIAMETRO EFFETTIVO - EFFECTIVE DIAMETER

Vc = m/min VELOCITÀ DI TAGLIO - CUTTING SPEED

n = giri/min (min⁻¹) NUMERO DI GIRI - NUMBER OF REVOLUTIONS

fz = mm AVANZAMENTO AL DENTE -TOOTH FEED

fn = mm AVANZAMENTO AL GIRO - FEED / REVOLUTION

Vf = mm/min VELOCITÀ DI AVANZAMENTO - FEED SPEED

DATI TECNICI LAVORAZIONI PAG. 1152 - 1153
MACHINING TECHNICAL DATA PAGE 1152 - 1153
BEARBEITUNGSSCHNITTDATEN S. 1152 - 1153
DONNEES TECHNIQUES USINAGES PAGES 1152 - 1153

$$n = \frac{Vc \cdot 1000}{\text{øDe} \cdot 3,14} = \text{giri/min (min}^{-1}\text{)}$$

$$fn = fz \cdot z = \text{mm}$$

$$Vf = fz \cdot z \cdot n = \text{mm/min}$$

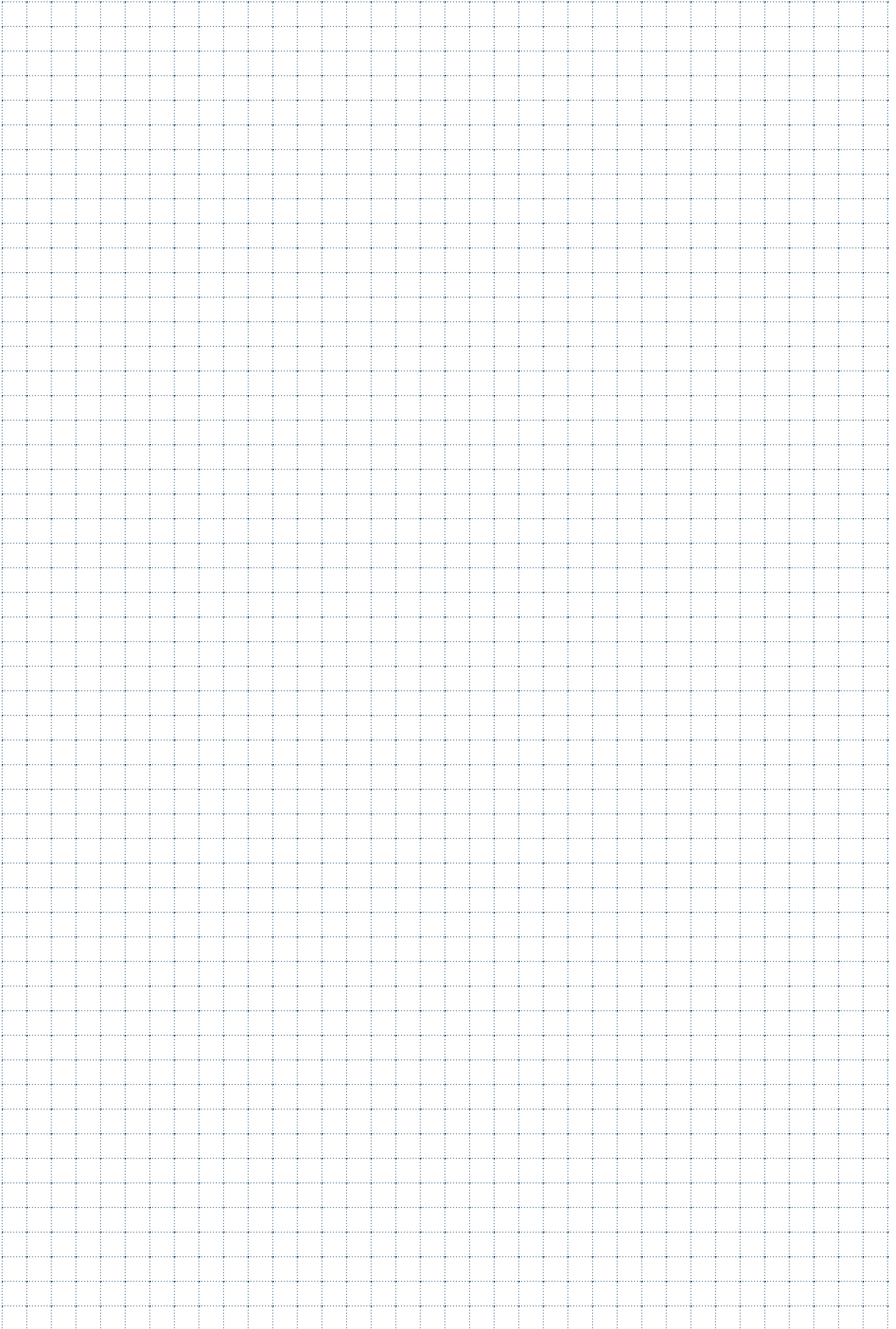



FRESE A 3 TAGLI

MILLING 3 CUTTINGS / DREISCHNEIDER / FRAISES A 3 COUPES /
FRESAS DE 3 FILOS

SMW3100

$\varnothing D = 2 - 20$

IN ESAURIMENTO
END OF STOCK
AUSLAUFEND
EN ÉPUISEMENT

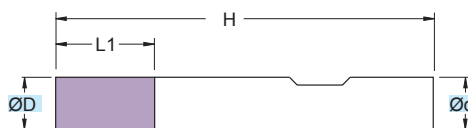

RIVESTIM.
 COATED
BLACK



90°

42 HRC



Fresa in M.D.I. Micrograno
 Gambo sec. norma di fabbrica

Micrograin HM mills
 Shank according to factory standard

TOLLERANZE	D	d
TOLLERANCE RANGE	h10	h6

ART.	(mm)				
	$\varnothing D$	$\varnothing d$	L1	H	z
SMW3100.020.N00	2	6	4	38	3
SMW3100.030.N00	3	6	5	38	3
SMW3100.040.N00	4	6	7	38	3
SMW3100.050.N00	5	6	8	38	3
SMW3100.060.N00	6	6	8	38	3
SMW3100.080.N00	8	8	11	43	3
SMW3100.100.N00	10	10	13	50	3
SMW3100.120.N00	12	12	15	55	3
SMW3100.160.N00	16	16	18	62	3
SMW3100.200.N00	20	20	22	75	3

Applicazione - Application

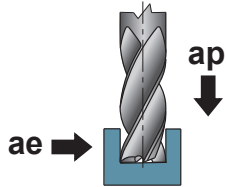

	MATERIALI - MATERIALS										ØD	Vc	fz	ap	ae				
	P	M	K			N			S	H						G			
	ACCIAIO NON LEGATO NOT ALLOY STEEL	ACCIAIO POCO LEGATO LOW ALLOY STEEL	ACCIAIO ALTO LEGATO ALLOY STEEL	INOX MARTENSITICO STAINLESS STEEL MART.	INOX AUST. DUPLEX STAINLESS STEEL AUST.	GHISA GRIGIA GREY CAST IRON	GHISA SFEROIDALE SPHEROIDAL GRAPHITE	GHISA MALLEABILE MALLEABLE CAST IRON	ALLUMINIO E SUE LEGHE ALUMINIUM	RAMME E SUE LEGHE COPPER	NON METALLICI PLASTICS	LEGHE RESIST. CALORE HIGH TEMP. ALLOY	TITANIO E SUE LEGHE TITANIUM	ACCIAIO TEMPRATO HARDENED STEEL	GRAFITE GRAPHITE				
●															2	100-130	0,003-0,013	1,0	1xD
●															3	100-130	0,003-0,015	1,5	1xD
●															4	100-130	0,005-0,020	2,0	1xD
●															5	100-130	0,008-0,023	2,5	1xD
●															6	100-130	0,010-0,025	3,0	1xD
●															8	100-130	0,015-0,030	4,0	1xD
●															10	100-130	0,020-0,035	5,0	1xD
●															12	100-130	0,025-0,040	6,0	1xD
●															16	100-130	0,030-0,045	8,0	1xD
●															20	100-130	0,035-0,050	10,0	1xD
●															2	60-90	0,003-0,013	1,0	1xD
●															3	60-90	0,003-0,015	1,5	1xD
●															4	60-90	0,005-0,020	2,0	1xD
●															5	60-90	0,008-0,023	2,5	1xD
●															6	60-90	0,010-0,025	3,0	1xD
●															8	60-90	0,015-0,030	4,0	1xD
●															10	60-90	0,020-0,035	5,0	1xD
●															12	60-90	0,025-0,040	6,0	1xD
●															16	60-90	0,030-0,045	8,0	1xD
●															20	60-90	0,035-0,050	10,0	1xD
●		●													2	40-70	0,003-0,013	1,0	1xD
●		●													3	40-70	0,003-0,015	1,5	1xD
●		●													4	40-70	0,005-0,020	2,0	1xD
●		●													5	40-70	0,008-0,023	2,5	1xD
●		●													6	40-70	0,010-0,025	3,0	1xD
●		●													8	40-70	0,015-0,030	4,0	1xD
●		●													10	40-70	0,020-0,035	5,0	1xD
●		●													12	40-70	0,025-0,040	6,0	1xD
●		●													16	40-70	0,030-0,045	8,0	1xD
●		●													20	40-70	0,035-0,050	10,0	1xD
●			●												2	30-60	0,003-0,010	1,0	1xD
●			●												3	30-60	0,003-0,013	1,5	1xD
●			●												4	30-60	0,003-0,015	2,0	1xD
●			●												5	30-60	0,002-0,017	2,5	1xD
●			●												6	30-60	0,005-0,020	3,0	1xD
●			●												8	30-60	0,008-0,023	4,0	1xD
●			●												10	30-60	0,010-0,025	5,0	1xD
●			●												12	30-60	0,015-0,030	6,0	1xD
●			●												16	30-60	0,020-0,035	8,0	1xD
●			●												20	30-60	0,025-0,040	10,0	1xD
●				●											2	125-155	0,003-0,013	1,0	1xD
●				●											3	125-155	0,003-0,015	1,5	1xD
●				●											4	125-155	0,005-0,020	2,0	1xD
●				●											5	125-155	0,008-0,023	2,5	1xD
●				●											6	125-155	0,010-0,025	3,0	1xD
●				●											8	125-155	0,015-0,030	4,0	1xD
●				●											10	125-155	0,020-0,035	5,0	1xD
●				●											12	125-155	0,025-0,040	6,0	1xD
●				●											16	125-155	0,030-0,045	8,0	1xD
●				●											20	125-155	0,035-0,050	10,0	1xD
○							●								2	100-130	0,003-0,013	1,0	1xD
○							●								3	100-130	0,003-0,015	1,5	1xD
○							●								4	100-130	0,005-0,020	2,0	1xD
○							●								5	100-130	0,008-0,023	2,5	1xD
○							●								6	100-130	0,010-0,025	3,0	1xD
○							●								8	100-130	0,015-0,030	4,0	1xD
○							●								10	100-130	0,020-0,035	5,0	1xD
○							●								12	100-130	0,025-0,040	6,0	1xD
○							●								16	100-130	0,030-0,045	8,0	1xD
○							●								20	100-130	0,035-0,050	10,0	1xD

● APPLICAZIONE CONSIGLIATA-RECOMMENDED APPLICATION
EMPFOLLENER EINSATZ - APPLICATION CONSEILLÉE

○ APPLICAZIONE POSSIBILE - POSSIBLE APPLICATION
MÖGLICHE ANWENDUNG - APPLICATION POSSIBLE

Vc = m/min VELOCITÀ DI TAGLIO - CUTTING SPEED

n = giri/min (min⁻¹) NUMERO DI GIRI - NUMBER OF REVOLUTIONS

fz = mm AVANZAMENTO AL DENTE -TOOTH FEED

fn = mm AVANZAMENTO AL GIRO - FEED / REVOLUTION

Vf = mm/min VELOCITÀ DI AVANZAMENTO - FEED SPEED

$$n = \frac{Vc \cdot 1000}{\text{ØD} \cdot 3,14} = \text{giri/min (min}^{-1}\text{)}$$

$$fn = fz \cdot z = \text{mm}$$

$$Vf = fz \cdot z \cdot n = \text{mm/min}$$

SM3100

ØD = 2 - 20

NEW

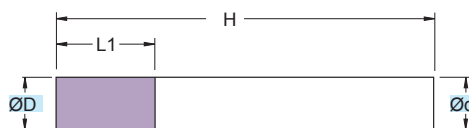

RIVESTIM.
COATED
BLACK



90°

42 HRC



Fresa in M.D.I. Micrograno
 Gambo sec. norma di fabbrica

Micrograin HM mills
 Shank according to factory standard

TOLLERANZE	D	d
TOLLERANCE RANGE	h10	h6

(mm)					
ART.	ØD	Ød	L1	H	z
SM3100.020.N00	2	6	4	38	3
SM3100.030.N00	3	6	5	38	3
SM3100.040.N00	4	6	7	38	3
SM3100.050.N00	5	6	8	38	3
SM3100.060.N00	6	6	8	38	3
SM3100.080.N00	8	8	11	43	3
SM3100.100.N00	10	10	13	50	3
SM3100.120.N00	12	12	15	55	3
SM3100.160.N00	16	16	18	62	3
SM3100.200.N00	20	20	22	75	3

Applicazione - Application

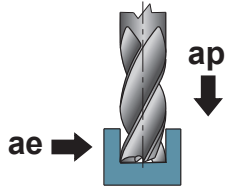

	MATERIALI - MATERIALS											ØD	Vc (m/min)	fz (mm)	ap (mm)	ae (mm)				
	P	M	K			N			S	H	G									
	ACCIAIO NON LEGATO NOT ALLOY STEEL	ACCIAIO POCO LEGATO LOW ALLOY STEEL	ACCIAIO ALTO LEGATO ALLOY STEEL	INOX MARTENSITICO STAINLESS STEEL MART.	INOX AUST. DUPLEX STAINLESS STEEL AUST.	GHISA GRIGIA GREY CAST IRON	GHISA SFEROIDALE SPHEROIDAL GRAPHITE	GHISA MALLEABILE MALLEABLE CAST IRON	ALLUMINIO E SUE LEGHE ALUMINIUM	RAMME E SUE LEGHE COPPER	NON METALLICI PLASTICS	LEGHE RESIST. CALORE HIGH TEMP. ALLOY	TITANIO E SUE LEGHE TITANIUM	ACCIAIO TEMPRATO HARDENED STEEL	GRAFITE GRAPHITE					
●																2	100-130	0,003-0,013	1,0	1xD
●																3	100-130	0,003-0,015	1,5	1xD
●																4	100-130	0,005-0,020	2,0	1xD
●																5	100-130	0,008-0,023	2,5	1xD
●																6	100-130	0,010-0,025	3,0	1xD
●																8	100-130	0,015-0,030	4,0	1xD
●																10	100-130	0,020-0,035	5,0	1xD
●																12	100-130	0,025-0,040	6,0	1xD
●																16	100-130	0,030-0,045	8,0	1xD
●																20	100-130	0,035-0,050	10,0	1xD
●																2	60-90	0,003-0,013	1,0	1xD
●																3	60-90	0,003-0,015	1,5	1xD
●																4	60-90	0,005-0,020	2,0	1xD
●																5	60-90	0,008-0,023	2,5	1xD
●																6	60-90	0,010-0,025	3,0	1xD
●																8	60-90	0,015-0,030	4,0	1xD
●																10	60-90	0,020-0,035	5,0	1xD
●																12	60-90	0,025-0,040	6,0	1xD
●																16	60-90	0,030-0,045	8,0	1xD
●																20	60-90	0,035-0,050	10,0	1xD
●		●														2	40-70	0,003-0,013	1,0	1xD
●		●														3	40-70	0,003-0,015	1,5	1xD
●		●														4	40-70	0,005-0,020	2,0	1xD
●		●														5	40-70	0,008-0,023	2,5	1xD
●		●														6	40-70	0,010-0,025	3,0	1xD
●		●														8	40-70	0,015-0,030	4,0	1xD
●		●														10	40-70	0,020-0,035	5,0	1xD
●		●														12	40-70	0,025-0,040	6,0	1xD
●		●														16	40-70	0,030-0,045	8,0	1xD
●		●														20	40-70	0,035-0,050	10,0	1xD
●			●													2	30-60	0,003-0,010	1,0	1xD
●			●													3	30-60	0,003-0,013	1,5	1xD
●			●													4	30-60	0,003-0,015	2,0	1xD
●			●													5	30-60	0,002-0,017	2,5	1xD
●			●													6	30-60	0,005-0,020	3,0	1xD
●			●													8	30-60	0,008-0,023	4,0	1xD
●			●													10	30-60	0,010-0,025	5,0	1xD
●			●													12	30-60	0,015-0,030	6,0	1xD
●			●													16	30-60	0,020-0,035	8,0	1xD
●			●													20	30-60	0,025-0,040	10,0	1xD
●				●												2	125-155	0,003-0,013	1,0	1xD
●				●												3	125-155	0,003-0,015	1,5	1xD
●				●												4	125-155	0,005-0,020	2,0	1xD
●				●												5	125-155	0,008-0,023	2,5	1xD
●				●												6	125-155	0,010-0,025	3,0	1xD
●				●												8	125-155	0,015-0,030	4,0	1xD
●				●												10	125-155	0,020-0,035	5,0	1xD
●				●												12	125-155	0,025-0,040	6,0	1xD
●				●												16	125-155	0,030-0,045	8,0	1xD
●				●												20	125-155	0,035-0,050	10,0	1xD
●					●											2	100-130	0,003-0,013	1,0	1xD
●					●											3	100-130	0,003-0,015	1,5	1xD
●					●											4	100-130	0,005-0,020	2,0	1xD
●					●											5	100-130	0,008-0,023	2,5	1xD
●					●											6	100-130	0,010-0,025	3,0	1xD
●					●											8	100-130	0,015-0,030	4,0	1xD
●					●											10	100-130	0,020-0,035	5,0	1xD
●					●											12	100-130	0,025-0,040	6,0	1xD
●					●											16	100-130	0,030-0,045	8,0	1xD
●					●											20	100-130	0,035-0,050	10,0	1xD

● APPLICAZIONE CONSIGLIATA-RECOMMENDED APPLICATION
EMPFÖHLENER EINSATZ - APPLICATION CONSEILLÉE

○ APPLICAZIONE POSSIBILE - POSSIBLE APPLICATION
MÖGLICHE ANWENDUNG - APPLICATION POSSIBLE

Vc = m/min VELOCITÀ DI TAGLIO - CUTTING SPEED

n = giri/min (min⁻¹) NUMERO DI GIRI - NUMBER OF REVOLUTIONS

fz = mm AVANZAMENTO AL DENTE -TOOTH FEED

fn = mm AVANZAMENTO AL GIRO - FEED / REVOLUTION

Vf = mm/min VELOCITÀ DI AVANZAMENTO - FEED SPEED

$$n = \frac{Vc \cdot 1000}{\varnothing D \cdot 3,14} = \text{giri/min (min}^{-1}\text{)}$$

$$fn = fz \cdot z = \text{mm}$$

$$Vf = fz \cdot z \cdot n = \text{mm/min}$$

SMW3231

$\varnothing D = 2 - 20$

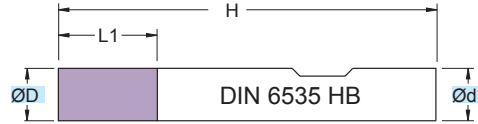

RIVESTIM.
 COATED
RED



90°

**58
 HRC**



Fresa in M.D.I. Micrograno
 Gambo sec. DIN 6535 HB

Micrograin HM mills
 DIN 6535 HB Shank

TOLLERANZE	D	d
TOLLERANCE RANGE	h10	h6

(mm)					
ART.	$\varnothing D$	$\varnothing d$	L1	H	z
SMW3231.020.N00	2	6	4	50	3
SMW3231.030.N00	3	6	5	50	3
SMW3231.040.N00	4	6	7	50	3
SMW3231.050.N00	5	6	8	50	3
SMW3231.060.N00	6	6	8	50	3
SMW3231.070.N00	7	8	11	57	3
SMW3231.080.N00	8	8	11	57	3
SMW3231.090.N00	9	10	15	63	3
SMW3231.100.N00	10	10	15	63	3
SMW3231.120.N00	12	12	21	72	3
SMW3231.160.N00	16	16	26	82	3
SMW3231.200.N00	20	20	32	92	3

--	--	--	--	--	--

Applicazione - Application

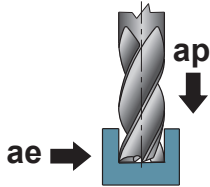

P	M	K	N	S	H	G	ØD	Vc	fz	ap	ae			
												ACCIAIO NON LEGATO NOT ALLOY STEEL	ACCIAIO POCO LEGATO LOW ALLOY STEEL	ACCIAIO ALTO LEGATO ALLOY STEEL
•							2	120-150	0,003-0,013	0,5xD	1xD			
•							3	120-150	0,003-0,015	0,5xD	1xD			
•							4	120-150	0,005-0,020	0,5xD	1xD			
•							5	120-150	0,008-0,023	0,5xD	1xD			
•							6	120-150	0,010-0,025	0,5xD	1xD			
•							7	120-150	0,012-0,027	0,5xD	1xD			
•							8	120-150	0,015-0,030	0,5xD	1xD			
•							9	120-150	0,018-0,033	0,5xD	1xD			
•							10	120-150	0,020-0,035	0,5xD	1xD			
•							12	120-150	0,025-0,040	0,5xD	1xD			
•							16	120-150	0,030-0,045	0,5xD	1xD			
•							20	120-150	0,035-0,050	0,5xD	1xD			
•							2	80-120	0,003-0,013	0,5xD	1xD			
•							3	80-120	0,003-0,015	0,5xD	1xD			
•							4	80-120	0,005-0,020	0,5xD	1xD			
•							5	80-120	0,008-0,023	0,5xD	1xD			
•							6	80-120	0,010-0,025	0,5xD	1xD			
•							7	80-120	0,012-0,027	0,5xD	1xD			
•							8	80-120	0,015-0,030	0,5xD	1xD			
•							9	80-120	0,018-0,033	0,5xD	1xD			
•							10	80-120	0,020-0,035	0,5xD	1xD			
•							12	80-120	0,025-0,040	0,5xD	1xD			
•							16	80-120	0,030-0,045	0,5xD	1xD			
•							20	80-120	0,035-0,050	0,5xD	1xD			
	•						2	30-60	0,003-0,010	0,5xD	1xD			
	•						3	30-60	0,003-0,013	0,5xD	1xD			
	•						4	30-60	0,003-0,015	0,5xD	1xD			
	•						5	30-60	0,002-0,017	0,5xD	1xD			
	•						6	30-60	0,005-0,020	0,5xD	1xD			
	•						7	30-60	0,006-0,021	0,5xD	1xD			
	•						8	30-60	0,008-0,023	0,5xD	1xD			
	•						9	30-60	0,009-0,024	0,5xD	1xD			
	•						10	30-60	0,010-0,025	0,5xD	1xD			
	•						12	30-60	0,015-0,030	0,5xD	1xD			
	•						16	30-60	0,020-0,035	0,5xD	1xD			
	•						20	30-60	0,025-0,040	0,5xD	1xD			
		•					2	120-150	0,003-0,013	0,5xD	1xD			
		•					3	120-150	0,003-0,015	0,5xD	1xD			
		•					4	120-150	0,003-0,015	0,5xD	1xD			
		•					5	120-150	0,005-0,020	0,5xD	1xD			
		•					6	120-150	0,010-0,025	0,5xD	1xD			
		•					7	120-150	0,012-0,027	0,5xD	1xD			
		•					8	120-150	0,015-0,030	0,5xD	1xD			
		•					9	120-150	0,017-0,032	0,5xD	1xD			
		•					10	120-150	0,020-0,035	0,5xD	1xD			
		•					12	120-150	0,025-0,040	0,5xD	1xD			
		•					16	120-150	0,030-0,045	0,5xD	1xD			
		•					20	120-150	0,035-0,050	0,5xD	1xD			
			•				2	100-130	0,003-0,013	0,5xD	1xD			
			•				3	100-130	0,003-0,015	0,5xD	1xD			
			•				4	100-130	0,003-0,015	0,5xD	1xD			
			•				5	100-130	0,005-0,020	0,5xD	1xD			
			•				6	100-130	0,010-0,025	0,5xD	1xD			
			•				7	100-130	0,012-0,027	0,5xD	1xD			
			•				8	100-130	0,015-0,030	0,5xD	1xD			
			•				9	100-130	0,017-0,032	0,5xD	1xD			
			•				10	100-130	0,020-0,035	0,5xD	1xD			
			•				12	100-130	0,025-0,040	0,5xD	1xD			
			•				16	100-130	0,030-0,045	0,5xD	1xD			
			•				20	100-130	0,035-0,050	0,5xD	1xD			

PER LAVORAZIONI A SPALLAMENTO AUMENTARE I PARAMETRI DEL 20%
FOR SHOULDER MILLING PARAMETERS SHOULD BE INCREASED BY 20%

● APPLICAZIONE CONSIGLIATA-RECOMMENDED APPLICATION
EMPFÖHLENER EINSATZ - APPLICATION CONSEILLÉE

○ APPLICAZIONE POSSIBILE - POSSIBLE APPLICATION
MÖGLICHE ANWENDUNG - APPLICATION POSSIBLE

Vc = m/min VELOCITÀ DI TAGLIO - CUTTING SPEED

n = giri/min (min⁻¹) NUMERO DI GIRI - NUMBER OF REVOLUTIONS

fz = mm AVANZAMENTO AL DENTE -TOOTH FEED

fn = mm AVANZAMENTO AL GIRO - FEED / REVOLUTION

Vf = mm/min VELOCITÀ DI AVANZAMENTO - FEED SPEED

$$n = \frac{Vc \cdot 1000}{\text{ØD} \cdot 3,14} = \text{giri/min (min}^{-1}\text{)}$$

$$fn = fz \cdot z = \text{mm}$$

$$Vf = fz \cdot z \cdot n = \text{mm/min}$$

SMW3300

ØD = 2 - 20

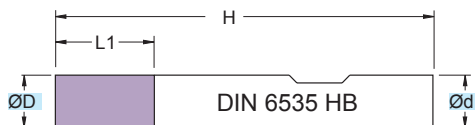

RIVESTIM.
COATED
BLACK



90°

**42
HRC**



Fresa in M.D.I. Micrograno
 Gambo sec. DIN 6535 HB

Micrograin HM mills
 DIN 6535 HB Shank

TOLLERANZE	D	d
TOLLERANCE RANGE	h10	h6

ART.	(mm)				
	ØD	Ød	L1	H	z
SMW3300.020.N00	2,00	3	7	38	3
SMW3300.025.N00	2,50	3	7	38	3
SMW3300.030.N00	3,00	3	8	38	3
SMW3300.035.N00	3,50	4	11	50	3
SMW3300.040.N00	4,00	4	11	50	3
SMW3300.045.N00	4,50	5	11	50	3
SMW3300.050.N00	5,00	5	10	50	3
SMW3300.055.N00	5,50	6	10	50	3
SMW3300.060.N00	6,00	6	10	57	3
SMW3300.065.N00	6,50	8	13	63	3
SMW3300.070.N00	7,00	8	13	63	3
SMW3300.075.N00	7,50	8	16	63	3
SMW3300.080.N00	8,00	8	16	63	3
SMW3300.085.N00	8,50	10	16	72	3
SMW3300.090.N00	9,00	10	16	72	3
SMW3300.095.N00	9,50	10	19	72	3
SMW3300.100.N00	10,00	10	19	72	3
SMW3300.105.N00 New	10,50	12	19	72	3
SMW3300.110.N00	11,00	12	19	72	3
SMW3300.115.N00 New	11,50	12	19	72	3
SMW3300.120.N00	12,00	12	22	83	3
SMW3300.125.N00 New	12,50	14	22	83	3
SMW3300.130.N00	13,00	14	22	83	3
SMW3300.135.N00 New	13,50	14	22	83	3
SMW3300.140.N00	14,00	14	22	83	3
SMW3300.145.N00 New	14,50	16	26	83	3
SMW3300.150.N00	15,00	16	26	83	3
SMW3300.155.N00 New	15,50	16	26	83	3
SMW3300.160.N00	16,00	16	26	83	3
SMW3300.170.N00	17,00	18	26	92	3
SMW3300.180.N00	18,00	18	26	92	3
SMW3300.190.N00	19,00	20	32	104	3
SMW3300.200.N00	20,00	20	32	104	3



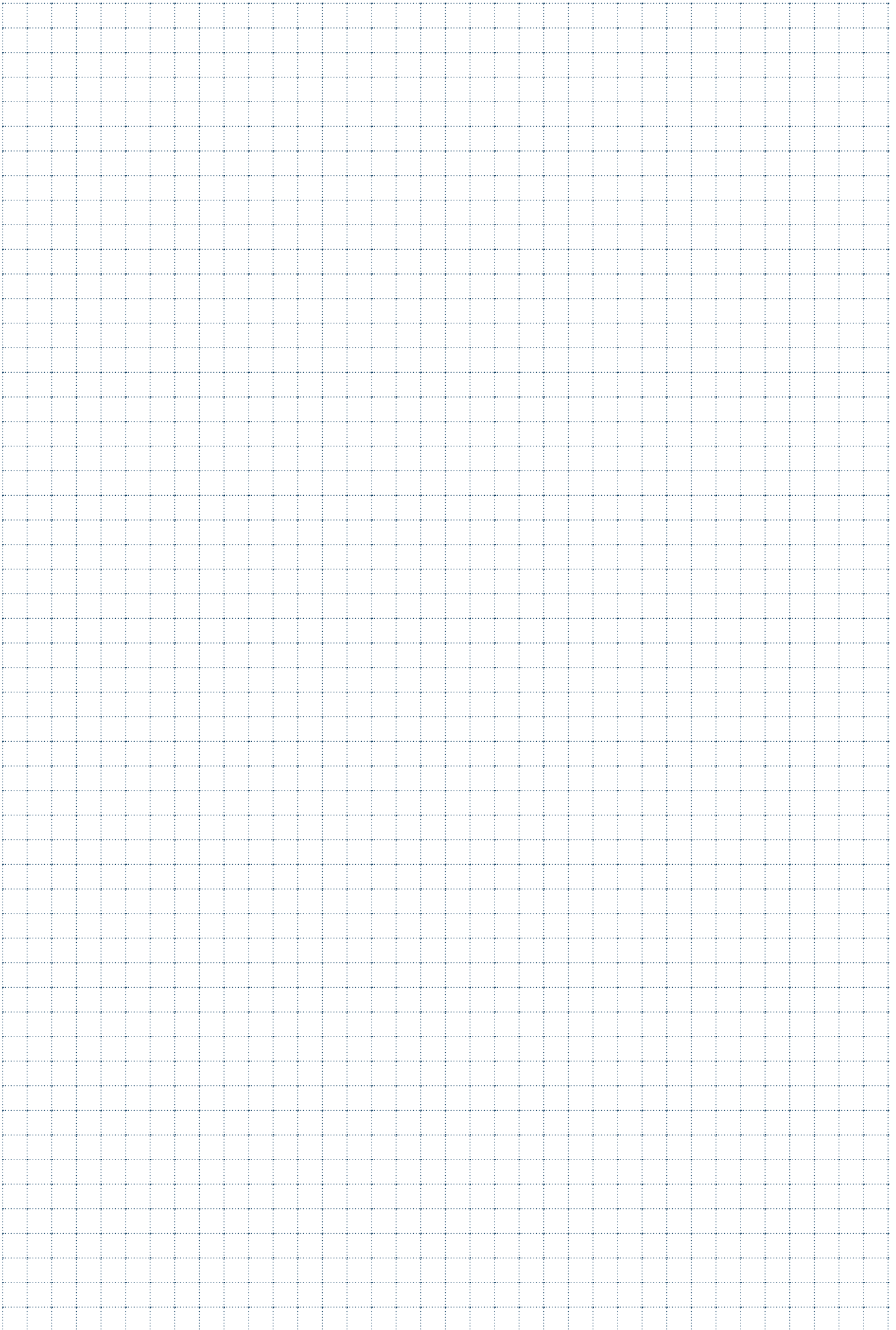



FRESE A 4 TAGLI

MILLING 4 CUTTINGS / VIERSCHNEIDER / FRAISES A 4 COUPES /
FRESAS DE 4 FILOS

SMW4300

$\varnothing D = 5,5 - 20$

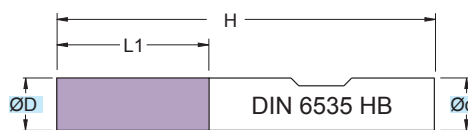

RIVESTIM.
 COATED
BLACK



90°

**42
 HRC**



Fresa in M.D.I. Micrograno
 Gambo sec. DIN 6535 HB

Micrograin HM mills
 DIN 6535 HB Shank

TOLLERANZE	D	d
TOLERANCE RANGE	h10	h6

ART.	(mm)				
	$\varnothing D$	$\varnothing d$	L1	H	z
SMW4300.055.N00	5,5	6	10	57	4
SMW4300.060.N00	6,0	6	10	57	4
SMW4300.070.N00	7,0	8	13	63	4
SMW4300.080.N00	8,0	8	16	63	4
SMW4300.090.N00	9,0	10	16	72	4
SMW4300.100.N00	10,0	10	19	72	4
SMW4300.110.N00	11,0	12	19	72	4
SMW4300.120.N00	12,0	12	22	83	4
SMW4300.140.N00	14,0	14	22	83	4
SMW4300.160.N00	16,0	16	26	83	4
SMW4300.180.N00	18,0	18	26	92	4
SMW4300.200.N00	20,0	20	32	104	4

Applicazione - Application

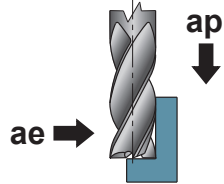

P	M	K	N	S	H	G	(mm) ØD	(m/min) Vc	(mm) fz	(mm) ap	(mm) ae			
												ACCIAIO NON LEGATO NOT ALLOY STEEL	ACCIAIO POCO LEGATO LOW ALLOY STEEL	ACCIAIO ALTO LEGATO ALLOY STEEL
•							2+3	60-90	0,003-0,015	4,5	0,3			
•							3+4	60-90	0,003-0,017	6,0	0,4			
•							4+5	60-90	0,005-0,020	7,5	0,5			
•							5+6	60-90	0,010-0,025	9,0	0,6			
•							6+8	60-90	0,015-0,030	12,0	0,8			
•							8+10	60-90	0,020-0,035	15,0	1,0			
•							10+12	60-90	0,030-0,045	18,0	1,2			
•							12+16	60-90	0,040-0,055	24,0	1,6			
•							16+20	60-90	0,050-0,065	30,0	2,0			
	•						2+3	40-70	0,003-0,015	4,5	0,3			
	•						3+4	40-70	0,003-0,017	6,0	0,4			
	•						4+5	40-70	0,005-0,020	7,5	0,5			
	•						5+6	40-70	0,010-0,025	9,0	0,6			
	•						6+8	40-70	0,015-0,030	12,0	0,8			
	•						8+10	40-70	0,020-0,035	15,0	1,0			
	•						10+12	40-70	0,030-0,045	18,0	1,2			
	•						12+16	40-70	0,040-0,055	24,0	1,6			
	•						16+20	40-70	0,050-0,065	30,0	2,0			
		•					2+3	25-55	0,003-0,013	4,5	0,3			
		•					3+4	25-55	0,003-0,015	6,0	0,4			
		•					4+5	25-55	0,003-0,015	7,5	0,5			
		•					5+6	25-55	0,005-0,020	9,0	0,6			
		•					6+8	25-55	0,010-0,025	12,0	0,8			
		•					8+10	25-55	0,015-0,030	15,0	1,0			
		•					10+12	25-55	0,020-0,035	18,0	1,2			
		•					12+16	25-55	0,030-0,045	24,0	1,6			
		•					16+20	25-55	0,040-0,055	30,0	2,0			
			•				2+3	100-130	0,003-0,013	4,5	0,3			
			•				3+4	100-130	0,003-0,015	6,0	0,4			
			•				4+5	100-130	0,003-0,015	7,5	0,5			
			•				5+6	100-130	0,005-0,020	9,0	0,6			
			•				6+8	100-130	0,010-0,025	12,0	0,8			
			•				8+10	100-130	0,015-0,030	15,0	1,0			
			•				10+12	100-130	0,020-0,035	18,0	1,2			
			•				12+16	100-130	0,030-0,045	24,0	1,6			
			•				16+20	100-130	0,040-0,055	30,0	2,0			

PER LAVORAZIONI IN CAVA DIMINUIRE I PARAMETRI DEL 20%
FOR SLOT CUTTING PARAMETERS SHOULD BE REDUCED BY 20%

- APPLICAZIONE CONSIGLIATA-RECOMMENDED APPLICATION
EMPFÖHLENER EINSATZ - APPLICATION CONSEILLÉE
- APPLICAZIONE POSSIBILE - POSSIBLE APPLICATION
MÖGLICHE ANWENDUNG - APPLICATION POSSIBLE

Vc = m/min VELOCITÀ DI TAGLIO - CUTTING SPEED

n = giri/min (min⁻¹) NUMERO DI GIRI - NUMBER OF REVOLUTIONS

fz = mm AVANZAMENTO AL DENTE -TOOTH FEED

fn = mm AVANZAMENTO AL GIRO - FEED / REVOLUTION

Vf = mm/min VELOCITÀ DI AVANZAMENTO - FEED SPEED

$$n = \frac{Vc \cdot 1000}{\text{ØD} \cdot 3,14} = \text{giri/min (min}^{-1}\text{)}$$

$$fn = fz \cdot z = \text{mm}$$

$$Vf = fz \cdot z \cdot n = \text{mm/min}$$

SM4300

ØD = 2 - 20

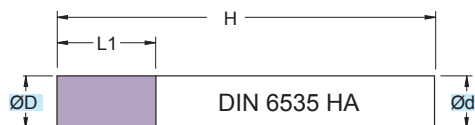

RIVESTIM.
 COATED
BLACK



90°

**42
 HRC**



**Fresa in M.D.I. Micrograno
 Gambo cilindrico HA**

Micrograin HM mills
 Cylindrical Shank HA

TOLLERANZE	D	d
TOLERANCE RANGE	h10	h6

ART.	(mm)				
	ØD	Ød	L1	H	z
SM4300.020.N00	2,0	3	7	38	4
SM4300.025.N00	2,5	3	7	38	4
SM4300.030.N00	3,0	3	8	38	4
SM4300.035.N00	3,5	4	11	50	4
SM4300.040.N00	4,0	4	11	50	4
SM4300.045.N00	4,5	5	11	50	4
SM4300.050.N00	5,0	5	10	50	4
SM4300.055.N00	5,5	6	10	57	4
SM4300.060.N00	6,0	6	10	57	4
SM4300.070.N00	7,0	8	13	63	4
SM4300.080.N00	8,0	8	16	63	4
SM4300.090.N00	9,0	10	16	72	4
SM4300.100.N00	10,0	10	19	72	4
SM4300.110.N00	11,0	12	19	72	4
SM4300.120.N00	12,0	12	22	83	4
SM4300.140.N00	14,0	14	22	83	4
SM4300.160.N00	16,0	16	26	83	4
SM4300.180.N00	18,0	18	26	92	4
SM4300.200.N00	20,0	20	32	104	4

Applicazione - Application

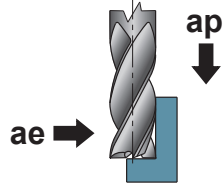

P	M	K	N	S	H	G	(mm) ØD	(m/min) Vc	(mm) fz	(mm) ap	(mm) ae			
												ACCIAIO NON LEGATO NOT ALLOY STEEL	ACCIAIO POCO LEGATO LOW ALLOY STEEL	ACCIAIO ALTO LEGATO ALLOY STEEL
•							2+3	60-90	0,003-0,015	4,5	0,3			
•							3+4	60-90	0,003-0,017	6,0	0,4			
•							4+5	60-90	0,005-0,020	7,5	0,5			
•							5+6	60-90	0,010-0,025	9,0	0,6			
•							6+8	60-90	0,015-0,030	12,0	0,8			
•							8+10	60-90	0,020-0,035	15,0	1,0			
•							10+12	60-90	0,030-0,045	18,0	1,2			
•							12+16	60-90	0,040-0,055	24,0	1,6			
•							16+20	60-90	0,050-0,065	30,0	2,0			
	•						2+3	40-70	0,003-0,015	4,5	0,3			
	•						3+4	40-70	0,003-0,017	6,0	0,4			
	•						4+5	40-70	0,005-0,020	7,5	0,5			
	•						5+6	40-70	0,010-0,025	9,0	0,6			
	•						6+8	40-70	0,015-0,030	12,0	0,8			
	•						8+10	40-70	0,020-0,035	15,0	1,0			
	•						10+12	40-70	0,030-0,045	18,0	1,2			
	•						12+16	40-70	0,040-0,055	24,0	1,6			
	•						16+20	40-70	0,050-0,065	30,0	2,0			
		•					2+3	25-55	0,003-0,013	4,5	0,3			
		•					3+4	25-55	0,003-0,015	6,0	0,4			
		•					4+5	25-55	0,003-0,015	7,5	0,5			
		•					5+6	25-55	0,005-0,020	9,0	0,6			
		•					6+8	25-55	0,010-0,025	12,0	0,8			
		•					8+10	25-55	0,015-0,030	15,0	1,0			
		•					10+12	25-55	0,020-0,035	18,0	1,2			
		•					12+16	25-55	0,030-0,045	24,0	1,6			
		•					16+20	25-55	0,040-0,055	30,0	2,0			
			•				2+3	100-130	0,003-0,013	4,5	0,3			
			•				3+4	100-130	0,003-0,015	6,0	0,4			
			•				4+5	100-130	0,003-0,015	7,5	0,5			
			•				5+6	100-130	0,005-0,020	9,0	0,6			
			•				6+8	100-130	0,010-0,025	12,0	0,8			
			•				8+10	100-130	0,015-0,030	15,0	1,0			
			•				10+12	100-130	0,020-0,035	18,0	1,2			
			•				12+16	100-130	0,030-0,045	24,0	1,6			
			•				16+20	100-130	0,040-0,055	30,0	2,0			

PER LAVORAZIONI IN CAVA DIMINUIRE I PARAMETRI DEL 20%
FOR SLOT CUTTING PARAMETERS SHOULD BE REDUCED BY 20%

- APPLICAZIONE CONSIGLIATA-RECOMMENDED APPLICATION
EMPFÖHLENER EINSATZ - APPLICATION CONSEILLÉE
- APPLICAZIONE POSSIBILE - POSSIBLE APPLICATION
MÖGLICHE ANWENDUNG - APPLICATION POSSIBLE

Vc = m/min VELOCITÀ DI TAGLIO - CUTTING SPEED

n = giri/min (min⁻¹) NUMERO DI GIRI - NUMBER OF REVOLUTIONS

fz = mm AVANZAMENTO AL DENTE -TOOTH FEED

fn = mm AVANZAMENTO AL GIRO - FEED / REVOLUTION

Vf = mm/min VELOCITÀ DI AVANZAMENTO - FEED SPEED

$$n = \frac{Vc \cdot 1000}{\text{ØD} \cdot 3,14} = \text{giri/min (min}^{-1}\text{)}$$

$$fn = fz \cdot z = \text{mm}$$

$$Vf = fz \cdot z \cdot n = \text{mm/min}$$

SMW4400

ØD = 3 - 20

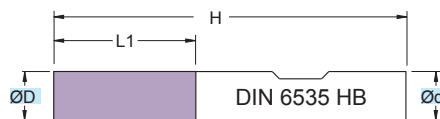

RIVESTIM.
 COATED
BLACK

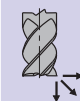

90°

**42
 HRC**



Fresa in M.D.I. Micrograno
 Gambo sec. DIN 6535 HB

Micrograin HM mills
 DIN 6535 HB Shank

TOLLERANZE	D	d
TOLERANCE RANGE	h10	h6

ART.	(mm)				
	ØD	Ød	L1	H	z
SMW4400.030.N00	3	6	20	60	4
SMW4400.040.N00	4	6	25	75	4
SMW4400.050.N00	5	6	25	75	4
SMW4400.060.N00	6	6	30	75	4
SMW4400.080.N00	8	8	45	100	4
SMW4400.100.N00	10	10	45	100	4
SMW4400.120.N00	12	12	45	100	4
SMW4400.120.NL02	12	12	65	150	4
SMW4400.140.N00	14	14	45	100	4
SMW4400.160.N00	16	16	45	100	4
SMW4400.160.NL02	16	16	65	150	4
SMW4400.180.N00	18	18	45	100	4
SMW4400.200.N00	20	20	45	104	4
SMW4400.200.NL02	20	20	65	150	4

Applicazione - Application

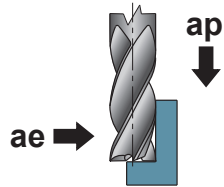

P	M	K	N	S	H	G	(mm) ØD	(m/min) Vc	(mm) fz	(mm) ap	(mm) ae			
												ACCIAIO NON LEGATO NOT ALLOY STEEL	ACCIAIO POCO LEGATO LOW ALLOY STEEL	ACCIAIO ALTO LEGATO ALLOY STEEL
●							3-4	60-90	0,003-0,017	6,0	0,4			
●							4-5	60-90	0,005-0,020	7,5	0,5			
●							5-6	60-90	0,010-0,025	9,0	0,6			
●							6-8	60-90	0,015-0,030	12,0	0,8			
●							8-10	60-90	0,020-0,035	15,0	1,0			
●							10-12	60-90	0,030-0,045	18,0	1,2			
●							12-16	60-90	0,040-0,055	24,0	1,6			
●							16-20	60-90	0,050-0,065	30,0	2,0			
	●						3-4	35-65	0,003-0,017	6,0	0,4			
	●						4-5	35-65	0,005-0,020	7,5	0,5			
	●						5-6	35-65	0,010-0,025	9,0	0,6			
	●						6-8	35-65	0,015-0,030	12,0	0,8			
	●						8-10	35-65	0,020-0,035	15,0	1,0			
	●						10-12	35-65	0,030-0,045	18,0	1,2			
	●						12-16	35-65	0,040-0,055	24,0	1,6			
	●						16-20	35-65	0,050-0,065	30,0	2,0			
		●					3-4	25-55	0,003-0,015	6,0	0,4			
		●					4-5	25-55	0,003-0,015	7,5	0,5			
		●					5-6	25-55	0,005-0,020	9,0	0,6			
		●					6-8	25-55	0,010-0,025	12,0	0,8			
		●					8-10	25-55	0,015-0,030	15,0	1,0			
		●					10-12	25-55	0,020-0,035	18,0	1,2			
		●					12-16	25-55	0,030-0,045	24,0	1,6			
		●					16-20	25-55	0,040-0,055	30,0	2,0			
			●				3-4	100-130	0,003-0,015	6,0	0,4			
			●				4-5	100-130	0,003-0,015	7,5	0,5			
			●				5-6	100-130	0,005-0,020	9,0	0,6			
			●				6-8	100-130	0,010-0,025	12,0	0,8			
			●				8-10	100-130	0,015-0,030	15,0	1,0			
			●				10-12	100-130	0,020-0,035	18,0	1,2			
			●				12-16	100-130	0,030-0,045	24,0	1,6			
			●				16-20	100-130	0,040-0,055	30,0	2,0			

PER LAVORAZIONI IN CAVA DIMINUIRE I PARAMETRI DEL 20%
FOR SLOT CUTTING PARAMETERS SHOULD BE REDUCED BY 20%

- APPLICAZIONE CONSIGLIATA-RECOMMENDED APPLICATION
EMPFÖHLENER EINSATZ - APPLICATION CONSEILLÉE
- APPLICAZIONE POSSIBILE - POSSIBLE APPLICATION
MÖGLICHE ANWENDUNG - APPLICATION POSSIBLE

Vc = m/min VELOCITÀ DI TAGLIO - CUTTING SPEED

n = giri/min (min⁻¹) NUMERO DI GIRI - NUMBER OF REVOLUTIONS

fz = mm AVANZAMENTO AL DENTE -TOOTH FEED

fn = mm AVANZAMENTO AL GIRO - FEED / REVOLUTION

Vf = mm/min VELOCITÀ DI AVANZAMENTO - FEED SPEED

$$n = \frac{Vc \cdot 1000}{\text{ØD} \cdot 3,14} = \text{giri/min (min}^{-1}\text{)}$$

$$fn = fz \cdot z = \text{mm}$$

$$Vf = fz \cdot z \cdot n = \text{mm/min}$$

SMW4402

$\varnothing D = 2 - 20$

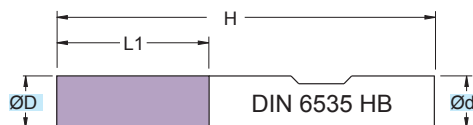

RIVESTIM. COATED BLACK	
45°	42 HRC

**Fresa in M.D.I. Micrograno
 Gambo sec. DIN 6535 HB**

Micrograin HM mills
 DIN 6535 HB Shank

TOLLERANZE	D	d
TOLLERANCE RANGE	h10	h6

ART.	(mm)					
	$\varnothing D$	$\varnothing d$	L1	H	45°	z
SMW4402.020.N00	2	6	8	57	0,05	4
SMW4402.030.N00	3	6	14	57	0,05	4
SMW4402.040.N00	4	6	18	57	0,10	4
SMW4402.050.N00	5	6	20	57	0,10	4
SMW4402.060.N00	6	6	21	57	0,10	4
SMW4402.080.N00	8	8	27	63	0,15	4
SMW4402.100.N00	10	10	32	72	0,15	4
SMW4402.120.N00	12	12	34	83	0,20	4
SMW4402.160.N00	16	16	38	92	0,20	4
SMW4402.200.N00	20	20	47	104	0,30	4

Applicazione - Application

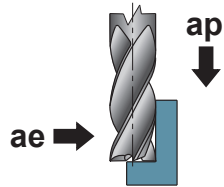

	MATERIALI - MATERIALS											(mm) ØD	(m/min) Vc	(mm) fz	(mm) ap	(mm) ae				
	P	M	K			N			S	H	G									
	ACCIAIO NON LEGATO NOT ALLOY STEEL	ACCIAIO POCO LEGATO LOW ALLOY STEEL	ACCIAIO ALTO LEGATO ALLOY STEEL	INOX MARTENSITICO STAINLESS STEEL MART.	INOX AUST. DUPLEX STAINLESS STEEL AUST.	GHISA GRIGIA GREY CAST IRON	GHISA SFEROIDALE SPHEROIDAL GRAPHITE	GHISA MALLEABILE MALLEABLE CAST IRON	ALLUMINIO E SUE LEGHE ALUMINIUM	RAME E SUE LEGHE COPPER	NON METALLICI PLASTICS	LEGHE RESIST. CALORE HIGH TEMP. ALLOY	TITANIO E SUE LEGHE TITANIUM	ACCIAIO TEMPRATO HARDENED STEEL	GRAFITE GRAPHITE					
●																2	60-90	0,003-0,015	1,5xD	0,2xD
●																3	60-90	0,003-0,015	1,5xD	0,2xD
●																4	60-90	0,003-0,015	1,5xD	0,2xD
●																5	60-90	0,003-0,015	1,5xD	0,2xD
●																6	60-90	0,003-0,015	1,5xD	0,2xD
●																8	60-90	0,010-0,025	1,5xD	0,2xD
●																10	60-90	0,010-0,025	1,5xD	0,2xD
●																12	60-90	0,020-0,035	1,5xD	0,2xD
●																16	60-90	0,030-0,045	1,5xD	0,2xD
●																20	60-90	0,030-0,045	1,5xD	0,2xD
		●														2	40-70	0,003-0,015	1,5xD	0,2xD
		●														3	40-70	0,003-0,015	1,5xD	0,2xD
		●														4	40-70	0,003-0,015	1,5xD	0,2xD
		●														5	40-70	0,003-0,015	1,5xD	0,2xD
		●														6	40-70	0,003-0,015	1,5xD	0,2xD
		●														8	40-70	0,010-0,025	1,5xD	0,2xD
		●														10	40-70	0,010-0,025	1,5xD	0,2xD
		●														12	40-70	0,020-0,035	1,5xD	0,2xD
		●														16	40-70	0,030-0,045	1,5xD	0,2xD
		●														20	40-70	0,030-0,045	1,5xD	0,2xD
				●												2	25-55	0,003-0,015	1,5xD	0,2xD
				●												3	25-55	0,003-0,015	1,5xD	0,2xD
				●												4	25-55	0,003-0,015	1,5xD	0,2xD
				●												5	25-55	0,003-0,015	1,5xD	0,2xD
				●												6	25-55	0,003-0,015	1,5xD	0,2xD
				●												8	25-55	0,010-0,025	1,5xD	0,2xD
				●												10	25-55	0,010-0,025	1,5xD	0,2xD
				●												12	25-55	0,020-0,035	1,5xD	0,2xD
				●												16	25-55	0,030-0,045	1,5xD	0,2xD
				●												20	25-55	0,030-0,045	1,5xD	0,2xD
					●											2	80-110	0,003-0,015	1,5xD	0,2xD
					●											3	80-110	0,003-0,015	1,5xD	0,2xD
					●											4	80-110	0,010-0,025	1,5xD	0,2xD
					●											5	80-110	0,010-0,025	1,5xD	0,2xD
					●											6	80-110	0,010-0,025	1,5xD	0,2xD
					●											8	80-110	0,030-0,045	1,5xD	0,2xD
					●											10	80-110	0,030-0,045	1,5xD	0,2xD
					●											12	80-110	0,030-0,045	1,5xD	0,2xD
					●											16	80-110	0,040-0,055	1,5xD	0,2xD
					●											20	80-110	0,040-0,055	1,5xD	0,2xD

PER LAVORAZIONI IN CAVA DIMINUIRE I PARAMETRI DEL 20%
FOR SLOT CUTTING PARAMETERS SHOULD BE REDUCED BY 20%

- APPLICAZIONE CONSIGLIATA-RECOMMENDED APPLICATION
EMPFÖHLENER EINSATZ - APPLICATION CONSEILLÉE
- APPLICAZIONE POSSIBILE - POSSIBLE APPLICATION
MÖGLICHE ANWENDUNG - APPLICATION POSSIBLE

Vc = m/min VELOCITÀ DI TAGLIO - CUTTING SPEED

n = giri/min (min⁻¹) NUMERO DI GIRI - NUMBER OF REVOLUTIONS

fz = mm AVANZAMENTO AL DENTE -TOOTH FEED

fn = mm AVANZAMENTO AL GIRO - FEED / REVOLUTION

Vf = mm/min VELOCITÀ DI AVANZAMENTO - FEED SPEED

$$n = \frac{Vc \cdot 1000}{\text{ØD} \cdot 3,14} = \text{giri/min (min}^{-1}\text{)}$$

$$fn = fz \cdot z = \text{mm}$$

$$Vf = fz \cdot z \cdot n = \text{mm/min}$$

SM4330

ØD = 4 - 20

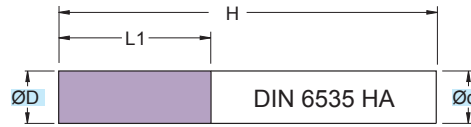

RIVESTIM.
 COATED
GRAY



45°

**52
 HRC**

HSC



Fresa in M.D.I. Micrograno
 Gambo cilindrico HA

Micrograin HM mills
 Cylindrical Shank HA

TOLLERANZE	D	d
TOLERANCE RANGE	h10	h6

ART.	(mm)					
	ØD	Ød	L1	H	45°	z
SM4330.040.N00	4	6	11	57	0,10	4
SM4330.050.N00	5	6	13	57	0,10	4
SM4330.060.N00	6	6	13	57	0,10	4
SM4330.080.N00	8	8	19	63	0,15	4
SM4330.100.N00	10	10	22	72	0,15	4
SM4330.120.N00	12	12	26	83	0,20	4
SM4330.140.N00	14	14	26	83	0,20	4
SM4330.160.N00	16	16	32	92	0,20	4
SM4330.180.N00	18	18	32	92	0,30	4
SM4330.200.N00	20	20	38	104	0,30	4

Applicazione - Application

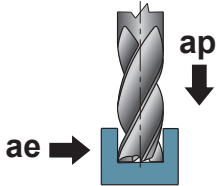

P	M	K	N	S	H	G	ØD (mm)	Vc (m/min)	fz (mm)	ap (mm)	ae (mm)			
												ACCAIO NON LEGATO NOT ALLOY STEEL	ACCAIO POCO LEGATO LOW ALLOY STEEL	ACCAIO ALTO LEGATO ALLOY STEEL
•							4	160-190	0,030-0,045	0,5xD	1xD			
•							5	160-190	0,035-0,050	0,5xD	1xD			
•							6	160-190	0,040-0,055	0,5xD	1xD			
•							8	160-190	0,050-0,065	0,5xD	1xD			
•							10	160-190	0,060-0,075	0,5xD	1xD			
•							12	160-190	0,070-0,085	0,5xD	1xD			
•							14	160-190	0,080-0,095	0,5xD	1xD			
•							16	160-190	0,090-0,105	0,5xD	1xD			
•							18	160-190	0,090-0,105	0,5xD	1xD			
•							20	160-190	0,090-0,105	0,5xD	1xD			
	•						4	100-130	0,015-0,030	0,5xD	1xD			
	•						5	100-130	0,020-0,035	0,5xD	1xD			
	•						6	100-130	0,025-0,040	0,5xD	1xD			
	•						8	100-130	0,030-0,045	0,5xD	1xD			
	•						10	100-130	0,030-0,045	0,5xD	1xD			
	•						12	100-130	0,040-0,055	0,5xD	1xD			
	•						14	100-130	0,050-0,065	0,5xD	1xD			
	•						16	100-130	0,060-0,075	0,5xD	1xD			
	•						18	100-130	0,060-0,075	0,5xD	1xD			
	•						20	100-130	0,060-0,075	0,5xD	1xD			
		•					4	180-210	0,035-0,050	0,5xD	1xD			
		•					5	180-210	0,040-0,055	0,5xD	1xD			
		•					6	180-210	0,045-0,060	0,5xD	1xD			
		•					8	180-210	0,060-0,075	0,5xD	1xD			
		•					10	180-210	0,070-0,085	0,5xD	1xD			
		•					12	180-210	0,090-0,105	0,5xD	1xD			
		•					14	180-210	0,100-0,115	0,5xD	1xD			
		•					16	180-210	0,110-0,125	0,5xD	1xD			
		•					18	180-210	0,110-0,125	0,5xD	1xD			
		•					20	180-210	0,110-0,125	0,5xD	1xD			
			•				4	160-190	0,035-0,050	0,5xD	1xD			
			•				5	160-190	0,040-0,055	0,5xD	1xD			
			•				6	160-190	0,045-0,060	0,5xD	1xD			
			•				8	160-190	0,060-0,075	0,5xD	1xD			
			•				10	160-190	0,070-0,085	0,5xD	1xD			
			•				12	160-190	0,090-0,105	0,5xD	1xD			
			•				14	160-190	0,100-0,115	0,5xD	1xD			
			•				16	160-190	0,110-0,125	0,5xD	1xD			
			•				18	160-190	0,110-0,125	0,5xD	1xD			
			•				20	160-190	0,110-0,125	0,5xD	1xD			
				•			4	20-40	0,003-0,011	0,5xD	1xD			
				•			5	20-40	0,003-0,012	0,5xD	1xD			
				•			6	20-40	0,003-0,013	0,5xD	1xD			
				•			8	20-40	0,003-0,015	0,5xD	1xD			
				•			10	20-40	0,005-0,020	0,5xD	1xD			
				•			12	20-40	0,010-0,025	0,5xD	1xD			
				•			14	20-40	0,015-0,030	0,5xD	1xD			
				•			16	20-40	0,020-0,035	0,5xD	1xD			
				•			18	20-40	0,025-0,040	0,5xD	1xD			
				•			20	20-40	0,030-0,045	0,5xD	1xD			

PER LAVORAZIONI A SPALLAMENTO AUMENTARE I PARAMETRI DEL 20%
FOR SHOULDER MILLING PARAMETERS SHOULD BE INCREASED BY 20%

● APPLICAZIONE CONSIGLIATA-RECOMMENDED APPLICATION
EMPFÖHLENER EINSATZ - APPLICATION CONSEILLÉE

○ APPLICAZIONE POSSIBILE - POSSIBLE APPLICATION
MÖGLICHE ANWENDUNG - APPLICATION POSSIBLE

Vc = m/min VELOCITÀ DI TAGLIO - CUTTING SPEED

n = giri/min (min⁻¹) NUMERO DI GIRI - NUMBER OF REVOLUTIONS

fz = mm AVANZAMENTO AL DENTE -TOOTH FEED

fn = mm AVANZAMENTO AL GIRO - FEED / REVOLUTION

Vf = mm/min VELOCITÀ DI AVANZAMENTO - FEED SPEED

$$n = \frac{Vc \cdot 1000}{\text{ØD} \cdot 3,14} = \text{giri/min (min}^{-1}\text{)}$$

$$fn = fz \cdot z = \text{mm}$$

$$Vf = fz \cdot z \cdot n = \text{mm/min}$$

SMW4304

ØD = 3 - 20

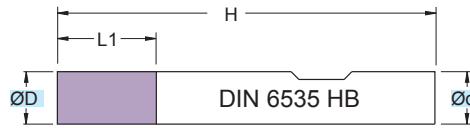

RIVESTIM.
 COATED
GRAY

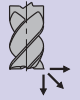

90°

**42
 HRC**



Fresa in M.D.I. Micrograno
 Gambo sec. DIN 6535 HB

Micrograin HM mills
 DIN 6535 HB Shank

TOLLERANZE	D	d
TOLERANCE RANGE	h10	h6

ART.	(mm)				
	ØD	Ød	L1	H	z
SMW4304.030.N00	3	6	6	57	4
SMW4304.040.N00	4	6	8	57	4
SMW4304.050.N00	5	6	10	57	4
SMW4304.060.N00	6	6	13	57	4
SMW4304.080.N00	8	8	16	63	4
SMW4304.100.N00	10	10	22	72	4
SMW4304.120.N00	12	12	26	83	4
SMW4304.160.N00	16	16	32	92	4
SMW4304.200.N00	20	20	38	104	4

Applicazione - Application

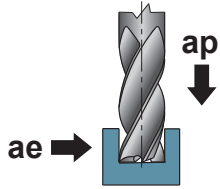

	MATERIALI - MATERIALS													(mm) ØD	(m/min) Vc	(mm) fz	(mm) ap	(mm) ae		
	P			M	K			N			S	H	G							
	ACCIAIO NON LEGATO NOT ALLOY STEEL	ACCIAIO POCO LEGATO LOW ALLOY STEEL	ACCIAIO ALTO LEGATO ALLOY STEEL	INOX MARTENSITICO STAINLESS STEEL MART.	INOX AUST. DUPLEX STAINLESS STEEL AUST.	GHISA GRIGIA GREY CAST IRON	GHISA SFEROIDALE SPHEROIDAL GRAPHITE	GHISA MALLEABILE MALLEABLE CAST IRON	ALLUMINIO E SUE LEGHE ALUMINIUM	RAME E SUE LEGHE COPPER	NON METALLICI PLASTICS	LEGHE RESIST. CALORE HIGH TEMP. ALLOY	TITANIO E SUE LEGHE TITANIUM	ACCIAIO TEMPRATO HARDENED STEEL	GRAFITE GRAPHITE					
●																3	100-130	0,003-0,015	1xD	1xD
●																4	100-130	0,005-0,020	1xD	1xD
●																5	100-130	0,010-0,025	1xD	1xD
●																6	100-130	0,020-0,035	1xD	1xD
●																8	100-130	0,030-0,045	1xD	1xD
●																10	100-130	0,035-0,050	1xD	1xD
●																12	100-130	0,040-0,055	1xD	1xD
●																16	100-130	0,050-0,065	1xD	1xD
●																20	100-130	0,060-0,075	1xD	1xD
		●														3	50-80	0,003-0,015	1xD	1xD
		●														4	50-80	0,005-0,020	1xD	1xD
		●														5	50-80	0,010-0,025	1xD	1xD
		●														6	50-80	0,015-0,030	1xD	1xD
		●														8	50-80	0,020-0,035	1xD	1xD
		●														10	50-80	0,025-0,040	1xD	1xD
		●														12	50-80	0,030-0,045	1xD	1xD
		●														16	50-80	0,040-0,055	1xD	1xD
		●														20	50-80	0,050-0,065	1xD	1xD
				●												3	30-60	0,003-0,013	1xD	1xD
				●												4	30-60	0,003-0,015	1xD	1xD
				●												5	30-60	0,005-0,020	1xD	1xD
				●												6	30-60	0,005-0,020	1xD	1xD
				●												8	30-60	0,010-0,025	1xD	1xD
				●												10	30-60	0,015-0,030	1xD	1xD
				●												12	30-60	0,020-0,035	1xD	1xD
				●												16	30-60	0,030-0,045	1xD	1xD
				●												20	30-60	0,040-0,055	1xD	1xD
					●											3	125-155	0,005-0,020	1xD	1xD
					●											4	125-155	0,015-0,030	1xD	1xD
					●											5	125-155	0,025-0,040	1xD	1xD
					●											6	125-155	0,035-0,050	1xD	1xD
					●											8	125-155	0,050-0,065	1xD	1xD
					●											10	125-155	0,055-0,070	1xD	1xD
					●											12	125-155	0,060-0,075	1xD	1xD
					●											16	125-155	0,080-0,095	1xD	1xD
					●											20	125-155	0,110-0,125	1xD	1xD
						●										3	100-130	0,005-0,020	1xD	1xD
						●										4	100-130	0,015-0,030	1xD	1xD
						●										5	100-130	0,025-0,040	1xD	1xD
						●										6	100-130	0,035-0,050	1xD	1xD
						●										8	100-130	0,050-0,065	1xD	1xD
						●										10	100-130	0,055-0,070	1xD	1xD
						●										12	100-130	0,060-0,075	1xD	1xD
						●										16	100-130	0,080-0,095	1xD	1xD
						●										20	100-130	0,110-0,125	1xD	1xD

PER LAVORAZIONI A SPALLAMENTO AUMENTARE I PARAMETRI DEL 20%
FOR SHOULDER MILLING PARAMETERS SHOULD BE INCREASED BY 20%

● APPLICAZIONE CONSIGLIATA-RECOMMENDED APPLICATION
EMPFOLHENER EINSATZ - APPLICATION CONSEILLÉE

○ APPLICAZIONE POSSIBILE - POSSIBLE APPLICATION
MÖGLICHE ANWENDUNG - APPLICATION POSSIBLE

Vc = m/min VELOCITÀ DI TAGLIO - CUTTING SPEED

n = giri/min (min⁻¹) NUMERO DI GIRI - NUMBER OF REVOLUTIONS

fz = mm AVANZAMENTO AL DENTE -TOOTH FEED

fn = mm AVANZAMENTO AL GIRO - FEED / REVOLUTION

Vf = mm/min VELOCITÀ DI AVANZAMENTO - FEED SPEED

$$n = \frac{Vc \cdot 1000}{\text{ØD} \cdot 3,14} = \text{giri/min (min}^{-1}\text{)}$$

$$fn = fz \cdot z = \text{mm}$$

$$Vf = fz \cdot z \cdot n = \text{mm/min}$$

SMW3304

ØD = 4 - 25

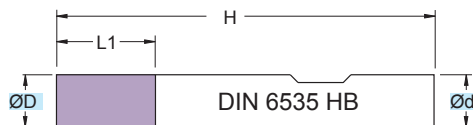
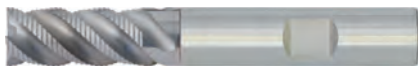

RIVESTIM.
 COATED
GRAY



90°

**42
 HRC**



Fresa in M.D.I. Micrograno
 Gambo sec. DIN 6535 HB

Micrograin HM mills
 DIN 6535 HB Shank

TOLLERANZE	D	d
TOLLERANCE RANGE	h10	h6

ART.	(mm)				
	ØD	Ød	L1	H	z
SMW3304.040.N00	4	6	11	57	3
SMW3304.050.N00	5	6	13	57	4
SMW3304.060.N00	6	6	16	57	4
SMW3304.070.N00	7	8	16	63	4
SMW3304.080.N00	8	8	16	63	4
SMW3304.090.N00	9	10	19	72	4
SMW3304.100.N00	10	10	22	72	4
SMW3304.120.N00	12	12	26	83	4
SMW3304.140.N00	14	14	26	83	5
SMW3304.160.N00	16	16	32	92	5
SMW3304.200.N00	20	20	38	104	6
SMW3304.250.N00	25	25	45	121	6

Applicazione - Application

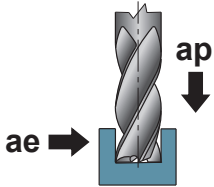

P	M	K	N	S	H	G	ØD	Vc	fz	ap	ae			
												ACCIAIO NON LEGATO NOT ALLOY STEEL	ACCIAIO POCO LEGATO LOW ALLOY STEEL	ACCIAIO ALTO LEGATO ALLOY STEEL
•							4	150-180	0,010-0,025	1xD	0,5xD			
•							5	150-180	0,015-0,030	1xD	0,5xD			
•							6	150-180	0,020-0,035	1xD	0,5xD			
•							7	150-180	0,025-0,040	1xD	0,5xD			
•							8	150-180	0,030-0,045	1xD	0,5xD			
•							9	150-180	0,040-0,055	1xD	0,5xD			
•							10	150-180	0,050-0,065	1xD	0,5xD			
•							12	150-180	0,070-0,085	1xD	0,5xD			
•							14	150-180	0,090-0,105	1xD	0,5xD			
•							16	150-180	0,110-0,125	1xD	0,5xD			
•							20	150-180	0,130-0,145	1xD	0,5xD			
•							25	150-180	0,150-0,165	1xD	0,5xD			
	•						4	130-160	0,010-0,025	1xD	0,5xD			
	•						5	130-160	0,015-0,030	1xD	0,5xD			
	•						6	130-160	0,020-0,035	1xD	0,5xD			
	•						7	130-160	0,025-0,040	1xD	0,5xD			
	•						8	130-160	0,030-0,045	1xD	0,5xD			
	•						9	130-160	0,040-0,055	1xD	0,5xD			
	•						10	130-160	0,050-0,065	1xD	0,5xD			
	•						12	130-160	0,070-0,085	1xD	0,5xD			
	•						14	130-160	0,090-0,105	1xD	0,5xD			
	•						16	130-160	0,110-0,125	1xD	0,5xD			
	•						20	130-160	0,130-0,145	1xD	0,5xD			
	•						25	130-160	0,150-0,165	1xD	0,5xD			
							4	30-60	0,040-0,055	1xD	0,5xD			
							5	30-60	0,040-0,055	1xD	0,5xD			
							6	30-60	0,050-0,065	1xD	0,5xD			
							7	30-60	0,050-0,065	1xD	0,5xD			
							8	30-60	0,050-0,065	1xD	0,5xD			
							9	30-60	0,060-0,075	1xD	0,5xD			
							10	30-60	0,070-0,085	1xD	0,5xD			
							12	30-60	0,090-0,105	1xD	0,5xD			
							14	30-60	0,110-0,125	1xD	0,5xD			
							16	30-60	0,140-0,155	1xD	0,5xD			
							20	30-60	0,190-0,205	1xD	0,5xD			
							25	30-60	0,190-0,205	1xD	0,5xD			
							4	60-90	0,040-0,055	1xD	0,5xD			
							5	60-90	0,040-0,055	1xD	0,5xD			
							6	60-90	0,050-0,065	1xD	0,5xD			
							7	60-90	0,050-0,065	1xD	0,5xD			
							8	60-90	0,050-0,065	1xD	0,5xD			
							9	60-90	0,060-0,075	1xD	0,5xD			
							10	60-90	0,070-0,085	1xD	0,5xD			
							12	60-90	0,090-0,105	1xD	0,5xD			
							14	60-90	0,110-0,125	1xD	0,5xD			
							16	60-90	0,140-0,155	1xD	0,5xD			
							20	60-90	0,190-0,205	1xD	0,5xD			
							25	60-90	0,190-0,205	1xD	0,5xD			

PER LAVORAZIONI A SPALLAMENTO AUMENTARE I PARAMETRI DEL 20%
FOR SHOULDER MILLING PARAMETERS SHOULD BE INCREASED BY 20%

● APPLICAZIONE CONSIGLIATA-RECOMMENDED APPLICATION
EMPFÖHLENER EINSATZ - APPLICATION CONSEILLÉE

○ APPLICAZIONE POSSIBILE - POSSIBLE APPLICATION
MÖGLICHE ANWENDUNG - APPLICATION POSSIBLE

Vc = m/min VELOCITÀ DI TAGLIO - CUTTING SPEED

n = giri/min (min⁻¹) NUMERO DI GIRI - NUMBER OF REVOLUTIONS

fz = mm AVANZAMENTO AL DENTE -TOOTH FEED

fn = mm AVANZAMENTO AL GIRO - FEED / REVOLUTION

Vf = mm/min VELOCITÀ DI AVANZAMENTO - FEED SPEED

$$n = \frac{Vc \cdot 1000}{\text{ØD} \cdot 3,14} = \text{giri/min (min}^{-1}\text{)}$$

$$fn = fz \cdot z = \text{mm}$$

$$Vf = fz \cdot z \cdot n = \text{mm/min}$$

SMW4404

ØD = 6 - 20

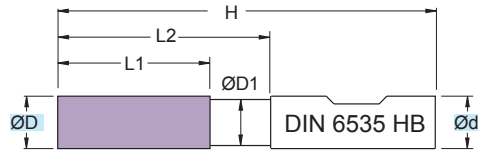

RIVESTIM.
COATED
GRAY

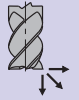

90°

**42
HRC**



Fresa in M.D.I. Micrograno
 Gambo sec. DIN 6535 HB

Micrograin HM mills
 DIN 6535 HB Shank

TOLLERANZE	D	d
TOLLERANCE RANGE	h10	h6

ART.	(mm)						
	ØD	Ød	ØD1	L1	L2	H	z
SMW4404.060.N00	6	6	5,8	13	20	57	4
SMW4404.080.N00	8	8	7,7	19	27	63	4
SMW4404.100.N00	10	10	9,5	22	32	72	4
SMW4404.120.N00	12	12	11,5	26	38	83	4
SMW4404.140.N00	14	14	13,5	26	38	83	4
SMW4404.160.N00	16	16	15,5	32	44	92	4
SMW4404.180.N00	18	18	17,5	32	44	92	4
SMW4404.200.N00	20	20	19,5	38	50	104	4

Applicazione - Application

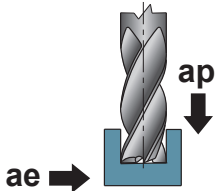

Applicazione - Application	MATERIALI - MATERIALS											(mm) ØD	(m/min) Vc	(mm) fz	(mm) ap	(mm) ae				
	P	M	K			N		S	H	G										
	ACCIAIO NON LEGATO NOT ALLOY STEEL	ACCIAIO POCO LEGATO LOW ALLOY STEEL	ACCIAIO ALTO LEGATO ALLOY STEEL	INOX MARTENSITICO STAINLESS STEEL MART.	INOX AUST. DUPLEX STAINLESS STEEL AUST.	GHISA GRIGIA GREY CAST IRON	GHISA SFEROIDALE SPHEROIDAL GRAPHITE	GHISA MALLEABILE MALLEABLE CAST IRON	ALLUMINIO E SUE LEGHE ALUMINIUM	RAME E SUE LEGHE COPPER	NON METALLICI PLASTICS	LEGHE RESIST. CALORE HIGH TEMP. ALLOY	TITANIO E SUE LEGHE TITANIUM	ACCIAIO TEMPRATO HARDENED STEEL	GRAFITE GRAPHITE					
●																6	120-150	0,014-0,029	1xD	1xD
●																8	120-150	0,022-0,037	1xD	1xD
●																10	120-150	0,030-0,045	1xD	1xD
●																12	120-150	0,038-0,053	1xD	1xD
●																14	120-150	0,046-0,061	1xD	1xD
●																16	120-150	0,054-0,069	1xD	1xD
●																18	120-150	0,062-0,077	1xD	1xD
●																20	120-150	0,070-0,085	1xD	1xD
	●															6	100-130	0,014-0,029	1xD	1xD
	●															8	100-130	0,022-0,037	1xD	1xD
	●															10	100-130	0,030-0,045	1xD	1xD
	●															12	100-130	0,038-0,053	1xD	1xD
	●															14	100-130	0,046-0,061	1xD	1xD
	●															16	100-130	0,054-0,069	1xD	1xD
	●															18	100-130	0,062-0,077	1xD	1xD
	●															20	100-130	0,070-0,085	1xD	1xD
				●												6	40-70	0,005-0,020	0,75xD	1xD
				●												8	40-70	0,010-0,025	0,75xD	1xD
				●												10	40-70	0,010-0,025	0,75xD	1xD
				●												12	40-70	0,015-0,030	0,75xD	1xD
				●												14	40-70	0,020-0,035	0,75xD	1xD
				●												16	40-70	0,025-0,040	0,75xD	1xD
				●												18	40-70	0,030-0,045	0,75xD	1xD
				●												20	40-70	0,035-0,050	0,75xD	1xD
					●											6	160-220	0,032-0,047	1xD	1xD
					●											8	160-220	0,046-0,061	1xD	1xD
					●											10	160-220	0,060-0,075	1xD	1xD
					●											12	160-220	0,074-0,089	1xD	1xD
					●											14	160-220	0,088-0,103	1xD	1xD
					●											16	160-220	0,102-0,117	1xD	1xD
					●											18	160-220	0,116-0,131	1xD	1xD
					●											20	160-220	0,130-0,145	1xD	1xD
						●										6	130-160	0,020-0,035	1xD	1xD
						●										8	130-160	0,030-0,045	1xD	1xD
						●										10	130-160	0,040-0,055	1xD	1xD
						●										12	130-160	0,050-0,065	1xD	1xD
						●										14	130-160	0,060-0,075	1xD	1xD
						●										16	130-160	0,070-0,085	1xD	1xD
						●										18	130-160	0,080-0,095	1xD	1xD
						●										20	130-160	0,090-0,105	1xD	1xD
												●				6	20-50	0,005-0,020	0,75xD	1xD
												●				8	20-50	0,010-0,025	0,75xD	1xD
												●				10	20-50	0,010-0,025	0,75xD	1xD
												●				12	20-50	0,015-0,030	0,75xD	1xD
												●				14	20-50	0,020-0,035	0,75xD	1xD
												●				16	20-50	0,025-0,040	0,75xD	1xD
												●				18	20-50	0,030-0,045	0,75xD	1xD
												●				20	20-50	0,035-0,050	0,75xD	1xD
													●			6	40-70	0,005-0,020	0,75xD	1xD
													●			8	40-70	0,010-0,025	0,75xD	1xD
													●			10	40-70	0,010-0,025	0,75xD	1xD
													●			12	40-70	0,015-0,030	0,75xD	1xD
													●			14	40-70	0,020-0,035	0,75xD	1xD
													●			16	40-70	0,025-0,040	0,75xD	1xD
													●			18	40-70	0,030-0,045	0,75xD	1xD
													●			20	40-70	0,035-0,050	0,75xD	1xD

PER LAVORAZIONI A SPALLAMENTO AUMENTARE I PARAMETRI DEL 20%
FOR SHOULDER MILLING PARAMETERS SHOULD BE INCREASED BY 20%

- APPLICAZIONE CONSIGLIATA-RECOMMENDED APPLICATION
EMPFÖHLENER EINSATZ - APPLICATION CONSEILLÉE
- APPLICAZIONE POSSIBILE - POSSIBLE APPLICATION
MÖGLICHE ANWENDUNG - APPLICATION POSSIBLE

Vc = m/min VELOCITÀ DI TAGLIO - CUTTING SPEED

n = giri/min (min⁻¹) NUMERO DI GIRI - NUMBER OF REVOLUTIONS

fz = mm AVANZAMENTO AL DENTE - TOOTH FEED

fn = mm AVANZAMENTO AL GIRO - FEED / REVOLUTION

Vf = mm/min VELOCITÀ DI AVANZAMENTO - FEED SPEED

$$n = \frac{Vc \cdot 1000}{\text{ØD} \cdot 3,14} = \text{giri/min (min}^{-1}\text{)}$$

$$fn = fz \cdot z = \text{mm}$$

$$Vf = fz \cdot z \cdot n = \text{mm/min}$$

SM4325

ØD = 3 - 20

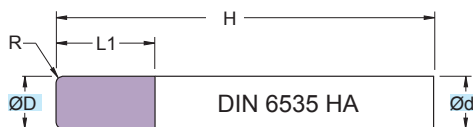

RIVESTIM.
 COATED
GRAY



R

**62
 HRC**



Fresa in M.D.I. Micrograno
 Gambo cilindrico HA

Micrograin HM mills
 Cylindrical Shank HA

TOLLERANZE	D	d
TOLLERANCE RANGE	h10	h6

ART.	(mm)					
	ØD	Ød	L1	H	R	z
SM4325.030.R030	3	3	6	50	0,3	4
SM4325.030.R050	3	3	6	50	0,5	4
SM4325.040.R030	4	4	8	60	0,3	4
SM4325.040.R050	4	4	8	60	0,5	4
SM4325.040.R100	4	4	8	60	1,0	4
SM4325.040.R150	4	4	8	60	1,5	4
SM4325.050.R030	5	5	10	60	0,3	4
SM4325.050.R050	5	5	10	60	0,5	4
SM4325.050.R100	5	5	10	60	1,0	4
SM4325.050.R150	5	5	10	60	1,5	4
SM4325.050.R200	5	5	10	60	2,0	4
SM4325.060.R030	6	6	12	70	0,3	4
SM4325.060.R050	6	6	12	70	0,5	4
SM4325.060.R100	6	6	12	70	1,0	4
SM4325.060.R150	6	6	12	70	1,5	4
SM4325.060.R200	6	6	12	70	2,0	4
SM4325.060.R250	6	6	12	70	2,5	4
SM4325.080.R030	8	8	16	70	0,3	4
SM4325.080.R050	8	8	16	70	0,5	4
SM4325.080.R100	8	8	16	70	1,0	4
SM4325.080.R150	8	8	16	70	1,5	4
SM4325.080.R200	8	8	16	70	2,0	4
SM4325.080.R250	8	8	16	70	2,5	4
SM4325.080.R300	8	8	16	70	3,0	4
SM4325.100.R030	10	10	20	70	0,3	4
SM4325.100.R050	10	10	20	70	0,5	4

ART.	(mm)					
	ØD	Ød	L1	H	R	z
SM4325.100.R100	10	10	20	70	1,0	4
SM4325.100.R150	10	10	20	70	1,5	4
SM4325.100.R200	10	10	20	70	2,0	4
SM4325.100.R250	10	10	20	70	2,5	4
SM4325.100.R300	10	10	20	70	3,0	4
SM4325.120.R030	12	12	24	80	0,3	4
SM4325.120.R050	12	12	24	80	0,5	4
SM4325.120.R100	12	12	24	80	1,0	4
SM4325.120.R150	12	12	24	80	1,5	4
SM4325.120.R200	12	12	24	80	2,0	4
SM4325.120.R250	12	12	24	80	2,5	4
SM4325.120.R300	12	12	24	80	3,0	4
SM4325.140.R050	14	14	28	90	0,5	4
SM4325.140.R100	14	14	28	90	1,0	4
SM4325.140.R150	14	14	28	90	1,5	4
SM4325.140.R200	14	14	28	90	2,0	4
SM4325.140.R250	14	14	28	90	2,5	4
SM4325.140.R300	14	14	28	90	3,0	4
SM4325.160.R100	16	16	32	90	1,0	4
SM4325.160.R200	16	16	32	90	2,0	4
SM4325.160.R300	16	16	32	90	3,0	4
SM4325.200.R100	20	20	40	120	1,0	4
SM4325.200.R200	20	20	40	120	2,0	4
SM4325.200.R300	20	20	40	120	3,0	4

Applicazione - Application

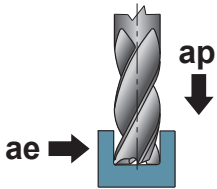

P	M	K	N	S	H	G	(mm) ØD	(m/min) Vc	(mm) fz	(mm) ap	(mm) ae			
												ACCIAIO NON LEGATO NOT ALLOY STEEL	ACCIAIO POCO LEGATO LOW ALLOY STEEL	ACCIAIO ALTO LEGATO ALLOY STEEL
●							3	130-160	0,020-0,035	1xD	1xD			
●							4	130-160	0,020-0,035	1xD	1xD			
●							5	130-160	0,020-0,035	1xD	1xD			
●							6	130-160	0,030-0,045	1xD	1xD			
●							8	130-160	0,040-0,055	1xD	1xD			
●							10	130-160	0,050-0,065	1xD	1xD			
●							12	130-160	0,060-0,075	1xD	1xD			
●							14	130-160	0,070-0,085	1xD	1xD			
●							16	130-160	0,080-0,095	1xD	1xD			
●							20	130-160	0,100-0,115	1xD	1xD			
○							3	50-80	0,020-0,035	1xD	1xD			
○							4	50-80	0,020-0,035	1xD	1xD			
○							5	50-80	0,020-0,035	1xD	1xD			
○							6	50-80	0,030-0,045	1xD	1xD			
○							8	50-80	0,040-0,055	1xD	1xD			
○							10	50-80	0,050-0,065	1xD	1xD			
○							12	50-80	0,060-0,075	1xD	1xD			
○							14	50-80	0,070-0,085	1xD	1xD			
○							16	50-80	0,080-0,095	1xD	1xD			
○							20	50-80	0,100-0,115	1xD	1xD			
		○					3	120-150	0,030-0,045	1xD	1xD			
		○					4	120-150	0,030-0,045	1xD	1xD			
		○					5	120-150	0,040-0,055	1xD	1xD			
		○					6	120-150	0,050-0,065	1xD	1xD			
		○					8	120-150	0,060-0,075	1xD	1xD			
		○					10	120-150	0,070-0,085	1xD	1xD			
		○					12	120-150	0,080-0,095	1xD	1xD			
		○					14	120-150	0,090-0,105	1xD	1xD			
		○					16	120-150	0,090-0,105	1xD	1xD			
		○					20	120-150	0,110-0,125	1xD	1xD			
						●	3	160-190	0,010-0,025	0,025xD	0,025xD			
						●	4	160-190	0,010-0,025	0,025xD	0,025xD			
						●	5	160-190	0,020-0,035	0,025xD	0,025xD			
						●	6	160-190	0,020-0,035	0,025xD	0,025xD			
						●	8	160-190	0,030-0,045	0,025xD	0,025xD			
						●	10	160-190	0,040-0,055	0,025xD	0,025xD			
						●	12	160-190	0,050-0,065	0,025xD	0,025xD			
						●	14	160-190	0,060-0,075	0,025xD	0,025xD			
						●	16	160-190	0,070-0,085	0,025xD	0,025xD			
						●	20	160-190	0,080-0,095	0,025xD	0,025xD			

PER LAVORAZIONI A SPALLAMENTO AUMENTARE I PARAMETRI DEL 20%
FOR SHOULDER MILLING PARAMETERS SHOULD BE INCREASED BY 20%

- APPLICAZIONE CONSIGLIATA-RECOMMENDED APPLICATION
EMPFÖHLENER EINSATZ - APPLICATION CONSEILLÉE
- APPLICAZIONE POSSIBILE - POSSIBLE APPLICATION
MÖGLICHE ANWENDUNG - APPLICATION POSSIBLE

Vc = m/min VELOCITÀ DI TAGLIO - CUTTING SPEED

n = giri/min (min⁻¹) NUMERO DI GIRI - NUMBER OF REVOLUTIONS

fz = mm AVANZAMENTO AL DENTE -TOOTH FEED

fn = mm AVANZAMENTO AL GIRO - FEED / REVOLUTION

Vf = mm/min VELOCITÀ DI AVANZAMENTO - FEED SPEED

$$n = \frac{Vc \cdot 1000}{\text{ØD} \cdot 3,14} = \text{giri/min (min}^{-1}\text{)}$$

$$fn = fz \cdot z = \text{mm}$$

$$Vf = fz \cdot z \cdot n = \text{mm/min}$$

SM4215

ØD = 2 - 16

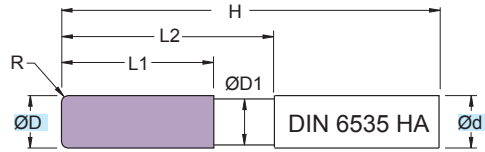

Fresa in M.D.I. Micrograno
 Gambo cilindrico HA

Micrograin HM mills
 cylindrical Shank HA

TOLLERANZE	D	d
TOLLERANCE RANGE	h10	h6

RIVESTIM. COATED
GRAY

52 HRC

HSC

ART.	(mm)							
ART.	ØD	Ød	ØD1	L1	L2	H	R	z
SM4215.020.R010	2	6	1,8	4	21	57	0,1	4
SM4215.020.R020	2	6	1,8	4	21	57	0,2	4
SM4215.020.R030	2	6	1,8	4	21	57	0,3	4
SM4215.020.R040	2	6	1,8	4	21	57	0,4	4
SM4215.040.R010	4	6	3,6	6	21	57	0,1	4
SM4215.040.R020	4	6	3,6	6	21	57	0,2	4
SM4215.040.R030	4	6	3,6	6	21	57	0,3	4
SM4215.040.R040	4	6	3,6	6	21	57	0,4	4
SM4215.040.R050	4	6	3,6	6	21	57	0,5	4
SM4215.040.R060	4	6	3,6	6	21	57	0,6	4
SM4215.040.R070	4	6	3,6	6	21	57	0,7	4
SM4215.040.R080	4	6	3,6	6	21	57	0,8	4
SM4215.040.R090	4	6	3,6	6	21	57	0,9	4
SM4215.040.R100	4	6	3,6	6	21	57	1,0	4
SM4215.040.R110	4	6	3,6	6	21	57	1,1	4
SM4215.040.R120	4	6	3,6	6	21	57	1,2	4
SM4215.040.R130	4	6	3,6	6	21	57	1,3	4
SM4215.040.R140	4	6	3,6	6	21	57	1,4	4
SM4215.040.R150	4	6	3,6	6	21	57	1,5	4
SM4215.060.R010	6	6	5,5	7	21	57	0,1	4
SM4215.060.R020	6	6	5,5	7	21	57	0,2	4
SM4215.060.R030	6	6	5,5	7	21	57	0,3	4
SM4215.060.R040	6	6	5,5	7	21	57	0,4	4
SM4215.060.R050	6	6	5,5	7	21	57	0,5	4
SM4215.060.R060	6	6	5,5	7	21	57	0,6	4
SM4215.060.R070	6	6	5,5	7	21	57	0,7	4
SM4215.060.R080	6	6	5,5	7	21	57	0,8	4
SM4215.060.R090	6	6	5,5	7	21	57	0,9	4
SM4215.060.R100	6	6	5,5	7	21	57	1,0	4
SM4215.060.R110	6	6	5,5	7	21	57	1,1	4
SM4215.060.R120	6	6	5,5	7	21	57	1,2	4

ART.	(mm)							
ART.	ØD	Ød	ØD1	L1	L2	H	R	z
SM4215.060.R130	6	6	5,5	7	21	57	1,3	4
SM4215.060.R140	6	6	5,5	7	21	57	1,4	4
SM4215.060.R150	6	6	5,5	7	21	57	1,5	4
SM4215.060.R160	6	6	5,5	7	21	57	1,6	4
SM4215.060.R170	6	6	5,5	7	21	57	1,7	4
SM4215.060.R180	6	6	5,5	7	21	57	1,8	4
SM4215.060.R190	6	6	5,5	7	21	57	1,9	4
SM4215.060.R200	6	6	5,5	7	21	57	2,0	4
SM4215.060.R210	6	6	5,5	7	21	57	2,1	4
SM4215.060.R220	6	6	5,5	7	21	57	2,2	4
SM4215.060.R230	6	6	5,5	7	21	57	2,3	4
SM4215.060.R240	6	6	5,5	7	21	57	2,4	4
SM4215.060.R250	6	6	5,5	7	21	57	2,5	4
SM4215.080.R050	8	8	7,4	9	27	63	0,5	4
SM4215.080.R100	8	8	7,4	9	27	63	1,0	4
SM4215.080.R150	8	8	7,4	9	27	63	1,5	4
SM4215.080.R200	8	8	7,4	9	27	63	2,0	4
SM4215.100.R050	10	10	9,2	11	32	72	0,5	4
SM4215.100.R100	10	10	9,2	11	32	72	1,0	4
SM4215.100.R150	10	10	9,2	11	32	72	1,5	4
SM4215.100.R200	10	10	9,2	11	32	72	2,0	4
SM4215.120.R050	12	12	11,0	12	38	83	0,5	4
SM4215.120.R100	12	12	11,0	12	38	83	1,0	4
SM4215.120.R150	12	12	11,0	12	38	83	1,5	4
SM4215.120.R200	12	12	11,0	12	38	83	2,0	4
SM4215.160.R050	16	16	15,0	16	44	92	0,5	4
SM4215.160.R100	16	16	15,0	16	44	92	1,0	4
SM4215.160.R150	16	16	15,0	16	44	92	1,5	4
SM4215.160.R200	16	16	15,0	16	44	92	2,0	4

SM4525

ØD = 3 - 20

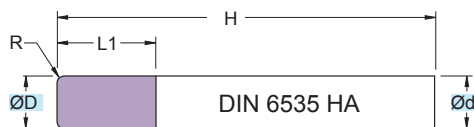

RIVESTIM.
 COATED
GRAY



R

**62
 HRC**



Fresa in M.D.I. Micrograno
 Gambo cilindrico HA

Micrograin HM mills
 Cylindrical Shank HA

TOLLERANZE	D	d
TOLLERANCE RANGE	h10	h6

ART.	(mm)						z
	ØD	Ød	L1	H	R		
SM4525.030.R030	3	3	6	70	0,3		4
SM4525.030.R050	3	3	6	70	0,5		4
SM4525.040.R030	4	4	8	80	0,3		4
SM4525.040.R050	4	4	8	80	0,5		4
SM4525.040.R100	4	4	8	80	1,0		4
SM4525.040.R150	4	4	8	80	1,5		4
SM4525.050.R030	5	5	10	100	0,3		4
SM4525.050.R050	5	5	10	100	0,5		4
SM4525.050.R100	5	5	10	100	1,0		4
SM4525.050.R150	5	5	10	100	1,5		4
SM4525.060.R030	6	6	12	100	0,3		4
SM4525.060.R050	6	6	12	100	0,5		4
SM4525.060.R100	6	6	12	100	1,0		4
SM4525.060.R150	6	6	12	100	1,5		4
SM4525.060.R200	6	6	12	100	2,0		4
SM4525.060.R250	6	6	12	100	2,5		4
SM4525.080.R030	8	8	16	100	0,3		4
SM4525.080.R050	8	8	16	100	0,5		4
SM4525.080.R100	8	8	16	100	1,0		4
SM4525.080.R150	8	8	16	100	1,5		4
SM4525.080.R200	8	8	16	100	2,0		4
SM4525.080.R250	8	8	16	100	2,5		4
SM4525.080.R300	8	8	16	100	3,0		4
SM4525.100.R030	10	10	20	120	0,3		4

ART.	(mm)						z
	ØD	Ød	L1	H	R		
SM4525.100.R050	10	10	20	120	0,5		4
SM4525.100.R100	10	10	20	120	1,0		4
SM4525.100.R150	10	10	20	120	1,5		4
SM4525.100.R200	10	10	20	120	2,0		4
SM4525.100.R250	10	10	20	120	2,5		4
SM4525.100.R300	10	10	20	120	3,0		4
SM4525.120.R030	12	12	24	120	0,3		4
SM4525.120.R050	12	12	24	120	0,5		4
SM4525.120.R100	12	12	24	120	1,0		4
SM4525.120.R150	12	12	24	120	1,5		4
SM4525.120.R200	12	12	24	120	2,0		4
SM4525.120.R250	12	12	24	120	2,5		4
SM4525.120.R300	12	12	24	120	3,0		4
SM4525.140.R050	14	14	28	120	0,5		4
SM4525.140.R100	14	14	28	120	1,0		4
SM4525.140.R150	14	14	28	120	1,5		4
SM4525.140.R200	14	14	28	120	2,0		4
SM4525.140.R250	14	14	28	120	2,5		4
SM4525.140.R300	14	14	28	120	3,0		4
SM4525.160.R100	16	16	32	120	1,0		4
SM4525.160.R200	16	16	32	120	2,0		4
SM4525.160.R300	16	16	32	120	3,0		4
SM4525.200.R100	20	20	40	160	1,0		4
SM4525.200.R200	20	20	40	160	2,0		4
SM4525.200.R300	20	20	40	160	3,0		4

Applicazione - Application

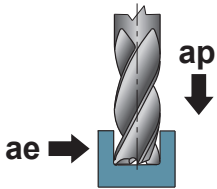

P	M	K	N	S	H	G	(mm) ØD	(m/min) Vc	(mm) fz	(mm) ap	(mm) ae			
												ACCIAIO NON LEGATO NOT ALLOY STEEL	ACCIAIO POCO LEGATO LOW ALLOY STEEL	ACCIAIO ALTO LEGATO ALLOY STEEL
							3	130-160	0,020-0,035	1xD	1xD			
							4	130-160	0,020-0,035	1xD	1xD			
							5	130-160	0,020-0,035	1xD	1xD			
							6	130-160	0,030-0,045	1xD	1xD			
							8	130-160	0,040-0,055	1xD	1xD			
							10	130-160	0,050-0,065	1xD	1xD			
							12	130-160	0,060-0,075	1xD	1xD			
							14	130-160	0,070-0,085	1xD	1xD			
							16	130-160	0,080-0,095	1xD	1xD			
							20	130-160	0,100-0,115	1xD	1xD			
							3	50-80	0,020-0,035	1xD	1xD			
							4	50-80	0,020-0,035	1xD	1xD			
							5	50-80	0,020-0,035	1xD	1xD			
							6	50-80	0,030-0,045	1xD	1xD			
							8	50-80	0,040-0,055	1xD	1xD			
							10	50-80	0,050-0,065	1xD	1xD			
							12	50-80	0,060-0,075	1xD	1xD			
							14	50-80	0,070-0,085	1xD	1xD			
							16	50-80	0,080-0,095	1xD	1xD			
							20	50-80	0,100-0,115	1xD	1xD			
							3	120-150	0,030-0,045	1xD	1xD			
							4	120-150	0,030-0,045	1xD	1xD			
							5	120-150	0,040-0,055	1xD	1xD			
							6	120-150	0,050-0,065	1xD	1xD			
							8	120-150	0,060-0,075	1xD	1xD			
							10	120-150	0,070-0,085	1xD	1xD			
							12	120-150	0,080-0,095	1xD	1xD			
							14	120-150	0,090-0,105	1xD	1xD			
							16	120-150	0,090-0,105	1xD	1xD			
							20	120-150	0,110-0,125	1xD	1xD			
							3	160-190	0,010-0,025	0,025xD	0,025xD			
							4	160-190	0,010-0,025	0,025xD	0,025xD			
							5	160-190	0,020-0,035	0,025xD	0,025xD			
							6	160-190	0,020-0,035	0,025xD	0,025xD			
							8	160-190	0,030-0,045	0,025xD	0,025xD			
							10	160-190	0,040-0,055	0,025xD	0,025xD			
							12	160-190	0,050-0,065	0,025xD	0,025xD			
							14	160-190	0,060-0,075	0,025xD	0,025xD			
							16	160-190	0,070-0,085	0,025xD	0,025xD			
							20	160-190	0,080-0,095	0,025xD	0,025xD			

PER LAVORAZIONI A SPALLAMENTO AUMENTARE I PARAMETRI DEL 20%
FOR SHOULDER MILLING PARAMETERS SHOULD BE INCREASED BY 20%

- APPLICAZIONE CONSIGLIATA-RECOMMENDED APPLICATION
EMPFÖHLENER EINSATZ - APPLICATION CONSEILLÉE
- APPLICAZIONE POSSIBILE - POSSIBLE APPLICATION
MÖGLICHE ANWENDUNG - APPLICATION POSSIBLE

Vc = m/min VELOCITÀ DI TAGLIO - CUTTING SPEED

n = giri/min (min⁻¹) NUMERO DI GIRI - NUMBER OF REVOLUTIONS

fz = mm AVANZAMENTO AL DENTE -TOOTH FEED

fn = mm AVANZAMENTO AL GIRO - FEED / REVOLUTION

Vf = mm/min VELOCITÀ DI AVANZAMENTO - FEED SPEED

$$n = \frac{Vc \cdot 1000}{\text{ØD} \cdot 3,14} = \text{giri/min (min}^{-1}\text{)}$$

$$fn = fz \cdot z = \text{mm}$$

$$Vf = fz \cdot z \cdot n = \text{mm/min}$$

SMW4403

ØD = 3 - 20

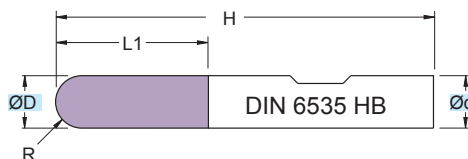
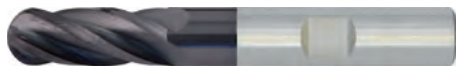

RIVESTIM.
 COATED
BLACK



R

**42
 HRC**



Fresa in M.D.I. Micrograno
 Gambo sec. DIN 6535 HB

Micrograin HM mills
 DIN 6535 HB Shank

TOLLERANZE	D	d
TOLLERANCE RANGE	h10	h6

ART.	(mm)					
	ØD	Ød	L1	H	R	z
SMW4403.030.S015	3	3	7	38	1,5	4
SMW4403.040.S020	4	4	14	50	2,0	4
SMW4403.050.S025	5	6	14	50	2,5	4
SMW4403.060.S030	6	6	19	60	3,0	4
SMW4403.080.S040	8	8	20	60	4,0	4
SMW4403.100.S050	10	10	21	70	5,0	4
SMW4403.120.S060	12	12	25	75	6,0	4
SMW4403.160.S080	16	16	32	88	8,0	4
SMW4403.200.S100	20	20	38	104	10,0	4

Applicazione - Application

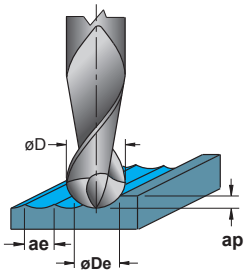

P	M	K	N	S	H	G	ØDe	Vc	fz	ap	ae			
												ACCIAIO NON LEGATO NOT ALLOY STEEL	ACCIAIO POCO LEGATO LOW ALLOY STEEL	ACCIAIO ALTO LEGATO ALLOY STEEL
●							3	80-110	0,020-0,035	0,05xD	0,06xD			
●							4	80-110	0,035-0,050	0,05xD	0,06xD			
●							5	80-110	0,035-0,050	0,05xD	0,06xD			
●							6	80-110	0,035-0,050	0,05xD	0,06xD			
●							8	80-110	0,040-0,055	0,05xD	0,06xD			
●							10	80-110	0,040-0,055	0,05xD	0,06xD			
●							12	80-110	0,060-0,075	0,05xD	0,06xD			
●							16	80-110	0,070-0,085	0,05xD	0,06xD			
●							20	80-110	0,080-0,095	0,05xD	0,06xD			
	●						3	55-85	0,005-0,020	0,05xD	0,06xD			
	●						4	55-85	0,020-0,035	0,05xD	0,06xD			
	●						5	55-85	0,020-0,035	0,05xD	0,06xD			
	●						6	55-85	0,020-0,035	0,05xD	0,06xD			
	●						8	55-85	0,030-0,045	0,05xD	0,06xD			
	●						10	55-85	0,030-0,045	0,05xD	0,06xD			
	●						12	55-85	0,040-0,055	0,05xD	0,06xD			
	●						16	55-85	0,050-0,065	0,05xD	0,06xD			
	●						20	55-85	0,060-0,075	0,05xD	0,06xD			
		●					3	30-60	0,003-0,015	0,05xD	0,06xD			
		●					4	30-60	0,010-0,025	0,05xD	0,06xD			
		●					5	30-60	0,010-0,025	0,05xD	0,06xD			
		●					6	30-60	0,010-0,025	0,05xD	0,06xD			
		●					8	30-60	0,020-0,035	0,05xD	0,06xD			
		●					10	30-60	0,020-0,035	0,05xD	0,06xD			
		●					12	30-60	0,030-0,045	0,05xD	0,06xD			
		●					16	30-60	0,040-0,055	0,05xD	0,06xD			
		●					20	30-60	0,050-0,065	0,05xD	0,06xD			
			●				3	100-130	0,025-0,040	0,05xD	0,06xD			
			●				4	100-130	0,050-0,065	0,05xD	0,06xD			
			●				5	100-130	0,050-0,065	0,05xD	0,06xD			
			●				6	100-130	0,050-0,065	0,05xD	0,06xD			
			●				8	100-130	0,060-0,075	0,05xD	0,06xD			
			●				10	100-130	0,060-0,075	0,05xD	0,06xD			
			●				12	100-130	0,080-0,095	0,05xD	0,06xD			
			●				16	100-130	0,110-0,125	0,05xD	0,06xD			
			●				20	100-130	0,130-0,145	0,05xD	0,06xD			
				●			3	100-130	0,020-0,035	0,05xD	0,06xD			
				●			4	100-130	0,035-0,050	0,05xD	0,06xD			
				●			5	100-130	0,035-0,050	0,05xD	0,06xD			
				●			6	100-130	0,035-0,050	0,05xD	0,06xD			
				●			8	100-130	0,040-0,055	0,05xD	0,06xD			
				●			10	100-130	0,040-0,055	0,05xD	0,06xD			
				●			12	100-130	0,060-0,075	0,05xD	0,06xD			
				●			16	100-130	0,070-0,085	0,05xD	0,06xD			
				●			20	100-130	0,080-0,095	0,05xD	0,06xD			

● APPLICAZIONE CONSIGLIATA-RECOMMENDED APPLICATION
EMPFOLHENER EINSATZ - APPLICATION CONSEILLÉE

○ APPLICAZIONE POSSIBILE - POSSIBLE APPLICATION
MÖGLICHE ANWENDUNG - APPLICATION POSSIBLE

DATI TECNICI LAVORAZIONI PAG. 1152 - 1153
MACHINING TECHNICAL DATA PAGE 1152 - 1153
BEARBEITUNGSSCHNITTDATEN S. 1152 - 1153
DONNEES TECHNIQUES USINAGES PAGES 1152 - 1153

øD = mm DIAMETRO - DIAMETER

øDe = mm DIAMETRO EFFETTIVO - EFFECTIVE DIAMETER

Vc = m/min VELOCITÀ DI TAGLIO - CUTTING SPEED

n = giri/min (min⁻¹) NUMERO DI GIRI - NUMBER OF REVOLUTIONS

fz = mm AVANZAMENTO AL DENTE -TOOTH FEED

fn = mm AVANZAMENTO AL GIRO - FEED / REVOLUTION

Vf = mm/min VELOCITÀ DI AVANZAMENTO - FEED SPEED

$$n = \frac{Vc \cdot 1000}{\text{ØDe} \cdot 3,14} = \text{giri/min (min}^{-1}\text{)}$$

$$fn = fz \cdot z = \text{mm}$$

$$Vf = fz \cdot z \cdot n = \text{mm/min}$$

SM6402

ØD = 4 - 20

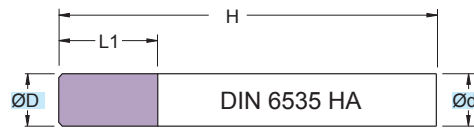

RIVESTIM.
 COATED
GRAY



45°

**42
 HRC**



Fresa in M.D.I. Micrograno
 Gambo sec. DIN 6535 HA

Micrograin HM mills
 DIN 6535 HA Shank

TOLLERANZE	D	d
TOLLERANCE RANGE	h10	h6

ART.	(mm)					
	ØD	Ød	L1	H	45°	z
SM6402.040.N00	4	6	11	57	0,1	6
SM6402.050.N00	5	6	13	57	0,1	6
SM6402.060.N00	6	6	13	57	0,1	6
SM6402.080.N00	8	8	19	63	0,1	6
SM6402.100.N00	10	10	22	72	0,1	6
SM6402.120.N00	12	12	26	83	0,1	6
SM6402.160.N00	16	16	32	92	0,1	6
SM6402.200.N00	20	20	38	104	0,1	8

Applicazione - Application

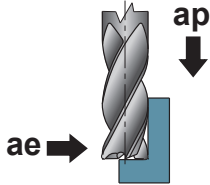

	MATERIALI - MATERIALS											ØD (mm)	Vc (m/min)	fz (mm)	ap (mm)	ae (mm)				
	P	M	K			N			S	H	G									
	ACCIAIO NON LEGATO NOT ALLOY STEEL	ACCIAIO POCO LEGATO LOW ALLOY STEEL	ACCIAIO ALTO LEGATO ALLOY STEEL	INOX MARTENSITICO STAINLESS STEEL MART.	INOX AUST. DUPLEX STAINLESS STEEL AUST.	GHISA GRIGIA GREY CAST IRON	GHISA SFEROIDALE SPHEROIDAL GRAPHITE	GHISA MALLEABILE MALLEABLE CAST IRON	ALLUMINIO E SUE LEGHE ALUMINIUM	RAME E SUE LEGHE COPPER	NON METALLICI PLASTICS	LEGHE RESIST. CALORE HIGH TEMP. ALLOY	TITANIO E SUE LEGHE TITANIUM	ACCIAIO TEMPRATO HARDENED STEEL	GRAFITE GRAPHITE					
●																6	140-170	0,010-0,025	9	0,3
●																8	140-170	0,015-0,030	12	0,4
●																10	140-170	0,020-0,035	15	0,5
●																12	140-170	0,035-0,050	18	0,6
●																16	140-170	0,040-0,055	24	0,8
●																20	140-170	0,050-0,065	30	1,0
○	●															6	70-100	0,005-0,020	9	0,3
○	●															8	70-100	0,010-0,025	12	0,4
○	●															10	70-100	0,015-0,030	15	0,5
○	●															12	70-100	0,025-0,040	18	0,6
○	●															16	70-100	0,035-0,050	24	0,8
○	●															20	70-100	0,040-0,055	30	1,0
○		●														6	60-90	0,005-0,020	9	0,3
○		●														8	60-90	0,010-0,025	12	0,4
○		●														10	60-90	0,015-0,030	15	0,5
○		●														12	60-90	0,025-0,040	18	0,6
○		●														16	60-90	0,035-0,050	24	0,8
○		●														20	60-90	0,040-0,055	30	1,0
○			●													6	20-50	0,005-0,020	9	0,1
○			●													8	20-50	0,010-0,025	12	0,1
○			●													10	20-50	0,015-0,030	15	0,1
○			●													12	20-50	0,020-0,035	18	0,1
○			●													16	20-50	0,030-0,045	24	0,1
○			●													20	20-50	0,040-0,055	30	0,1
○				●												6	135-165	0,005-0,020	9	0,3
○				●												8	135-165	0,010-0,025	12	0,4
○				●												10	135-165	0,015-0,030	15	0,5
○				●												12	135-165	0,025-0,040	18	0,6
○				●												16	135-165	0,035-0,050	24	0,8
○				●												20	135-165	0,040-0,055	30	1,0
○					●											6	110-140	0,005-0,020	9	0,3
○					●											8	110-140	0,010-0,025	12	0,4
○					●											10	110-140	0,015-0,030	15	0,5
○					●											12	110-140	0,025-0,040	18	0,6
○					●											16	110-140	0,035-0,050	24	0,8
○					●											20	110-140	0,040-0,055	30	1,0
○									●							6	80-110	0,005-0,020	9	0,1
○									●							8	80-110	0,010-0,025	12	0,1
○									●							10	80-110	0,020-0,035	15	0,1
○									●							12	80-110	0,030-0,045	18	0,1
○									●							16	80-110	0,040-0,055	24	0,1
○									●							20	80-110	0,050-0,065	30	0,1
○											●					6	15-40	0,005-0,020	9	0,1
○											●					8	15-40	0,010-0,025	12	0,1
○											●					10	15-40	0,015-0,030	15	0,1
○											●					12	15-40	0,020-0,035	18	0,1
○											●					16	15-40	0,030-0,045	24	0,1
○											●					20	15-40	0,040-0,055	30	0,1
○												●				6	40-60	0,005-0,020	9	0,1
○												●				8	40-60	0,010-0,025	12	0,1
○												●				10	40-60	0,015-0,030	15	0,1
○												●				12	40-60	0,020-0,035	18	0,1
○												●				16	40-60	0,030-0,045	24	0,1
○												●				20	40-60	0,040-0,055	30	0,1

● APPLICAZIONE CONSIGLIATA-RECOMMENDED APPLICATION
EMPFÖHLENER EINSATZ - APPLICATION CONSEILLÉE

○ APPLICAZIONE POSSIBILE - POSSIBLE APPLICATION
MÖGLICHE ANWENDUNG - APPLICATION POSSIBLE

Vc = m/min VELOCITÀ DI TAGLIO - CUTTING SPEED

n = giri/min (min⁻¹) NUMERO DI GIRI - NUMBER OF REVOLUTIONS

fz = mm AVANZAMENTO AL DENTE -TOOTH FEED

fn = mm AVANZAMENTO AL GIRO - FEED / REVOLUTION

Vf = mm/min VELOCITÀ DI AVANZAMENTO - FEED SPEED

$$n = \frac{Vc \cdot 1000}{\text{ØD} \cdot 3,14} = \text{giri/min (min}^{-1}\text{)}$$

$$fn = fz \cdot z = \text{mm}$$

$$Vf = fz \cdot z \cdot n = \text{mm/min}$$

SM6502

ØD = 4 - 20

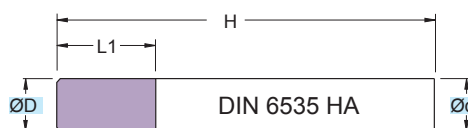

RIVESTIM.
 COATED
GRAY



45°

**42
 HRC**



Fresa in M.D.I. Micrograno
 Gambo sec. DIN 6535 HA

Micrograin HM mills
 DIN 6535 HA Shank

TOLLERANZE	D	d
TOLLERANCE RANGE	h10	h6

ART.	(mm)					
	ØD	Ød	L1	H	45°	z
SM6502.040.N00	4	6	16	62	0,1	6
SM6502.050.N00	5	6	18	62	0,1	6
SM6502.060.N00	6	6	18	62	0,1	6
SM6502.080.N00	8	8	24	68	0,1	6
SM6502.100.N00	10	10	30	80	0,1	6
SM6502.120.N00	12	12	36	93	0,1	6
SM6502.160.N00	16	16	48	108	0,1	6
SM6502.200.N00	20	20	60	126	0,1	8

Applicazione - Application

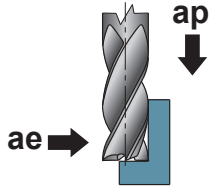

	MATERIALI - MATERIALS											ØD (mm)	Vc (m/min)	fz (mm)	ap (mm)	ae (mm)				
	P			M	K			N			S						H	G		
	ACCIAIO NON LEGATO NOT ALLOY STEEL	ACCIAIO POCO LEGATO LOW ALLOY STEEL	ACCIAIO ALTO LEGATO ALLOY STEEL	INOX MARTENSITICO STAINLESS STEEL MART.	INOX AUST. DUPLEX STAINLESS STEEL AUST.	GHISA GRIGIA GREY CAST IRON	GHISA SFEROIDALE SPHEROIDAL GRAPHITE	GHISA MALLEABILE MALLEABLE CAST IRON	ALLUMINIO E SUE LEGHE ALUMINIUM	RAME E SUE LEGHE COPPER	NON METALLICI PLASTICS	LEGHE RESIST. CALORE HIGH TEMP. ALLOY	TITANIO E SUE LEGHE TITANIUM	ACCIAIO TEMPRATO HARDENED STEEL	GRAFITE GRAPHITE					
●																6	100-130	0,005-0,020	15	0,18
●																8	100-130	0,010-0,025	20	0,24
●																10	100-130	0,015-0,030	25	0,30
●																12	100-130	0,020-0,035	30	0,36
●																16	100-130	0,030-0,045	40	0,48
●																20	100-130	0,035-0,050	50	0,60
○																6	50-80	0,003-0,015	15	0,18
○																8	50-80	0,005-0,020	20	0,24
○																10	50-80	0,010-0,025	25	0,30
○																12	50-80	0,020-0,035	30	0,36
○																16	50-80	0,025-0,040	40	0,48
○																20	50-80	0,030-0,045	50	0,60
○			●													6	40-70	0,003-0,015	15	0,18
○			●													8	40-70	0,005-0,020	20	0,24
○			●													10	40-70	0,010-0,025	25	0,30
○			●													12	40-70	0,020-0,035	30	0,36
○			●													16	40-70	0,025-0,040	40	0,48
○			●													20	40-70	0,030-0,045	50	0,60
○				●												6	20-40	0,003-0,015	15	0,1
○				●												8	20-40	0,005-0,020	20	0,1
○				●												10	20-40	0,010-0,025	25	0,1
○				●												12	20-40	0,020-0,035	30	0,1
○				●												16	20-40	0,025-0,040	40	0,1
○				●												20	20-40	0,030-0,045	50	0,1
○					●											6	140-170	0,003-0,015	15	0,18
○					●											8	140-170	0,005-0,020	20	0,24
○					●											10	140-170	0,010-0,025	25	0,30
○					●											12	140-170	0,020-0,035	30	0,36
○					●											16	140-170	0,025-0,040	40	0,48
○					●											20	140-170	0,030-0,045	50	0,60
○						●										6	120-150	0,003-0,015	15	0,18
○						●										8	120-150	0,005-0,020	20	0,24
○						●										10	120-150	0,010-0,025	25	0,30
○						●										12	120-150	0,020-0,035	30	0,36
○						●										16	120-150	0,025-0,040	40	0,48
○						●										20	120-150	0,030-0,045	50	0,60
○										●						6	110-140	0,003-0,015	15	0,1
○										●						8	110-140	0,005-0,020	20	0,1
○										●						10	110-140	0,010-0,025	25	0,1
○										●						12	110-140	0,020-0,035	30	0,1
○										●						16	110-140	0,025-0,040	40	0,1
○										●						20	110-140	0,030-0,045	50	0,1
○											●					6	15-30	0,003-0,015	15	0,1
○											●					8	15-30	0,005-0,020	20	0,1
○											●					10	15-30	0,010-0,025	25	0,1
○											●					12	15-30	0,020-0,035	30	0,1
○											●					16	15-30	0,025-0,040	40	0,1
○											●					20	15-30	0,030-0,045	50	0,1
○												●				6	35-50	0,003-0,015	15	0,1
○												●				8	35-50	0,005-0,020	20	0,1
○												●				10	35-50	0,010-0,025	25	0,1
○												●				12	35-50	0,020-0,035	30	0,1
○												●				16	35-50	0,025-0,040	40	0,1
○												●				20	35-50	0,030-0,045	50	0,1

● APPLICAZIONE CONSIGLIATA-RECOMMENDED APPLICATION
EMPFÖHLENER EINSATZ - APPLICATION CONSEILLÉE

○ APPLICAZIONE POSSIBILE - POSSIBLE APPLICATION
MÖGLICHE ANWENDUNG - APPLICATION POSSIBLE

Vc = m/min VELOCITÀ DI TAGLIO - CUTTING SPEED

n = giri/min (min⁻¹) NUMERO DI GIRI - NUMBER OF REVOLUTIONS

fz = mm AVANZAMENTO AL DENTE -TOOTH FEED

fn = mm AVANZAMENTO AL GIRO - FEED / REVOLUTION

Vf = mm/min VELOCITÀ DI AVANZAMENTO - FEED SPEED

$$n = \frac{Vc \cdot 1000}{\text{ØD} \cdot 3,14} = \text{giri/min (min}^{-1}\text{)}$$

$$fn = fz \cdot z = \text{mm}$$

$$Vf = fz \cdot z \cdot n = \text{mm/min}$$

SM6432

ØD = 6 - 20

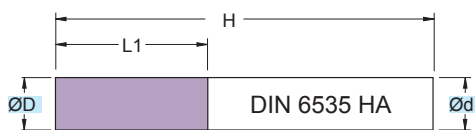

RIVESTIM.
COATED
GRAY



90°

**64
HRC**



Fresa in M.D.I. Micrograno
 Gambo cilindrico HA

Micrograin HM mills
 Cylindrical Shank HA

TOLLERANZE	D	d
TOLERANCE RANGE	h10	h6

ART.	(mm)				
	ØD	Ød	L1	H	z
SM6432.040.N00	4	6	11	57	6
SM6432.050.N00	5	6	13	57	6
SM6432.060.N00	6	6	13	57	6
SM6432.080.N00	8	8	19	63	6
SM6432.100.N00	10	10	22	72	6
SM6432.120.N00	12	12	26	83	6
SM6432.140.N00	14	14	26	83	6
SM6432.160.N00	16	16	32	92	8
SM6432.180.N00	18	18	32	92	8
SM6432.200.N00	20	20	38	104	8

Applicazione - Application

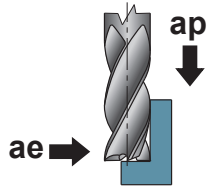

P	M	K	N	S	H	G	(mm) ØD	(m/min) Vc	(mm) fz	(mm) ap	(mm) ae			
												ACCIAIO NON LEGATO NOT ALLOY STEEL	ACCIAIO POCO LEGATO LOW ALLOY STEEL	ACCIAIO ALTO LEGATO ALLOY STEEL
●							6	75-105	0,020-0,035	9	0,1			
●							8	75-105	0,030-0,045	12	0,1			
●							10	75-105	0,035-0,050	15	0,1			
●							12	75-105	0,050-0,065	18	0,1			
●							14	75-105	0,050-0,065	21	0,1			
●							16	75-105	0,060-0,075	24	0,1			
●							18	75-105	0,070-0,085	27	0,1			
●							20	75-105	0,090-0,105	30	0,1			
						●	6	25-55	0,005-0,020	9	0,1			
						●	8	25-55	0,010-0,025	12	0,1			
						●	10	25-55	0,020-0,035	15	0,1			
						●	12	25-55	0,025-0,040	18	0,1			
						●	14	25-55	0,030-0,045	21	0,1			
						●	16	25-55	0,035-0,050	24	0,1			
						●	18	25-55	0,040-0,055	27	0,1			
						●	20	25-55	0,045-0,060	30	0,1			

● APPLICAZIONE CONSIGLIATA-RECOMMENDED APPLICATION
EMPFOLLENER EINSATZ - APPLICATION CONSEILLÉE

○ APPLICAZIONE POSSIBILE - POSSIBLE APPLICATION
MÖGLICHE ANWENDUNG - APPLICATION POSSIBLE

Vc = m/min VELOCITÀ DI TAGLIO - CUTTING SPEED
 n = giri/min (min⁻¹) NUMERO DI GIRI - NUMBER OF REVOLUTIONS
 fz = mm AVANZAMENTO AL DENTE -TOOTH FEED
 fn = mm AVANZAMENTO AL GIRO - FEED / REVOLUTION
 Vf = mm/min VELOCITÀ DI AVANZAMENTO - FEED SPEED

$$n = \frac{Vc \cdot 1000}{\text{ØD} \cdot 3,14} = \text{giri/min (min}^{-1}\text{)}$$

$$fn = fz \cdot z = \text{mm}$$

$$Vf = fz \cdot z \cdot n = \text{mm/min}$$

SM6532

ØD = 6 - 20

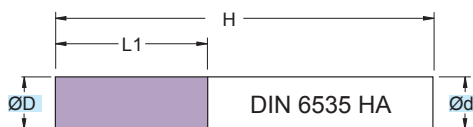

RIVESTIM.
 COATED
GRAY



90°

**64
 HRC**



Fresa in M.D.I. Micrograno
 Gambo cilindrico HA

Micrograin HM mills
 Cylindrical Shank HA

TOLLERANZE	D	d
TOLLERANCE RANGE	h10	h6

ART.	(mm)				
	ØD	Ød	L1	H	z
SM6532.060.N00	6	6	18	62	6
SM6532.080.N00	8	8	24	68	6
SM6532.100.N00	10	10	30	80	6
SM6532.120.N00	12	12	36	93	6
SM6532.140.N00	14	14	42	99	6
SM6532.160.N00	16	16	48	108	8
SM6532.180.N00	18	18	54	114	8
SM6532.200.N00	20	20	60	126	8

Applicazione - Application

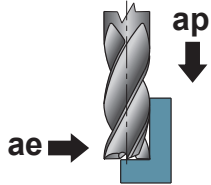

	MATERIALI - MATERIALS											(mm) ØD	(m/min) Vc	(mm) fz	(mm) ap	(mm) ae					
	P	M	K			N			S	H	G										
	ACCIAIO NON LEGATO NOT ALLOY STEEL	ACCIAIO POCO LEGATO LOW ALLOY STEEL	ACCIAIO ALTO LEGATO ALLOY STEEL	INOX MARTENSITICO STAINLESS STEEL MART.	INOX AUST. DUPLEX STAINLESS STEEL AUST.	GHISA GRIGIA GREY CAST IRON	GHISA SFEROIDALE SPHEROIDAL GRAPHITE	GHISA MALLEABILE MALLEABLE CAST IRON	ALLUMINIO E SUE LEGHE ALUMINIUM	RAME E SUE LEGHE COPPER	NON METALLICI PLASTICS	LEGHE RESIST. CALORE HIGH TEMP. ALLOY	TITANIO E SUE LEGHE TITANIUM	ACCIAIO TEMPRATO HARDENED STEEL	GRAFITE GRAPHITE						
●	●																6	45-75	0,015-0,030	15	0,1
●	●																8	45-75	0,025-0,040	20	0,1
●	●																10	45-75	0,030-0,045	25	0,1
●	●																12	45-75	0,035-0,050	30	0,1
●	●																14	45-75	0,045-0,060	35	0,1
●	●																16	45-75	0,050-0,065	40	0,1
●	●																18	45-75	0,060-0,075	45	0,1
●	●																20	45-75	0,070-0,085	50	0,1
														●			6	20-40	0,010-0,025	15	0,1
														●			8	20-40	0,015-0,030	20	0,1
														●			10	20-40	0,025-0,040	25	0,1
														●			12	20-40	0,030-0,045	30	0,1
														●			14	20-40	0,040-0,055	35	0,1
														●			16	20-40	0,045-0,060	40	0,1
														●			18	20-40	0,050-0,065	45	0,1
														●			20	20-40	0,060-0,075	50	0,1

● APPLICAZIONE CONSIGLIATA-RECOMMENDED APPLICATION
EMPFOLHENER EINSATZ - APPLICATION CONSEILLÉE

○ APPLICAZIONE POSSIBILE - POSSIBLE APPLICATION
MÖGLICHE ANWENDUNG - APPLICATION POSSIBLE

Vc = m/min VELOCITÀ DI TAGLIO - CUTTING SPEED

n = giri/min (min⁻¹) NUMERO DI GIRI - NUMBER OF REVOLUTIONS

fz = mm AVANZAMENTO AL DENTE -TOOTH FEED

fn = mm AVANZAMENTO AL GIRO - FEED / REVOLUTION

Vf = mm/min VELOCITÀ DI AVANZAMENTO - FEED SPEED

$$n = \frac{Vc \cdot 1000}{\text{ØD} \cdot 3,14} = \text{giri/min (min}^{-1}\text{)}$$

$$fn = fz \cdot z = \text{mm}$$

$$Vf = fz \cdot z \cdot n = \text{mm/min}$$

SM7215..TI

ØD = 6 - 16

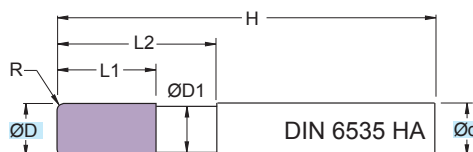

Fresa in M.D.I. Micrograno
 Gambo sec. DIN 6535 HA

Micrograin HM mills
 DIN 6535 HA Shank

TOLLERANZE	D	d
TOLLERANCE RANGE	h10	h6

RIVESTIM. COATED	
ORANGE	
R	52 HRC

(mm)								
ART.	ØD	Ød	ØD1	L1	L2	H	R	z
SM7215.060.R050.TI	6	6	5,8	13	20	58	0,50	5
SM7215.060.R100.TI	6	6	5,8	13	20	58	1,00	5
SM7215.080.R050.TI	8	8	7,7	19	28	64	0,50	5
SM7215.080.R100.TI	8	8	7,7	19	28	64	1,00	5
SM7215.080.R150.TI	8	8	7,7	19	28	64	1,50	5
SM7215.080.R200.TI	8	8	7,7	19	28	64	2,00	5
SM7215.100.R050.TI	10	10	9,5	22	33	73	0,50	7
SM7215.100.R100.TI	10	10	9,5	22	33	73	1,00	7
SM7215.100.R150.TI	10	10	9,5	22	33	73	1,50	7
SM7215.100.R200.TI	10	10	9,5	22	33	73	2,00	7
SM7215.100.R300.TI	10	10	9,5	22	33	73	3,00	7
SM7215.120.R050.TI	12	12	11,5	26	38	84	0,50	9
SM7215.120.R100.TI	12	12	11,5	26	38	84	1,00	9
SM7215.120.R150.TI	12	12	11,5	26	38	84	1,50	9
SM7215.120.R200.TI	12	12	11,5	26	38	84	2,00	9
SM7215.120.R300.TI	12	12	11,5	26	38	84	3,00	9
SM7215.160.R100.TI	16	16	15,5	32	45	93	1,00	9
SM7215.160.R150.TI	16	16	15,5	32	45	93	1,50	9
SM7215.160.R200.TI	16	16	15,5	32	45	93	2,00	9
SM7215.160.R300.TI	16	16	15,5	32	45	93	3,00	9
SM7215.160.R400.TI	16	16	15,5	32	45	93	4,00	9

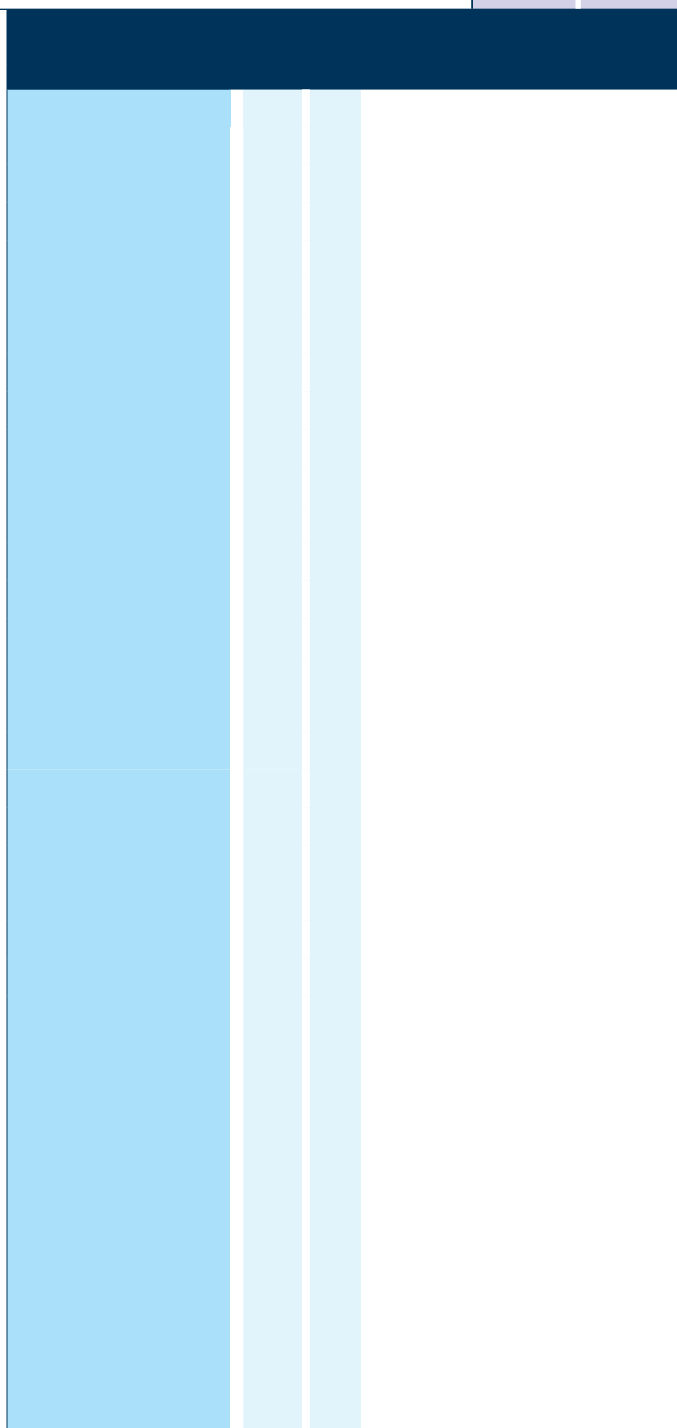

Applicazione - Application

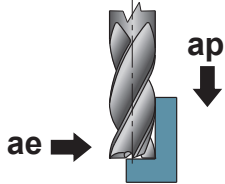

	MATERIALI - MATERIALS													(mm) ØD	(m/min) Vc	(mm) fz	(mm) ap	(mm) ae		
	P				M	K				N			S						H	G
	ACCIAIO NON LEGATO NOT ALLOY STEEL	ACCIAIO POCO LEGATO LOW ALLOY STEEL	ACCIAIO ALTO LEGATO ALLOY STEEL	INOX MARTENSITICO STAINLESS STEEL MART.	INOX AUST. DUPLEX STAINLESS STEEL AUST.	GHISA GRIGIA GREY CAST IRON	GHISA SFEROIDALE SPHEROIDAL GRAPHITE	GHISA MALLEABILE MALLEABLE CAST IRON	ALLUMINIO E SUE LEGHE ALUMINIUM	RAME E SUE LEGHE COPPER	NON METALLICI PLASTICS	LEGHE RESIST. CALORE HIGH TEMP. ALLOY	TITANIO E SUE LEGHE TITANIUM	ACCIAIO TEMPRATO HARDENED STEEL	GRAFITE GRAPHITE					
○																6+8	110-140	0,025-0,040	1xD	0,25xD
○																8+10	110-140	0,030-0,045	1xD	0,25xD
○																10+12	110-140	0,040-0,055	1xD	0,25xD
○																12+16	110-140	0,055-0,070	1xD	0,25xD
○																6+8	105-135	0,025-0,040	1xD	0,15xD
○																8+10	105-135	0,030-0,045	1xD	0,15xD
○																10+12	105-135	0,040-0,055	1xD	0,15xD
○																12+16	105-135	0,055-0,070	1xD	0,15xD
		○														6+8	100-130	0,025-0,040	1xD	0,15xD
		○														8+10	100-130	0,030-0,045	1xD	0,15xD
		○														10+12	100-130	0,040-0,055	1xD	0,15xD
		○														12+16	100-130	0,055-0,070	1xD	0,15xD
					●											6+8	100-110	0,025-0,045	1xD	0,15xD
					●											8+10	100-110	0,030-0,055	1xD	0,15xD
					●											10+12	100-110	0,040-0,075	1xD	0,15xD
					●											12+16	100-110	0,050-0,085	1xD	0,15xD
												●				6+8	30-50	0,015-0,025	1xD	0,15xD
												●				8+10	30-50	0,020-0,035	1xD	0,15xD
												●				10+12	30-50	0,025-0,040	1xD	0,15xD
												●				12+16	30-50	0,030-0,050	1xD	0,15xD
													●			6+8	55-80	0,030-0,045	1xD	0,15xD
													●			8+10	55-80	0,035-0,060	1xD	0,15xD
													●			10+12	55-80	0,045-0,070	1xD	0,15xD
													●			12+16	55-80	0,050-0,090	1xD	0,15xD
														○		6+8	20-40	0,003-0,015	0,25xD	0,15xD
														○		8+10	20-40	0,002-0,017	0,25xD	0,15xD
														○		10+12	20-40	0,005-0,020	0,25xD	0,15xD
														○		12+16	20-40	0,010-0,025	0,25xD	0,15xD

● APPLICAZIONE CONSIGLIATA-RECOMMENDED APPLICATION
EMPFÖHLENER EINSATZ - APPLICATION CONSEILLÉE

○ APPLICAZIONE POSSIBILE - POSSIBLE APPLICATION
MÖGLICHE ANWENDUNG - APPLICATION POSSIBLE

Vc = m/min VELOCITÀ DI TAGLIO - CUTTING SPEED

n = giri/min (min⁻¹) NUMERO DI GIRI - NUMBER OF REVOLUTIONS

fz = mm AVANZAMENTO AL DENTE -TOOTH FEED

fn = mm AVANZAMENTO AL GIRO - FEED / REVOLUTION

Vf = mm/min VELOCITÀ DI AVANZAMENTO - FEED SPEED

$$n = \frac{Vc \cdot 1000}{\text{ØD} \cdot 3,14} = \text{giri/min (min}^{-1}\text{)}$$

$$fn = fz \cdot z = \text{mm}$$

$$Vf = fz \cdot z \cdot n = \text{mm/min}$$

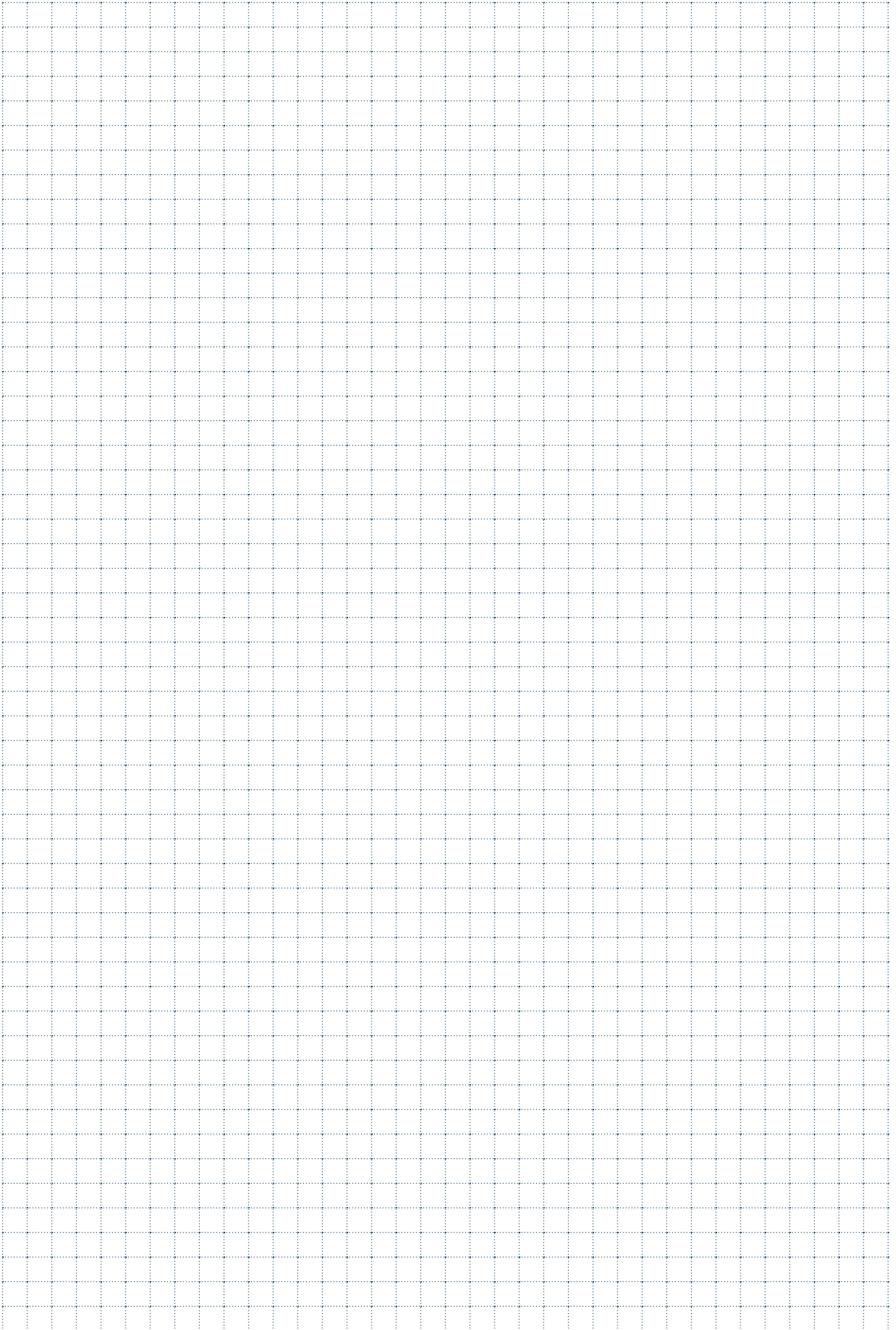



ELICA CON ANGOLO VARIABILE

HELIX WITH VARIABLE ANGLE / SPIRALE MIT VARIABLEM WINKEL /
HÉLICE À ANGLE VARIABLE / HÉLICE CON ÂNGULO VARIABLE

SMW3400

$\varnothing D = 3 - 20$

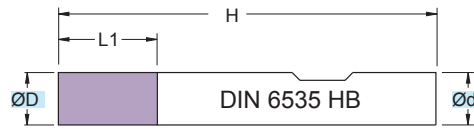
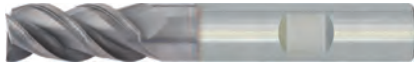

RIVESTIM.
COATED
GRAY

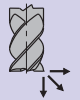

45°

**52
HRC**



HSC

Fresa in M.D.I. Micrograno
 Gambo cilindrico HB

Micrograin HM mills
 Cylindrical Shank HB

TOLLERANZE	D	d
TOLLERANCE RANGE	h10	h6

ART.	(mm)					
	$\varnothing D$	$\varnothing d$	L1	H	45°	z
SMW3400.030.N00	3	6	8	57	0,05	3
SMW3400.040.N00	4	6	11	57	0,10	3
SMW3400.050.N00	5	6	13	57	0,10	3
SMW3400.060.N00	6	6	13	57	0,10	3
SMW3400.070.N00	7	8	16	63	0,15	3
SMW3400.080.N00	8	8	19	63	0,15	3
SMW3400.090.N00	9	10	19	72	0,15	3
SMW3400.100.N00	10	10	22	72	0,15	3
SMW3400.120.N00	12	12	26	83	0,20	3
SMW3400.160.N00	16	16	32	92	0,20	3
SMW3400.200.N00	20	20	38	104	0,30	3

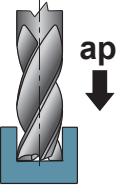
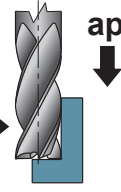
Applicazione - Application	MATERIALI - MATERIALS										ØD	Vc (m/min)	fz (mm)	ap (mm)	ae (mm)						
	P	M	K			N			S	H						G					
	ACCIAIO NON LEGATO NOT ALLOY STEEL	ACCIAIO POCO LEGATO LOW ALLOY STEEL	ACCIAIO ALTO LEGATO ALLOY STEEL	INOX MARTENSITICO STAINLESS STEEL MART.	INOX AUST. DUPLEX STAINLESS STEEL AUST.	GHISA GRIGIA GREY CAST IRON	GHISA SFEROIDALE SPHEROIDAL GRAPHITE	GHISA MALLEABILE MALLEABLE CAST IRON	ALLUMINIO E SUE LEGHE ALUMINIUM	RAME E SUE LEGHE COPPER	NON METALLICI PLASTICS	LEGHE RESIST. CALORE HIGH TEMP. ALLOY	TITANIO E SUE LEGHE TITANIUM	ACCIAIO TEMPRATO HARDENED STEEL	GRAFITE GRAPHITE						
			●													3	160-190	0,015-0,035	0,5xD	1xD	
			●														4	160-190	0,025-0,045	0,5xD	1xD
			●														5	160-190	0,030-0,050	0,5xD	1xD
			●														6	160-190	0,035-0,055	0,5xD	1xD
			●														7	160-190	0,040-0,060	0,5xD	1xD
			●														8	160-190	0,045-0,065	0,5xD	1xD
			●														9	160-190	0,050-0,070	0,5xD	1xD
			●														10	160-190	0,055-0,075	0,5xD	1xD
			●														12	160-190	0,065-0,085	0,5xD	1xD
			●														16	160-190	0,085-0,110	0,5xD	1xD
			●														20	160-190	0,085-0,110	0,5xD	1xD
						○											3	50-80	0,015-0,025	0,5xD	1xD
						○											4	50-80	0,020-0,030	0,5xD	1xD
						○											5	50-80	0,025-0,035	0,5xD	1xD
						○											6	50-80	0,025-0,040	0,5xD	1xD
						○											7	50-80	0,025-0,040	0,5xD	1xD
						○											8	50-80	0,025-0,045	0,5xD	1xD
						○											9	50-80	0,025-0,045	0,5xD	1xD
						○											10	50-80	0,025-0,045	0,5xD	1xD
						○											12	50-80	0,035-0,055	0,5xD	1xD
					○											16	50-80	0,055-0,075	0,5xD	1xD	
					○											20	50-80	0,055-0,075	0,5xD	1xD	
							●										3	180-210	0,110-0,035	0,5xD	1xD
						●										4	180-210	0,030-0,050	0,5xD	1xD	
						●										5	180-210	0,035-0,055	0,5xD	1xD	
						●										6	180-210	0,040-0,060	0,5xD	1xD	
						●										7	180-210	0,045-0,065	0,5xD	1xD	
						●										8	180-210	0,055-0,075	0,5xD	1xD	
						●										9	180-210	0,060-0,080	0,5xD	1xD	
						●										10	180-210	0,065-0,085	0,5xD	1xD	
						●										12	180-210	0,085-0,110	0,5xD	1xD	
						●										16	180-210	0,110-0,130	0,5xD	1xD	
						●										20	180-210	0,110-0,130	0,5xD	1xD	
														○			3	20-40	0,005-0,009	1xD	0,25xD
														○			4	20-40	0,005-0,011	1xD	0,25xD
														○			5	20-40	0,005-0,012	1xD	0,25xD
														○			6	20-40	0,005-0,013	1xD	0,25xD
														○			7	20-40	0,005-0,014	1xD	0,25xD
														○			8	20-40	0,006-0,015	1xD	0,25xD
														○			9	20-40	0,080-0,017	1xD	0,25xD
														○			10	20-40	0,010-0,020	1xD	0,25xD
														○			12	20-40	0,012-0,025	1xD	0,25xD
														○			16	20-40	0,015-0,035	1xD	0,25xD
														○			20	20-40	0,020-0,040	1xD	0,25xD

PER LAVORAZIONI A SPALLAMENTO AUMENTARE I PARAMETRI DEL 20%
FOR SHOULDER MILLING PARAMETERS SHOULD BE INCREASED BY 20%

● APPLICAZIONE CONSIGLIATA-RECOMMENDED APPLICATION
EMPFOHLENER EINSATZ - APPLICATION CONSEILLÉE

○ APPLICAZIONE POSSIBILE - POSSIBLE APPLICATION
MÖGLICHE ANWENDUNG - APPLICATION POSSIBLE

Vc = m/min VELOCITÀ DI TAGLIO - CUTTING SPEED

n = giri/min (min⁻¹) NUMERO DI GIRI - NUMBER OF REVOLUTIONS

fz = mm AVANZAMENTO AL DENTE -TOOTH FEED

fn = mm AVANZAMENTO AL GIRO - FEED / REVOLUTION

Vf = mm/min VELOCITÀ DI AVANZAMENTO - FEED SPEED

$$n = \frac{Vc \cdot 1000}{\text{ØD} \cdot 3,14} = \text{giri/min (min}^{-1}\text{)}$$

$$fn = fz \cdot z = \text{mm}$$

$$Vf = fz \cdot z \cdot n = \text{mm/min}$$

SMW3400..TI

ØD = 3 - 20

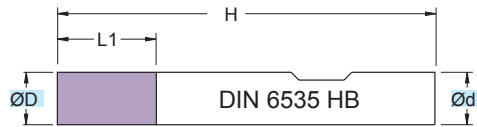

RIVESTIM. COATED ORANGE	
45°	52 HRC

Fresa in M.D.I. Micrograno
 Gambo cilindrico HB

Micrograin HM mills
 Cylindrical Shank HB

TOLLERANZE	D	d
TOLERANCE RANGE	h10	h6

ART.	(mm)					
	ØD	Ød	L1	H	45°	z
SMW3400.030.N00.TI	3	6	8	57	0,05	3
SMW3400.040.N00.TI	4	6	11	57	0,10	3
SMW3400.050.N00.TI	5	6	13	57	0,10	3
SMW3400.060.N00.TI	6	6	13	57	0,10	3
SMW3400.070.N00.TI	7	8	16	63	0,15	3
SMW3400.080.N00.TI	8	8	19	63	0,15	3
SMW3400.090.N00.TI	9	10	19	72	0,15	3
SMW3400.100.N00.TI	10	10	22	72	0,15	3
SMW3400.120.N00.TI	12	12	26	83	0,20	3
SMW3400.160.N00.TI	16	16	32	92	0,20	3
SMW3400.200.N00.TI	20	20	38	104	0,30	3

--	--	--	--	--	--	--

Applicazione - Application

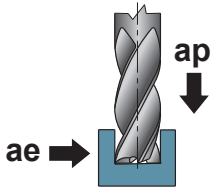

P	M	K	N	S	H	G	(mm) ØD	(m/min) Vc	(mm) fz	(mm) ap	(mm) ae			
												ACCAIO NON LEGATO NOT ALLOY STEEL	ACCAIO POCO LEGATO LOW ALLOY STEEL	ACCAIO ALTO LEGATO ALLOY STEEL
							3	100-130	0,015-0,035	0,5xD	1xD			
							4	100-130	0,025-0,045	0,5xD	1xD			
							5	100-130	0,030-0,050	0,5xD	1xD			
							6	100-130	0,035-0,055	0,5xD	1xD			
							7	100-130	0,040-0,060	0,5xD	1xD			
							8	100-130	0,045-0,065	0,5xD	1xD			
							9	100-130	0,050-0,070	0,5xD	1xD			
							10	100-130	0,055-0,075	0,5xD	1xD			
							12	100-130	0,065-0,085	0,5xD	1xD			
							16	100-130	0,085-0,110	0,5xD	1xD			
							20	100-130	0,085-0,110	0,5xD	1xD			
							3	80-110	0,015-0,025	0,5xD	1xD			
							4	80-110	0,020-0,030	0,5xD	1xD			
							5	80-110	0,025-0,035	0,5xD	1xD			
							6	80-110	0,025-0,040	0,5xD	1xD			
							7	80-110	0,025-0,040	0,5xD	1xD			
							8	80-110	0,025-0,045	0,5xD	1xD			
							9	80-110	0,025-0,045	0,5xD	1xD			
							10	80-110	0,025-0,045	0,5xD	1xD			
							12	80-110	0,035-0,055	0,5xD	1xD			
							16	80-110	0,055-0,075	0,5xD	1xD			
							20	80-110	0,055-0,075	0,5xD	1xD			
							3	30-50	0,005-0,015	0,5xD	1xD			
							4	30-50	0,005-0,015	0,5xD	1xD			
							5	30-50	0,005-0,015	0,5xD	1xD			
							6	30-50	0,008-0,025	0,5xD	1xD			
							7	30-50	0,008-0,025	0,5xD	1xD			
							8	30-50	0,010-0,030	0,5xD	1xD			
							9	30-50	0,010-0,030	0,5xD	1xD			
							10	30-50	0,015-0,035	0,5xD	1xD			
							12	30-50	0,020-0,040	0,5xD	1xD			
							16	30-50	0,030-0,050	0,5xD	1xD			
							20	30-50	0,035-0,055	0,5xD	1xD			
							3	30-75	0,005-0,015	0,5xD	1xD			
							4	30-75	0,005-0,015	0,5xD	1xD			
							5	30-75	0,005-0,020	0,5xD	1xD			
							6	30-75	0,008-0,025	0,5xD	1xD			
							7	30-75	0,008-0,025	0,5xD	1xD			
							8	30-75	0,010-0,030	0,5xD	1xD			
							9	30-75	0,010-0,030	0,5xD	1xD			
							10	30-75	0,015-0,035	0,5xD	1xD			
							12	30-75	0,020-0,040	0,5xD	1xD			
							16	30-75	0,030-0,050	0,5xD	1xD			
							20	30-75	0,035-0,055	0,5xD	1xD			
							3	20-35	0,005-0,009	1xD	0,25xD			
							4	20-35	0,005-0,011	1xD	0,25xD			
							5	20-35	0,005-0,012	1xD	0,25xD			
							6	20-35	0,005-0,013	1xD	0,25xD			
							7	20-35	0,005-0,014	1xD	0,25xD			
							8	20-35	0,006-0,015	1xD	0,25xD			
							9	20-35	0,080-0,017	1xD	0,25xD			
							10	20-35	0,010-0,020	1xD	0,25xD			
							12	20-35	0,012-0,025	1xD	0,25xD			
							16	20-35	0,015-0,035	1xD	0,25xD			
							20	20-35	0,020-0,040	1xD	0,25xD			

PER LAVORAZIONI A SPALLAMENTO AUMENTARE I PARAMETRI DEL 20%
FOR SHOULDER MILLING PARAMETERS SHOULD BE INCREASED BY 20%

- APPLICAZIONE CONSIGLIATA-RECOMMENDED APPLICATION
EMPFOLLENER EINSATZ - APPLICATION CONSEILLÉE
- APPLICAZIONE POSSIBILE - POSSIBLE APPLICATION
MÖGLICHE ANWENDUNG - APPLICATION POSSIBLE

Vc = m/min VELOCITÀ DI TAGLIO - CUTTING SPEED

n = giri/min (min⁻¹) NUMERO DI GIRI - NUMBER OF REVOLUTIONS

fz = mm AVANZAMENTO AL DENTE -TOOTH FEED

fn = mm AVANZAMENTO AL GIRO - FEED / REVOLUTION

Vf = mm/min VELOCITÀ DI AVANZAMENTO - FEED SPEED

$$n = \frac{Vc \cdot 1000}{\text{ØD} \cdot 3,14} = \text{giri/min (min}^{-1}\text{)}$$

$$fn = fz \cdot z = \text{mm}$$

$$Vf = fz \cdot z \cdot n = \text{mm/min}$$

SM3415

$\varnothing D = 3 - 20$

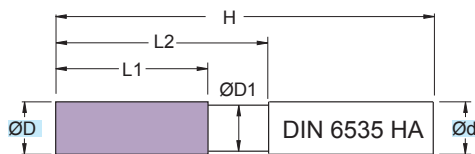

Fresa in M.D.I. Micrograno
 Gambo cilindrico HA

Micrograin HM mills
 Cylindrical Shank HA

TOLLERANZE	D	d
TOLLERANCE RANGE	h10	h6

RIVESTIM.
 COATED
GRAY



45°

**52
 HRC**



HSC

ART.	(mm)								z
	ØD	Ød	ØD1	L1	L2	H	45°		
SM3415.030.G00	3	6	2,8	8	14	57	0,05		3
SM3415.040.G00	4	6	3,8	11	18	57	0,10		3
SM3415.050.G00	5	6	4,8	13	20	57	0,10		3
SM3415.060.G00	6	6	5,8	13	20	57	0,10		3
SM3415.070.G00	7	8	6,8	16	24	63	0,15		3
SM3415.080.G00	8	8	7,7	19	28	63	0,15		3
SM3415.090.G00	9	10	8,7	19	28	72	0,15		3
SM3415.100.G00	10	10	9,5	22	33	72	0,15		3
SM3415.120.G00	12	12	11,5	26	40	83	0,20		3
SM3415.160.G00	16	16	15,5	32	45	92	0,20		3
SM3415.200.G00	20	20	19,5	38	50	104	0,30		3

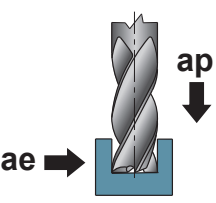
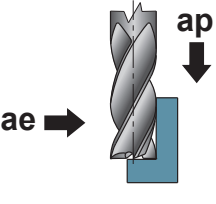
Applicazione - Application	MATERIALI - MATERIALS										ØD	Vc (m/min)	fz (mm)	ap (mm)	ae (mm)						
	P	M	K			N			S	H						G					
	ACCIAIO NON LEGATO NOT ALLOY STEEL	ACCIAIO POCO LEGATO LOW ALLOY STEEL	ACCIAIO ALTO LEGATO ALLOY STEEL	INOX MARTENSITICO STAINLESS STEEL MART.	INOX AUST. DUPLEX STAINLESS STEEL AUST.	GHISA GRIGIA GREY CAST IRON	GHISA SFEROIDALE SPHEROIDAL GRAPHITE	GHISA MALLEABILE MALLEABLE CAST IRON	ALLUMINIO E SUE LEGHE ALUMINIUM	RAME E SUE LEGHE COPPER	NON METALLICI PLASTICS	LEGHE RESIST. CALORE HIGH TEMP. ALLOY	TITANIO E SUE LEGHE TITANIUM	ACCIAIO TEMPRATO HARDENED STEEL	GRAFITE GRAPHITE						
			●													3	160-190	0,015-0,035	0,5xD	1xD	
			●														4	160-190	0,025-0,045	0,5xD	1xD
			●														5	160-190	0,030-0,050	0,5xD	1xD
			●														6	160-190	0,035-0,055	0,5xD	1xD
			●														7	160-190	0,040-0,060	0,5xD	1xD
			●														8	160-190	0,045-0,065	0,5xD	1xD
			●														9	160-190	0,050-0,070	0,5xD	1xD
			●														10	160-190	0,055-0,075	0,5xD	1xD
			●														12	160-190	0,065-0,085	0,5xD	1xD
			●														16	160-190	0,085-0,110	0,5xD	1xD
			●														20	160-190	0,085-0,110	0,5xD	1xD
						○											3	50-80	0,015-0,025	0,5xD	1xD
						○											4	50-80	0,020-0,030	0,5xD	1xD
						○											5	50-80	0,025-0,035	0,5xD	1xD
						○											6	50-80	0,025-0,040	0,5xD	1xD
						○											7	50-80	0,025-0,040	0,5xD	1xD
						○											8	50-80	0,025-0,045	0,5xD	1xD
						○											9	50-80	0,025-0,045	0,5xD	1xD
						○											10	50-80	0,025-0,045	0,5xD	1xD
						○											12	50-80	0,035-0,055	0,5xD	1xD
					○											16	50-80	0,055-0,075	0,5xD	1xD	
					○											20	50-80	0,055-0,075	0,5xD	1xD	
							●										3	180-210	0,110-0,035	0,5xD	1xD
						●										4	180-210	0,030-0,050	0,5xD	1xD	
						●										5	180-210	0,035-0,055	0,5xD	1xD	
						●										6	180-210	0,040-0,060	0,5xD	1xD	
						●										7	180-210	0,045-0,065	0,5xD	1xD	
						●										8	180-210	0,055-0,075	0,5xD	1xD	
						●										9	180-210	0,060-0,080	0,5xD	1xD	
						●										10	180-210	0,065-0,085	0,5xD	1xD	
						●										12	180-210	0,085-0,110	0,5xD	1xD	
						●										16	180-210	0,110-0,130	0,5xD	1xD	
						●										20	180-210	0,110-0,130	0,5xD	1xD	
															○	3	20-40	0,005-0,009	1xD	0,25xD	
															○	4	20-40	0,005-0,011	1xD	0,25xD	
															○	5	20-40	0,005-0,012	1xD	0,25xD	
															○	6	20-40	0,005-0,013	1xD	0,25xD	
															○	7	20-40	0,005-0,014	1xD	0,25xD	
															○	8	20-40	0,006-0,015	1xD	0,25xD	
															○	9	20-40	0,080-0,017	1xD	0,25xD	
															○	10	20-40	0,010-0,020	1xD	0,25xD	
															○	12	20-40	0,012-0,025	1xD	0,25xD	
															○	16	20-40	0,015-0,035	1xD	0,25xD	
															○	20	20-40	0,020-0,040	1xD	0,25xD	

PER LAVORAZIONI A SPALLAMENTO AUMENTARE I PARAMETRI DEL 20%
FOR SHOULDER MILLING PARAMETERS SHOULD BE INCREASED BY 20%

● APPLICAZIONE CONSIGLIATA-RECOMMENDED APPLICATION
EMPFOHLENER EINSATZ - APPLICATION CONSEILLÉE

○ APPLICAZIONE POSSIBILE - POSSIBLE APPLICATION
MÖGLICHE ANWENDUNG - APPLICATION POSSIBLE

Vc = m/min VELOCITÀ DI TAGLIO - CUTTING SPEED

n = giri/min (min⁻¹) NUMERO DI GIRI - NUMBER OF REVOLUTIONS

fz = mm AVANZAMENTO AL DENTE -TOOTH FEED

fn = mm AVANZAMENTO AL GIRO - FEED / REVOLUTION

Vf = mm/min VELOCITÀ DI AVANZAMENTO - FEED SPEED

$$n = \frac{Vc \cdot 1000}{\text{ØD} \cdot 3,14} = \text{giri/min (min}^{-1}\text{)}$$

$$fn = fz \cdot z = \text{mm}$$

$$Vf = fz \cdot z \cdot n = \text{mm/min}$$

SM3415..TI

ØD = 3 - 20

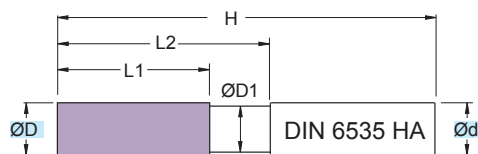

RIVESTIM. COATED ORANGE	
45°	52 HRC

Fresa in M.D.I. Micrograno
 Gambo cilindrico HA

Micrograin HM mills
 Cylindrical Shank HA

TOLLERANZE	D	d
TOLLERANCE RANGE	h10	h6

(mm)								
ART.	ØD	Ød	ØD1	L1	L2	H	45°	z
SM3415.030.G00.TI	3	6	2,8	8	14	57	0,05	3
SM3415.040.G00.TI	4	6	3,8	11	18	57	0,10	3
SM3415.050.G00.TI	5	6	4,8	13	20	57	0,10	3
SM3415.060.G00.TI	6	6	5,8	13	20	57	0,10	3
SM3415.070.G00.TI	7	8	6,8	16	24	63	0,15	3
SM3415.080.G00.TI	8	8	7,7	19	27	63	0,15	3
SM3415.090.G00.TI	9	10	8,7	19	28	72	0,15	3
SM3415.100.G00.TI	10	10	9,5	22	32	72	0,15	3
SM3415.120.G00.TI	12	12	11,5	26	38	83	0,20	3
SM3415.160.G00.TI	16	16	15,5	32	44	92	0,20	3
SM3415.200.G00.TI	20	20	19,5	38	50	104	0,30	3

Applicazione - Application	MATERIALI - MATERIALS										ØD	Vc (m/min)	fz (mm)	ap (mm)	ae (mm)							
	P	M	K			N			S	H						G						
	ACCIAIO NON LEGATO NOT ALLOY STEEL	ACCIAIO POCO LEGATO LOW ALLOY STEEL	ACCIAIO ALTO LEGATO ALLOY STEEL	INOX MARTENSITICO STAINLESS STEEL MART.	INOX AUST. DUPLEX STAINLESS STEEL AUST.	GHISA GRIGIA GREY CAST IRON	GHISA SFEROIDALE SPHEROIDAL GRAPHITE	GHISA MALLEABILE MALLEABLE CAST IRON	ALLUMINIO E SUE LEGHE ALUMINIUM	RAME E SUE LEGHE COPPER	NON METALLICI PLASTICS	LEGHE RESIST. CALORE HIGH TEMP. ALLOY	TITANIO E SUE LEGHE TITANIUM	ACCIAIO TEMPRATO HARDENED STEEL	GRAFITE GRAPHITE							
			○													3	100-130	0,015-0,035	0,5xD	1xD		
			○														4	100-130	0,025-0,045	0,5xD	1xD	
			○														5	100-130	0,030-0,050	0,5xD	1xD	
			○														6	100-130	0,035-0,055	0,5xD	1xD	
			○														7	100-130	0,040-0,060	0,5xD	1xD	
			○														8	100-130	0,045-0,065	0,5xD	1xD	
			○														9	100-130	0,050-0,070	0,5xD	1xD	
			○														10	100-130	0,055-0,075	0,5xD	1xD	
			○														12	100-130	0,065-0,085	0,5xD	1xD	
			○														16	100-130	0,085-0,110	0,5xD	1xD	
			○														20	100-130	0,085-0,110	0,5xD	1xD	
					●												3	80-110	0,015-0,025	0,5xD	1xD	
					●													4	80-110	0,020-0,030	0,5xD	1xD
					●													5	80-110	0,025-0,035	0,5xD	1xD
					●													6	80-110	0,025-0,040	0,5xD	1xD
					●													7	80-110	0,025-0,040	0,5xD	1xD
					●													8	80-110	0,025-0,045	0,5xD	1xD
					●													9	80-110	0,025-0,045	0,5xD	1xD
					●													10	80-110	0,025-0,045	0,5xD	1xD
					●													12	80-110	0,035-0,055	0,5xD	1xD
				●													16	80-110	0,055-0,075	0,5xD	1xD	
				●													20	80-110	0,055-0,075	0,5xD	1xD	
													●				3	30-50	0,005-0,015	0,5xD	1xD	
												●					4	30-50	0,005-0,015	0,5xD	1xD	
												●					5	30-50	0,005-0,015	0,5xD	1xD	
												●					6	30-50	0,008-0,025	0,5xD	1xD	
												●					7	30-50	0,008-0,025	0,5xD	1xD	
												●					8	30-50	0,010-0,030	0,5xD	1xD	
												●					9	30-50	0,010-0,030	0,5xD	1xD	
												●					10	30-50	0,015-0,035	0,5xD	1xD	
												●					12	30-50	0,020-0,040	0,5xD	1xD	
												●					16	30-50	0,030-0,050	0,5xD	1xD	
												●					20	30-50	0,035-0,055	0,5xD	1xD	
														○			3	20-35	0,005-0,009	1xD	0,25xD	
														○			4	20-35	0,005-0,011	1xD	0,25xD	
														○			5	20-35	0,005-0,012	1xD	0,25xD	
														○			6	20-35	0,005-0,013	1xD	0,25xD	
														○			7	20-35	0,005-0,014	1xD	0,25xD	
														○			8	20-35	0,006-0,015	1xD	0,25xD	
														○			9	20-35	0,080-0,017	1xD	0,25xD	
														○			10	20-35	0,010-0,020	1xD	0,25xD	
														○			12	20-35	0,012-0,025	1xD	0,25xD	
														○			16	20-35	0,015-0,035	1xD	0,25xD	
														○			20	20-35	0,020-0,040	1xD	0,25xD	

PER LAVORAZIONI A SPALLAMENTO AUMENTARE I PARAMETRI DEL 20%
FOR SHOULDER MILLING PARAMETERS SHOULD BE INCREASED BY 20%

● APPLICAZIONE CONSIGLIATA-RECOMMENDED APPLICATION
EMPFOHLENER EINSATZ - APPLICATION CONSEILLÉE

○ APPLICAZIONE POSSIBILE - POSSIBLE APPLICATION
MÖGLICHE ANWENDUNG - APPLICATION POSSIBLE

Vc = m/min VELOCITÀ DI TAGLIO - CUTTING SPEED

n = giri/min (min⁻¹) NUMERO DI GIRI - NUMBER OF REVOLUTIONS

fz = mm AVANZAMENTO AL DENTE -TOOTH FEED

fn = mm AVANZAMENTO AL GIRO - FEED / REVOLUTION

Vf = mm/min VELOCITÀ DI AVANZAMENTO - FEED SPEED

$$n = \frac{Vc \cdot 1000}{\varnothing D \cdot 3,14} = \text{giri/min (min}^{-1}\text{)}$$

$$fn = fz \cdot z = \text{mm}$$

$$Vf = fz \cdot z \cdot n = \text{mm/min}$$

SM3515

ØD = 4 - 10

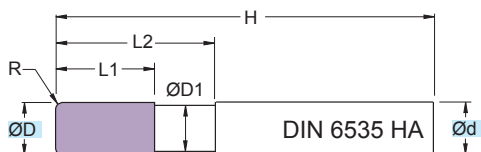

Fresa in M.D.I. Micrograno
 Gambo cilindrico HA

Micrograin HM mills
 Cylindrical Shank HA

TOLLERANZE	D	d
TOLLERANCE RANGE	h10	h6

RIVESTIM. COATED GRAY	
R	52 HRC

(mm)								
ART.	ØD	Ød	ØD1	L1	L2	H	R	z
SM3515.040.R025	4	4	3,8	11	18	57	0,25	3
SM3515.040.R050	4	4	3,8	11	18	57	0,50	3
SM3515.040.R075	4	4	3,8	11	18	57	0,75	3
SM3515.040.R100	4	4	3,8	11	18	57	1,00	3
SM3515.040.R125	4	4	3,8	11	18	57	1,25	3
SM3515.040.R150	4	4	3,8	11	18	57	1,50	3
SM3515.050.R025	5	5	4,8	13	20	57	0,25	3
SM3515.050.R050	5	5	4,8	13	20	57	0,50	3
SM3515.050.R075	5	5	4,8	13	20	57	0,75	3
SM3515.050.R100	5	5	4,8	13	20	57	1,00	3
SM3515.050.R125	5	5	4,8	13	20	57	1,25	3
SM3515.050.R150	5	5	4,8	13	20	57	1,50	3
SM3515.050.R175	5	5	4,8	13	20	57	1,75	3
SM3515.050.R200	5	5	4,8	13	20	57	2,00	3
SM3515.060.R025	6	6	5,8	13	20	57	0,25	3
SM3515.060.R050	6	6	5,8	13	20	57	0,50	3
SM3515.060.R075	6	6	5,8	13	20	57	0,75	3
SM3515.060.R100	6	6	5,8	13	20	57	1,00	3
SM3515.060.R125	6	6	5,8	13	20	57	1,25	3
SM3515.060.R150	6	6	5,8	13	20	57	1,50	3
SM3515.060.R175	6	6	5,8	13	20	57	1,75	3
SM3515.060.R200	6	6	5,8	13	20	57	2,00	3
SM3515.060.R250	6	6	5,8	13	20	57	2,50	3
SM3515.080.R025	8	8	7,7	19	27	63	0,25	3
SM3515.080.R050	8	8	7,7	19	27	63	0,50	3
SM3515.080.R075	8	8	7,7	19	27	63	0,75	3
SM3515.080.R100	8	8	7,7	19	27	63	1,00	3
SM3515.080.R125	8	8	7,7	19	27	63	1,25	3
SM3515.080.R150	8	8	7,7	19	27	63	1,50	3
SM3515.080.R175	8	8	7,7	19	27	63	1,75	3
SM3515.080.R200	8	8	7,7	19	27	63	2,00	3
SM3515.080.R250	8	8	7,7	19	27	63	2,50	3
SM3515.100.R025	10	10	9,5	22	32	72	0,25	3
SM3515.100.R050	10	10	9,5	22	32	72	0,50	3
SM3515.100.R075	10	10	9,5	22	32	72	0,75	3
SM3515.100.R100	10	10	9,5	22	32	72	1,00	3
SM3515.100.R125	10	10	9,5	22	32	72	1,25	3
SM3515.100.R150	10	10	9,5	22	32	72	1,50	3
SM3515.100.R175	10	10	9,5	22	32	72	1,75	3

(mm)								
ART.	ØD	Ød	ØD1	L1	L2	H	R	z
SM3515.100.R200	10	10	9,5	22	32	72	2,00	3
SM3515.100.R250	10	10	9,5	22	32	72	2,50	3
SM3515.100.R300	10	10	9,5	22	32	72	3,00	3

Applicazione - Application

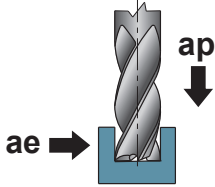

P	M	K	N	S	H	G	ØD	Vc (m/min)	fz (mm)	ap (mm)	ae (mm)			
												ACACCIAIO NON LEGATO NOT ALLOY STEEL	ACACCIAIO POCO LEGATO LOW ALLOY STEEL	ACACCIAIO ALTO LEGATO ALLOY STEEL
●							4	140-170	0,005-0,020	1xD	1xD			
●							5	140-170	0,010-0,025	1xD	1xD			
●							6	140-170	0,015-0,030	1xD	1xD			
●							8	140-170	0,025-0,040	1xD	1xD			
●							10	140-170	0,025-0,040	1xD	1xD			
●							4	100-130	0,005-0,020	1xD	1xD			
●							5	100-131	0,010-0,025	1xD	1xD			
●							6	100-132	0,015-0,030	1xD	1xD			
●							8	100-133	0,025-0,040	1xD	1xD			
●							10	100-134	0,025-0,040	1xD	1xD			
●							4	80-110	0,005-0,020	1xD	1xD			
●							5	80-110	0,010-0,025	1xD	1xD			
●							6	80-110	0,015-0,030	1xD	1xD			
●							8	80-110	0,025-0,040	1xD	1xD			
●							10	80-110	0,025-0,040	1xD	1xD			
○							4	40-70	0,005-0,020	1xD	1xD			
○							5	40-70	0,005-0,020	1xD	1xD			
○							6	40-70	0,010-0,025	1xD	1xD			
○							8	40-70	0,010-0,025	1xD	1xD			
○							10	40-70	0,010-0,025	1xD	1xD			
●							4	140-170	0,005-0,020	1xD	1xD			
●							5	140-170	0,010-0,025	1xD	1xD			
●							6	140-170	0,015-0,030	1xD	1xD			
●							8	140-170	0,025-0,040	1xD	1xD			
●							10	140-170	0,025-0,040	1xD	1xD			
●							4	140-170	0,005-0,020	1xD	1xD			
●							5	140-170	0,010-0,025	1xD	1xD			
●							6	140-170	0,015-0,030	1xD	1xD			
●							8	140-170	0,025-0,040	1xD	1xD			
●							10	140-170	0,025-0,040	1xD	1xD			
○							4	20-30	0,005-0,020	1xD	1xD			
○							5	20-30	0,005-0,020	1xD	1xD			
○							6	20-30	0,010-0,025	1xD	1xD			
○							8	20-30	0,010-0,025	1xD	1xD			
○							10	20-30	0,010-0,025	1xD	1xD			
○							4	25-40	0,005-0,020	1xD	1xD			
○							5	25-40	0,005-0,020	1xD	1xD			
○							6	25-40	0,010-0,025	1xD	1xD			
○							8	25-40	0,010-0,025	1xD	1xD			
○							10	25-40	0,010-0,025	1xD	1xD			
○							4	20-40	0,005-0,020	0,25xD	1xD			
○							5	20-40	0,005-0,020	0,25xD	1xD			
○							6	20-40	0,010-0,025	0,25xD	1xD			
○							8	20-40	0,010-0,025	0,25xD	1xD			
○							10	20-40	0,010-0,025	0,25xD	1xD			

PER LAVORAZIONI A SPALLAMENTO AUMENTARE I PARAMETRI DEL 20%
FOR SHOULDER MILLING PARAMETERS SHOULD BE INCREASED BY 20%

● APPLICAZIONE CONSIGLIATA-RECOMMENDED APPLICATION
EMPFOHLENER EINSATZ - APPLICATION CONSEILLÉE

○ APPLICAZIONE POSSIBILE - POSSIBLE APPLICATION
MÖGLICHE ANWENDUNG - APPLICATION POSSIBLE

Vc = m/min VELOCITÀ DI TAGLIO - CUTTING SPEED

n = giri/min (min⁻¹) NUMERO DI GIRI - NUMBER OF REVOLUTIONS

fz = mm AVANZAMENTO AL DENTE -TOOTH FEED

fn = mm AVANZAMENTO AL GIRO - FEED / REVOLUTION

Vf = mm/min VELOCITÀ DI AVANZAMENTO - FEED SPEED

$$n = \frac{Vc \cdot 1000}{\varnothing D \cdot 3,14} = \text{giri/min (min}^{-1}\text{)}$$

$$fn = fz \cdot z = \text{mm}$$

$$Vf = fz \cdot z \cdot n = \text{mm/min}$$

SM3515..TI

ØD = 4 - 10

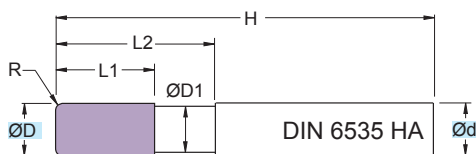

Fresa in M.D.I. Micrograno
 Gambo cilindrico HA

Micrograin HM mills
 Cylindrical Shank HA

TOLLERANZE	D	d
TOLLERANCE RANGE	h10	h6

RIVESTIM. COATED	
ORANGE	
R	52 HRC

(mm)								
ART.	ØD	Ød	ØD1	L1	L2	H	R	z
SM3515.040.R025.TI	4	4	3,8	11	18	57	0,25	3
SM3515.040.R050.TI	4	4	3,8	11	18	57	0,50	3
SM3515.040.R075.TI	4	4	3,8	11	18	57	0,75	3
SM3515.040.R100.TI	4	4	3,8	11	18	57	1,00	3
SM3515.040.R125.TI	4	4	3,8	11	18	57	1,25	3
SM3515.040.R150.TI	4	4	3,8	11	18	57	1,50	3
SM3515.050.R025.TI	5	5	4,8	13	20	57	0,25	3
SM3515.050.R050.TI	5	5	4,8	13	20	57	0,50	3
SM3515.050.R075.TI	5	5	4,8	13	20	57	0,75	3
SM3515.050.R100.TI	5	5	4,8	13	20	57	1,00	3
SM3515.050.R125.TI	5	5	4,8	13	20	57	1,25	3
SM3515.050.R150.TI	5	5	4,8	13	20	57	1,50	3
SM3515.050.R175.TI	5	5	4,8	13	20	57	1,75	3
SM3515.050.R200.TI	5	5	4,8	13	20	57	2,00	3
SM3515.060.R025.TI	6	6	5,8	13	20	57	0,25	3
SM3515.060.R050.TI	6	6	5,8	13	20	57	0,50	3
SM3515.060.R075.TI	6	6	5,8	13	20	57	0,75	3
SM3515.060.R100.TI	6	6	5,8	13	20	57	1,00	3
SM3515.060.R125.TI	6	6	5,8	13	20	57	1,25	3
SM3515.060.R150.TI	6	6	5,8	13	20	57	1,50	3
SM3515.060.R175.TI	6	6	5,8	13	20	57	1,75	3
SM3515.060.R200.TI	6	6	5,8	13	20	57	2,00	3
SM3515.060.R250.TI	6	6	5,8	13	20	57	2,50	3
SM3515.080.R025.TI	8	8	7,7	19	27	63	0,25	3
SM3515.080.R050.TI	8	8	7,7	19	27	63	0,50	3
SM3515.080.R075.TI	8	8	7,7	19	27	63	0,75	3
SM3515.080.R100.TI	8	8	7,7	19	27	63	1,00	3
SM3515.080.R125.TI	8	8	7,7	19	27	63	1,25	3
SM3515.080.R150.TI	8	8	7,7	19	27	63	1,50	3
SM3515.080.R175.TI	8	8	7,7	19	27	63	1,75	3
SM3515.080.R200.TI	8	8	7,7	19	27	63	2,00	3
SM3515.080.R250.TI	8	8	7,7	19	27	63	2,50	3
SM3515.100.R025.TI	10	10	9,5	22	32	72	0,25	3
SM3515.100.R050.TI	10	10	9,5	22	32	72	0,50	3
SM3515.100.R075.TI	10	10	9,5	22	32	72	0,75	3
SM3515.100.R100.TI	10	10	9,5	22	32	72	1,00	3
SM3515.100.R125.TI	10	10	9,5	22	32	72	1,25	3
SM3515.100.R150.TI	10	10	9,5	22	32	72	1,50	3
SM3515.100.R175.TI	10	10	9,5	22	32	72	1,75	3

(mm)								
ART.	ØD	Ød	ØD1	L1	L2	H	R	z
SM3515.100.R200.TI	10	10	9,5	22	32	72	2,00	3
SM3515.100.R250.TI	10	10	9,5	22	32	72	2,50	3
SM3515.100.R300.TI	10	10	9,5	22	32	72	3,00	3

Applicazione - Application

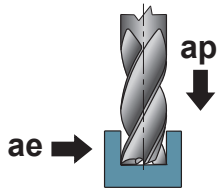

	MATERIALI - MATERIALS											(mm) ØD	(m/min) Vc	(mm) fz	(mm) ap	(mm) ae				
	P	M	K			N			S	H	G									
	ACCIAIO NON LEGATO NOT ALLOY STEEL	ACCIAIO POCO LEGATO LOW ALLOY STEEL	ACCIAIO ALTO LEGATO ALLOY STEEL	INOX MARTENSITICO STAINLESS STEEL MART.	INOX AUST. DUPLEX STAINLESS STEEL AUST.	GHISA GRIGIA GREY CAST IRON	GHISA SFEROIDALE SPHEROIDAL GRAPHITE	GHISA MALLEABILE MALLEABLE CAST IRON	ALLUMINIO E SUE LEGHE ALUMINIUM	RAME E SUE LEGHE COPPER	NON METALLICI PLASTICS	LEGHE RESIST. CALORE HIGH TEMP. ALLOY	TITANIO E SUE LEGHE TITANIUM	ACCIAIO TEMPRATO HARDENED STEEL	GRAFITE GRAPHITE					
○																4	110-140	0,030-0,045	1xD	1xD
○																5	110-140	0,035-0,050	1xD	1xD
○																6	110-140	0,040-0,055	1xD	1xD
○																8	110-140	0,050-0,065	1xD	1xD
○																10	110-140	0,060-0,075	1xD	1xD
○																4	100-135	0,030-0,045	1xD	1xD
○																5	100-135	0,035-0,050	1xD	1xD
○																6	100-135	0,040-0,055	1xD	1xD
○																8	100-135	0,050-0,065	1xD	1xD
○																10	100-135	0,060-0,075	1xD	1xD
		○														4	100-130	0,030-0,045	1xD	1xD
		○														5	100-130	0,035-0,050	1xD	1xD
		○														6	100-130	0,040-0,055	1xD	1xD
		○														8	100-130	0,050-0,065	1xD	1xD
		○														10	100-130	0,060-0,075	1xD	1xD
					●											4	80-110	0,015-0,030	1xD	1xD
					●											5	80-110	0,020-0,035	1xD	1xD
					●											6	80-110	0,025-0,040	1xD	1xD
					●											8	80-110	0,030-0,045	1xD	1xD
					●											10	80-110	0,030-0,045	1xD	1xD
												●				4	30-50	0,005-0,015	1xD	1xD
												●				5	30-50	0,005-0,015	1xD	1xD
												●				6	30-50	0,010-0,025	1xD	1xD
												●				8	30-50	0,015-0,030	1xD	1xD
												●				10	30-50	0,020-0,035	1xD	1xD
													●			4	30-75	0,005-0,015	1xD	1xD
													●			5	30-75	0,008-0,020	1xD	1xD
													●			6	30-75	0,010-0,025	1xD	1xD
													●			8	30-75	0,015-0,030	1xD	1xD
													●			10	30-75	0,020-0,035	1xD	1xD
														○		4	20-35	0,005-0,011	0,25xD	1xD
														○		5	20-35	0,005-0,012	0,25xD	1xD
														○		6	20-35	0,006-0,013	0,25xD	1xD
														○		8	20-35	0,006-0,015	0,25xD	1xD
														○		10	20-35	0,010-0,020	0,25xD	1xD

PER LAVORAZIONI A SPALLAMENTO AUMENTARE I PARAMETRI DEL 20%
FOR SHOULDER MILLING PARAMETERS SHOULD BE INCREASED BY 20%

- APPLICAZIONE CONSIGLIATA-RECOMMENDED APPLICATION
EMPFOHLENER EINSATZ - APPLICATION CONSEILLÉE
- APPLICAZIONE POSSIBILE - POSSIBLE APPLICATION
MÖGLICHE ANWENDUNG - APPLICATION POSSIBLE

Vc = m/min VELOCITÀ DI TAGLIO - CUTTING SPEED

n = giri/min (min⁻¹) NUMERO DI GIRI - NUMBER OF REVOLUTIONS

fz = mm AVANZAMENTO AL DENTE -TOOTH FEED

fn = mm AVANZAMENTO AL GIRO - FEED / REVOLUTION

Vf = mm/min VELOCITÀ DI AVANZAMENTO - FEED SPEED

$$n = \frac{Vc \cdot 1000}{\text{ØD} \cdot 3,14} = \text{giri/min (min}^{-1}\text{)}$$

$$fn = fz \cdot z = \text{mm}$$

$$Vf = fz \cdot z \cdot n = \text{mm/min}$$

SM3525

ØD = 4 - 10

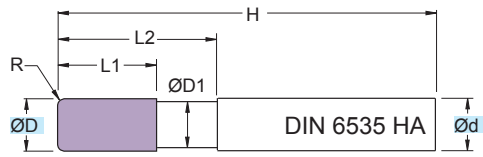

Fresa in M.D.I. Micrograno
 Gambo cilindrico HA

Micrograin HM mills
 Cylindrical Shank HA

TOLLERANZE	D	d
TOLLERANCE RANGE	h10	h6

RIVESTIM. COATED GRAY	
R	52 HRC

ART.	(mm)							
ART.	ØD	Ød	ØD1	L1	L2	H	R	z
SM3525.040.R025	4	4	3,8	19	26	72	0,25	3
SM3525.040.R050	4	4	3,8	19	26	72	0,50	3
SM3525.040.R075	4	4	3,8	19	26	72	0,75	3
SM3525.040.R100	4	4	3,8	19	26	72	1,00	3
SM3525.040.R125	4	4	3,8	19	26	72	1,25	3
SM3525.040.R150	4	4	3,8	19	26	72	1,50	3
SM3525.050.R025	5	5	4,8	22	29	72	0,25	3
SM3525.050.R050	5	5	4,8	22	29	72	0,50	3
SM3525.050.R075	5	5	4,8	22	29	72	0,75	3
SM3525.050.R100	5	5	4,8	22	29	72	1,00	3
SM3525.050.R125	5	5	4,8	22	29	72	1,25	3
SM3525.050.R150	5	5	4,8	22	29	72	1,50	3
SM3525.050.R175	5	5	4,8	22	29	72	1,75	3
SM3525.050.R200	5	5	4,8	22	29	72	2,00	3
SM3525.060.R025	6	6	5,8	22	29	72	0,25	3
SM3525.060.R050	6	6	5,8	22	29	72	0,50	3
SM3525.060.R075	6	6	5,8	22	29	72	0,75	3
SM3525.060.R100	6	6	5,8	22	29	72	1,00	3
SM3525.060.R125	6	6	5,8	22	29	72	1,25	3
SM3525.060.R150	6	6	5,8	22	29	72	1,50	3
SM3525.060.R175	6	6	5,8	22	29	72	1,75	3
SM3525.060.R200	6	6	5,8	22	29	72	2,00	3
SM3525.060.R250	6	6	5,8	22	29	72	2,50	3
SM3525.080.R025	8	8	7,7	26	35	83	0,25	3
SM3525.080.R050	8	8	7,7	26	35	83	0,50	3
SM3525.080.R075	8	8	7,7	26	35	83	0,75	3
SM3525.080.R100	8	8	7,7	26	35	83	1,00	3
SM3525.080.R125	8	8	7,7	26	35	83	1,25	3
SM3525.080.R150	8	8	7,7	26	35	83	1,50	3
SM3525.080.R175	8	8	7,7	26	35	83	1,75	3
SM3525.080.R200	8	8	7,7	26	35	83	2,00	3
SM3525.080.R250	8	8	7,7	26	35	83	2,50	3
SM3525.100.R025	10	10	9,5	32	43	100	0,25	3
SM3525.100.R050	10	10	9,5	32	43	100	0,50	3
SM3525.100.R075	10	10	9,5	32	43	100	0,75	3
SM3525.100.R100	10	10	9,5	32	43	100	1,00	3
SM3525.100.R125	10	10	9,5	32	43	100	1,25	3
SM3525.100.R150	10	10	9,5	32	43	100	1,50	3
SM3525.100.R175	10	10	9,5	32	43	100	1,75	3

ART.	(mm)							
ART.	ØD	Ød	ØD1	L1	L2	H	R	z
SM3525.100.R200	10	10	9,5	32	43	100	2,00	3
SM3525.100.R250	10	10	9,5	32	43	100	2,50	3
SM3525.100.R300	10	10	9,5	32	43	100	3,00	3

Applicazione - Application

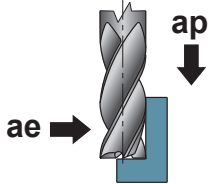

P	M	K	N	S	H	G	ØD	Vc	fz	ap	ae			
												ACCIAIO NON LEGATO NOT ALLOY STEEL	ACCIAIO POCO LEGATO LOW ALLOY STEEL	ACCIAIO ALTO LEGATO ALLOY STEEL
●							4	150-200	0,005-0,020	3xD	0,10xD			
●							5	150-200	0,010-0,025	3xD	0,10xD			
●							6	150-200	0,015-0,030	3xD	0,10xD			
●							8	150-200	0,025-0,040	3xD	0,10xD			
●							10	150-200	0,025-0,040	3xD	0,10xD			
	●						4	120-160	0,005-0,020	3xD	0,10xD			
	●						5	120-160	0,010-0,025	3xD	0,10xD			
	●						6	120-160	0,015-0,030	3xD	0,10xD			
	●						8	120-160	0,025-0,040	3xD	0,10xD			
	●						10	120-160	0,025-0,040	3xD	0,10xD			
		●					4	100-140	0,005-0,020	3xD	0,10xD			
		●					5	100-140	0,010-0,025	3xD	0,10xD			
		●					6	100-140	0,015-0,030	3xD	0,10xD			
		●					8	100-140	0,025-0,040	3xD	0,10xD			
		●					10	100-140	0,025-0,040	3xD	0,10xD			
			○				4	60-100	0,005-0,020	3xD	0,10xD			
			○				5	60-100	0,005-0,020	3xD	0,10xD			
			○				6	60-100	0,010-0,025	3xD	0,10xD			
			○				8	60-100	0,010-0,025	3xD	0,10xD			
			○				10	60-100	0,010-0,025	3xD	0,10xD			
				●			4	170-240	0,005-0,020	3xD	0,10xD			
				●			5	170-240	0,010-0,025	3xD	0,10xD			
				●			6	170-240	0,015-0,030	3xD	0,10xD			
				●			8	170-240	0,025-0,040	3xD	0,10xD			
				●			10	170-240	0,025-0,040	3xD	0,10xD			
					●		4	170-240	0,005-0,020	3xD	0,10xD			
					●		5	170-240	0,010-0,025	3xD	0,10xD			
					●		6	170-240	0,015-0,030	3xD	0,10xD			
					●		8	170-240	0,025-0,040	3xD	0,10xD			
					●		10	170-240	0,025-0,040	3xD	0,10xD			
						○	4	30-50	0,005-0,020	3xD	0,10xD			
						○	5	30-50	0,005-0,020	3xD	0,10xD			
						○	6	30-50	0,010-0,025	3xD	0,10xD			
						○	8	30-50	0,010-0,025	3xD	0,10xD			
						○	10	30-50	0,010-0,025	3xD	0,10xD			
						○	4	30-50	0,005-0,020	3xD	0,10xD			
						○	5	30-50	0,005-0,020	3xD	0,10xD			
						○	6	30-50	0,010-0,025	3xD	0,10xD			
						○	8	30-50	0,010-0,025	3xD	0,10xD			
						○	10	30-50	0,010-0,025	3xD	0,10xD			
						○	4	20-40	0,005-0,020	0,25xD	0,20xD			
						○	5	20-40	0,005-0,020	0,25xD	0,20xD			
						○	6	20-40	0,010-0,025	0,25xD	0,20xD			
						○	8	20-40	0,010-0,025	0,25xD	0,20xD			
						○	10	20-40	0,010-0,025	0,25xD	0,20xD			

PER LAVORAZIONI A SPALLAMENTO AUMENTARE I PARAMETRI DEL 20%
FOR SHOULDER MILLING PARAMETERS SHOULD BE INCREASED BY 20%

● APPLICAZIONE CONSIGLIATA-RECOMMENDED APPLICATION
EMPFOHLENER EINSATZ - APPLICATION CONSEILLÉE

○ APPLICAZIONE POSSIBILE - POSSIBLE APPLICATION
MÖGLICHE ANWENDUNG - APPLICATION POSSIBLE

Vc = m/min VELOCITÀ DI TAGLIO - CUTTING SPEED

n = giri/min (min⁻¹) NUMERO DI GIRI - NUMBER OF REVOLUTIONS

fz = mm AVANZAMENTO AL DENTE -TOOTH FEED

fn = mm AVANZAMENTO AL GIRO - FEED / REVOLUTION

Vf = mm/min VELOCITÀ DI AVANZAMENTO - FEED SPEED

$$n = \frac{Vc \cdot 1000}{\varnothing D \cdot 3,14} = \text{giri/min (min}^{-1}\text{)}$$

$$fn = fz \cdot z = \text{mm}$$

$$Vf = fz \cdot z \cdot n = \text{mm/min}$$

SM3525..TI

ØD = 4 - 10

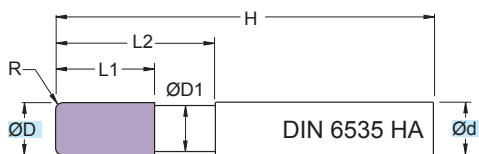

Fresa in M.D.I. Micrograno
 Gambo cilindrico HA

Micrograin HM mills
 Cylindrical Shank HA

TOLLERANZE	D	d
TOLLERANCE RANGE	h10	h6

RIVESTIM. COATED	
ORANGE	
R	52 HRC

ART.	(mm)							
ART.	ØD	Ød	ØD1	L1	L2	H	R	z
SM3525.040.R025.TI	4	4	3,8	19	26	72	0,25	3
SM3525.040.R050.TI	4	4	3,8	19	26	72	0,50	3
SM3525.040.R075.TI	4	4	3,8	19	26	72	0,75	3
SM3525.040.R100.TI	4	4	3,8	19	26	72	1,00	3
SM3525.040.R125.TI	4	4	3,8	19	26	72	1,25	3
SM3525.040.R150.TI	4	4	3,8	19	26	72	1,50	3
SM3525.050.R025.TI	5	5	4,8	22	29	72	0,25	3
SM3525.050.R050.TI	5	5	4,8	22	29	72	0,50	3
SM3525.050.R075.TI	5	5	4,8	22	29	72	0,75	3
SM3525.050.R100.TI	5	5	4,8	22	29	72	1,00	3
SM3525.050.R125.TI	5	5	4,8	22	29	72	1,25	3
SM3525.050.R150.TI	5	5	4,8	22	29	72	1,50	3
SM3525.050.R175.TI	5	5	4,8	22	29	72	1,75	3
SM3525.050.R200.TI	5	5	4,8	22	29	72	2,00	3
SM3525.060.R025.TI	6	6	5,8	22	29	72	0,25	3
SM3525.060.R050.TI	6	6	5,8	22	29	72	0,50	3
SM3525.060.R075.TI	6	6	5,8	22	29	72	0,75	3
SM3525.060.R100.TI	6	6	5,8	22	29	72	1,00	3
SM3525.060.R125.TI	6	6	5,8	22	29	72	1,25	3
SM3525.060.R150.TI	6	6	5,8	22	29	72	1,50	3
SM3525.060.R175.TI	6	6	5,8	22	29	72	1,75	3
SM3525.060.R200.TI	6	6	5,8	22	29	72	2,00	3
SM3525.060.R250.TI	6	6	5,8	22	29	72	2,50	3
SM3525.080.R025.TI	8	8	7,7	26	35	83	0,25	3
SM3525.080.R050.TI	8	8	7,7	26	35	83	0,50	3
SM3525.080.R075.TI	8	8	7,7	26	35	83	0,75	3
SM3525.080.R100.TI	8	8	7,7	26	35	83	1,00	3
SM3525.080.R125.TI	8	8	7,7	26	35	83	1,25	3
SM3525.080.R150.TI	8	8	7,7	26	35	83	1,50	3
SM3525.080.R175.TI	8	8	7,7	26	35	83	1,75	3
SM3525.080.R200.TI	8	8	7,7	26	35	83	2,00	3
SM3525.080.R250.TI	8	8	7,7	26	35	83	2,50	3
SM3525.100.R025.TI	10	10	9,5	32	43	100	0,25	3
SM3525.100.R050.TI	10	10	9,5	32	43	100	0,50	3
SM3525.100.R075.TI	10	10	9,5	32	43	100	0,75	3
SM3525.100.R100.TI	10	10	9,5	32	43	100	1,00	3
SM3525.100.R125.TI	10	10	9,5	32	43	100	1,25	3
SM3525.100.R150.TI	10	10	9,5	32	43	100	1,50	3
SM3525.100.R175.TI	10	10	9,5	32	43	100	1,75	3

ART.	(mm)							
ART.	ØD	Ød	ØD1	L1	L2	H	R	z
SM3525.100.R200.TI	10	10	9,5	32	43	100	2,00	3
SM3525.100.R250.TI	10	10	9,5	32	43	100	2,50	3
SM3525.100.R300.TI	10	10	9,5	32	43	100	3,00	3

Applicazione - Application

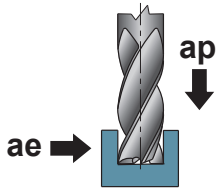

	MATERIALI - MATERIALS													(mm) ØD	(m/min) Vc	(mm) fz	(mm) ap	(mm) ae		
	P	M	K			N			S	H	G									
	ACCIAIO NON LEGATO NOT ALLOY STEEL	ACCIAIO POCO LEGATO LOW ALLOY STEEL	ACCIAIO ALTO LEGATO ALLOY STEEL	INOX MARTENSITICO STAINLESS STEEL MART.	INOX AUST. DUPLEX STAINLESS STEEL AUST.	GHISA GRIGIA GREY CAST IRON	GHISA SFEROIDALE SPHEROIDAL GRAPHITE	GHISA MALLEABILE MALLEABLE CAST IRON	ALLUMINIO E SUE LEGHE ALUMINIUM	RAME E SUE LEGHE COPPER	NON METALLICI PLASTICS	LEGHE RESIST. CALORE HIGH TEMP. ALLOY	TITANIO E SUE LEGHE TITANIUM	ACCIAIO TEMPRATO HARDENED STEEL	GRAFITE GRAPHITE					
○																4	110-140	0,030-0,045	1xD	1xD
○																5	110-140	0,035-0,050	1xD	1xD
○																6	110-140	0,040-0,055	1xD	1xD
○																8	110-140	0,050-0,065	1xD	1xD
○																10	110-140	0,060-0,075	1xD	1xD
○																4	100-135	0,030-0,045	1xD	1xD
○																5	100-135	0,035-0,050	1xD	1xD
○																6	100-135	0,040-0,055	1xD	1xD
○																8	100-135	0,050-0,065	1xD	1xD
○																10	100-135	0,060-0,075	1xD	1xD
○																4	100-130	0,030-0,045	1xD	1xD
○																5	100-130	0,035-0,050	1xD	1xD
○																6	100-130	0,040-0,055	1xD	1xD
○																8	100-130	0,050-0,065	1xD	1xD
○																10	100-130	0,060-0,075	1xD	1xD
●																4	80-110	0,015-0,030	1xD	1xD
●																5	80-110	0,020-0,035	1xD	1xD
●																6	80-110	0,025-0,040	1xD	1xD
●																8	80-110	0,030-0,045	1xD	1xD
●																10	80-110	0,030-0,045	1xD	1xD
●																4	30-50	0,005-0,015	1xD	1xD
●																5	30-50	0,005-0,015	1xD	1xD
●																6	30-50	0,010-0,025	1xD	1xD
●																8	30-50	0,015-0,030	1xD	1xD
●																10	30-50	0,020-0,035	1xD	1xD
●																4	30-75	0,005-0,015	1xD	1xD
●																5	30-75	0,008-0,020	1xD	1xD
●																6	30-75	0,010-0,025	1xD	1xD
●																8	30-75	0,015-0,030	1xD	1xD
●																10	30-75	0,020-0,035	1xD	1xD
○																4	20-35	0,005-0,011	0,25xD	1xD
○																5	20-35	0,005-0,012	0,25xD	1xD
○																6	20-35	0,006-0,013	0,25xD	1xD
○																8	20-35	0,006-0,015	0,25xD	1xD
○																10	20-35	0,010-0,020	0,25xD	1xD

PER LAVORAZIONI A SPALLAMENTO AUMENTARE I PARAMETRI DEL 20%
FOR SHOULDER MILLING PARAMETERS SHOULD BE INCREASED BY 20%

- APPLICAZIONE CONSIGLIATA-RECOMMENDED APPLICATION
EMPFOHLENER EINSATZ - APPLICATION CONSEILLÉE
- APPLICAZIONE POSSIBILE - POSSIBLE APPLICATION
MÖGLICHE ANWENDUNG - APPLICATION POSSIBLE

Vc = m/min VELOCITÀ DI TAGLIO - CUTTING SPEED

n = giri/min (min⁻¹) NUMERO DI GIRI - NUMBER OF REVOLUTIONS

fz = mm AVANZAMENTO AL DENTE -TOOTH FEED

fn = mm AVANZAMENTO AL GIRO - FEED / REVOLUTION

Vf = mm/min VELOCITÀ DI AVANZAMENTO - FEED SPEED

$$n = \frac{Vc \cdot 1000}{\text{ØD} \cdot 3,14} = \text{giri/min (min}^{-1}\text{)}$$

$$fn = fz \cdot z = \text{mm}$$

$$Vf = fz \cdot z \cdot n = \text{mm/min}$$

SMW4501

$\varnothing D = 5 - 20$

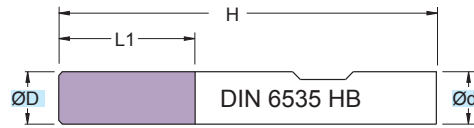

RIVESTIM. COATED BLACK	
45°	52 HRC

Fresa in M.D.I. Micrograno
 Gambo sec. DIN 6535 HB

Micrograin HM mills
 DIN 6535 HB Shank

TOLLERANZE	D	d
TOLLERANCE RANGE	h10	h6

ART.	(mm)					
	$\varnothing D$	$\varnothing d$	L1	H	45°	z
SMW4501.050.N00	5	6	21	63	0,18	4
SMW4501.060.N00	6	6	22	63	0,20	4
SMW4501.080.N00	8	8	28	80	0,20	4
SMW4501.100.N00	10	10	33	100	0,30	4
SMW4501.120.N00	12	12	42	100	0,30	4
SMW4501.140.N00	14	14	48	100	0,30	4
SMW4501.160.N00	16	16	53	150	0,40	4
SMW4501.200.N00	20	20	68	150	0,50	4

Applicazione - Application

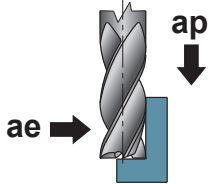

P	M	K	N	S	H	G	(mm) ØD	(m/min) Vc	(mm) fz	(mm) ap	(mm) ae			
												ACCIAIO NON LEGATO NOT ALLOY STEEL	ACCIAIO POCO LEGATO LOW ALLOY STEEL	ACCIAIO ALTO LEGATO ALLOY STEEL
●							5+6	150-200	0,015-0,030	3xD	0,10xD			
●							6+8	150-200	0,025-0,040	3xD	0,10xD			
●							8+12	150-200	0,030-0,045	3xD	0,10xD			
●							12+16	150-200	0,040-0,055	3xD	0,10xD			
●							16+20	150-200	0,055-0,070	3xD	0,10xD			
	●						5+6	120-160	0,015-0,030	3xD	0,10xD			
	●						6+8	120-160	0,025-0,040	3xD	0,10xD			
	●						8+12	120-160	0,030-0,045	3xD	0,10xD			
	●						12+16	120-160	0,040-0,055	3xD	0,10xD			
	●						16+20	120-160	0,055-0,070	3xD	0,10xD			
		●					5+6	100-140	0,015-0,030	3xD	0,10xD			
		●					6+8	100-140	0,025-0,040	3xD	0,10xD			
		●					8+12	100-140	0,030-0,045	3xD	0,10xD			
		●					12+16	100-140	0,040-0,055	3xD	0,10xD			
		●					16+20	100-140	0,055-0,070	3xD	0,10xD			
			○				5+6	60-100	0,005-0,020	3xD	0,10xD			
			○				6+8	60-100	0,010-0,025	3xD	0,10xD			
			○				8+12	60-100	0,020-0,035	3xD	0,10xD			
			○				12+16	60-100	0,025-0,040	3xD	0,10xD			
			○				16+20	60-100	0,035-0,050	3xD	0,10xD			
				●			5+6	170-240	0,025-0,035	3xD	0,10xD			
				●			6+8	170-240	0,040-0,050	3xD	0,10xD			
				●			8+12	170-240	0,045-0,060	3xD	0,10xD			
				●			12+16	170-240	0,060-0,075	3xD	0,10xD			
				●			16+20	170-240	0,080-0,095	3xD	0,10xD			
					●		5+6	170-240	0,005-0,035	3xD	0,10xD			
					●		6+8	170-240	0,008-0,050	3xD	0,10xD			
					●		8+12	170-240	0,045-0,060	3xD	0,10xD			
					●		12+16	170-240	0,060-0,075	3xD	0,10xD			
					●		16+20	170-240	0,080-0,095	3xD	0,10xD			
						○	5+6	30-50	0,005-0,020	3xD	0,10xD			
						○	6+8	30-50	0,005-0,025	3xD	0,10xD			
						○	8+12	30-50	0,006-0,030	3xD	0,10xD			
						○	12+16	30-50	0,006-0,035	3xD	0,10xD			
						○	16+20	30-50	0,010-0,045	3xD	0,10xD			
						○	5+6	30-50	0,017-0,032	3xD	0,10xD			
						○	6+8	30-50	0,021-0,036	3xD	0,10xD			
						○	8+12	30-50	0,028-0,043	3xD	0,10xD			
						○	12+16	30-50	0,035-0,050	3xD	0,10xD			
						○	16+20	30-50	0,045-0,060	3xD	0,10xD			
						○	5+6	20-40	0,005-0,013	0,25xD	0,20xD			
						○	6+8	20-40	0,005-0,015	0,25xD	0,20xD			
						○	8+12	20-40	0,005-0,017	0,25xD	0,20xD			
						○	12+16	20-40	0,005-0,020	0,25xD	0,20xD			
						○	16+20	20-40	0,005-0,020	0,25xD	0,20xD			

PER LAVORAZIONI A SPALLAMENTO AUMENTARE I PARAMETRI DEL 20%
FOR SHOULDER MILLING PARAMETERS SHOULD BE INCREASED BY 20%

● APPLICAZIONE CONSIGLIATA-RECOMMENDED APPLICATION
EMPFOHLENER EINSATZ - APPLICATION CONSEILLÉE

○ APPLICAZIONE POSSIBILE - POSSIBLE APPLICATION
MÖGLICHE ANWENDUNG - APPLICATION POSSIBLE

Vc = m/min VELOCITÀ DI TAGLIO - CUTTING SPEED

n = giri/min (min⁻¹) NUMERO DI GIRI - NUMBER OF REVOLUTIONS

fz = mm AVANZAMENTO AL DENTE -TOOTH FEED

fn = mm AVANZAMENTO AL GIRO - FEED / REVOLUTION

Vf = mm/min VELOCITÀ DI AVANZAMENTO - FEED SPEED

$$n = \frac{Vc \cdot 1000}{\varnothing D \cdot 3,14} = \text{giri/min (min}^{-1}\text{)}$$

$$fn = fz \cdot z = \text{mm}$$

$$Vf = fz \cdot z \cdot n = \text{mm/min}$$

SMW4501..TI

ØD = 5 - 20

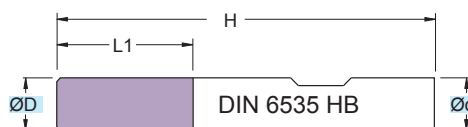

RIVESTIM.
COATED
ORANGE



45°

**52
HRC**



Fresa in M.D.I. Micrograno
 Gambo sec. DIN 6535 HB

Micrograin HM mills
 DIN 6535 HB Shank

TOLLERANZE	D	d
TOLLERANCE RANGE	h10	h6

ART.	(mm)					
	ØD	Ød	L1	H	45°	z
SMW4501.050.N00.TI	5	6	21	63	0,18	4
SMW4501.060.N00.TI	6	6	22	63	0,20	4
SMW4501.080.N00.TI	8	8	28	80	0,20	4
SMW4501.100.N00.TI	10	10	33	100	0,30	4
SMW4501.120.N00.TI	12	12	42	100	0,30	4
SMW4501.140.N00.TI	14	14	48	100	0,30	4
SMW4501.160.N00.TI	16	16	53	150	0,40	4
SMW4501.200.N00.TI	20	20	68	150	0,50	4

MATERIALI - MATERIALS Pag. 1199

Applicazione - Application

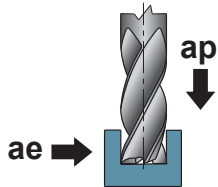

Applicazione - Application	MATERIALI - MATERIALS													(mm) ØD	(m/min) Vc	(mm) fz	(mm) ap	(mm) ae		
	P	M	K			N			S	H	G									
	ACCIAIO NON LEGATO NOT ALLOY STEEL	ACCIAIO POCO LEGATO LOW ALLOY STEEL	ACCIAIO ALTO LEGATO ALLOY STEEL	INOX MARTENSITICO STAINLESS STEEL MART.	INOX AUST. DUPLEX STAINLESS STEEL AUST.	GHISA GRIGIA GREY CAST IRON	GHISA SFEROIDALE SPHEROIDAL GRAPHITE	GHISA MALLEABILE MALLEABLE CAST IRON	ALLUMINIO E SUE LEGHE ALUMINIUM	RAME E SUE LEGHE COPPER	NON METALLICI PLASTICS	LEGHE RESIST. CALORE HIGH TEMP. ALLOY	TITANIO E SUE LEGHE TITANIUM	ACCIAIO TEMPRATO HARDENED STEEL	GRAFITE GRAPHITE					
○																5+6	110-140	0,015-0,030	1xD	1xD
○																6+8	110-140	0,025-0,040	1xD	1xD
○																8+12	110-140	0,030-0,045	1xD	1xD
○																12+16	110-140	0,040-0,055	1xD	1xD
○																16+20	110-140	0,055-0,070	1xD	1xD
○																5+6	100-135	0,015-0,030	1xD	1xD
○																6+8	100-135	0,025-0,040	1xD	1xD
○																8+12	100-135	0,030-0,045	1xD	1xD
○																12+16	100-135	0,040-0,055	1xD	1xD
○																16+20	100-135	0,055-0,070	1xD	1xD
○																5+6	100-130	0,015-0,030	1xD	1xD
○																6+8	100-130	0,025-0,040	1xD	1xD
○																8+12	100-130	0,030-0,045	1xD	1xD
○																12+16	100-130	0,040-0,055	1xD	1xD
○																16+20	100-130	0,055-0,070	1xD	1xD
●																5+6	80-110	0,026-0,041	1xD	1xD
●																6+8	80-110	0,030-0,045	1xD	1xD
●																8+12	80-110	0,040-0,055	1xD	1xD
●																12+16	80-110	0,060-0,075	1xD	1xD
●																16+20	80-110	0,070-0,085	1xD	1xD
●																5+6	30-50	0,010-0,020	1xD	1xD
●																6+8	30-50	0,015-0,025	1xD	1xD
●																8+12	30-50	0,020-0,035	1xD	1xD
●																12+16	30-50	0,025-0,040	1xD	1xD
●																16+20	30-50	0,030-0,045	1xD	1xD
●																5+6	30-75	0,005-0,022	1xD	1xD
●																6+8	30-75	0,008-0,028	1xD	1xD
●																8+12	30-75	0,020-0,035	1xD	1xD
●																12+16	30-75	0,027-0,042	1xD	1xD
●																16+20	30-75	0,037-0,052	1xD	1xD
○																5+6	20-35	0,005-0,013	0,25xD	1xD
○																6+8	20-35	0,005-0,015	0,25xD	1xD
○																8+12	20-35	0,006-0,017	0,25xD	1xD
○																12+16	20-35	0,006-0,020	0,25xD	1xD
○																16+20	20-35	0,010-0,020	0,25xD	1xD

PER LAVORAZIONI A SPALLAMENTO AUMENTARE I PARAMETRI DEL 20%
FOR SHOULDER MILLING PARAMETERS SHOULD BE INCREASED BY 20%

- APPLICAZIONE CONSIGLIATA-RECOMMENDED APPLICATION
EMPFOHLENER EINSATZ - APPLICATION CONSEILLÉE
- APPLICAZIONE POSSIBILE - POSSIBLE APPLICATION
MÖGLICHE ANWENDUNG - APPLICATION POSSIBLE

Vc = m/min VELOCITÀ DI TAGLIO - CUTTING SPEED

n = giri/min (min⁻¹) NUMERO DI GIRI - NUMBER OF REVOLUTIONS

fz = mm AVANZAMENTO AL DENTE -TOOTH FEED

fn = mm AVANZAMENTO AL GIRO - FEED / REVOLUTION

Vf = mm/min VELOCITÀ DI AVANZAMENTO - FEED SPEED

$$n = \frac{Vc \cdot 1000}{\text{ØD} \cdot 3,14} = \text{giri/min (min}^{-1}\text{)}$$

$$fn = fz \cdot z = \text{mm}$$

$$Vf = fz \cdot z \cdot n = \text{mm/min}$$

SMW4502

ØD = 5 - 20

NEW

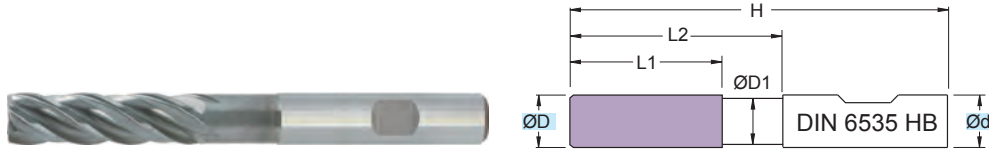

Fresa in M.D.I. Micrograno
 Gambo sec. DIN 6535 HB

Micrograin HM mills
 DIN 6535 HB Shank

TOLLERANZE	D	d
TOLLERANCE RANGE	h10	h6

RIVESTIM. COATED BLACK	
45°	52 HRC

ART.	(mm)							
	ØD	Ød	ØD1	L1	L2	H	45°	z
SMW4502.050.N00	5	6	4,8	20	25	62	0,18	4
SMW4502.060.N00	6	6	5,8	22	30	68	0,20	4
SMW4502.080.N00	8	8	7,7	28	41	79	0,20	4
SMW4502.100.N00	10	10	9,5	35	52	95	0,30	4
SMW4502.120.N00	12	12	11,5	42	62	109	0,30	4
SMW4502.140.N00	14	14	13,5	49	73	120	0,30	4
SMW4502.160.N00	16	16	15,5	56	86	136	0,40	4
SMW4502.200.N00	20	20	19,5	70	103	155	0,50	4

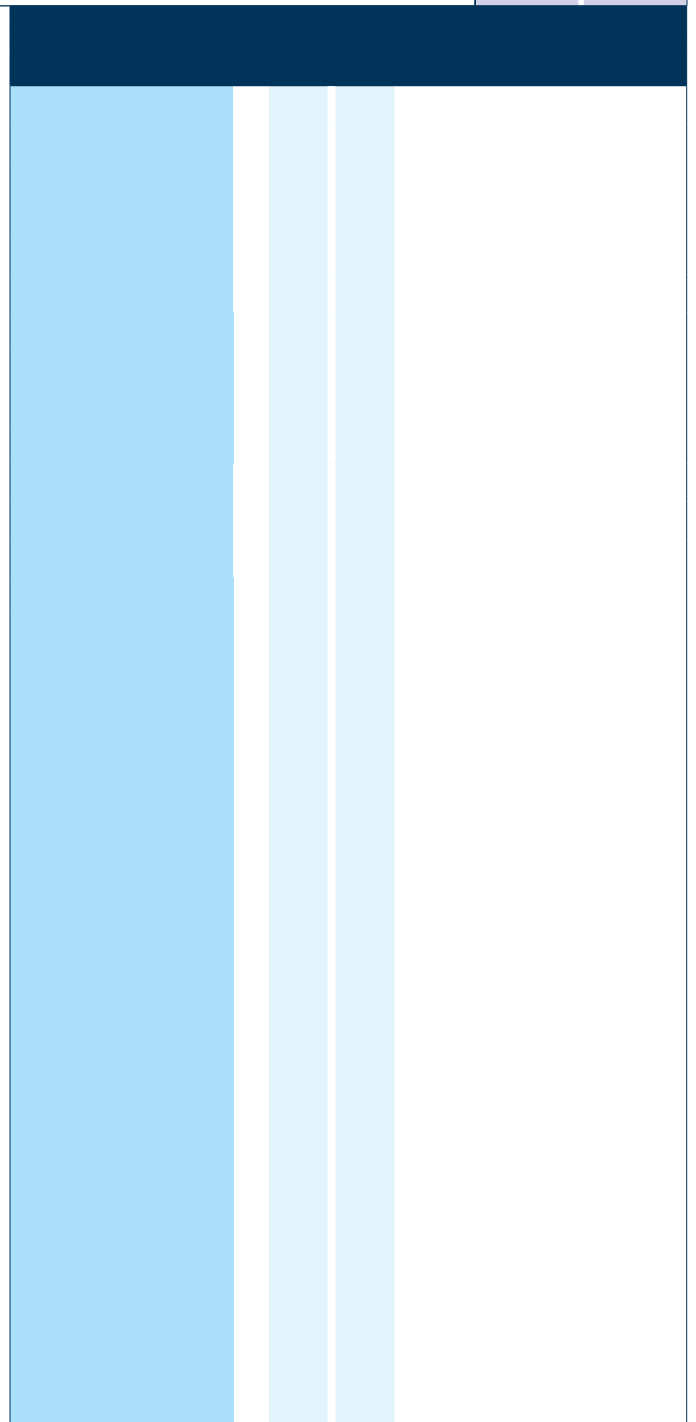

Applicazione - Application

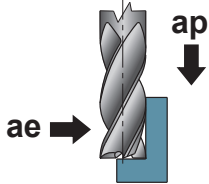

P	M	K	N	S	H	G	ØD	Vc	fz	ap	ae			
												ACCIAIO NON LEGATO NOT ALLOY STEEL	ACCIAIO POCO LEGATO LOW ALLOY STEEL	ACCIAIO ALTO LEGATO ALLOY STEEL
●							5+6	150-200	0,015-0,030	3xD	0,10xD			
●							6-8	150-200	0,025-0,040	3xD	0,10xD			
●							8+12	150-200	0,030-0,045	3xD	0,10xD			
●							12+16	150-200	0,040-0,055	3xD	0,10xD			
●							16+20	150-200	0,055-0,070	3xD	0,10xD			
	●						5+6	120-160	0,015-0,030	3xD	0,10xD			
	●						6-8	120-160	0,025-0,040	3xD	0,10xD			
	●						8+12	120-160	0,030-0,045	3xD	0,10xD			
	●						12+16	120-160	0,040-0,055	3xD	0,10xD			
	●						16+20	120-160	0,055-0,070	3xD	0,10xD			
		●					5+6	100-140	0,015-0,030	3xD	0,10xD			
		●					6-8	100-140	0,025-0,040	3xD	0,10xD			
		●					8+12	100-140	0,030-0,045	3xD	0,10xD			
		●					12+16	100-140	0,040-0,055	3xD	0,10xD			
		●					16+20	100-140	0,055-0,070	3xD	0,10xD			
			○				5+6	60-100	0,005-0,020	3xD	0,10xD			
			○				6-8	60-100	0,010-0,025	3xD	0,10xD			
			○				8+12	60-100	0,020-0,035	3xD	0,10xD			
			○				12+16	60-100	0,025-0,040	3xD	0,10xD			
			○				16+20	60-100	0,035-0,050	3xD	0,10xD			
				●			5+6	170-240	0,025-0,035	3xD	0,10xD			
				●			6-8	170-240	0,040-0,050	3xD	0,10xD			
				●			8+12	170-240	0,045-0,060	3xD	0,10xD			
				●			12+16	170-240	0,060-0,075	3xD	0,10xD			
				●			16+20	170-240	0,080-0,095	3xD	0,10xD			
					●		5+6	170-240	0,005-0,035	3xD	0,10xD			
					●		6-8	170-240	0,008-0,050	3xD	0,10xD			
					●		8+12	170-240	0,045-0,060	3xD	0,10xD			
					●		12+16	170-240	0,060-0,075	3xD	0,10xD			
					●		16+20	170-240	0,080-0,095	3xD	0,10xD			
						○	5+6	30-50	0,005-0,020	3xD	0,10xD			
						○	6-8	30-50	0,005-0,025	3xD	0,10xD			
						○	8+12	30-50	0,006-0,030	3xD	0,10xD			
						○	12+16	30-50	0,006-0,035	3xD	0,10xD			
						○	16+20	30-50	0,010-0,045	3xD	0,10xD			
						○	5+6	30-50	0,017-0,032	3xD	0,10xD			
						○	6-8	30-50	0,021-0,036	3xD	0,10xD			
						○	8+12	30-50	0,028-0,043	3xD	0,10xD			
						○	12+16	30-50	0,035-0,050	3xD	0,10xD			
						○	16+20	30-50	0,045-0,060	3xD	0,10xD			
						○	5+6	20-40	0,005-0,013	0,25xD	0,20xD			
						○	6-8	20-40	0,005-0,015	0,25xD	0,20xD			
						○	8+12	20-40	0,005-0,017	0,25xD	0,20xD			
						○	12+16	20-40	0,005-0,020	0,25xD	0,20xD			
						○	16+20	20-40	0,005-0,020	0,25xD	0,20xD			

PER LAVORAZIONI A SPALLAMENTO AUMENTARE I PARAMETRI DEL 20%
FOR SHOULDER MILLING PARAMETERS SHOULD BE INCREASED BY 20%

● APPLICAZIONE CONSIGLIATA-RECOMMENDED APPLICATION
EMPFOHLENER EINSATZ - APPLICATION CONSEILLÉE

○ APPLICAZIONE POSSIBILE - POSSIBLE APPLICATION
MÖGLICHE ANWENDUNG - APPLICATION POSSIBLE

Vc = m/min VELOCITÀ DI TAGLIO - CUTTING SPEED

n = giri/min (min⁻¹) NUMERO DI GIRI - NUMBER OF REVOLUTIONS

fz = mm AVANZAMENTO AL DENTE -TOOTH FEED

fn = mm AVANZAMENTO AL GIRO - FEED / REVOLUTION

Vf = mm/min VELOCITÀ DI AVANZAMENTO - FEED SPEED

$$n = \frac{Vc \cdot 1000}{\varnothing D \cdot 3,14} = \text{giri/min (min}^{-1}\text{)}$$

$$fn = fz \cdot z = \text{mm}$$

$$Vf = fz \cdot z \cdot n = \text{mm/min}$$

SMW4401

ØD = 3 - 25

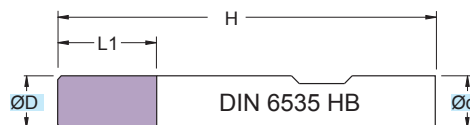

RIVESTIM.
COATED
BLACK



45°

**52
HRC**



Fresa in M.D.I. Micrograno
 Gambo sec. DIN 6535 HB

Micrograin HM mills
 DIN 6535 HB Shank

TOLLERANZE	D	d
TOLLERANCE RANGE	h10	h6

ART.	(mm)					
	ØD	Ød	L1	H	45°	z
SMW4401.030.G00	3	6	8	57	0,10	4
SMW4401.040.G00	4	6	11	57	0,13	4
SMW4401.050.G00	5	6	13	57	0,18	4
SMW4401.060.G00	6	6	13	57	0,20	4
SMW4401.070.G00	7	8	19	63	0,20	4
SMW4401.080.G00	8	8	19	63	0,20	4
SMW4401.090.G00	9	10	22	72	0,30	4
SMW4401.100.G00	10	10	22	72	0,30	4
SMW4401.110.G00	11	12	26	83	0,30	4
SMW4401.120.G00	12	12	26	83	0,30	4
SMW4401.130.G00	13	14	26	83	0,30	4
SMW4401.140.G00	14	14	26	83	0,30	4
SMW4401.160.G00	16	16	32	92	0,40	4
SMW4401.180.G00	18	18	32	92	0,40	4
SMW4401.200.G00	20	20	38	104	0,50	4
SMW4401.250.G00	25	25	38	104	0,50	4

Applicazione - Application

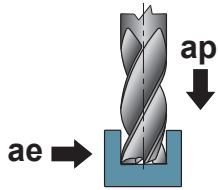

	MATERIALI - MATERIALS													(mm) ØD	(m/min) Vc	(mm) fz	(mm) ap	(mm) ae		
	P	M	K			N			S	H	G									
	ACCIAIO NON LEGATO NOT ALLOY STEEL	ACCIAIO POCO LEGATO LOW ALLOY STEEL	ACCIAIO ALTO LEGATO ALLOY STEEL	INOX MARTENSITICO STAINLESS STEEL MART.	INOX AUST. DUPLEX STAINLESS STEEL AUST.	GHISA GRIGIA GREY CAST IRON	GHISA SFEROIDALE SPHEROIDAL GRAPHITE	GHISA MALLEABILE MALLEABLE CAST IRON	ALLUMINIO E SUE LEGHE ALUMINIUM	RAME E SUE LEGHE COPPER	NON METALLICI PLASTICS	LEGHE RESIST. CALORE HIGH TEMP. ALLOY	TITANIO E SUE LEGHE TITANIUM	ACCIAIO TEMPRATO HARDENED STEEL	GRAFITE GRAPHITE					
●																3+6	140-170	0,015-0,030	1xD	1xD
●																6+9	140-170	0,025-0,040	1xD	1xD
●																9+12	140-170	0,030-0,045	1xD	1xD
●																12+16	140-170	0,040-0,055	1xD	1xD
●																16+25	140-170	0,055-0,070	1xD	1xD
●																3+6	100-130	0,015-0,030	1xD	1xD
●																6+9	100-130	0,025-0,040	1xD	1xD
●																9+12	100-130	0,030-0,045	1xD	1xD
●																12+16	100-130	0,040-0,055	1xD	1xD
●																16+25	100-130	0,055-0,070	1xD	1xD
●			●													3+6	80-110	0,015-0,030	1xD	1xD
●			●													6+9	80-110	0,025-0,040	1xD	1xD
●			●													9+12	80-110	0,030-0,045	1xD	1xD
●			●													12+16	80-110	0,040-0,055	1xD	1xD
●			●													16+25	80-110	0,055-0,070	1xD	1xD
○					○											3+6	40-70	0,005-0,020	1xD	1xD
○					○											6+9	40-70	0,010-0,025	1xD	1xD
○					○											9+12	40-70	0,020-0,035	1xD	1xD
○					○											12+16	40-70	0,025-0,040	1xD	1xD
○					○											16+25	40-70	0,035-0,050	1xD	1xD
●						●										3+6	140-170	0,025-0,035	1xD	1xD
●						●										6+9	140-170	0,040-0,050	1xD	1xD
●						●										9+12	140-170	0,045-0,060	1xD	1xD
●						●										12+16	140-170	0,060-0,075	1xD	1xD
●						●										16+25	140-170	0,080-0,095	1xD	1xD
●							●									3+6	140-170	0,005-0,035	1xD	1xD
●							●									6+9	140-170	0,008-0,050	1xD	1xD
●							●									9+12	140-170	0,045-0,060	1xD	1xD
●							●									12+16	140-170	0,060-0,075	1xD	1xD
●							●									16+25	140-170	0,080-0,095	1xD	1xD
○												○				3+6	20-30	0,005-0,020	1xD	1xD
○												○				6+9	20-30	0,005-0,025	1xD	1xD
○												○				9+12	20-30	0,006-0,030	1xD	1xD
○												○				12+16	20-30	0,006-0,035	1xD	1xD
○												○				16+25	20-30	0,010-0,045	1xD	1xD
○												○				3+6	25-40	0,017-0,032	1xD	1xD
○												○				6+9	25-40	0,021-0,036	1xD	1xD
○												○				9+12	25-40	0,028-0,043	1xD	1xD
○												○				12+16	25-40	0,035-0,050	1xD	1xD
○												○				16+25	25-40	0,045-0,060	1xD	1xD
○													○			3+6	20-40	0,005-0,013	0,25xD	1xD
○													○			6+9	20-40	0,005-0,015	0,25xD	1xD
○													○			9+12	20-40	0,005-0,017	0,25xD	1xD
○													○			12+16	20-40	0,005-0,020	0,25xD	1xD
○													○			16+25	20-40	0,005-0,020	0,25xD	1xD

PER LAVORAZIONI A SPALLAMENTO AUMENTARE I PARAMETRI DEL 20%
FOR SHOULDER MILLING PARAMETERS SHOULD BE INCREASED BY 20%

● APPLICAZIONE CONSIGLIATA-RECOMMENDED APPLICATION
EMPFOHLENER EINSATZ - APPLICATION CONSEILLÉE

○ APPLICAZIONE POSSIBILE - POSSIBLE APPLICATION
MÖGLICHE ANWENDUNG - APPLICATION POSSIBLE

Vc = m/min VELOCITÀ DI TAGLIO - CUTTING SPEED

n = giri/min (min⁻¹) NUMERO DI GIRI - NUMBER OF REVOLUTIONS

fz = mm AVANZAMENTO AL DENTE -TOOTH FEED

fn = mm AVANZAMENTO AL GIRO - FEED / REVOLUTION

Vf = mm/min VELOCITÀ DI AVANZAMENTO - FEED SPEED

$$n = \frac{Vc \cdot 1000}{\varnothing D \cdot 3,14} = \text{giri/min (min}^{-1}\text{)}$$

$$fn = fz \cdot z = \text{mm}$$

$$Vf = fz \cdot z \cdot n = \text{mm/min}$$

SMW4401..TI

ØD = 3 - 25

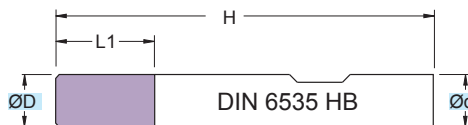

Fresa in M.D.I. Micrograno
 Gambo sec. DIN 6535 HB

Micrograin HM mills
 DIN 6535 HB Shank

TOLLERANZE	D	d
TOLLERANCE RANGE	h10	h6

RIVESTIM. COATED ORANGE	
45°	52 HRC

ART.	(mm)					
	ØD	Ød	L1	H	45°	z
SMW4401.030.G00.TI	3	6	8	57	0,10	4
SMW4401.040.G00.TI	4	6	11	57	0,13	4
SMW4401.050.G00.TI	5	6	13	57	0,18	4
SMW4401.060.G00.TI	6	6	13	57	0,20	4
SMW4401.070.G00.TI	7	8	19	63	0,20	4
SMW4401.080.G00.TI	8	8	19	63	0,20	4
SMW4401.090.G00.TI	9	10	22	72	0,30	4
SMW4401.100.G00.TI	10	10	22	72	0,30	4
SMW4401.110.G00.TI	11	12	26	83	0,30	4
SMW4401.120.G00.TI	12	12	26	83	0,30	4
SMW4401.130.G00.TI	13	14	26	83	0,30	4
SMW4401.140.G00.TI	14	14	26	83	0,30	4
SMW4401.160.G00.TI	16	16	32	92	0,40	4
SMW4401.180.G00.TI	18	18	32	92	0,40	4
SMW4401.200.G00.TI	20	20	38	104	0,50	4
SMW4401.250.G00.TI	25	25	38	104	0,50	4

Applicazione - Application

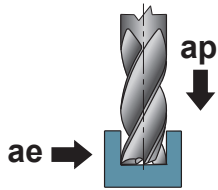

	MATERIALI - MATERIALS											(mm) ØD	(m/min) Vc	(mm) fz	(mm) ap	(mm) ae				
	P	M	K			N			S	H	G									
	ACCIAIO NON LEGATO NOT ALLOY STEEL	ACCIAIO POCO LEGATO LOW ALLOY STEEL	ACCIAIO ALTO LEGATO ALLOY STEEL	INOX MARTENSITICO STAINLESS STEEL MART.	INOX AUST. DUPLEX STAINLESS STEEL AUST.	GHISA GRIGIA GREY CAST IRON	GHISA SFEROIDALE SPHEROIDAL GRAPHITE	GHISA MALLEABILE MALLEABLE CAST IRON	ALLUMINIO E SUE LEGHE ALUMINIUM	RAME E SUE LEGHE COPPER	NON METALLICI PLASTICS	LEGHE RESIST. CALORE HIGH TEMP. ALLOY	TITANIO E SUE LEGHE TITANIUM	ACCIAIO TEMPRATO HARDENED STEEL	GRAFITE GRAPHITE					
○																3+6	110-140	0,015-0,030	1xD	1xD
○																6+9	110-140	0,025-0,040	1xD	1xD
○																9+12	110-140	0,030-0,045	1xD	1xD
○																12+16	110-140	0,040-0,055	1xD	1xD
○																16+25	110-140	0,055-0,070	1xD	1xD
○																3+6	100-135	0,015-0,030	1xD	1xD
○																6+9	100-135	0,025-0,040	1xD	1xD
○																9+12	100-135	0,030-0,045	1xD	1xD
○																12+16	100-135	0,040-0,055	1xD	1xD
○																16+25	100-135	0,055-0,070	1xD	1xD
○			○													3+6	100-130	0,015-0,030	1xD	1xD
○			○													6+9	100-130	0,025-0,040	1xD	1xD
○			○													9+12	100-130	0,030-0,045	1xD	1xD
○			○													12+16	100-130	0,040-0,055	1xD	1xD
○			○													16+25	100-130	0,055-0,070	1xD	1xD
●					●											3+6	80-110	0,026-0,041	1xD	1xD
●					●											6+9	80-110	0,030-0,045	1xD	1xD
●					●											9+12	80-110	0,040-0,055	1xD	1xD
●					●											12+16	80-110	0,060-0,075	1xD	1xD
●					●											16+25	80-110	0,070-0,085	1xD	1xD
●												●				3+6	30-50	0,010-0,020	1xD	1xD
●												●				6+9	30-50	0,015-0,025	1xD	1xD
●												●				9+12	30-50	0,020-0,035	1xD	1xD
●												●				12+16	30-50	0,025-0,040	1xD	1xD
●												●				16+25	30-50	0,030-0,045	1xD	1xD
●												●				3+6	30-75	0,005-0,020	1xD	1xD
●												●				6+9	30-75	0,008-0,028	1xD	1xD
●												●				9+12	30-75	0,017-0,032	1xD	1xD
●												●				12+16	30-75	0,030-0,045	1xD	1xD
●												●				16+25	30-75	0,040-0,055	1xD	1xD
○													○			3+6	20-35	0,005-0,013	0,25xD	1xD
○													○			6+9	20-35	0,005-0,015	0,25xD	1xD
○													○			9+12	20-35	0,005-0,017	0,25xD	1xD
○													○			12+16	20-35	0,005-0,020	0,25xD	1xD
○													○			16+25	20-35	0,005-0,020	0,25xD	1xD

PER LAVORAZIONI A SPALLAMENTO AUMENTARE I PARAMETRI DEL 20%
FOR SHOULDER MILLING PARAMETERS SHOULD BE INCREASED BY 20%

● APPLICAZIONE CONSIGLIATA-RECOMMENDED APPLICATION
EMPFOHLENER EINSATZ - APPLICATION CONSEILLÉE

○ APPLICAZIONE POSSIBILE - POSSIBLE APPLICATION
MÖGLICHE ANWENDUNG - APPLICATION POSSIBLE

Vc = m/min VELOCITÀ DI TAGLIO - CUTTING SPEED

n = giri/min (min⁻¹) NUMERO DI GIRI - NUMBER OF REVOLUTIONS

fz = mm AVANZAMENTO AL DENTE -TOOTH FEED

fn = mm AVANZAMENTO AL GIRO - FEED / REVOLUTION

Vf = mm/min VELOCITÀ DI AVANZAMENTO - FEED SPEED

$$n = \frac{Vc \cdot 1000}{\text{ØD} \cdot 3,14} = \text{giri/min (min}^{-1}\text{)}$$

$$fn = fz \cdot z = \text{mm}$$

$$Vf = fz \cdot z \cdot n = \text{mm/min}$$

SM4415

ØD = 3 - 25

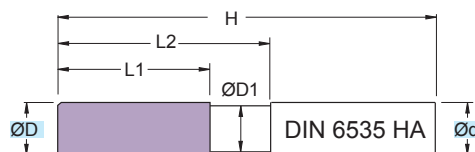

Fresa in M.D.I. Micrograno
 Gambo sec. DIN 6535 HA

Micrograin HM mills
 DIN 6535 HA Shank

TOLLERANZE	D	d
TOLERANCE RANGE	h10	h6

RIVESTIM. COATED BLACK	
45°	52 HRC

(mm)								
ART.	ØD	Ød	ØD1	L1	L2	H	45°	z
SM4415.030.G00	3	6	2,8	8	14	57	0,10	4
SM4415.040.G00	4	6	3,8	11	18	57	0,13	4
SM4415.050.G00	5	6	4,8	13	20	57	0,18	4
SM4415.060.G00	6	6	5,8	13	20	57	0,20	4
SM4415.070.G00	7	8	6,7	19	27	63	0,20	4
SM4415.080.G00	8	8	7,7	19	27	63	0,20	4
SM4415.090.G00	9	10	8,7	22	32	72	0,30	4
SM4415.100.G00	10	10	9,5	22	32	72	0,30	4
SM4415.110.G00	11	12	10,5	26	38	83	0,30	4
SM4415.120.G00	12	12	11,5	26	38	83	0,30	4
SM4415.130.G00	13	14	12,5	26	38	83	0,30	4
SM4415.140.G00	14	14	13,5	26	38	83	0,30	4
SM4415.160.G00	16	16	15,5	32	44	92	0,40	4
SM4415.180.G00	18	18	17,5	32	44	92	0,40	4
SM4415.200.G00	20	20	19,5	38	50	104	0,50	4
SM4415.250.G00	25	25	24,5	38	48	104	0,50	4

Applicazione - Application

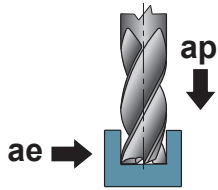

	MATERIALI - MATERIALS													(mm) ØD	(m/min) Vc	(mm) fz	(mm) ap	(mm) ae		
	P	M	K			N			S	H	G									
	ACCIAIO NON LEGATO NOT ALLOY STEEL	ACCIAIO POCO LEGATO LOW ALLOY STEEL	ACCIAIO ALTO LEGATO ALLOY STEEL	INOX MARTENSITICO STAINLESS STEEL MART.	INOX AUST. DUPLEX STAINLESS STEEL AUST.	GHISA GRIGIA GREY CAST IRON	GHISA SFEROIDALE SPHEROIDAL GRAPHITE	GHISA MALLEABILE MALLEABLE CAST IRON	ALLUMINIO E SUE LEGHE ALUMINIUM	RAME E SUE LEGHE COPPER	NON METALLICI PLASTICS	LEGHE RESIST. CALORE HIGH TEMP. ALLOY	TITANIO E SUE LEGHE TITANIUM	ACCIAIO TEMPRATO HARDENED STEEL	GRAFITE GRAPHITE					
●																3+6	140-170	0,015-0,030	1xD	1xD
●																6+9	140-170	0,025-0,040	1xD	1xD
●																9+12	140-170	0,030-0,045	1xD	1xD
●																12+16	140-170	0,040-0,055	1xD	1xD
●																16+25	140-170	0,055-0,070	1xD	1xD
●																3+6	100-130	0,015-0,030	1xD	1xD
●																6+9	100-130	0,025-0,040	1xD	1xD
●																9+12	100-130	0,030-0,045	1xD	1xD
●																12+16	100-130	0,040-0,055	1xD	1xD
●																16+25	100-130	0,055-0,070	1xD	1xD
●			●													3+6	80-110	0,015-0,030	1xD	1xD
●			●													6+9	80-110	0,025-0,040	1xD	1xD
●			●													9+12	80-110	0,030-0,045	1xD	1xD
●			●													12+16	80-110	0,040-0,055	1xD	1xD
●			●													16+25	80-110	0,055-0,070	1xD	1xD
○					○											3+6	40-70	0,005-0,020	1xD	1xD
○					○											6+9	40-70	0,010-0,025	1xD	1xD
○					○											9+12	40-70	0,020-0,035	1xD	1xD
○					○											12+16	40-70	0,025-0,040	1xD	1xD
○					○											16+25	40-70	0,035-0,050	1xD	1xD
●						●										3+6	140-170	0,025-0,035	1xD	1xD
●						●										6+9	140-170	0,040-0,050	1xD	1xD
●						●										9+12	140-170	0,045-0,060	1xD	1xD
●						●										12+16	140-170	0,060-0,075	1xD	1xD
●						●										16+25	140-170	0,080-0,095	1xD	1xD
●							●									3+6	140-170	0,005-0,035	1xD	1xD
●							●									6+9	140-170	0,008-0,050	1xD	1xD
●							●									9+12	140-170	0,045-0,060	1xD	1xD
●							●									12+16	140-170	0,060-0,075	1xD	1xD
●							●									16+25	140-170	0,080-0,095	1xD	1xD
○												○				3+6	20-30	0,005-0,020	1xD	1xD
○												○				6+9	20-30	0,005-0,025	1xD	1xD
○												○				9+12	20-30	0,006-0,030	1xD	1xD
○												○				12+16	20-30	0,006-0,035	1xD	1xD
○												○				16+25	20-30	0,010-0,045	1xD	1xD
○												○				3+6	25-40	0,017-0,032	1xD	1xD
○												○				6+9	25-40	0,021-0,036	1xD	1xD
○												○				9+12	25-40	0,028-0,043	1xD	1xD
○												○				12+16	25-40	0,035-0,050	1xD	1xD
○												○				16+25	25-40	0,045-0,060	1xD	1xD
○													○			3+6	20-40	0,005-0,013	0,25xD	1xD
○													○			6+9	20-40	0,005-0,015	0,25xD	1xD
○													○			9+12	20-40	0,005-0,017	0,25xD	1xD
○													○			12+16	20-40	0,005-0,020	0,25xD	1xD
○													○			16+25	20-40	0,005-0,020	0,25xD	1xD

PER LAVORAZIONI A SPALLAMENTO AUMENTARE I PARAMETRI DEL 20%
FOR SHOULDER MILLING PARAMETERS SHOULD BE INCREASED BY 20%

● APPLICAZIONE CONSIGLIATA-RECOMMENDED APPLICATION
EMPFOHLENER EINSATZ - APPLICATION CONSEILLÉE

○ APPLICAZIONE POSSIBILE - POSSIBLE APPLICATION
MÖGLICHE ANWENDUNG - APPLICATION POSSIBLE

Vc = m/min VELOCITÀ DI TAGLIO - CUTTING SPEED

n = giri/min (min⁻¹) NUMERO DI GIRI - NUMBER OF REVOLUTIONS

fz = mm AVANZAMENTO AL DENTE -TOOTH FEED

fn = mm AVANZAMENTO AL GIRO - FEED / REVOLUTION

Vf = mm/min VELOCITÀ DI AVANZAMENTO - FEED SPEED

$$n = \frac{Vc \cdot 1000}{\varnothing D \cdot 3,14} = \text{giri/min (min}^{-1}\text{)}$$

$$fn = fz \cdot z = \text{mm}$$

$$Vf = fz \cdot z \cdot n = \text{mm/min}$$

SM4415..TI

ØD = 3 - 25

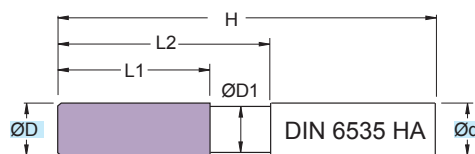

Fresa in M.D.I. Micrograno
 Gambo sec. DIN 6535 HA

Micrograin HM mills
 DIN 6535 HA Shank

TOLLERANZE	D	d
TOLLERANCE RANGE	h10	h6

RIVESTIM. COATED	
ORANGE	
45°	52 HRC

(mm)								
ART.	ØD	Ød	ØD1	L1	L2	H	45°	z
SM4415.030.G00.TI	3	6	2,8	8	14	57	0,10	4
SM4415.040.G00.TI	4	6	3,8	11	18	57	0,13	4
SM4415.050.G00.TI	5	6	4,8	13	20	57	0,18	4
SM4415.060.G00.TI	6	6	5,8	13	20	57	0,20	4
SM4415.070.G00.TI	7	8	6,7	19	27	63	0,20	4
SM4415.080.G00.TI	8	8	7,7	19	27	63	0,20	4
SM4415.090.G00.TI	9	10	8,7	22	32	72	0,30	4
SM4415.100.G00.TI	10	10	9,5	22	32	72	0,30	4
SM4415.110.G00.TI	11	12	10,5	26	38	83	0,30	4
SM4415.120.G00.TI	12	12	11,5	26	38	83	0,30	4
SM4415.130.G00.TI	13	14	12,5	26	38	83	0,30	4
SM4415.140.G00.TI	14	14	13,5	26	38	83	0,30	4
SM4415.160.G00.TI	16	16	15,5	32	44	92	0,40	4
SM4415.180.G00.TI	18	18	17,5	32	44	92	0,40	4
SM4415.200.G00.TI	20	20	19,5	38	50	104	0,50	4
SM4415.250.G00.TI	25	25	24,5	38	48	104	0,50	4

Applicazione - Application

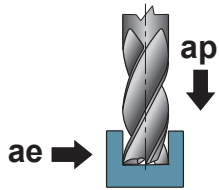

	MATERIALI - MATERIALS											(mm) ØD	(m/min) Vc	(mm) fz	(mm) ap	(mm) ae				
	P	M	K			N			S	H	G									
	ACCIAIO NON LEGATO NOT ALLOY STEEL	ACCIAIO POCO LEGATO LOW ALLOY STEEL	ACCIAIO ALTO LEGATO ALLOY STEEL	INOX MARTENSITICO STAINLESS STEEL MART.	INOX AUST. DUPLEX STAINLESS STEEL AUST.	GHISA GRIGIA GREY CAST IRON	GHISA SFEROIDALE SPHEROIDAL GRAPHITE	GHISA MALLEABILE MALLEABLE CAST IRON	ALLUMINIO E SUE LEGHE ALUMINIUM	RAME E SUE LEGHE COPPER	NON METALLICI PLASTICS	LEGHE RESIST. CALORE HIGH TEMP. ALLOY	TITANIO E SUE LEGHE TITANIUM	ACCIAIO TEMPRATO HARDENED STEEL	GRAFITE GRAPHITE					
○																3+6	110-140	0,015-0,030	1xD	1xD
○																6+9	110-140	0,025-0,040	1xD	1xD
○																9+12	110-140	0,030-0,045	1xD	1xD
○																12+16	110-140	0,040-0,055	1xD	1xD
○																16+25	110-140	0,055-0,070	1xD	1xD
○																3+6	100-135	0,015-0,030	1xD	1xD
○																6+9	100-135	0,025-0,040	1xD	1xD
○																9+12	100-135	0,030-0,045	1xD	1xD
○																12+16	100-135	0,040-0,055	1xD	1xD
○																16+25	100-135	0,055-0,070	1xD	1xD
○			○													3+6	100-130	0,015-0,030	1xD	1xD
○			○													6+9	100-130	0,025-0,040	1xD	1xD
○			○													9+12	100-130	0,030-0,045	1xD	1xD
○			○													12+16	100-130	0,040-0,055	1xD	1xD
○			○													16+25	100-130	0,055-0,070	1xD	1xD
●					●											3+6	80-110	0,026-0,041	1xD	1xD
●					●											6+9	80-110	0,030-0,045	1xD	1xD
●					●											9+12	80-110	0,040-0,055	1xD	1xD
●					●											12+16	80-110	0,060-0,075	1xD	1xD
●					●											16+25	80-110	0,070-0,085	1xD	1xD
●												●				3+6	30-50	0,010-0,020	1xD	1xD
●												●				6+9	30-50	0,015-0,025	1xD	1xD
●												●				9+12	30-50	0,020-0,035	1xD	1xD
●												●				12+16	30-50	0,025-0,040	1xD	1xD
●												●				16+25	30-50	0,030-0,045	1xD	1xD
●												●				3+6	30-75	0,005-0,020	1xD	1xD
●												●				6+9	30-75	0,008-0,028	1xD	1xD
●												●				9+12	30-75	0,017-0,032	1xD	1xD
●												●				12+16	30-75	0,030-0,045	1xD	1xD
●												●				16+25	30-75	0,040-0,055	1xD	1xD
○													○			3+6	20-35	0,005-0,013	0,25xD	1xD
○													○			6+9	20-35	0,005-0,015	0,25xD	1xD
○													○			9+12	20-35	0,005-0,017	0,25xD	1xD
○													○			12+16	20-35	0,005-0,020	0,25xD	1xD
○													○			16+25	20-35	0,005-0,020	0,25xD	1xD

PER LAVORAZIONI A SPALLAMENTO AUMENTARE I PARAMETRI DEL 20%
FOR SHOULDER MILLING PARAMETERS SHOULD BE INCREASED BY 20%

- APPLICAZIONE CONSIGLIATA-RECOMMENDED APPLICATION
EMPFOHLENER EINSATZ - APPLICATION CONSEILLÉE
- APPLICAZIONE POSSIBILE - POSSIBLE APPLICATION
MÖGLICHE ANWENDUNG - APPLICATION POSSIBLE

Vc = m/min VELOCITÀ DI TAGLIO - CUTTING SPEED
n = giri/min (min⁻¹) NUMERO DI GIRI - NUMBER OF REVOLUTIONS
fz = mm AVANZAMENTO AL DENTE -TOOTH FEED
fn = mm AVANZAMENTO AL GIRO - FEED / REVOLUTION
Vf = mm/min VELOCITÀ DI AVANZAMENTO - FEED SPEED

$$n = \frac{Vc \cdot 1000}{\text{ØD} \cdot 3,14} = \text{giri/min (min}^{-1}\text{)}$$

$$fn = fz \cdot z = \text{mm}$$

$$Vf = fz \cdot z \cdot n = \text{mm/min}$$

SMW4305

ØD = 4 - 20

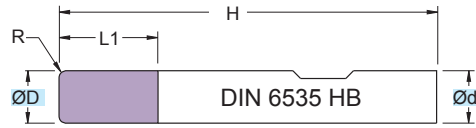

RIVESTIM.
COATED
GRAY

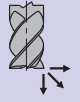

R

52 HRC



Fresa in M.D.I. Micrograno
 Gambo sec. DIN 6535 HB

Micrograin HM mills
 DIN 6535 HB Shank

TOLLERANZE	D	d
TOLERANCE RANGE	h10	h6

ART.	(mm)					
	ØD	Ød	L1	H	R	z
SMW4305.040.R025	4	6	11	57	0,25	4
SMW4305.041.R050	4	6	11	57	0,50	4
SMW4305.042.R100	4	6	11	57	1,00	4
SMW4305.050.R050	5	6	13	57	0,50	4
SMW4305.051.R100	5	6	13	57	1,00	4
SMW4305.052.R150	5	6	13	57	1,50	4
SMW4305.060.R050	6	6	13	57	0,50	4
SMW4305.061.R100	6	6	13	57	1,00	4
SMW4305.062.R150	6	6	13	57	1,50	4
SMW4305.063.R200	6	6	13	57	2,00	4
SMW4305.080.R050	8	8	19	63	0,50	4
SMW4305.081.R100	8	8	19	63	1,00	4
SMW4305.082.R150	8	8	19	63	1,50	4
SMW4305.083.R200	8	8	19	63	2,00	4
SMW4305.100.R050	10	10	22	72	0,50	4
SMW4305.101.R100	10	10	22	72	1,00	4
SMW4305.102.R150	10	10	22	72	1,50	4
SMW4305.103.R200	10	10	22	72	2,00	4
SMW4305.120.R050	12	12	26	83	0,50	4
SMW4305.121.R100	12	12	26	83	1,00	4
SMW4305.122.R150	12	12	26	83	1,50	4
SMW4305.123.R200	12	12	26	83	2,00	4
SMW4305.140.R100	14	14	26	83	1,00	4
SMW4305.141.R200	14	14	26	83	2,00	4
SMW4305.160.R100	16	16	32	92	1,00	4
SMW4305.161.R150	16	16	32	92	1,50	4

ART.	(mm)					
	ØD	Ød	L1	H	R	z
SMW4305.162.R200	16	16	32	92	2,00	4
SMW4305.163.R250	16	16	32	92	2,50	4
SMW4305.180.R150	18	18	32	92	1,50	4
SMW4305.181.R250	18	18	32	92	2,50	4
SMW4305.200.R100	20	20	38	104	1,00	4
SMW4305.201.R150	20	20	38	104	1,50	4
SMW4305.202.R200	20	20	38	104	2,00	4
SMW4305.203.R250	20	20	38	104	2,50	4
SMW4305.204.R300	20	20	38	104	3,00	4
SMW4305.205.R400	20	20	38	104	4,00	4
SMW4305.206.R500	20	20	38	104	5,00	4

Applicazione - Application

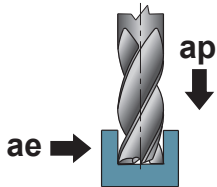

	MATERIALI - MATERIALS													(mm) ØD	(m/min) Vc	(mm) fz	(mm) ap	(mm) ae		
	P	M	K			N			S	H	G									
	ACCIAIO NON LEGATO NOT ALLOY STEEL	ACCIAIO POCO LEGATO LOW ALLOY STEEL	ACCIAIO ALTO LEGATO ALLOY STEEL	INOX MARTENSITICO STAINLESS STEEL MART.	INOX AUST. DUPLEX STAINLESS STEEL AUST.	GHISA GRIGIA GREY CAST IRON	GHISA SFEROIDALE SPHEROIDAL GRAPHITE	GHISA MALLEABILE MALLEABLE CAST IRON	ALLUMINIO E SUE LEGHE ALUMINIUM	RAME E SUE LEGHE COPPER	NON METALLICI PLASTICS	LEGHE RESIST. CALORE HIGH TEMP. ALLOY	TITANIO E SUE LEGHE TITANIUM	ACCIAIO TEMPRATO HARDENED STEEL	GRAFITE GRAPHITE					
●																4+6	140-170	0,015-0,030	1xD	1xD
●																6+10	140-170	0,025-0,040	1xD	1xD
●																10+14	140-170	0,030-0,045	1xD	1xD
●																14+18	140-170	0,040-0,055	1xD	1xD
●																18+20	140-170	0,055-0,070	1xD	1xD
○																4+6	100-130	0,015-0,030	1xD	1xD
○																6+10	100-130	0,025-0,040	1xD	1xD
○																10+14	100-130	0,030-0,045	1xD	1xD
○																14+18	100-130	0,040-0,055	1xD	1xD
○																18+20	100-130	0,055-0,070	1xD	1xD
○			●													4+6	80-110	0,015-0,030	1xD	1xD
○			●													6+10	80-110	0,025-0,040	1xD	1xD
○			●													10+14	80-110	0,030-0,045	1xD	1xD
○			●													14+18	80-110	0,040-0,055	1xD	1xD
○			●													18+20	80-110	0,055-0,070	1xD	1xD
○				○												4+6	40-70	0,005-0,020	1xD	1xD
○				○												6+10	40-70	0,010-0,025	1xD	1xD
○				○												10+14	40-70	0,020-0,035	1xD	1xD
○				○												14+18	40-70	0,025-0,040	1xD	1xD
○				○												18+20	40-70	0,035-0,050	1xD	1xD
○					●											4+6	140-170	0,025-0,035	1xD	1xD
○					●											6+10	140-170	0,040-0,050	1xD	1xD
○					●											10+14	140-170	0,045-0,060	1xD	1xD
○					●											14+18	140-170	0,060-0,075	1xD	1xD
○					●											18+20	140-170	0,080-0,095	1xD	1xD
○						●										4+6	140-170	0,005-0,035	1xD	1xD
○						●										6+10	140-170	0,008-0,050	1xD	1xD
○						●										10+14	140-170	0,045-0,060	1xD	1xD
○						●										14+18	140-170	0,060-0,075	1xD	1xD
○						●										18+20	140-170	0,080-0,095	1xD	1xD
○												○				4+6	20-30	0,005-0,020	1xD	1xD
○												○				6+10	20-30	0,005-0,025	1xD	1xD
○												○				10+14	20-30	0,006-0,030	1xD	1xD
○												○				14+18	20-30	0,006-0,035	1xD	1xD
○												○				18+20	20-30	0,010-0,045	1xD	1xD
○												○				4+6	25-40	0,017-0,032	1xD	1xD
○												○				6+10	25-40	0,021-0,036	1xD	1xD
○												○				10+14	25-40	0,028-0,043	1xD	1xD
○												○				14+18	25-40	0,035-0,050	1xD	1xD
○												○				18+20	25-40	0,045-0,060	1xD	1xD
○													○			4+6	20-40	0,005-0,013	0,25xD	1xD
○													○			6+10	20-40	0,005-0,015	0,25xD	1xD
○													○			10+14	20-40	0,005-0,017	0,25xD	1xD
○													○			14+18	20-40	0,005-0,020	0,25xD	1xD
○													○			18+20	20-40	0,005-0,020	0,25xD	1xD

PER LAVORAZIONI A SPALLAMENTO AUMENTARE I PARAMETRI DEL 20%
FOR SHOULDER MILLING PARAMETERS SHOULD BE INCREASED BY 20%

● APPLICAZIONE CONSIGLIATA-RECOMMENDED APPLICATION
EMPFOHLENER EINSATZ - APPLICATION CONSEILLÉE

○ APPLICAZIONE POSSIBILE - POSSIBLE APPLICATION
MÖGLICHE ANWENDUNG - APPLICATION POSSIBLE

Vc = m/min VELOCITÀ DI TAGLIO - CUTTING SPEED

n = giri/min (min⁻¹) NUMERO DI GIRI - NUMBER OF REVOLUTIONS

fz = mm AVANZAMENTO AL DENTE -TOOTH FEED

fn = mm AVANZAMENTO AL GIRO - FEED / REVOLUTION

Vf = mm/min VELOCITÀ DI AVANZAMENTO - FEED SPEED

$$n = \frac{Vc \cdot 1000}{\varnothing D \cdot 3,14} = \text{giri/min (min}^{-1}\text{)}$$

$$fn = fz \cdot z = \text{mm}$$

$$Vf = fz \cdot z \cdot n = \text{mm/min}$$

SMW4305..TI

ØD = 4 - 20

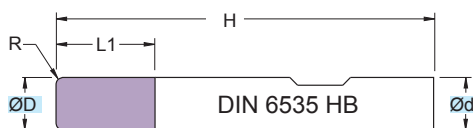

Fresa in M.D.I. Micrograno
 Gambo sec. DIN 6535 HB

Micrograin HM mills
 DIN 6535 HB Shank

TOLLERANZE	D	d
TOLERANCE RANGE	h10	h6

RIVESTIM. COATED ORANGE	
R	52 HRC

ART.	(mm)					
	ØD	Ød	L1	H	R	z
SMW4305.040.R025.TI	4	6	11	57	0,25	4
SMW4305.041.R050.TI	4	6	11	57	0,50	4
SMW4305.042.R100.TI	4	6	11	57	1,00	4
SMW4305.050.R050.TI	5	6	13	57	0,50	4
SMW4305.051.R100.TI	5	6	13	57	1,00	4
SMW4305.052.R150.TI	5	6	13	57	1,50	4
SMW4305.060.R050.TI	6	6	13	57	0,50	4
SMW4305.061.R100.TI	6	6	13	57	1,00	4
SMW4305.062.R150.TI	6	6	13	57	1,50	4
SMW4305.063.R200.TI	6	6	13	57	2,00	4
SMW4305.080.R050.TI	8	8	19	63	0,50	4
SMW4305.081.R100.TI	8	8	19	63	1,00	4
SMW4305.082.R150.TI	8	8	19	63	1,50	4
SMW4305.083.R200.TI	8	8	19	63	2,00	4
SMW4305.100.R050.TI	10	10	22	72	0,50	4
SMW4305.101.R100.TI	10	10	22	72	1,00	4
SMW4305.102.R150.TI	10	10	22	72	1,50	4
SMW4305.103.R200.TI	10	10	22	72	2,00	4
SMW4305.120.R050.TI	12	12	26	83	0,50	4
SMW4305.121.R100.TI	12	12	26	83	1,00	4
SMW4305.122.R150.TI	12	12	26	83	1,50	4
SMW4305.123.R200.TI	12	12	26	83	2,00	4
SMW4305.140.R100.TI	14	14	26	83	1,00	4
SMW4305.141.R200.TI	14	14	26	83	2,00	4
SMW4305.160.R100.TI	16	16	32	92	1,00	4
SMW4305.161.R150.TI	16	16	32	92	1,50	4

ART.	(mm)					
	ØD	Ød	L1	H	R	z
SMW4305.162.R200.TI	16	16	32	92	2,00	4
SMW4305.163.R250.TI	16	16	32	92	2,50	4
SMW4305.180.R150.TI	18	18	32	92	1,50	4
SMW4305.181.R250.TI	18	18	32	92	2,50	4
SMW4305.200.R100.TI	20	20	38	104	1,00	4
SMW4305.201.R150.TI	20	20	38	104	1,50	4
SMW4305.202.R200.TI	20	20	38	104	2,00	4
SMW4305.203.R250.TI	20	20	38	104	2,50	4
SMW4305.204.R300.TI	20	20	38	104	3,00	4
SMW4305.205.R400.TI	20	20	38	104	4,00	4
SMW4305.206.R500.TI	20	20	38	104	5,00	4

Applicazione - Application

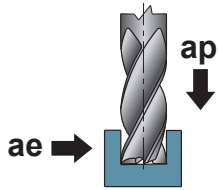

	MATERIALI - MATERIALS													(mm) ØD	(m/min) Vc	(mm) fz	(mm) ap	(mm) ae		
	P	M	K			N			S	H	G									
	ACCIAIO NON LEGATO NOT ALLOY STEEL	ACCIAIO POCO LEGATO LOW ALLOY STEEL	ACCIAIO ALTO LEGATO ALLOY STEEL	INOX MARTENSITICO STAINLESS STEEL MART.	INOX AUST. DUPLEX STAINLESS STEEL AUST.	GHISA GRIGIA GREY CAST IRON	GHISA SFEROIDALE SPHEROIDAL GRAPHITE	GHISA MALLEABILE MALLEABLE CAST IRON	ALLUMINIO E SUE LEGHE ALUMINIUM	RAME E SUE LEGHE COPPER	NON METALLICI PLASTICS	LEGHE RESIST. CALORE HIGH TEMP. ALLOY	TITANIO E SUE LEGHE TITANIUM	ACCIAIO TEMPRATO HARDENED STEEL	GRAFITE GRAPHITE					
○																4+6	110-140	0,015-0,030	1xD	1xD
○																6+10	110-140	0,025-0,040	1xD	1xD
○																10+14	110-140	0,030-0,045	1xD	1xD
○																14+18	110-140	0,040-0,055	1xD	1xD
○																18+20	110-140	0,055-0,070	1xD	1xD
○																4+6	100-135	0,015-0,030	1xD	1xD
○																6+10	100-135	0,025-0,040	1xD	1xD
○																10+14	100-135	0,030-0,045	1xD	1xD
○																14+18	100-135	0,040-0,055	1xD	1xD
○																18+20	100-135	0,055-0,070	1xD	1xD
○		○														4+6	100-130	0,015-0,030	1xD	1xD
○		○														6+10	100-130	0,025-0,040	1xD	1xD
○		○														10+14	100-130	0,030-0,045	1xD	1xD
○		○														14+18	100-130	0,040-0,055	1xD	1xD
○		○														18+20	100-130	0,055-0,070	1xD	1xD
●					●											4+6	80-110	0,026-0,041	1xD	1xD
●					●											6+10	80-110	0,030-0,045	1xD	1xD
●					●											10+14	80-110	0,040-0,055	1xD	1xD
●					●											14+18	80-110	0,060-0,075	1xD	1xD
●					●											18+20	80-110	0,070-0,085	1xD	1xD
●												●				4+6	30-50	0,010-0,020	1xD	1xD
●												●				6+10	30-50	0,015-0,025	1xD	1xD
●												●				10+14	30-50	0,020-0,035	1xD	1xD
●												●				14+18	30-50	0,025-0,040	1xD	1xD
●												●				18+20	30-50	0,030-0,045	1xD	1xD
○													○			4+6	30-75	0,005-0,020	1xD	1xD
○													○			6+10	30-75	0,008-0,030	1xD	1xD
○													○			10+14	30-75	0,023-0,038	1xD	1xD
○													○			14+18	30-75	0,033-0,048	1xD	1xD
○													○			18+20	30-75	0,037-0,052	1xD	1xD
○														○		4+6	20-35	0,005-0,013	0,25xD	1xD
○														○		6+10	20-35	0,005-0,015	0,25xD	1xD
○														○		10+14	20-35	0,005-0,017	0,25xD	1xD
○														○		14+18	20-35	0,005-0,020	0,25xD	1xD
○														○		18+20	20-35	0,005-0,020	0,25xD	1xD

PER LAVORAZIONI A SPALLAMENTO AUMENTARE I PARAMETRI DEL 20%
FOR SHOULDER MILLING PARAMETERS SHOULD BE INCREASED BY 20%

- APPLICAZIONE CONSIGLIATA-RECOMMENDED APPLICATION
EMPFOHLENER EINSATZ - APPLICATION CONSEILLÉE
- APPLICAZIONE POSSIBILE - POSSIBLE APPLICATION
MÖGLICHE ANWENDUNG - APPLICATION POSSIBLE

Vc = m/min VELOCITÀ DI TAGLIO - CUTTING SPEED

n = giri/min (min⁻¹) NUMERO DI GIRI - NUMBER OF REVOLUTIONS

fz = mm AVANZAMENTO AL DENTE -TOOTH FEED

fn = mm AVANZAMENTO AL GIRO - FEED / REVOLUTION

Vf = mm/min VELOCITÀ DI AVANZAMENTO - FEED SPEED

$$n = \frac{Vc \cdot 1000}{\text{ØD} \cdot 3,14} = \text{giri/min (min}^{-1}\text{)}$$

$$fn = fz \cdot z = \text{mm}$$

$$Vf = fz \cdot z \cdot n = \text{mm/min}$$

SM4314

ØD = 6 - 16

NEW

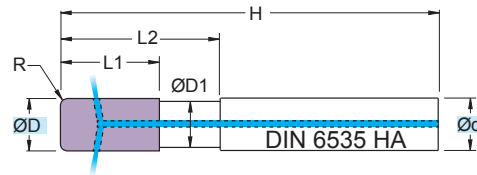

Fresa in M.D.I. Micrograno
 Gambo sec. DIN 6535 HB

Micrograin HM mills
 DIN 6535 HB Shank

TOLLERANZE	D	d
TOLLERANCE RANGE	h10	h6

RIVESTIM. COATED	
ORANGE	
R	52 HRC

(mm)								
ART.	ØD	Ød	ØD1	L1	L2	H	R	z
SM4314.060.R050.C	6	6	5,7	13	20	57	0,50	4
SM4314.060.R100.C	6	6	5,7	13	20	57	1,00	4
SM4314.080.R050.C	8	8	7,7	18	26	63	0,50	4
SM4314.080.R100.C	8	8	7,7	18	26	63	1,00	4
SM4314.080.R200.C	8	8	7,7	18	26	63	2,00	4
SM4314.100.R050.C	10	10	9,7	22	31	72	0,50	4
SM4314.100.R100.C	10	10	9,7	22	31	72	1,00	4
SM4314.120.R050.C	12	12	11,6	26	37	83	0,50	4
SM4314.120.R100.C	12	12	11,6	26	37	83	1,00	4
SM4314.120.R150.C	12	12	11,6	26	37	83	1,50	4
SM4314.120.R200.C	12	12	11,6	26	37	83	2,00	4
SM4314.160.R100.C	16	16	15,6	32	43	92	1,00	4
SM4314.160.R200.C	16	16	15,6	32	43	92	2,00	4

Applicazione - Application

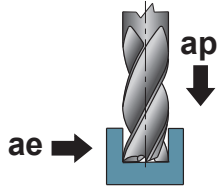

	MATERIALI - MATERIALS													(mm) ØD	(m/min) Vc	(mm) fz	(mm) ap	(mm) ae		
	P	M	K			N			S		H	G								
	ACCIAIO NON LEGATO NOT ALLOY STEEL	ACCIAIO POCO LEGATO LOW ALLOY STEEL	ACCIAIO ALTO LEGATO ALLOY STEEL	INOX MARTENSITICO STAINLESS STEEL MART.	INOX AUST. DUPLEX STAINLESS STEEL AUST.	GHISA GRIGIA GREY CAST IRON	GHISA SFEROIDALE SPHEROIDAL GRAPHITE	GHISA MALLEABILE MALLEABLE CAST IRON	ALLUMINIO E SUE LEGHE ALUMINIUM	RAME E SUE LEGHE COPPER	NON METALLICI PLASTICS	LEGHE RESIST. CALORE HIGH TEMP. ALLOY	TITANIO E SUE LEGHE TITANIUM	ACCIAIO TEMPRATO HARDENED STEEL	GRAFITE GRAPHITE					
●																6+8	120-150	0,025-0,040	1xD	1xD
●																8+10	120-150	0,030-0,045	1xD	1xD
●																10+12	120-150	0,040-0,055	1xD	1xD
●																12+16	120-150	0,055-0,070	1xD	1xD
	●															6+8	110-140	0,025-0,040	1xD	1xD
	●															8+10	110-140	0,030-0,045	1xD	1xD
	●															10+12	110-140	0,040-0,055	1xD	1xD
	●															12+16	110-140	0,055-0,070	1xD	1xD
		●														6+8	100-130	0,025-0,040	1xD	1xD
		●														8+10	100-130	0,030-0,045	1xD	1xD
		●														10+12	100-130	0,040-0,055	1xD	1xD
		●														12+16	100-130	0,055-0,070	1xD	1xD
			●													6+8	80-130	0,030-0,045	1xD	1xD
			●													8+10	80-130	0,040-0,055	1xD	1xD
			●													10+12	80-130	0,060-0,075	1xD	1xD
			●													12+16	80-130	0,070-0,085	1xD	1xD
				●								●				6+8	30-50	0,015-0,025	1xD	1xD
					●							●				8+10	30-50	0,020-0,035	1xD	1xD
						●						●				10+12	30-50	0,025-0,040	1xD	1xD
							●					●				12+16	30-50	0,030-0,045	1xD	1xD
													●			6+8	30-80	0,008-0,030	1xD	1xD
													●			8+10	30-80	0,023-0,038	1xD	1xD
													●			10+12	30-80	0,033-0,048	1xD	1xD
													●			12+16	30-80	0,037-0,052	1xD	1xD
														○		6+8	20-40	0,005-0,015	0,25xD	1xD
														○		8+10	20-40	0,005-0,017	0,25xD	1xD
														○		10+12	20-40	0,005-0,020	0,25xD	1xD
														○		12+16	20-40	0,005-0,020	0,25xD	1xD

PER LAVORAZIONI A SPALLAMENTO AUMENTARE I PARAMETRI DEL 20%
FOR SHOULDER MILLING PARAMETERS SHOULD BE INCREASED BY 20%

● APPLICAZIONE CONSIGLIATA-RECOMMENDED APPLICATION
EMPFOHLENER EINSATZ - APPLICATION CONSEILLÉE

○ APPLICAZIONE POSSIBILE - POSSIBLE APPLICATION
MÖGLICHE ANWENDUNG - APPLICATION POSSIBLE

Vc = m/min VELOCITÀ DI TAGLIO - CUTTING SPEED

n = giri/min (min⁻¹) NUMERO DI GIRI - NUMBER OF REVOLUTIONS

fz = mm AVANZAMENTO AL DENTE -TOOTH FEED

fn = mm AVANZAMENTO AL GIRO - FEED / REVOLUTION

Vf = mm/min VELOCITÀ DI AVANZAMENTO - FEED SPEED

$$n = \frac{Vc \cdot 1000}{\text{ØD} \cdot 3,14} = \text{giri/min (min}^{-1}\text{)}$$

$$fn = fz \cdot z = \text{mm}$$

$$Vf = fz \cdot z \cdot n = \text{mm/min}$$

SM4315

ØD = 4 - 20

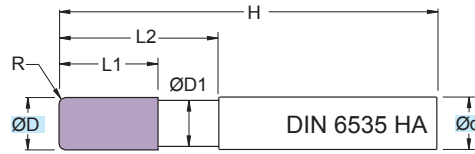

Fresa in M.D.I. Micrograno
 Gambo sec. DIN 6535 HA

Micrograin HM mills
 DIN 6535 HA Shank

TOLLERANZE	D	d
TOLLERANCE RANGE	h10	h6

RIVESTIM. COATED GRAY	
R	52 HRC

ART.	(mm)							
	ØD	Ød	ØD1	L1	L2	H	R	z
SM4315.040.R025	4	6	3,8	11	18	57	0,25	4
SM4315.041.R050	4	6	3,8	11	18	57	0,50	4
SM4315.042.R100	4	6	3,8	11	18	57	1,00	4
SM4315.050.R050	5	6	4,8	13	20	57	0,50	4
SM4315.051.R100	5	6	4,8	13	20	57	1,00	4
SM4315.052.R150	5	6	4,8	13	20	57	1,50	4
SM4315.060.R050	6	6	5,8	13	20	57	0,50	4
SM4315.061.R100	6	6	5,8	13	20	57	1,00	4
SM4315.062.R150	6	6	5,8	13	20	57	1,50	4
SM4315.063.R200	6	6	5,8	13	20	57	2,00	4
SM4315.080.R050	8	8	7,7	19	27	63	0,50	4
SM4315.081.R100	8	8	7,7	19	27	63	1,00	4
SM4315.082.R150	8	8	7,7	19	27	63	1,50	4
SM4315.083.R200	8	8	7,7	19	27	63	2,00	4
SM4315.100.R050	10	10	9,5	22	32	72	0,50	4
SM4315.101.R100	10	10	9,5	22	32	72	1,00	4
SM4315.102.R150	10	10	9,5	22	32	72	1,50	4
SM4315.103.R200	10	10	9,5	22	32	72	2,00	4
SM4315.120.R050	12	12	11,5	26	38	83	0,50	4
SM4315.121.R100	12	12	11,5	26	38	83	1,00	4
SM4315.122.R150	12	12	11,5	26	38	83	1,50	4
SM4315.123.R200	12	12	11,5	26	38	83	2,00	4
SM4315.140.R100	14	14	13,5	26	38	83	1,00	4
SM4315.141.R200	14	14	13,5	26	38	83	2,00	4
SM4315.160.R100	16	16	15,5	32	44	92	1,00	4
SM4315.161.R150	16	16	15,5	32	44	92	1,50	4

ART.	(mm)							
	ØD	Ød	ØD1	L1	L2	H	R	z
SM4315.162.R200	16	16	15,5	32	44	92	2,00	4
SM4315.163.R250	16	16	15,5	32	44	92	2,50	4
SM4315.180.R150	18	18	17,5	32	44	92	1,50	4
SM4315.181.R250	18	18	17,5	32	44	92	2,50	4
SM4315.200.R100	20	20	19,5	38	50	104	1,00	4
SM4315.201.R150	20	20	19,5	38	50	104	1,50	4
SM4315.202.R200	20	20	19,5	38	50	104	2,00	4
SM4315.203.R250	20	20	19,5	38	50	104	2,50	4
SM4315.204.R300	20	20	19,5	38	50	104	3,00	4
SM4315.205.R400	20	20	19,5	38	50	104	4,00	4
SM4315.206.R500	20	20	19,5	38	50	104	5,00	4

Applicazione - Application

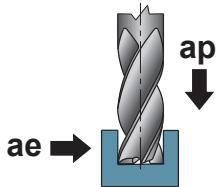

	MATERIALI - MATERIALS													(mm) ØD	(m/min) Vc	(mm) fz	(mm) ap	(mm) ae		
	P	M	K			N			S	H	G									
	ACCIAIO NON LEGATO NOT ALLOY STEEL	ACCIAIO POCO LEGATO LOW ALLOY STEEL	ACCIAIO ALTO LEGATO ALLOY STEEL	INOX MARTENSITICO STAINLESS STEEL MART.	INOX AUST. DUPLEX STAINLESS STEEL AUST.	GHISA GRIGIA GREY CAST IRON	GHISA SFEROIDALE SPHEROIDAL GRAPHITE	GHISA MALLEABILE MALLEABLE CAST IRON	ALLUMINIO E SUE LEGHE ALUMINIUM	RAME E SUE LEGHE COPPER	NON METALLICI PLASTICS	LEGHE RESIST. CALORE HIGH TEMP. ALLOY	TITANIO E SUE LEGHE TITANIUM	ACCIAIO TEMPRATO HARDENED STEEL	GRAFITE GRAPHITE					
●																4+6	140-170	0,015-0,030	1xD	1xD
●																6+10	140-170	0,025-0,040	1xD	1xD
●																10+14	140-170	0,030-0,045	1xD	1xD
●																14+18	140-170	0,040-0,055	1xD	1xD
●																18+20	140-170	0,055-0,070	1xD	1xD
○																4+6	100-130	0,015-0,030	1xD	1xD
○																6+10	100-130	0,025-0,040	1xD	1xD
○																10+14	100-130	0,030-0,045	1xD	1xD
○																14+18	100-130	0,040-0,055	1xD	1xD
○																18+20	100-130	0,055-0,070	1xD	1xD
○																4+6	80-110	0,015-0,030	1xD	1xD
○																6+10	80-110	0,025-0,040	1xD	1xD
○																10+14	80-110	0,030-0,045	1xD	1xD
○																14+18	80-110	0,040-0,055	1xD	1xD
○																18+20	80-110	0,055-0,070	1xD	1xD
○																4+6	40-70	0,005-0,020	1xD	1xD
○																6+10	40-70	0,010-0,025	1xD	1xD
○																10+14	40-70	0,020-0,035	1xD	1xD
○																14+18	40-70	0,025-0,040	1xD	1xD
○																18+20	40-70	0,035-0,050	1xD	1xD
○																4+6	140-170	0,025-0,035	1xD	1xD
○																6+10	140-170	0,040-0,050	1xD	1xD
○																10+14	140-170	0,045-0,060	1xD	1xD
○																14+18	140-170	0,060-0,075	1xD	1xD
○																18+20	140-170	0,080-0,095	1xD	1xD
○																4+6	140-170	0,005-0,035	1xD	1xD
○																6+10	140-170	0,008-0,050	1xD	1xD
○																10+14	140-170	0,045-0,060	1xD	1xD
○																14+18	140-170	0,060-0,075	1xD	1xD
○																18+20	140-170	0,080-0,095	1xD	1xD
○																4+6	20-30	0,005-0,020	1xD	1xD
○																6+10	20-30	0,005-0,025	1xD	1xD
○																10+14	20-30	0,006-0,030	1xD	1xD
○																14+18	20-30	0,006-0,035	1xD	1xD
○																18+20	20-30	0,010-0,045	1xD	1xD
○																4+6	25-40	0,017-0,032	1xD	1xD
○																6+10	25-40	0,021-0,036	1xD	1xD
○																10+14	25-40	0,028-0,043	1xD	1xD
○																14+18	25-40	0,035-0,050	1xD	1xD
○																18+20	25-40	0,045-0,060	1xD	1xD
○																4+6	20-40	0,005-0,013	0,25xD	1xD
○																6+10	20-40	0,005-0,015	0,25xD	1xD
○																10+14	20-40	0,005-0,017	0,25xD	1xD
○																14+18	20-40	0,005-0,020	0,25xD	1xD
○																18+20	20-40	0,005-0,020	0,25xD	1xD

PER LAVORAZIONI A SPALLAMENTO AUMENTARE I PARAMETRI DEL 20%
FOR SHOULDER MILLING PARAMETERS SHOULD BE INCREASED BY 20%

● APPLICAZIONE CONSIGLIATA-RECOMMENDED APPLICATION
EMPFOHLENER EINSATZ - APPLICATION CONSEILLÉE

○ APPLICAZIONE POSSIBILE - POSSIBLE APPLICATION
MÖGLICHE ANWENDUNG - APPLICATION POSSIBLE

Vc = m/min VELOCITÀ DI TAGLIO - CUTTING SPEED

n = giri/min (min⁻¹) NUMERO DI GIRI - NUMBER OF REVOLUTIONS

fz = mm AVANZAMENTO AL DENTE -TOOTH FEED

fn = mm AVANZAMENTO AL GIRO - FEED / REVOLUTION

Vf = mm/min VELOCITÀ DI AVANZAMENTO - FEED SPEED

$$n = \frac{Vc \cdot 1000}{\varnothing D \cdot 3,14} = \text{giri/min (min}^{-1}\text{)}$$

$$fn = fz \cdot z = \text{mm}$$

$$Vf = fz \cdot z \cdot n = \text{mm/min}$$

SM4315..TI

ØD = 4 - 20

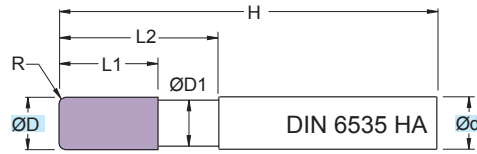

Fresa in M.D.I. Micrograno
 Gambo sec. DIN 6535 HA

Micrograin HM mills
 DIN 6535 HA Shank

TOLLERANZE	D	d
TOLLERANCE RANGE	h10	h6

RIVESTIM. COATED	
ORANGE	
R	52 HRC

ART.	(mm)							
ART.	ØD	Ød	ØD1	L1	L2	H	R	z
SM4315.040.R025.TI	4	6	3,8	11	18	57	0,25	4
SM4315.041.R050.TI	4	6	3,8	11	18	57	0,50	4
SM4315.042.R100.TI	4	6	3,8	11	18	57	1,00	4
SM4315.050.R050.TI	5	6	4,8	13	20	57	0,50	4
SM4315.051.R100.TI	5	6	4,8	13	20	57	1,00	4
SM4315.052.R150.TI	5	6	4,8	13	20	57	1,50	4
SM4315.060.R050.TI	6	6	5,8	13	20	57	0,50	4
SM4315.061.R100.TI	6	6	5,8	13	20	57	1,00	4
SM4315.062.R150.TI	6	6	5,8	13	20	57	1,50	4
SM4315.063.R200.TI	6	6	5,8	13	20	57	2,00	4
SM4315.080.R050.TI	8	8	7,7	19	27	63	0,50	4
SM4315.081.R100.TI	8	8	7,7	19	27	63	1,00	4
SM4315.082.R150.TI	8	8	7,7	19	27	63	1,50	4
SM4315.083.R200.TI	8	8	7,7	19	27	63	2,00	4
SM4315.100.R050.TI	10	10	9,5	22	32	72	0,50	4
SM4315.101.R100.TI	10	10	9,5	22	32	72	1,00	4
SM4315.102.R150.TI	10	10	9,5	22	32	72	1,50	4
SM4315.103.R200.TI	10	10	9,5	22	32	72	2,00	4
SM4315.120.R050.TI	12	12	11,5	26	38	83	0,50	4
SM4315.121.R100.TI	12	12	11,5	26	38	83	1,00	4
SM4315.122.R150.TI	12	12	11,5	26	38	83	1,50	4
SM4315.123.R200.TI	12	12	11,5	26	38	83	2,00	4
SM4315.140.R100.TI	14	14	13,5	26	38	83	1,00	4
SM4315.141.R200.TI	14	14	13,5	26	38	83	2,00	4
SM4315.160.R100.TI	16	16	15,5	32	44	92	1,00	4
SM4315.161.R150.TI	16	16	15,5	32	44	92	1,50	4

ART.	(mm)							
ART.	ØD	Ød	ØD1	L1	L2	H	R	z
SM4315.162.R200.TI	16	16	15,5	32	44	92	2,00	4
SM4315.163.R250.TI	16	16	15,5	32	44	92	2,50	4
SM4315.180.R150.TI	18	18	17,5	32	44	92	1,50	4
SM4315.181.R250.TI	18	18	17,5	32	44	92	2,50	4
SM4315.200.R100.TI	20	20	19,5	38	50	104	1,00	4
SM4315.201.R150.TI	20	20	19,5	38	50	104	1,50	4
SM4315.202.R200.TI	20	20	19,5	38	50	104	2,00	4
SM4315.203.R250.TI	20	20	19,5	38	50	104	2,50	4
SM4315.204.R300.TI	20	20	19,5	38	50	104	3,00	4
SM4315.205.R400.TI	20	20	19,5	38	50	104	4,00	4
SM4315.206.R500.TI	20	20	19,5	38	50	104	5,00	4



Applicazione - Application

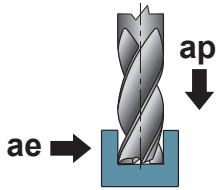

	MATERIALI - MATERIALS													(mm) ØD	(m/min) Vc	(mm) fz	(mm) ap	(mm) ae		
	P	M	K			N			S	H	G									
	ACCIAIO NON LEGATO NOT ALLOY STEEL	ACCIAIO POCO LEGATO LOW ALLOY STEEL	ACCIAIO ALTO LEGATO ALLOY STEEL	INOX MARTENSITICO STAINLESS STEEL MART.	INOX AUST. DUPLEX STAINLESS STEEL AUST.	GHISA GRIGIA GREY CAST IRON	GHISA SFEROIDALE SPHEROIDAL GRAPHITE	GHISA MALLEABILE MALLEABLE CAST IRON	ALLUMINIO E SUE LEGHE ALUMINIUM	RAME E SUE LEGHE COPPER	NON METALLICI PLASTICS	LEGHE RESIST. CALORE HIGH TEMP. ALLOY	TITANIO E SUE LEGHE TITANIUM	ACCIAIO TEMPRATO HARDENED STEEL	GRAFITE GRAPHITE					
○																4+6	110-140	0,015-0,030	1xD	1xD
○																6+10	110-140	0,025-0,040	1xD	1xD
○																10+14	110-140	0,030-0,045	1xD	1xD
○																14+18	110-140	0,040-0,055	1xD	1xD
○																18+20	110-140	0,055-0,070	1xD	1xD
○																4+6	100-135	0,015-0,030	1xD	1xD
○																6+10	100-135	0,025-0,040	1xD	1xD
○																10+14	100-135	0,030-0,045	1xD	1xD
○																14+18	100-135	0,040-0,055	1xD	1xD
○																18+20	100-135	0,055-0,070	1xD	1xD
○																4+6	100-130	0,015-0,030	1xD	1xD
○																6+10	100-130	0,025-0,040	1xD	1xD
○																10+14	100-130	0,030-0,045	1xD	1xD
○																14+18	100-130	0,040-0,055	1xD	1xD
○																18+20	100-130	0,055-0,070	1xD	1xD
●																4+6	80-110	0,026-0,041	1xD	1xD
●																6+10	80-110	0,030-0,045	1xD	1xD
●																10+14	80-110	0,040-0,055	1xD	1xD
●																14+18	80-110	0,060-0,075	1xD	1xD
●																18+20	80-110	0,070-0,085	1xD	1xD
●																4+6	30-50	0,010-0,020	1xD	1xD
●																6+10	30-50	0,015-0,025	1xD	1xD
●																10+14	30-50	0,020-0,035	1xD	1xD
●																14+18	30-50	0,025-0,040	1xD	1xD
●																18+20	30-50	0,030-0,045	1xD	1xD
●																4+6	30-75	0,005-0,020	1xD	1xD
●																6+10	30-75	0,008-0,030	1xD	1xD
●																10+14	30-75	0,023-0,038	1xD	1xD
●																14+18	30-75	0,033-0,048	1xD	1xD
●																18+20	30-75	0,037-0,052	1xD	1xD
○																4+6	20-35	0,005-0,013	0,25xD	1xD
○																6+10	20-35	0,005-0,015	0,25xD	1xD
○																10+14	20-35	0,005-0,017	0,25xD	1xD
○																14+18	20-35	0,005-0,020	0,25xD	1xD
○																18+20	20-35	0,005-0,020	0,25xD	1xD

PER LAVORAZIONI A SPALLAMENTO AUMENTARE I PARAMETRI DEL 20%
FOR SHOULDER MILLING PARAMETERS SHOULD BE INCREASED BY 20%

- APPLICAZIONE CONSIGLIATA-RECOMMENDED APPLICATION
EMPFOHLENER EINSATZ - APPLICATION CONSEILLÉE
- APPLICAZIONE POSSIBILE - POSSIBLE APPLICATION
MÖGLICHE ANWENDUNG - APPLICATION POSSIBLE

Vc = m/min VELOCITÀ DI TAGLIO - CUTTING SPEED

n = giri/min (min⁻¹) NUMERO DI GIRI - NUMBER OF REVOLUTIONS

fz = mm AVANZAMENTO AL DENTE -TOOTH FEED

fn = mm AVANZAMENTO AL GIRO - FEED / REVOLUTION

Vf = mm/min VELOCITÀ DI AVANZAMENTO - FEED SPEED

$$n = \frac{Vc \cdot 1000}{\text{ØD} \cdot 3,14} = \text{giri/min (min}^{-1}\text{)}$$

$$fn = fz \cdot z = \text{mm}$$

$$Vf = fz \cdot z \cdot n = \text{mm/min}$$

SM4313

ØD = 2,5 - 16

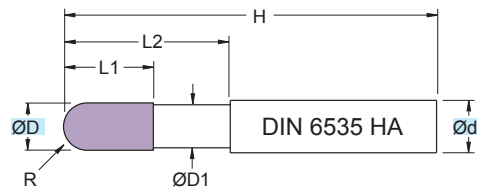

Fresa in M.D.I. Micrograno
 Gambo cilindrico HA

Micrograin HM mills
 Cylindrical Shank HA

TOLLERANZE	D	d
TOLLERANCE RANGE	h10	h6

RIVESTIM. COATED GRAY	
R	60 HRC

(mm)								
ART.	ØD	Ød	ØD1	L1	L2	H	R	z
SM4313.025.S125	2,5	3	2,3	4,0	16	50	1,25	4
SM4313.030.S150	3,0	6	2,8	5,0	16	57	1,50	4
SM4313.035.S175	3,5	6	3,3	6,0	18	57	1,75	4
SM4313.040.S200	4,0	6	3,8	6,0	18	57	2,00	4
SM4313.045.S225	4,5	6	4,3	7,0	18	57	2,25	4
SM4313.050.S250	5,0	6	4,8	7,5	20	57	2,50	4
SM4313.060.S300	6,0	6	5,7	9,0	21	57	3,00	4
SM4313.070.S350	7,0	8	6,7	10,5	24	63	3,50	4
SM4313.080.S400	8,0	8	7,7	12,0	25	63	4,00	4
SM4313.090.S450	9,0	10	8,7	13,5	26	72	4,50	4
SM4313.100.S500	10,0	10	9,7	15,0	28	72	5,00	4
SM4313.120.S600	12,0	12	11,6	18,0	30	83	6,00	4
SM4313.130.S650	13,0	14	12,6	20,0	32	83	6,50	4
SM4313.140.S700	14,0	14	13,6	20,0	32	83	7,00	4
SM4313.150.S750	15,0	16	14,6	22,5	34	92	7,50	4
SM4313.160.S800	16,0	16	15,6	24,0	36	92	8,00	4

Applicazione - Application

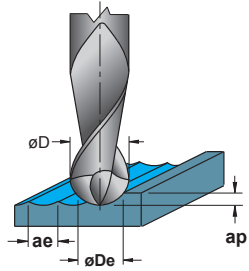

P	M	K	N	S	H	G					
							(mm) ØDe	(m/min) Vc	(mm) fz	(mm) ap	(mm) ae
●							2,5	160-190	0,020-0,035	0,1xDe	0,6xDe
●							3+4	160-190	0,035-0,050	0,1xDe	0,6xDe
●							4+5	160-190	0,035-0,050	0,1xDe	0,6xDe
●							5+7	160-190	0,035-0,050	0,1xDe	0,6xDe
●							7+9	160-190	0,040-0,055	0,1xDe	0,6xDe
●							9+12	160-190	0,070-0,085	0,1xDe	0,6xDe
●							12+14	160-190	0,080-0,095	0,1xDe	0,6xDe
●							14+16	160-190	0,085-0,115	0,1xDe	0,6xDe
●							2,5	140-170	0,020-0,035	0,1xDe	0,6xDe
●							3+4	140-170	0,035-0,050	0,1xDe	0,6xDe
●							4+5	140-170	0,035-0,050	0,1xDe	0,6xDe
●							5+7	140-170	0,035-0,050	0,1xDe	0,6xDe
●							7+9	140-170	0,040-0,055	0,1xDe	0,6xDe
●							9+12	140-170	0,070-0,085	0,1xDe	0,6xDe
●							12+14	140-170	0,080-0,095	0,1xDe	0,6xDe
●							14+16	140-170	0,085-0,115	0,1xDe	0,6xDe
●							2,5	110-140	0,020-0,035	0,1xDe	0,6xDe
●							3+4	110-140	0,035-0,050	0,1xDe	0,6xDe
●							4+5	110-140	0,035-0,050	0,1xDe	0,6xDe
●							5+7	110-140	0,035-0,050	0,1xDe	0,6xDe
●							7+9	110-140	0,040-0,055	0,1xDe	0,6xDe
●							9+12	110-140	0,070-0,085	0,1xDe	0,6xDe
●							12+14	110-140	0,080-0,095	0,1xDe	0,6xDe
●							14+16	110-140	0,085-0,115	0,1xDe	0,6xDe
○							2,5	40-70	0,003-0,015	0,1xDe	0,6xDe
○							3+4	40-70	0,010-0,025	0,1xDe	0,6xDe
○							4+5	40-70	0,010-0,025	0,1xDe	0,6xDe
○							5+7	40-70	0,010-0,025	0,1xDe	0,6xDe
○							7+9	40-70	0,020-0,035	0,1xDe	0,6xDe
○							9+12	40-70	0,040-0,055	0,1xDe	0,6xDe
○							12+14	40-70	0,050-0,065	0,1xDe	0,6xDe
○							14+16	40-70	0,055-0,075	0,1xDe	0,6xDe
●							2,5	140-170	0,025-0,040	0,1xDe	0,6xDe
●							3+4	140-170	0,050-0,065	0,1xDe	0,6xDe
●							4+5	140-170	0,050-0,065	0,1xDe	0,6xDe
●							5+7	140-170	0,050-0,065	0,1xDe	0,6xDe
●							7+9	140-170	0,060-0,075	0,1xDe	0,6xDe
●							9+12	140-170	0,110-0,125	0,1xDe	0,6xDe
●							12+14	140-170	0,130-0,145	0,1xDe	0,6xDe
●							14+16	140-170	0,135-0,155	0,1xDe	0,6xDe
●							2,5	140-170	0,020-0,035	0,1xDe	0,6xDe
●							3+4	140-170	0,035-0,050	0,1xDe	0,6xDe
●							4+5	140-170	0,035-0,050	0,1xDe	0,6xDe
●							5+7	140-170	0,035-0,050	0,1xDe	0,6xDe
●							7+9	140-170	0,040-0,055	0,1xDe	0,6xDe
●							9+12	140-170	0,070-0,085	0,1xDe	0,6xDe
●							12+14	140-170	0,080-0,095	0,1xDe	0,6xDe
●							14+16	140-170	0,085-0,100	0,1xDe	0,6xDe
○							2,5	90-120	0,003-0,015	0,1xDe	0,6xDe
○							3+4	90-120	0,010-0,025	0,1xDe	0,6xDe
○							4+5	90-120	0,010-0,025	0,1xDe	0,6xDe
○							5+7	90-120	0,010-0,025	0,1xDe	0,6xDe
○							7+9	90-120	0,020-0,035	0,1xDe	0,6xDe
○							9+12	90-120	0,040-0,055	0,1xDe	0,6xDe
○							12+14	90-120	0,050-0,065	0,1xDe	0,6xDe
○							14+16	90-120	0,055-0,075	0,1xDe	0,6xDe

● APPLICAZIONE CONSIGLIATA-RECOMMENDED APPLICATION
EMPFÖHLENER EINSATZ - APPLICATION CONSEILLÉE

○ APPLICAZIONE POSSIBILE - POSSIBLE APPLICATION
MÖGLICHE ANWENDUNG - APPLICATION POSSIBLE

øD = mm DIAMETRO - DIAMETER

øDe = mm DIAMETRO EFFETTIVO - EFFECTIVE DIAMETER

Vc = m/min VELOCITÀ DI TAGLIO - CUTTING SPEED

n = giri/min (min⁻¹) NUMERO DI GIRI - NUMBER OF REVOLUTIONS

fz = mm AVANZAMENTO AL DENTE -TOOTH FEED

fn = mm AVANZAMENTO AL GIRO - FEED / REVOLUTION

Vf = mm/min VELOCITÀ DI AVANZAMENTO - FEED SPEED

DATI TECNICI LAVORAZIONI PAG. 1152 - 1153
MACHINING TECHNICAL DATA PAGE 1152 - 1153
BEARBEITUNGSSCHNITTDATEN S. 1152 - 1153
DONNEES TECHNIQUES USINAGES PAGES 1152 - 1153

$$n = \frac{Vc \cdot 1000}{\varnothing De \cdot 3,14} = \text{giri/min (min}^{-1}\text{)}$$

$$fn = fz \cdot z = \text{mm}$$

$$Vf = fz \cdot z \cdot n = \text{mm/min}$$

SM4313..TI

ØD = 2,5 - 16

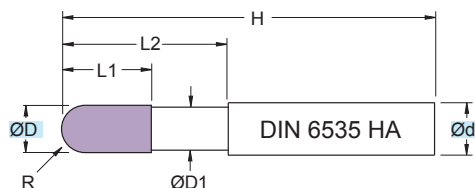

Fresa in M.D.I. Micrograno
 Gambo cilindrico HA

Micrograin HM mills
 Cylindrical Shank HA

TOLLERANZE	D	d
TOLLERANCE RANGE	h10	h6

RIVESTIM.
 COATED
ORANGE



R

**52
 HRC**



(mm)								
ART.	ØD	Ød	ØD1	L1	L2	H	R	z
SM4313.025.S125.TI	2,5	3	2,3	4,0	16	50	1,25	4
SM4313.030.S150.TI	3,0	6	2,8	5,0	16	57	1,50	4
SM4313.035.S175.TI	3,5	6	3,3	6,0	18	57	1,75	4
SM4313.040.S200.TI	4,0	6	3,8	6,0	18	57	2,00	4
SM4313.045.S225.TI	4,5	6	4,3	7,0	18	57	2,25	4
SM4313.050.S250.TI	5,0	6	4,8	7,5	20	57	2,50	4
SM4313.060.S300.TI	6,0	6	5,7	9,0	21	57	3,00	4
SM4313.070.S350.TI	7,0	8	6,7	10,5	24	63	3,50	4
SM4313.080.S400.TI	8,0	8	7,7	12,0	25	63	4,00	4
SM4313.090.S450.TI	9,0	10	8,7	13,5	26	72	4,50	4
SM4313.100.S500.TI	10,0	10	9,7	15,0	28	72	5,00	4
SM4313.120.S600.TI	12,0	12	11,6	18,0	30	83	6,00	4
SM4313.130.S650.TI	13,0	14	12,6	20,0	32	83	6,50	4
SM4313.140.S700.TI	14,0	14	13,6	20,0	32	83	7,00	4
SM4313.150.S750.TI	15,0	16	14,6	22,5	34	92	7,50	4
SM4313.160.S800.TI	16,0	16	15,6	24,0	36	92	8,00	4

Applicazione - Application

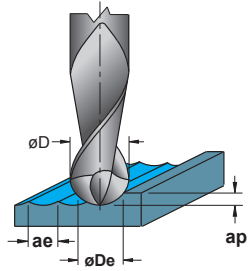

	MATERIALI - MATERIALS										(mm) ØDe	(m/min) Vc	(mm) fz	(mm) ap	(mm) ae					
	P	M	K			N			S	H						G				
	ACCIAIO NON LEGATO NOT ALLOY STEEL	ACCIAIO POCO LEGATO LOW ALLOY STEEL	ACCIAIO ALTO LEGATO ALLOY STEEL	INOX MARTENSITICO STAINLESS STEEL MART.	INOX AUST. DUPLEX STAINLESS STEEL AUST.	GHISA GRIGIA GREY CAST IRON	GHISA SFEROIDALE SPHEROIDAL GRAPHITE	GHISA MALLEABILE MALLEABLE CAST IRON	ALLUMINIO E SUE LEGHE ALUMINIUM	RAME E SUE LEGHE COPPER	NON METALLICI PLASTICS	LEGHE RESIST. CALORE HIGH TEMP. ALLOY	TITANIO E SUE LEGHE TITANIUM	ACCIAIO TEMPRATO HARDENED STEEL	GRAFITE GRAPHITE					
○																2,5	110-140	0,020-0,035	0,1xDe	0,6xDe
○																3+4	110-140	0,035-0,050	0,1xDe	0,6xDe
○																4+5	110-140	0,035-0,050	0,1xDe	0,6xDe
○																5+7	110-140	0,035-0,050	0,1xDe	0,6xDe
○																7+9	110-140	0,040-0,055	0,1xDe	0,6xDe
○																9+12	110-140	0,070-0,085	0,1xDe	0,6xDe
○																12+14	110-140	0,080-0,095	0,1xDe	0,6xDe
○																14+16	110-140	0,085-0,115	0,1xDe	0,6xDe
○				○												2,5	120-150	0,015-0,030	0,1xDe	0,6xDe
○				○												3+4	120-150	0,025-0,040	0,1xDe	0,6xDe
○				○												4+5	120-150	0,030-0,045	0,1xDe	0,6xDe
○				○												5+7	120-150	0,040-0,055	0,1xDe	0,6xDe
○				○												7+9	120-150	0,055-0,070	0,1xDe	0,6xDe
○				○												9+12	120-150	0,065-0,080	0,1xDe	0,6xDe
○				○												12+14	120-150	0,075-0,090	0,1xDe	0,6xDe
○				○												14+16	120-150	0,085-0,110	0,1xDe	0,6xDe
●					●											2,5	90-140	0,030-0,045	0,1xDe	0,6xDe
●					●											3+4	90-140	0,030-0,045	0,1xDe	0,6xDe
●					●											4+5	90-140	0,040-0,055	0,1xDe	0,6xDe
●					●											5+7	90-140	0,050-0,065	0,1xDe	0,6xDe
●					●											7+9	90-140	0,060-0,075	0,1xDe	0,6xDe
●					●											9+12	90-140	0,070-0,085	0,1xDe	0,6xDe
●					●											12+14	90-140	0,080-0,095	0,1xDe	0,6xDe
●					●											14+16	90-140	0,090-0,105	0,1xDe	0,6xDe
●											●					2,5	35-80	0,010-0,025	0,08xDe	0,3xDe
●											●					3+4	35-80	0,010-0,025	0,08xDe	0,3xDe
●											●					4+5	35-80	0,020-0,035	0,08xDe	0,3xDe
●											●					5+7	35-80	0,020-0,035	0,08xDe	0,3xDe
●											●					7+9	35-80	0,030-0,045	0,08xDe	0,3xDe
●											●					9+12	35-80	0,040-0,055	0,08xDe	0,3xDe
●											●					12+14	35-80	0,050-0,065	0,08xDe	0,3xDe
●											●					14+16	35-80	0,060-0,080	0,08xDe	0,3xDe
●												●				2,5	90-120	0,010-0,028	0,08xDe	0,3xDe
●												●				3+4	90-120	0,015-0,030	0,08xDe	0,3xDe
●												●				4+5	90-120	0,020-0,035	0,08xDe	0,3xDe
●												●				5+7	90-120	0,027-0,042	0,08xDe	0,3xDe
●												●				7+9	90-120	0,035-0,050	0,08xDe	0,3xDe
●												●				9+12	90-120	0,045-0,060	0,08xDe	0,3xDe
●												●				12+14	90-120	0,055-0,070	0,08xDe	0,3xDe
●												●				14+16	90-120	0,070-0,085	0,08xDe	0,3xDe
○													○			2,5	30-50	0,005-0,013	0,05xDe	0,15xDe
○													○			3+4	30-50	0,005-0,015	0,05xDe	0,1xDe
○													○			4+5	30-50	0,006-0,017	0,05xDe	0,1xDe
○													○			5+7	30-50	0,006-0,020	0,05xDe	0,1xDe
○													○			7+9	30-50	0,010-0,020	0,05xDe	0,1xDe
○													○			9+12	30-50	0,014-0,023	0,05xDe	0,1xDe
○													○			12+14	30-50	0,016-0,028	0,05xDe	0,1xDe
○													○			14+16	30-50	0,020-0,032	0,05xDe	0,1xDe

● APPLICAZIONE CONSIGLIATA - RECOMMENDED APPLICATION
EMPFOLHENER EINSATZ - APPLICATION CONSEILLÉE

○ APPLICAZIONE POSSIBILE - POSSIBLE APPLICATION
MÖGLICHE ANWENDUNG - APPLICATION POSSIBLE

DATI TECNICI LAVORAZIONI PAG. 1152 - 1153
MACHINING TECHNICAL DATA PAGE 1152 - 1153
BEARBEITUNGSSCHNITTDATEN S. 1152 - 1153
DONNÉES TECHNIQUES USINAGES PAGES 1152 - 1153

øD = mm DIAMETRO - DIAMETER

øDe = mm DIAMETRO EFFETTIVO - EFFECTIVE DIAMETER

Vc = m/min VELOCITÀ DI TAGLIO - CUTTING SPEED

n = giri/min (min⁻¹) NUMERO DI GIRI - NUMBER OF REVOLUTIONS

fz = mm AVANZAMENTO AL DENTE - TOOTH FEED

fn = mm AVANZAMENTO AL GIRO - FEED / REVOLUTION

Vf = mm/min VELOCITÀ DI AVANZAMENTO - FEED SPEED

$$n = \frac{Vc \cdot 1000}{\text{øDe} \cdot 3,14} = \text{giri/min (min}^{-1}\text{)}$$

$$fn = fz \cdot z = \text{mm}$$

$$Vf = fz \cdot z \cdot n = \text{mm/min}$$

SM4413..LX

ØD = 3 - 16

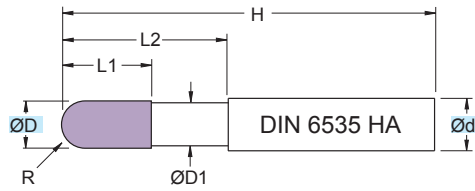

Fresa in M.D.I. Micrograno
 Gambo cilindrico HA

Micrograin HM mills
 Cylindrical Shank HA

TOLLERANZE	D	d
TOLLERANCE RANGE	h10	h6

RIVESTIM. COATED GRAY	
R	60 HRC

ART.	(mm)							
	ØD	Ød	ØD1	L1	L2	H	R	z
SM4413.030.S150.LX	3	6	2,8	5,0	17	75	1,5	4
SM4413.040.S200.LX	4	6	3,8	6,0	22	75	2,0	4
SM4413.050.S250.LX	5	6	4,8	7,5	27	75	2,5	4
SM4413.060.S300.LX	6	6	5,7	9,0	32	100	3,0	4
SM4413.080.S400.LX	8	8	7,7	12,0	42	100	4,0	4
SM4413.100.S500.LX	10	10	9,7	15,0	52	127	5,0	4
SM4413.120.S600.LX	12	12	11,6	18,0	62	152	6,0	4
SM4413.160.S800.LX	16	16	15,6	24,0	82	152	8,0	4

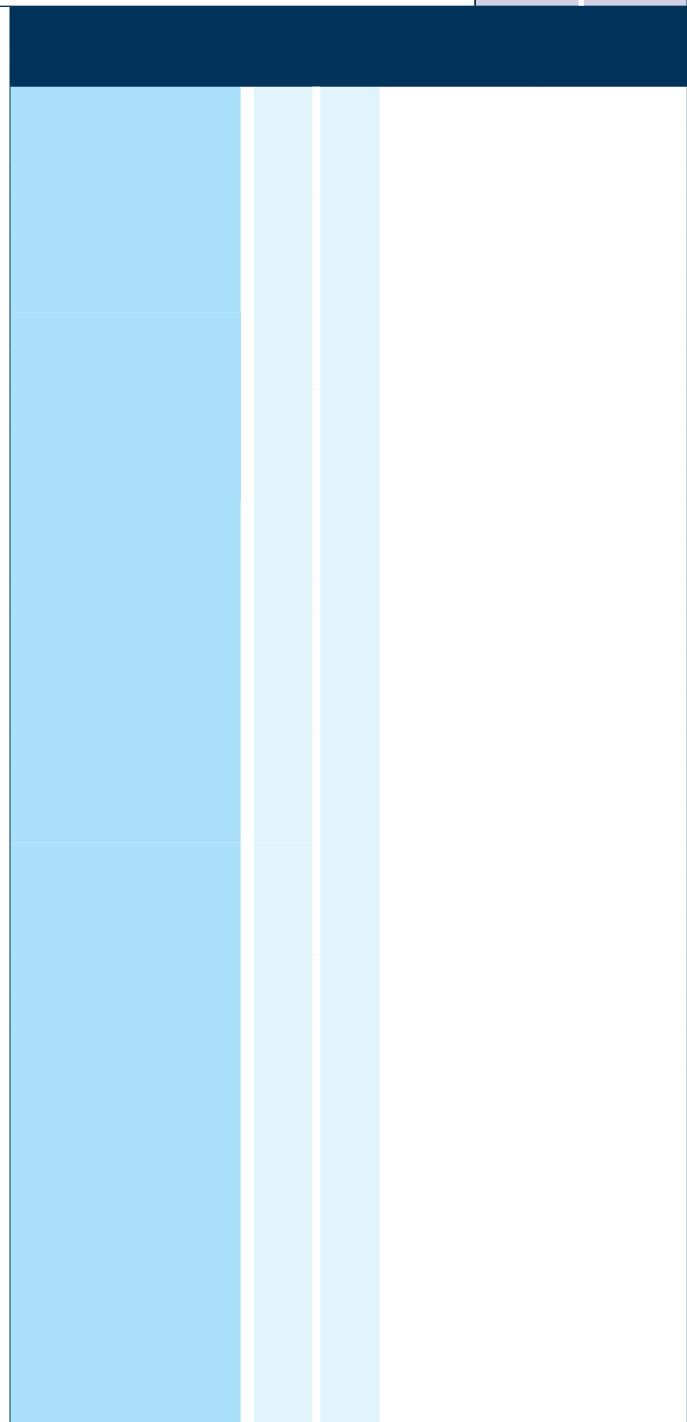

Applicazione - Application

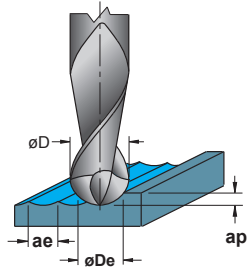

	MATERIALI - MATERIALS											(mm) ØDe	(m/min) Vc	(mm) fz	(mm) ap	(mm) ae				
	P	M	K			N			S	H	G									
	ACCIAIO NON LEGATO NOT ALLOY STEEL	ACCIAIO POCO LEGATO LOW ALLOY STEEL	ACCIAIO ALTO LEGATO ALLOY STEEL	INOX MARTENSITICO STAINLESS STEEL MART.	INOX AUST. DUPLEX STAINLESS STEEL AUST.	GHISA GRIGIA GREY CAST IRON	GHISA SFEROIDALE SPHEROIDAL GRAPHITE	GHISA MALLEABILE MALLEABLE CAST IRON	ALLUMINIO E SUE LEGHE ALUMINIUM	RAME E SUE LEGHE COPPER	NON METALLICI PLASTICS	LEGHE RESIST. CALORE HIGH TEMP. ALLOY	TITANIO E SUE LEGHE TITANIUM	ACCIAIO TEMPRATO HARDENED STEEL	GRAFITE GRAPHITE					
●																3	160-190	0,020-0,035	0,08xDe	0,5xDe
●																4	160-190	0,035-0,050	0,08xDe	0,5xDe
●																5	160-190	0,035-0,050	0,08xDe	0,5xDe
●																6	160-190	0,035-0,050	0,08xDe	0,5xDe
●																8	160-190	0,040-0,055	0,08xDe	0,5xDe
●																10	160-190	0,070-0,085	0,08xDe	0,5xDe
●																12	160-190	0,080-0,095	0,08xDe	0,5xDe
●																16	160-190	0,085-0,115	0,08xDe	0,5xDe
●	●															3	140-170	0,020-0,035	0,08xDe	0,5xDe
●	●															4	140-170	0,035-0,050	0,08xDe	0,5xDe
●	●															5	140-170	0,035-0,050	0,08xDe	0,5xDe
●	●															6	140-170	0,035-0,050	0,08xDe	0,5xDe
●	●															8	140-170	0,040-0,055	0,08xDe	0,5xDe
●	●															10	140-170	0,070-0,085	0,08xDe	0,5xDe
●	●															12	140-170	0,080-0,095	0,08xDe	0,5xDe
●	●															16	140-170	0,085-0,115	0,08xDe	0,5xDe
○																3	110-140	0,020-0,035	0,08xDe	0,5xDe
○																4	110-140	0,035-0,050	0,08xDe	0,5xDe
○																5	110-140	0,035-0,050	0,08xDe	0,5xDe
○																6	110-140	0,035-0,050	0,08xDe	0,5xDe
○																8	110-140	0,040-0,055	0,08xDe	0,5xDe
○																10	110-140	0,070-0,085	0,08xDe	0,5xDe
○																12	110-140	0,080-0,095	0,08xDe	0,5xDe
○																16	110-140	0,085-0,115	0,08xDe	0,5xDe
○				○												3	40-70	0,003-0,015	0,08xDe	0,5xDe
○				○												4	40-70	0,010-0,025	0,08xDe	0,5xDe
○				○												5	40-70	0,010-0,025	0,08xDe	0,5xDe
○				○												6	40-70	0,010-0,025	0,08xDe	0,5xDe
○				○												8	40-70	0,020-0,035	0,08xDe	0,5xDe
○				○												10	40-70	0,040-0,055	0,08xDe	0,5xDe
○				○												12	40-70	0,050-0,065	0,08xDe	0,5xDe
○				○												16	40-70	0,055-0,075	0,08xDe	0,5xDe
○						●										3	140-170	0,025-0,040	0,08xDe	0,5xDe
○						●										4	140-170	0,050-0,065	0,08xDe	0,5xDe
○						●										5	140-170	0,050-0,065	0,08xDe	0,5xDe
○						●										6	140-170	0,050-0,065	0,08xDe	0,5xDe
○						●										8	140-170	0,060-0,075	0,08xDe	0,5xDe
○						●										10	140-170	0,110-0,125	0,08xDe	0,5xDe
○						●										12	140-170	0,130-0,145	0,08xDe	0,5xDe
○						●										16	140-170	0,135-0,155	0,08xDe	0,5xDe
○							●									3	140-170	0,020-0,035	0,08xDe	0,5xDe
○							●									4	140-170	0,035-0,050	0,08xDe	0,5xDe
○							●									5	140-170	0,035-0,050	0,08xDe	0,5xDe
○							●									6	140-170	0,035-0,050	0,08xDe	0,5xDe
○							●									8	140-170	0,040-0,055	0,08xDe	0,5xDe
○							●									10	140-170	0,070-0,085	0,08xDe	0,5xDe
○							●									12	140-170	0,080-0,095	0,08xDe	0,5xDe
○							●									16	140-170	0,085-0,100	0,08xDe	0,5xDe
○													○			3	90-120	0,003-0,015	0,08xDe	0,5xDe
○													○			4	90-120	0,010-0,025	0,08xDe	0,5xDe
○													○			5	90-120	0,010-0,025	0,08xDe	0,5xDe
○													○			6	90-120	0,010-0,025	0,08xDe	0,5xDe
○													○			8	90-120	0,020-0,035	0,08xDe	0,5xDe
○													○			10	90-120	0,040-0,055	0,08xDe	0,5xDe
○													○			12	90-120	0,050-0,065	0,08xDe	0,5xDe
○													○			16	90-120	0,055-0,075	0,08xDe	0,5xDe

● APPLICAZIONE CONSIGLIATA-RECOMMENDED APPLICATION
EMPFÖHLENER EINSATZ - APPLICATION CONSEILLÉE

○ APPLICAZIONE POSSIBILE - POSSIBLE APPLICATION
MÖGLICHE ANWENDUNG - APPLICATION POSSIBLE

øD = mm DIAMETRO - DIAMETER

øDe = mm DIAMETRO EFFETTIVO - EFFECTIVE DIAMETER

Vc = m/min VELOCITÀ DI TAGLIO - CUTTING SPEED

n = giri/min (min⁻¹) NUMERO DI GIRI - NUMBER OF REVOLUTIONS

fz = mm AVANZAMENTO AL DENTE -TOOTH FEED

fn = mm AVANZAMENTO AL GIRO - FEED / REVOLUTION

Vf = mm/min VELOCITÀ DI AVANZAMENTO - FEED SPEED

DATI TECNICI LAVORAZIONI PAG. 1152 - 1153
MACHINING TECHNICAL DATA PAGE 1152 - 1153
BEARBEITUNGSSCHNITTDATEN S. 1152 - 1153
DONNEES TECHNIQUES USINAGES PAGES 1152 - 1153

$$n = \frac{Vc \cdot 1000}{\varnothing De \cdot 3,14} = \text{giri/min (min}^{-1}\text{)}$$

$$fn = fz \cdot z = \text{mm}$$

$$Vf = fz \cdot z \cdot n = \text{mm/min}$$

SM5215..TI

ØD = 6 - 16

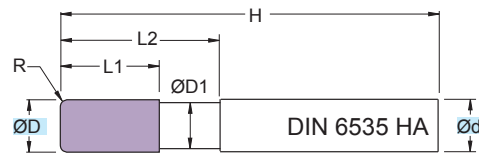

Fresa in M.D.I. Micrograno
 Gambo sec. DIN 6535 HA

Micrograin HM mills
 DIN 6535 HA Shank

TOLLERANZE	D	d
TOLLERANCE RANGE	h10	h6

RIVESTIM. COATED	
ORANGE	
R	52 HRC

ART.	(mm)							
	ØD	Ød	ØD1	L1	L2	H	R	z
SM5215.060.SR050.TI	6	6	5,7	13	20	58	0,50	5
SM5215.060.SR100.TI	6	6	5,7	13	20	58	1,00	5
SM5215.080.SR050.TI	8	8	7,7	19	28	64	0,50	5
SM5215.080.SR100.TI	8	8	7,7	19	28	64	1,00	5
SM5215.080.SR200.TI	8	8	7,7	19	28	64	2,00	5
SM5215.100.SR050.TI	10	10	9,7	22	33	73	0,50	5
SM5215.100.SR100.TI	10	10	9,7	22	33	73	1,00	5
SM5215.100.SR200.TI	10	10	9,7	22	33	73	2,00	5
SM5215.120.SR050.TI	12	12	11,6	26	38	84	0,50	5
SM5215.120.SR100.TI	12	12	11,6	26	38	84	1,00	5
SM5215.120.SR150.TI	12	12	11,6	26	38	84	1,50	5
SM5215.120.SR200.TI	12	12	11,6	26	38	84	2,00	5
SM5215.120.SR300.TI	12	12	11,6	26	38	84	3,00	5
SM5215.160.SR100.TI	16	16	15,6	32	45	93	1,00	5
SM5215.160.SR150.TI	16	16	15,6	32	45	93	1,50	5
SM5215.160.SR200.TI	16	16	15,6	32	45	93	2,00	5
SM5215.160.SR300.TI	16	16	15,6	32	45	93	3,00	5
SM5215.160.SR400.TI	16	16	15,6	32	45	93	4,00	5

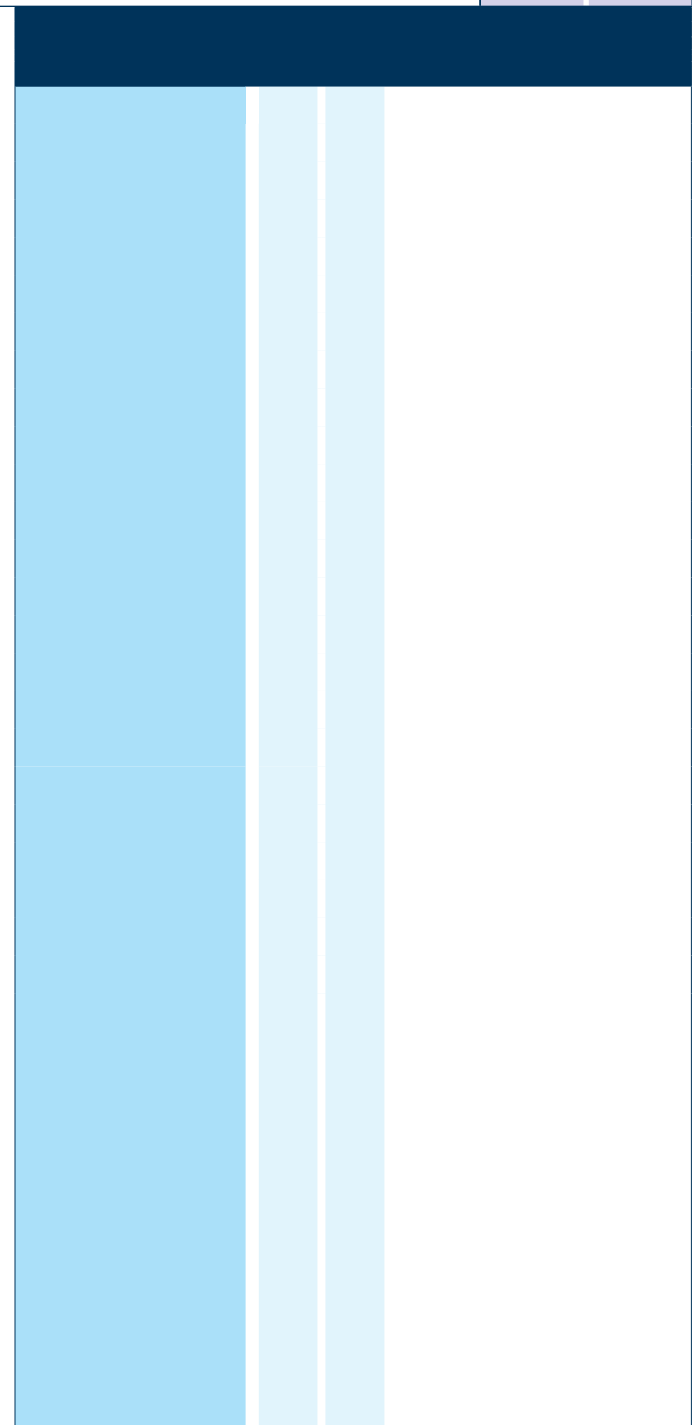

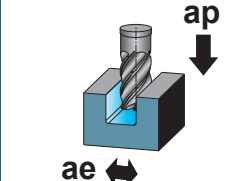
					MATERIALI - MATERIALS						
					P	M	S	H			
					ACCIAIO NON LEGATO NOT ALLOY STEEL	ACCIAIO POCO LEGATO LOW ALLOY STEEL	ACCIAIO ALTO LEGATO ALLOY STEEL	INOX AUST. DUPLEX STAINLESS STEEL/AUST.	LEGHE RESIST. CALORE HIGH TEMP. ALLOY	TITANIO E SUE LEGHE TITANIUM	ACCIAIO TEMPRATO HARDENED STEEL
(mm) ØD	(m/min) Vc	(mm) fz	(mm) ap	(mm) ae							
6÷8	120-140	0,015-0,030	1xD	1xD	●						
8÷10	120-140	0,020-0,040	1xD	1xD	●						
10÷12	120-140	0,030-0,050	1xD	1xD	●						
12÷16	120-140	0,040-0,060	1xD	1xD	●						
6÷8	110-130	0,015-0,030	1xD	1xD	●						
8÷10	110-130	0,020-0,040	1xD	1xD	●						
10÷12	110-130	0,030-0,050	1xD	1xD	●						
12÷16	110-130	0,040-0,060	1xD	1xD	●						
6÷8	115-125	0,010-0,025	1xD	1xD		●					
8÷10	115-125	0,020-0,035	1xD	1xD		●					
10÷12	115-125	0,030-0,045	1xD	1xD		●					
12÷16	115-125	0,040-0,055	1xD	1xD		●					
6÷8	80-120	0,015-0,040	1xD	1xD			●				
8÷10	80-120	0,035-0,050	1xD	1xD			●				
10÷12	80-120	0,045-0,060	1xD	1xD			●				
12÷16	80-120	0,055-0,070	1xD	1xD			●				
6÷8	25-55	0,010-0,020	1xD	1xD				●			
8÷10	25-55	0,015-0,030	1xD	1xD				●			
10÷12	25-55	0,025-0,035	1xD	1xD				●			
12÷16	25-55	0,030-0,045	1xD	1xD				●			
6÷8	40-70	0,015-0,035	1xD	1xD					●		
8÷10	40-70	0,030-0,045	1xD	1xD					●		
10÷12	40-70	0,035-0,050	1xD	1xD					●		
12÷16	40-70	0,040-0,060	1xD	1xD					●		
6÷8	15-35	0,005-0,010	0,20xD	1xD						○	
8÷10	15-35	0,007-0,012	0,20xD	1xD						○	
10÷12	15-35	0,009-0,015	0,20xD	1xD						○	
12÷16	15-35	0,010-0,020	0,20xD	1xD						○	

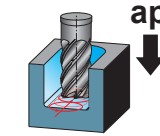
Trocooidale Trochoidal										
										
ap = 2xD (mm)										
ae = 0,1xD (mm)										
ae = 0,15xD (mm)										
ae = 0,2xD (mm)										
(mm) ØD	(m/min) Vc	(mm) fz	(mm) hm	(m/min) Vc	(mm) fz	(mm) hm	(m/min) Vc	(mm) fz	(mm) hm	
6÷8	160-260	0,100-0,150	0,03-0,05	160-260	0,080-0,120	0,03-0,04	160-260	0,060-0,090	0,03-0,04	
8÷10	160-260	0,130-0,180	0,04-0,06	160-260	0,110-0,150	0,04-0,06	160-260	0,070-0,110	0,03-0,05	
10÷12	160-260	0,160-0,210	0,05-0,07	160-260	0,140-0,180	0,05-0,07	160-260	0,080-0,130	0,04-0,06	
12÷16	160-260	0,190-0,240	0,06-0,08	160-260	0,170-0,210	0,06-0,08	160-260	0,090-0,150	0,04-0,07	
6÷8	150-240	0,100-0,150	0,03-0,05	150-240	0,080-0,120	0,03-0,04	150-240	0,060-0,090	0,03-0,04	
8÷10	150-240	0,130-0,180	0,04-0,06	150-240	0,110-0,150	0,04-0,06	150-240	0,070-0,110	0,03-0,05	
10÷12	150-240	0,160-0,210	0,05-0,07	150-240	0,140-0,180	0,05-0,07	150-240	0,080-0,130	0,04-0,06	
12÷16	150-240	0,190-0,240	0,06-0,08	150-240	0,170-0,210	0,06-0,08	150-240	0,090-0,150	0,04-0,07	
6÷8	150-220	0,100-0,150	0,03-0,05	150-220	0,080-0,120	0,03-0,04	150-220	0,060-0,090	0,03-0,04	
8÷10	150-220	0,130-0,180	0,04-0,06	150-220	0,110-0,150	0,04-0,06	150-220	0,070-0,110	0,03-0,05	
10÷12	150-220	0,160-0,210	0,05-0,07	150-220	0,140-0,180	0,05-0,07	150-220	0,080-0,130	0,04-0,06	
12÷16	150-220	0,190-0,240	0,06-0,08	150-220	0,170-0,210	0,06-0,08	150-220	0,090-0,150	0,04-0,07	
6÷8	130-200	0,080-0,130	0,03-0,04	130-200	0,070-0,110	0,03-0,04	130-200	0,050-0,080	0,02-0,04	
8÷10	130-200	0,110-0,160	0,03-0,05	130-200	0,100-0,140	0,04-0,05	130-200	0,060-0,100	0,03-0,05	
10÷12	130-200	0,140-0,190	0,04-0,06	130-200	0,130-0,170	0,05-0,06	130-200	0,070-0,120	0,03-0,06	
12÷16	130-200	0,170-0,210	0,05-0,07	130-200	0,160-0,200	0,06-0,08	130-200	0,080-0,140	0,04-0,07	
ae = 0,05xD (mm)										
6÷8	80-130	0,060-0,110	0,02-0,03	70-120	0,050-0,100	0,02-0,03	60-110	0,040-0,090	0,02-0,03	
8÷10	80-130	0,090-0,140	0,02-0,03	70-120	0,080-0,130	0,03-0,04	60-110	0,070-0,120	0,03-0,04	
10÷12	80-130	0,150-0,200	0,03-0,04	70-120	0,140-0,190	0,04-0,06	60-110	0,130-0,180	0,05-0,07	
12÷16	80-130	0,180-0,240	0,04-0,05	70-120	0,170-0,230	0,05-0,07	60-110	0,160-0,220	0,06-0,08	
ae = 0,10xD (mm)										
6÷8	90-160	0,070-0,120	0,02-0,03	90-160	0,060-0,110	0,02-0,03	80-160	0,050-0,100	0,02-0,04	
8÷10	90-160	0,100-0,150	0,02-0,03	90-160	0,090-0,140	0,03-0,04	80-160	0,080-0,130	0,03-0,05	
10÷12	90-160	0,160-0,210	0,03-0,04	90-160	0,150-0,200	0,05-0,06	80-160	0,140-0,190	0,05-0,07	
12÷16	90-160	0,190-0,250	0,04-0,05	90-160	0,180-0,240	0,06-0,07	80-160	0,170-0,230	0,06-0,08	
ae = 0,15xD (mm)										
6÷8	90-160	0,070-0,120	0,02-0,03	90-160	0,060-0,110	0,02-0,03	80-160	0,050-0,100	0,02-0,04	
8÷10	90-160	0,100-0,150	0,02-0,03	90-160	0,090-0,140	0,03-0,04	80-160	0,080-0,130	0,03-0,05	
10÷12	90-160	0,160-0,210	0,03-0,04	90-160	0,150-0,200	0,05-0,06	80-160	0,140-0,190	0,05-0,07	
12÷16	90-160	0,190-0,250	0,04-0,05	90-160	0,180-0,240	0,06-0,07	80-160	0,170-0,230	0,06-0,08	

PER LAVORAZIONI A SPALLAMENTO AUMENTARE I PARAMETRI DEL 20%
FOR SHOULDER MILLING PARAMETERS SHOULD BE INCREASED BY 20%

- APPLICAZIONE CONSIGLIATA-RECOMMENDED APPLICATION
EMPFOHLENER EINSATZ - APPLICATION CONSEILLÉE
- APPLICAZIONE POSSIBILE - POSSIBLE APPLICATION
MÖGLICHE ANWENDUNG - APPLICATION POSSIBLE

Vc = m/min VELOCITÀ DI TAGLIO - CUTTING SPEED
n = giri/min (min⁻¹) NUMERO DI GIRI - NUMBER OF REVOLUTIONS
fz = mm AVANZAMENTO AL DENTE -TOOTH FEED
fn = mm AVANZAMENTO AL GIRO - FEED / REVOLUTION
Vf = mm/min VELOCITÀ DI AVANZAMENTO - FEED SPEED

$$n = \frac{Vc \cdot 1000}{\text{ØD} \cdot 3,14} = \text{giri/min (min}^{-1}\text{)}$$

$$fn = fz \cdot z = \text{mm}$$

$$Vf = fz \cdot z \cdot n = \text{mm/min}$$

hm = mm SPESSORE MEDIO DEL TRUCIOLO - CHIP'S AVERAGE THICKNESS
Dm = mm LARGHEZZA CAVA - SLOT WIDTH
ØD = mm DIAMETRO FRESA - MILLING CUTTER DIAMETER
w = mm INCREMENTO DI PASSATA RADIALE - RADIAL STEP OVER
ae = mm TAGLIO RADIALE, VALORE MASSIMO - RADIAL CUT MAX.

$$\text{ØD} = \text{Max } 60\% \text{ Dm} = \text{mm}$$

$$w = \text{Max } 10\% \text{ ØD} = \text{mm}$$

$$ae = \frac{Dm^2 - (Dm - 2 \cdot w)^2}{4 \cdot (Dm - \text{ØD})} = \text{mm}$$

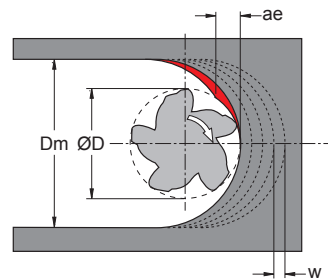

SMW5405..TI

$\varnothing D = 8 - 16$

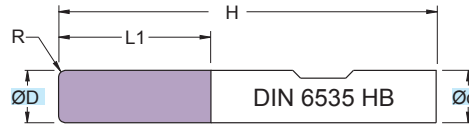

RIVESTIM. COATED	
ORANGE	
R	52 HRC

Fresa in M.D.I. Micrograno
 Gambo sec. DIN 6535 HA

Micrograin HM mills
 DIN 6535 HA Shank

TOLLERANZE	D	d
TOLLERANCE RANGE	h10	h6

(mm)						
ART.	$\varnothing D$	$\varnothing d$	L1	H	R	z
SMW5405.080.SR030.TI	8	8	33	71	0,30	5
SMW5405.080.SR050.TI	8	8	33	71	0,50	5
SMW5405.100.SR030.TI	10	10	41	83	0,30	5
SMW5405.100.SR050.TI	10	10	41	83	0,50	5
SMW5405.100.SR100.TI	10	10	41	83	1,00	5
SMW5405.120.SR030.TI	12	12	49	96	0,30	5
SMW5405.120.SR050.TI	12	12	49	96	0,50	5
SMW5405.120.SR100.TI	12	12	49	96	1,00	5
SMW5405.140.SR030.TI	14	14	57	103	0,30	5
SMW5405.140.SR050.TI	14	14	57	103	0,50	5
SMW5405.140.SR100.TI	14	14	57	103	1,00	5
SMW5405.160.SR030.TI	16	16	65	120	0,30	5
SMW5405.160.SR050.TI	16	16	65	120	0,50	5
SMW5405.160.SR100.TI	16	16	65	120	1,00	5

--	--	--	--	--	--	--

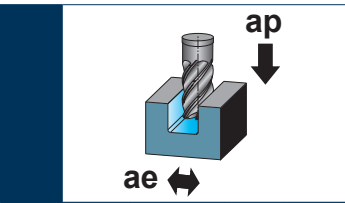

(mm) ØD	(m/min) Vc	(mm) fz	(mm) ap	(mm) ae
8÷10	140-230	0,060-0,100	4xD	0,10xD
10÷12	140-230	0,070-0,120	4xD	0,10xD
12÷16	140-230	0,080-0,130	4xD	0,10xD
8÷10	130-220	0,060-0,100	4xD	0,10xD
10÷12	130-220	0,070-0,120	4xD	0,10xD
12÷16	130-220	0,080-0,130	4xD	0,10xD
8÷10	130-200	0,060-0,100	4xD	0,10xD
10÷12	130-200	0,080-0,130	4xD	0,10xD
12÷16	130-200	0,090-0,150	4xD	0,10xD
8÷10	120-180	0,050-0,090	4xD	0,10xD
10÷12	120-180	0,060-0,110	4xD	0,10xD
12÷16	120-180	0,070-0,130	4xD	0,10xD
8÷10	60-110	0,060-0,110	4xD	0,10xD
10÷12	60-110	0,120-0,160	4xD	0,10xD
12÷16	60-110	0,140-0,200	4xD	0,10xD
8÷10	80-160	0,070-0,120	4xD	0,10xD
10÷12	80-160	0,130-0,170	4xD	0,10xD
12÷16	80-160	0,150-0,210	4xD	0,10xD
8÷10	15-35	0,007-0,012	4xD	0,05xD
10÷12	15-35	0,009-0,015	4xD	0,05xD
12÷16	15-35	0,010-0,020	4xD	0,05xD

MATERIALI - MATERIALS				
P	M	S	H	
ACCIAIO NON LEGATO NOT ALLOY STEEL	ACCIAIO POCO LEGATO LOW ALLOY STEEL	ACCIAIO ALTO LEGATO ALLOY STEEL	INOX AUST. DUPLEX STAINLESS STEEL/AUST.	LEGHE RESIST. CALORE HIGH TEMP. ALLOY
			TITANIO E SUE LEGHE TITANIUM	ACCIAIO TEMPRATO HARDENED STEEL

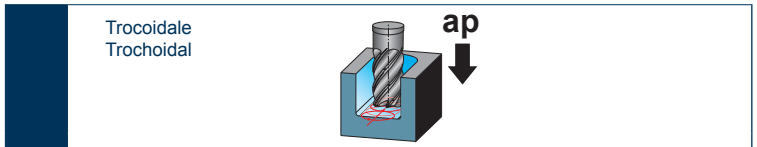

Trocoïdale Trochoidal										
ap = 4xD (mm)										
ae = 0,05xD (mm)			ae = 0,075xD (mm)			ae = 0,10xD (mm)				
(mm) ØD	(m/min) Vc	(mm) fz	(mm) hm	(m/min) Vc	(mm) fz	(mm) hm	(m/min) Vc	(mm) fz	(mm) hm	
8÷10	140-230	0,130-0,180	0,03-0,05	140-230	0,100-0,135	0,03-0,05	140-230	0,060-0,100	0,03-0,04	
10÷12	140-230	0,140-0,190	0,04-0,06	140-230	0,130-0,160	0,04-0,06	140-230	0,070-0,120	0,03-0,05	
12÷16	140-230	0,170-0,220	0,05-0,07	140-230	0,150-0,190	0,05-0,07	140-230	0,080-0,130	0,03-0,06	
8÷10	130-220	0,120-0,160	0,03-0,05	130-220	0,100-0,130	0,03-0,05	130-220	0,060-0,100	0,03-0,04	
10÷12	130-220	0,140-0,190	0,04-0,06	130-220	0,130-0,160	0,04-0,06	130-220	0,070-0,120	0,03-0,05	
12÷16	130-220	0,170-0,220	0,05-0,07	130-220	0,150-0,190	0,05-0,07	130-220	0,080-0,130	0,03-0,06	
8÷10	130-200	0,120-0,160	0,03-0,05	130-200	0,100-0,130	0,03-0,05	130-200	0,060-0,100	0,03-0,05	
10÷12	130-200	0,140-0,190	0,04-0,06	130-200	0,130-0,160	0,04-0,06	130-200	0,080-0,130	0,03-0,05	
12÷16	130-200	0,170-0,220	0,05-0,07	130-200	0,150-0,190	0,05-0,07	130-200	0,090-0,150	0,03-0,06	
8÷10	120-180	0,100-0,140	0,03-0,05	120-180	0,090-0,130	0,03-0,05	120-180	0,050-0,090	0,03-0,04	
10÷12	120-180	0,130-0,170	0,04-0,06	120-180	0,120-0,150	0,04-0,06	120-180	0,060-0,110	0,03-0,05	
12÷16	120-180	0,150-0,190	0,05-0,07	120-180	0,140-0,180	0,05-0,07	120-180	0,070-0,130	0,04-0,06	
ae = 0,05xD (mm)			ae = 0,075xD (mm)			ae = 0,10xD (mm)				
8÷10	70-120	0,080-0,130	0,02-0,03	60-110	0,070-0,120	0,02-0,03	60-110	0,060-0,110	0,03-0,04	
10÷12	70-120	0,130-0,180	0,03-0,04	60-110	0,130-0,170	0,03-0,04	60-110	0,120-0,160	0,05-0,06	
12÷16	70-120	0,160-0,220	0,04-0,05	60-110	0,150-0,200	0,04-0,05	60-110	0,140-0,200	0,05-0,07	
8÷10	80-150	0,090-0,140	0,03-0,04	80-150	0,080-0,130	0,03-0,04	80-160	0,070-0,120	0,03-0,04	
10÷12	80-150	0,140-0,190	0,03-0,04	80-150	0,140-0,180	0,03-0,04	80-160	0,130-0,170	0,05-0,06	
12÷16	80-150	0,170-0,230	0,04-0,05	80-150	0,160-0,210	0,04-0,05	80-160	0,150-0,210	0,05-0,07	

PER LAVORAZIONI A SPALLAMENTO AUMENTARE I PARAMETRI DEL 20%
FOR SHOULDER MILLING PARAMETERS SHOULD BE INCREASED BY 20%

- APPLICAZIONE CONSIGLIATA-RECOMMENDED APPLICATION
EMPFOHLENER EINSATZ - APPLICATION CONSEILLÉE
- APPLICAZIONE POSSIBILE - POSSIBLE APPLICATION
MÖGLICHE ANWENDUNG - APPLICATION POSSIBLE

Vc = m/min VELOCITÀ DI TAGLIO - CUTTING SPEED
n = giri/min (min⁻¹) NUMERO DI GIRI - NUMBER OF REVOLUTIONS
fz = mm AVANZAMENTO AL DENTE -TOOTH FEED
fn = mm AVANZAMENTO AL GIRO - FEED / REVOLUTION
Vf = mm/min VELOCITÀ DI AVANZAMENTO - FEED SPEED

$$n = \frac{Vc \cdot 1000}{\text{ØD} \cdot 3,14} = \text{giri/min (min}^{-1}\text{)}$$

$$fn = fz \cdot z = \text{mm}$$

$$Vf = fz \cdot z \cdot n = \text{mm/min}$$

hm = mm SPESSORE MEDIO DEL TRUCIOLO - CHIP'S AVERAGE THICKNESS
Dm = mm LARGHEZZA CAVA - SLOT WIDTH
ØD = mm DIAMETRO FRESA - MILLING CUTTER DIAMETER
w = mm INCREMENTO DI PASSATA RADIALE - RADIAL STEP OVER
ae = mm TAGLIO RADIALE, VALORE MASSIMO - RADIAL CUT MAX.

$$\text{ØD} = \text{Max } 60\% \text{ Dm} = \text{mm}$$

$$w = \text{Max } 10\% \text{ ØD} = \text{mm}$$

$$ae = \frac{Dm^2 - (Dm - 2 \cdot w)^2}{4 \cdot (Dm - \text{ØD})} = \text{mm}$$

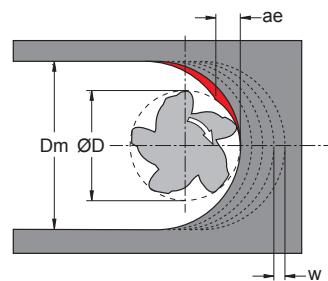

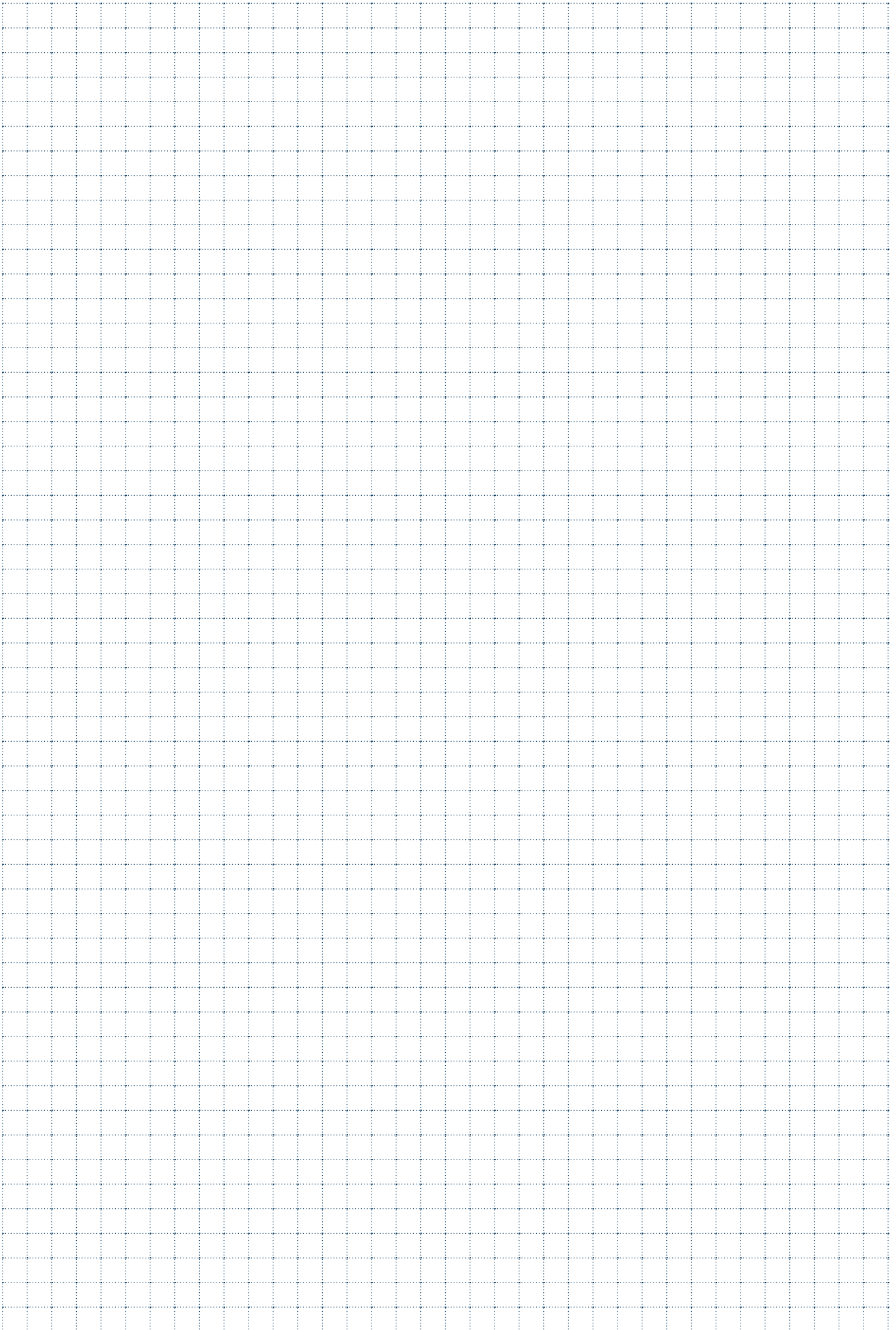



SEDI CHIAVETTE

KEYSLOTS / PASSFEDERNUTEN / LOGEMENT CLES /
RANURAS PARA CHAVETAS

SMW3301

$\varnothing D = 1,80-15,70$

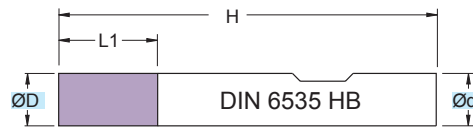

RIVESTIM. COATED BLACK	
90°	42 HRC

**Fresa in M.D.I. Micrograno
 Gambo cilindrico HB**

Micrograin HM mills
 Cylindrical Shank HB

TOLLERANZE	D	d
TOLLERANCE RANGE	h10	h6

ART.	(mm)				
	$\varnothing D$	$\varnothing d$	L1	H	z
SMW3301.018.N00	1,80	6	3	50	3
SMW3301.028.N00	2,80	6	4	50	3
SMW3301.038.N00	3,80	6	5	50	3
SMW3301.048.N00	4,80	6	6	50	3
SMW3301.057.N00	5,75	6	7	50	3
SMW3301.077.N00	7,75	8	10	63	3
SMW3301.097.N00	9,70	10	11	72	3
SMW3301.117.N00	11,70	12	14	83	3
SMW3301.137.N00	13,70	14	14	83	3
SMW3301.157.N00	15,70	16	16	92	3

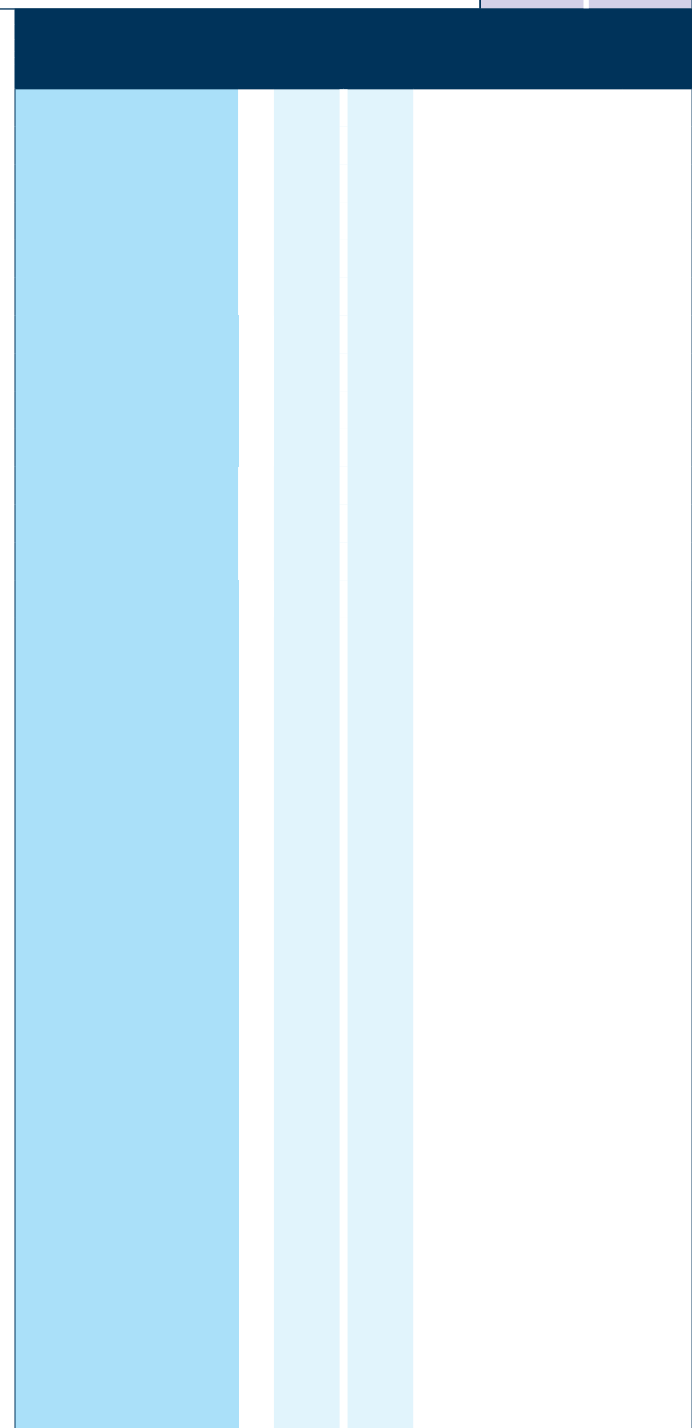

MATERIALI - MATERIALS Pag. 1199

Applicazione - Application

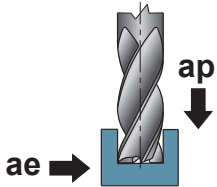

Applicazione - Application	MATERIALI - MATERIALS											(mm) ØD	(m/min) Vc	(mm) fz	(mm) ap	(mm) ae				
	P		M	K			N			S	H						G			
	ACCIAIO NON LEGATO NOT ALLOY STEEL	ACCIAIO POCO LEGATO LOW ALLOY STEEL	ACCIAIO ALTO LEGATO ALLOY STEEL	INOX MARTENSITICO STAINLESS STEEL MART.	INOX AUST. DUPLEX STAINLESS STEEL AUST.	GHISA GRIGIA GREY CAST IRON	GHISA SFEROIDALE SPHEROIDAL GRAPHITE	GHISA MALLEABILE MALLEABLE CAST IRON	ALLUMINIO E SUE LEGHE ALUMINIUM	RAME E SUE LEGHE COPPER	NON METALLICI PLASTICS	LEGHE RESIST. CALORE HIGH TEMP. ALLOY	TITANIO E SUE LEGHE TITANIUM	ACCIAIO TEMPRATO HARDENED STEEL	GRAFITE GRAPHITE					
●																1,80	70-100	0,010-0,025	0,5xD	1xD
●																2,80	70-100	0,020-0,035	0,5xD	1xD
●																3,80	70-100	0,030-0,045	0,5xD	1xD
●																4,80	70-100	0,035-0,050	0,5xD	1xD
●																5,75	70-100	0,040-0,055	0,5xD	1xD
●																7,75	70-100	0,050-0,065	0,5xD	1xD
●																9,70	70-100	0,060-0,075	0,5xD	1xD
●																11,70	70-100	0,070-0,085	0,5xD	1xD
●																13,70	70-100	0,080-0,095	0,5xD	1xD
●																15,70	70-100	0,090-0,105	0,5xD	1xD
		●														1,80	55-85	0,010-0,025	0,5xD	1xD
		●														2,80	55-85	0,020-0,035	0,5xD	1xD
		●														3,80	55-85	0,030-0,045	0,5xD	1xD
		●														4,80	55-85	0,035-0,050	0,5xD	1xD
		●														5,75	55-85	0,040-0,055	0,5xD	1xD
		●														7,75	55-85	0,050-0,065	0,5xD	1xD
		●														9,70	55-85	0,060-0,075	0,5xD	1xD
		●														11,70	55-85	0,070-0,085	0,5xD	1xD
		●														13,70	55-85	0,080-0,095	0,5xD	1xD
		●														15,70	55-85	0,090-0,105	0,5xD	1xD
			●													1,80	40-70	0,010-0,025	0,5xD	1xD
			●													2,80	40-70	0,020-0,035	0,5xD	1xD
			●													3,80	40-70	0,030-0,045	0,5xD	1xD
			●													4,80	40-70	0,035-0,050	0,5xD	1xD
			●													5,75	40-70	0,040-0,055	0,5xD	1xD
			●													7,75	40-70	0,050-0,065	0,5xD	1xD
			●													9,70	40-70	0,060-0,075	0,5xD	1xD
			●													11,70	40-70	0,070-0,085	0,5xD	1xD
			●													13,70	40-70	0,080-0,095	0,5xD	1xD
			●													15,70	40-70	0,090-0,105	0,5xD	1xD
				●												1,80	90-130	0,010-0,025	0,5xD	1xD
				●												2,80	90-130	0,020-0,035	0,5xD	1xD
				●												3,80	90-130	0,030-0,045	0,5xD	1xD
				●												4,80	90-130	0,035-0,050	0,5xD	1xD
				●												5,75	90-130	0,040-0,055	0,5xD	1xD
				●												7,75	90-130	0,050-0,065	0,5xD	1xD
				●												9,70	90-130	0,060-0,075	0,5xD	1xD
				●												11,70	90-130	0,070-0,085	0,5xD	1xD
				●												13,70	90-130	0,080-0,095	0,5xD	1xD
				●												15,70	90-130	0,090-0,105	0,5xD	1xD
					●											1,80	70-100	0,010-0,025	0,5xD	1xD
					●											2,80	70-100	0,020-0,035	0,5xD	1xD
					●											3,80	70-100	0,030-0,045	0,5xD	1xD
					●											4,80	70-100	0,035-0,050	0,5xD	1xD
					●											5,75	70-100	0,040-0,055	0,5xD	1xD
					●											7,75	70-100	0,050-0,065	0,5xD	1xD
					●											9,70	70-100	0,060-0,075	0,5xD	1xD
					●											11,70	70-100	0,070-0,085	0,5xD	1xD
					●											13,70	70-100	0,080-0,095	0,5xD	1xD
					●											15,70	70-100	0,090-0,105	0,5xD	1xD

● APPLICAZIONE CONSIGLIATA-RECOMMENDED APPLICATION
EMPFOHLENER EINSATZ - APPLICATION CONSEILLÉE

○ APPLICAZIONE POSSIBILE - POSSIBLE APPLICATION
MÖGLICHE ANWENDUNG - APPLICATION POSSIBLE

Vc = m/min VELOCITÀ DI TAGLIO - CUTTING SPEED

n = giri/min (min⁻¹) NUMERO DI GIRI - NUMBER OF REVOLUTIONS

fz = mm AVANZAMENTO AL DENTE -TOOTH FEED

fn = mm AVANZAMENTO AL GIRO - FEED / REVOLUTION

Vf = mm/min VELOCITÀ DI AVANZAMENTO - FEED SPEED

$$n = \frac{Vc \cdot 1000}{\text{ØD} \cdot 3,14} = \text{giri/min (min}^{-1}\text{)}$$

$$fn = fz \cdot z = \text{mm}$$

$$Vf = fz \cdot z \cdot n = \text{mm/min}$$

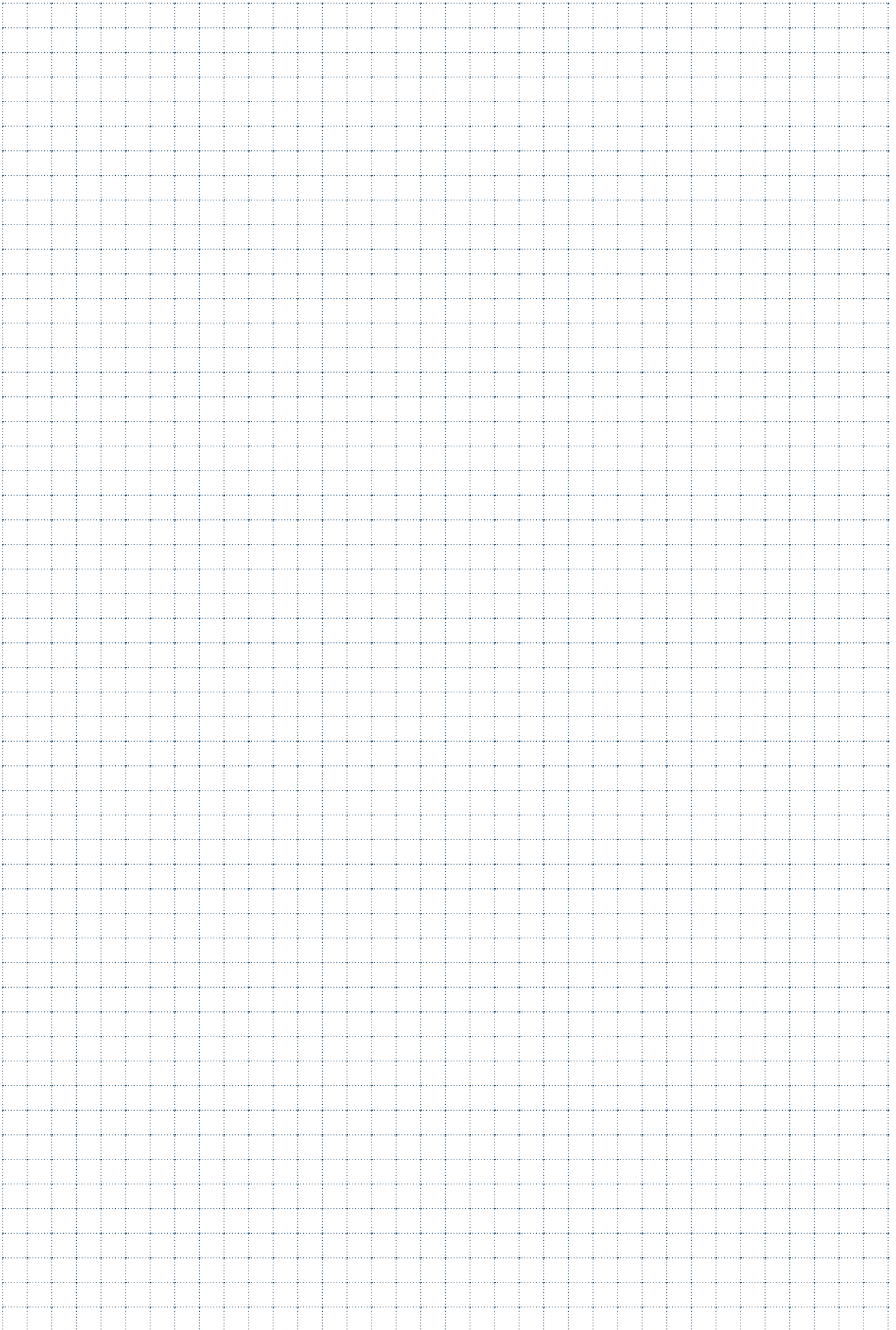



SVASATORI SMUSSATORI

COUNTERSINK AND CHAMFER MILLS / KEGELSENKER-KANTENFRÄSER /
FRAISES CONIQUES A NOYER-CHANFREINEURS / AVELLANADORES-BISELADORAS

SCR0183

$\varnothing D = 4 - 20$

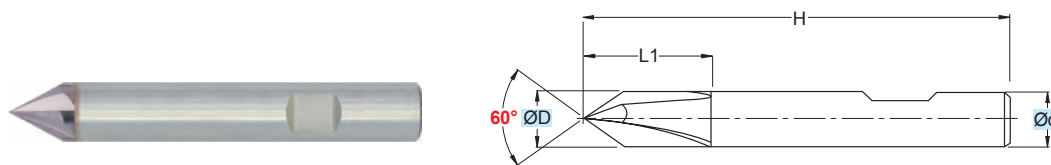

RIVESTIM.
COATED

BLACK

60°

**42
HRC**



Fresa in M.D.I. Micrograno
 Gambo sec. DIN 6535 HB

Micrograin HM mills
 DIN 6535 HB Shank

TOLLERANZE	D	d
TOLLERANCE RANGE		h6

ART.	(mm)				
	$\varnothing D$	$\varnothing d$	H	L1	Z
SCR0183040	4	4	54	4	4
SCR0183060	6	6	57	6	5
SCR0183080	8	8	63	8	5
SCR0183100	10	10	72	10	6
SCR0183120	12	12	83	12	6
SCR0183160	16	16	92	16	6
SCR0183200	20	20	104	20	6

Applicazione - Application

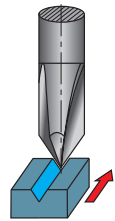
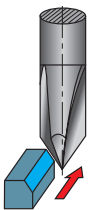
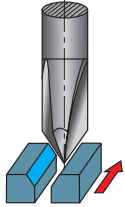

P	M	K	N	S	H	G	(mm) ØD	(m/min) Vc	(mm) fz	(mm) ap	(mm) ae			
												ACACCIAIO NON LEGATO NOT ALLOY STEEL	ACACCIAIO POCO LEGATO LOW ALLOY STEEL	ACACCIAIO ALTO LEGATO ALLOY STEEL
							4	60-90	0,030-0,045	-	-			
							6	60-90	0,030-0,045	-	-			
							8	60-90	0,030-0,045	-	-			
							10	60-90	0,030-0,045	-	-			
							12	60-90	0,030-0,045	-	-			
							16	60-90	0,030-0,045	-	-			
							20	60-90	0,030-0,045	-	-			
							4	30-60	0,020-0,035	-	-			
							6	30-60	0,020-0,035	-	-			
							8	30-60	0,020-0,035	-	-			
							10	30-60	0,020-0,035	-	-			
							12	30-60	0,020-0,035	-	-			
							16	30-60	0,020-0,035	-	-			
							20	30-60	0,020-0,035	-	-			
							4	100-130	0,060-0,075	-	-			
							6	100-130	0,060-0,075	-	-			
							8	100-130	0,060-0,075	-	-			
							10	100-130	0,060-0,075	-	-			
							12	100-130	0,060-0,075	-	-			
							16	100-130	0,060-0,075	-	-			
							20	100-130	0,060-0,075	-	-			
							4	270-320	0,060-0,075	-	-			
							6	270-320	0,060-0,075	-	-			
							8	270-320	0,060-0,075	-	-			
							10	270-320	0,060-0,075	-	-			
							12	270-320	0,060-0,075	-	-			
							16	270-320	0,060-0,075	-	-			
							20	270-320	0,060-0,075	-	-			

● APPLICAZIONE CONSIGLIATA-RECOMMENDED APPLICATION
EMPFOLHENER EINSATZ - APPLICATION CONSEILLÉE

○ APPLICAZIONE POSSIBILE - POSSIBLE APPLICATION
MÖGLICHE ANWENDUNG - APPLICATION POSSIBLE

Vc = m/min VELOCITÀ DI TAGLIO - CUTTING SPEED

n = giri/min (min⁻¹) NUMERO DI GIRI - NUMBER OF REVOLUTIONS

fz = mm AVANZAMENTO AL DENTE -TOOTH FEED

fn = mm AVANZAMENTO AL GIRO - FEED / REVOLUTION

Vf = mm/min VELOCITÀ DI AVANZAMENTO - FEED SPEED

$$n = \frac{Vc \cdot 1000}{\varnothing D \cdot 3,14} = \text{giri/min (min}^{-1}\text{)}$$

$$fn = fz \cdot z = \text{mm}$$

$$Vf = fz \cdot z \cdot n = \text{mm/min}$$

SCR0187

$\varnothing D = 4 - 20$

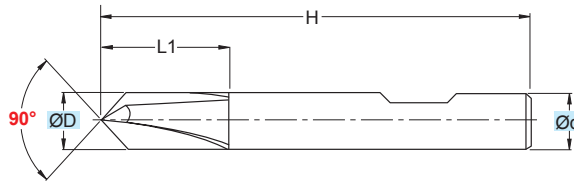

RIVESTIM.
COATED

BLACK

90°

**42
HRC**



Fresa in M.D.I. Micrograno
 Gambo sec. DIN 6535 HB

Micrograin HM mills
 DIN 6535 HB Shank

TOLLERANZE	D	d
TOLLERANCE RANGE		h6

ART.	(mm)				
	$\varnothing D$	$\varnothing d$	H	L1	Z
SCR0187040	4	4	54	4	4
SCR0187060	6	6	57	6	5
SCR0187080	8	8	63	8	5
SCR0187100	10	10	72	10	6
SCR0187120	12	12	83	12	6
SCR0187160	16	16	92	16	6
SCR0187200	20	20	104	20	6

Applicazione - Application

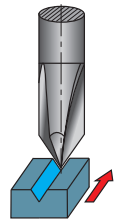
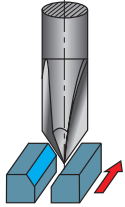

P	M	K	N	S	H	G	(mm) ØD	(m/min) Vc	(mm) fz	(mm) ap	(mm) ae			
												ACCIAIO NON LEGATO NOT ALLOY STEEL	ACCIAIO POCO LEGATO LOW ALLOY STEEL	ACCIAIO ALTO LEGATO ALLOY STEEL
							4	60-90	0,030-0,045	-	-			
							6	60-90	0,030-0,045	-	-			
							8	60-90	0,030-0,045	-	-			
							10	60-90	0,030-0,045	-	-			
							12	60-90	0,030-0,045	-	-			
							16	60-90	0,030-0,045	-	-			
							20	60-90	0,030-0,045	-	-			
							4	30-60	0,020-0,035	-	-			
							6	30-60	0,020-0,035	-	-			
							8	30-60	0,020-0,035	-	-			
							10	30-60	0,020-0,035	-	-			
							12	30-60	0,020-0,035	-	-			
							16	30-60	0,020-0,035	-	-			
							20	30-60	0,020-0,035	-	-			
							4	100-130	0,060-0,075	-	-			
							6	100-130	0,060-0,075	-	-			
							8	100-130	0,060-0,075	-	-			
							10	100-130	0,060-0,075	-	-			
							12	100-130	0,060-0,075	-	-			
							16	100-130	0,060-0,075	-	-			
							20	100-130	0,060-0,075	-	-			
							4	270-320	0,060-0,075	-	-			
							6	270-320	0,060-0,075	-	-			
							8	270-320	0,060-0,075	-	-			
							10	270-320	0,060-0,075	-	-			
							12	270-320	0,060-0,075	-	-			
							16	270-320	0,060-0,075	-	-			
							20	270-320	0,060-0,075	-	-			

● APPLICAZIONE CONSIGLIATA-RECOMMENDED APPLICATION
EMPFOLHENER EINSATZ - APPLICATION CONSEILLÉE

○ APPLICAZIONE POSSIBILE - POSSIBLE APPLICATION
MÖGLICHE ANWENDUNG - APPLICATION POSSIBLE

Vc = m/min VELOCITÀ DI TAGLIO - CUTTING SPEED

n = giri/min (min⁻¹) NUMERO DI GIRI - NUMBER OF REVOLUTIONS

fz = mm AVANZAMENTO AL DENTE -TOOTH FEED

fn = mm AVANZAMENTO AL GIRO - FEED / REVOLUTION

Vf = mm/min VELOCITÀ DI AVANZAMENTO - FEED SPEED

$$n = \frac{Vc \cdot 1000}{\text{ØD} \cdot 3,14} = \text{giri/min (min}^{-1}\text{)}$$

$$fn = fz \cdot z = \text{mm}$$

$$Vf = fz \cdot z \cdot n = \text{mm/min}$$

SMR0110

ØD = 4 - 16

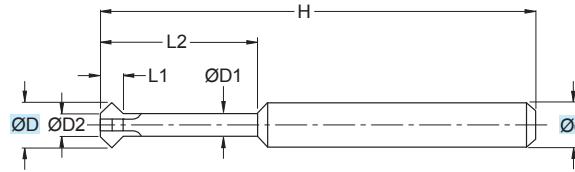

RIVESTIM. COATED	
BLACK	
45°	42 HRC

Fresa in M.D.I. Micrograno
 Gambo sec. DIN 6535 HB

Micrograin HM mills
 DIN 6535 HB Shank

TOLLERANZE	D	d
TOLERANCE RANGE	h12	h6

ART.	(mm)							
	ØD	Ød	ØD1	ØD2	H	L1	L2	Z
SMR0110040	4	4	2	0,5	100	2,75	15	4
SMR0110060	6	6	4	0,5	100	3,75	18	4
SMR0110080	8	8	5	0,5	100	5,25	24	4
SMR0110100	10	10	6	0,5	100	6,75	30	4
SMR0110120	12	12	7	1	100	8,00	36	4
SMR0110160	16	16	10	1	100	10,5	48	4

Applicazione - Application

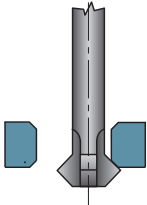

	MATERIALI - MATERIALS											(mm) ØD	(m/min) Vc	(mm) fz	(mm) ap	(mm) ae				
	P	M	K			N			S	H	G									
	ACCIAIO NON LEGATO NOT ALLOY STEEL	ACCIAIO POCO LEGATO LOW ALLOY STEEL	ACCIAIO ALTO LEGATO ALLOY STEEL	INOX MARTENSITICO STAINLESS STEEL MART.	INOX AUST. DUPLEX STAINLESS STEEL AUST.	GHISA GRIGIA GREY CAST IRON	GHISA SFEROIDALE SPHEROIDAL GRAPHITE	GHISA MALLEABILE MALLEABLE CAST IRON	ALLUMINIO E SUE LEGHE ALUMINIUM	RAME E SUE LEGHE COPPER	NON METALLICI PLASTICS	LEGHE RESIST. CALORE HIGH TEMP. ALLOY	TITANIO E SUE LEGHE TITANIUM	ACCIAIO TEMPRATO HARDENED STEEL	GRAFITE GRAPHITE					
●			●													4	60-90	0,030-0,045	-	-
●			●													6	60-90	0,030-0,045	-	-
●			●													8	60-90	0,030-0,045	-	-
●			●													10	60-90	0,030-0,045	-	-
●			●													12	60-90	0,030-0,045	-	-
●			●													16	60-90	0,030-0,045	-	-
					●											4	30-60	0,020-0,035	-	-
					●											6	30-60	0,020-0,035	-	-
					●											8	30-60	0,020-0,035	-	-
					●											10	30-60	0,020-0,035	-	-
					●											12	30-60	0,020-0,035	-	-
					●											16	30-60	0,020-0,035	-	-
							●									4	100-130	0,060-0,075	-	-
							●									6	100-130	0,060-0,075	-	-
							●									8	100-130	0,060-0,075	-	-
							●									10	100-130	0,060-0,075	-	-
							●									12	100-130	0,060-0,075	-	-
							●									16	100-130	0,060-0,075	-	-
									●							4	270-320	0,060-0,075	-	-
									●							6	270-320	0,060-0,075	-	-
									●							8	270-320	0,060-0,075	-	-
									●							10	270-320	0,060-0,075	-	-
									●							12	270-320	0,060-0,075	-	-
									●							16	270-320	0,060-0,075	-	-

● APPLICAZIONE CONSIGLIATA-RECOMMENDED APPLICATION
EMPFOLLENER EINSATZ - APPLICATION CONSEILLÉE

○ APPLICAZIONE POSSIBILE - POSSIBLE APPLICATION
MÖGLICHE ANWENDUNG - APPLICATION POSSIBLE

Vc = m/min VELOCITÀ DI TAGLIO - CUTTING SPEED

n = giri/min (min⁻¹) NUMERO DI GIRI - NUMBER OF REVOLUTIONS

fz = mm AVANZAMENTO AL DENTE -TOOTH FEED

fn = mm AVANZAMENTO AL GIRO - FEED / REVOLUTION

Vf = mm/min VELOCITÀ DI AVANZAMENTO - FEED SPEED

$$n = \frac{Vc \cdot 1000}{\text{ØD} \cdot 3,14} = \text{giri/min (min}^{-1}\text{)}$$

$$fn = fz \cdot z = \text{mm}$$

$$Vf = fz \cdot z \cdot n = \text{mm/min}$$

SS230

$\varnothing D = 3 - 20$

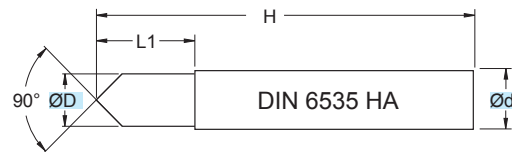

90°	ALU $\leq 5\% \text{ Si}$

Fresa in M.D.I. Micrograno
 Gambo cilindrico HA

Micrograin HM minimills
 Cylindrical Shank HA

TOLLERANZE	D	d
TOLLERANCE RANGE	h10	h6

ART.	(mm)					z
	$\varnothing D$	$\varnothing d$	L1	H		
SS230.030	3	4	6	50		2
SS230.040	4	5	8	50		2
SS230.050	5	6	10	50		2
SS230.060	6	8	12	60		2
SS230.080	8	10	16	70		2
SS230.100	10	12	18	70		2
SS230.120	12	12	20	70		2
SS230.160	16	16	26	80		2
SS230.200	20	20	32	100		2

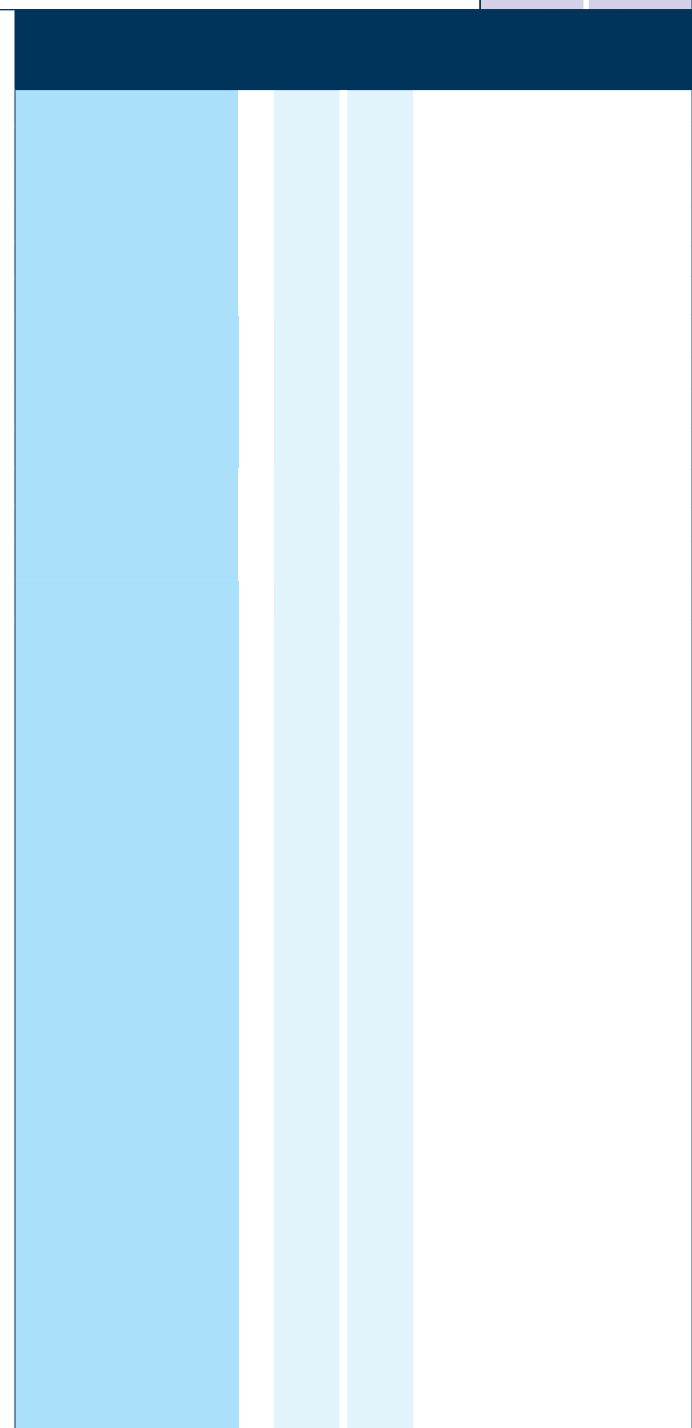

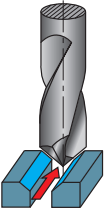
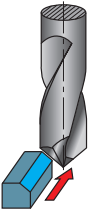
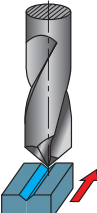
Applicazione - Application	MATERIALI - MATERIALS											(mm) ØD	(m/min) Vc	(mm) fz	(mm) ap	(mm) ae				
	P	M	K			N			S	H	G									
	ACCIAIO NON LEGATO NOT ALLOY STEEL	ACCIAIO POCO LEGATO LOW ALLOY STEEL	ACCIAIO ALTO LEGATO ALLOY STEEL	INOX MARTENSITICO STAINLESS STEEL-MART.	INOX AUST. DUPLEX STAINLESS STEEL-AUST.	GHISA GRIGIA GREY CAST IRON	GHISA SFEROIDALE SPHEROIDAL GRAPHITE	GHISA MALLEABILE MALLEABLE CAST IRON	ALLUMINIO Si ≤ 12% ALUMINIUM 12 ≤ 12%	ALLUMINIO Si > 12% ALUMINIUM 12 > 12%	NON METALLICI PLASTICS	LEGHE RESIST. CALORE HIGH TEMP. ALLOY	TITANIO E SUE LEGHE TITANIUM	ACCIAIO TEMPRATO HARDENED STEEL	GRAFITE GRAPHITE					
									●							3	350-470	0,020-0,035	-	-
									●							4	350-470	0,030-0,045	-	-
									●							5	350-470	0,040-0,055	-	-
									●							6	350-470	0,050-0,065	-	-
									●							8	350-470	0,070-0,085	-	-
									●							10	350-470	0,090-0,105	-	-
									●							12	350-470	0,110-0,125	-	-
									●							16	350-470	0,170-0,185	-	-
									●							20	350-470	0,190-0,205	-	-
									●							3	170-250	0,010-0,025	-	-
									●							4	170-250	0,020-0,035	-	-
									●							5	170-250	0,030-0,045	-	-
									●							6	170-250	0,040-0,055	-	-
									●							8	170-250	0,050-0,065	-	-
									●							10	170-250	0,070-0,085	-	-
									●							12	170-250	0,090-0,105	-	-
									●							16	170-250	0,150-0,165	-	-
									●							20	170-250	0,170-0,185	-	-
																				

● APPLICAZIONE CONSIGLIATA-RECOMMENDED APPLICATION
EMPFOLHENER EINSATZ - APPLICATION CONSEILLÉE

○ APPLICAZIONE POSSIBILE - POSSIBLE APPLICATION
MÖGLICHE ANWENDUNG - APPLICATION POSSIBLE

Vc = m/min VELOCITÀ DI TAGLIO - CUTTING SPEED

n = giri/min (min⁻¹) NUMERO DI GIRI - NUMBER OF REVOLUTIONS

fz = mm AVANZAMENTO AL DENTE -TOOTH FEED

fn = mm AVANZAMENTO AL GIRO - FEED / REVOLUTION

Vf = mm/min VELOCITÀ DI AVANZAMENTO - FEED SPEED

$$n = \frac{Vc \cdot 1000}{\text{ØD} \cdot 3,14} = \text{giri/min (min}^{-1}\text{)}$$

$$fn = fz \cdot z = \text{mm}$$

$$Vf = fz \cdot z \cdot n = \text{mm/min}$$

SM4701

ØD = 6 - 10

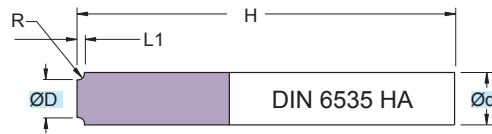

RIVESTIM. COATED BLACK	
R	42 HRC

Fresa in M.D.I. Micrograno
 Gambo cilindrico HA

Micrograin HM mills
 Cylindrical Shank HA

TOLLERANZE	D	d
TOLLERANCE RANGE	h10	h6

ART.	(mm)					
	ØD	Ød	L1	H	R	z
SM4701.080.R050	7	8	0,5	70	0,5	4
SM4701.080.R100	6	8	1,0	70	1,0	4
SM4701.100.R150	7	10	1,5	75	1,5	4
SM4701.100.R200	6	10	2,0	75	2,0	4
SM4701.120.R250	7	12	2,5	75	2,5	4
SM4701.120.R300	6	12	3,0	75	3,0	4
SM4701.160.R350	9	16	3,5	80	3,5	4
SM4701.160.R400	8	16	4,0	80	4,0	4
SM4701.160.R450	7	16	4,5	80	4,5	4
SM4701.200.R500	10	20	5,0	80	5,0	4
SM4701.200.R600	8	20	6,0	80	6,0	4

--	--	--	--	--	--	--

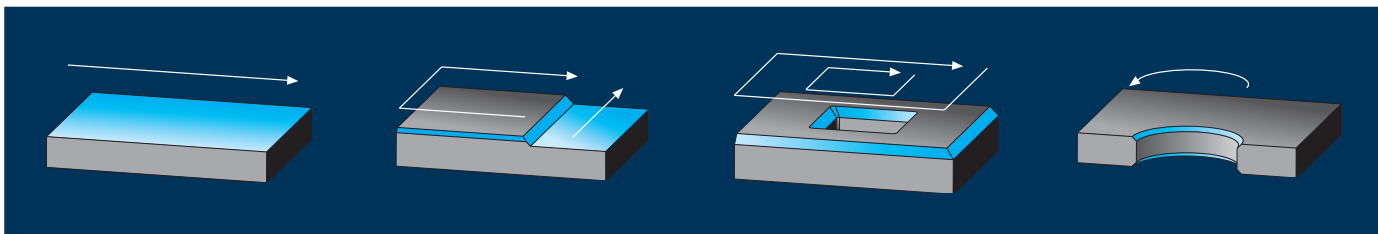

S676 Pag. 440		S678 Pag. 440		S614 Pag. 445		S614.9 Pag. 445	
	$\text{ØD} = 9 - 32$		$\text{ØD} = 9 - 32$		$\text{ØD} = 0$		$\text{ØD} = 0$
S 676W..	S 676XLZ ..	S 678W .. 12		S 614.45W-0-12	NEW SET	S 614.9.45W-0-12	
	45° SP..0603 SP..09T3 SP..1204	$h = 4,0$ $h = 5,8$ $h = 8,0$			43° SC..1204	$h = 7,8$	
S616 Pag. 441							
	$\text{ØD} = 16$		$\text{ØD} = 1,2 - 25$		$\text{ØD} = 5,4 - 17$		
S 616.30 ..	S 616.45 .. S 6165XLZ.4 ..	S 616.60 .. S 616XLZ.60 ..					
	30° 45° 60° TC..1102 TC..16T3 TC..2204	$h = 6,9/9,0$ $h = 7,3/13,0$ $h = 13,8$					
S618.3 Pag. 442		S618.4 Pag. 443					
	$\text{ØD} = 4,9 - 23,8$		$\text{ØD} = 7,8 - 27,2$				
S 618 ..11.3 S 618 ..16.3		S 618 ..12.4					
	10°-80° TC..1102 TC..16T3		10°-80° SC..1204				
S613 Pag. 444		S613.9 Pag. 444					
	$\text{ØD} = 0$		$\text{ØD} = 0$				
S 613.45W-0-16	NEW SET	S 613.9.45W-0-16					
	45° TC..16T3	$h = 10$					

S 438 .. 13
S 438W .. 13
S 438WF .. 13
S 438G .. 13

Ø 50-250

γ_p +20°/+22,5°
 γ_f -15°/-10°
 γ_o +4°/+10°

ISO 6462 ...

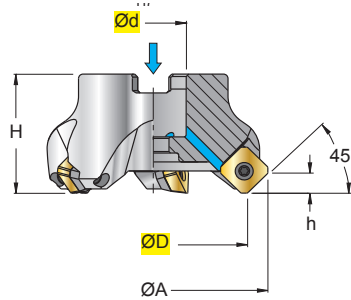
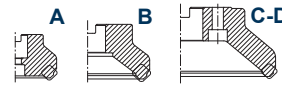

SEEX 13T3.. .M12	
SEHT 13T3.. .F44P	
SEKT 13T3.. .F53	
SEKT 13T3.. .F58	
SEKW 13T3.. .F51	
SEKX 1305.. .Z52	

GLI ARTICOLI CON DIAMETRO ≥ 160mm SONO SPROVVISTI DI FORI PER ADDUZIONE REFRIGERANTE INTERNA
 ITEMS WITH DIAMETER ≥ 160mm ARE NOT EQUIPPED WITH INTERNAL COOLING BORE
 ARTIKEL MIT DURCHMESSER ≥ 160mm SIND NICHT MIT INNENKÜHLBOHRUNG AUSGESTATTET
 LES ARTICLES AVEC DIAMETRE ≥ 160 mm SONT DEPOURVUS DE TROUS POUR L'ARROSAGE DU LIQUIDE REFRIGERANT INTERNE

INSERTI - INSERTS
PAG. 532

ART.	(mm)										ISO 6462		Tools							
	ØD	Ød	ØA	H	h	Z	kg	Nm	ISO 6462	ISO 6462	PA13M	BCL7	123512P	5035	5615P	AL10x30				
S 438W 050 - 13	50	22	63	40	6	4	Y	0,37	3,0+3,5	A	13T3	13T3	PA13M	BCL7	123512P	5035	5615P	AL10x30		
S 438W 063 - 13	63	22	76	40	6	5	Y	0,56	3,0+3,5	A	13T3	13T3	PA13M	BCL7	123512P	5035	5615P	AL12x35		
S 438W 080 - 13	80	27	93	50	6	6	Y	1,06	3,0+3,5	A-B	13T3	13T3	PA13M	BCL7	123512P	5035	5615P	AL16x35		
S 438W 100 - 13	100	32	113	50	6	7	Y	1,67	3,0+3,5	A-B	13T3	13T3	PA13M	BCL7	123512P	5035	5615P	AL20x45		
S 438W 125 - 13	125	40	138	63	6	8	Y	3,13	3,0+3,5	A-B	13T3	13T3	PA13M	BCL7	123512P	5035	5615P	-		
S 438 160 - 13	160	40	173	63	6	10	Y	4,16	3,0+3,5	C	13T3	13T3	PA13M	BCL7	123512P	5035	5615P	-		
S 438 200 - 13	200	60	213	63	6	12	-	6,81	3,0+3,5	D	13T3	13T3	PA13M	BCL7	123512P	5035	5615P	-		
S 438 250 - 13	250	60	263	63	6	14	-	9,68	3,0+3,5	D	13T3	13T3	PA13M	BCL7	123512P	5035	5615P	-		
S 438WF 050 - 13	50	22	63	40	6	5	-	0,36	3,0+3,5	A	13T3	13T3	PA13M	BCL7	123512P	5035	5615P	AL10x30		
S 438WF 063 - 13	63	22	76	40	6	6	-	0,56	3,0+3,5	A	13T3	13T3	PA13M	BCL7	123512P	5035	5615P	AL12x35		
S 438WF 080 - 13	80	27	93	50	6	8	-	1,03	3,0+3,5	A-B	13T3	13T3	PA13M	BCL7	123512P	5035	5615P	AL16x35		
S 438WF 100 - 13	100	32	113	50	6	10	-	1,61	3,0+3,5	A-B	13T3	13T3	PA13M	BCL7	123512P	5035	5615P	AL20x45		
S 438WF 125 - 13	125	40	138	63	6	12	-	3,06	3,0+3,5	A-B	13T3	13T3	PA13M	BCL7	123512P	5035	5615P	-		
S 438G 160 - 13	160	40	173	63	6	7	Y	4,32	3,0+3,5	C	13T3	13T3	PA13M	BCL7	123512P	5035	5615P	-		
S 438G 200 - 13	200	60	213	63	6	8	Y	7,01	3,0+3,5	B	13T3	13T3	PA13M	BCL7	123512P	5035	5615P	-		
S 438G 250 - 13	250	60	263	63	6	10	Y	9,88	3,0+3,5	D	13T3	13T3	PA13M	BCL7	123512P	5035	5615P	-		

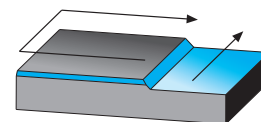
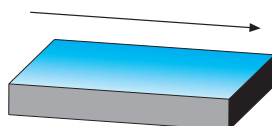

F = PASSO FINE - FINE PITCH - FEINE ZAHNTEILUNG - PAS FIN
 = PASSO DIFFERENZIATO - DIFFERENTIAL PITCH - UNGLEICHE TEILUNG - PAS DIFFERENCIE

SCelta VELOCE - QUICK PICK		Tenacità + ↑		Toughness - ↓		Pag. 538		HT	HW	HC						SEEX..			SEHT..							
		CERMET		NON RIV. COATED		RIVESTITI COATED GRADES BESCHICHTET RECOUVERTS						DT63	N3005	N3815	F2135	F2540	F3120	T1120	T528N	F1325	F1335	l	d	s	d1	r
SEEX	13T3 AGTR .M12	●																			8,2	13,4	3,97	4,1	1,5	20
SEHT	13T3 AZFN .F44P																				13,4	13,4	3,97	4,2	-	20
SEKT	13T3 AFEN .F53																				13,4	13,4	3,97	4,2	-	20
SEKT	13T3 AFSN .F58																				13,4	13,4	3,97	4,2	-	20
SEKW	13T3 AFSN .F51																				13,4	13,4	3,97	4,2	-	20
SEKX	1305 AGSR .Z52																				3,9	15,17	5,58	4,1	1,0	20

! - CON INSERTI SEKX 1305.. Z52 PROFONDITÀ MASSIMA DI LAVORO = 2 (mm) PER ALTI AVANZAMENTI
! - WITH INSERTS SEKX 1305.. Z52 MAXIMUM MACHINING DEPTH = 2 (mm) FOR HIGH FEED
PROFONDITÀ MASSIMA DI LAVORO = 6 (mm) PER AVANZAMENTI STANDARD
MAXIMUM MACHINING DEPTH = 6 (mm) FOR STANDARD FEED

MATERIALI - MATERIALS		VDI 3323 GR.	HB Rm1) HRC2)	fz0 mm			Vc m/min						Pag. 552		
Pag. 1199				F	M	R	N3815	F3120	F1325	F1335	F2135	F2540	T1120		
P	ACCIAIO NON LEGATO - NOT ALLOY STEEL	1--5	125-300	0,12	0,15	0,19		200	240	220			250		
	ACCIAIO POCO LEGATO - LOW ALLOY STEEL	6--9	180-350	0,12	0,15	0,19		180	190	180			200		
	ACCIAIO ALTO LEGATO - ALLOY STEEL	10-11	200-325	0,12	0,15	0,19		160	150	160			180		
	INOX MARTENS. - STAINLESS STEEL MART	12-13	200-240	0,12	0,15	0,19		120	150				140		
M	INOX AUST. DUPLEX - STAINLESS STEEL AUST	14.1-14.2	180-230	0,1	0,15	0,17			100	90	120	100			
	GHISA GRIGIA - GREY CAST IRON	15-16	180-260	0,1	0,15	0,19		280	250						
	GHISA SFEROIDALE - SPHEROIDAL GRAPHITE	17-18	160-250	0,1	0,15	0,19		260	220						
K	GHISA MALLEABILE - MALLEABLE CAST IRON	19-20	130-230	0,1	0,15	0,19		240	140						
	ALLUMINIO E SUE LEGHE - ALUMINIUM	21--25	60-130	0,1	0,13	0,16	700								
	RAME E SUE LEGHE - COPPER	26--28	90-110	0,1	0,13	0,16	280								
N	NON METALLICI - PLASTICS	29-30	/	0,1	0,13	0,16	280								
	LEGHE RESIST. CALORE - HIG. TEMP. ALLOY	31--35	200-320	0,08	0,14						50				
S	TITANIO E SUE LEGHE - TITANIUM	36-37	400-1050 ¹⁾	0,08	0,14						45				
	ACCIAIO TEMPRATO - HARDENED STEEL	38--41	45-60 ²⁾												

$$n = \frac{Vc \cdot 1000}{\phi D \cdot 3,14} = \text{giri/min (min}^{-1}\text{)}$$

$$fz = fz0 \cdot Kae = \text{mm}$$

$$fn = fz \cdot z = \text{mm}$$

$$Vf = fz \cdot z \cdot n = \text{mm/min}$$

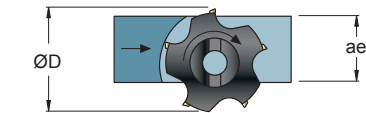

ae/D	0,5-1 50-100%	0,2 20%	0,1 10%	0,05 5%	0,02 2%
Kae	1	1,1	1,2	1,3	1,5

ae/D	0,5-1 50-100%	0,2 20%	0,1 10%	0,05 5%
Vc	Vc (min)-----Vc (max)			

F = FINITURA , LAV. LEGGERA - FINISHING , LIGHT MACHINING
M = LAV. MEDIA , GENERICA - MEDIUM MACHINING , GENERIC
R = SGROSSATURA , LAV. PESANTE - ROUGHING , HEAVY MACHINING

Vc = m/min VELOCITÀ DI TAGLIO - CUTTING SPEED
n = giri/min (min⁻¹) NUMERO DI GIRI - NUMBER OF REVOLUTIONS
fz = mm AVANZAMENTO AL DENTE - TOOTH FEED
fn = mm AVANZAMENTO AL GIRO - FEED / REVOLUTION
Vf = mm/min VELOCITÀ DI AVANZAMENTO - FEED SPEED
Kae = FATTORE DI CORREZIONE - CORRECTION FACTOR

MATERIALI MATERIALS pag. 1199	P		M		K		S				
	ACCIAIO NON LEGATO NOT ALLOY STEEL	ACCIAIO POCO LEGATO LOW ALLOY STEEL	ACCIAIO ALTO LEGATO ALLOY STEEL	INOX MARTENSITICO STAINLESS STEEL MART	INOX AUST. DUPLEX STAINLESS STEEL AUST	GHISA GRIGIA GREY CAST IRON	GHISA SFEROIDALE SPHEROIDAL GRAPHITE	GHISA MALLEABILE MALLEABLE CAST IRON	LEGHE RESIST. CALORE HIG. TEMP. ALLOY TITANIO E SUE LEGHE TITANIUM		
ALTI AVANZAMENTI HIGH FEED	fz0 mm ap<2	0,2-0,6	0,2-0,5	0,2-0,4	0,2-0,4	0,2-0,5	0,2-0,6	0,2-0,6	0,2-0,6	0,1-0,4	0,1-0,4
AVANZAMENTI STAND. STANDARD FEED	fz0 mm ap>2	0,25	0,25	0,25	0,25	0,25	0,25	0,25	0,25		
VELOCITÀ DI TAGLIO CUTTING SPEED	Vc m/min	100-220	80-220	80-180	70-180	60-200	80-180	70-160	70-170	20-60	40-70

S 4501-8W .. 12N

Ø 50-250

γ_p -6°
 γ_f -9°/-2°
 γ_o -11°/-6°

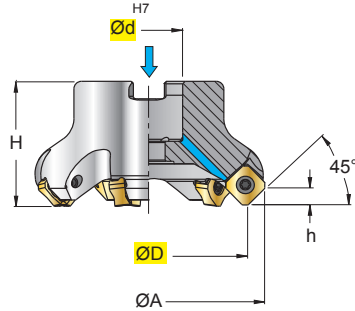
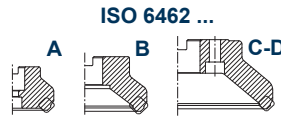

SNEX 1206NN .K11	
SNCX 1206ANFN .F57P	
SNMX 1206NN .F51	
SNMX 1206NN .F52	
SNMX 1206NN .F53	
SNMX 1206NN .F58	
SNMX 120612 .F51	
SNMX 120612 .F58	

INSERTI - INSERTS
PAG. 533

ART.	(mm)						Z		kg	Nm	ISO 6462				
	ØD	Ød	ØA	H	h	Z									
S 4501-8W-050-04-12N	50	22	63,4	40	6	4	-	0,41	3,8÷5	A	1206	124011P	5620P	AL10x30	
S 4501-8W-050-06-12N	50	22	63,4	40	6	6	-	0,41	3,8÷5	A					
S 4501-8W-063-05-12N	63	22	76,4	40	6	5	-	0,61	3,8÷5	A					
S 4501-8W-063-06-12N	63	22	76,4	40	6	6	-	0,55	3,8÷5	A					
S 4501-8W-063-08-12N	63	22	76,4	40	6	8	-	0,55	3,8÷5	A					
S 4501-8W-080-06-12N	80	27	93,4	50	6	6	-	0,99	3,8÷5	A	1206	124011P	5620P	AL12x35	
S 4501-8W-080-07-12N	80	27	93,4	50	6	7	-	0,98	3,8÷5	A					
S 4501-8W-080-10-12N	80	27	93,4	50	6	10	-	0,98	3,8÷5	A					
S 4501-8W-100-08-12N	100	32	113,4	50	6	8	-	1,60	3,8÷5	A	1206	124011P	5620P	AL16x35	
S 4501-8W-100-12-12N	100	32	113,4	50	6	12	-	1,60	3,8÷5	A					
S 4501-8W-125-08-12N	125	40	138,4	63	6	8	-	3,31	3,8÷5	A	1206	124011P	5620P	AL20x45	
S 4501-8W-125-10-12N	125	40	138,4	63	6	10	-	3,25	3,8÷5	A					
S 4501-8W-125-16-12N	125	40	138,4	63	6	16	-	3,26	3,8÷5	A					
S 4501-8-160-10-12N	160	40	173,4	63	6	10	-	4,17	3,8÷5	C					
S 4501-8-160-12-12N	160	40	173,4	63	6	12	-	4,14	3,8÷5	C					
S 4501-8-160-20-12N	160	40	173,4	63	6	20	-	4,16	3,8÷5	C					
S 4501-8-200-18-12N	200	60	213,4	63	6	18	-	6,69	3,8÷5	D					
S 4501-8-200-26-12N	200	60	213,4	63	6	26	-	6,81	3,8÷5	D					
S 4501-8-250-20-12N	250	60	263,4	63	6	20	-	9,40	3,8÷5	D					
S 4501-8-250-30-12N	250	60	263,4	63	6	30	-	9,51	3,8÷5	D					

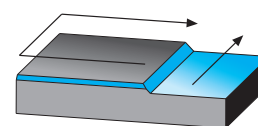
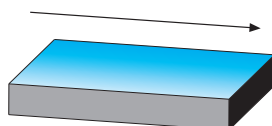

F = PASSO FINE - FINE PITCH - FEINE ZAHNTEILUNG - PAS FIN
 = PASSO DIFFERENZIATO - DIFFERENTIAL PITCH - UNGLEICHE TEILUNG - PAS DIFFERENCIE

S 4502-8W .. 05

Ø 50-125

γ_p -6°
 γ_f -9°/-4°
 γ_o -11°/-7°

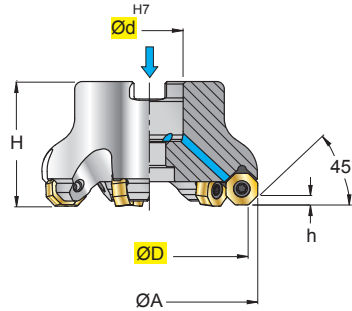
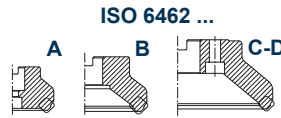

ONMU 050608SN .F51	
ONMU 050608SN .F53	
ONMU 050608SN .F55	
ONMU 050608SN .F58	

INSERTI - INSERTS
 PAG. 529

ART.	(mm)						Z	kg	Nm	ISO 6462				
	ØD	Ød	ØA	H	h	↻								
S 4502-8W-050-04-05	50	22	57,7	40	3	4	0,38	3,8+5	A	0506	124011P	5620P	AL10x30	
S 4502-8W-050-06-05	50	22	57,7	40	3	6	0,39	3,8+5	A					
S 4502-8W-063-06-05	63	22	70,7	40	3	6	0,52	3,8+5	A					
S 4502-8W-063-08-05	63	22	70,7	40	3	8	0,53	3,8+5	A					
S 4502-8W-080-07-05	80	27	87,6	50	3	7	1,03	3,8+5	A-B	0506	124011P	5620P	AL12x35	
S 4502-8W-080-10-05	80	27	87,6	50	3	10	1,04	3,8+5	A-B					
S 4502-8W-100-08-05	100	32	107,6	50	3	8	1,66	3,8+5	A-B	0506	124011P	5620P	AL16x35	
S 4502-8W-100-12-05	100	32	107,6	50	3	12	1,68	3,8+5	A-B					
S 4502-8W-125-10-05	125	40	132,6	63	3	10	3,50	3,8+5	A-B	0506	124011P	5620P	AL 20x45	
S 4502-8W-125-16-05	125	40	132,6	63	3	16	3,50	3,8+5	A-B					

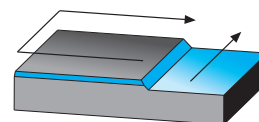
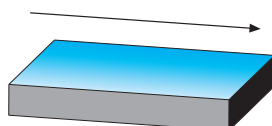

W = FORO PER LIQUIDO REFRIGERANTE - COOLANT BORE - KÜHLMITTELBOHRUNG - TROU DU LIQUIDE D'ARROSAGE
 = PASSO DIFFERENZIATO - DIFFERENTIAL PITCH - UNGLEICHE TEILUNG - PAS DIFFERENCE

SCELTA VELOCE - QUICK PICK

Tenacità + ↑

Toughness - ↓

Pag. 538

HT

CERMET

HW

NON RIV. CEMENTED CARBIDE GRADES

HC

RIVESTITI COATED GRADES BESCHICHTET RECOUVERTS

COD.	P			M			K			N			S			H			l	d	s	d1	r	a°			
	F	M	R	F	M	R	F	M	R	F	M	R	F	M	R	F	M	R									
ONMU 050608SN .F51	○	○																				5,24	12,7	5,8	5,45	0,8	-
ONMU 050608SN .F53																						5,24	12,7	5,8	5,45	0,8	-
ONMU 050608SN .F55		●	●	○	○																	5,24	12,7	5,8	5,45	0,8	-
ONMU 050608SN .F58	○	●	●	○	○	○	○	○	○													5,24	12,7	5,8	5,45	0,8	-

⚠ - COME OPZIONE SI POSSONO MONTARE GLI INSERTI **SNMX**. DA TENERE PRESENTE CHE DIAMETRO E ALTEZZA CON QUESTI INSERTI SARANNO DIVERSI: **ØD** DIMINUIRÀ DI CIRCA **2,9 mm** MENTRE QUOTA **H** AUMENTERÀ DI CIRCA **1,45 mm**

⚠ - **SNMX** INSERTS CAN BE OPTIONALLY USED. PLEASE NOTE THAT WITH THESE INSERTS DIAMETER AND HEIGHT WILL CHANGE: **ØD** WILL DECREASE BY AROUND **2,9 mm** AND **H** WILL INCREASE BY AROUND **1,45 mm**

CON ADDUZIONE LUBROREFRIGERANTE - WITH COOLANT SUPPLY	
SENZA ADDUZIONE LUBROREFRIGERANTE - WITHOUT COOLANT SUPPLY	

MATERIALI - MATERIALS Pag. 1199		VDI 3323 GR.	HB Rm1) HRC2)	fz0 mm			Vc m/min Pag. 552								
				F	M	R	F7810	F3120	F1325	F1335	F2135	F2540			
P	ACCIAIO NON LEGATO - NOT ALLOY STEEL	1-5	125-300	0,16	0,22	0,3	270	250	240	220					
	ACCIAIO POCO LEGATO - LOW ALLOY STEEL	6-9	180-350	0,16	0,22	0,3	230	200	190	180					
	ACCIAIO ALTO LEGATO - ALLOY STEEL	10-11	200-325	0,16	0,22	0,3	200	190	150	160					
	INOX MARTENS. - STAINLESS STEEL MART	12-13	200-240	0,16	0,22	0,3		150	150						
M	INOX AUST. DUPLEX - STAINLESS STEEL AUST	14.1-14.2	180-230	0,12	0,18	0,25	120		100	90	120	100			
	GHISA GRIGIA - GREY CAST IRON	15-16	180-260	0,2	0,25	0,35	280	230	250						
	GHISA SFEROIDALE - SPHEROIDAL GRAPHITE	17-18	160-250	0,2	0,25	0,35	250	170	220						
K	GHISA MALLEABILE - MALLEABLE CAST IRON	19-20	130-230	0,2	0,25	0,35	250	150	140						
	ALLUMINIO E SUE LEGHE - ALUMINIUM	21-25	60-130												
	RAME E SUE LEGHE - COPPER	26-28	90-110												
N	NON METALLICI - PLASTICS	29-30	/												
	LEGHE RESIST. CALORE - HIG. TEMP. ALLOY	31-35	200-320	0,1	0,13	0,2					50				
S	TITANIO E SUE LEGHE - TITANIUM	36-37	400-1050 ¹⁾	0,1	0,13	0,2					45				
	ACCIAIO TEMPRATO - HARDENED STEEL	38-41	45-60 ²⁾	0,1	0,16	0,26	75								

$$n = \frac{Vc \cdot 1000}{\phi D \cdot 3,14} = \text{giri/min (min}^{-1}\text{)}$$

$$fz = fz0 \cdot Kae = \text{mm}$$

$$fn = fz \cdot z = \text{mm}$$

$$Vf = fz \cdot z \cdot n = \text{mm/min}$$

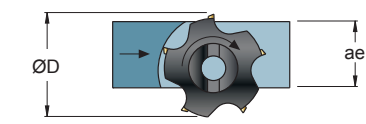

ae/D	0,5-1 50-100%	0,2 20%	0,1 10%	0,05 5%	0,02 2%
Kae	1	1,1	1,2	1,3	1,5

ae/D	0,5-1 50-100%	0,2 20%	0,1 10%	0,05 5%
Vc Pag. 552	Vc (min)-----Vc(max)			

- F** = FINITURA, LAV. LEGGERA - FINISHING, LIGHT MACHINING
M = LAV. MEDIA, GENERICA - MEDIUM MACHINING, GENERIC
R = SGROSSATURA, LAV. PESANTE - ROUGHING, HEAVY MACHINING
- Vc** = m/min VELOCITÀ DI TAGLIO - CUTTING SPEED
n = giri/min (min⁻¹) NUMERO DI GIRI - NUMBER OF REVOLUTIONS
fz = mm AVANZAMENTO AL DENTE - TOOTH FEED
fn = mm AVANZAMENTO AL GIRO - FEED / REVOLUTION
Vf = mm/min VELOCITÀ DI AVANZAMENTO - FEED SPEED
Kae = FATTORE DI CORREZIONE - CORRECTION FACTOR

LATO A - SIDE A

LATO B - SIDE B

- 16 Taglienti "Utili" disponibili grazie all'inserto bilaterale.
- 16 "Useful" cutting-edges thanks to two-sided insert
- 16 "Nützliche" schneidkanten dank zweiseitiger wendeschneidplatten
- 16 Tranchants "Utiles" disponibles grace a la plaquette bilaterale

S 8801-8 .. 12
S 8801-8W .. 12

Ø 50-250

γ_p -6°
 γ_f -8°/-5,5°
 γ_o -8°/-5,5°

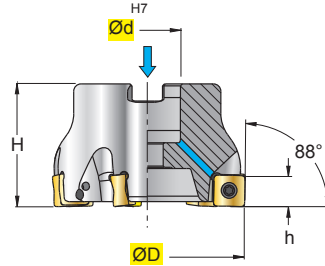
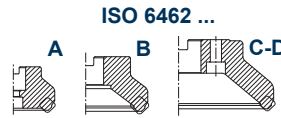

SNMX 1206QNN .F51	
SNMX 1206QNN .F53	
SNMX 1206QNN .F58	
SNMX 120612 .F51	
SNMX 120612 .F58	
INSERTI - INSERTS PAG. 533	

ART.	(mm)								ISO 6462				
	ØD	Ød	H	h	Z								
S 8801-8W-050-04-12	50	22	40	11,5	4	-	0,27	3,8÷5	A	1206	124011P	5620P	VBSF10
S 8801-8W-063-06-12	63	22	40	11,5	6	-	0,46	3,8÷5	A				
S 8801-8W-080-07-12	80	27	50	11,5	7	-	0,94	3,8÷5	A	1206	124011P	5620P	AL12x35
S 8801-8W-080-09-12	80	27	50	11,5	9	-	0,92	3,8÷5	A				
S 8801-8W-100-08-12	100	32	50	11,5	8	-	1,63	3,8÷5	A-B	1206	124011P	5620P	AL16x35
S 8801-8W-100-11-12	100	32	50	11,5	11	-	1,59	3,8÷5	A-B				
S 8801-8W-125-10-12	125	40	63	11,5	10	-	3,05	3,8÷5	A-B	1206	124011P	5620P	AL20x45
S 8801-8W-125-14-12	125	40	63	11,5	14	-	2,99	3,8÷5	A-B				
S 8801-8-160-12-12	160	40	63	11,5	12	-	4,00	3,8÷5	C	1206	124011P	5620P	-
S 8801-8-160-18-12	160	40	63	11,5	18	-	3,91	3,8÷5	C				
S 8801-8-200-14-12	200	60	63	11,5	14	-	6,61	3,8÷5	D				
S 8801-8-200-22-12	200	60	63	11,5	22	-	6,48	3,8÷5	D				
S 8801-8-250-16-12	250	60	63	11,5	16	-	9,68	3,8÷5	D				
S 8801-8-250-24-12	250	60	63	11,5	24	-	9,52	3,8÷5	D				

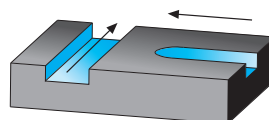

SCELTA VELOCE - QUICK PICK

Tenacità + ↑

Toughness - ↓

Pag. 538

COD.	P M K N S H												HT	HW	HC					l	d	s	d1	r	a°					
	F M R			F M R			F M R			F M R			F M R			F M R			F2540							T3116	F3120	T1730	F1335	
	F	M	R	F	M	R	F	M	R	F	M	R	F	M	R	F	M	R												
SNMX 1206QNN .F51		○	○																						12,7	12,7	6,35	5,4	0,8	-
SNMX 1206QNN .F53				●	●																				12,7	12,7	6,35	5,4	0,8	-
SNMX 1206QNN .F58	●	●			○	○																			12,7	12,7	6,35	5,4	0,8	-
SNMX 120612 .F51							●	●																	12,7	12,7	6,35	5,4	1,2	-
SNMX 120612 .F58	●	●			○	○																			12,7	12,7	6,35	5,4	1,2	-

CON ADDUZIONE LUBROREFRIGERANTE - WITH COOLANT SUPPLY

SENZA ADDUZIONE LUBROREFRIGERANTE - WITHOUT COOLANT SUPPLY

MATERIALI - MATERIALS Pag. 1199		VDI 3323 GR.	HB Rm1) HRC2)	fz0 mm			Vc m/min Pag. 552							
				F	M	R	T3116	F3120	T1730	F1335	F2540			
P	ACCIAIO NON LEGATO - NOT ALLOY STEEL	1-5	125-300	0,12	0,25	0,35		200	230	220				
	ACCIAIO POCO LEGATO - LOW ALLOY STEEL	6-9	180-350	0,1	0,2	0,3		180	190	180				
	ACCIAIO ALTO LEGATO - ALLOY STEEL	10-11	200-325	0,1	0,2	0,3		160	165	160				
	INOX MARTENS. - STAINLESS STEEL MART	12-13	200-240	0,08	0,15	0,25		120	150					
M	INOX AUST. DUPLEX - STAINLESS STEEL AUST	14.1-14.2	180-230	0,06	0,10	0,15				90	100			
	GHISA GRIGIA - GREY CAST IRON	15-16	180-260	0,12	0,3	0,4	310	280						
	GHISA SFEROIDALE - SPHEROIDAL GRAPHITE	17-18	160-250	0,12	0,25	0,35	180	260						
K	GHISA MALLEABILE - MALLEABLE CAST IRON	19-20	130-230	0,12	0,25	0,35	280	240						
	ALLUMINIO E SUE LEGHE - ALUMINIUM	21-25	60-130											
	RAME E SUE LEGHE - COPPER	26-28	90-110											
N	NON METALLICI - PLASTICS	29-30	/											
	LEGHE RESIST. CALORE - HIG. TEMP. ALLOY	31-35	200-320											
S	TITANIO E SUE LEGHE - TITANIUM	36-37	400-1050 ¹⁾											
	ACCIAIO TEMPRATO - HARDENED STEEL	38-41	45-60 ²⁾											

$$n = \frac{Vc \cdot 1000}{\varnothing D \cdot 3,14} = \text{giri/min (min}^{-1}\text{)}$$

$$fz = fz0 \cdot Kae = \text{mm}$$

$$fn = fz \cdot z = \text{mm}$$

$$Vf = fz \cdot z \cdot n = \text{mm/min}$$

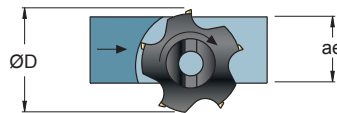

ae/D	0,5-1 50-100%	0,2 20%	0,1 10%	0,05 5%	0,02 2%
Kae	1	1,1	1,2	1,3	1,5

ae/D	0,5-1 50-100%	0,2 20%	0,1 10%	0,05 5%
Vc Pag. 552	Vc (min)-----Vc(max)			





- F** = FINITURA, LAV. LEGGERA - FINISHING, LIGHT MACHINING
M = LAV. MEDIA, GENERICA - MEDIUM MACHINING, GENERIC
R = SGROSSATURA, LAV. PESANTE - ROUGHING, HEAVY MACHINING





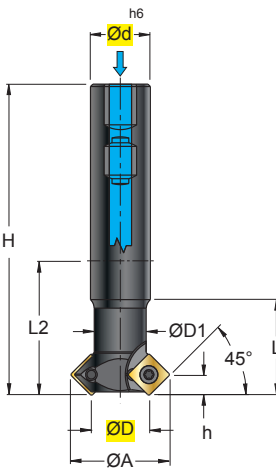
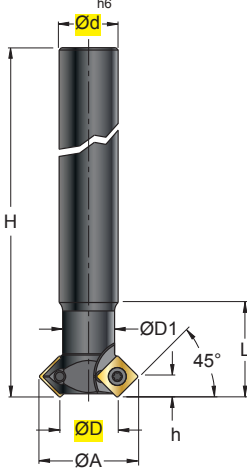
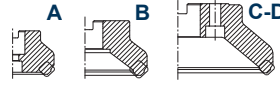

- Vc** = m/min VELOCITÀ DI TAGLIO - CUTTING SPEED
n = giri/min (min⁻¹) NUMERO DI GIRI - NUMBER OF REVOLUTIONS
fz = mm AVANZAMENTO AL DENTE - TOOTH FEED
fn = mm AVANZAMENTO AL GIRO - FEED / REVOLUTION
Vf = mm/min VELOCITÀ DI AVANZAMENTO - FEED SPEED
Kae = FATTORE DI CORREZIONE - CORRECTION FACTOR

LATO A - SIDE A

LATO B - SIDE B

- 8 Taglienti "Utili" disponibili grazie all'inserto bilaterale.
- 8 "Useful" cutting-edges thanks to two-sided insert
- 8 "Nützliche" schneidkanten dank zweiseitiger wendeschneidplatten
- 8 Tranchants "Utiles" disponibles grace a la plaquette bilaterale

S 676W ..	S 676XLZ ..	S 678W .. 12	SPMTN54	
Ø 09-032	Ø 09-032	Ø 040-050	SPMWN51	
		ISO 6462 ... 	SPMWN59	
			 INSERTI - INSERTS PAG. 535	

(mm)																			
ART.	ØD	Ød	ØD1	ØD2	ØA	H	h	L	L2	Z		kg	Nm 	ISO 6462					
S 676W	009 - 06	9	16	9	-	17,0	90	4,0	29	42	1	/	0,107	1,1+1,3	-	060304	12256P	5608P	-
S 676W	016 - 09	16	20	16	-	28,0	110	5,8	42	60	2	-	0,209	3,0+3,5	-	09T308	123509P	5615P	-
S 676W	025 - 12	25	25	22	-	41,5	130	8	40	74	2	-	0,434	4,0+5,0	-	120408	124510P	5620P	-
S 676W	032 - 12	32	32	30	-	48,5	130	8	50	70	3	-	0,716	4,0+5,0	-				
S 676XLZ	009 - 06	9	16	9	-	17,0	150	4,0	29	-	1	/	0,205	1,1+1,3	-	060304	12256P	5608P	-
S 676XLZ	016 - 09	16	20	16	-	28,0	200	5,8	42	-	2	-	0,444	3,0+3,5	-	09T308	123509P	5615P	-
S 676XLZ	025 - 12	25	25	22	-	41,5	200	8	40	-	2	-	0,723	4,0+5,0	-	120408	124510P	5620P	-
S 676XLZ	032 - 12	32	32	30	-	48,5	250	8	50	-	3	-	1,491	4,0+5,0	-				
S 678W	040 - 12	40	22	-	40	56,0	40	8	-	-	4	-	0,252	4,0+5,0	A	120408	124510P	5620P	VBSF10
S 678W	050 - 12	50	22	-	48	66,0	40	8	-	-	5	-	0,403	4,0+5,0	A				

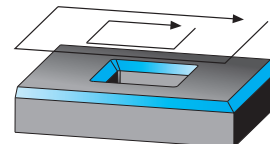
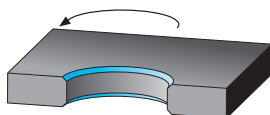

W = FORO PER LIQUIDO REFRIGERANTE - COOLANT BORE - KÜHLMITTELBOHRUNG - TROU DU LIQUIDE D'ARROSAGE
 XLZ = EXTRALUNGA, STELO CILINDRICO - EXTRALONG, CYLINDRICAL SHANK - EXTRALANG, ZYLINDERSCHAFT - EXTRALONGUE, QUEUE CYLINDRIQUE
 ↻ = PASSO DIFFERENZIATO - DIFFERENTIAL PITCH - UNGLEICHE TEILUNG - PAS DIFFERENCIE

S 616.30 ..		S 616.45 .. S 616XLZ ..		S 616.60 ..		TCMT 110204 .G39	
Ø 16	$\gamma_p +10^\circ$ $\gamma_f 0^\circ$ $\gamma_o +5^\circ$	Ø 1,2-25	$\gamma_p +29,5^\circ/+6^\circ$ $\gamma_f -15^\circ/-5^\circ$ $\gamma_o -15^\circ/+1^\circ$	Ø 5,4-17	$\gamma_p +8,5^\circ/+4^\circ$ $\gamma_f -15^\circ/-7^\circ$ $\gamma_o -0,5^\circ/0^\circ$	TCMTS42	
						TCMTG52	
						TCMT 220408 EN .E52	
INSERTI - INSERTS PAG. 535							

(mm)																
ART.	ØD	Ød	ØA	H	h	L	L2	Z		kg	Nm					
S616.30-16-16 (**)	16,0	25	42,5	95	7,5	39	39	3	-	0,420	3,8+5,0	16T3	1240P	5615P		
S616.45-1,2-11 (*)	1,2	12	15,0	70	6,9	25	25	1	/	0,060	1,1+1,3	1102	12256P	5608P		
S616.45-3,5-11 (*)	3,5	12	16,0	70	6,0	25	25	1	/	0,060	1,1+1,3					
S616.45-6,2-11 (*)	6,2	16	21,0	80	7,3	27	32	2	-	0,120	1,1+1,3					
S616.45-10,4-16 (**)	10,4	25	32,0	95	10,8	39	39	2	-	0,352	3,8+5,0	16T3	1240P	5615P		
S616.45-25-22 (***)	25,0	32	53,0	110	13,8	40	50	3	-	0,694	4,0+5,0	2204	124510P	5620P		
S616XLZ.45-6,2-11 (*)	6,2	16	21,0	150	7,3	27	-	2	-	0,231	1,1+1,3	1102	12256P	5608P		
S616XLZ.45-10,4-16 (**)	10,4	25	32,0	150	10,8	39	-	2	-	0,519	3,8+5,0	16T3	1240P	5615P		
S616.60-5,4-11 (*)	5,4	12	16,0	70	9,0	25	25	1	-	0,060	1,1+1,3	1102	12256P	5608P		
S616.60-14,4-11 (*)	14,4	16	24,0	80	8,5	27	32	2	-	0,140	1,1+1,3					
S616.60-17-16 (**)	17,0	25	32,0	95	13,0	39	39	2	-	0,326	3,8+5,0	16T3	1240P	5615P		
S616XLZ.60-14,4-11 (*)	14,4	16	24,0	150	8,5	27	-	2	-	0,248	1,1+1,3	1102	12256P	5608P		
S616XLZ.60-17-16 (**)	17,0	25	32,0	150	13,0	39	-	2	-	0,543	3,8+5,0	16T3	1240P	5615P		

(*) Misure rilevate con inserto TCMT 110202
 Dimensions obtained with insert TCMT 110202
 Mit der Wendeplatte TCMT 110202 aufgenommene
 Bemessungen
 Dimensions relevées avec plaquette TCMT 110202

(**) Misure rilevate con inserto TCMT 16T304
 Dimensions obtained with insert TCMT 16T304
 Mit der Wendeplatte TCMT 16T304 aufgenommene
 Bemessungen
 Dimensions relevées avec plaquette TCMT 16T304

(***) Misure rilevate con inserto TCMT 220408
 Dimensions obtained with insert TCMT 220408
 Mit der Wendeplatte Tcmt 220408 aufgenommene
 Bemessungen
 Dimensions relevées avec plaquette TCMT 220408

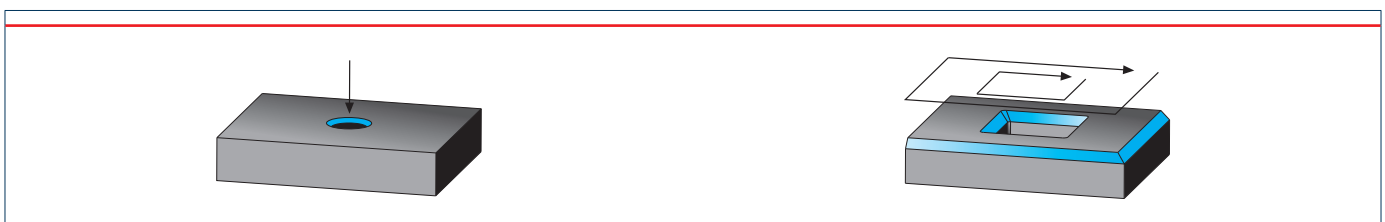

XLZ = EXTRALUNGA , STELO CILINDRICO - EXTRALONG , CYLINDRICAL SHANK - EXTRALANG , ZYLINDERSCHAFT - EXTRALONGUE , QUEUE CYLINDRIQUE
 = PASSO DIFFERENZIATO - DIFFERENTIAL PITCH - UNGLEICHE TEILUNG - PAS DIFFERENCIE

S 618 .. .3

Ø 20-25

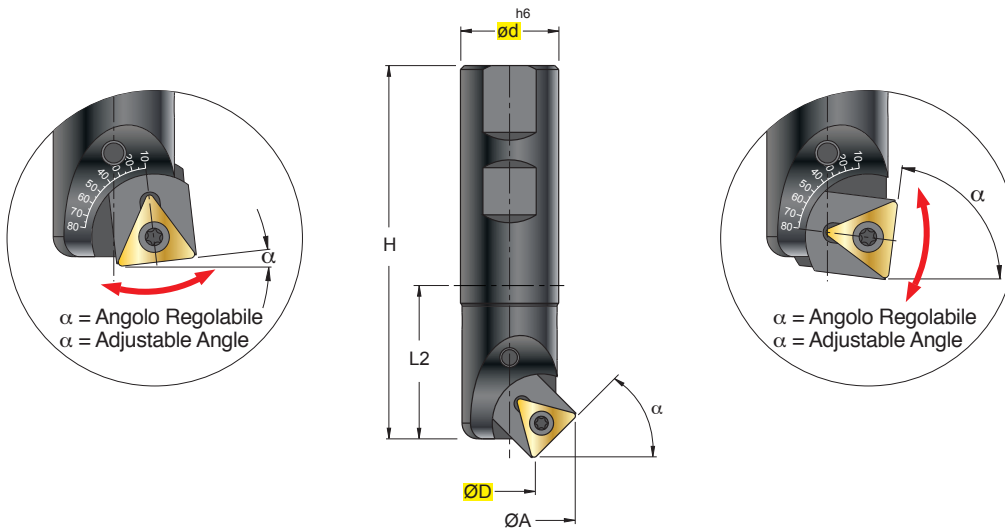

TCMT
110204
.G39



TCMT ...
.S42



TCMT ...
.G52



INSERTI - INSERTS
PAG. 535

		(mm)						kg	Nm					
ART.		ØD	Ød	ØA	H	L2	α							
S 618	020-11 .3	7,1	20	25,6	100	51	10°	0,213	1,1+1,3	1102	S11	12256P	5608P	FS243
		8,6	20	26,2	100	51	20°	0,213	1,1+1,3					
		10,3	20	26,5	100	51	30°	0,213	1,1+1,3					
		12,2	20	26,4	100	51	40°	0,213	1,1+1,3					
		13,2	20	26,3	100	51	45°	0,213	1,1+1,3					
		14,2	20	26,0	100	51	50°	0,213	1,1+1,3					
		16,2	20	25,3	100	51	60°	0,213	1,1+1,3					
		18,2	20	24,2	100	51	70°	0,213	1,1+1,3					
20,1	20	22,9	100	51	80°	0,213	1,1+1,3							
S 618	025-16 .3	4,9	25	31,6	100	44	10°	0,310	3,8+5,0	16T3	S16	12409P	5515P	SM612
		7,1	25	32,6	100	44	20°	0,310	3,8+5,0					
		9,7	25	33,1	100	44	30°	0,310	3,8+5,0					
		12,4	25	33,1	100	44	40°	0,310	3,8+5,0					
		13,8	25	32,9	100	44	45°	0,310	3,8+5,0					
		15,3	25	32,6	100	44	50°	0,310	3,8+5,0					
		18,2	25	31,6	100	44	60°	0,310	3,8+5,0					
		21,0	25	30,1	100	44	70°	0,310	3,8+5,0					
23,8	25	28,2	100	44	80°	0,310	3,8+5,0							

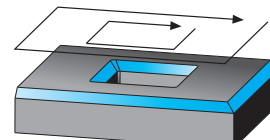
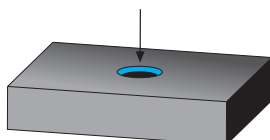

S 618 .. .4

Ø 20

SCMT
 1204..
 .G52

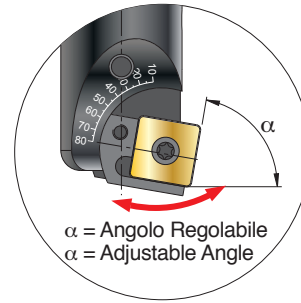
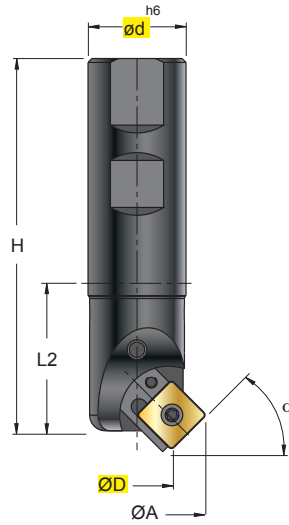
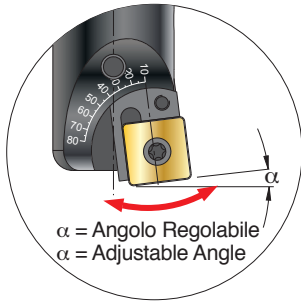

INSERTI - INSERTS
 PAG. 205

ART.	020-12..4	(mm)						kg	Nm	1204	S12.4	FS243	5620	SM612	5004	5015
		ØD	Ød	ØA	H	L2	α									
S 618	020-12..4	7,8	20	29,5	100	51	10°	0,213	5,5+7,0	1204	S12.4	FS243	5620	SM612	5004	5015
		10,5	20	31,0	100	51	20°	0,213	5,5+7,0							
		13,3	20	32,3	100	51	30°	0,213	5,5+7,0							
		16,2	20	33,0	100	51	40°	0,213	5,5+7,0							
		17,7	20	33,1	100	51	45°	0,213	5,5+7,0							
		19,2	20	33,2	100	51	50°	0,213	5,5+7,0							
		22,1	20	32,8	100	51	60°	0,213	5,5+7,0							
		24,8	20	32,0	100	51	70°	0,213	5,5+7,0							
		27,2	20	30,7	100	51	80°	0,213	5,5+7,0							

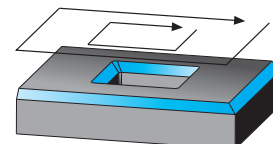
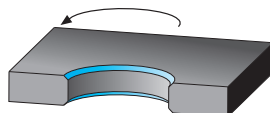

S 613.45W-0-16

Ø 0

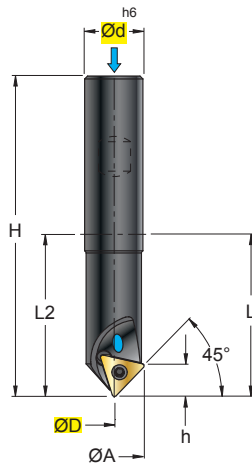

S 613.9.45W-0-16

Ø 0

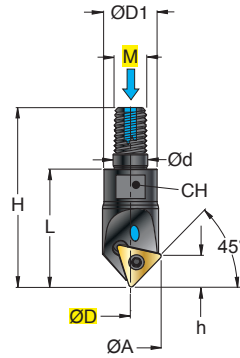

TCMX 16T308ZN .S52



INSERTI - INSERTS
PAG. 535

GRADO
GRADE

QUICK
PICK

MATERIALI
MATERIALS

F4140



P	M	K	N	S	H
●	●	○	○	●	

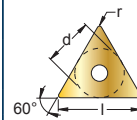

mm					
l	d	S	d1	r	
16,5	9,52	3,97	4,4	0,8	

(mm)

ART.	ØD	M	Ød	ØD1	ØA	H	h	L	L2	Z	CH	kg	Nm					
S 613.45W-0-16	0	-	20	-	21,6	110	10	50	60	1	-	0,21	3,8+5,0	16T308			12409P	5615P
S 613.9.45W-0-16	0	10	10,5	18	21,6	59	10	40	-	1	15	0,07	3,8+5,0	16T308			12409P	5615P

PS613

NEW



Contenuto del Set - Set Content
 N.1 S613.45W-0-16
 N.1 5615P
 N.2 TCMX 16T308ZN.S52 F4140

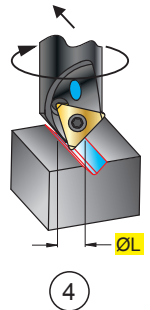
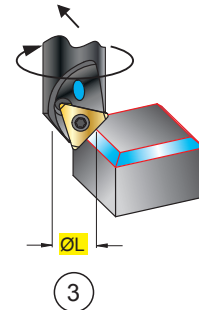
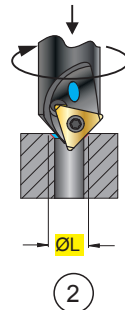
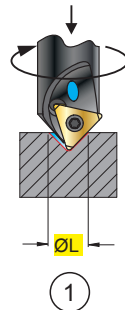

MATERIALI - MATERIALS Pag. 1199		VDI 3323 GR.	HB Rm1) HRC2)	Vc m/min F4140	fz mm ① ②-③ ④		
P	ACCIAIO NON LEGATO - NOT ALLOY STEEL	1-5	125-300	120	0,02-0,04	0,05-0,2	0,03-0,08
	ACCIAIO POCO LEGATO - LOW ALLOY STEEL	6-9	180-350	100	0,02-0,04	0,05-0,2	0,03-0,08
	ACCIAIO ALTO LEGATO - ALLOY STEEL	10-11	200-325	80	0,02-0,04	0,05-0,2	0,03-0,08
	INOX MARTENS. - STAINLESS STEEL MART	12-13	200-240	100	0,02-0,04	0,05-0,2	0,03-0,08
M	INOX AUST. DUPLEX - STAINLESS STEEL AUST	14.1-14.2	180-230	100	0,03-0,05	0,05-0,2	0,03-0,08
K	GHISA GRIGIA - GREY CAST IRON	15-16	180-260	120	0,03-0,06	0,05-0,2	0,05-0,1
	GHISA SFEROIDALE - SPHEROIDAL GRAPHITE	17-18	160-250	140	0,03-0,06	0,05-0,2	0,05-0,1
	GHISA MALLEABILE - MALLEABLE CAST IRON	19-20	130-230	120	0,03-0,06	0,05-0,2	0,05-0,1
N	ALLUMINIO E SUE LEGHE - ALUMINIUM	21-25	60-130	200	0,03-0,06	0,05-0,2	0,08-0,15
	RAME E SUE LEGHE - COPPER	26-28	90-110	150	0,03-0,06	0,05-0,2	0,08-0,15
S	NON METALLICI - PLASTICS	29-30	/				
	LEGHE RESIST. CALORE - HIG. TEMP. ALLOY	31-35	200-320	50	0,01-0,06	0,03-0,07	0,05-0,1
H	TITANIO E SUE LEGHE - TITANIUM	36-37	400-1050 ⁰	50	0,01-0,06	0,03-0,07	0,05-0,1
	ACCIAIO TEMPRATO - HARDENED STEEL	38-41	45-60 ²				

$$n = \frac{Vc \cdot 1000}{\phi L \cdot 3,14} = \text{giri/min (min}^{-1}\text{)}$$

$$fz = fz0 \cdot Kae = \text{mm}$$

$$fn = fz \cdot z = \text{mm}$$

$$Vf = fz \cdot z \cdot n = \text{mm/min}$$

F = FINITURA, LAV. LEGGERA - FINISHING, LIGHT MACHINING
 M = LAV. MEDIA, GENERICA - MEDIUM MACHINING, GENERIC
 R = SGROSSATURA, LAV. PESANTE - ROUGHING, HEAVY MACHINING

Vc = m/min VELOCITÀ DI TAGLIO - CUTTING SPEED
 n = giri/min (min⁻¹) NUMERO DI GIRI - NUMBER OF REVOLUTIONS
 fz = mm AVANZAMENTO AL DENTE - TOOTH FEED
 fn = mm AVANZAMENTO AL GIRO - FEED / REVOLUTION
 Vf = mm/min VELOCITÀ DI AVANZAMENTO - FEED SPEED
 Kae = FATTORE DI CORREZIONE - CORRECTION FACTOR

S 614.45W-0-12

Ø 0

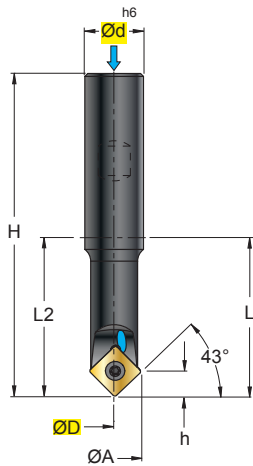

S 614.9.45W-0-12

Ø 0

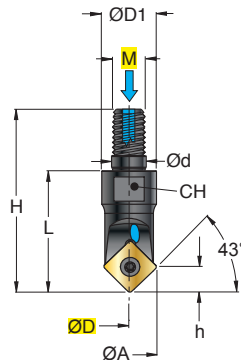

SCMX 120408ZN .S52



INSERTI - INSERTS
 PAG. 531

GRADO
 GRADE

QUICK
 PICK

MATERIALI
 MATERIALS

F4140



P	M	K	N	S	H
●	●	○	○	●	

mm				
l	d	S	d1	r
12,7	12,7	4,76	5,3	0,8

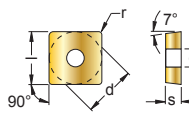

(mm)

ART.	ØD	M	Ød	ØD1	ØA	H	h	L	L2	Z	CH	kg	Nm	120408	FS242	5620
S 614.45W-0-12	0	-	20	-	18,4	110	7,8	50	60	1	-	0,21	5,5+7,0	120408	FS242	5620
S 614.9.45W-0-12	0	10	10,5	18	18,4	59	7,8	40	-	1	15	0,07	5,5+7,0	120408	FS242	5620

PS614

NEW



Contenuto del Set - Set Content
 N.1 S614.45W-0-12
 N.1 5520
 N.2 SCMX 120408ZN.S52 F4140

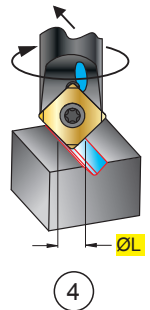
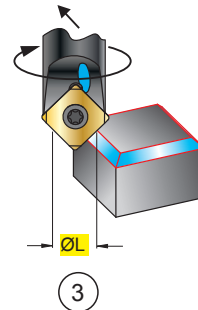
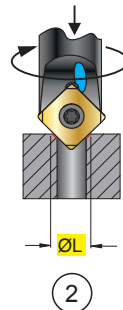
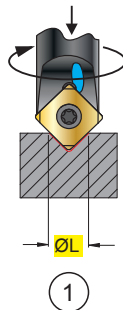

MATERIALI - MATERIALS Pag. 1199		VDI 3323 GR.	HB Rm1) HRC2)	Vc m/min	fz mm		
				F4140	①	②-③	④
P	ACCIAIO NON LEGATO - NOT ALLOY STEEL	1-5	125-300	120	0,02-0,04	0,05-0,2	0,03-0,08
	ACCIAIO POCO LEGATO - LOW ALLOY STEEL	6-9	180-350	100	0,02-0,04	0,05-0,2	0,03-0,08
	ACCIAIO ALTO LEGATO - ALLOY STEEL	10-11	200-325	80	0,02-0,04	0,05-0,2	0,03-0,08
	INOX MARTENS. - STAINLESS STEEL MART	12-13	200-240	100	0,02-0,04	0,05-0,2	0,03-0,08
M	INOX AUST. DUPLEX - STAINLESS STEEL AUST	14.1-14.2	180-230	100	0,03-0,05	0,05-0,2	0,03-0,08
K	GHISA GRIGIA - GREY CAST IRON	15-16	180-260	120	0,03-0,06	0,05-0,2	0,05-0,1
	GHISA SFEROIDALE - SPHEROIDAL GRAPHITE	17-18	160-250	140	0,03-0,06	0,05-0,2	0,05-0,1
	GHISA MALLEABILE - MALLEABLE CAST IRON	19-20	130-230	120	0,03-0,06	0,05-0,2	0,05-0,1
N	ALLUMINIO E SUE LEGHE - ALUMINIUM	21-25	60-130	200	0,03-0,06	0,05-0,2	0,08-0,15
	RAME E SUE LEGHE - COPPER	26-28	90-110	150	0,03-0,06	0,05-0,2	0,08-0,15
	NON METALLICI - PLASTICS	29-30	/	/	/	/	/
S	LEGHE RESIST. CALORE - HIG. TEMP. ALLOY	31-35	200-320	50	0,01-0,06	0,03-0,07	0,05-0,1
	TITANIO E SUE LEGHE - TITANIUM	36-37	400-1050 ⁿ	50	0,01-0,06	0,03-0,07	0,05-0,1
H	ACCIAIO TEMPRATO - HARDENED STEEL	38-41	45-60 ⁿ	/	/	/	/

$$n = \frac{Vc \cdot 1000}{\phi L \cdot 3,14} = \text{giri/min (min}^{-1}\text{)}$$

$$fz = fz0 \cdot Kae = \text{mm}$$

$$fn = fz \cdot z = \text{mm}$$

$$Vf = fz \cdot z \cdot n = \text{mm/min}$$

F = FINITURA, LAV. LEGGERA - FINISHING, LIGHT MACHINING
 M = LAV. MEDIA, GENERICA - MEDIUM MACHINING, GENERIC
 R = SGROSSATURA, LAV. PESANTE - ROUGHING, HEAVY MACHINING

Vc = m/min VELOCITÀ DI TAGLIO - CUTTING SPEED
 n = giri/min (min⁻¹) NUMERO DI GIRI - NUMBER OF REVOLUTIONS
 fz = mm AVANZAMENTO AL DENTE - TOOTH FEED
 fn = mm AVANZAMENTO AL GIRO - FEED / REVOLUTION
 Vf = mm/min VELOCITÀ DI AVANZAMENTO - FEED SPEED
 Kae = FATTORE DI CORREZIONE - CORRECTION FACTOR



FRESE PER SPALLAMENTI



SHOULDER MILLING CUTTERS















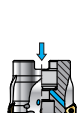

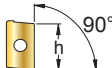

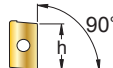







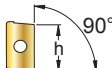

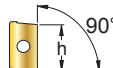
ECKFRÄSER

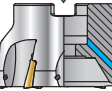



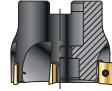
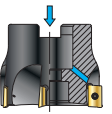
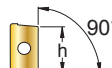

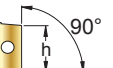
FRAISES À DRESSER

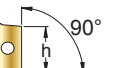

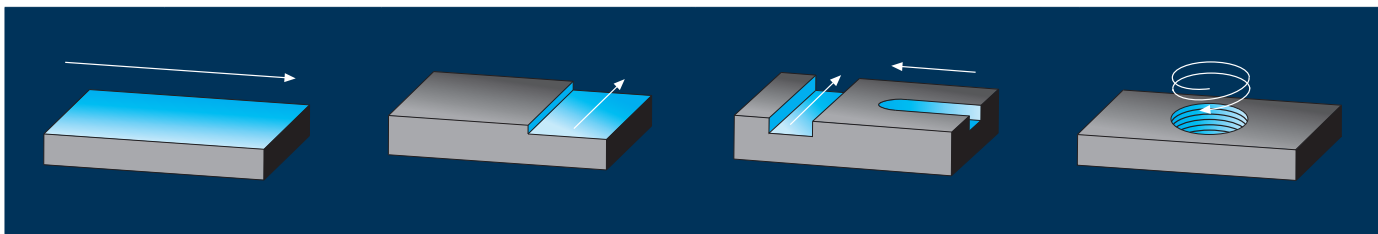
FRESAS PARA ESCUADRAR

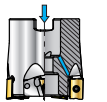
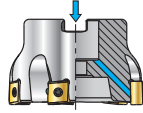
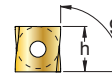
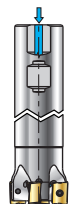
S2000. Pag. 86..07 448		S2000. Pag. 89..07 448		S9006. Pag. 6..W..-06 454	S9006. Pag. 8W..-06 454	S9006. Pag. 9W..-06 454	S1086W/GW Pag. 460													
	ØD = 10 - 25		ØD = 18 - 35		ØD = 20 - 40			ØD = 20 - 42		ØD = 10 - 32										
S 2000.86W .. 07		S 2000.89W .. 07		S 9006.6W .. -06 S 9006.6XLW .. -06	S 9006.8W .. -06	S 9006.9W .. -06	S 1086W/GW .. 10													
			BD..0703		h = 6					TNGX..0604		h = 6					AP..1003		h = 10	
S2000. Pag. 86..11 450		S2000. Pag. 88..11 450		S2000. Pag. 89..11 450		S9006- Pag. 6..W..-10 456	S9006- Pag. 8W..-10 456	S9006- Pag. 9W..-10 456	S1086 Pag. 462											
	ØD = 16 - 40		ØD = 40 - 80		ØD = 16 - 35		ØD = 32 - 40		ØD = 40 - 125		ØD = 32 - 40		ØD = 20 - 40		ØD = 10 - 32					
S 2000.86W .. 11 S 2000.86LMW .. 11 S 2000.86XLMW .. 11	S 2000.88W .. 11		S 2000.89W .. 11		S 9006-6W .. -10 S 9006-6XLW .. -10	S 9006-8W .. -10	S 9006-9W .. -10	S 1086GXL .. 10		S 1086XLZ .. 10 S 1086XLM .. 10										
			BD..11T3		h = 11					TNGX..1006		h = 10					AP..1003		h = 10	
S2000. Pag. 86..17 452		S2000. Pag. 88..17 452		S9005- Pag. 6..W..-09 458	S9005- Pag. 8W..-09 458	S9005- Pag. 9W..-09 458	S1088 Pag. 464													
	ØD = 25 - 40		ØD = 25 - 40		ØD = 40 - 100		ØD = 32 - 40		ØD = 40 - 125		ØD = 32 - 40		ØD = 40 - 63		ØD = 40 - 63					
S 2000.86W .. 17	S 2000.86XLMW .. 17		S 2000.88W .. 17		S 9005-6W .. -09 S 9005-6XLW .. -09	S 9005-8W .. -09	S 9005-9W .. -09	S 1088 .. 10		S 1088W/GW .. 10										
			BD..1704		h = 15,7					TOKX..09T3		h = 8					AP..1003		h = 10	
S1089 Pag. 464																				
							ØD = 10 - 12			ØD = 16 - 32										
S 1089W ..																				
			AP..1003		h = 10															

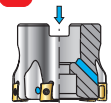
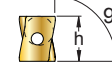
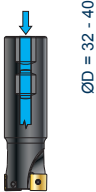
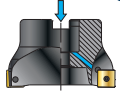

S9001-6..-10 Pag. 466  ØD = 20 - 40 S 9001-6W ..-10		S9001-8W..-10 Pag. 466  ØD = 20 - 32 S 9001-6XLW ..-10  ØD = 40 - 63 S 9001-8W ..-10		S1696W Pag. 472  ØD = 25 - 40 S 1696W .. 16		S9003.8W Pag. 478  ØD = 50 - 160 S 9003.8W ..13					
 LNMM..1006 h = 9		 AP..1604 h = 16		 LNMX 1313 h = 12							
S9001-6W..-15 Pag. 468  ØD = 32 - 40 S 9001-6W ..-15		S9001-8W..-15 Pag. 468  ØD = 50 - 80 S 9001-8W ..-15		S1696 Pag. 474  ØD = 25 - 40 S 1696XLZ .. 16 S 1696XLZM .. 16		S9004.6..W..-06 Pag. 480  ØD = 32 - 40 S 9004-6LW ..-09 S 9004-6XLW ..-09		S9004.8W..-09 Pag. 458  ØD = 40 - 125 S 9004-8W- ..-09		S9004.9W..-09 Pag. 480  ØD = 32 - 40 S 9004-9W- ..-09	
 LNMM..1510 h = 14		 AP..1604 h = 16		 LNMX 0907 h = 9							
S1296 Pag. 470  ØD = 32 - 40 S 1296W .. 12		S1298 Pag. 470  ØD = 32 - 40 S 1296XLZ .. 12		 ØD = 50 - 250 S 1298W/G/GW.. 12		S1698 Pag. 476  ØD = 40 - 125 S 1698 .. 16		 ØD = 40 - 125 S 1698W/GW .. 16			
 SD..1205 h = 10,5		 AP..1604 h = 16									

S 2000.86W.. 07

Ø 10-25

γ_p +3,5°/+7°
 γ_f -18,7°/-9,7°
 γ_o -18,7°/-9,7°

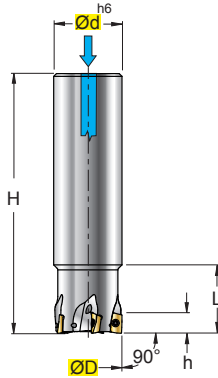

S 2000.89W.. 07

Ø 18-35

γ_p +7°
 γ_f -10,85°/-8,56°
 γ_o -10,85°/-8,56°

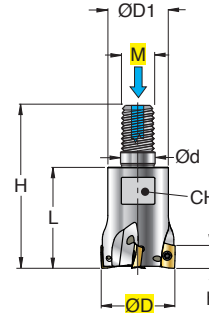

**BDMT 0703
.Y42**



**BDMT 0703
.Y52**



INSERTI - INSERTS
PAG. 528

(mm)

ART.	ØD	M	Ød	ØD1	H	h	L	β	Z	↻	CH	kg	Nm			
S 2000.86W 010-01.07	10	-	10	-	80	6	17	6°	1	/	-	0,04	0,5+0,6	0703	122041P	5606P
S 2000.86W 012-02.07	12	-	12	-	80	6	18	3,5°	2	-	-	0,06	0,5+0,6			
S 2000.86W 014-02.07	14	-	12	-	80	6	18	3°	2	-	-	0,07	0,5+0,6			
S 2000.86W 016-03.07	16	-	16	-	85	6	20	1,8°	3	-	-	0,12	0,5+0,6	0703	122041P	5606P
S 2000.86W 020-04.07	20	-	20	-	90	6	20	1,4°	4	-	-	0,20	0,5+0,6			
S 2000.86W 025-05.07	25	-	25	-	95	6	25	1,0°	5	-	-	0,33	0,5+0,6			
S 2000.89W 018-03.07	18	8	8,5	13	42	6	25	1,6°	3	-	10	0,04	0,5+0,6	0703	122041P	5606P
S 2000.89W 022-03.07	22	10	10,5	18	49	6	30	1,2°	3	-	15	0,07	0,5+0,6			
S 2000.89W 022-04.07	22	10	10,5	18	49	6	30	1,2°	4	-	15	0,07	0,5+0,6			
S 2000.89W 028-05.07	28	12	12,5	21	57	6	35	0,9°	5	-	17	0,12	0,5+0,6			
S 2000.89W 035-07.07	35	16	17,0	29	67	6	43	0,7°	7	-	24	0,26	0,5+0,6			

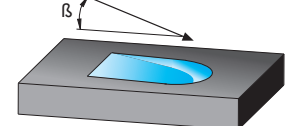
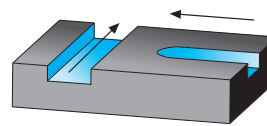
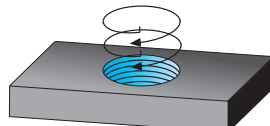
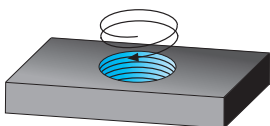

W = FORO PER LIQUIDO REFRIGERANTE - COOLANT BORE - KÜHLMITTELBOHRUNG - TROU DU LIQUIDE D'ARROSAGE
↻ = PASSO DIFFERENZIATO - DIFFERENTIAL PITCH - UNGLEICHE TEILUNG - PAS DIFFERENCIE

SCelta VELOCE - QUICK PICK

Tenacità + ↑
Toughness - ↓

Pag.538

COD.	MATERIALI												HT	HW	HC		l	d	s	d1	r	a°																										
	P			M			K			N					S								H			F3710	F4725																					
	F	M	R	F	M	R	F	M	R	F	M	R			F	M							R	F	M			R																				
BDMT 070304ER .Y42	○	●	○	○	○	○	○	○	○	○	○	○	○	○	○	○	○	○	○	○	■	■	6,7	4,6	2,6	2,3	0,4	16																				
BDMT 070302ER .Y52	○	●	○	○	○	○	○	○	○	○	○	○	○	○	○	○	○	○	○	○	■	■	6,7	4,6	2,6	2,3	0,2	16																				
BDMT 070304ER .Y52	○	●	○	○	○	○	○	○	○	○	○	○	○	○	○	○	○	○	○	○	■	■	6,7	4,6	2,6	2,3	0,4	16																				
CON ADDUZIONE LUBROREFRIGERANTE - WITH COOLANT SUPPLY																						●	●																									
SENZA ADDUZIONE LUBROREFRIGERANTE - WITHOUT COOLANT SUPPLY																						○	○																									

MATERIALI - MATERIALS Pag. 1199		VDI 3323 GR.	HB Rm1) HRC2)	fz0 mm			Vc m/min Pag. 552														
				F	M	R	F3710	F4725													
P	ACCIAIO NON LEGATO - NOT ALLOY STEEL	1-5	125-300	0,08	0,15	0,25		200													
	ACCIAIO POCO LEGATO - LOW ALLOY STEEL	6-9	180-350	0,08	0,15	0,2		170													
	ACCIAIO ALTO LEGATO - ALLOY STEEL	10-11	200-325	0,06	0,12	0,16		160													
	INOX MARTENS. - STAINLESS STEEL MART	12-13	200-240	0,08	0,12	0,15		140													
M	INOX AUST. DUPLEX - STAINLESS STEEL AUST	14.1-14.2	180-230	0,08	0,12	0,15		170													
K	GHISA GRIGIA - GREY CAST IRON	15-16	180-260	0,08	0,18	0,25	190														
	GHISA SFEROIDALE - SPHEROIDAL GRAPHITE	17-18	160-250	0,08	0,15	0,2	170														
	GHISA MALLEABILE - MALLEABLE CAST IRON	19-20	130-230	0,08	0,15	0,2	150														
N	ALLUMINIO E SUE LEGHE - ALUMINIUM	21-25	60-130																		
	RAME E SUE LEGHE - COPPER	26-28	90-110																		
S	NON METALLICI - PLASTICS	29-30	/																		
	LEGHE RESIST. CALORE - HIG. TEMP. ALLOY	31-35	200-320	0,05	0,07	0,1	50														
	TITANIO E SUE LEGHE - TITANIUM	36-37	400-1050 ⁹	0,05	0,07	0,1	50														
H	ACCIAIO TEMPRATO - HARDENED STEEL	38-41	45-60 ⁹																		

$$n = \frac{Vc \cdot 1000}{\varnothing D \cdot 3,14} = \text{giri/min (min}^{-1}\text{)}$$

$$fz = fz0 \cdot Kae = \text{mm}$$

$$fn = fz \cdot z = \text{mm}$$

$$Vf = fz \cdot z \cdot n = \text{mm/min}$$

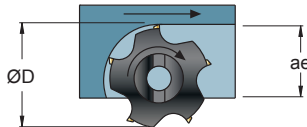









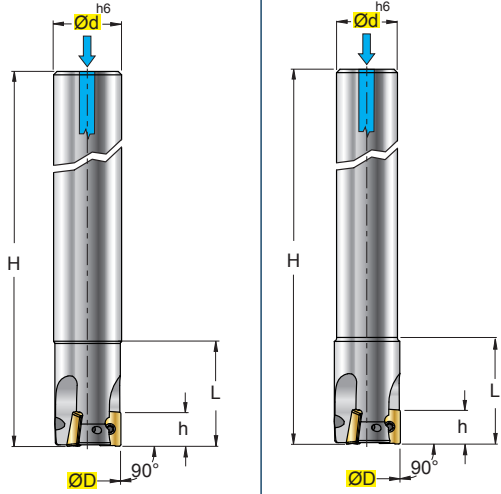

ae/D	0,5-1 50-100%	0,3 30%	0,2 20%	0,1 10%	0,05 5%	0,02 2%
Kae	1	1,2	1,5	2,1	3	4,8

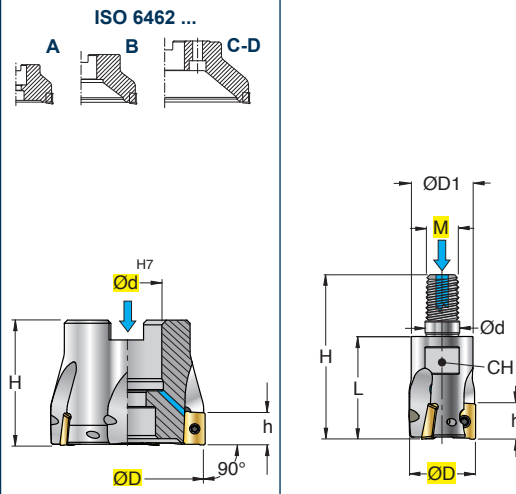
ae/D	0,5-1 50-100%	0,2 20%	0,1 10%	0,05 5%
Vc Pag. 552	Vc (min)-----Vc(max)			

- F = FINITURA, LAV. LEGGERA - FINISHING, LIGHT MACHINING
- M = LAV. MEDIA, GENERICA - MEDIUM MACHINING, GENERIC
- R = SGROSSATURA, LAV. PESANTE - ROUGHING, HEAVY MACHINING

- Vc = m/min VELOCITÀ DI TAGLIO - CUTTING SPEED
- n = giri/min (min⁻¹) NUMERO DI GIRI - NUMBER OF REVOLUTIONS
- fz = mm AVANZAMENTO AL DENTE - TOOTH FEED
- fn = mm AVANZAMENTO AL GIRO - FEED / REVOLUTION
- Vf = mm/min VELOCITÀ DI AVANZAMENTO - FEED SPEED
- Kae = FATTORE DI CORREZIONE - CORRECTION FACTOR

S 2000.86W..11 S 2000.86XLW..11	S 2000.86MW..11 S 2000.86XLMW..11	S 2000.88W.. 11	S 2000.89W.. 11	BDGT 11T3 .Y57	
$\varnothing 16-40$ $\gamma_p +6,3^\circ/+11,7^\circ$ $\gamma_f -15^\circ/-7,63^\circ$ $\gamma_o -15^\circ/-7,63^\circ$	$\varnothing 16-32$ $\gamma_p +6,3^\circ/+11,7^\circ$ $\gamma_f -15^\circ/-7,63^\circ$ $\gamma_o -15^\circ/-7,63^\circ$	$\varnothing 40-80$ $\gamma_p +11^\circ/+11,7^\circ$ $\gamma_f -7^\circ/-7,5^\circ$ $\gamma_o -7^\circ/-7,5^\circ$	$\varnothing 16-35$ $\gamma_p +6,3^\circ/+10,5^\circ$ $\gamma_f -15^\circ/-8,5^\circ$ $\gamma_o -15^\circ/-8,5^\circ$	BDMT 11T3 .Y42	
				BDMT 11T3 .Y52	
				 INSERTI - INSERTS PAG. 528	

ART.	$\varnothing D$	M	$\varnothing d$	$\varnothing D1$	H	h	L	β	Z		CH	kg	Nm	ISO 6462				
S 2000.86W 016-02-11	16	-	16	-	100	10	30	3°	2	-	-	0,14	1,1+1,3	-	11T3	122555PK	5608	-
S 2000.86W 020-03-11	20	-	20	-	110	10	26	5°	3	-	-	0,23	1,1+1,3	-	11T3	122555PK	5608	-
S 2000.86W 025-03-11	25	-	25	-	120	10	32	2,5°	3	-	-	0,42	1,1+1,3	-	11T3	122555PK	5608	-
S 2000.86W 032-04-11	32	-	32	-	130	10	30	1,5°	4	-	-	0,73	1,1+1,3	-	11T3	122555PK	5608	-
S 2000.86XLW 020-02-11	20	-	20	-	140	10	60	5°	2	-	-	0,30	1,1+1,3	-	11T3	122555PK	5608	-
S 2000.86XLW 025-02-11	25	-	25	-	160	10	60	2,5°	2	-	-	0,58	1,1+1,3	-	11T3	122555PK	5608	-
S 2000.86XLW 032-02-11	32	-	32	-	200	10	65	1,5°	2	-	-	1,18	1,1+1,3	-	11T3	122555PK	5608	-
S 2000.86XLW 040-02-11	40	-	32	-	240	10	65	0,7°	2	-	-	1,62	1,1+1,3	-	11T3	122555PK	5608	-
S 2000.86XLW 040-03-11	40	-	32	-	240	10	65	0,7°	3	-	-	1,60	1,1+1,3	-	11T3	122555PK	5608	-
S 2000.86MW 016-02-11	16	-	12	-	100	10	32	3°	2	-	-	0,10	1,1+1,3	-	11T3	122555PK	5608	-
S 2000.86MW 020-03-11	20	-	16	-	110	10	32	5°	3	-	-	0,17	1,1+1,3	-	11T3	122555PK	5608	-
S 2000.86MW 025-03-11	25	-	20	-	120	10	34	2,5°	3	-	-	0,30	1,1+1,3	-	11T3	122555PK	5608	-
S 2000.86MW 032-04-11	32	-	25	-	130	10	43	1,5°	4	-	-	0,52	1,1+1,3	-	11T3	122555PK	5608	-
S 2000.86XLMW 018-02-11	18	-	16	-	170	10	32	3°	2	-	-	0,24	1,1+1,3	-	11T3	122555PK	5608	-
S 2000.86XLMW 020-02-11	20	-	16	-	170	10	32	5°	2	-	-	0,25	1,1+1,3	-	11T3	122555PK	5608	-
S 2000.86XLMW 020-03-11	20	-	16	-	170	10	32	5°	3	-	-	0,24	1,1+1,3	-	11T3	122555PK	5608	-
S 2000.86XLMW 022-02-11	22	-	20	-	170	10	32	2,5°	2	-	-	0,39	1,1+1,3	-	11T3	122555PK	5608	-
S 2000.86XLMW 022-03-11	22	-	20	-	170	10	32	2,5°	3	-	-	0,39	1,1+1,3	-	11T3	122555PK	5608	-
S 2000.86XLMW 025-02-11	25	-	20	-	210	10	34	2,5°	2	-	-	0,49	1,1+1,3	-	11T3	122555PK	5608	-
S 2000.86XLMW 025-03-11	25	-	20	-	210	10	34	2,5°	3	-	-	0,48	1,1+1,3	-	11T3	122555PK	5608	-
S 2000.86XLMW 032-02-11	32	-	25	-	210	10	43	1,5°	2	-	-	0,78	1,1+1,3	-	11T3	122555PK	5608	-
S 2000.86XLMW 032-03-11	32	-	25	-	210	10	43	1,5°	3	-	-	0,77	1,1+1,3	-	11T3	122555PK	5608	-
S 2000.88W 040-05-11	40	-	16	-	40	10	-	0,7°	5	-	-	0,2	1,1+1,3	A	11T3	122555PK	5608	VBSF08L
S 2000.88W 050-05-11	50	-	22	-	40	10	-	-	5	-	-	0,3	1,1+1,3	A	11T3	122555PK	5608	VBSF10
S 2000.88W 063-06-11	63	-	22	-	40	10	-	-	6	-	-	0,5	1,1+1,3	A	11T3	122555PK	5608	VBSF12
S 2000.88W 080-07-11	80	-	27	-	50	10	-	-	7	-	-	1,0	1,1+1,3	A	11T3	122555PK	5608	VBSF12
S 2000.89W 016-02-11	16	8	8,5	13	42	10	25	3°	2	-	10	0,03	1,1+1,3	-	11T3	122555PK	5608	-
S 2000.89W 020-03-11	20	10	10,5	18	49	10	30	5°	3	-	15	0,06	1,1+1,3	-	11T3	122555PK	5608	-
S 2000.89W 022-03-11	22	10	10,5	18	49	10	30	2,5°	3	-	15	0,06	1,1+1,3	-	11T3	122555PK	5608	-
S 2000.89W 025-03-11	25	12	12,5	21	57	10	35	2,5°	3	-	17	0,10	1,1+1,3	-	11T3	122555PK	5608	-
S 2000.89W 028-03-11	28	12	12,5	21	57	10	35	1,5°	3	-	17	0,10	1,1+1,3	-	11T3	122555PK	5608	-
S 2000.89W 028-04-11	28	12	12,5	21	57	10	35	1,5°	4	-	17	0,11	1,1+1,3	-	11T3	122555PK	5608	-
S 2000.89W 032-04-11	32	16	17	29	67	10	43	1,5°	4	-	24	0,25	1,1+1,3	-	11T3	122555PK	5608	-
S 2000.89W 035-04-11	35	16	17	29	67	10	43	1°	4	-	24	0,27	1,1+1,3	-	11T3	122555PK	5608	-
S 2000.89W 035-05-11	35	16	17	29	67	10	43	1°	5	-	24	0,27	1,1+1,3	-	11T3	122555PK	5608	-

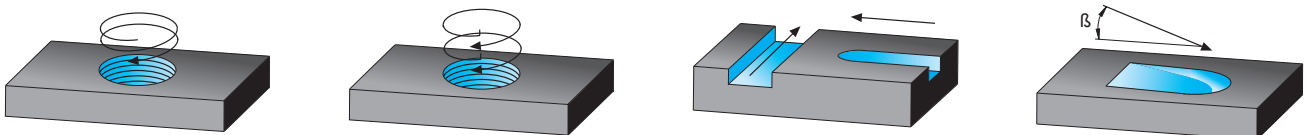

W = FORO PER LIQUIDO REFRIGERANTE - COOLANT BORE - KÜHLMITTELBOHRUNG - TROU DU LIQUIDE D'ARROSAGE
 = PASSO DIFFERENZIATO - DIFFERENTIAL PITCH - UNGLEICHE TEILUNG - PAS DIFFERENCE

SCELTA VELOCE - QUICK PICK

Tenacità + ↑

Toughness - ↓

Pag. 538

HT	HW	HC	
CERMET	NON RIV. CEMENTED CARBIDE GRADES	RIVESTITI COATED GRADES BESCHICHTET RECOUVERTS	
		F3710	F4725

COD.	P			M			K			N			S			H			l	d	s	d1	r	a°	
	F	M	R	F	M	R	F	M	R	F	M	R	F	M	R	F	M	R							
BDGT 11T302FR .Y57									●	●	○	○	○							11,0	6,7	3,8	2,8	0,2	18
BDGT 11T304FR .Y57									●	●	○	○	○							11,0	6,7	3,8	2,8	0,4	18
BDGT 11T308FR .Y57									●	●	○	○	○							11,0	6,7	3,8	2,8	0,8	18
BDMT 11T304ER .Y42	○	●	○	●	○	●														11,0	6,7	3,8	2,8	0,4	18
BDMT 11T308ER .Y42	○	●	○	●	○	●														11,0	6,7	3,8	2,8	0,8	18
BDMT 11T308ER .Y52							○	●	○				○	○						11,0	6,7	3,8	2,8	0,8	18
BDMT 11T312ER .Y52	○	●	○	●	○	●														11,0	6,7	3,8	2,8	1,2	18
BDMT 11T316ER .Y52	○	●	○	●	○	●														11,0	6,7	3,8	2,8	1,6	18
BDMT 11T320ER .Y52	○	●	○	●	○	●														11,0	6,7	3,8	2,8	2,0	18
BDMT 11T324ER .Y52	○	●	○	●	○	●														11,0	6,7	3,8	2,8	2,4	18
BDMT 11T331ER .Y52	○	●	○	●	○	●														11,0	6,7	3,8	2,8	3,1	18

CON ADDUZIONE LUBROREFRIGERANTE - WITH COOLANT SUPPLY

SENZA ADDUZIONE LUBROREFRIGERANTE - WITHOUT COOLANT SUPPLY

MATERIALI - MATERIALS Pag. 1199		VDI 3323 GR.	HB Rm1) HRC2)	fz0 mm			Vc m/min Pag. 552									
				F	M	R	N3015	F3710	F4725							
P	ACCIAIO NON LEGATO - NOT ALLOY STEEL	1--5	125-300	0,08	0,15	0,25			200							
	ACCIAIO POCO LEGATO - LOW ALLOY STEEL	6-9	180-350	0,08	0,15	0,2			170							
	ACCIAIO ALTO LEGATO - ALLOY STEEL	10-11	200-325	0,06	0,12	0,16			160							
	INOX MARTENS. - STAINLESS STEEL MART	12-13	200-240	0,08	0,12	0,15			140							
M	INOX AUST. DUPLEX - STAINLESS STEEL AUST	14.1-14.2	180-230	0,08	0,12	0,15			170							
K	GHISA GRIGIA - GREY CAST IRON	15-16	180-260	0,08	0,18	0,25		190								
	GHISA SFEROIDALE - SPHEROIDAL GRAPHITE	17-18	160-250	0,08	0,15	0,2		170								
	GHISA MALLEABILE - MALLEABLE CAST IRON	19-20	130-230	0,08	0,15	0,2		150								
N	ALLUMINIO E SUE LEGHE - ALUMINIUM	21--25	60-130	0,08	0,15	0,2	950									
	RAME E SUE LEGHE - COPPER	26-28	90-110	0,08	0,15	0,2	625									
	NON METALLICI - PLASTICS	29-30	/	0,08	0,15	0,2	285									
S	LEGHE RESIST. CALORE - HIG. TEMP. ALLOY	31--35	200-320	0,05	0,10	0,15	80									
	TITANIO E SUE LEGHE - TITANIUM	36-37	400-1050 ⁹⁾	0,05	0,10	0,15	80									
H	ACCIAIO TEMPRATO - HARDENED STEEL	38-41	45-60 ⁸⁾													

$$n = \frac{Vc \cdot 1000}{\varnothing D \cdot 3,14} = \text{giri/min (min}^{-1}\text{)}$$

$$fz = fz0 \cdot Kae = \text{mm}$$

$$fn = fz \cdot z = \text{mm}$$

$$Vf = fz \cdot z \cdot n = \text{mm/min}$$

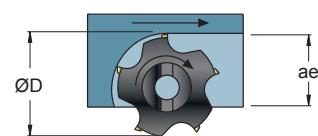





ae/D	0,5-1 50-100%	0,3 30%	0,2 20%	0,1 10%	0,05 5%	0,02 2%
Kae	1	1,2	1,5	2,1	3	4,8

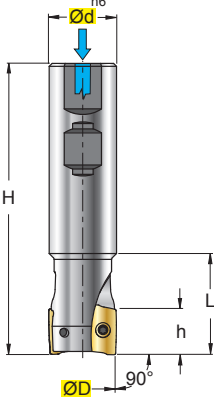
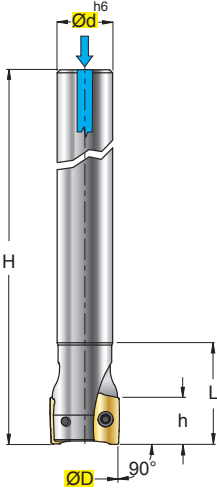
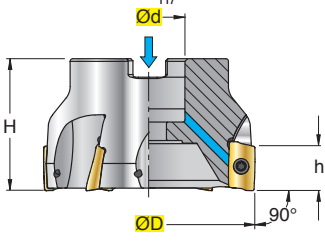
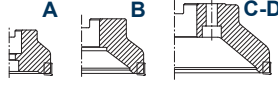

ae/D	0,5-1 50-100%	0,2 20%	0,1 10%	0,05 5%
Vc Pag. 552	Vc (min)-----Vc(max)			

- F** = FINITURA , LAV. LEGGERA - FINISHING , LIGHT MACHINING
M = LAV. MEDIA , GENERICA - MEDIUM MACHINING , GENERIC
R = SGROSSATURA , LAV. PESANTE - ROUGHING , HEAVY MACHINING
- Vc** = m/min VELOCITÀ DI TAGLIO - CUTTING SPEED
n = giri/min (min⁻¹) NUMERO DI GIRI - NUMBER OF REVOLUTIONS
fz = mm AVANZAMENTO AL DENTE -TOOTH FEED
fn = mm AVANZAMENTO AL GIRO - FEED / REVOLUTION
Vf = mm/min VELOCITÀ DI AVANZAMENTO - FEED SPEED
Kae = FATTORE DI CORREZIONE - CORRECTION FACTOR

Raggio Inserto Insert Radius (mm)	Raggio Fresa Milling cutter Radius (mm)
1,6	R1,0
2,0	R1,2
2,4	R1,6
3,1	R2,5
4,0	

- Per usare inserti con r≥1,6mm, bisogna modificare il corpo fresa come indicato in figura.
- To use inserts with r≥1,6mm, it is necessary to modify the milling cutting body as illustrated in the figure
- Um wendeschneidplatten mit r≥1,6mm, muss der fräserkörper wie in der abbildung angegeben verändert werden
- Pour utiliser les plaquettes avec r≥1,6mm, il faut modifier le corps de la fraise comme il est indiqué dans l'illustration.

S 2000.86W.. 17	$\gamma_p +7^\circ/+10^\circ$ $\gamma_f -11^\circ/-7^\circ$ $\gamma_o -11^\circ/-7^\circ$	S 2000.86XLMW.. 17	$\gamma_p +7^\circ/+10^\circ$ $\gamma_f -11^\circ/-7^\circ$ $\gamma_o -11^\circ/-7^\circ$	S 2000.88W.. 17	$\gamma_p +10^\circ$ $\gamma_f -7^\circ$ $\gamma_o -7^\circ$	BDGT 1704 .Y57	
$\varnothing 25-40$ 		$\varnothing 25-40$ 		$\varnothing 40-100$ 	ISO 6462 ... 	BDMT 1704 .Y42	
						BDMT 1704 .Y52	
						 INSERTI - INSERTS PAG. 528	

(mm)																		
ART.	$\varnothing D$	M	$\varnothing d$	$\varnothing D1$	H	h	L	β	Z		CH	kg	Nm					ISO 6462
S 2000.86W 025-02.17	25	-	25	-	92	15,7	36	4,5°	2	-	-	0,28	3,8÷5,0	-	1704	C04008P	5615P	-
S 2000.86W 032-03.17	32	-	32	-	100	15,7	40	2,5°	3	-	-	0,50	3,8÷5,0	-				
S 2000.86W 040-04.17	40	-	32	-	110	15,7	50	2°	4	-	-	0,63	3,8÷5,0	-				
S 2000.86XLMW 025-02.17	25	-	20	-	210	15,7	60	4,5°	2	-	-	0,48	3,8÷5,0	-	1704	C04008P	5615P	-
S 2000.86XLMW 032-03.17	32	-	25	-	250	15,7	65	2,5°	3	-	-	0,90	3,8÷5,0	-				
S 2000.86XLMW 040-04.17	40	-	32	-	250	15,7	65	2°	4	-	-	1,49	3,8÷5,0	-				
S 2000.88W 040-04.17	40	-	16	-	40	15,7	-	2°	4	-	-	0,17	3,8÷5,0	A	1704	C04008P	5615P	VBSF08L
S 2000.88W 050-04.17	50	-	22	-	40	15,7	-	1,5°	4	-	-	0,29	3,8÷5,0	A	1704	C04008P	5615P	VBSF10
S 2000.88W 050-05.17	50	-	22	-	40	15,7	-	1,5°	5	-	-	0,27	3,8÷5,0	A				
S 2000.88W 063-05.17	63	-	22	-	40	15,7	-	1°	5	-	-	0,51	3,8÷5,0	A				
S 2000.88W 063-06.17	63	-	22	-	40	15,7	-	1°	6	-	-	0,49	3,8÷5,0	A				
S 2000.88W 080-06.17	80	-	27	-	50	15,7	-	1°	6	-	-	0,97	3,8÷5,0	A-B	1704	C04008P	5615P	AL12x35
S 2000.88W 100-07.17	100	-	32	-	50	15,7	-	0,5°	7	-	-	1,44	3,8÷5,0	A-B	1704	C04008P	5615P	AL16x35

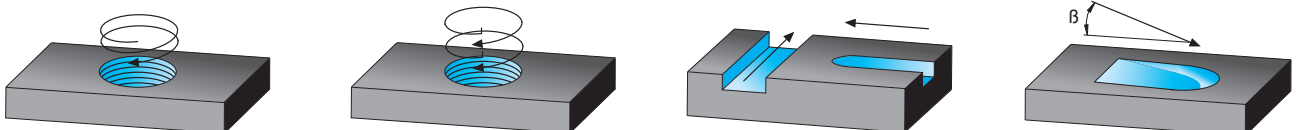

W = FORO PER LIQUIDO REFRIGERANTE - COOLANT BORE - KÜHLMITTELBOHRUNG - TROU DU LIQUIDE D'ARROSAGE
 = PASSO DIFFERENZIATO - DIFFERENTIAL PITCH - UNGLEICHE TEILUNG - PAS DIFFERENCIE

S 9006.6W- .. -06

Ø 20-40
 γ_p -11°
 γ_f -16,5°/-15°
 γ_o -16,5°/-15°

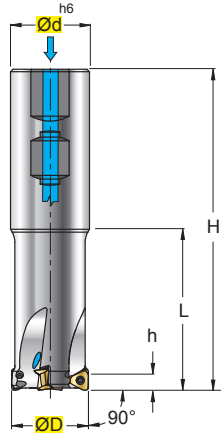

S 9006.6XLW- .. -06

Ø 20-40
 γ_p -11°
 γ_f -16,5°/-15°
 γ_o -16,5°/-15°

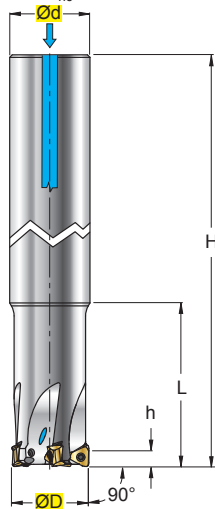

S 9006.8W- .. -06

Ø 40-100
 γ_p -11°
 γ_f -15°
 γ_o -15°

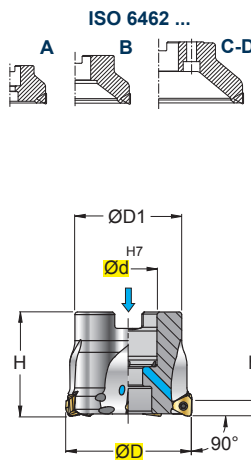

S 9006.9W- .. -06

Ø 20-42
NEW
 γ_p -11°
 γ_f -16,5°/-15°
 γ_o -16,5°/-15°

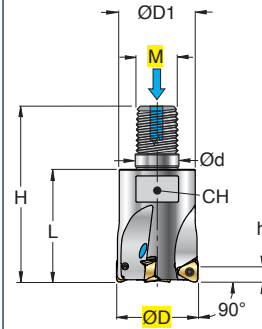

INSERTI - INSERTS
PAG. 536

ART.	ØD	M	Ød	ØD1	H	L	h	β	Z	CH	kg	Nm	ISO 6462	0604...	12256P	5608P		
S 9006.6W 020-03-06	20	-	20	-	100	40	6	2°	3	-	0,20	1,1+1,3	-	0604...	12256P	5608P	-	
S 9006.6W 025-03-06	25	-	25	-	115	50	6	1,5°	3	-	0,37	1,1+1,3	-	0604...	12256P	5608P	-	
S 9006.6W 025-04-06	25	-	25	-	115	50	6	1,5°	4	Y	0,35	1,1+1,3	-	0604...	12256P	5608P	-	
S 9006.6W 032-04-06	32	-	32	-	130	60	6	1°	4	Y	0,71	1,1+1,3	-	0604...	12256P	5608P	-	
S 9006.6W 040-05-06	40	-	32	-	140	70	6	0,8°	5	Y	0,80	1,1+1,3	-	0604...	12256P	5608P	-	
S 9006.6XLW 020-03-06	20	-	20	-	160	40	6	2°	3	-	0,34	1,1+1,3	-	0604...	12256P	5608P	-	
S 9006.6XLW 025-03-06	25	-	25	-	170	50	6	1,5°	3	-	0,57	1,1+1,3	-	0604...	12256P	5608P	-	
S 9006.6XLW 032-04-06	32	-	32	-	180	60	6	1°	4	Y	1,02	1,1+1,3	-	0604...	12256P	5608P	-	
S 9006.6XLW 032-05-06	32	-	32	-	180	60	6	1°	5	Y	1,01	1,1+1,3	-	0604...	12256P	5608P	-	
S 9006.6XLW 040-05-06	40	-	32	-	200	70	6	0,8°	5	Y	1,17	1,1+1,3	-	0604...	12256P	5608P	-	
S 9006.8W 040-05-06	40	-	16	36	40	-	6	0,8°	5	Y	0,23	1,1+1,3	-	0604...	12256P	5608P	VDST2008	
S 9006.8W 040-06-06	40	-	16	36	40	-	6	0,8°	6	Y	0,23	1,1+1,3	-	0604...	12256P	5608P	VBSF10	
S 9006.8W 050-05-06	50	-	22	41	40	-	6	0,5°	5	Y	0,33	1,1+1,3	A	0604...	12256P	5608P	VBSF10	
S 9006.8W 050-07-06	50	-	22	41	40	-	6	0,5°	7	Y	0,31	1,1+1,3	A	0604...	12256P	5608P	VBSF12	
S 9006.8W 063-06-06	63	-	22	44	40	-	6	0,5°	6	Y	0,47	1,1+1,3	A-B	0604...	12256P	5608P	VBSF12	
S 9006.8W 063-09-06	63	-	22	44	40	-	6	0,5°	9	Y	0,44	1,1+1,3	A-B	0604...	12256P	5608P	VBSF16	
S 9006.8W 080-10-06	80	-	27	61	50	-	6	0,5°	10	Y	1,01	1,1+1,3	A-B	0604...	12256P	5608P	VBSF16	
S 9006.8W 100-12-06	100	-	32	75	50	-	6	0,5°	12	Y	1,61	1,1+1,3	A-B	0604...	12256P	5608P	VBSF16	
S9006.9W-020-03-06	20	10	10,5	18	49	30	6	2°	3	-	15	0,06	1,1+1,3	-	0604...	12256P	5608P	-
S9006.9W-025-03-06	25	12	12,5	21	57	35	6	1,5°	3	-	17	0,10	1,1+1,3	-	0604...	12256P	5608P	-
S9006.9W-025-04-06	25	12	12,5	21	57	35	6	1,5°	4	Y	17	0,09	1,1+1,3	-	0604...	12256P	5608P	-
S9006.9W-030-04-06	30	16	17	29	67	43	6	1°	4	Y	24	0,20	1,1+1,3	-	0604...	12256P	5608P	-
S9006.9W-032-04-06	32	16	17	29	67	43	6	1°	4	Y	24	0,22	1,1+1,3	-	0604...	12256P	5608P	-
S9006.9W-035-05-06	35	16	17	29	67	43	6	1°	5	Y	24	0,23	1,1+1,3	-	0604...	12256P	5608P	-
S9006.9W-040-05-06	40	16	17	29	67	43	6	1°	5	Y	24	0,29	1,1+1,3	-	0604...	12256P	5608P	-
S9006.9W-042-05-06	42	16	17	29	67	43	6	1°	5	Y	24	0,31	1,1+1,3	-	0604...	12256P	5608P	-

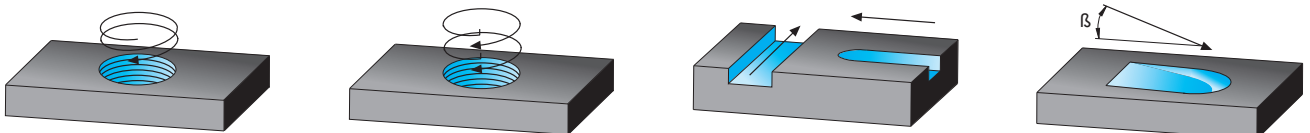

W = FORO PER LIQUIDO REFRIGERANTE - COOLANT BORE - KÜHLMITTELBOHRUNG - TROU DU LIQUIDE D'ARROSAGE
L = LUNGA, STELO CILINDRICO - LONG, CYLINDRICAL SHANK - LANG, ZYLINDERSCHAFT - LONGUE, QUEUE CYLINDRIQUE
↻ = PASSO DIFFERENZIATO - DIFFERENTIAL PITCH - UNGLEICHE TEILUNG - PAS DIFFERENCIE

SCelta VELOCE - QUICK PICK		Tenacità + ↑		Toughness - ↓		Pag. 538		HT	HW	HC																									
		CERMET		NON RIV. CEMENTED CARBIDE GRADES		RIVESTITI COATED GRADES BESCHICHTET RECOUVERTS				F5105	F3110	F2330	F2335	l	d	s	d1	r	a°																
COD.		P		M		K		N		S		H																							
		F	M	R	F	M	R	F	M	R	F	M	R	F	M	R	F	M	R																
TNGX	060404 .X42	○	○		●	●		○	○		○	○		○	○		○	○								11	6,35	3,42	2,8	0,4	-				
TNGX	060408 .X42	○	○		●	●		○	○		○	○		○	○		○	○								11	6,35	3,42	2,8	0,8	-				
TNGX	060408 .X51	○	○		●	●		○	○		○	○		○	○		○	○								11	6,35	3,42	2,8	0,8	-				
TNGX	060404 .X54	○	○		●	●		○	○		○	○		○	○		○	○								11	6,35	3,42	2,8	0,4	-				
TNGX	060408 .X54	○	○		●	●		○	○		○	○		○	○		○	○								11	6,35	3,42	2,8	0,8	-				
CON ADDUZIONE LUBROREFRIGERANTE - WITH COOLANT SUPPLY																																			
SENZA ADDUZIONE LUBROREFRIGERANTE - WITHOUT COOLANT SUPPLY																																			

MATERIALI - MATERIALS		VDI 3323 GR.	HB Rm1) HRC2)	fz0 mm			Vc m/min				Pag. 552									
Pag. 1199				F	M	R	F5105	F3110	F2330	F2335										
P	ACCIAIO NON LEGATO - NOT ALLOY STEEL	1--5	125-300	0,05	0,08	0,15	280		250	220										
	ACCIAIO POCO LEGATO - LOW ALLOY STEEL	6--9	180-350	0,05	0,08	0,15	280		200	200										
	ACCIAIO ALTO LEGATO - ALLOY STEEL	10-11	200-325	0,05	0,08	0,15	230		180	160										
	INOX MARTENS. - STAINLESS STEEL MART	12-13	200-240	0,05	0,08	0,15	180		180	160										
M	INOX AUST. DUPLEX - STAINLESS STEEL AUST	14.1-14.2	180-230	0,05	0,08	0,12	160		170	140										
K	GHISA GRIGIA - GREY CAST IRON	15-16	180-260	0,05	0,1	0,18	300	320		220										
	GHISA SFEROIDALE - SPHEROIDAL GRAPHITE	17-18	160-250	0,05	0,1	0,18	250	280		200										
	GHISA MALLEABILE - MALLEABLE CAST IRON	19-20	130-230	0,05	0,1	0,18	250	280		200										
N	ALLUMINIO E SUE LEGHE - ALUMINIUM	21--25	60-130																	
	RAME E SUE LEGHE - COPPER	26--28	90-110																	
	NON METALLICI - PLASTICS	29-30	/																	
S	LEGHE RESIST. CALORE - HIG. TEMP. ALLOY	31--35	200-320	0,05	0,08	0,12	60		60	60										
	TITANIO E SUE LEGHE - TITANIUM	36-37	400-1050 ¹⁾	0,05	0,08	0,12	60		60	60										
H	ACCIAIO TEMPRATO - HARDENED STEEL	38--41	45-60 ²⁾																	



- SE LA SPORGENZA DELLA FRESA É >3xD RIDURRE I PARAMETRI DI LAVORO: Vc, fz, ap DEL 30%
- IF THE PROTRUSION OF THE CUTTER IS >3xD, REDUCE CUTTING PARAMETERS: Vc, fz, ap BY 30%

$$n = \frac{Vc \cdot 1000}{\varnothing D \cdot 3,14} = \text{giri/min (min}^{-1}\text{)}$$

$$fz = fz0 \cdot Kae = \text{mm}$$

$$fn = fz \cdot K = \text{mm}$$

$$Vf = fz \cdot z \cdot n = \text{mm/min}$$

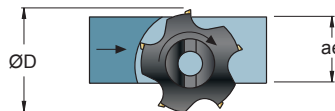

ae/D	0,5-1 50-100%	0,3 30%	0,2 20%	0,1 10%	0,05 5%	0,02 2%
Kae	1	1,2	1,5	2,1	3	4,8

ae/D	0,5-1 50-100%	0,2 20%	0,1 10%	0,05 5%
Vc (min)-----Vc(max)				
R-----M-----F				
Vc Pag. 552				

F = FINITURA, LAV. LEGGERA - FINISHING, LIGHT MACHINING
M = LAV. MEDIA, GENERICA - MEDIUM MACHINING, GENERIC
R = SGROSSATURA, LAV. PESANTE - ROUGHING, HEAVY MACHINING

Vc = m/min VELOCITÀ DI TAGLIO - CUTTING SPEED
n = giri/min (min⁻¹) NUMERO DI GIRI - NUMBER OF REVOLUTIONS
fz = mm AVANZAMENTO AL DENTE - TOOTH FEED
fn = mm AVANZAMENTO AL GIRO - FEED / REVOLUTION
Vf = mm/min VELOCITÀ DI AVANZAMENTO - FEED SPEED
Kae = FATTORE DI CORREZIONE - CORRECTION FACTOR

LATO A - SIDE A

LATO B - SIDE B

- 6 Taglienti "Utili" disponibili grazie all'inserto bilaterale.
- 6 "Useful" cutting-edges thanks to two-sided insert
- 6 "Nützliche" schneidkanten dank zweiseitiger wendeschneidplatten
- 6 Tranchants "Utiles" disponibles grace a la plaquette bilaterale

S 9006.6W- .. -10 NEW $\gamma_p -9,5^\circ$ $\gamma_f -16^\circ$ $\gamma_o -16,5^\circ/-15^\circ$	S 9006.6XLW- .. -10 NEW $\gamma_p -9,5^\circ$ $\gamma_f -16^\circ$ $\gamma_o -16,5^\circ/-15^\circ$	S 9006.8W- .. -10 NEW $\gamma_p -9,5^\circ$ $\gamma_f -16^\circ$ $\gamma_o -15^\circ$	S 9006.9W- .. -10 NEW $\gamma_p -9,5^\circ$ $\gamma_f -16^\circ$ $\gamma_o -16,5^\circ/-15^\circ$	TNGX 1006.. .X42 TNGX 1006.. .X51 TNGX 1006.. .X54 TNGX 1006.. .X57P
		ISO 6462 ... 		

INSERTI - INSERTS
PAG. 536

ART.	ØD	M	Ød	ØD1	H	L	h	Z	kg	Nm	ISO 6462				
S 9006.6W 032-03-10	32	-	32	-	130	60	10	3	0,57	3,8+5	-	1006...	1240P	5615P	-
S 9006.6W 040-04-10	40	-	32	-	140	70	10	4	0,68	3,8+5	-				
S 9006.6XLW 032-03-10	32	-	32	-	180	60	10	3	0,99	3,8+5	-	1006...	1240P	5615P	-
S 9006.6XLW 040-04-10	40	-	32	-	200	70	10	4	1,18	3,8+5	-				
S 9006.8W 040-04-10	40	-	16	36	40	-	10	4	0,21	3,8+5	-	1006...	1240P	5615P	VDST2008
S 9006.8W 050-05-10	50	-	22	41	40	-	10	5	0,28	3,8+5	-		1240P	5615P	VBSF10
S 9006.8W 063-06-10	63	-	22	44	40	-	10	6	0,41	3,8+5	A				
S 9006.8W 080-07-10	80	-	27	61	50	-	10	7	0,99	3,8+5	A		1240P	5615P	VBSF12
S 9006.8W 100-07-10	100	-	32	75	50	-	10	7	1,67	3,8+5	A-B		1240P	5615P	VBSF16
S 9006.8W 100-09-10	100	-	32	75	50	-	10	9	1,65	3,8+5	A-B				
S 9006.8W 125-08-10	125	-	40	95	63	-	10	8	3,07	3,8+5	A-B		1240P	5615P	VBSF20
S 9006.8W 125-10-10	125	-	40	95	63	-	10	10	3,10	3,8+5	A-B				
S 9006.9W 032-03-10	32	16	17	29	67	43	10	3	0,19	3,8+5	-	1006...	1240P	5615P	-
S 9006.9W 035-03-10	35	16	17	29	67	43	10	3	0,22	3,8+5	-				
S 9006.9W 040-04-10	40	16	17	29	67	43	10	4	0,25	3,8+5	-				

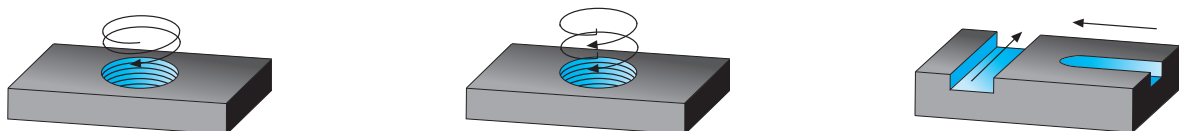

W = FORO PER LIQUIDO REFRIGERANTE - COOLANT BORE - KÜHLMITTELBOHRUNG - TROU DU LIQUIDE D'ARROSAGE
 L = LUNGA, STELO CILINDRICO - LONG, CYLINDRICAL SHANK - LANG, ZYLINDERSCHAFT - LONGUE, QUEUE CYLINDRIQUE
 = PASSO DIFFERENZIATO - DIFFERENTIAL PITCH - UNGLEICHE TEILUNG - PAS DIFFERENCIE

SCelta VELOCE - QUICK PICK		Tenacità + ↑ Toughness - ↓		Pag. 538		HT	HW	HC																							
		CERMET: N3620 NON RIV. CEMENTED CARBIDE GRADES RIVESTITI COATED GRADES BESCHICHTET RECOUVERTS: F5105, F3110, F2330, F2335																													
COD.		P			M			K			N			S			H			l	d	s	d1	r	a°						
		F	M	R	F	M	R	F	M	R	F	M	R	F	M	R	F	M	R	F	M	R	F	M	R						
TNGX	100604 .X42	○	○		●	●																				16,5	9,52	6,58	4,4	0,4	-
TNGX	100608 .X42	○	○		●	●																				16,5	9,52	6,58	4,4	0,8	-
TNGX	100608 .X51																									16,5	9,52	6,58	4,4	0,8	-
TNGX	100608 .X54																									16,5	9,52	6,58	4,4	0,8	-
TNGX	100616 .X54																									16,5	9,52	6,58	4,4	1,6	-
TNGX	100608 .X57P																									16,5	9,52	6,58	4,4	0,8	-
CON ADDUZIONE LUBROREFRIGERANTE - WITH COOLANT SUPPLY														○				●	●	●	●										
SENZA ADDUZIONE LUBROREFRIGERANTE - WITHOUT COOLANT SUPPLY														●				●	●	●	○										

MATERIALI - MATERIALS Pag. 1199		VDI 3323 GR.	HB Rm1) HRC2)	fz0 mm			Vc m/min Pag. 552							
				F	M	R	N3620	F5105	F3110	F2330	F2335			
P	ACCIAIO NON LEGATO - NOT ALLOY STEEL	1-5	125-300	0,05	0,08	0,15		280		250	220			
	ACCIAIO POCO LEGATO - LOW ALLOY STEEL	6-9	180-350	0,05	0,08	0,15		280		200	200			
	ACCIAIO ALTO LEGATO - ALLOY STEEL	10-11	200-325	0,05	0,08	0,15		230		180	160			
	INOX MARTENS. - STAINLESS STEEL MART	12-13	200-240	0,05	0,08	0,15		180		180	160			
M	INOX AUST. DUPLEX - STAINLESS STEEL AUST	14.1-14.2	180-230	0,05	0,08	0,12		160		170	140			
K	GHISA GRIGIA - GREY CAST IRON	15-16	180-260	0,05	0,1	0,18		300	320		220			
	GHISA SFEROIDALE - SPHEROIDAL GRAPHITE	17-18	160-250	0,05	0,1	0,18		250	280		200			
	GHISA MALLEABILE - MALLEABLE CAST IRON	19-20	130-230	0,05	0,1	0,18		250	280		200			
N	ALLUMINIO E SUE LEGHE - ALUMINIUM	21-25	60-130	0,1	0,15	0,2	300							
	RAME E SUE LEGHE - COPPER	26-28	90-110	0,1	0,15	0,2	300							
	NON METALLICI - PLASTICS	29-30	/	0,1	0,15	0,2	300							
S	LEGHE RESIST. CALORE - HIG. TEMP. ALLOY	31-35	200-320	0,05	0,08	0,12		60		60	60			
	TITANIO E SUE LEGHE - TITANIUM	36-37	400-1050 ¹⁾	0,05	0,08	0,12		60		60	60			
H	ACCIAIO TEMPRATO - HARDENED STEEL	38-41	45-60 ²⁾											



- SE LA SPORGENZA DELLA FRESA É >3xD RIDURRE I PARAMETRI DI LAVORO: Vc, fz, ap DEL 30%
- IF THE PROTRUSION OF THE CUTTER IS >3xD, REDUCE CUTTING PARAMETERS: Vc, fz, ap BY 30%

$$n = \frac{Vc \cdot 1000}{\phi D \cdot 3,14} = \text{giri/min (min}^{-1}\text{)}$$

$$fz = fz0 \cdot Kae = \text{mm}$$

$$fn = fz \cdot K = \text{mm}$$

$$Vf = fz \cdot z \cdot n = \text{mm/min}$$

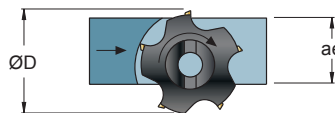

ae/D	0,5-1 50-100%	0,3 30%	0,2 20%	0,1 10%	0,05 5%	0,02 2%
Kae	1	1,2	1,5	2,1	3	4,8

ae/D	0,5-1 50-100%	0,2 20%	0,1 10%	0,05 5%
Vc (min)-----Vc(max)				
R-----M-----F				



Vc Pag. 552

F = FINITURA, LAV. LEGGERA - FINISHING, LIGHT MACHINING
M = LAV. MEDIA, GENERICA - MEDIUM MACHINING, GENERIC
R = SGROSSATURA, LAV. PESANTE - ROUGHING, HEAVY MACHINING

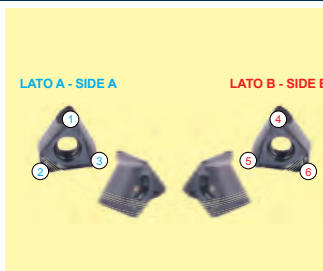
Vc = m/min VELOCITÀ DI TAGLIO - CUTTING SPEED
n = giri/min (min⁻¹) NUMERO DI GIRI - NUMBER OF REVOLUTIONS
fz = mm AVANZAMENTO AL DENTE - TOOTH FEED
fn = mm AVANZAMENTO AL GIRO - FEED / REVOLUTION
Vf = mm/min VELOCITÀ DI AVANZAMENTO - FEED SPEED
Kae = FATTORE DI CORREZIONE - CORRECTION FACTOR

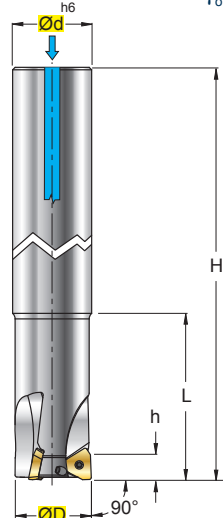
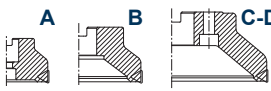
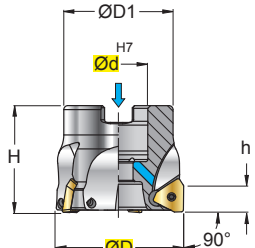
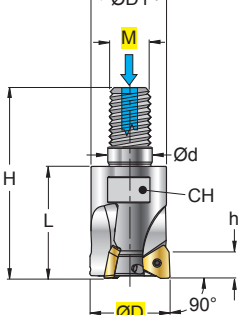

- 6 Taglienti "Utili" disponibili grazie all'inserto bilaterale.
- 6 "Useful" cutting-edges thanks to two-sided insert
- 6 "Nützliche" schneidkanten dank zweiseitiger wendeschneidplatten
- 6 Tranchants "Utiles" disponibles grace a la plaquette bilaterale

S 9005-6W- .. -09 S 9005-6XLW- .. -09	$\gamma_p +12^\circ/+13^\circ$ $\gamma_f -7^\circ/-6^\circ$ $\gamma_o -7^\circ/-6^\circ$	S 9005-8W- .. -09	$\gamma_p +13^\circ$ $\gamma_f -6^\circ/-5^\circ$ $\gamma_o -6^\circ/-5^\circ$	S 9005-9W- .. -09	$\gamma_p +12^\circ/+13^\circ$ $\gamma_f -7^\circ/-6^\circ$ $\gamma_o -7^\circ/-6^\circ$	TOKX 09T3.. .G52	
$\varnothing 32-40$		$\varnothing 40-125$	ISO 6462 ...  	$\varnothing 32-40$		TOKX 09T3.. .G53	
						 INSERTI - INSERTS PAG. 536	

(mm)													ISO 6462	09T3...	123084P	5608P	VDST2008	
ART.	$\varnothing D$	M	$\varnothing d$	$\varnothing D1$	H	L	h	β	Z	\rightarrow	CH	kg	Nm	A	09T3...	123084P	5608P	VDST2008
S 9005-6W 032-03-09	32	-	32	-	130	40	8	1°	3	-	-	0,71	1,2+1,5	-	09T3...	123084P	5608P	-
S 9005-6W 035-04-09	35	-	32	-	130	40	8	0,9°	4	-	-	0,72	1,2+1,5	-	09T3...	123084P	5608P	-
S 9005-6W 040-04-09	40	-	32	-	130	40	8	0,8°	4	-	-	0,76	1,2+1,5	-	09T3...	123084P	5608P	-
S 9005-6XLW 032-03-09	32	-	32	-	255	65	8	1°	3	-	-	1,42	1,2+1,5	-	09T3...	123084P	5608P	-
S 9005-6XLW 035-04-09	35	-	32	-	255	65	8	0,9°	4	-	-	1,46	1,2+1,5	-	09T3...	123084P	5608P	-
S 9005-6XLW 040-04-09	40	-	32	-	255	65	8	0,8°	4	-	-	1,51	1,2+1,5	-	09T3...	123084P	5608P	-
S 9005-8W 040-04-09	40	-	16	36	40	-	8	0,8°	4	-	-	0,20	1,2+1,5	A	09T3...	123084P	5608P	VDST2008
S 9005-8W 050-05-09	50	-	22	41	40	-	8	0,5°	5	✓	-	0,27	1,2+1,5	A	09T3...	123084P	5608P	VBSF10
S 9005-8W 063-06-09	63	-	22	48	40	-	8	0,5°	6	✓	-	0,43	1,2+1,5	A	09T3...	123084P	5608P	VBSF12
S 9005-8W 080-07-09	80	-	27	61	50	-	8	0,5°	7	✓	-	0,93	1,2+1,5	A	09T3...	123084P	5608P	VBSF16
S 9005-8W 100-07-09	100	-	32	80	50	-	8	0,5°	7	✓	-	1,66	1,2+1,5	A	09T3...	123084P	5608P	VBSF16
S 9005-8W 100-09-09	100	-	32	80	50	-	8	0,5°	9	✓	-	1,60	1,2+1,5	A	09T3...	123084P	5608P	VBSF20
S 9005-8W 125-08-09	125	-	40	95	63	-	8	0,5°	8	✓	-	3,10	1,2+1,5	A	09T3...	123084P	5608P	VBSF20
S 9005-8W 125-10-09	125	-	40	95	63	-	8	0,5°	10	✓	-	3,07	1,2+1,5	A	09T3...	123084P	5608P	VBSF20
S 9005-9W 032-03-09	32	16	17	29	67	43	8	1°	3	-	24	0,19	1,2+1,5	-	09T3...	123084P	5608P	-
S 9005-9W 035-04-09	35	16	17	29	67	43	8	0,9°	4	-	24	0,20	1,2+1,5	-	09T3...	123084P	5608P	-
S 9005-9W 040-04-09	40	16	17	29	67	43	8	0,8°	4	-	24	0,23	1,2+1,5	-	09T3...	123084P	5608P	-

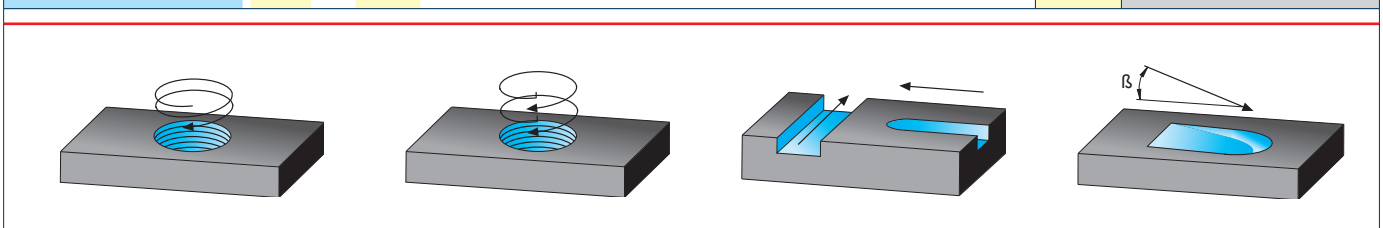

W = FORO PER LIQUIDO REFRIGERANTE - COOLANT BORE - KÜHLMITTELBOHRUNG - TROU DU LIQUIDE D'ARROSAGE
L = LUNGA, STELO CILINDRICO - LONG, CYLINDRICAL SHANK - LANG, ZYLINDERSCHAFT - LONGUE, QUEUE CYLINDRIQUE
 = PASSO DIFFERENZIATO - DIFFERENTIAL PITCH - UNGLEICHE TEILUNG - PAS DIFFERENCIE

SCELTA VELOCE - QUICK PICK

Tenacità + ↑

Toughness - ↓

Pag. 538

HT	HW	HC			
		NON RIV. CEMENTED CARBIDE GRADES		RIVESTITI COATED GRADES / BESCHICHTET RECOUVERTS	
		T2035	F2635	F4635	T5130

COD.	P		M		K		N		S		H		l	d	s	d1	r	a°
	F	M	R	F	M	R	F	M	R	F	M	R						
TOKX 09T308PDER .G52	●	●	○	○	○	○	○	○	○	○	○	○	13	9,58	3,85	3,35	0,8	12
TOKX 09T316PDER .G52	●	●	○	○	○	○	○	○	○	○	○	○	13	9,58	3,85	3,35	1,6	12
TOKX 09T308PDER .G53	○	○	○	●	●	●	○	○	○	○	○	○	13	9,58	3,85	3,35	0,8	12
TOKX 09T316PDER .G53	○	○	○	●	●	●	○	○	○	○	○	○	13	9,58	3,85	3,35	1,6	12

CON ADDUZIONE LUBROREFRIGERANTE - WITH COOLANT SUPPLY

SENZA ADDUZIONE LUBROREFRIGERANTE - WITHOUT COOLANT SUPPLY

MATERIALI - MATERIALS Pag. 1199		VDI 3323 GR.	HB Rm ¹ HRC ²	fz0 mm			Vc m/min Pag. 552			
				F	M	R	T5130	T2035	F2635	F4635
P	ACCIAIO NON LEGATO - NOT ALLOY STEEL	1-5	125-300	0,08	0,12	0,2	200		190	200
	ACCIAIO POCO LEGATO - LOW ALLOY STEEL	6-9	180-350	0,08	0,12	0,2	160		160	150
	ACCIAIO ALTO LEGATO - ALLOY STEEL	10-11	200-325	0,08	0,12	0,2	140		150	120
	INOX MARTENS. - STAINLESS STEEL MART	12-13	200-240	0,08	0,12	0,2	140		150	120
M	INOX AUST. DUPLEX - STAINLESS STEEL AUST	14.1-14.2	180-230	0,08	0,1	0,17	120	130	140	100
K	GHISA GRIGIA - GREY CAST IRON	15-16	180-260	0,12	0,25	0,35	150			150
	GHISA SFEROIDALE - SPHEROIDAL GRAPHITE	17-18	160-250	0,1	0,2	0,3	150			150
	GHISA MALLEABILE - MALLEABLE CAST IRON	19-20	130-230	0,1	0,2	0,3	150			150
N	ALLUMINIO E SUE LEGHE - ALUMINIUM	21-25	60-130							
	RAME E SUE LEGHE - COPPER	26-28	90-110							
	NON METALLICI - PLASTICS	29-30	/							
S	LEGHE RESIST. CALORE - HIG. TEMP. ALLOY	31-35	200-320	0,05	0,1	0,15		55		
	TITANIO E SUE LEGHE - TITANIUM	36-37	400-1050 ¹¹	0,05	0,1	0,15		40		
H	ACCIAIO TEMPRATO - HARDENED STEEL	38-41	45-60 ²							

⚠ - SE LA SPORGENZA DELLA FRESA È >3xD RIDURRE I PARAMETRI DI LAVORO: Vc, fz, ap DEL 30%
- IF THE PROTRUSION OF THE CUTTER IS >3xD, REDUCE CUTTING PARAMETERS: Vc, fz, ap BY 30%

$$n = \frac{Vc \cdot 1000}{\varnothing D \cdot 3,14} = \text{giri/min (min}^{-1}\text{)}$$

$$fz = fz0 \cdot Kae = \text{mm}$$

$$fn = fz \cdot z = \text{mm}$$

$$Vf = fz \cdot z \cdot n = \text{mm/min}$$

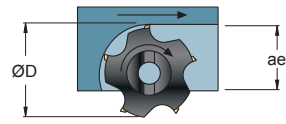

ae/D	0,5-1 50-100%	0,3 30%	0,2 20%	0,1 10%	0,05 5%	0,02 2%
Kae	1	1,2	1,5	2,1	3	4,8

ae/D	0,5-1 50-100%	0,2 20%	0,1 10%	0,05 5%
Vc Pag. 552	Vc (min)-----Vc(max)			

- F** = FINITURA, LAV. LEGGERA - FINISHING, LIGHT MACHINING
M = LAV. MEDIA, GENERICA - MEDIUM MACHINING, GENERIC
R = SGROSSATURA, LAV. PESANTE - ROUGHING, HEAVY MACHINING
- Vc** = m/min VELOCITÀ DI TAGLIO - CUTTING SPEED
n = giri/min (min⁻¹) NUMERO DI GIRI - NUMBER OF REVOLUTIONS
fz = mm AVANZAMENTO AL DENTE - TOOTH FEED
fn = mm AVANZAMENTO AL GIRO - FEED / REVOLUTION
Vf = mm/min VELOCITÀ DI AVANZAMENTO - FEED SPEED
Kae = FATTORE DI CORREZIONE - CORRECTION FACTOR

S 1086W..10
S 1086GW..10

Ø 10-32

γ_p -1,5°/+10°
 γ_f -21°/-11,5°
 γ_o -21°/-11,5°

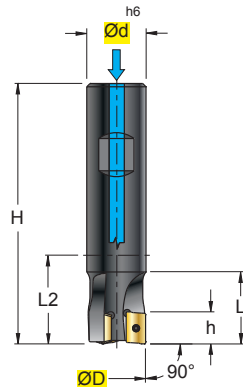

APKT 1003 .I52	
APKT 1003 .N52	
APKT 1003 .S52	
APKX 1003 .S52	
APKT 1003 .Z54	
APKT 1003 .T55	
APHT 1003 .S57	

INSERTI - INSERTS
PAG. 526

ART.	(mm)										kg	Nm				
	ØD	Ød	H	h	L	L2	Z		β							
S 1086W 010 - 10	10	16	80	10	24	32	1	/	11°	0,09	1,1+1,3	1003		12255P	5608P	
S 1086W 011 - 10	11	16	80	10	24	32	1	/	11°	0,10	1,1+1,3					
S 1086W 012 - 10	12	16	80	10	24	32	1	/	9°	0,10	1,1+1,3					
S 1086W 013 - 10	13	16	80	10	24	32	1	/	8,5°	0,10	1,1+1,3					
S 1086W 014 - 10	14	16	80	10	25	32	1	/	8°	0,10	1,1+1,3					
S 1086W 015 - 10	15	16	85	10	25	37	2	-	4°	0,10	1,1+1,3					
S 1086W 016 - 10	16	16	85	10	25	37	2	-	3,5°	0,11	1,1+1,3					
S 1086W 017 - 10	17	20	85	10	25	35	2	-	3°	0,16	1,1+1,3					
S 1086W 018 - 10	18	20	85	10	26,5	35	2	-	2,5°	0,16	1,1+1,3					
S 1086W 019 - 10	19	20	90	10	25	40	2	-	2°	0,18	1,1+1,3					
S 1086W 020 - 10	20	20	90	10	25	40	3	-	1,5°	0,18	1,1+1,3					
S 1086W 022 - 10	22	25	95	10	25	39	3	-	1,5°	0,29	1,1+1,3					
S 1086W 024 - 10	24	25	95	10	25	39	4	-	1°	0,29	1,1+1,3					
S 1086W 025 - 10	25	25	95	10	25	39	4	-	0,9°	0,30	1,1+1,3					
S 1086W 028 - 10	28	25	95	10	25	39	4	-	0,9°	0,32	1,1+1,3					
S 1086W 029 - 10	29	25	95	10	25	39	4	-	0,8°	0,32	1,1+1,3					
S 1086W 030 - 10	30	25	95	10	25	39	4	-	0,8°	0,33	1,1+1,3					
S 1086W 032 - 10	32	25	95	10	25	39	5	-	0,6°	0,33	1,1+1,3					
S 1086GW 020 - 10	20	20	90	10	25	40	2	-	1,5°	0,18	1,1+1,3	1003		12255P	5608P	
S 1086GW 025 - 10	25	25	95	10	25	39	3	-	0,9°	0,30	1,1+1,3					
S 1086GW 032 - 10	32	25	95	10	25	39	4	-	0,6°	0,33	1,1+1,3					

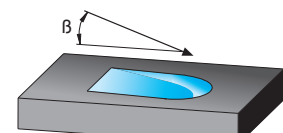
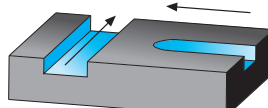
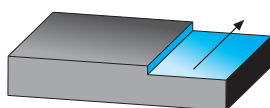

W = FORO PER LIQUIDO REFRIGERANTE - COOLANT BORE - KÜHLMITTELBOHRUNG - TROU DU LIQUIDE D'ARROSAGE

G = PASSO GROSSO - LARGE TEETH DISTANCE - NORMALE ZAHNTEILUNG - GRANDE DISTANCE DENTS.

= PASSO DIFFERENZIATO - DIFFERENTIAL PITCH - UNGLEICHE TEILUNG - PAS DIFFERENCIE

SCELTA VELOCE - QUICK PICK

Tenacità +

Toughness -

Pag. 538

COD.				P		M		K		N		S		H		HT CERMET	HW NON RIV. CEMENTED CARBIDE GRADES	HC RIVESTITI COATED GRADES BESCHICHTET RECOUVERTS																			
				F	M	R	F	M	R	F	M	R	F	M	R			F	M	R	T120	T516	T525	T526							T528N	T530	T525	F2330	F1035	F2335	l
APKT	1003	PDR	.I52	●	●	○	○	○	○	○	○	○	○	○	○																	10,5	6,70	3,50	2,8	0,5	11
APKT	1003	PDR	.N52	●	●	○	○	○	○	○	○	○	○	○	○																	10,5	6,70	3,50	2,8	0,5	11
APKT	1003	PDTR	.S52	○	○	○	○	○	○	○	○	○	○	○	○			■														10,5	6,70	3,50	2,8	0,5*	11
APKT	1003	PDR	.S52	○	○	○	○	○	○	○	○	○	○	○	○				■				■									10,5	6,70	3,50	2,8	0,5*	11
APKT	1003	PDSR	.Z54	○	○	○	○	○	○	○	○	○	○	○	○				■													10,5	6,70	3,50	2,8	0,5	11
APKT	1003	PDER	.Z54	○	○	○	○	○	○	○	○	○	○	○	○																	10,5	6,70	3,50	2,8	0,5	11
APKT	1003	PDER	.T55	○	○	○	○	○	○	○	○	○	○	○	○																	11,0	6,70	3,50	2,8	0,5	11
APHT	1003	PDFR	.S57							●	●	●	●	●	○	○	■															10,5	6,70	3,50	2,8	0,5	11

* = RAGGIO PARZIALE / PARTIAL RADIUS/ TEILRADIUS / RAYON PARTIEL

CON ADDUZIONE LUBROREFRIGERANTE - WITH COOLANT SUPPLY

SENZA ADDUZIONE LUBROREFRIGERANTE - WITHOUT COOLANT SUPPLY

MATERIALI - MATERIALS Pag. 1199		VDI 3323 GR.	HB Rm1) HRC2)	fz0 mm			Vc m/min Pag. 552									
				F	M	R	T120	T516	T525	T526	T528N	T530	F2330	F1035	F2335	
P	ACCIAIO NON LEGATO - NOT ALLOY STEEL	1-5	125-300	0,1	0,15	0,2				250	220	220	230	270	125	250
	ACCIAIO POCO LEGATO - LOW ALLOY STEEL	6-9	180-350	0,06	0,1	0,15				200	160	160	180	220	120	200
	ACCIAIO ALTO LEGATO - ALLOY STEEL	10-11	200-325	0,06	0,1	0,15				170	150	150	150	200	100	180
	INOX MARTENS. - STAINLESS STEEL MART	12-13	200-240	0,06	0,08	0,1				150	140	140	140	180	100	150
M	INOX AUST. DUPLEX - STAINLESS STEEL AUST	14.1-14.2	180-230	0,06	0,08	0,1	100		140	130	120	120	150		130	
K	GHISA GRIGIA - GREY CAST IRON	15-16	180-260	0,1	0,15	0,2	120	250	200			180	160			240
	GHISA SFEROIDALE - SPHEROIDAL GRAPHITE	17-18	160-250	0,06	0,12	0,15	110	200	180			160	150			200
	GHISA MALLEABILE - MALLEABLE CAST IRON	19-20	130-230	0,06	0,12	0,15	120	220	200			170	160			200
N	ALLUMINIO E SUE LEGHE - ALUMINIUM	21-25	60-130	0,06	0,15	0,2	500						600			
	RAME E SUE LEGHE - COPPER	26-28	90-110	0,06	0,12	0,18	300						300			
S	NON METALLICI - PLASTICS	29-30	/	0,06	0,12	0,18										
	LEGHE RESIST. CALORE - HIG. TEMP. ALLOY	31-35	200-320	0,06	0,08	0,1	20		40		40	40	40		40	
H	TITANIO E SUE LEGHE - TITANIUM	36-37	400-1050 ⁿ⁾	0,06	0,08	0,1	30		50		60	50	50		50	
	ACCIAIO TEMPRATO - HARDENED STEEL	38-41	45-60 ^{a)}	0,06	0,08	0,1			40							

$$n = \frac{Vc \cdot 1000}{\phi D \cdot 3,14} = \text{giri/min (min}^{-1}\text{)}$$

$$fz = fz0 \cdot Kae = \text{mm}$$

$$fn = fz \cdot z = \text{mm}$$

$$Vf = fz \cdot z \cdot n = \text{mm/min}$$

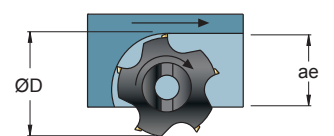

ae/D	0,5-1	0,3	0,2	0,1	0,05	0,02
50-100%	30%	20%	10%	5%	2%	
Kae	1	1,2	1,5	2,1	3	4,8

ae/D	0,5-1	0,2	0,1	0,05
	50-100%	20%	10%	5%

Vc
Pag. 552

Vc (min)-----Vc(max)

- F** = FINITURA , LAV. LEGGERA - FINISHING , LIGHT MACHINING
 - M** = LAV. MEDIA , GENERIC - MEDIUM MACHINING , GENERIC
 - R** = SGROSSATURA , LAV. PESANTE - ROUGHING , HEAVY MACHINING
- Vc** = m/min VELOCITÀ DI TAGLIO - CUTTING SPEED
 - n** = giri/min (min⁻¹) NUMERO DI GIRI - NUMBER OF REVOLUTIONS
 - fz** = mm AVANZAMENTO AL DENTE -TOOTH FEED
 - fn** = mm AVANZAMENTO AL GIRO - FEED / REVOLUTION
 - Vf** = mm/min VELOCITÀ DI AVANZAMENTO - FEED SPEED
 - Kae** = FATTORE DI CORREZIONE - CORRECTION FACTOR

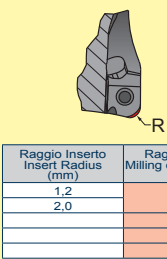

- Per usare inserti con r≥1,2mm, bisogna modificare il corpo fresa come indicato in figura.
- To use inserts with r≥1,2mm, it is necessary to modify the milling cutting body as illustrated in the figure
- Um wendeschneidplatten mit r≥1,2mm, muss der fräserkörper wie in der abbildung angegeben verändert werden
- Pour utiliser les plaquettes avec r≥1,2mm, il faut modifier le corps de la fraise comme il est indiqué dans l'illustration.







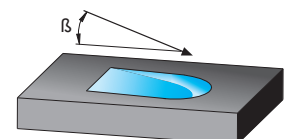
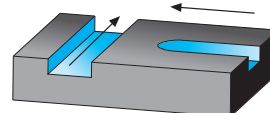
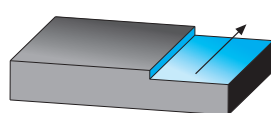
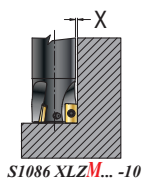

Raggio Inserto Insert Radius (mm)	Raggio Fresa Milling cutter Radius (mm)
1,2	R1,0
2,0	

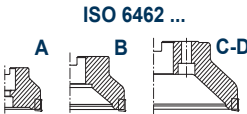
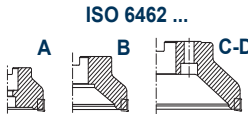
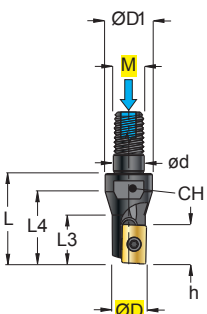
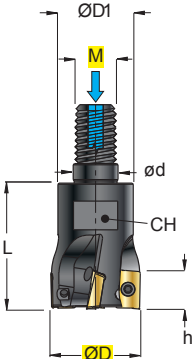
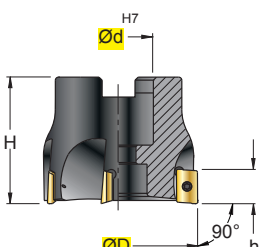
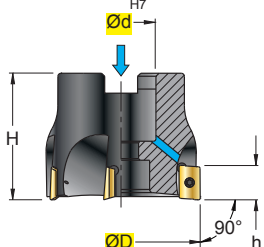
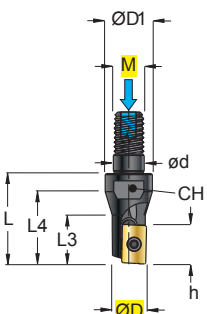







S 1086GXL..10		S 1086XLZ..10		S 1086XLZM..10		APKT 1003 .I52	
Ø 20-40	$\gamma_p +7^\circ/+10^\circ$ $\gamma_f -13,5^\circ/-10^\circ$ $\gamma_o -13,5^\circ/-10^\circ$	Ø 10-32	$\gamma_p -1,5^\circ/+10^\circ$ $\gamma_f -21^\circ/-11,5^\circ$ $\gamma_o -21^\circ/-11,5^\circ$	Ø 16-25	$\gamma_p -1,5^\circ/+10^\circ$ $\gamma_f -21^\circ/-11,5^\circ$ $\gamma_o -21^\circ/-11,5^\circ$	APKT 1003 .N52	
						APKT 1003 .S52	
						APKX 1003 .S52	
						APKT 1003 .Z54	
						APKT 1003 .T55	
						APHT 1003 .S57	
						INSERTI - INSERTS PAG. 526	

(mm)																	
ART.	ØD	Ød/CM	ØD1	H	h	L	L2	L3	β	Z	X	kg	Nm				
S 1086GXL 020 - 10	20	20	-	130	10	40	80	-	1,5°	2	-	0,29	1,1+1,3	1003	12255P	5608P	
S 1086GXL 025 - 10	25	25	-	140	10	40	84	-	0,9°	3	-	0,47	1,1+1,3				
S 1086GXL 032 - 10	32	32	-	160	10	50	100	-	0,6°	4	-	0,93	1,1+1,3				
S 1086GXL 040 - 10	40	32	-	200	10	60	140	-	-	5	-	1,23	1,1+1,3				
S 1086XLZ 010 - 10	10	20	11,5	200	10	50	-	18	11°	1	/	0,40	1,1+1,3	1003	12255P	5608P	
S 1086XLZ 011 - 10	11	20	13,5	200	10	50	-	19	11°	1	/	0,41	1,1+1,3				
S 1086XLZ 012 - 10	12	20	13,5	200	10	50	-	21	9°	1	/	0,41	1,1+1,3				
S 1086XLZ 013 - 10	13	20	15,0	200	10	50	-	22	8,5°	1	/	0,42	1,1+1,3				
S 1086XLZ 014 - 10	14	20	15,5	200	10	50	-	21	8°	1	/	0,43	1,1+1,3				
S 1086XLZ 015 - 10	15	20	16,0	200	10	50	-	23	4°	2	-	0,42	1,1+1,3				
S 1086XLZ 016 - 10	16	20	17,0	200	10	50	-	35	3,5°	2	-	0,43	1,1+1,3				
S 1086XLZ 017 - 10	17	20	18,0	200	10	50	-	35	3°	2	-	0,44	1,1+1,3				
S 1086XLZ 018 - 10	18	20	19,0	200	10	50	-	35	2,5°	2	-	0,44	1,1+1,3				
S 1086XLZ 019 - 10	19	20	19,0	200	10	50	-	35	2°	2	-	0,45	1,1+1,3				
S 1086XLZ 020 - 10	20	20	-	200	10	50	-	50	1,5°	2	-	0,46	1,1+1,3				
S 1086XLZ 022 - 10	22	25	-	220	10	50	-	50	1,5°	2	-	0,76	1,1+1,3				
S 1086XLZ 024 - 10	24	25	-	220	10	50	-	50	1°	3	-	0,79	1,1+1,3				
S 1086XLZ 025 - 10	25	25	-	220	10	50	-	50	0,9°	3	-	0,80	1,1+1,3				
S 1086XLZ 028 - 10	28	32	-	250	10	50	-	50	0,9°	3	-	1,44	1,1+1,3				
S 1086XLZ 029 - 10	29	32	-	250	10	50	-	50	0,8°	3	-	1,46	1,1+1,3				
S 1086XLZ 030 - 10	30	32	-	250	10	50	-	50	0,8°	4	-	1,46	1,1+1,3				
S 1086XLZ 032 - 10	32	32	-	250	10	50	-	50	0,6°	4	-	1,50	1,1+1,3				
S 1086XLZM 016 - 10	16	15	-	150	10	25	-	-	1,5°	2	-	0,5	0,20	1,1+1,3	1003	12255P	5608P
S 1086XLZM 020 - 10	20	19	-	160	10	25	-	-	1,5°	2	-	0,5	0,34	1,1+1,3			
S 1086XLZM 025 - 10	25	24	-	200	10	25	-	-	0,9°	3	-	0,5	0,68	1,1+1,3			



XLZ = EXTRALUNGA, STELO CILINDRICO - EXTRALONG, CYLINDRICAL SHANK - EXTRALANG, ZYLINDERSCHAFT - EXTRALONGUE, QUEUE CYLINDRIQUE
 GXL = PASSO GROSSO EXTRALUNGA - EXTRALONG WITH LARGE TEETH DISTANCE - EXTRALANG MIT NORMAL ZUHNTAILUNG - EXTRALONGUE AVEC GRANDE DISTANCE DENTS
 = PASSO DIFFERENZIATO - DIFFERENTIAL PITCH - UNGLEICHE TEILUNG - PAS DIFFERENCIÉ

S 1088 .. 10	S 1088W .. 10 S 1088GW .. 10	S 1089W ..	APKT 1003 .I52
$\varnothing 40-63$ $\gamma_p +11^\circ/+12^\circ$ $\gamma_f -10^\circ/-8^\circ$ $\gamma_o -10^\circ/-8^\circ$	$\varnothing 40-63$ $\gamma_p +11^\circ/+12^\circ$ $\gamma_f -10^\circ/-8^\circ$ $\gamma_o -10^\circ/-8^\circ$	$\varnothing 10-32$ $\gamma_p -1,5^\circ/+10^\circ$ $\gamma_f -21^\circ/-11,5^\circ$ $\gamma_o -21^\circ/-11,5^\circ$	
ISO 6462 ... 	ISO 6462 ... 	FORM A 	FORM B 
			
			
			
			
			
			
			 INSERTI - INSERTS PAG. 526

(mm)																					  		
ART.	FORM	$\varnothing D$	M	$\varnothing d$	$\varnothing D1$	H	h	L	L3	L4	β	Z		CH	kg	Nm	ISO 6462						
S 1088	040 - 10	40	-	22	40	10	-	-	-	-	-	6	-	-	0,210	1,1+1,3	A	1003	12255P	5608P	VBSF10		
S 1088	050 - 10	50	-	22	40	10	-	-	-	-	-	7	-	-	0,320	1,1+1,3	A						
S 1088	063 - 10	63	-	22	40	10	-	-	-	-	-	8	-	-	0,550	1,1+1,3	A						
S 1088W	040 - 10	40	-	22	40	10	-	-	-	-	-	6	-	-	0,210	1,1+1,3	A	1003	12255P	5608P	VBSF10		
S 1088W	050 - 10	50	-	22	40	10	-	-	-	-	-	7	-	-	0,320	1,1+1,3	A						
S 1088W	063 - 10	63	-	22	40	10	-	-	-	-	-	8	-	-	0,350	1,1+1,3	A						
S 1088GW	040 - 10	40	-	22	40	10	-	-	-	-	-	5	-	-	0,210	1,1+1,3	A	1003	12255P	5608P	VBSF10		
S 1088GW	050 - 10	50	-	22	40	10	-	-	-	-	-	6	-	-	0,320	1,1+1,3	A						
S 1088GW	063 - 10	63	-	22	40	10	-	-	-	-	-	7	-	-	0,550	1,1+1,3	A						
S 1089W	10 25 01.10	10	8	8,5	13	-	10	25	13,5	20	11°	1	/	10	0,017	1,1+1,3	-	1003	12255P	5608P	-		
S 1089W	12 25 01.10	12	8	8,5	13	-	10	25	13	20	9°	1	/	10	0,020	1,1+1,3	-						
S 1089W	16 25 02.10	16	8	8,5	13	-	10	25	-	-	3,5°	2	-	10	0,023	1,1+1,3	-						
S 1089W	20 30 03.10	20	10	10,5	18	-	10	30	-	-	1,5°	3	-	15	0,049	1,1+1,3	-						
S 1089W	25 35 03.10	25	12	12,5	21	-	10	35	-	-	0,9°	3	-	17	0,090	1,1+1,3	-						
S 1089W	25 35 04.10	25	12	12,5	21	-	10	35	-	-	0,9°	4	-	17	0,089	1,1+1,3	-						
S 1089W	32 43 05.10	32	16	17	29	-	10	43	-	-	0,6°	5	-	24	0,212	1,1+1,3	-						

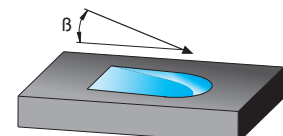
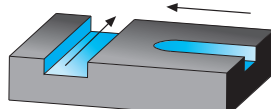
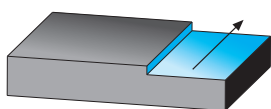

W = FORO PER LIQUIDO REFRIGERANTE - COOLANT BORE - KÜHLMITTELBOHRUNG - TROU DU LIQUIDE D'ARROSAGE

G = PASSO GROSSO - LARGE TEETH DISTANCE - NORMALE ZAHNTEILUNG - GRANDE DISTANCE DENTS.

 = PASSO DIFFERENZIATO - DIFFERENTIAL PITCH - UNGLEICHE TEILUNG - PAS DIFFERENCIE

SCELTA VELOCE - QUICK PICK													Tenacità + ↑ Toughness - ↓		Pag. 538		HT	HW	HC																		
COD.				P			M			K			N			S			H			T120	T516	T525	T526	T528N	T530	T525	F2330	F1035	F2335	l	d	s	d1	r	a°
				F	M	R	F	M	R	F	M	R	F	M	R	F	M	R	F	M	R																
APKT	1003	PDR	.I52	●	●	○	○	○	○	○	○	○	○																10,5	6,70	3,50	2,8	0,5	11			
APKT	1003	PDR	.N52	●	●	○	○	○	○	○	○	○	○																10,5	6,70	3,50	2,8	0,5	11			
APKT	1003	PDTR	.S52									●	●																10,5	6,70	3,50	2,8	0,5*	11			
APKT	1003	PDR	.S52	○	●	●	●	●	○				○																10,5	6,70	3,50	2,8	0,5*	11			
APKT	1003	PDSR	.Z54	○	●	●	○	○																					10,5	6,70	3,50	2,8	0,5	11			
APKT	1003	PDER	.Z54	●	●																								10,5	6,70	3,50	2,8	0,5	11			
APKT	1003	PDER	.T55		○			●					○		●														11,0	6,70	3,50	2,8	0,5	11			
APHT	1003	PDFR	.S57					●	●	●	●	○	○								■								10,5	6,70	3,50	2,8	0,5	11			

* = RAGGIO PARZIALE / PARTIAL RADIUS/ TEILRADIUS / RAYON PARTIEL

CON ADDUZIONE LUBROREFRIGERANTE - WITH COOLANT SUPPLY

SENZA ADDUZIONE LUBROREFRIGERANTE - WITHOUT COOLANT SUPPLY

MATERIALI - MATERIALS		VDI 3323 GR.	HB Rm1) HRC2)	fz0 mm			Vc m/min											
Pag. 1199				F	M	R	T120	T516	T525	T526	T528N	T530	F2330	F1035	F2335			
P	ACCIAIO NON LEGATO - NOT ALLOY STEEL	1-5	125-300	0,1	0,15	0,2				250	220	220	230	270	125	250		
	ACCIAIO POCO LEGATO - LOW ALLOY STEEL	6-9	180-350	0,06	0,1	0,15				200	160	160	180	220	120	200		
	ACCIAIO ALTO LEGATO - ALLOY STEEL	10-11	200-325	0,06	0,1	0,15				170	150	150	150	200	100	180		
	INOX MARTENS. - STAINLESS STEEL MART	12-13	200-240	0,06	0,08	0,1				150	140	140	140	180	100	150		
M	INOX AUST. DUPLEX - STAINLESS STEEL AUST	14.1-14.2	180-230	0,06	0,08	0,1	100			140	130	120	120	150		130		
K	GHISA GRIGIA - GREY CAST IRON	15-16	180-260	0,1	0,15	0,2	120	250	200				180	160			240	
	GHISA SFEROIDALE - SPHEROIDAL GRAPHITE	17-18	160-250	0,06	0,12	0,15	110	200	180				160	150			200	
	GHISA MALLEABILE - MALLEABLE CAST IRON	19-20	130-230	0,06	0,12	0,15	120	220	200				170	160			200	
N	ALLUMINIO E SUE LEGHE - ALUMINIUM	21-25	60-130	0,06	0,15	0,2	500							600				
	RAME E SUE LEGHE - COPPER	26-28	90-110	0,06	0,12	0,18	300							300				
S	NON METALLICI - PLASTICS	29-30	/	0,06	0,12	0,18												
	LEGHE RESIST. CALORE - HIG. TEMP. ALLOY	31-35	200-320	0,06	0,08	0,1	20			40			40	40		40		
	TITANIO E SUE LEGHE - TITANIUM	36-37	400-1050 ⁹⁾	0,06	0,08	0,1	30			50			60	50		50		
H	ACCIAIO TEMPRATO - HARDENED STEEL	38-41	45-60 ^{a)}	0,06	0,08	0,1				40								

$$n = \frac{Vc \cdot 1000}{\phi D \cdot 3,14} = \text{giri/min (min}^{-1}\text{)}$$

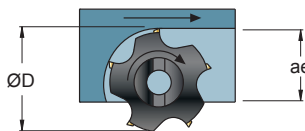

$$fz = fz0 \cdot Kae = \text{mm}$$

$$fn = fz \cdot z = \text{mm}$$

$$Vf = fz \cdot z \cdot n = \text{mm/min}$$

ae/D	0,5-1	0,3	0,2	0,1	0,05	0,02
Kae	1	1,2	1,5	2,1	3	4,8





ae/D	0,5-1	0,2	0,1	0,05
	50-100%	20%	10%	5%
Vc	Vc (min)-----Vc(max)			
Pag. 552				

F = FINITURA, LAV. LEGGERA - FINISHING, LIGHT MACHINING
M = LAV. MEDIA, GENERICA - MEDIUM MACHINING, GENERIC
R = SGROSSATURA, LAV. PESANTE - ROUGHING, HEAVY MACHINING

Vc = m/min VELOCITÀ DI TAGLIO - CUTTING SPEED
n = giri/min (min⁻¹) NUMERO DI GIRI - NUMBER OF REVOLUTIONS
fz = mm AVANZAMENTO AL DENTE - TOOTH FEED
fn = mm AVANZAMENTO AL GIRO - FEED / REVOLUTION
Vf = mm/min VELOCITÀ DI AVANZAMENTO - FEED SPEED
Kae = FATTORE DI CORREZIONE - CORRECTION FACTOR

Raggio Inserto Insert Radius (mm)	Raggio Fresa Milling cutter Radius (mm)
1,2	R1,0
2,0	

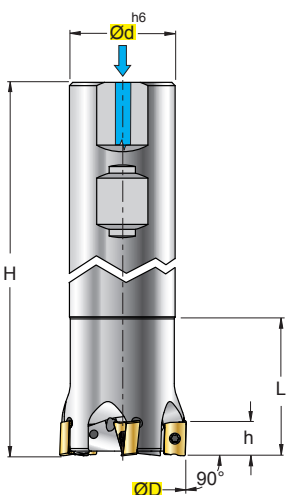
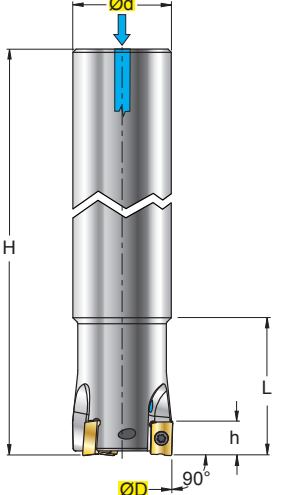
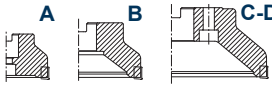
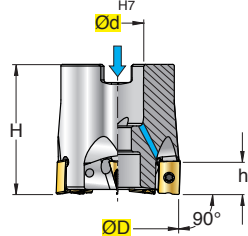
- Per usare inserti con r≥1,2mm, bisogna modificare il corpo fresa come indicato in figura.
- To use inserts with r≥1,2mm, it is necessary to modify the milling cutting body as illustrated in the figure.
- Um wendeschneidplatten mit r≥1,2mm, muss der fräserkörper wie in der abbildung angegeben verändert werden.
- Pour utiliser les plaquettes avec r≥1,2mm, il faut modifier le corps de la fraise comme il est indiqué dans l'illustration.

S 9001-6W..-10	S 9001-6XLW..-10 S 9001-6XLMW..-10	S 9001-8W..-10	LNMM 1006 .F56 
$\varnothing 20-40$ $\gamma_p -6^\circ$ $\gamma_f -27^\circ/-17,5^\circ$ $\gamma_o -27^\circ/-17,5^\circ$	$\varnothing 20-32$ $\gamma_p -6^\circ$ $\gamma_f -27^\circ/-19^\circ$ $\gamma_o -27^\circ/-19^\circ$	$\varnothing 40-63$ $\gamma_p -6,35^\circ/-6^\circ$ $\gamma_f -17,5^\circ/-13^\circ$ $\gamma_o -17,5^\circ/-13^\circ$	LNMM 1006 .F61 
		ISO 6462 ...  	
			 INSERTI - INSERTS PAG. 528

(mm)															
ART.	$\varnothing D$	$\varnothing d$	H	h	L	β	Z		 kg	 Nm	ISO 6462				
S9001-6W-020-02-10	20	20	100	9	30	4°	2	—	0,20	1,5+2,0	—	1006	C03007	5609	—
S9001-6W-020-03-10	20	20	100	9	30	4°	3	—	0,20	1,5+2,0	—	1006	C03007	5609	—
S9001-6W-025-02-10	25	25	115	9	35	3,5°	2	—	0,41	1,5+2,0	—	1006	C03007	5609	—
S9001-6W-025-03-10	25	25	115	9	35	3,5°	3	—	0,41	1,5+2,0	—	1006	C03007	5609	—
S9001-6W-032-03-10	32	32	125	9	42	3°	3	—	0,76	1,5+2,0	—	1006	C03007	5609	—
S9001-6W-032-04-10	32	32	125	9	42	3°	4	—	0,76	1,5+2,0	—	1006	C03007	5609	—
S9001-6W-040-04-10	40	32	130	9	42	2°	4	—	0,87	1,5+2,0	—	1006	C03007	5609	—
S9001-6W-040-05-10	40	32	130	9	42	2°	5	—	0,87	1,5+2,0	—	1006	C03007	5609	—
S9001-6XLW-020-02-10	20	20	150	9	30	4°	2	—	0,31	1,5+2,0	—	1006	C03007	5609	—
S9001-6XLW-025-02-10	25	25	150	9	35	3,5°	2	—	0,51	1,5+2,0	—	1006	C03007	5609	—
S9001-6XLW-032-03-10	32	32	180	9	42	3°	3	—	0,99	1,5+2,0	—	1006	C03007	5609	—
S9001-6XLMW-020-02-10	20	19	150	9	30	4°	2	—	0,31	1,5+2,0	—	1006	C03007	5609	—
S9001-6XLMW-025-02-10	25	24	150	9	35	3,5°	2	—	0,51	1,5+2,0	—	1006	C03007	5609	—
S9001-6XLMW-032-03-10	32	30	180	9	42	3°	3	—	0,99	1,5+2,0	—	1006	C03007	5609	—
S9001-8W-040-04-10	40	16	40	9	—	2°	4	—	0,24	1,5+2,0	A	1006	C03007	5609	VBSF08L
S9001-8W-040-05-10	40	16	40	9	—	2°	5	—	0,24	1,5+2,0	A	1006	C03007	5609	VBSF10
S9001-8W-050-05-10	50	22	40	9	—	1,5°	5	—	0,35	1,5+2,0	A	1006	C03007	5609	VBSF10
S9001-8W-050-07-10	50	22	40	9	—	1,5°	7	—	0,35	1,5+2,0	A	1006	C03007	5609	VBSF10
S9001-8W-063-06-10	63	22	40	9	—	1°	6	—	0,60	1,5+2,0	A	1006	C03007	5609	VBSF10
S9001-8W-063-08-10	63	22	40	9	—	1°	8	—	0,60	1,5+2,0	A	1006	C03007	5609	VBSF10

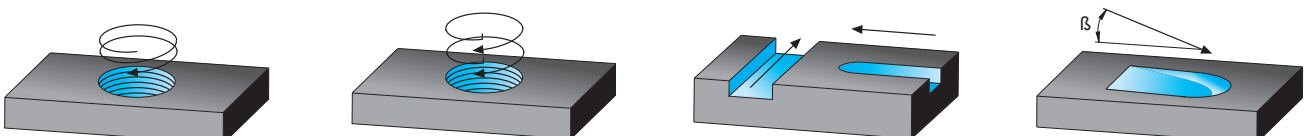

W = FORO PER LIQUIDO REFRIGERANTE - COOLANT BORE - KÜHLMITTELBOHRUNG - TROU DU LIQUIDE D'ARROSAGE
 = PASSO DIFFERENZIATO - DIFFERENTIAL PITCH - UNGLEICHE TEILUNG - PAS DIFFERENCE

SCELTA VELOCE - QUICK PICK												HT		HW	HC						Diagram												
												CERMET		NON RIV. CEMENTED CARBIDE GRADES	RIVESTITI COATED GRADES BESCHICHTET RECOUVERTS																		
COD.		P			M			K			N			S			H			HT	HW	T3116	F3120	F3420	F1325	F1335	F4345	l	d	s	d1	r	a°
F	M	R	F	M	R	F	M	R	F	M	R	F	M	R	F	M	R	F	M	R													
LNMM	100605	.F56	○	●	○	○	○	○	○	○	○																						
LNMM	100605	.F61	○	○				●	●																								

Tenacità + ↑
Toughness - ↓

Pag. 538

CON ADDUZIONE LUBROREFRIGERANTE - WITH COOLANT SUPPLY

SENZA ADDUZIONE LUBROREFRIGERANTE - WITHOUT COOLANT SUPPLY

MATERIALI - MATERIALS Pag. 1199		VDI 3323 GR.	HB Rm1) HRC2)	fz0 mm			Vc m/min Pag. 552																						
				F	M	R	T3116	F3120	F3420	F1325	F1335	F4345																	
P	ACCIAIO NON LEGATO - NOT ALLOY STEEL	1-5	125-300	0,08	0,15	0,25		200		230	220	200																	
	ACCIAIO POCO LEGATO - LOW ALLOY STEEL	6-9	180-350	0,08	0,15	0,2		180		190	180	170																	
	ACCIAIO ALTO LEGATO - ALLOY STEEL	10-11	200-325	0,06	0,12	0,16		160		170	160	160																	
	INOX MARTENS. - STAINLESS STEEL MART	12-13	200-240	0,08	0,12	0,15		120																					
M	INOX AUST. DUPLEX - STAINLESS STEEL AUST	14.1-14.2	180-230	0,08	0,12	0,15				100	90	80																	
	GHISA GRIGIA - GREY CAST IRON	15-16	180-260	0,08	0,18	0,25	310	280	250	220																			
K	GHISA SFEROIDALE - SPHEROIDAL GRAPHITE	17-18	160-250	0,08	0,15	0,2	180	260	260	180																			
	GHISA MALLEABILE - MALLEABLE CAST IRON	19-20	130-230	0,08	0,15	0,2	280	240	240	160																			
N	ALLUMINIO E SUE LEGHE - ALUMINIUM	21-25	60-130																										
	RAME E SUE LEGHE - COPPER	26-28	90-110																										
S	LEGHE RESIST. CALORE - HIG. TEMP. ALLOY	31-35	200-320																										
	TITANIO E SUE LEGHE - TITANIUM	36-37	400-1050 ⁹⁾																										
H	ACCIAIO TEMPRATO - HARDENED STEEL	38-41	45-60 ⁸⁾																										

$$n = \frac{V_c \cdot 1000}{\varnothing D \cdot 3,14} = \text{giri/min (min}^{-1}\text{)}$$

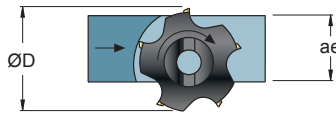

$$fz = fz0 \cdot Kae = \text{mm}$$

$$fn = fz \cdot z = \text{mm}$$

$$Vf = fz \cdot z \cdot n = \text{mm/min}$$

ae/D	0,5-1 50-100%	0,2 20%	0,1 10%	0,05 5%	0,02 2%
Kae	1	1,1	1,2	1,3	1,5

ae/D	0,5-1 50-100%	0,2 20%	0,1 10%	0,05 5%
Vc	Vc (min)-----Vc(max) Pag. 552			

F = FINITURA , LAV. LEGGERA - FINISHING , LIGHT MACHINING
M = LAV. MEDIA , GENERICA - MEDIUM MACHINING , GENERIC
R = SGROSSATURA , LAV. PESANTE - ROUGHING , HEAVY MACHINING

Vc = m/min VELOCITÀ DI TAGLIO - CUTTING SPEED
n = giri/min (min⁻¹) NUMERO DI GIRI - NUMBER OF REVOLUTIONS
fz = mm AVANZAMENTO AL DENTE -TOOTH FEED
fn = mm AVANZAMENTO AL GIRO - FEED / REVOLUTION
Vf = mm/min VELOCITÀ DI AVANZAMENTO - FEED SPEED
Kae = FATTORE DI CORREZIONE - CORRECTION FACTOR

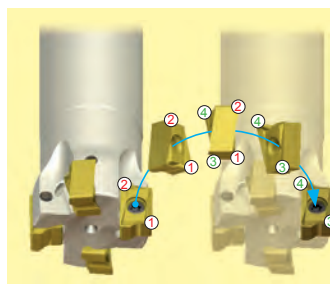

- 4 Taglienti "Utili" disponibili grazie all'inserto bilaterale.
- 4 "Useful" cutting-edges thanks to two-sided insert
- "Nützliche" schneidkanten dank zweiseitiger wendeschneidplatten
- Tranchants "Utiles" disponibles grace a la plaquette bilaterale

S 9001-6W..-15

Ø 32-40

γ_p -6°
 γ_f -24°/-20°
 γ_o -24°/-20°

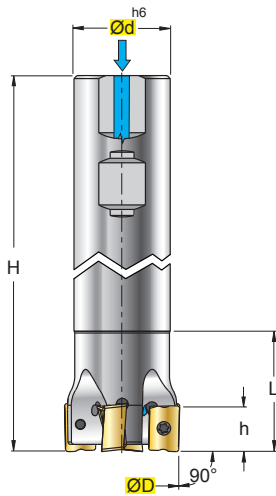

S 9001-8W..-15

Ø 50-80

γ_p -6,35°/-6°
 γ_f -17°
 γ_o -17°

ISO 6462 ...

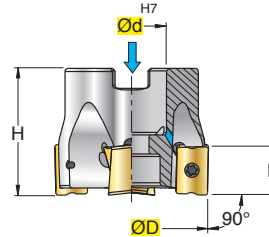
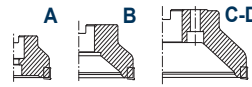

LNMM 1510
.F56



LNMM 1510
.F61



INSERTI - INSERTS
PAG. 528



ART.	(mm)										ISO 6462	1510	1240P	5615P	-
	ØD	Ød	H	h	L	β	Z	kg	Nm						
S9001-6W-032-02-15	32	32	125	14	40	2,5°	2	-	0,71	3,8+5	-	1510	1240P	5615P	-
S9001-6W-032-03-15	32	32	125	14	40	2,5°	3	-	0,71	3,8+5	-				
S9001-6W-040-03-15	40	32	130	14	40	2°	3	-	0,78	3,8+5	-				
S9001-6W-040-04-15	40	32	130	14	40	2°	4	-	0,78	3,8+5	-				
S9001-8W-050-03-15	50	22	40	14	-	2°	3	-	0,31	3,8+5	A	1510	1240P	5615P	VBSF10
S9001-8W-050-04-15	50	22	40	14	-	2°	4	-	0,31	3,8+5	A				
S9001-8W-063-04-15	63	22	40	14	-	2°	4	-	0,54	3,8+5	A				
S9001-8W-063-06-15	63	22	40	14	-	2°	6	-	0,54	3,8+5	A				
S9001-8W-080-05-15	80	27	50	14	-	1,5°	5	-	1,0	3,8+5	A-B	1510	1240P	5615P	AL12x35
S9001-8W-080-07-15	80	27	50	14	-	1,5°	7	-	1,0	3,8+5	A-B				

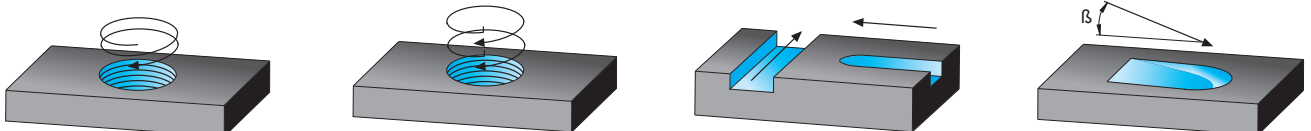

W = FORO PER LIQUIDO REFRIGERANTE - COOLANT BORE - KÜHLMITTELBOHRUNG - TROU DU LIQUIDE D'ARROSAGE
↻ = PASSO DIFFERENZIATO - DIFFERENTIAL PITCH - UNGLEICHE TEILUNG - PAS DIFFERENCIE

SCELTA VELOCE - QUICK PICK

Tenacità + ↑ ↑
Toughness - ↓ ↓

Pag. 538

COD.	P			M			K			N			S			H			HT	HW	HC						l	d	s	d1	r	a°			
	F	M	R	F	M	R	F	M	R	F	M	R	F	M	R	F	M	R			T3116	F3120	F3420	F1325	F1335	F4345									
LNMM 151008 .F56	○	●	●	○	○	○	○	○	○	○	○										■	■	■												
LNMM 151008 .F61		○	○						●	●											■	■													

CON ADDUZIONE LUBROREFRIGERANTE - WITH COOLANT SUPPLY

SENZA ADDUZIONE LUBROREFRIGERANTE - WITHOUT COOLANT SUPPLY

MATERIALI - MATERIALS Pag. 1199		VDI 3323 GR.	HB Rm1) HRC2)	fz0 mm			Vc m/min Pag. 552											
				F	M	R	T3116	F3120	F3420	F1325	F1335	F4345						
P	ACCIAIO NON LEGATO - NOT ALLOY STEEL	1--5	125-300	0,08	0,15	0,25		200		230	220	200						
	ACCIAIO POCO LEGATO - LOW ALLOY STEEL	6-9	180-350	0,08	0,15	0,2		180		190	180	170						
	ACCIAIO ALTO LEGATO - ALLOY STEEL	10-11	200-325	0,06	0,12	0,16		160		170	160	160						
	INOX MARTENS. - STAINLESS STEEL MART	12-13	200-240	0,08	0,12	0,15		120										
M	INOX AUST. DUPLEX - STAINLESS STEEL AUST	14.1-14.2	180-230	0,08	0,12	0,15				100	90	80						
	GHISA GRIGIA - GREY CAST IRON	15-16	180-260	0,08	0,18	0,25	310	280	250	220								
	GHISA SFEROIDALE - SPHEROIDAL GRAPHITE	17-18	160-250	0,08	0,15	0,2	180	260	260	180								
K	GHISA MALLEABILE - MALLEABLE CAST IRON	19-20	130-230	0,08	0,15	0,2	280	240	240	160								
	ALLUMINIO E SUE LEGHE - ALUMINIUM	21--25	60-130															
N	RAME E SUE LEGHE - COPPER	26-28	90-110															
	NON METALLICI - PLASTICS	29-30	/															
S	LEGHE RESIST. CALORE - HIG. TEMP. ALLOY	31--35	200-320															
	TITANIO E SUE LEGHE - TITANIUM	36-37	400-1050 ¹⁾															
H	ACCIAIO TEMPRATO - HARDENED STEEL	38-41	45-60 ²⁾															

$$n = \frac{Vc \cdot 1000}{\phi D \cdot 3,14} = \text{giri/min (min}^{-1}\text{)}$$

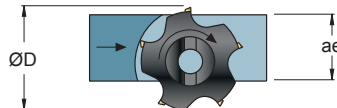

$$fz = fz0 \cdot Kae = \text{mm}$$

$$fn = fz \cdot z = \text{mm}$$

$$Vf = fz \cdot z \cdot n = \text{mm/min}$$

ae/D	0,5-1 50-100%	0,2 20%	0,1 10%	0,05 5%	0,02 2%
Kae	1	1,1	1,2	1,3	1,5





ae/D	0,5-1 50-100%	0,2 20%	0,1 10%	0,05 5%
Vc Pag. 552	Vc (min)-----Vc(max)			

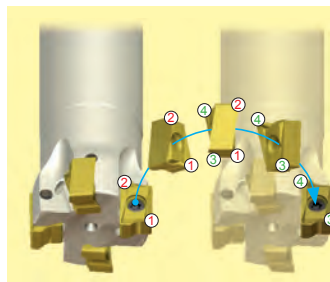



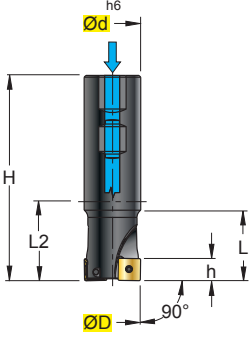
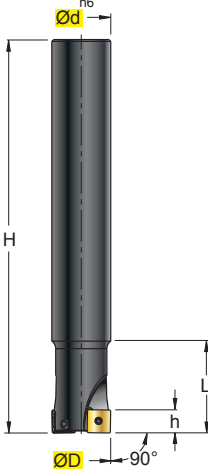

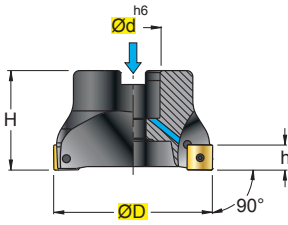
F = FINITURA , LAV. LEGGERA - FINISHING , LIGHT MACHINING
M = LAV. MEDIA , GENERICA - MEDIUM MACHINING , GENERIC
R = SGROSSATURA , LAV. PESANTE - ROUGHING , HEAVY MACHINING

Vc = m/min VELOCITÀ DI TAGLIO - CUTTING SPEED
n = giri/min (min⁻¹) NUMERO DI GIRI - NUMBER OF REVOLUTIONS
fz = mm AVANZAMENTO AL DENTE -TOOTH FEED
fn = mm AVANZAMENTO AL GIRO - FEED / REVOLUTION
Vf = mm/min VELOCITÀ DI AVANZAMENTO - FEED SPEED
Kae = FATTORE DI CORREZIONE - CORRECTION FACTOR

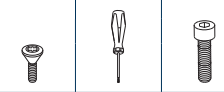

- 4 Taglienti "Utili" disponibili grazie all'inserto bilaterale.
- 4 "Useful" cutting-edges thanks to two-sided insert
- 4 "Nützliche" schneidkanten dank zweiseitiger wendeschneidplatten
- 4 Tranchants "Utiles" disponibles grace a la plaquette bilaterale

S 1296W .. 12		S 1296XLZ .. 12		S 1298W ..12 S 1298GW..12 S 1298G..12		SDMT 1205 .F58	
Ø 32-40	γ_p +8°/+7° γ_f -9°/-8° γ_o -9°/-8°	Ø 32-40	γ_p +8°/+7° γ_f -9°/-8° γ_o -9°/-8°	Ø 50-250	γ_p +7°/+8° γ_f -8°/-1,6° γ_o -8°/-1,6°		
				<p>ISO 6462 ...</p>  		 INSERTI - INSERTS PAG. 531	

(mm)																		
ART.	ØD	Ød	H	h	L	L2	Z		kg	Nm	ISO 6462							
S 1296W 032 - 12	32	32	110	10,5	40	50	2	—	0,545	3,8+5,0	—	1205	124011P	5620P	—			
S 1296W 040 - 12	40	32	115	10,5	45	45	3	—	0,618	3,8+5,0	—							
S 1296XLZ 032 - 12	32	32	250	10,5	40	—	2	—	1,432	3,8+5,0	—	1205	124011P	5620P	—			
S 1296XLZ 040 - 12	40	40	250	10,5	45	—	3	—	2,247	3,8+5,0	—							
S 1298W 050 - 12	50	22	40	10,5	—	—	5	Y	0,295	3,8+5,0	A	1205	124011P	5620P	VBSF10			
S 1298W 063 - 12	63	22	40	10,5	—	—	6	Y	0,470	3,8+5,0	A							
S 1298W 080 - 12	80	27	50	10,5	—	—	6	Y	1,040	3,8+5,0	A	1205	124011P	5620P	VBSF12			
S 1298W 100 - 12	100	32	50	10,5	—	—	8	Y	1,600	3,8+5,0	A	1205	124011P	5620P	VBSF16			
S 1298W 125 - 12	125	40	63	10,5	—	—	9	Y	3,300	3,8+5,0	A	1205	124011P	5620P	VBSF20			
S 1298GW 050 - 12	50	22	40	10,5	—	—	3	—	0,289	3,8+5,0	A	1205	124011P	5620P	VBSF10			
S 1298GW 063 - 12	63	22	40	10,5	—	—	4	Y	0,474	3,8+5,0	A							
S 1298GW 080 - 12	80	27	50	10,5	—	—	5	Y	1,04	3,8+5,0	A	1205	124011P	5620P	VBSF12			
S 1298GW 100 - 12	100	32	50	10,5	—	—	6	Y	1,61	3,8+5,0	A-B	1205	124011P	5620P	VBSF16			
S 1298GW 125 - 12	125	40	63	10,5	—	—	7	Y	3,275	3,8+5,0	A-B	1205	124011P	5620P	VBSF20			
S 1298G 160 - 12	160	40	63	10,5	—	—	8	Y	3,74	3,8+5,0	C	1205	124011P	5620P	—			
S 1298G 200 - 12	200	60	63	10,5	—	—	10	Y	7,07	3,8+5,0	D							
S 1298G 250 - 12	250	60	63	10,5	—	—	12	Y	10,06	3,8+5,0	D							

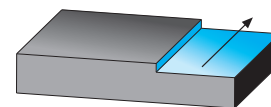
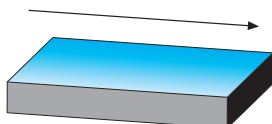

W = FORO PER LIQUIDO REFRIGERANTE - COOLANT BORE - KÜHLMITTELBOHRUNG - TROU DU LIQUIDE D'ARROSAGE
 XLZ = EXTRALUNGA, STELO CILINDRICO - EXTRALONG, CYLINDRICAL SHANK - EXTRALANG, ZYLINDERSCHAFT - EXTRALONGUE, QUEUE CYLINDRIQUE
 G = PASSO GROSSO - LARGE TEETH DISTANCE - NORMALE ZAHNTEILUNG - GRANDE DISTANCE DENTS.
 = PASSO DIFFERENZIATO - DIFFERENTIAL PITCH - UNGLEICHE TEILUNG - PAS DIFFERENCIE

SCelta VELOCE - QUICK PICK		Tenacità + ↑		Toughness - ↓		Pag. 538		HT	HW	HC																								
		COD.		P		M		K		N		S		H		HT	HW	HC			l	d	s	d1	r	a°								
		F	M	R	F	M	R	F	M	R	F	M	R	F	M	R	F	M	R	F	M	R	F	M	R	F	M	R						
SDMT	1205 PDSR .F58	●	●	○	○	○		●	●																				12,7	12,7	5,0	5,5	0,8	15
CON ADDUZIONE LUBROREFRIGERANTE - WITH COOLANT SUPPLY																																		
SENZA ADDUZIONE LUBROREFRIGERANTE - WITHOUT COOLANT SUPPLY																																		

MATERIALI - MATERIALS		VDI 3323 GR.	HB Rm(1) HRC(2)	fz0 mm			Vc m/min Pag. 552											
Pag. 1199				F	M	R	F3120	T1730	F1335									
P	ACCIAIO NON LEGATO - NOT ALLOY STEEL	1-5	125-300	0,12	0,25	0,35	250	230	220									
	ACCIAIO POCO LEGATO - LOW ALLOY STEEL	6-9	180-350	0,1	0,2	0,3	200	190	180									
	ACCIAIO ALTO LEGATO - ALLOY STEEL	10-11	200-325	0,1	0,2	0,3	190	165	160									
	INOX MARTENS. - STAINLESS STEEL MART	12-13	200-240	0,08	0,15	0,25	150	150										
M	INOX AUST. DUPLEX - STAINLESS STEEL AUST	14.1-14.2	180-230	0,06	0,10	0,20			90									
K	GHISA GRIGIA - GREY CAST IRON	15-16	180-260	0,1	0,22	0,28	230											
	GHISA SFEROIDALE - SPHEROIDAL GRAPHITE	17-18	160-250	0,1	0,22	0,28	170											
	GHISA MALLEABILE - MALLEABLE CAST IRON	19-20	130-230	0,1	0,22	0,28	150											
N	ALLUMINIO E SUE LEGHE - ALUMINIUM	21-25	60-130															
	RAME E SUE LEGHE - COPPER	26-28	90-110															
	NON METALLICI - PLASTICS	29-30	/															
S	LEGHE RESIST. CALORE - HIG. TEMP. ALLOY	31-35	200-320															
	TITANIO E SUE LEGHE - TITANIUM	36-37	400-1050 ¹⁾															
H	ACCIAIO TEMPRATO - HARDENED STEEL	38-41	45-60 ²⁾															

$$n = \frac{Vc \cdot 1000}{\varnothing D \cdot 3,14} = \text{giri/min (min}^{-1}\text{)}$$

$$fz = fz0 \cdot Kae = \text{mm}$$

$$fn = fz \cdot z = \text{mm}$$

$$Vf = fz \cdot z \cdot n = \text{mm/min}$$

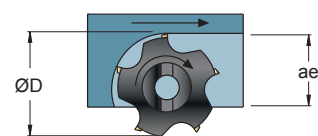

ae/D	0,5-1	0,3	0,2	0,1	0,05	0,02
Kae	1	1,2	1,5	2,1	3	4,8

ae/D	0,5-1 50-100%	0,2 20%	0,1 10%	0,05 5%
Vc	Vc (min)-----Vc(max)			
Pag. 552				

- F = FINITURA, LAV. LEGGERA - FINISHING, LIGHT MACHINING
- M = LAV. MEDIA, GENERICA - MEDIUM MACHINING, GENERIC
- R = SGROSSATURA, LAV. PESANTE - ROUGHING, HEAVY MACHINING
- Vc = m/min VELOCITÀ DI TAGLIO - CUTTING SPEED
- n = giri/min (min⁻¹) NUMERO DI GIRI - NUMBER OF REVOLUTIONS
- fz = mm AVANZAMENTO AL DENTE -TOOTH FEED
- fn = mm AVANZAMENTO AL GIRO - FEED / REVOLUTION
- Vf = mm/min VELOCITÀ DI AVANZAMENTO - FEED SPEED
- Kae = FATTORE DI CORREZIONE - CORRECTION FACTOR

S 1696W .. 16

Ø 25-40

γ_p +4°/+8°
 γ_f -13,5°/-12,5°
 γ_o -13,5°/-12,5°

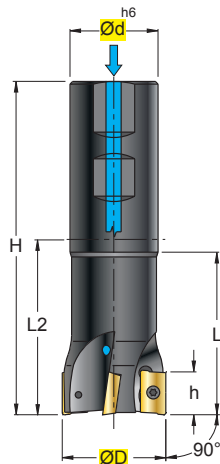

APKT 1604 .S51/.S54	
APKT 1604 .S52	
APMT 1604 .I52	
APMT 1604 .N52	NEW
APFT 1604 .S52	
APKX 1604 .S52	
APFX 1604 .S52	
APKT 1604 .Z54	
APKT 1604 .T55	
APKT 1604 .K57P	

INSERTI - INSERTS
PAG. 527

ART.	(mm)								Z	↻	kg	Nm			
	ØD	Ød	H	h	L	L2	β								
S 1696W 025 - 16	25	25	100	16	44	44	3,5°	2	Y	0,29	3,8÷5,0	1604	C04008P	5615P	
S 1696W 032 - 16	32	32	110	16	50	50	2,0°	3	Y	0,54	3,8÷5,0	1604	C04011P	5615P	
S 1696W 040 - 16	40	32	115	16	55	55	1,5°	4	Y	0,64	3,8÷5,0				

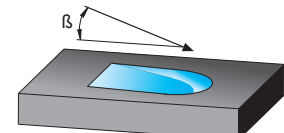
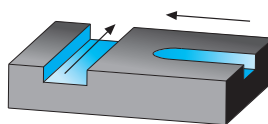
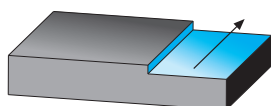

W = FORO PER LIQUIDO REFRIGERANTE - COOLANT BORE - KÜHLMITTELBOHRUNG - TROU DU LIQUIDE D'ARROSAGE
XLZ = EXTRALUNGA , STELO CILINDRICO - EXTRALONG , CYLINDRICAL SHANK - EXTRALANG , ZYLINDERSCHAFT - EXTRALONGUE , QUEUE CYLINDRIQUE
↻ = PASSO DIFFERENZIATO - DIFFERENTIAL PITCH - UNGLEICHE TEILUNG - PAS DIFFERENCIE

S 1696XLZ .. 16

Ø 25-40

γ_p +4°/+8°
 γ_f -13,5°/-12,5°
 γ_o -13,5°/-12,5°

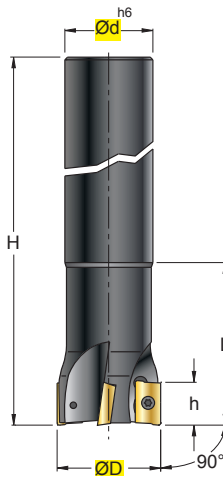

S 1696XLZM..16

Ø 25-32

γ_p +4°/+8°
 γ_f -13,5°/-12,5°
 γ_o -13,5°/-12,5°

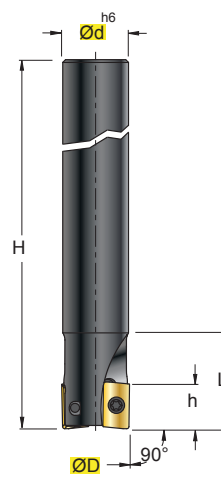

APKT 1604 .S51/.S54	
APKT 1604 .S52	
APMT 1604 .I52	
APMT 1604 .N52	
APFT 1604 .S52	
APKX 1604 .S52	
APFX 1604 .S52	
APKT 1604 .Z54	
APKT 1604 .T55	
APKT 1604 .K57P	

INSERTI - INSERTS
PAG. 527

(mm)

ART.	ØD	Ød/CM	H	h	L	L2	β	Z	↻	X	kg	Nm			
S 1696XLZ 025 - 16	25	25	200	16	44	-	3,5°	2	Y	-	0,69	3,8±5,0	1604	C04008P	5615P
S 1696XLZ 032 - 16	32	32	250	16	50	-	2,0°	3	Y	-	1,44	3,8±5,0	1604	C04011P	5615P
S 1696XLZ 040 - 16	40	32	250	16	50	-	1,5°	4	Y	-	2,30	3,8±5,0			
S 1696XLZM 025 - 16	25	24	200	16	35	-	3,5°	2	Y	0,5	0,67	3,8±5,0	1604	C04008P	5615P
S 1696XLZM 032 - 16	32	30	250	16	35	-	2,0°	3	Y	1,0	1,51	3,8±5,0	1604	C04011P	5615P

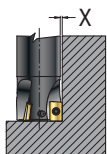

S1696XLZM...-16

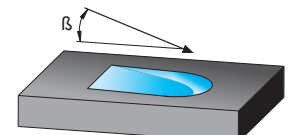
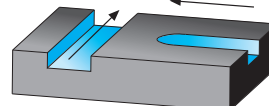
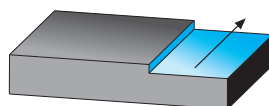

W = FORO PER LIQUIDO REFRIGERANTE - COOLANT BORE - KÜHLMITTELBOHRUNG - TROU DU LIQUIDE D'ARROSAGE

GXL = PASSO GROSSO EXTRALUNGA - EXTRALONG WITH LARGE TEETH DISTANCE - EXTRALANG MIT NORMAL ZUHNTLEUNG - EXTRALONGUE AVEC GRANDE DISTANCE DENTS

↻ = PASSO DIFFERENZIATO - DIFFERENTIAL PITCH - UNGLEICHE TEILUNG - PAS DIFFERENCIE

S 1698 .. 16		Ø 40-125		S 1698W ..16		Ø 40-125		APKT 1604 .S51/.S54		APKT 1604 .S52		APMT 1604 .I52		APMT 1604 .N52		APFT 1604 .S52		APKX 1604 .S52		APFX 1604 .S52		APKT 1604 .Z54		APKT 1604 .T55		APKT 1604 .K57P			
		$\gamma_p +6^\circ/+9^\circ$ $\gamma_f -12,5^\circ/-3^\circ$ $\gamma_o -12,5^\circ/-3^\circ$				$\gamma_p +6^\circ/+9^\circ$ $\gamma_f -12,5^\circ/-3^\circ$ $\gamma_o -12,5^\circ/-3^\circ$																							
ISO 6462 ...		A B C-D		ISO 6462 ...		A B C-D																							

INSERTI - INSERTS
PAG. 527

(mm)													ISO 6462			
ART.	ØD	Ød	H	h	β	Z		kg	Nm							
S 1698	040 - 16	40	16	40	16	1,8°	4	Y	0,18	3,8+5,0	A	1604	C04011P	5615P	VBSF08	
S 1698	050 - 16	50	22	40	16	1,0°	5	Y	0,25	3,8+5,0	A	1604	C04011P	5615P	VBSF10	
S 1698	063 - 16	63	22	40	16	0,7°	6	Y	0,47	3,8+5,0	A					
S 1698	080 - 16	80	27	50	16	0,6°	7	Y	0,94	3,8+5,0	A-B	1604	C04011P	5615P	VBSF12	
S 1698	100 - 16	100	32	50	16	0,4°	8	Y	1,55	3,8+5,0	A-B	1604	C04011P	5615P	VBSF16	
S 1698	125 - 16	125	40	63	16	0,3°	9	Y	3,43	3,8+5,0	A-B	1604	C04011P	5615P	VBSF20	
S 1698W	040 - 16	40	16	40	16	1,8°	4	Y	0,18	3,8+5,0	A	1604	C04011P	5615P	VBSF08	
S 1698W	050 - 16	50	22	40	16	1,0°	5	Y	0,25	3,8+5,0	A	1604	C04011P	5615P	VBSF10	
S 1698W	063 - 16	63	22	40	16	0,7°	6	Y	0,47	3,8+5,0	A					
S 1698W	080 - 16	80	27	50	16	0,6°	7	Y	0,94	3,8+5,0	A-B	1604	C04011P	5615P	VBSF12	
S 1698W	100 - 16	100	32	50	16	0,4°	8	Y	1,55	3,8+5,0	A-B	1604	C04011P	5615P	VBSF16	
S 1698W	125 - 16	125	40	63	16	0,3°	9	Y	3,43	3,8+5,0	A	1604	C04011P	5615P	VBSF20	
S 1698GW	040 - 16	40	16	40	16	1,8°	3	Y	0,17	3,8+5,0	A	1604	C04011P	5615P	VBSF08	
S 1698GW	050 - 16	50	22	40	16	1,0°	4	Y	0,24	3,8+5,0	A	1604	C04011P	5615P	VBSF10	
S 1698GW	063 - 16	63	22	40	16	0,7°	5	Y	0,45	3,8+5,0	A					
S 1698GW	080 - 16	80	27	50	16	0,6°	6	Y	0,92	3,8+5,0	A-B	1604	C04011P	5615P	VBSF12	
S 1698GW	100 - 16	100	32	50	16	0,4°	7	Y	1,52	3,8+5,0	A-B	1604	C04011P	5615P	VBSF16	
S 1698GW	125 - 16	125	40	63	16	0,3°	8	Y	3,10	3,8+5,0	A-B	1604	C04011P	5615P	VBSF20	

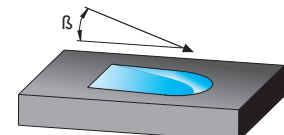
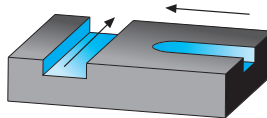
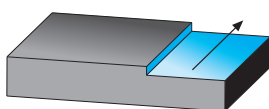

W = FORO PER LIQUIDO REFRIGERANTE - COOLANT BORE - KÜHLMITTELBOHRUNG - TROU DU LIQUIDE D'ARROSAGE
G = PASSO GROSSO - LARGE TEETH DISTANCE - NORMALE ZAHNTEILUNG - GRANDE DISTANCE DENTS.
 = PASSO DIFFERENZIATO - DIFFERENTIAL PITCH - UNGLEICHE TEILUNG - PAS DIFFERENCIE

S 9003.8W .. 13

Ø 50-160

γ_p -5°
 γ_f -15,8°/9°
 γ_o -15,8°/9°

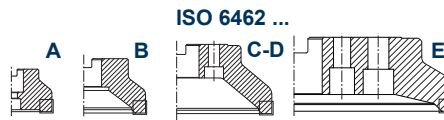

**LNMX
131308..
.F58**



**LNMX
131308..
.F61**

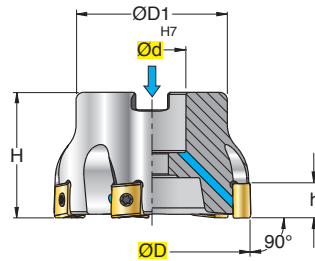

INSERTI - INSERTS
PAG. 529

ART.	(mm)						Z	kg	Nm	ISO 6462	1313	1240P	5615P	VBSF10
	ØD	Ød	ØD1	H	h	↻								
S 9003.8W-050-05-13	50	22	42	40	12	5	0,30	3,8+5,0	A	1313	1240P	5615P	VBSF10	
S 9003.8W-050-06-13	50	22	42	40	12	6	0,29	3,8+5,0	A	1313	1240P	5615P	VBSF10	
S 9003.8W-063-06-13	63	22	48	40	12	6	0,51	3,8+5,0	A	1313	1240P	5615P	VBSF10	
S 9003.8W-063-08-13	63	22	48	40	12	8	0,50	3,8+5,0	A	1313	1240P	5615P	VBSF10	
S 9003.8W-080-07-13	80	27	60	50	12	7	1,00	3,8+5,0	A	1313	1240P	5615P	AL 12x35	
S 9003.8W-080-10-13	80	27	60	50	12	10	1,00	3,8+5,0	A	1313	1240P	5615P	AL 12x35	
S 9003.8W-100-09-13	100	32	80	50	12	9	1,66	3,8+5,0	A	1313	1240P	5615P	AL 16x35	
S 9003.8W-100-13-13	100	32	80	50	12	13	1,64	3,8+5,0	A	1313	1240P	5615P	AL 16x35	
S 9003.8W-125-11-13	125	40	95	63	12	11	3,20	3,8+5,0	A-B	1313	1240P	5615P	AL 20x45	
S 9003.8W-125-17-13	125	40	95	63	12	17	3,17	3,8+5,0	A-B	1313	1240P	5615P	AL 20x45	
S 9003.8-160-12-13	160	40	115	63	12	12	4,00	3,8+5,0	C-D	1313	1240P	5615P	-	
S 9003.8-160-19-13	160	40	115	63	12	19	3,98	3,8+5,0	C-D	1313	1240P	5615P	-	

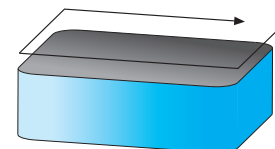
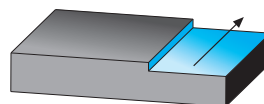
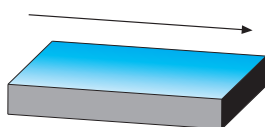

W = FORO PER LIQUIDO REFRIGERANTE - COOLANT BORE - KÜHLMITTELBOHRUNG - TROU DU LIQUIDE D'ARROSAGE
↻ = PASSO DIFFERENZIATO - DIFFERENTIAL PITCH - UNGLEICHE TEILUNG - PAS DIFFERENCIE

S 9004.6LW- .. -09

Ø 20-32 γ_p -2°/-4°
 γ_f -15°/-25°
 γ_o -15°/-25°

NEW

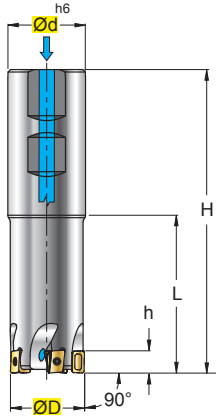

S 9004.6XLW- .. -09

Ø 20-32 γ_p -2°/-4°
 γ_f -15°/-25°
 γ_o -15°/-25°

NEW

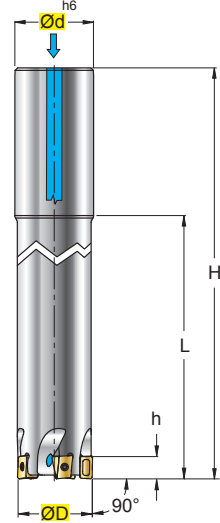

S 9004.8W- .. -09

Ø 40-80 γ_p -4°
 γ_f -10°/-12,1°
 γ_o -10°/-12,1°

NEW

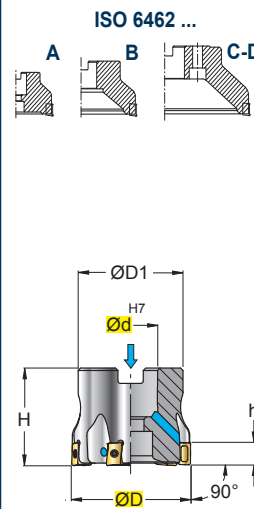

S 9004.9W- .. -09

Ø 20-32 γ_p -2°/-4°
 γ_f -15°/-24°
 γ_o -15°/-24°

NEW

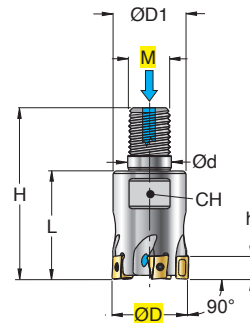

LNMX
090708
.F51



LNMX
090708
.F58



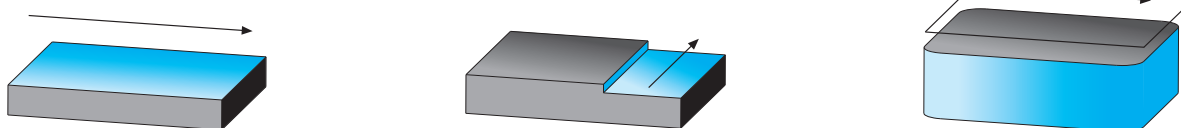

INSERTI - INSERTS
PAG. 529

ART.	ØD	M	Ød	ØD1	H	L	h	Z	CH	kg	Nm	ISO 6462				
S 9004.6LW 020-03-09	20	-	20	-	100	50	9	3	-	0,21	0,9+1,0	-	090708	122285P	5607P	-
S 9004.6LW 025-04-09	25	-	25	-	115	59	9	4	Y	0,39	0,9+1,0	-				
S 9004.6LW 032-05-09	32	-	32	-	125	65	9	5	Y	0,70	0,9+1,0	-				
S 9004.6XLW 020-03-09	20	-	20	-	150	98	9	3	-	0,32	0,9+1,0	-	090708	122285P	5607P	-
S 9004.6XLW 025-04-09	25	-	25	-	150	94	9	4	Y	0,52	0,9+1,0	-				
S 9004.6XLW 032-05-09	32	-	32	-	180	120	9	5	Y	1,00	0,9+1,0	-				
S 9004.8W 040-04-09	40	-	16	36	40	-	9	4	Y	0,23	0,9+1,0	A	090708	122285P	5607P	VBSF08L
S 9004.8W 040-06-09	40	-	16	36	40	-	9	6	Y	0,23	0,9+1,0	A				
S 9004.8W 050-05-09	50	-	22	43	40	-	9	5	Y	0,33	0,9+1,0	A	090708	122285P	5607P	VBSF10
S 9004.8W 050-07-09	50	-	22	43	40	-	9	7	Y	0,34	0,9+1,0	A				
S 9004.8W 063-06-09	63	-	22	48	40	-	9	6	Y	0,45	0,9+1,0	A-B	090708	122285P	5607P	AL10x30
S 9004.8W 063-09-09	63	-	22	48	40	-	9	9	Y	0,46	0,9+1,0	A-B				
S 9004.8W 080-07-09	80	-	27	58	50	-	9	7	Y	0,87	0,9+1,0	A-B	090708	122285P	5607P	AL12x35
S 9004.8W 080-10-09	80	-	27	58	50	-	9	10	Y	0,87	0,9+1,0	A-B				
S 9004.9W 020-03-09	20	10	10,5	19	46	27	9	3	-	0,05	0,9+1,0	-	090708	122285P	5607P	-
S 9004.9W 025-04-09	25	12	12,5	21	52	30	9	4	Y	0,08	0,9+1,0	-				
S 9004.9W 032-05-09	32	16	17,0	29	66	43	9	5	Y	0,22	0,9+1,0	-				

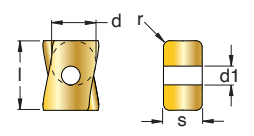

W = FORO PER LIQUIDO REFRIGERANTE - COOLANT BORE - KÜHLMITTELBOHRUNG - TROU DU LIQUIDE D'ARROSAGE
L = LUNGA, STELO CILINDRICO - LONG, CYLINDRICAL SHANK - LANG, ZYLINDERSCHAFT - LONGUE, QUEUE CYLINDRIQUE
XL = EXTRALUNGA, STELO CILINDRICO - EXTRALONG, CYLINDRICAL SHANK - EXTRALANG, ZYLINDERSCHAFT - EXTRALONGUE, QUEUE CYLINDRIQUE
↻ = PASSO DIFFERENZIATO - DIFFERENTIAL PITCH - UNGLEICHE TEILUNG - PAS DIFFERENCIE

SCELTA VELOCE - QUICK PICK		Tenacità + ↑		Toughness - ↓		Pag. 538		HT	HW	HC													
		COD.		P		M		K		N		S		H		F3120	F1325	F1335	l	d	s	d1	r
F	M	R	F	M	R	F	M	R	F	M	R	F	M	R	F								
LNMX	090708	.F51	○	○			●	●							■			9	7,21	5	2,5	0,8	-
LNMX	090708	.F58	●	●	○	○	○	○								■	■						

CON ADDUZIONE LUBROREFRIGERANTE - WITH COOLANT SUPPLY 

SENZA ADDUZIONE LUBROREFRIGERANTE - WITHOUT COOLANT SUPPLY 

MATERIALI - MATERIALS Pag. 1199		VDI 3323 GR.	HB Rm ¹⁾ HRC ²⁾	fz0 mm			Vc m/min Pag. 552								
				F	M	R	F3120	F1325	F1335						
P	ACCIAIO NON LEGATO - NOT ALLOY STEEL	1--5	125-300	0,08	0,15	0,25	200	230	220						
	ACCIAIO POCO LEGATO - LOW ALLOY STEEL	6--9	180-350	0,08	0,15	0,2	180	190	180						
	ACCIAIO ALTO LEGATO - ALLOY STEEL	10-11	200-325	0,06	0,12	0,16	160	170	160						
	INOX MARTENS. - STAINLESS STEEL MART	12-13	200-240	0,08	0,12	0,15	120								
M	INOX AUST. DUPLEX - STAINLESS STEEL AUST	14.1-14.2	180-230	0,08	0,12	0,15		100	90						
K	GHISA GRIGIA - GREY CAST IRON	15-16	180-260	0,08	0,18	0,25	280	220							
	GHISA SFEROIDALE - SPHEROIDAL GRAPHITE	17-18	160-250	0,08	0,15	0,2	260	180							
	GHISA MALLEABILE - MALLEABLE CAST IRON	19-20	130-230	0,08	0,15	0,2	240	160							
N	ALLUMINIO E SUE LEGHE - ALUMINIUM	21--25	60-130												
	RAME E SUE LEGHE - COPPER	26--28	90-110												
	NON METALLICI - PLASTICS	29-30	/												
S	LEGHE RESIST. CALORE - HIG. TEMP. ALLOY	31--35	200-320												
	TITANIO E SUE LEGHE - TITANIUM	36-37	400-1050 ¹⁾												
H	ACCIAIO TEMPRATO - HARDENED STEEL	38--41	45-60 ²⁾												



- SE LA SPORGENZA DELLA FRESA È >3xD RIDURRE I PARAMETRI DI LAVORO: Vc, fz, ap DEL 30%
- IF THE PROTRUSION OF THE CUTTER IS >3xD, REDUCE CUTTING PARAMETERS: Vc, fz, ap BY 30%

$$n = \frac{Vc \cdot 1000}{\varnothing D \cdot 3,14} = \text{giri/min (min}^{-1}\text{)}$$

$$fz = fz0 \cdot Kae = \text{mm}$$

$$fn = fz \cdot K = \text{mm}$$

$$Vf = fz \cdot z \cdot n = \text{mm/min}$$

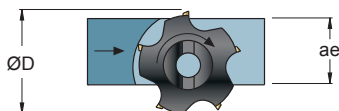

ae/D	0,5-1 50-100%	0,3 30%	0,2 20%	0,1 10%	0,05 5%	0,02 2%
Kae	1	1,2	1,5	2,1	3	4,8

ae/D	0,5-1 50-100%	0,2 20%	0,1 10%	0,05 5%
Vc (min)-----Vc(max)				
R-----M-----F				
Vc Pag. 552				

F = FINITURA , LAV. LEGGERA - FINISHING , LIGHT MACHINING
M = LAV. MEDIA , GENERIC - MEDIUM MACHINING , GENERIC
R = SGROSSATURA , LAV. PESANTE - ROUGHING , HEAVY MACHINING



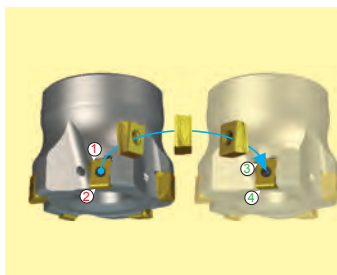



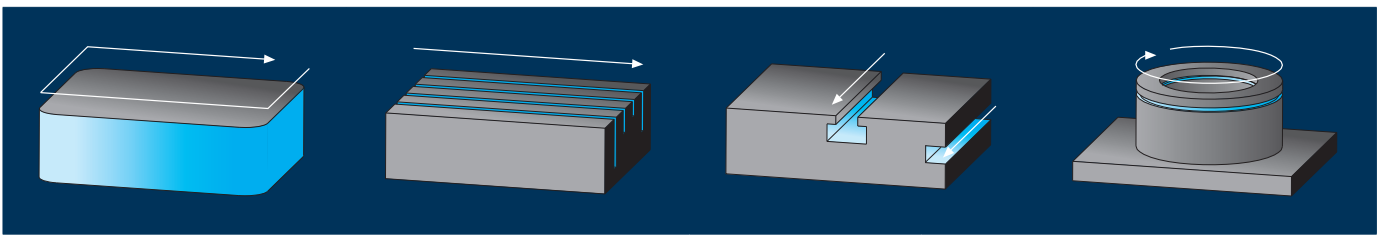

Vc = m/min VELOCITÀ DI TAGLIO - CUTTING SPEED
n = giri/min (min⁻¹) NUMERO DI GIRI - NUMBER OF REVOLUTIONS
fz = mm AVANZAMENTO AL DENTE -TOOTH FEED
fn = mm AVANZAMENTO AL GIRO - FEED / REVOLUTION
Vf = mm/min VELOCITÀ DI AVANZAMENTO - FEED SPEED
Kae = FATTORE DI CORREZIONE - CORRECTION FACTOR

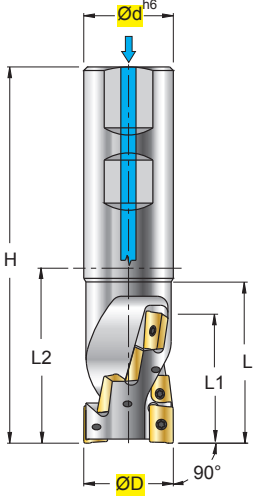
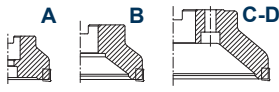
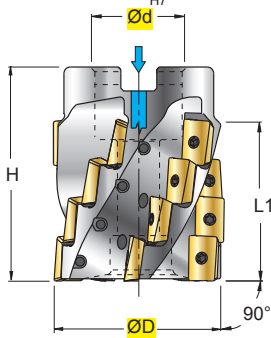

- 4 Taglienti "Utili" disponibili grazie all'inserto bilaterale.
- 4 "Useful" cutting-edges thanks to two-sided insert
- 4 "Nützliche" schneidkanten dank zweiseitiger wendeschneidplatten
- 4 Tranchants "Utiles" disponibles grace a la plaquette bilaterale



S950		Pag. 492	S905		Pag. 498
		ØD = 63 - 250			ØD = 20 - 32
S 950 ..			S 905W ..		
	SNHX..11.. SNHX..12..			AP..1003 AP..1604	
S955		Pag. 494			
		ØD = 50 - 160			
S 955 .. S 955M ..					
	SNHX..11.. SNHX..12..				
S959		Pag. 496			
		ØD = 50 - 80			
S 959 ..					
	SNHX..11.. SNHX..12..				

S 1056W .. 10	$\varnothing 20-40$	S 1058W .. 10 S 1058WF .. 10	$\varnothing 40-63$	APKT 1003 .I52	
		<p style="text-align: center;">ISO 6462 ...</p>  		APKT 1003 .N52	
				APKT 1003 .S52	
				APKX 1003 .S52	
				APKT 1003 .Z54	
				APKT 1003 .T55	
				APHT 1003 .S57	
				 INSERTI - INSERTS PAG. 526	

ART.		(mm)										kg	Nm	ISO 6462			
		$\varnothing D$	$\varnothing d$	H	L	L1	L2	Z	N	K							
S 1056W	020-10	20	20	87	37	28	37	2	4	1	0,200	1,1+1,3	-	1003	12255P	5608P	-
S 1056W	020.2-10(**)	20	20	87	37	28	37	2	6	2	0,200	1,1+1,3	-				
S 1056W	025-10	25	25	105	49	37	49	2	8	2	0,340	1,1+1,3	-				
S 1056W	032-10(***)	32	32	115	55	46	55	4	12	2	0,605	1,1+1,3	-				
S 1056W	032.2-10(**)	32	32	115	55	46	55	2	10	2	0,605	1,1+1,3	-				
S 1056W	032.3-10(*)	32	32	115	55	46	55	3	15	3	0,600	1,1+1,3	-				
S 1056W	040-10	40	32	130	70	55	70	3	18	3	0,810	1,1+1,3	-				
S 1056W	040.2-10(**)	40	32	130	70	55	70	2	12	2	0,810	1,1+1,3	-				
S 1058W	040-10	40	16	50	-	37	-	3	12	3	0,250	1,1+1,3	A	1003	12255P	5608P	VBSF08L
S 1058W	050-10	50	22	60	-	46	-	3	15	3	0,510	1,1+1,3	A	1003	12255P	5608P	VBSF10L
S 1058W	063-10	63	27	60	-	46	-	4	20	4	0,800	1,1+1,3	A	1003	12255P	5608P	VBSF12L
S 1058WF	040-10	40	16	50	-	37	-	5	20	5	0,240	1,1+1,3	A	1003	12255P	5608P	VBSF08L
S 1058WF	050-10	50	22	60	-	46	-	5	25	5	0,510	1,1+1,3	A	1003	12255P	5608P	VBSF10L
S 1058WF	063-10	63	27	60	-	46	-	7	35	7	0,840	1,1+1,3	A	1003	12255P	5608P	VBSF12L

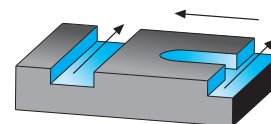
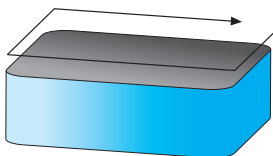

- | | | |
|----------------|-----------------|---|
| (*) 3 ELICHE | (**) 2 ELICHE | (***) 2 ELICHE N°4 INSERTI IN TESTA |
| (*) 3 FLUTES | (**) 2 FLUTES | (***) 2 FLUTES 4 FRONT INSERTS |
| (*) 3 SPIRALEN | (**) 2 SPIRALEN | (***) 2 SPIRALEN A STIRNWEENDEPLATTEN |
| (*) 3 HÉLICES | (**) 2 HÉLICES | (***) 2 HÉLICES 4 PLAQUETTES À L' EXTREMITÉ |

Z = NUMERO DI ELICHE - NUMBER OF FLUTES - SPIRALENANZAHL - NOMBRE D' HELICES
 K = FATTORE D'AVANZAMENTO - FACTOR OF FEED - VORSCHUBFAKTOR - FACTEUR D' AVANCE
 N = NUMERO D'INSERTI - INSERT NUMBER - WENDEPLATTENANZAHL - NOMBRE DES PLAQUETTES
 W = FORO PER LIQUIDO REFRIGERANTE - COOLLANT BORE - KÜHLMITTELBOHRUNG - TROU DU LIQUIDE D'ARROSAGE
 F = PASSO FINE - FINE PITCH - FEINE ZUHNTILUNG - PAS FIN

SCelta VELOCE - QUICK PICK

Tenacità + ↑
Toughness - ↓

Pag. 538

COD.	P M K N S H												HT	HW	HC						l	d	s	d1	r	a°		
	F	M	R	F	M	R	F	M	R	F	M	R			T120	T516	T526	T528N	T530	T525							F2330	F1035
APKT 1003 PDR .I52	●	●	○	○	○	○	○	○	○	○	○	○											10,5	6,70	3,50	2,8	0,5	11
APKT 1003 PDR .N52	●	●	○	○	○	○	○	○	○	○	○	○											10,5	6,70	3,50	2,8	0,5	11
APKT 1003 PDTR .S52																							10,5	6,70	3,50	2,8	0,5*	11
APKX 1003 PDR .S52	○	●	●	●	●	○	○	○	○	○	○	○											10,5	6,70	3,50	2,8	0,5*	11
APKT 1003 PDSR .Z54	○	●	●	●	○	○	○	○	○	○	○	○											10,5	6,70	3,50	2,8	0,5	11
APKT 1003 PDER .Z54	○	●	●	○	○	○	○	○	○	○	○	○											10,5	6,70	3,50	2,8	0,5	11
APKT 1003 PDER .T55	○	○	○	○	○	○	○	○	○	○	○	○											11,0	6,70	3,50	2,8	0,5	11
APHT 1003 PDRF .S57																							10,5	6,70	3,50	2,8	0,5	11

* = RAGGIO PARZIALE / PARTIAL RADIUS/ TEILRADIUS / RAYON PARTIEL

CON ADDUZIONE LUBROREFRIGERANTE - WITH COOLANT SUPPLY

SENZA ADDUZIONE LUBROREFRIGERANTE - WITHOUT COOLANT SUPPLY

MATERIALI - MATERIALS Pag. 1199		VDI 3323 GR.	HB Rm1) HRC2)	fz0 mm			Vc m/min Pag. 552										
				F	M	R	T120	T516	T525	T526	T528N	T530	F2330	F1035	F2335		
P	ACCIAIO NON LEGATO - NOT ALLOY STEEL	1--5	125-300	0,1	0,15	0,2				250	220	230	270	125	250		
	ACCIAIO POCO LEGATO - LOW ALLOY STEEL	6-9	180-350	0,06	0,1	0,15				200	160	180	220	120	200		
	ACCIAIO ALTO LEGATO - ALLOY STEEL	10-11	200-325	0,06	0,1	0,15				170	150	150	200	100	180		
	INOX MARTENS. - STAINLESS STEEL MART	12-13	200-240	0,06	0,08	0,1				150	140	140	180	100	150		
M	INOX AUST. DUPLEX - STAINLESS STEEL AUST	14.1-14.2	180-230	0,06	0,08	0,1	100		140	130	120	120	150		130		
K	GHISA GRIGIA - GREY CAST IRON	15-16	180-260	0,1	0,15	0,2	120	250	200			180	160		240		
	GHISA SFEROIDALE - SPHEROIDAL GRAPHITE	17-18	160-250	0,06	0,12	0,15	110	200	180			160	150		200		
	GHISA MALLEABILE - MALLEABLE CAST IRON	19-20	130-230	0,06	0,12	0,15	120	220	200			170	160		200		
N	ALLUMINIO E SUE LEGHE - ALUMINIUM	21--25	60-130	0,06	0,15	0,2	500					600					
	RAME E SUE LEGHE - COPPER	26-28	90-110	0,06	0,12	0,18	300					300					
	NON METALLICI - PLASTICS	29-30	/	0,06	0,12	0,18											
S	LEGHE RESIST. CALORE - HIG. TEMP. ALLOY	31--35	200-320	0,06	0,08	0,1	20		40		40	40	40		40		
	TITANIO E SUE LEGHE - TITANIUM	36-37	400-1050 ⁹⁾	0,06	0,08	0,1	30		50		60	50	50		50		
H	ACCIAIO TEMPRATO - HARDENED STEEL	38-41	45-60 ⁸⁾	0,06	0,08	0,1			40								

$$n = \frac{Vc \cdot 1000}{\varnothing D \cdot 3,14} = \text{giri/min (min}^{-1}\text{)}$$

$$fz = fz0 \cdot Kae \cdot Kap = \text{mm}$$

$$fn = fz \cdot K = \text{mm}$$

$$Vf = fz \cdot K \cdot n = \text{mm/min}$$

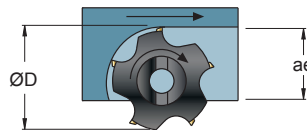

ae/D	0,5-1 50-100%	0,3 30%	0,2 20%	0,1 10%	0,05 5%	0,02 2%
Kae	1	1,2	1,5	2,1	3	4,8

ae/D	0,5-1 50-100%	0,2 20%	0,1 10%	0,05 5%
Vc	Vc (min)-----Vc(max)			

Pag. 552

ap/D	0,25	0,5	0,75	1,0	ap max=L1
Kap	1	1	0,8	0,7	0,5

- F = FINITURA, LAV. LEGGERA - FINISHING, LIGHT MACHINING
M = LAV. MEDIA, GENERICA - MEDIUM MACHINING, GENERIC
R = SGROSSATURA, LAV. PESANTE - ROUGHING, HEAVY MACHINING

- Vc = m/min VELOCITÀ DI TAGLIO - CUTTING SPEED
n = giri/min (min⁻¹) NUMERO DI GIRI - NUMBER OF REVOLUTIONS
fz = mm AVANZAMENTO AL DENTE - TOOTH FEED
fn = mm AVANZAMENTO AL GIRO - FEED / REVOLUTION
Vf = mm/min VELOCITÀ DI AVANZAMENTO - FEED SPEED
Kae / Kap = FATTORE DI CORREZIONE - CORRECTION FACTOR

S 1656W .. 16

Ø 25-40

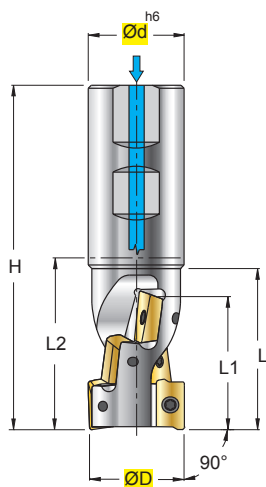

S 1658 .. 16

Ø 50-125

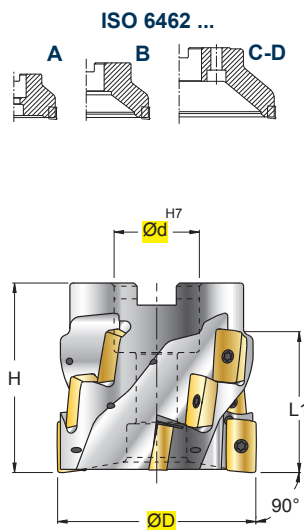

APKT 1604
.S51/.S54



APMT 1604
.I52



APMT 1604
.N52



APFT 1604
.S52



APKX 1604
.S52



APKT 1604
.Z54



APKT 1604
.K57P



INSERTI - INSERTS
PAG. 527

(mm)

ART.	ØD	Ød	H	L	L1	L2	Z	N	K	kg	Nm	ISO 6462	1604			
S 1656W 025-16	25	25	95	38	29	39	1	2	1	0,29	3,8+5,0	-	1604	C04008P	5615P	-
S 1656W 032-16	32	32	115	53	44	55	2	6	2	0,52	3,8+5,0	-				
S 1656W 040-16	40	32	130	65	58	70	2	8	2	0,73	3,8+5,0	-				
S 1658 050-16	50	27	50	-	30	-	3	6	3	0,36	3,8+5,0	A	1604	C04011P	5615P	VBSF12
S 1658 063-16	63	27	60	-	44	-	4	12	4	0,74	3,8+5,0	A	1604	C04011P	5615P	VBSF12L
S 1658 080-16	80	32	60	-	44	-	5	15	5	1,20	3,8+5,0	A	1604	C04011P	5615P	VBSF16L
S 1658 100-16	100	40	60	-	44	-	6	18	6	1,70	3,8+5,0	A-B	1604	C04011P	5615P	VBSF20
S 1658 125-16	125	40	60	-	44	-	7	21	7	3,15	3,8+5,0	A-B				

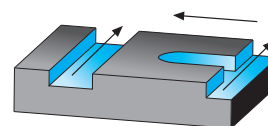
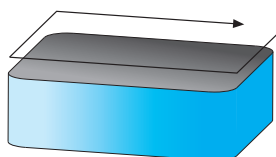

Z = NUMERO DI ELICHE - NUMBER OF FLUTES - SPIRALENANZAHL - NOMBRE D' HELICES
K = FATTORE D'AVANZAMENTO - FACTOR OF FEED - VORSCHUBFAKTOR - FACTEUR D' AVANCE
N = NUMERO D'INSERTI - INSERT NUMBER - WENDEPLATTENANZAHL - NOMBRE DES PLAQUETTES
W = FORO PER LIQUIDO REFRIGERANTE - COOLLANT BORE - KÜHLMITTELBOHRUNG - TROU DU LIQUIDE D'ARROSAGE

SCELTA VELOCE - QUICK PICK

Tenacità **+** ↑ 

Toughness **-** ↓

Pag. 538

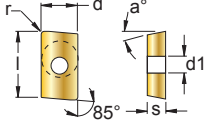
COD.										HT		HW		HC																	
		P			M			K			N			S			H		T110	T120	T516	T526	T528N	T525	T544	l	d	s	d1	r	a°
F	M	R	F	M	R	F	M	R	F	M	R	F	M	R	F	M	R														
APKT	1604	PDR	.S51																						17,0	9,45	5,26	4,4	0,4	11	
APMT	1604	PDR	.I52																							17,0	9,45	5,26	4,4	0,8	11
APMT	1604	PDR	.N52																							17,0	9,45	5,26	4,4	0,8	11
APFT	1604	PDTR	.S52																							17,0	9,45	4,76	4,4	0,8	11
APKX	1604	PDR	.S52																							17,0	9,45	5,76	4,4	0,8	11
APKT	1604	PDTR	.S54																							17,0	9,45	5,26	4,4	0,4	11
APKT	1604	PDSR	.Z54																							17,0	9,45	5,26	4,4	0,8	11
APKT	1604	PDFR	.K57P																							16,4	9,53	4,76	4,4	0,2	11

CON ADDUZIONE LUBROREFRIGERANTE - WITH COOLANT SUPPLY 

SENZA ADDUZIONE LUBROREFRIGERANTE - WITHOUT COOLANT SUPPLY 

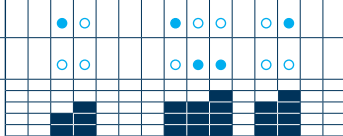

MATERIALI - MATERIALS Pag. 1199		VDI 3323 GR.	HB Rm1) HRC2)	fz0 mm			Vc m/min Pag. 552											
				F	M	R	T110	T120	T516	T525	T526	T528N	T544					
P	ACCIAIO NON LEGATO - NOT ALLOY STEEL	1--5	125-300	0,1	0,2	0,3					250	220	220	230				
	ACCIAIO POCO LEGATO - LOW ALLOY STEEL	6-9	180-350	0,08	0,15	0,25					200	160	160	180				
	ACCIAIO ALTO LEGATO - ALLOY STEEL	10-11	200-325	0,08	0,15	0,25					170	150	150	150				
	INOX MARTENS. - STAINLESS STEEL MART	12-13	200-240	0,06	0,12	0,2					150	140	140	140				
M	INOX AUST. DUPLEX - STAINLESS STEEL AUST	14.1-14.2	180-230	0,06	0,1	0,15		100			140	130	120	120				
K	GHISA GRIGIA - GREY CAST IRON	15-16	180-260	0,12	0,25	0,35	120	120	250	200			180					
	GHISA SFEROIDALE - SPHEROIDAL GRAPHITE	17-18	160-250	0,1	0,2	0,3	120	110	200	180			160					
	GHISA MALLEABILE - MALLEABLE CAST IRON	19-20	130-230	0,1	0,2	0,3	120	120	220	200			170					
N	ALLUMINIO E SUE LEGHE - ALUMINIUM	21--25	60-130	0,06	0,2	0,35	950	500					600					
	RAME E SUE LEGHE - COPPER	26--28	90-110	0,06	0,18	0,3	400	300					300					
	NON METALLICI - PLASTICS	29-30	/	0,06	0,18	0,3	30											
S	LEGHE RESIST. CALORE - HIG. TEMP. ALLOY	31--35	200-320	0,05	0,08	0,12	20	20			40		40	50				
	TITANIO E SUE LEGHE - TITANIUM	36-37	400-1050 ¹⁾	0,05	0,08	0,12	30	30			50		60	50				
H	ACCIAIO TEMPRATO - HARDENED STEEL	38-41	45-60 ²⁾	0,05	0,08						40							

$$n = \frac{Vc \cdot 1000}{\varnothing D \cdot 3,14} = \text{giri/min (min}^{-1}\text{)}$$

$$fz = fz_0 \cdot K_{ae} \cdot K_{ap} = \text{mm}$$

$$f_n = f_z \cdot K = \text{mm}$$

$$V_f = f_z \cdot K \cdot n = \text{mm/min}$$

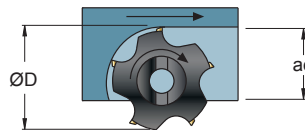

ae/D	0,5-1 50-100%	0,3 30%	0,2 20%	0,1 10%	0,05 5%	0,02 2%
Kae	1	1,2	1,5	2,1	3	4,8



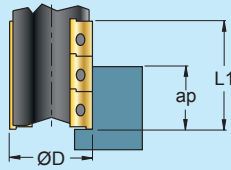

ae/D	0,5-1 50-100%	0,2 20%	0,1 10%	0,05 5%
Vc Pag. 552	Vc (min)-----Vc(max)			





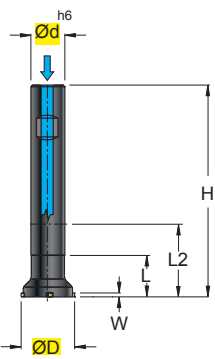
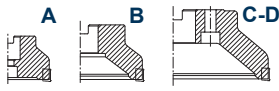

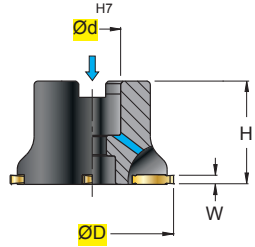
ap/D	0,25	0,5	0,75	1,0	ap max=L1
Kap	1	1	0,8	0,7	0,5

F = FINITURA , LAV. LEGGERA - FINISHING , LIGHT MACHINING
M = LAV. MEDIA , GENERICA - MEDIUM MACHINING , GENERIC
R = SGROSSATURA , LAV. PESANTE - ROUGHING , HEAVY MACHINING

Vc = m/min VELOCITÀ DI TAGLIO - CUTTING SPEED
n = giri/min (min⁻¹) NUMERO DI GIRI - NUMBER OF REVOLUTIONS
fz = mm AVANZAMENTO AL DENTE -TOOTH FEED
fn = mm AVANZAMENTO AL GIRO - FEED / REVOLUTION
Vf = mm/min VELOCITÀ DI AVANZAMENTO - FEED SPEED
Kae / Kap = FATTORE DI CORREZIONE - CORRECTION FACTOR

S 666W .. 16	\varnothing 19-34	S 668W .. 16	\varnothing 48-63	156.15.16.. .C54	
		ISO 6462 ... 		156.15.16.. .C57	
				154.15.16..	
		 INSERTI - INSERTS PAG. 525			

(mm)																
ART.	\varnothing D	\varnothing d	H	L	L2	Z	K	W	kg	Nm	ISO 6462					
S 666W	019-16	19	16	100	20	52	1	1	1,1-1,3	0,15	3,5+4,0	-	156.15-16	124095P	5615P	-
S 666W	034-16	34	20	125	25	75	3	3	1,6-2,15	0,31	3,5+4,0	-				
S 668W	048-16	48	16	40	-	-	4	4	2,15-3,15	0,35	3,5+4,0	A	156.15-16	124095P	5515P	VBSF08
S 668W	063-16	63	22	40	-	-	5	5	2,65-4,15	0,44	3,5+4,0	A	156.15-16	124095P	5515P	VBSF10

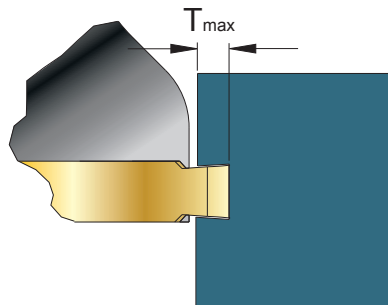

\varnothing D	T max
19	1,8
34 - 48 - 63	2,3

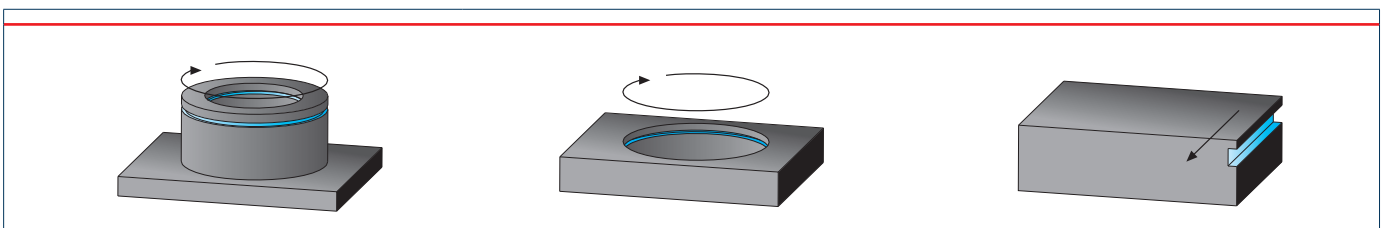

K = FATTORE D'AVANZAMENTO - FACTOR OF FEED - VORSCHUBFAKTOR - FACTEUR D'AVANCE

SCelta VELOCE - QUICK PICK							HT		HW	HC										
							CERMET		NON RIV. CEMENTED CARBIDE GRADES	RIVESTITI COATED GRADES BESCHICHTET RECOUVERTS										
							N6315			F6315										
COD.	P	M	K	N	S	H									I	d	s	d1	T	W
Tenacità + ↑ ↑ Toughness - ↓ Pag. 538																				
TOLLERANZA W - W TOLERANCE +0,05 +0,01																				
156.15-16110 .C54	●	●	●											16,0	9,52	3	4,5	3,0	1,10	
156.15-16130 .C54	●	●	●											16,0	9,52	3	4,5	3,0	1,30	
156.15-16160 .C54	●	●	●											16,0	9,52	3	4,5	3,0	1,60	
156.15-16185 .C54	●	●	●											16,0	9,52	3	4,5	3,0	1,85	
156.15-16215 .C54	●	●	●											16,0	9,52	3	4,5	3,0	2,15	
156.15-16265 .C54	●	●	●											16,0	9,52	3	4,5	3,0	2,65	
156.15-16315 .C54	●	●	●											16,0	9,52	3,5	4,5	3,3	3,15	
156.15-16415 .C54	●	●	●											16,0	9,52	4,5	4,5	3,3	4,15	
156.15-16110 .C57				●				■						16,0	9,52	3	4,5	3,0	1,10	
156.15-16130 .C57				●				■						16,0	9,52	3	4,5	3,0	1,30	
156.15-16160 .C57				●				■						16,0	9,52	3	4,5	3,0	1,60	
156.15-16185 .C57				●				■						16,0	9,52	3	4,5	3,0	1,85	
156.15-16215 .C57				●				■						16,0	9,52	3	4,5	3,0	2,15	
156.15-16265 .C57				●				■						16,0	9,52	3	4,5	3,0	2,65	
156.15-16315 .C57				●				■						16,0	9,52	3,5	4,5	3,3	3,15	
156.15-16415 .C57				●				■						16,0	9,52	4,5	4,5	3,3	4,15	

È POSSIBILE UTILIZZARE INSERTI 154.. NON RETTIFICATI, PAG 525
 154.. INSERTS CAN BE USED.. NOT GROUND, PAGE 525
 DIE VERWENDUNG NICHT GESCHLIFFENER WENDEPLATTEN 154.. IST MÖGLICH, S. SEITE 525
 IL EST POSSIBLE D'UTILISER DES PLAQUETTES 154.. NON RECTIFIÉES, PAGE 525

CON ADDUZIONE LUBROREFRIGERANTE - WITH COOLANT SUPPLY		●	●																
SENZA ADDUZIONE LUBROREFRIGERANTE - WITHOUT COOLANT SUPPLY		○	○																

MATERIALI - MATERIALS Pag. 1199		VDI 3323 GR.	HB Rm ¹⁾ HRC ²⁾	fz0 mm			Vc m/min Pag.552		
				F	M	R	N6315	F6315	
P	ACCIAIO NON LEGATO - NOT ALLOY STEEL	1--5	125-300	0,06	0,08	0,1		140	
	ACCIAIO POCO LEGATO - LOW ALLOY STEEL	6-9	180-350	0,06	0,08	0,1		130	
	ACCIAIO ALTO LEGATO - ALLOY STEEL	10-11	200-325	0,06	0,08	0,1		130	
	INOX MARTENS. - STAINLESS STEEL MART	12-13	200-240	0,06	0,08	0,1		130	
M	INOX AUST. DUPLEX - STAINLESS STEEL AUST	14.1-14.2	180-230	0,06	0,08	0,1		110	
	GHISA GRIGIA - GREY CAST IRON	15-16	180-260	0,08	0,1	0,12		110	
K	GHISA SFEROIDALE - SPHEROIDAL GRAPHITE	17-18	160-250	0,08	0,1	0,12		110	
	GHISA MALLEABILE - MALLEABLE CAST IRON	19-20	130-230	0,08	0,1	0,12		110	
N	ALLUMINIO E SUE LEGHE - ALUMINIUM	21--25	60-130	0,06	0,08	0,1		340	
	RAME E SUE LEGHE - COPPER	26-28	90-110	0,06	0,08	0,1		300	
S	NON METALLICI - PLASTICS	29-30	/	0,06	0,08	0,1		290	
	LEGHE RESIST. CALORE - HIG. TEMP. ALLOY	31--35	200-320						
H	TITANIO E SUE LEGHE - TITANIUM	36-37	400-1050 ³⁾						
	ACCIAIO TEMPRATO - HARDENED STEEL	38-41	45-60 ²⁾						

ae/D	0,5-1 50-100%	0,2 20%	0,1 10%	0,05 5%
Vc Pag. 552	Vc (min)-----Vc(max)			

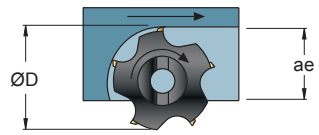

ae/D	0,1 10%	0,05 5%	0,04 4%	0,03 3%	0,02 2%
Kae	2,1	3	3,5	4	4,8

$$n = \frac{Vc \cdot 1000}{\text{ØD} \cdot 3,14} = \text{giri/min (min}^{-1}\text{)}$$

$$fz = fz0 \cdot Kae = \text{mm}$$

$$fn = fz \cdot z = \text{mm}$$

$$Vf = fz \cdot z \cdot n = \text{mm/min}$$

$$ae = \frac{\text{ØDe}^2 - \text{ØDi}^2}{4 \cdot (\text{ØDe} - \text{ØD})} = \text{mm}$$

$$Vf = \left(1 - \frac{\text{ØD}}{\text{ØDe}}\right) \cdot n \cdot fz \cdot z = \text{mm/min}$$

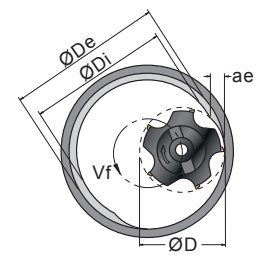

F = FINITURA , LAV. LEGGERA - FINISHING , LIGHT MACHINING
M = LAV. MEDIA , GENERICA - MEDIUM MACHINING , GENERIC
R = SGROSSATURA , LAV. PESANTE - ROUGHING , HEAVY MACHINING
Vc = m/min VELOCITÀ DI TAGLIO - CUTTING SPEED
n = giri/min (min⁻¹) NUMERO DI GIRI - NUMBER OF REVOLUTIONS
fz = mm AVANZAMENTO AL DENTE -TOOTH FEED
fn = mm AVANZAMENTO AL GIRO - FEED / REVOLUTION
Vf = mm/min VELOCITÀ DI AVANZAMENTO - FEED SPEED
Kae = FATTORE DI CORREZIONE - CORRECTION FACTOR

$$ae = \frac{\text{ØDe}^2 - \text{ØDi}^2}{4 \cdot (\text{ØDi} + \text{ØD})} = \text{mm}$$

$$Vf = \left(1 + \frac{\text{ØD}}{\text{ØDi}}\right) \cdot n \cdot fz \cdot z = \text{mm/min}$$

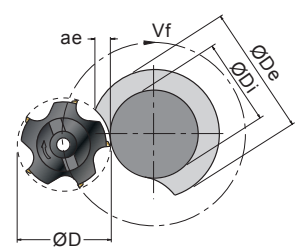

S 976W ..

Ø 21-50

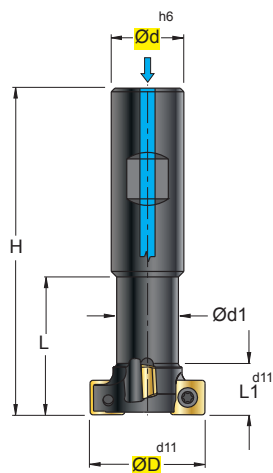

SPMT ...
.N54



SPMW..
.N51



SPMW..
.N59



INSERTI - INSERTS
 PAG. 535

(mm)

ART.	ØD	Ød	Ød1	H	L	L1	Z	K	kg	Nm			
S 976W 021-06	21	16	11	76	24	9	2	1	0,10	1,1+1,3	060304	12256P	5608P
S 976W 025-06	25	16	13	82	28	11	4	2	0,11	1,1+1,3			
S 976W 032-09	32	20	17	88	35	14	4	2	0,15	3,0+3,5	09T308	123509P	5615P
S 976W 040-09	40	25	21	108	44	17	4	2	0,37	3,0+3,5			
S 976W 050-12	50	32	27	120	59	21	4	2	0,65	4,0+5,0	120408	124510P	5620P

NOTE:

- Per cave a "T" secondo norme DIN 650-UNI 4788-ISO 299
- For "T" slot cutters according to DIN 650-UNI 4788-ISO 299 norms
- Fuer "T" Nuten nach DIN 650-UNI 4788-ISO 299 Normen
- Pour rainures à "T" selon les normes DIN 650-UNI 4788-ISO 299

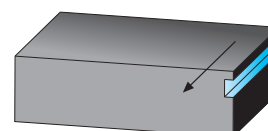
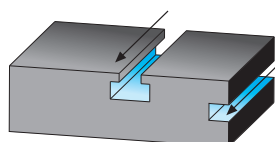

Z = NUMERO DI ELICHE - NUMBER OF FLUTES - SPIRALENANZAHL - NOMBRE D' HELICES
 K = FATTORE D 'AVANZAMENTO - FACTOR OF FEED - VORSCHUBFAKTOR - FACTEUR D' AVANCE
 W = FORO PER LIQUIDO REFRIGERANTE - COOLLANT BORE - KÜHLMITTELBOHRUNG - TROU DU LIQUIDE D'ARROSAGE

SCelta VELOCE - QUICK PICK												HT		HW	HC																						
												CERMET	NON RIV. CEMENTED CARBIDE GRADES	RIVESTITI COATED GRADES BESCHICHTET RECOUVERTS																							
														T3115	T528N																						
COD.		P			M			K			N			S			H					l	d	s	d1	r	a°										
		F	M	R	F	M	R	F	M	R	F	M	R	F	M	R	F	M	R																		
SPMT	060304	.N54	○	○	○	●	●	●																													
SPMT	09T308	.N54	○	○	○	●	●	●																													
SPMT	120408	.N54	○	○	○	●	●	●																													
SPMW	060304	.N51							○	●	●																										
SPMW	09T308	.N51							○	●	●																										
SPMW	120408	.N51							○	●	●																										
SPMW	060304	.N59	○	●	●	○																															
SPMW	09T308	.N59	○	●	●	○																															
SPMW	120408	.N59	○	●	●	○																															
CON ADDUZIONE LUBROREFRIGERANTE - WITH COOLANT SUPPLY																																					
SENZA ADDUZIONE LUBROREFRIGERANTE - WITHOUT COOLANT SUPPLY																																					

MATERIALI - MATERIALS Pag. 1199		VDI 3323 GR.	HB Rm1) HRC2)	fz0 mm		Vc m/min Pag. 552															
				1°	2°	T3115	T528N														
P	ACCIAIO NON LEGATO - NOT ALLOY STEEL	1--5	125-300	0,1	0,2		220														
	ACCIAIO POCO LEGATO - LOW ALLOY STEEL	6-9	180-350	0,06	0,15		220														
	ACCIAIO ALTO LEGATO - ALLOY STEEL	10-11	200-325	0,06	0,15		180														
	INOX MARTENS. - STAINLESS STEEL MART	12-13	200-240	0,06	0,12		160														
M	INOX AUST. DUPLEX - STAINLESS STEEL AUST	14.1-14.2	180-230	0,06	0,12		150														
K	GHISA GRIGIA - GREY CAST IRON	15-16	180-260	0,1	0,2	250															
	GHISA SFEROIDALE - SPHEROIDAL GRAPHITE	17-18	160-250	0,08	0,16	200															
	GHISA MALLEABILE - MALLEABLE CAST IRON	19-20	130-230	0,08	0,16	230															
N	ALLUMINIO E SUE LEGHE - ALUMINIUM	21--25	60-130																		
	RAME E SUE LEGHE - COPPER	26--28	90-110																		
	NON METALLICI - PLASTICS	29-30	/																		
S	LEGHE RESIST. CALORE - HIG. TEMP. ALLOY	31--35	200-320	0,06	0,12		40														
	TITANIO E SUE LEGHE - TITANIUM	36-37	400-1050 ⁹⁾	0,06	0,12		60														
H	ACCIAIO TEMPRATO - HARDENED STEEL	38-41	45-60 ^{a)}																		

$$n = \frac{Vc \cdot 1000}{\varnothing D \cdot 3,14} = \text{giri/min (min}^{-1}\text{)}$$

$$fz = fz0 \cdot Kae = \text{mm}$$

$$fn = fz \cdot K = \text{mm}$$

$$Vf = fz \cdot K \cdot n = \text{mm/min}$$

- F = FINITURA, LAV. LEGGERA - FINISHING, LIGHT MACHINING
M = LAV. MEDIA, GENERICA - MEDIUM MACHINING, GENERIC
R = SGROSSATURA, LAV. PESANTE - ROUGHING, HEAVY MACHINING
- Vc = m/min VELOCITÀ DI TAGLIO - CUTTING SPEED
n = giri/min (min⁻¹) NUMERO DI GIRI - NUMBER OF REVOLUTIONS
fz = mm AVANZAMENTO AL DENTE - TOOTH FEED
fn = mm AVANZAMENTO AL GIRO - FEED / REVOLUTION
Vf = mm/min VELOCITÀ DI AVANZAMENTO - FEED SPEED
Kae = FATTORE DI CORREZIONE - CORRECTION FACTOR

ae/D	0,5-1 50-100%	0,2 20%	0,1 10%	0,05 5%
Vc Pag. 552	Vc (min)-----Vc(max)			

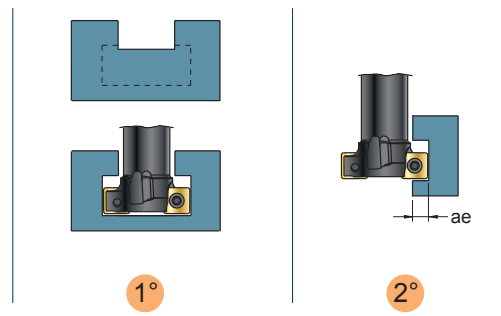

S 950 ..

Ø 63-250

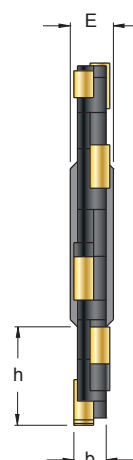
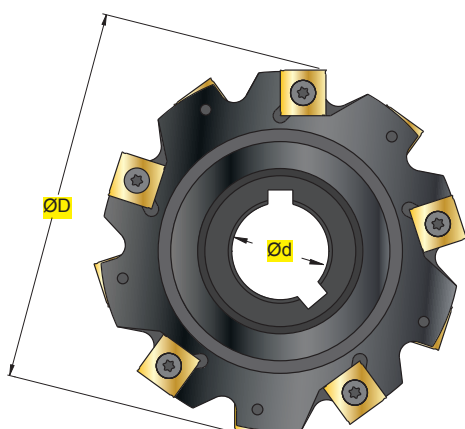

SNHX..
.Z47



SNHX..
.Z52



SNHX..
.Z62



INSERTI - INSERTS
PAG. 534

ART.	(mm)								kg	Nm			
	ØD	Ød	h	b	E	Z	K						
S 950 063 - 04	63	22	14	4	8	8	4	0,06	1,8+2,0	1102	C93504P	5609P	
S 950 063 - 05	63	22	14	5	8	8	4	0,07	1,8+2,0	1103	C93505P	5609P	
S 950 063 - 06	63	22	14	6	8	6	3	0,07	2,0+2,2	1203	C94005P	5615P	
S 950 080 - 04	80	22	22	4	8	10	5	0,10	1,8+2,0	1102	C93504	5609	
S 950 080 - 05	80	22	22	5	8	10	5	0,12	1,8+2,0	1103	C93505P	5609P	
S 950 080 - 06	80	22	22	6	8	8	4	0,13	2,0+2,2	1203	C94005P	5615P	
S 950 100 - 04	100	27	25	4	12	12	6	0,20	1,8+2,0	1102	C93504P	5609P	
S 950 100 - 05	100	27	25	5	12	12	6	0,23	1,8+2,0	1103	C93505P	5609P	
S 950 100 - 06	100	27	25	6	12	10	5	0,26	2,0+2,2	1203	C94005P	5615P	
S 950 100 - 07/08	100	27	25	7/8	12	10	5	0,30	2,0+2,2	1204/12045	C94006P	5615P	
S 950 100 - 10	100	27	25	10	12	10	5	0,37	2,0+2,2	1205	C94008P	5615P	
S 950 125 - 04	125	40	31	4	12	12	6	0,31	1,8+2,0	1102	C93504P	5609P	
S 950 125 - 05	125	40	31	5	12	12	6	0,35	1,8+2,0	1103	C93505P	5609P	
S 950 125 - 06	125	40	31	6	12	12	6	0,40	2,0+2,2	1203	C94005P	5615P	
S 950 125 - 07/08	125	40	31	7/8	12	12	6	0,45	2,0+2,2	1204/12045	C94006P	5615P	
S 950 125 - 10	125	40	31	10	12	12	6	0,57	2,0+2,2	1205	C94008P	5615P	
S 950 125 - 12	125	40	31	12	12	12	6	0,67	2,0+2,2	1207	C94010P	5615P	
S 950 160 - 04	160	40	44	4	12	18	9	0,56	1,8+2,0	1102	C93504P	5609P	
S 950 160 - 05	160	40	44	5	12	18	9	0,64	1,8+2,0	1103	C93505P	5609P	
S 950 160 - 06	160	40	44	6	12	16	8	0,74	2,0+2,2	1203	C94005P	5615P	
S 950 160 - 07/08	160	40	44	7/8	12	16	8	0,82	2,0+2,2	1204/12045	C94006P	5615P	
S 950 160 - 10	160	40	44	10	12	16	8	1,03	2,0+2,2	1205	C94008P	5615P	
S 950 160 - 12	160	40	44	12	12	16	8	1,30	2,0+2,2	1207	C94010P	5615P	
S 950 160 - 14	160	40	44	14	14	15	5	1,50	2,0+2,2	1205	C94008P	5615P	
S 950 200 - 04	200	50	62	4	12	18	9	0,76	1,8+2,0	1102	C93504P	5609P	
S 950 200 - 05	200	50	62	5	12	18	9	0,89	1,8+2,0	1103	C93505P	5609P	
S 950 200 - 06	200	50	62	6	12	18	9	1,10	2,0+2,2	1203	C94005P	5615P	
S 950 200 - 07/08	200	50	62	7/8	12	18	9	1,30	2,0+2,2	1204/12045	C94006P	5615P	
S 950 200 - 10	200	50	62	10	12	18	9	1,70	2,0+2,2	1205	C94008P	5615P	
S 950 200 - 12	200	50	62	12	12	18	9	2,00	2,0+2,2	1207	C94010P	5615P	
S 950 200 - 14	200	50	62	14	14	18	6	2,40	2,0+2,2	1205	C94008P	5615P	
S 950 250 - 10	250	50	87	10	12	24	12	2,70	2,0+2,2	1205	C94008P	5615P	
S 950 250 - 12	250	50	87	12	12	20	10	3,40	2,0+2,2	1207	C94010P	5615P	

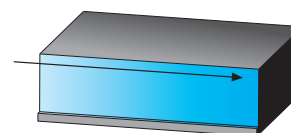
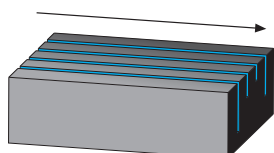

K = FATTORE D'AVANZAMENTO - FACTOR OF FEED - VORSCHUBFAKTOR - FACTEUR D'AVANCE

SCelta VELOCE - QUICK PICK

Tenacità \uparrow Toughness \downarrow

Pag. 538

COD.	MATERIALI												HT				HW				HC				DIMENSIONI																													
	P			M			K			N			S			H			CERMET		NON RIV. CEMENTED CARBIDE GRADES		RIVESTITI COATED GRADES BESCHICHTET RECOUVERTS		I	d	s	d1	r	a°																								
	F	M	R	F	M	R	F	M	R	F	M	R	F	M	R	F	M	R	F	M	R	F	M	R	F	M	R	F	M	R	T115	T5020	T528N	F1035																				
SNHX 1102 .Z47									●	●	●	●	●								■																			11,0	11,0	2,3	4,4	-	-									
SNHX 1103 .Z47									●	●	●	●	●									■																			11,0	11,0	2,7	4,4	-	-								
SNHX 1203 .Z47									●	●	●	●	●									■																			12,7	12,7	3,2	5,0	-	-								
SNHX 1204 .Z47									●	●	●	●	●									■																				12,7	12,7	4,0	5,0	-	-							
SNHX 12045 .Z47									●	●	●	●	●									■																					12,7	12,7	4,5	5,0	-	-						
SNHX 1205 .Z47									●	●	●	●	●									■																						12,7	12,7	5,4	5,0	-	-					
SNHX 1207 .Z47									●	●	●	●	●									■																						12,7	12,7	7,0	5,0	-	-					
SNHX 1102 .Z52		●	●						●	●	○	○										■																							11,0	11,0	2,3	4,4	-	-				
SNHX 1103 .Z52		●	●	●	●				●	●	○	○										■																								11,0	11,0	2,7	4,4	-	-			
SNHX 1203 .Z52		●	●	●	●	●			●	●	○	○										■																								12,7	12,7	3,2	5,0	-	-			
SNHX 1204 .Z52		●	●	●	●	●			●	●	○	○										■																								12,7	12,7	4,0	5,0	-	-			
SNHX 12045 .Z52		●	●	●	●	●			●	●	○	○										■																									12,7	12,7	4,5	5,0	-	-		
SNHX 1205 .Z52		●	●	●	●	●			●	●	○	○										■																										12,7	12,7	5,4	5,0	-	-	
SNHX 1207 .Z52		●	●	●	●	●			●	●	○	○										■																									12,7	12,7	7,0	5,0	-	-		
SNHX 1102 .Z62		●	●						●	●	○	○										■																									11,0	11,0	2,3	4,4	-	-		
SNHX 1103 .Z62		●	●						●	●	○	○										■																										11,0	11,0	2,7	4,4	-	-	
SNHX 1203 .Z62		●	●						●	●	○	○										■																										12,7	12,7	3,2	5,0	-	-	
SNHX 1204 .Z62		●	●						●	●	○	○										■																										12,7	12,7	4,0	5,0	-	-	
SNHX 12045 .Z62		●	●						●	●	○	○										■																										12,7	12,7	4,5	5,0	-	-	
SNHX 1205 .Z62		●	●						●	●	○	○										■																											12,7	12,7	5,4	5,0	-	-
SNHX 1207 .Z62		●	●						●	●	○	○										■																										12,7	12,7	7,0	5,0	-	-	

CON ADDUZIONE LUBROREFRIGERANTE - WITH COOLANT SUPPLY

SENZA ADDUZIONE LUBROREFRIGERANTE - WITHOUT COOLANT SUPPLY

MATERIALI - MATERIALS Pag. 1199	VDI 3323 GR.	HB Rm ¹ HRC ²	fz0 mm			Vc m/min Pag. 552												
			F	M	R	T115	T5020	T528N	F1035									
P ACCIAIO NON LEGATO - NOT ALLOY STEEL	1-5	125-300	0,08	0,12	0,16		220	220	125									
P ACCIAIO POCO LEGATO - LOW ALLOY STEEL	6-9	180-350	0,06	0,11	0,15		150	160	120									
P ACCIAIO ALTO LEGATO - ALLOY STEEL	10-11	200-325	0,06	0,11	0,15		140	150	100									
P INOX MARTENS. - STAINLESS STEEL MART	12-13	200-240	0,05	0,07	0,1		150	140	100									
M INOX AUST. DUPLEX - STAINLESS STEEL AUST	14.1-14.2	180-230	0,05	0,07	0,1			120	90									
K GHISA GRIGIA - GREY CAST IRON	15-16	180-260	0,1	0,14	0,18	120	160	180										
K GHISA SFEROIDALE - SPHEROIDAL GRAPHITE	17-18	160-250	0,08	0,12	0,16	120	150	160										
K GHISA MALLEABILE - MALLEABLE CAST IRON	19-20	130-230	0,08	0,12	0,16	120	160	170										
N ALLUMINIO E SUE LEGHE - ALUMINIUM	21-25	60-130	0,08	0,12	0,16	950												
N RAME E SUE LEGHE - COPPER	26-28	90-110	0,06	0,1	0,15	400												
N NON METALLICI - PLASTICS	29-30	/	0,06	0,1	0,15	300												
S LEGHE RESIST. CALORE - HIG. TEMP. ALLOY	31-35	200-320	0,06	0,08	0,12			40										
S TITANIO E SUE LEGHE - TITANIUM	36-37	400-1050 ¹⁾	0,06	0,08	0,12			60										
H ACCIAIO TEMPRATO - HARDENED STEEL	38-41	45-60 ²⁾																

$$n = \frac{Vc \cdot 1000}{\text{ØD} \cdot 3,14} = \text{giri/min (min}^{-1}\text{)}$$

$$fz = fz0 \cdot Kae = \text{mm}$$

$$fn = fz \cdot K = \text{mm}$$

$$Vf = fz \cdot K \cdot n = \text{mm/min}$$

F = FINITURA , LAV. LEGGERA - FINISHING , LIGHT MACHINING
M = LAV. MEDIA , GENERIC - MEDIUM MACHINING , GENERIC
R = SGROSSATURA , LAV. PESANTE - ROUGHING , HEAVY MACHINING

Vc = m/min VELOCITÀ DI TAGLIO - CUTTING SPEED
n = giri/min (min⁻¹) NUMERO DI GIRI - NUMBER OF REVOLUTIONS
fz = mm AVANZAMENTO AL DENTE -TOOTH FEED
fn = mm AVANZAMENTO AL GIRO - FEED / REVOLUTION
Vf = mm/min VELOCITÀ DI AVANZAMENTO - FEED SPEED
Kae = FATTORE DI CORREZIONE - CORRECTION FACTOR

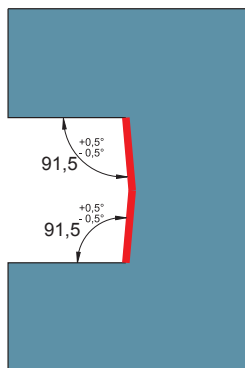

ae/D	0,5-1 50-100%	0,2 20%	0,1 10%	0,05 5%
Vc	Vc (min)-----Vc(max)			

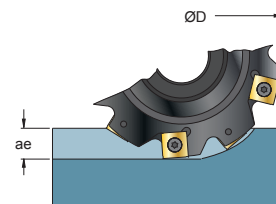

ae/D	0,3 30%	0,2 20%	0,1 10%	0,05 5%	0,02 2%
Kae	1,2	1,5	2,1	3	4,8

S 955 ..
S 955M ..

Ø 50-160

ISO 6462 ...

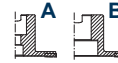

SNHX..



SNHX..



SNHX..

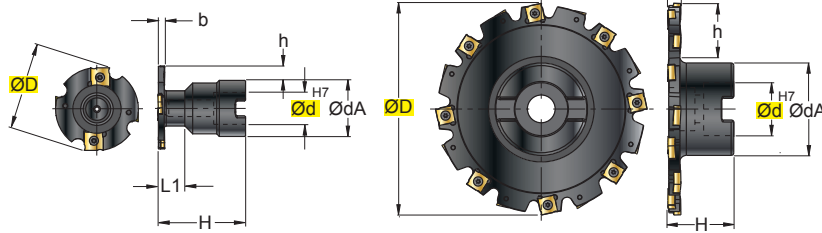
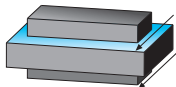
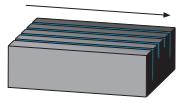

Ø50

Ø63+Ø160



INSERTI - INSERTS
PAG. 534

(mm)

ART.	ØD	Ød	b	ØdA	H	L1	h	Z	K	kg	Nm	ISO 6462					
S 955 050 - 04	50	16	4	32	50	15	8,5	4	2	0,20	1,8+2,0	-	1102	C93504P	5609P	VDST2008	-
S 955 050 - 05	50	16	5	32	50	15	8,5	4	2	0,21	1,8+2,0	-	1103	C93505P	5609P	VDST2008	-
S 955 050 - 06	50	16	6	32	50	15	8,5	4	2	0,21	2,0+2,2	-	1203	C94005P	5615P	VDST2008	-
S 955 050 - 07/08	50	16	7/8	32	50	15	8,5	4	2	0,22	2,0+2,2	-	1204/12045	C94006P	5615P	VDST2008	-
S 955 050 - 10	50	16	10	32	50	15	8,5	4	2	0,25	2,0+2,2	-	1205	C94008P	5615P	VDST2008	-
S 955 050 - 12	50	16	12	32	50	15	8,5	4	2	0,26	2,0+2,2	-	1207	C94010P	5615P	VDST2008	-
S 955 063 - 04	63	22	4	40	50	-	10,5	8	4	0,34	1,8+2,0	A	1102	C93504P	5609P	-	AL10x40
S 955 063 - 05	63	22	5	40	50	-	10,5	8	4	0,35	1,8+2,0	A	1103	C93505P	5609P	-	AL10x40
S 955 063 - 06	63	22	6	40	50	-	10,5	6	3	0,35	2,0+2,2	A	1203	C94005P	5615P	-	AL10x40
S 955 063 - 07/08	63	22	7/8	40	50	-	10,5	6	3	0,37	2,0+2,2	A	1204/12045	C94006P	5615P	-	AL10x40
S 955 063 - 10	63	22	10	40	50	-	10,5	6	3	0,39	2,0+2,2	A	1205	C94008P	5615P	-	AL10x40
S 955 063 - 12	63	22	12	40	50	-	10,5	6	3	0,40	2,0+2,2	A	1207	C94010P	5615P	-	AL10x40
S 955 063 - 14	63	22	14	40	50	-	10,5	6	2	0,43	2,0+2,2	A	1205	C94008P	5615P	-	AL10x40
S 955 063 - 16	63	22	16	40	50	-	10,5	6	2	0,45	2,0+2,2	A	1207	C94008P	5615P	-	AL10x40
S 955 080 - 04	80	22	4	40	50	-	20	10	5	0,38	1,8+2,0	A	1102	C93504P	5609P	-	AL10x40
S 955 080 - 05	80	22	5	40	50	-	20	10	5	0,40	1,8+2,0	A	1103	C93505P	5609P	-	AL10x40
S 955 080 - 06	80	22	6	40	50	-	20	8	4	0,41	2,0+2,2	A	1203	C94005P	5615P	-	AL10x40
S 955 080 - 07/08	80	22	7/8	40	50	-	20	8	4	0,44	2,0+2,2	A	1204/12045	C94006P	5615P	-	AL10x40
S 955 080 - 10	80	22	10	40	50	-	20	8	4	0,49	2,0+2,2	A	1205	C94008P	5615P	-	AL10x40
S 955 080 - 12	80	22	12	40	50	-	20	8	4	0,53	2,0+2,2	A	1207	C94010P	5615P	-	AL10x40
S 955 080 - 14	80	22	14	40	50	-	20	6	2	0,59	2,0+2,2	A	1205	C94008P	5615P	-	AL10x40
S 955 080 - 16	80	22	16	40	50	-	20	6	2	0,63	2,0+2,2	A	1207	C94008P	5615P	-	AL10x40
S 955 100 - 04	100	27	4	48	50	-	24,2	12	6	0,64	1,8+2,0	A	1102	C93504P	5609P	-	VBSF12L
S 955 100 - 05	100	27	5	48	50	-	24,2	12	6	0,68	1,8+2,0	A	1103	C93505P	5609P	-	VBSF12L
S 955 100 - 06	100	27	6	48	50	-	24,2	10	5	0,69	2,0+2,2	A	1203	C94005P	5615P	-	VBSF12L
S 955 100 - 07/08	100	27	7/8	48	50/50,5	-	24,2	10	5	0,73	2,0+2,2	A	1204/12045	C94006P	5615P	-	VBSF12L
S 955 100 - 10	100	27	10	48	50	-	24,2	10	5	0,79	2,0+2,2	A	1205	C94008P	5615P	-	VBSF12L
S 955 100 - 12	100	27	12	48	50	-	24,2	10	5	0,85	2,0+2,2	A	1207	C94010P	5615P	-	VBSF12L
S 955 100 - 14	100	27	14	48	50	-	24,2	9	3	0,95	2,0+2,2	A	1205	C94008P	5615P	-	VBSF12L
S 955 100 - 16	100	27	16	48	50	-	24,2	9	3	1,00	2,0+2,2	A	1207	C94008P	5615P	-	VBSF12L
S 955M 125 - 04	125	32	4	59	50	-	31	12	6	0,98	1,8+2,0	A	1102	C93504P	5609P	-	VBSF16
S 955M 125 - 05	125	32	5	59	50	-	31	12	6	1,02	1,8+2,0	A	1103	C93505P	5609P	-	VBSF16
S 955M 125 - 06	125	32	6	59	50	-	31	12	6	1,05	2,0+2,2	A	1203	C94005P	5615P	-	VBSF16
S 955M 125 - 07/08	125	32	7/8	59	50/50,5	-	31	12	6	1,09	2,0+2,2	A	1204/12045	C94006P	5615P	-	VBSF16
S 955M 125 - 10	125	32	10	59	50	-	31	12	6	1,19	2,0+2,2	A	1205	C94008P	5615P	-	VBSF16
S 955M 125 - 12	125	32	12	59	50	-	31	12	6	1,28	2,0+2,2	A	1207	C94010P	5615P	-	VBSF16
S 955 125 - 04	125	40	4	70	50	-	23,7	12	6	0,95	1,8+2,0	A	1102	C93504P	5609P	-	-
S 955 125 - 05	125	40	5	70	50	-	23,7	12	6	0,99	1,8+2,0	A	1103	C93505P	5609P	-	-
S 955 125 - 06	125	40	6	70	50	-	23,7	12	6	1,02	2,0+2,2	A	1203	C94005P	5615P	-	-
S 955 125 - 07/08	125	40	7/8	70	50/50,5	-	23,7	12	6	1,06	2,0+2,2	A	1204/12045	C94006P	5615P	-	-
S 955 125 - 10	125	40	10	70	50	-	23,7	12	6	1,16	2,0+2,2	A	1205	C94008P	5615P	-	-
S 955 125 - 12	125	40	12	70	50	-	23,7	12	6	1,25	2,0+2,2	A	1207	C94010P	5615P	-	-
S 955 125 - 14	125	40	14	70	50	-	23,7	12	4	1,35	2,0+2,2	A	1205	C94008P	5615P	-	-
S 955 125 - 16	125	40	16	70	50	-	23,7	12	4	1,43	2,0+2,2	A	1207	C94008P	5615P	-	-
S 955 160 - 04	160	40	4	70	50	-	41,2	16	8	1,14	1,8+2,0	B	1102	C93504P	5609P	-	-
S 955 160 - 05	160	40	5	70	50	-	41,2	16	8	1,21	1,8+2,0	B	1103	C93505P	5609P	-	-
S 955 160 - 06	160	40	6	70	50	-	41,2	16	8	1,41	2,0+2,2	B	1203	C94005P	5615P	-	-
S 955 160 - 07/08	160	40	7/8	70	50/50,5	-	41,2	16	8	1,41	2,0+2,2	B	1204/12045	C94006P	5615P	-	-
S 955 160 - 10	160	40	10	70	50	-	41,2	16	8	1,62	2,0+2,2	B	1205	C94008P	5615P	-	-
S 955 160 - 12	160	40	12	70	50	-	41,2	16	8	1,81	2,0+2,2	B	1207	C94010P	5615P	-	-
S 955 160 - 14	160	40	14	70	50	-	41,2	15	5	2,04	2,0+2,2	B	1205	C94008P	5615P	-	-
S 955 160 - 16	160	40	16	70	50	-	41,2	15	5	2,23	2,0+2,2	B	1207	C94008P	5615P	-	-

K = FATTORE D'AVANZAMENTO - FACTOR OF FEED - VORSCHUBFAKTOR - FACTEUR D'AVANCE



SCelta VELOCE - QUICK PICK



COD.	P				M				K				N				S				H				HT CERMET	HW NON RIV. CEMENTED CARBIDE GRADES	HC RIVESTITI COATED GRADES BESCHICHTET RECOUVERTS							
	F	M	R		F	M	R		F	M	R		F	M	R		F	M	R		F	M	R				T115	T5020	T528N	F1035	l	d	s	d1
SNHX 1102	.Z47								●	●		●	●																					
SNHX 1103	.Z47								●	●		●	●																					
SNHX 1203	.Z47								●	●		●	●																					
SNHX 1204	.Z47								●	●		●	●																					
SNHX 12045	.Z47								●	●		●	●																					
SNHX 1205	.Z47								●	●		●	●																					
SNHX 1207	.Z47								●	●		●	●																					
SNHX 1102	.Z52		●	●																														
SNHX 1103	.Z52		●	●																														
SNHX 1203	.Z52		●	●																														
SNHX 1204	.Z52		●	●																														
SNHX 12045	.Z52		●	●																														
SNHX 1205	.Z52		●	●																														
SNHX 1207	.Z52		●	●																														
SNHX 1102	.Z62		●	●																														
SNHX 1103	.Z62		●	●																														
SNHX 1203	.Z62		●	●																														
SNHX 1204	.Z62		●	●																														
SNHX 12045	.Z62		●	●																														
SNHX 1205	.Z62		●	●																														
SNHX 1207	.Z62		●	●																														

CON ADDUZIONE LUBROREFRIGERANTE - WITH COOLANT SUPPLY

SENZA ADDUZIONE LUBROREFRIGERANTE - WITHOUT COOLANT SUPPLY

MATERIALI - MATERIALS Pag. 1199		VDI 3323 GR.	HB Rm1) HRC2)	fz0 mm			Vc m/min Pag. 552							
P	M			K	N	S	H	T115	T5020	T528N	F1035			
	ACCIAIO NON LEGATO - NOT ALLOY STEEL	1--5	125-300	0,08	0,12	0,16		220	220	125				
	ACCIAIO POCO LEGATO - LOW ALLOY STEEL	6-9	180-350	0,06	0,11	0,15		150	160	120				
	ACCIAIO ALTO LEGATO - ALLOY STEEL	10-11	200-325	0,06	0,11	0,15		140	150	100				
	INOX MARTENS. - STAINLESS STEEL MART	12-13	200-240	0,05	0,07	0,1		150	140	100				
	INOX AUST. DUPLEX - STAINLESS STEEL AUST	14.1-14.2	180-230	0,05	0,07	0,1			120	90				
	GHISA GRIGIA - GREY CAST IRON	15-16	180-260	0,1	0,14	0,18	120	160	180					
	GHISA SFEROIDALE - SPHEROIDAL GRAPHITE	17-18	160-250	0,08	0,12	0,16	120	150	160					
	GHISA MALLEABILE - MALLEABLE CAST IRON	19-20	130-230	0,08	0,12	0,16	120	160	170					
	ALLUMINIO E SUE LEGHE - ALUMINIUM	21--25	60-130	0,08	0,12	0,16	950							
	RAME E SUE LEGHE - COPPER	26-28	90-110	0,06	0,1	0,15	400							
	NON METALLICI - PLASTICS	29-30	/	0,06	0,1	0,15	300							
	LEGHE RESIST. CALORE - HIG. TEMP. ALLOY	31--35	200-320	0,06	0,08	0,12			40					
	TITANIO E SUE LEGHE - TITANIUM	36-37	400-1050 ¹⁾	0,06	0,08	0,12			60					
	ACCIAIO TEMPRATO - HARDENED STEEL	38-41	45-60 ²⁾											

$$n = \frac{Vc \cdot 1000}{\varnothing D \cdot 3,14} = \text{giri/min (min}^{-1}\text{)}$$

$$fz = fz0 \cdot Kae = \text{mm}$$

$$fn = fz \cdot K = \text{mm}$$

$$Vf = fz \cdot K \cdot n = \text{mm/min}$$

F = FINITURA , LAV. LEGGERA - FINISHING , LIGHT MACHINING
 M = LAV. MEDIA , GENERIC - MEDIUM MACHINING , GENERIC
 R = SGROSSATURA , LAV. PESANTE - ROUGHING , HEAVY MACHINING

Vc = m/min VELOCITÀ DI TAGLIO - CUTTING SPEED
 n = giri/min (min⁻¹) NUMERO DI GIRI - NUMBER OF REVOLUTIONS
 fz = mm AVANZAMENTO AL DENTE -TOOTH FEED
 fn = mm AVANZAMENTO AL GIRO - FEED / REVOLUTION
 Vf = mm/min VELOCITÀ DI AVANZAMENTO - FEED SPEED
 Kae = FATTORE DI CORREZIONE - CORRECTION FACTOR

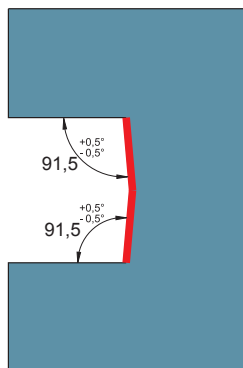

ae/D	0,5-1 50-100%	0,2 20%	0,1 10%	0,05 5%
Vc	Vc (min)-----Vc(max)			

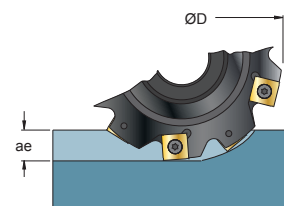

ae/D	0,3 30%	0,2 20%	0,1 10%	0,05 5%	0,02 2%
Kae	1,2	1,5	2,1	3	4,8

■ DISPONIBILI - IN STOCK - LIEFERBAR - DISPONIBLES / ■ NEW
 ●● APPLICAZIONE CONSIGLIATA-RECOMMENDED APPLICATION
 EMPFOHLENER EINSATZ - APPLICATION CONSEILLÉE

□ A RICHIESTA - ON REQUEST - AUF ANFRAGE - SUR DEMANDE / □ NEW
 ○○ APPLICAZIONE POSSIBILE - POSSIBLE APPLICATION
 MÖGLICHE ANWENDUNG - APPLICATION POSSIBLE

S 959 ..

Ø 50-80

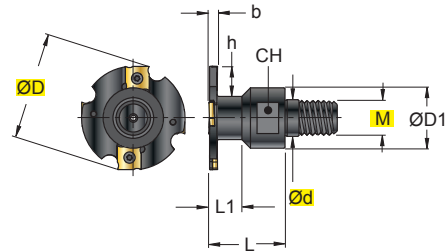

SNHX..
.Z47



SNHX..
.Z52



SNHX..
.Z62



INSERTI - INSERTS
PAG. 534

(mm)

ART.	ØD	M	Ød	b	ØD1	h	L	L1	Z	K	CH	kg	Nm			
S 959 050 - 04	50	16	17	4	29	14	35	15	4	2	24	0,19	1,8+2,0	1102	C93504P	5609P
S 959 050 - 05	50	16	17	5	29	14	35	15	4	2	24	0,20	1,8+2,0	1103	C93505P	5609P
S 959 050 - 06	50	16	17	6	29	14	35	15	4	2	24	0,20	2,0+2,2	1203	C94005P	5615P
S 959 063 - 04	63	16	17	4	29	14	35	-	8	4	24	0,26	1,8+2,0	1102	C93504P	5609P
S 959 063 - 05	63	16	17	5	29	14	35	-	8	4	24	0,27	1,8+2,0	1103	C93505P	5609P
S 959 063 - 06	63	16	17	6	29	14	35	-	6	3	24	0,28	2,0+2,2	1203	C94005P	5615P
S 959 080 - 04	80	16	17	4	29	22,5	35	-	10	5	24	0,31	1,8+2,0	1102	C93504	5609
S 959 080 - 05	80	16	17	5	29	22,5	35	-	10	5	24	0,32	1,8+2,0	1103	C93505P	5609P
S 959 080 - 06	80	16	17	6	29	22,5	35	-	8	4	24	0,34	2,0+2,2	1203	C94005P	5615P

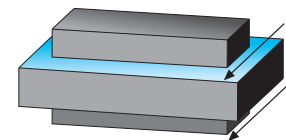
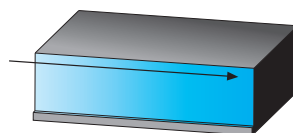
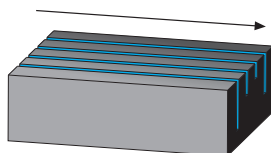

K = FATTORE D'AVANZAMENTO - FACTOR OF FEED - VORSCHUBFAKTOR - FACTEUR D'AVANCE

SCelta VELOCE - QUICK PICK

Tenacità +
Toughness -

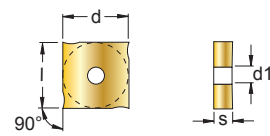

Pag. 538

COD.	P		M		K		N		S		H		HT CERMET	HW NON RIV. CEMENTED CARBIDE GRADES	HC RIVESTITI COATED GRADES BESCHICHTET RECOUVERTS									
	F M R		F M R		F M R		F M R		F M R		F M R				T115	T5020	T528N	F1035	l	d	s	d1	r	a°
	F	M	R	F	M	R	F	M	R	F	M	R												
SNHX 1102 .Z47														■				11,0	11,0	2,3	4,4	-	-	
SNHX 1103 .Z47														■				11,0	11,0	2,7	4,4	-	-	
SNHX 1203 .Z47														■				12,7	12,7	3,2	5,0	-	-	
SNHX 1204 .Z47														■				12,7	12,7	4,0	5,0	-	-	
SNHX 12045 .Z47														■				12,7	12,7	4,5	5,0	-	-	
SNHX 1205 .Z47														■				12,7	12,7	5,4	5,0	-	-	
SNHX 1207 .Z47														■				12,7	12,7	7,0	5,0	-	-	
SNHX 1102 .Z52		●	●					○	○									11,0	11,0	2,3	4,4	-	-	
SNHX 1103 .Z52		●	●	●	●			○	○									11,0	11,0	2,7	4,4	-	-	
SNHX 1203 .Z52		●	●	●	●			○	○									12,7	12,7	3,2	5,0	-	-	
SNHX 1204 .Z52		●	●	●	●			○	○									12,7	12,7	4,0	5,0	-	-	
SNHX 12045 .Z52		●	●	●	●			○	○									12,7	12,7	4,5	5,0	-	-	
SNHX 1205 .Z52		●	●	●	●			○	○									12,7	12,7	5,4	5,0	-	-	
SNHX 1207 .Z52		●	●	●	●			○	○									12,7	12,7	7,0	5,0	-	-	
SNHX 1102 .Z62		●	●					○	○									11,0	11,0	2,3	4,4	-	-	
SNHX 1103 .Z62		●	●					○	○									11,0	11,0	2,7	4,4	-	-	
SNHX 1203 .Z62		●	●					○	○									12,7	12,7	3,2	5,0	-	-	
SNHX 1204 .Z62		●	●					○	○									12,7	12,7	4,0	5,0	-	-	
SNHX 12045 .Z62		●	●					○	○									12,7	12,7	4,5	5,0	-	-	
SNHX 1205 .Z62		●	●					○	○									12,7	12,7	5,4	5,0	-	-	
SNHX 1207 .Z62		●	●					○	○									12,7	12,7	7,0	5,0	-	-	

CON ADDUZIONE LUBROREFRIGERANTE - WITH COOLANT SUPPLY

SENZA ADDUZIONE LUBROREFRIGERANTE - WITHOUT COOLANT SUPPLY



MATERIALI - MATERIALS Pag. 1199			VDI 3323 GR.	HB Rm1) HRC2)	fz0 mm			Vc m/min Pag. 552					
					F	M	R	T115	T5020	T528N	F1035		
P	ACCIAIO NON LEGATO - NOT ALLOY STEEL		1-5	125-300	0,08	0,12	0,16		220	220	125		
	ACCIAIO POCO LEGATO - LOW ALLOY STEEL		6-9	180-350	0,06	0,11	0,15		150	160	120		
	ACCIAIO ALTO LEGATO - ALLOY STEEL		10-11	200-325	0,06	0,11	0,15		140	150	100		
	INOX MARTENS. - STAINLESS STEEL MART		12-13	200-240	0,05	0,07	0,1		150	140	100		
M	INOX AUST. DUPLEX - STAINLESS STEEL AUST		14.1-14.2	180-230	0,05	0,07	0,1			120	90		
K	GHISA GRIGIA - GREY CAST IRON		15-16	180-260	0,1	0,14	0,18	120	160	180			
	GHISA SFEROIDALE - SPHEROIDAL GRAPHITE		17-18	160-250	0,08	0,12	0,16	120	150	160			
	GHISA MALLEABILE - MALLEABLE CAST IRON		19-20	130-230	0,08	0,12	0,16	120	160	170			
N	ALLUMINIO E SUE LEGHE - ALUMINIUM		21-25	60-130	0,08	0,12	0,16	950					
	RAME E SUE LEGHE - COPPER		26-28	90-110	0,06	0,1	0,15	400					
	NON METALLICI - PLASTICS		29-30	/	0,06	0,1	0,15	300					
S	LEGHE RESIST. CALORE - HIG. TEMP. ALLOY		31-35	200-320	0,06	0,08	0,12			40			
	TITANIO E SUE LEGHE - TITANIUM		36-37	400-1050 ¹⁾	0,06	0,08	0,12			60			
H	ACCIAIO TEMPRATO - HARDENED STEEL		38-41	45-60 ²⁾									

$$n = \frac{V_c \cdot 1000}{\varnothing D \cdot 3,14} = \text{giri/min (min}^{-1})$$

$$fz = fz0 \cdot Kae = \text{mm}$$

$$fn = fz \cdot K = \text{mm}$$

$$Vf = fz \cdot K \cdot n = \text{mm/min}$$

F = FINITURA, LAV. LEGGERA - FINISHING, LIGHT MACHINING
M = LAV. MEDIA, GENERICA - MEDIUM MACHINING, GENERIC
R = SGROSSATURA, LAV. PESANTE - ROUGHING, HEAVY MACHINING

Vc = m/min VELOCITÀ DI TAGLIO - CUTTING SPEED
n = giri/min (min⁻¹) NUMERO DI GIRI - NUMBER OF REVOLUTIONS
fz = mm AVANZAMENTO AL DENTE - TOOTH FEED
fn = mm AVANZAMENTO AL GIRO - FEED / REVOLUTION
Vf = mm/min VELOCITÀ DI AVANZAMENTO - FEED SPEED
Kae = FATTORE DI CORREZIONE - CORRECTION FACTOR

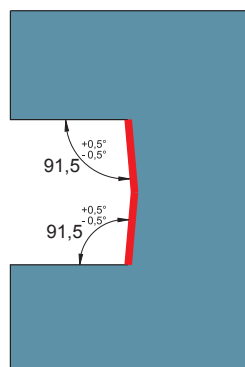

ae/D	0,5-1 50-100%	0,2 20%	0,1 10%	0,05 5%
Vc Pag. 552	Vc (min)-----Vc(max)			

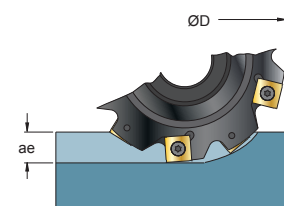

ae/D	0,3 30%	0,2 20%	0,1 10%	0,05 5%	0,02 2%
Kae	1,2	1,5	2,1	3	4,8

■ DISPONIBILI - IN STOCK - LIEFERBAR - DISPONIBLES / ■ NEW
● APPLICAZIONE CONSIGLIATA-RECOMMENDED APPLICATION
EMPFÖHLENER EINSATZ - APPLICATION CONSEILLÉE

□ A RICHIESTA - ON REQUEST - AUF ANFRAGE - SUR DEMANDE / □ NEW
○ APPLICAZIONE POSSIBILE - POSSIBLE APPLICATION
MÖGLICHE ANWENDUNG - APPLICATION POSSIBLE

S 905W ..

Ø 20-32

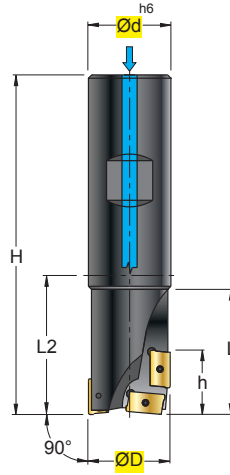

APKT 1003
.S52



APKT 1604
.S52







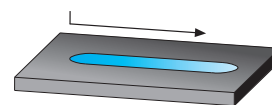
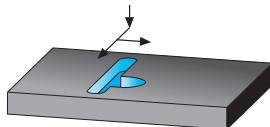

















INSERTI - INSERTS
PAG. 526/527

ART.	(mm)									kg	Nm			
	ØD	Ød	H	h	L	L2	Z	K						
S 905W 020 - 10	20	20	90	19	35	40	2	1	0,17	1,1+1,3	N°3 1003	12255P	5608P	
S 905W 025 - 10	25	25	110	19	50	54	2	1	0,32	1,1+1,3				
S 905W 032 - 16	32	32	130	29	50	70	2	1	0,64	3,8+5,0	N°3 1604	C04011P	5615P	

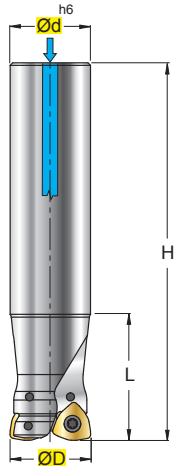
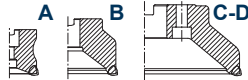
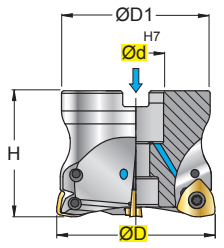
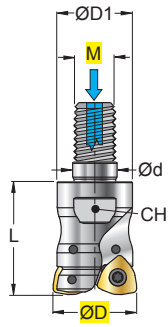

Z = NUMERO DI ELICHE - NUMBER OF FLUTES - SPIRALENANZAHL - NOMBRE D' HELICES
K = FATTORE D 'AVANZAMENTO - FACTOR OF FEED - VORSCHUBFAKTOR - FACTEUR D' AVANCE
W = FORO PER LIQUIDO REFRIGERANTE - COOLLANT BORE - KÜHLMITTELBOHRUNG - TROU DU LIQUIDE D'ARROSAGE

S846W Pag. 502		S848W Pag. 502		S849W Pag. 502		S806 Pag. 508						
	ØD = 25 - 40		ØD = 40 - 100		ØD = 25 - 40		ØD = 12,5 - 20		ØD = 15 - 16			
S 846LW .. 06 S 846XLW .. 06 S 846LW .. 08 S 846GLW .. 08 S 846XLW .. 08 S 846GLW .. 08		S 848W .. 06 S 848W .. 08 S 848WF .. 08		S 849W .. 06 S 849W .. 08 S 849W .. 08		S 806W ..						
		WP..06.. WP..08..	h = 1,5			RD.. 0701 RD.. 0702 RD.. 1003	h = 3,5 h = 3,5 h = 5					
S1502 Pag. 504				S808 Pag. 510								
			ØD = 50 - 80				ØD = 40 - 160					
		S 1502.8W ..				S 808W ..						
		WN.. 1405	h = 2			RD.. 1003 RD.. 12T3 RD.. 1604	h = 5 h = 6 h = 8					
S1503.6LW Pag. 506		S1503.8W Pag. 506		S1503.9W Pag. 506		S809 Pag. 512						
	ØD = 16 - 40		ØD = 40 - 63		ØD = 16 - 35		ØD = 10 - 32		ØD = 15 - 42			
S 1503.6LW ..		S 1503.8W ..		S 1503.9W ..		S 809W ..						
		LNMT 060312 h = 1				RD.. 0501 h = 2,5 RD.. 0701 h = 3,5 RD.. 0702 h = 3,5	RD.. 1003 h = 5 RD.. 12T3 h = 6 RD.. 1604 h = 8					

S 846..W .. 06 S 846..W .. 08	$\gamma_p +5^\circ/-4^\circ$ $\gamma_f -2,8^\circ$ $\gamma_o -5,8^\circ$	S 848..W .. 06 S 848..W .. 08	$\gamma_p +5^\circ$ $\gamma_f -3,5^\circ$ $\gamma_o -6,2^\circ$	S 849..W .. 06 S 849..W .. 08	$\gamma_p +4^\circ/+5^\circ$ $\gamma_f -2,8^\circ$ $\gamma_o -5,7^\circ$	WPMT .. .N42	
$\varnothing 25-40$		$\varnothing 40-100$		$\varnothing 25-40$		WPMW .. .N52	
		<p style="text-align: center;">ISO 6462 ...</p>  				 INSERTI - INSERTS PAG. 537	

ART.	(mm)											ISO 6462	ISO 6462	ISO 6462	ISO 6462	ISO 6462		
	$\varnothing D$	M	$\varnothing d$	$\varnothing D1$	H	L	β	Z	CH	kg	Nm							
S 846LW 025 - 06	25	-	25	-	140	60	5°	2	-	0,43	3,8+5,0	-	06...	C04008P	5615P	-	2440	
S 846LW 026 - 06	26	-	25	-	140	60	4,5°	2	-	0,44	3,8+5,0	-	06...	C04008P	5615P	-	2440	
S 846LW 032 - 06	32	-	32	-	150	70	3,5°	3	-	0,79	3,8+5,0	-	06...	C04008P	5615P	-	2440	
S 846LW 033 - 06	33	-	32	-	150	70	3°	3	-	0,80	3,8+5,0	-	06...	C04008P	5615P	-	2440	
S 846XLW 025 - 06	25	-	25	-	200	120	5°	2	-	0,60	3,8+5,0	-	06...	C04008P	5615P	-	2440	
S 846XLW 026 - 06	26	-	25	-	200	120	4,5°	2	-	0,62	3,8+5,0	-	06...	C04008P	5615P	-	2440	
S 846XLW 032 - 06	32	-	32	-	250	170	3,5°	3	-	1,29	3,8+5,0	-	06...	C04008P	5615P	-	2440	
S 846XLW 033 - 06	33	-	32	-	250	170	3°	3	-	1,32	3,8+5,0	-	06...	C04008P	5615P	-	2440	
S 846LW 032 - 08	32	-	32	-	150	50	10°	2	-	0,77	4,0+5,0	-	08...	124512P	5620P	-	2445	
S 846LW 033 - 08	33	-	32	-	150	50	8°	2	-	0,78	4,0+5,0	-	08...	124512P	5620P	-	2445	
S 846LW 040 - 08	40	-	32	-	150	50	6°	3	-	0,84	4,0+5,0	-	08...	124512P	5620P	-	2445	
S 846GLW 040 - 08	40	-	32	-	150	50	6°	2	-	0,85	4,0+5,0	-	08...	124512P	5620P	-	2445	
S 846XLW 032 - 08	32	-	32	-	250	50	10°	2	-	1,38	4,0+5,0	-	08...	124512P	5620P	-	2445	
S 846XLW 033 - 08	33	-	32	-	250	50	8°	2	-	1,40	4,0+5,0	-	08...	124512P	5620P	-	2445	
S 846XLW 040 - 08	40	-	32	-	250	50	6°	3	-	1,45	4,0+5,0	-	08...	124512P	5620P	-	2445	
S 846GXLW 040 - 08	40	-	32	-	250	50	6°	2	-	1,46	4,0+5,0	-	08...	124512P	5620P	-	2445	
S 848W 040 - 06	40	-	16	38	40	-	2°	3	-	0,21	3,8+5,0	A	06...	C04008P	5615P	VBSF08L	2440	
S 848W 050 - 08	50	-	22	48	50	-	4°	3	-	0,39	4,0+5,0	A	08...	124513P	5520P	VBSF10AV	2445	
S 848W 052 - 08	52	-	22	50	50	-	4°	3	-	0,45	4,0+5,0	A	08...	124513P	5520P	VBSF10	2445	
S 848W 063 - 08	63	-	22	59	50	-	2,5°	4	-	0,65	4,0+5,0	A	08...	124513P	5520P	VBSF12	2445	
S 848W 066 - 08	66	-	27	63	50	-	2,5°	4	-	0,70	4,0+5,0	A	08...	124513P	5520P	VBSF12L	2445	
S 848W 080 - 08	80	-	27	76	63	-	1,5°	5	-	1,47	4,0+5,0	A	08...	124513P	5520P	VBSF16L	2445	
S 848W 100 - 08	100	-	32	96	63	-	1°	6	-	2,45	4,0+5,0	A	08...	124513P	5520P	VBSF16L	2445	
S 848WF 050 - 08	50	-	22	48	50	-	4°	4	-	0,38	4,0+5,0	A	08...	124513P	5520P	VBSF10AV	2445	
S 848WF 052 - 08	52	-	22	50	50	-	4°	4	-	0,43	4,0+5,0	A	08...	124513P	5520P	VBSF10	2445	
S 848WF 063 - 08	63	-	22	59	50	-	2,5°	5	-	0,67	4,0+5,0	A	08...	124513P	5520P	VBSF12	2445	
S 848WF 066 - 08	66	-	27	63	50	-	2,5°	5	-	0,73	4,0+5,0	A	08...	124513P	5520P	VBSF12L	2445	
S 848WF 080 - 08	80	-	27	76	63	-	1,5°	6	-	1,51	4,0+5,0	A	08...	124513P	5520P	VBSF16L	2445	
S 848WF 100 - 08	100	-	32	96	63	-	1°	8	-	2,49	4,0+5,0	A	08...	124513P	5520P	VBSF16L	2445	
S 849W 025 - 06	25	12	12,5	21	-	35	5°	2	-	17	0,09	3,8+5,0	-	06...	C04008P	5615P	-	2440
S 849W 026 - 06	26	12	12,5	21	-	35	4,5°	2	-	17	0,09	3,8+5,0	-	06...	C04008P	5615P	-	2440
S 849W 032 - 06	32	16	17	29	-	43	3,5°	3	-	24	0,20	3,8+5,0	-	06...	C04008P	5615P	-	2440
S 849W 033 - 06	33	16	17	29	-	43	3°	3	-	24	0,20	3,8+5,0	-	06...	C04008P	5615P	-	2440
S 849W 032 - 08	32	16	17	29	-	43	10°	2	-	24	0,17	4,0+5,0	-	08...	124512P	5620P	-	2445
S 849W 033 - 08	33	16	17	29	-	43	8°	2	-	24	0,18	4,0+5,0	-	08...	124512P	5620P	-	2445
S 849W 040 - 08	40	16	17	29	-	43	6°	3	-	24	0,22	4,0+5,0	-	08...	124512P	5620P	-	2445
S 849GW 040 - 08	40	16	17	29	-	43	6°	2	-	24	0,24	4,0+5,0	-	08...	124512P	5620P	-	2445

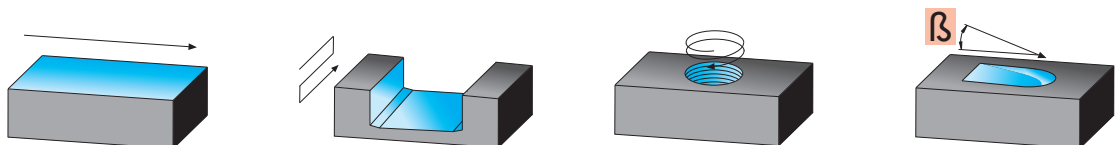

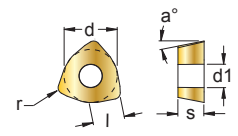
SCELTA VELOCE - QUICK PICK															HT		HW	HC														
Tenacità + ↑ Toughness - ↓															CERMET		NON RIV. CEMENTED CARBIDE GRADES	RIVESTITI COATED GRADES BESCHICHTET RECOUVERTS														
COD.		P			M			K			N			S			H			T5530		F4140		T5120			l	d	s	d1	r	a°
F	M	R	F	M	R	F	M	R	F	M	R	F	M	R	F	M	R	F	M	R	F	M	R									
WPMT	06X415 ZSR	.N42	●	○	○	●	○	○	○	○	○	○	○	○	○	○	○	○	○	○	○	○	○		6	9,52	4,20	4,3	1,5	11°		
WPMT	080615 ZSR	.N42	●	○	○	●	○	○	○	○	○	○	○	○	○	○	○	○	○	○	○	○	○		8	12,7	6,35	5,4	1,5	11°		
WPMW	06X415 ZSR	.N52	●	○	○	●	○	○	○	○	○	○	○	○	○	○	○	○	○	○	○	○	○		6	9,52	4,20	4,3	1,5	11°		
WPMW	080615 ZSR	.N52	●	○	○	●	○	○	○	○	○	○	○	○	○	○	○	○	○	○	○	○	○		8	12,7	6,35	5,4	1,5	11°		

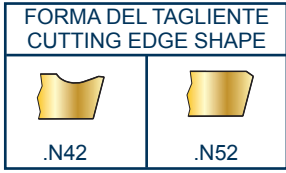

CON ADDUZIONE LUBROREFRIGERANTE - WITH COOLANT SUPPLY

SENZA ADDUZIONE LUBROREFRIGERANTE - WITHOUT COOLANT SUPPLY

MATERIALI - MATERIALS Pag. 1199		VDI 3323 GR.	HB Rm ¹ HRC ²	fz0 mm		fz mm	Vc m/min Pag. 552							
				WP..06	WP..08		T5120	T5530	F4140					
P	ACCIAIO NON LEGATO - NOT ALLOY STEEL	1--5	125-300	0,5-1,5	0,5-2	0,2	250	210	290					
	ACCIAIO POCO LEGATO - LOW ALLOY STEEL	6-9	180-350	0,5-1,5	0,5-2	0,2	250	180	240					
	ACCIAIO ALTO LEGATO - ALLOY STEEL	10-11	200-325	0,4-0,8	0,5-1	0,15	230	180	205					
	INOX MARTENS. - STAINLESS STEEL MART	12-13	200-240	0,5-1,5	0,5-2	0,2	180	150	170					
M	INOX AUST. DUPLEX - STAINLESS STEEL AUST	14.1-14.2	180-230	0,5-1,3	0,5-1,8	0,2			150					
K	GHISA GRIGIA - GREY CAST IRON	15-16	180-260	0,8-2	1-2,5	0,2	250	190	180					
	GHISA SFEROIDALE - SPHEROIDAL GRAPHITE	17-18	160-250	0,8-2	1-2,5	0,2	220	170	150					
	GHISA MALLEABILE - MALLEABLE CAST IRON	19-20	130-230	0,8-2	1-2,5	0,2	200	160	110					
N	ALLUMINIO E SUE LEGHE - ALUMINIUM	21--25	60-130											
	RAME E SUE LEGHE - COPPER	26--28	90-110											
	NON METALLICI - PLASTICS	29-30	/											
S	LEGHE RESIST. CALORE - HIG. TEMP. ALLOY	31--35	200-320											
	TITANIO E SUE LEGHE - TITANIUM	36-37	400-1050 ⁹											
H	ACCIAIO TEMPRATO - HARDENED STEEL	38-41	45-60 ^a	0,3-0,6	0,4-0,8	0,1			140					

$$n = \frac{Vc \cdot 1000}{\varnothing D \cdot 3,14} = \text{giri/min (min}^{-1}\text{)}$$

$$fz = fz0 \cdot Kae = \text{mm}$$

$$fn = fz \cdot z = \text{mm}$$

$$Vf = fz \cdot z \cdot n = \text{mm/min}$$

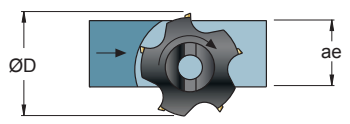

ae/D	0,5-1 50-100%	0,2 20%	0,1 10%	0,05 5%
Vc (min)-----Vc(max)				
Vc Pag. 552				

ae/D	0,5-1 50-100%	0,2 20%	0,1 10%	0,05 5%	0,02 2%
Kae	1	1,1	1,2	1,3	1,5

- F = FINITURA, LAV. LEGGERA - FINISHING, LIGHT MACHINING
- M = LAV. MEDIA, GENERICA - MEDIUM MACHINING, GENERIC
- R = SGROSSATURA, LAV. PESANTE - ROUGHING, HEAVY MACHINING

- Vc = m/min VELOCITÀ DI TAGLIO - CUTTING SPEED
- n = giri/min (min⁻¹) NUMERO DI GIRI - NUMBER OF REVOLUTIONS
- fz = mm AVANZAMENTO AL DENTE - TOOTH FEED
- fn = mm AVANZAMENTO AL GIRO - FEED / REVOLUTION
- Vf = mm/min VELOCITÀ DI AVANZAMENTO - FEED SPEED
- Kae = FATTORE DI CORREZIONE - CORRECTION FACTOR

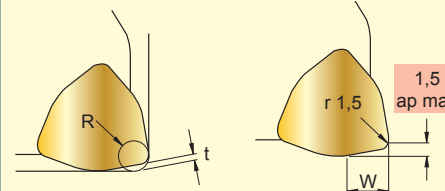

Inserto Insert	W (mm)	t (mm)	R (mm)
WPM..06	4,3	0,7	2,5
WPM..08	5,7	0,7	2,0

t = Materiale residuo / t = Residual Material
ap = Profondità massima di passata / ap = Maximum cutting depth

S 1502.8W .. 14

Ø 50-80

γ_p +15°
 γ_f -12°/-9°
 γ_o +12°

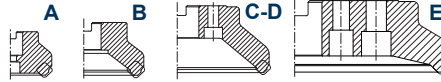

WNMT
1405..
.X52

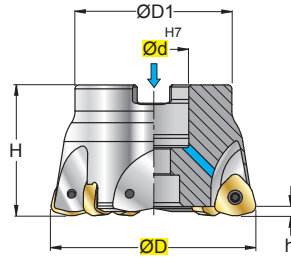

INSERTI - INSERTS
PAG. 537

ART.	(mm)							kg	Nm	ISO 6462	1405	C04011P	5615P	VBSF10
	ØD	Ød	ØD1	H	h	β	Z							
S 1502.8W-050-03-14	50	22	40	40	2	4,3°	3	0,24	3,8+5,0	A	1405	C04011P	5615P	VBSF10
S 1502.8W-050-04-14	50	22	40	40	2	4,3°	4	0,21	3,8+5,0	A	1405	C04011P	5615P	VBSF10
S 1502.8W-052-03-14	52	22	40	40	2	4°	3	0,27	3,8+5,0	A	1405	C04011P	5615P	VBSF10
S 1502.8W-052-04-14	52	22	40	40	2	4°	4	0,24	3,8+5,0	A	1405	C04011P	5615P	VBSF10
S 1502.8W-063-04-14	63	22	49	40	2	2,7°	4	0,44	3,8+5,0	A	1405	C04011P	5615P	VBSF10
S 1502.8W-063-05-14	63	22	49	40	2	2,7°	5	0,42	3,8+5,0	A	1405	C04011P	5615P	VBSF10
S 1502.8W-066-04-14	66	22	49	40	2	2,5°	4	0,48	3,8+5,0	A	1405	C04011P	5615P	VBSF10
S 1502.8W-066-05-14	66	22	49	40	2	2,5°	5	0,46	3,8+5,0	A	1405	C04011P	5615P	VBSF10
S 1502.8W-080-05-14	80	27	60	50	2	1,9°	5	1,02	3,8+5,0	A	1405	C04011P	5615P	VBSF12
S 1502.8W-080-06-14	80	27	60	50	2	1,9°	6	0,99	3,8+5,0	A	1405	C04011P	5615P	VBSF12

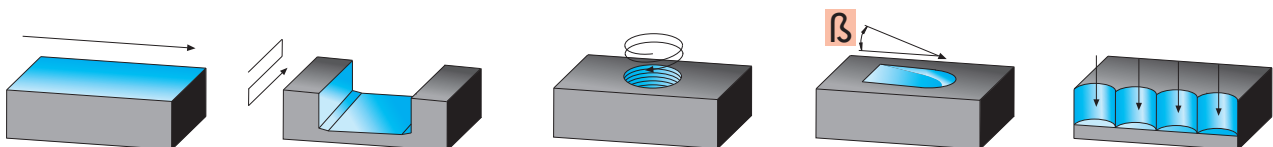

W = FORO PER LIQUIDO REFRIGERANTE - COOLANT BORE - KÜHLMITTELBOHRUNG - TROU DU LIQUIDE D'ARROSAGE
↻ = PASSO DIFFERENZIATO - DIFFERENTIAL PITCH - UNGLEICHE TEILUNG - PAS DIFFERENCE

SCELTA VELOCE - QUICK PICK										Tenacità + ↑ Toughness - ↓		Pag. 538		HT		HW		HC											
COD.		P		M		K		N		S		H		CERMET	NON RIV. CEMENTED CARBIDE GRADES	RIVESTITI COATED GRADES BESCHICHTET RECOUVERTS		F4130	T5120	l	d	s	d1	r	a°				
F	M	R	F	M	R	F	M	R	F	M	R	F	M			R	F									M	R		
WNMT	140525	.X52	●	●	●	●	●	●	○									■						7	13,7	5,5	4,9	2,5	-
CON ADDUZIONE LUBROREFRIGERANTE - WITH COOLANT SUPPLY										○		○																	
SENZA ADDUZIONE LUBROREFRIGERANTE - WITHOUT COOLANT SUPPLY										●		○																	

MATERIALI - MATERIALS Pag. 1199		VDI 3323 GR.	HB Rm ¹⁾ HRC ²⁾	fz0 mm	fz mm	Vc m/min Pag. 552					
						T5120	F4130				
P	ACCIAIO NON LEGATO - NOT ALLOY STEEL	1-5	125-300	0,3-1,5	0,06-0,1	250	240				
	ACCIAIO POCO LEGATO - LOW ALLOY STEEL	6-9	180-350	0,3-1,5	0,06-0,1	250	220				
	ACCIAIO ALTO LEGATO - ALLOY STEEL	10-11	200-325	0,3-1,0	0,06-0,1	230	200				
	INOX MARTENS. - STAINLESS STEEL MART	12-13	200-240	0,3-1,0	0,06-0,1	180	180				
M	INOX AUST. DUPLEX - STAINLESS STEEL AUST	14.1-14.2	180-230	0,3-0,7	0,06-0,1		170				
K	GHISA GRIGIA - GREY CAST IRON	15-16	180-260	0,4-1,5	0,06-0,1	250	190				
	GHISA SFEROIDALE - SPHEROIDAL GRAPHITE	17-18	160-250	0,4-1,5	0,06-0,1	220	170				
	GHISA MALLEABILE - MALLEABLE CAST IRON	19-20	130-230	0,4-1,5	0,06-0,1	200	130				
N	ALLUMINIO E SUE LEGHE - ALUMINIUM	21-25	60-130								
	RAME E SUE LEGHE - COPPER	26-28	90-110								
	NON METALLICI - PLASTICS	29-30	/								
S	LEGHE RESIST. CALORE - HIG. TEMP. ALLOY	31-35	200-320								
	TITANIO E SUE LEGHE - TITANIUM	36-37	400-1050 ¹⁾								
H	ACCIAIO TEMPRATO - HARDENED STEEL	38-41	45-60 ²⁾	0,2-0,7	0,06-0,1		50				

$$n = \frac{Vc \cdot 1000}{\phi D \cdot 3,14} = \text{giri/min (min}^{-1}\text{)}$$

$$fz = fz0 \cdot Kae = \text{mm}$$

$$fn = fz \cdot z = \text{mm}$$

$$Vf = fz \cdot z \cdot n = \text{mm/min}$$

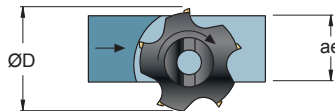

ae/D	0,5-1 50-100%	0,2 20%	0,1 10%	0,05 5%	0,02 2%
Kae	1	1,1	1,2	1,3	1,5

ae/D	0,5-1 50-100%	0,2 20%	0,1 10%	0,05 5%
Vc (min)-----Vc(max)				
Vc Pag. 552				

- F = FINITURA, LAV. LEGGERA - FINISHING, LIGHT MACHINING
- M = LAV. MEDIA, GENERICA - MEDIUM MACHINING, GENERIC
- R = SGROSSATURA, LAV. PESANTE - ROUGHING, HEAVY MACHINING

- Vc = m/min VELOCITÀ DI TAGLIO - CUTTING SPEED
- n = giri/min (min⁻¹) NUMERO DI GIRI - NUMBER OF REVOLUTIONS
- fz = mm AVANZAMENTO AL DENTE - TOOTH FEED
- fn = mm AVANZAMENTO AL GIRO - FEED / REVOLUTION
- Vf = mm/min VELOCITÀ DI AVANZAMENTO - FEED SPEED
- Kae = FATTORE DI CORREZIONE - CORRECTION FACTOR

	Inserto Insert	W (mm)	t (mm)	R (mm)
	WNMT 14	6,6	0,85	3,5

t = Materiale residuo / t = Residual Material
ap = Profondità massima di passata / ap = Maximum cutting depth

S 1503.6LW .. 06		S 1503.8W .. 06		S 1503.9W .. 06		LNMT 060312 .X52	
Ø 16-40	γ_p -6° γ_r -13°/-10° γ_o -10°/-9°	Ø 40-63	γ_p -6° γ_r -10°/-7,5° γ_o -9°/-8°	Ø 16-35	γ_p -6° γ_r -13°/-10° γ_o -10°/-9°	LNMT 060312 .X56	
		ISO 6462 ... 				LNMT 060312 .X58	
						INSERTI - INSERTS PAG. 529	

(mm)																		
ART.	ØD	M	Ød	ØD1	H	L	h	β	Z	↻	CH	kg	Nm	ISO 6462				
S 1503.6LW-016-02-06	16	-	16	-	100	30	1	3,5°	2	-	-	0,13	1,1+1,3	-	0603	122564P	5608P	-
S 1503.6LW-018-02-06	18	-	16	-	100	30	1	2,7°	2	-	-	0,14	1,1+1,3	-	0603	122564P	5608P	-
S 1503.6LW-020-03-06	20	-	20	-	130	50	1	2,3°	3	-	-	0,26	1,1+1,3	-	0603	122564P	5608P	-
S 1503.6LW-020-04-06	20	-	20	-	130	50	1	2,3°	4	-	-	0,26	1,1+1,3	-	0603	122564P	5608P	-
S 1503.6LW-022-03-06	22	-	20	-	130	50	1	1,9°	3	-	-	0,27	1,1+1,3	-	0603	122564P	5608P	-
S 1503.6LW-022-04-06	22	-	20	-	130	50	1	1,9°	4	-	-	0,28	1,1+1,3	-	0603	122564P	5608P	-
S 1503.6LW-025-04-06	25	-	25	-	140	60	1	1,6°	4	-	-	0,46	1,1+1,3	-	0603	122564P	5608P	-
S 1503.6LW-025-05-06	25	-	25	-	140	60	1	1,6°	5	-	-	0,45	1,1+1,3	-	0603	122564P	5608P	-
S 1503.6LW-028-04-06	28	-	25	-	140	60	1	1,3°	4	-	-	0,48	1,1+1,3	-	0603	122564P	5608P	-
S 1503.6LW-028-05-06	28	-	25	-	140	60	1	1,3°	5	-	-	0,48	1,1+1,3	-	0603	122564P	5608P	-
S 1503.6LW-030-04-06	30	-	32	-	150	70	1	1,2°	4	-	-	0,80	1,1+1,3	-	0603	122564P	5608P	-
S 1503.6LW-030-05-06	30	-	32	-	150	70	1	1,2°	5	-	-	0,80	1,1+1,3	-	0603	122564P	5608P	-
S 1503.6LW-032-05-06	32	-	32	-	150	70	1	1,1°	5	-	-	0,81	1,1+1,3	-	0603	122564P	5608P	-
S 1503.6LW-032-06-06	32	-	32	-	150	70	1	1,1°	6	-	-	0,81	1,1+1,3	-	0603	122564P	5608P	-
S 1503.6LW-035-05-06	35	-	32	-	150	35	1	1,0°	5	-	-	0,88	1,1+1,3	-	0603	122564P	5608P	-
S 1503.6LW-035-06-06	35	-	32	-	150	35	1	1,0°	6	-	-	0,88	1,1+1,3	-	0603	122564P	5608P	-
S 1503.6LW-040-06-06	40	-	32	-	160	45	1	0,8°	6	-	-	0,96	1,1+1,3	-	0603	122564P	5608P	-
S 1503.6LW-040-08-06	40	-	32	-	160	45	1	0,8°	8	-	-	0,96	1,1+1,3	-	0603	122564P	5608P	-
S 1503.8W-040-06-06	40	-	16	35	50	-	1	0,8°	6	-	-	0,21	1,1+1,3	A	0603	122564P	5608P	VBSF08L
S 1503.8W-040-08-06	40	-	16	35	50	-	1	0,8°	8	-	-	0,20	1,1+1,3	A	0603	122564P	5608P	VBSF08L
S 1503.8W-050-07-06	50	-	22	48	50	-	1	0,6°	7	-	-	0,46	1,1+1,3	A	0603	122564P	5608P	VBSF10L
S 1503.8W-050-09-06	50	-	22	48	50	-	1	0,6°	9	-	-	0,45	1,1+1,3	A	0603	122564P	5608P	VBSF10L
S 1503.8W-052-07-06	52	-	22	48	50	-	1	0,6°	7	-	-	0,50	1,1+1,3	A	0603	122564P	5608P	VBSF10L
S 1503.8W-052-09-06	52	-	22	48	50	-	1	0,6°	9	-	-	0,50	1,1+1,3	A	0603	122564P	5608P	VBSF10L
S 1503.8W-063-09-06	63	-	22	48	50	-	1	0,5°	9	-	-	0,67	1,1+1,3	A	0603	122564P	5608P	VBSF10L
S 1503.8W-063-11-06	63	-	22	48	50	-	1	0,5°	11	-	-	0,66	1,1+1,3	A	0603	122564P	5608P	VBSF10L
S 1503.9W-016-02-06	16	8	8,5	13	42	25	1	3,5°	2	-	10	0,03	1,1+1,3	-	0603	122564P	5608P	-
S 1503.9W-018-02-06	18	8	8,5	13	42	25	1	2,7°	2	-	10	0,03	1,1+1,3	-	0603	122564P	5608P	-
S 1503.9W-020-03-06	20	10	10,5	17,8	49	30	1	2,3°	3	-	15	0,06	1,1+1,3	-	0603	122564P	5608P	-
S 1503.9W-020-04-06	20	10	10,5	17,8	49	30	1	2,3°	4	-	15	0,05	1,1+1,3	-	0603	122564P	5608P	-
S 1503.9W-022-03-06	22	10	10,5	18	49	30	1	1,9°	3	-	15	0,06	1,1+1,3	-	0603	122564P	5608P	-
S 1503.9W-022-04-06	22	10	10,5	18	49	30	1	1,9°	4	-	15	0,06	1,1+1,3	-	0603	122564P	5608P	-
S 1503.9W-025-04-06	25	12	12,5	21	57	35	1	1,6°	4	-	17	0,10	1,1+1,3	-	0603	122564P	5608P	-
S 1503.9W-025-05-06	25	12	12,5	21	57	35	1	1,6°	5	-	17	0,09	1,1+1,3	-	0603	122564P	5608P	-
S 1503.9W-028-04-06	28	12	12,5	21	57	35	1	1,3°	4	-	17	0,11	1,1+1,3	-	0603	122564P	5608P	-
S 1503.9W-028-05-06	28	12	12,5	21	57	35	1	1,3°	5	-	17	0,10	1,1+1,3	-	0603	122564P	5608P	-
S 1503.9W-030-04-06	30	16	17	27	64	40	1	1,2°	4	-	24	0,20	1,1+1,3	-	0603	122564P	5608P	-
S 1503.9W-030-05-06	30	16	17	27	64	40	1	1,2°	5	-	24	0,19	1,1+1,3	-	0603	122564P	5608P	-
S 1503.9W-032-05-06	32	16	17	29	64	40	1	1,1°	5	-	24	0,21	1,1+1,3	-	0603	122564P	5608P	-
S 1503.9W-032-06-06	32	16	17	29	64	40	1	1,1°	6	-	24	0,21	1,1+1,3	-	0603	122564P	5608P	-
S 1503.9W-035-05-06	35	16	17	29	64	40	1	1,0°	5	-	24	0,23	1,1+1,3	-	0603	122564P	5608P	-
S 1503.9W-035-06-06	35	16	17	29	64	40	1	1,0°	6	-	24	0,23	1,1+1,3	-	0603	122564P	5608P	-

W = FORO PER LIQUIDO REFRIGERANTE - COOLANT BORE - KÜHLMITTELBOHRUNG - TROU DU LIQUIDE D'ARROSAGE
L = LUNGA, STELO CILINDRICO - LONG, CYLINDRICAL SHANK - LANG, ZYLINDERSCHAFT - LONGUE, QUEUE CYLINDRIQUE
↻ = PASSO DIFFERENZIATO - DIFFERENTIAL PITCH - UNGLEICHE TEILUNG - PAS DIFFERENCIE

SCELTA VELOCE - QUICK PICK										Tenacità + ↑ Toughness - ↓		Pag. 538		HT	HW	HC															
COD.		P			M			K			N			S			H			CERMET	NON RIV. CEMENTED CARBIDE GRADES	RIVESTITI COATED GRADES BESCHICHTET RECOUVERTS			L	H	s	d1	r	a°	
F	M	R	F	M	R	F	M	R	F	M	R	F	M	R	F	M	R	F	M			R	F4128	F4130							F7530
LNMT	060312	.X52	●	●		●	●								●											6,2	10	3,65	3	1,2	-
LNMT	060312	.X56	●	●		●	●								●											6,2	10	3,65	3	1,2	-
LNMT	060312	.X58	●	●		●	●								●											6,2	10	3,65	3	1,2	-
CON ADDUZIONE LUBROREFRIGERANTE - WITH COOLANT SUPPLY																															
SENZA ADDUZIONE LUBROREFRIGERANTE - WITHOUT COOLANT SUPPLY																															

MATERIALI - MATERIALS Pag. 1199		VDI 3323 GR.	HB Rm1) HRC2)	fz0 mm	fz mm	Vc m/min			Pag. 552					
P	M	K	N	S	H	F4128	F4130	F7530						
ACCIAIO NON LEGATO - NOT ALLOY STEEL	1-5	125-300	0,5-2	0,1-0,15			240	220						
ACCIAIO POCO LEGATO - LOW ALLOY STEEL	6-9	180-350	0,5-2	0,1-0,15			220	180						
ACCIAIO ALTO LEGATO - ALLOY STEEL	10-11	200-325	0,3-1,5	0,1-0,15			240	200						
INOX MARTENS. - STAINLESS STEEL MART	12-13	200-240	0,3-1,5	0,1-0,15			220	180						
INOX AUST. DUPLEX - STAINLESS STEEL AUST	14.1-14.2	180-230	0,3-1,5	0,1-0,15			170	180						
GHISA GRIGIA - GREY CAST IRON	15-16	180-260	0,5-1,8	0,1-0,2			240	190						
GHISA SFEROIDALE - SPHEROIDAL GRAPHITE	17-18	160-250	0,5-1,8	0,1-0,2			160	170						
GHISA MALLEABILE - MALLEABLE CAST IRON	19-20	130-230	0,5-1,8	0,1-0,2			120	130						
ALLUMINIO E SUE LEGHE - ALUMINIUM	21-25	60-130												
RAME E SUE LEGHE - COPPER	26-28	90-110												
NON METALLICI - PLASTICS	29-30	/												
LEGHE RESIST. CALORE - HIG. TEMP. ALLOY	31-35	200-320	0,4-1,2	0,08-0,12				25						
TITANIO E SUE LEGHE - TITANIUM	36-37	400-1050 ¹⁾	0,4-1,2	0,08-1,2				40						
ACCIAIO TEMPRATO - HARDENED STEEL	38-41	45-60 ²⁾	0,1-0,3	0,08-0,1			120	75						

⚠ - SE LA SPORGENZA DELLA FRESA È >3xD RIDURRE I PARAMETRI DI LAVORO: Vc, fz, ap DEL 30%
- IF THE PROTRUSION OF THE CUTTER IS >3xD, REDUCE CUTTING PARAMETERS: Vc, fz, ap BY 30%

$$n = \frac{Vc \cdot 1000}{\phi D \cdot 3,14} = \text{giri/min (min}^{-1}\text{)}$$

$$fz = fz0 \cdot Kae = \text{mm}$$

$$fn = fz \cdot z = \text{mm}$$

$$Vf = fz \cdot z \cdot n = \text{mm/min}$$

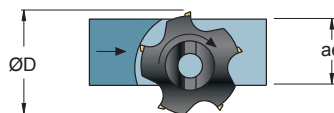

ae/D	0,5-1 50-100%	0,2 20%	0,1 10%	0,05 5%	0,02 2%
Kae	1	1,1	1,2	1,3	1,5

ae/D	0,5-1 50-100%	0,2 20%	0,1 10%	0,05 5%
Vc (min)-----Vc(max)				
Vc Pag. 552				

F = FINITURA, LAV. LEGGERA - FINISHING, LIGHT MACHINING
M = LAV. MEDIA, GENERICA - MEDIUM MACHINING, GENERIC
R = SGROSSATURA, LAV. PESANTE - ROUGHING, HEAVY MACHINING

Vc = m/min VELOCITÀ DI TAGLIO - CUTTING SPEED
n = giri/min (min⁻¹) NUMERO DI GIRI - NUMBER OF REVOLUTIONS
fz = mm AVANZAMENTO AL DENTE - TOOTH FEED
fn = mm AVANZAMENTO AL GIRO - FEED / REVOLUTION
Vf = mm/min VELOCITÀ DI AVANZAMENTO - FEED SPEED
Kae = FATTORE DI CORREZIONE - CORRECTION FACTOR

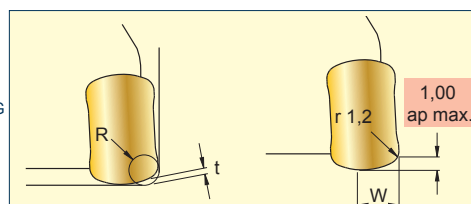

t = Materiale residuo / Residual Material
ap = Profondità massima di passata / Maximum cutting depth

Inserto Insert	W (mm)	t (mm)	R (mm)
LNMT 06	3,2	0,3	1,65

S 806W ..

Ø 12,5-20

FORM A

FORM B

γ_p 0°
 γ_f 0°

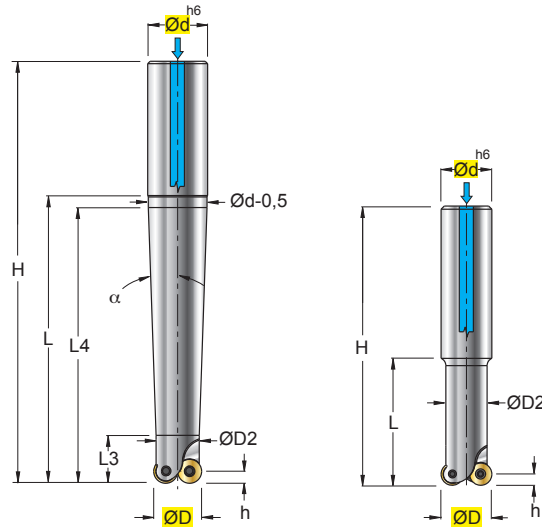

RDHX.. .T42	
RDET.. .T56	
RDEW.. .T56	
RDHT.. .T57P	

INSERTI - INSERTS
PAG. 531

(mm)																		
ART.	FORM	ØD	Ød	ØD2	H	h	L	L3	L4	α	β	Z		kg				Nm
S 806W 12,5 40 02.71	A	12,5	16	10	88	3,5	40	20	35	10,4°	22,7°	2	-	0,102	1,0+1,2	07T1	12254P	5607P
S 806W 12,5 60 02.71	A	12,5	16	10	108	3,5	60	20	55	4,3°	22,7°	2	-	0,120	1,0+1,2			
S 806W 12,5 80 02.71	A	12,5	16	10	128	3,5	80	20	75	2,9°	22,7°	2	-	0,139	1,0+1,2			
S 806W 15 40 02.72	B	15	16	13	88	3,5	40	-	-	-	20°	2	-	0,106	1,0+1,2	0702	12254P	5607P
S 806W 15 60 02.72	A	15	16	13	108	3,5	60	20	55	2,0°	20°	2	-	0,135	1,0+1,2			
S 806W 15 80 02.72	A	15	20	13	130	3,5	80	20	75	3,4°	20°	2	-	0,232	1,0+1,2			
S 806W 15 100 02.72	A	15	20	13	150	3,5	100	20	95	2,5°	20°	2	-	0,263	1,0+1,2			
S 806W 15 120 02.72	A	15	25	13	176	3,5	120	20	115	3,5°	20°	2	-	0,447	1,0+1,2			
S 806W 16 40 02.72	B	16	16	13	88	3,5	40	-	-	-	16,8°	2	-	0,107	1,0+1,2			
S 806W 16 60 02.72	A	16	16	13	108	3,5	60	20	55	2,0°	16,8°	2	-	0,135	1,0+1,2	1003	123507P	5615P
S 806W 16 80 02.72	A	16	20	13	130	3,5	80	20	75	3,4°	16,8°	2	-	0,232	1,0+1,2			
S 806W 16 100 02.72	A	16	20	13	150	3,5	100	20	95	2,5°	16,8°	2	-	0,263	1,0+1,2			
S 806W 16 120 02.72	A	16	25	13	176	3,5	120	20	115	3,5°	16,8°	2	-	0,449	1,0+1,2			
S 806W 20 40 02.10	A	20	20	18	90	5	40	20	35	2,9°	39°	2	-	0,181	3,0+3,5			
S 806W 20 60 02.10	A	20	20	18	110	5	60	20	55	1,3°	39°	2	-	0,222	3,0+3,5			
S 806W 20 80 02.10	A	20	25	18	136	5	80	20	75	3,4°	39°	2	-	0,396	3,0+3,5			
S 806W 20 100 02.10	A	20	25	18	156	5	100	20	95	2,5°	39°	2	-	0,450	3,0+3,5			
S 806W 20 120 02.10	A	20	25	18	176	5	120	20	115	2,0°	39°	2	-	0,503	3,0+3,5			

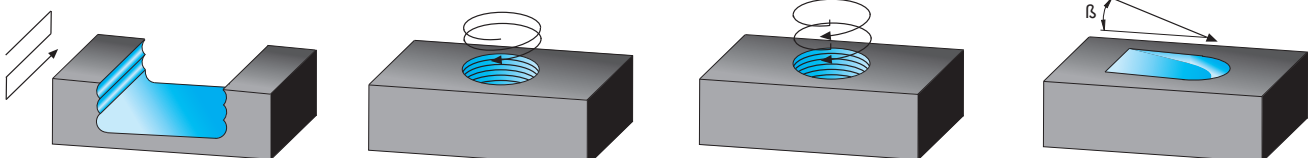

W = FORO PER LIQUIDO REFRIGERANTE - COOLANT BORE - KÜHLMITTELBOHRUNG - TROU DU LIQUIDE D'ARROSAGE
 = PASSO DIFFERENZIATO - DIFFERENTIAL PITCH - UNGLEICHE TEILUNG - PAS DIFFERENCE

SCELTA VELOCE - QUICK PICK



COD.	MATERIALI												HT	HW	HC				l	d	s	d1	r	a°												
	P			M			K			N					S			H							N3620		F5105		F2331		F2335					
	F	M	HSC	F	M	HSC	F	M	HSC	F	M	HSC	F	M	HSC	F	M	HSC	F	M	HSC	F	M	HSC	F	M	HSC	F	M	HSC						
RDHX 07T1 MOT .T42	●	●					●	●																												
RDHX 0702 MOT .T42	●	●					●	●																												
RDHX 1003 MOT .T42	●	●					●	●																												
RDET 1003 MOSN .T56	●	●		●	●								○	○																						
RDEW 1003 MOSN .T56	●	●		●	●																															
RDHT 07T1 MO .T57P										●	●																									
RDHT 0702 MO .T57P										●	●																									
RDHT 1003 MO .T57P										●	●																									

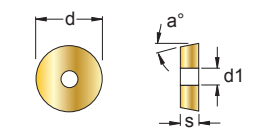

CON ADDUZIONE LUBROREFRIGERANTE - WITH COOLANT SUPPLY		SENZA ADDUZIONE LUBROREFRIGERANTE - WITHOUT COOLANT SUPPLY	

MATERIALI - MATERIALS Pag. 1199	VDI 3323 GR.	HB Rm ¹ HRC ²	Km	F5105 Vc (m/min)			N3620 Vc (m/min)			F2331 Vc (m/min)			F2335 Vc (m/min)		
				F	R	HSC	F	R	HSC	F	R	HSC	F	R	HSC
P ACCIAIO NON LEGATO - NOT ALLOY STEEL	1-5	125-300	1	260	220	310				280	240		260	220	
ACCIAIO POCO LEGATO - LOW ALLOY STEEL	6-9	180-350	0,9	280	270	300				300	260		280	250	
ACCIAIO ALTO LEGATO - ALLOY STEEL	10-11	200-325	0,8	230	210	250				240	220		220	200	
INOX MARTENS. - STAINLESS STEEL MART	12-13	200-240	1	200	150	180				180	150		180	160	
M INOX AUST. DUPLEX - STAINLESS STEEL AUST	14.1-14.2	180-230	1							160	120		150	120	
K GHISA GRIGIA - GREY CAST IRON	15-16	180-260	1	300	260	330							290	250	
GHISA SFEROIDALE - SPHEROIDAL GRAPHITE	17-18	160-250	1,1	240	230	280							240	220	
GHISA MALLEABILE - MALLEABLE CAST IRON	19-20	130-230	1,2	260	230	280							250	220	
N ALLUMINIO E SUE LEGHE - ALUMINIUM	21-25	60-130	1,3				430	400	450						
RAME E SUE LEGHE - COPPER	26-28	90-110	1,2				280	250	335						
NON METALLICI - PLASTICS	29-30	/	1,3				380	350	400						
S LEGHE RESIST. CALORE - HIG. TEMP. ALLOY	31-35	200-320	0,9										70	40	
TITANIO E SUE LEGHE - TITANIUM	36-37	400-1050 ¹⁾	0,8										70	40	
H ACCIAIO TEMPRATO - HARDENED STEEL	38-41	45-60 ²⁾	0,8	120	80	140									

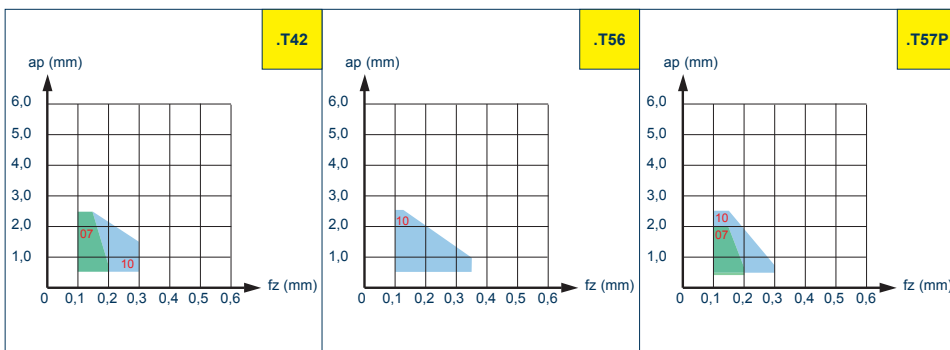

$$n = \frac{Vc \cdot 1000}{\varnothing D \cdot 3,14} = \text{giri/min (min}^{-1}\text{)}$$

$$fz = fz0 \cdot Kae \cdot Km = \text{mm}$$

$$fn = fz \cdot z = \text{mm}$$

$$Vf = fz \cdot z \cdot n = \text{mm/min}$$

ae/D	0,5-1	0,2	0,1	0,05	0,02
	50-100%	20%	10%	5%	2%
Kae	1	1,2	1,5	1,8	2

- F** = FINITURA, LAV. LEGGERA - FINISHING, LIGHT MACHINING
- R** = SGROSSATURA, LAV. PESANTE - ROUGHING, HEAVY MACHINING
- HSC** = LAVORAZIONE ALTA VELOCITÀ - HIGH SPEED CUTTING
- Km** = FATTORE DI AVANZAMENTO PER MATERIALE - FEED FACTOR FOR MATERIAL
- Vc** = m/min VELOCITÀ DI TAGLIO - CUTTING SPEED
- n** = giri/min (min⁻¹) NUMERO DI GIRI - NUMBER OF REV.
- fz** = mm AVANZAMENTO AL DENTE - TOOTH FEED
- fn** = mm AVANZAMENTO AL GIRO - FEED / REVOLUTION
- Vf** = mm/min VELOCITÀ DI AVANZAMENTO - FEED SPEED
- Kae** = FATTORE DI CORREZIONE - CORRECTION FACTOR

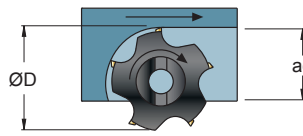

S 808W ..





Ø 40-160

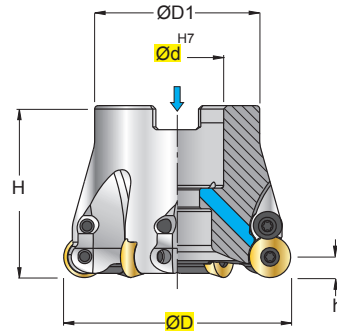
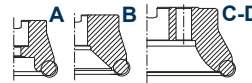



γ_p 0°
 γ_f 0°

ISO 6462 ...



RDGT.. .T42	
RDHX.. .T42	
RDET.. .T56	
RDEW.. .T56	
RDHT.. .T57P	
 INSERTI - INSERTS PAG. 531	

ART.	(mm)								kg	Nm	ISO 6462					
	ØD	Ød	ØD1	H	h	β	Z									
S 808W 40 40 05.10	40	16	32	40	5	7°	5	-	0,164	3,0±3,5	A	1003	123507P	-	5615P	VBSF08L
S 808W 42 40 05.10	42	16	32	40	5	6,7°	5	-	0,182	3,0±3,5	A	1003	123507P	-	5615P	VBSF10
S 808W 52 50 05.10	52	22	40	50	5	5,5°	5	-	0,385	3,0±3,5	A	1003	123507P	-	5615P	VBSF10
S 808W 52 50 07.10	52	22	40	50	5	5,5°	7	-	0,394	3,0±3,5	A	1003	123507P	-	5615P	VBSF10
S 808W 42 40 04.12	42	16	32	40	6	7,5°	4	-	0,156	3,0±3,5	A	12T3	123509P	2435P	5615P	VBSF08L
S 808W 48 50 04.12	48	22	40	50	6	6,5°	4	-	0,319	3,0±3,5	A	12T3	123509P	2435P	5615P	VBSF10
S 808W 50 50 05.12	50	22	40	50	6	6,1°	5	-	0,308	3,0±3,5	A	12T3	123509P	2435P	5615P	VBSF10
S 808W 52 50 05.12	52	22	40	50	6	5,7°	5	-	0,337	3,0±3,5	A	12T3	123509P	2435P	5615P	VBSF12
S 808W 63 50 06.12	63	27	48	50	6	4,3°	6	-	0,477	3,0±3,5	A	12T3	123509P	2435P	5615P	VBSF12
S 808W 66 50 06.12	66	27	48	50	6	4,1°	6	-	0,524	3,0±3,5	A	12T3	123509P	2435P	5615P	VBSF12
S 808W 80 52 07.12	80	27	60	52	6	3,2°	7	-	0,889	3,0±3,5	A-B	12T3	123509P	2435P	5615P	VBSF12
S 808W 50 50 04.16	50	22	40	50	8	9,5°	4	-	0,273	4,0±5,0	A	1604	124510P	2445	5620P	VBSF10
S 808W 52 50 04.16	52	22	40	50	8	8,8°	4	-	0,299	4,0±5,0	A	1604	124510P	2445	5620P	VBSF10
S 808W 63 50 05.16	63	27	48	50	8	7,1°	5	-	0,443	4,0±5,0	A	1604	124510P	2445	5620P	VBSF12
S 808W 66 50 05.16	66	27	48	50	8	6,0°	5	-	0,493	4,0±5,0	A	1604	124510P	2445	5620P	VBSF12
S 808W 66 50 06.16	66	27	48	50	8	6,0°	6	-	0,450	4,0±5,0	A	1604	124510P	2445	5620P	VBSF12
S 808W 80 52 06.16	80	27	60	52	8	4,5°	6	-	0,833	4,0±5,0	A-B	1604	124510P	2445	5620P	VBSF12
S 808W 80 52 07.16	80	27	60	52	8	4,5°	7	-	0,797	4,0±5,0	A-B	1604	124510P	2445	5620P	VBSF12
S 808W 100 52 07.16	100	32	75	52	8	3,7°	7	-	1,276	4,0±5,0	A-B	1604	124510P	2445	5620P	VBSF16
S 808W 125 63 08.16	125	40	90	63	8	2,8°	8	-	2,664	4,0±5,0	A-B	1604	124510P	2445	5620P	VBSF20
S 808 160 63 09.16	160	40	120	63	8	1,8°	9	-	4,183	4,0±5,0	C	1604	124510P	2445	5620P	-

-  * CON INSERTI RDET.. .T56 / RDEX.. .T56 / RDHT.. .T57P NON È POSSIBILE UTILIZZARE LA STAFFA 24..
-  * WITH RDET.. .T56 / RDEX.. .T56 / RDHT.. .T57P INSERTS THE CLAMPING SCREW 24.. CANNOT BE USED.
-  * MIT RDET.. .T56 / RDEX.. .T56 / RDHT.. .T57P-WENDEPLATTEN IST DIE AUFSPANNSCHRAUBE 24.. NICHT EINSETZBAR.
-  * AVEC LES PLAQUETTES RDET.. .T56 / RDEX.. .T56 / RDHT.. .T57P ON NE PEUT PAS UTILISER LA VIS DE BRIDAGE 24..

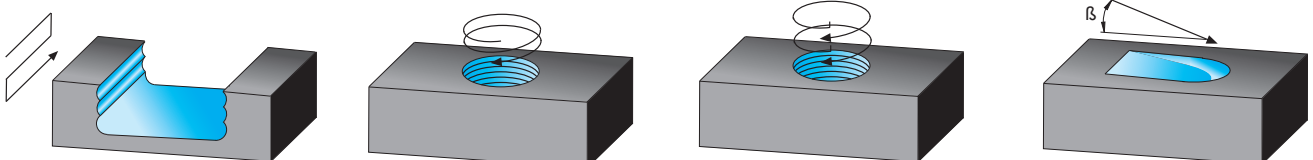

W = FORO PER LIQUIDO REFRIGERANTE - COOLANT BORE - KÜHLMITTELBOHRUNG - TROU DU LIQUIDE D'ARROSAGE
 = PASSO DIFFERENZIATO - DIFFERENTIAL PITCH - UNGLEICHE TEILUNG - PAS DIFFERENCIE

SCelta VELOCE - QUICK PICK



COD.	P			M			K			N			S			H			HT	HW	HC						l	d	s	d1	r	a°
	F	M	HSC	F	M	HSC	F	M	HSC	F	M	HSC	F	M	HSC	F	M	HSC			CERMET	NON RIV. CEMENTED CARBIDE GRADES	RIVESTITI COATED GRADES BESCHICHTET RECOUVERTS									
RDGT 1604 MOT .T42	●	●																														
RDHX 1003 MOT .T42	●	●																														
RDHX 12T3 MOT .T42	●	●																														
RDHX 1604 MOT .T42	●	●																														
RDET 1003 MOSN .T56	●	●		●	●		●	●																								
RDET 12T3 MOSN .T56	●	●		●	●		●	●																								
RDEW 1003 MOSN .T56	●	●		●	●		●	●																								
RDEW 12T3 MOSN .T56	●	●		●	●		●	●																								
RDEW 1604 MOSN .T56	●	●		●	●		●	●																								
RDHT 07T1 MO .T57P										●	●																					
RDHT 12T3 MO .T57P										●	●																					
RDHT 1604 MO .T57P										●	●																					

CON ADDUZIONE LUBROREFRIGERANTE - WITH COOLANT SUPPLY
SENZA ADDUZIONE LUBROREFRIGERANTE - WITHOUT COOLANT SUPPLY

MATERIALI - MATERIALS Pag. 1199	VDI 3323 GR.	HB Rm1 HRC2	Km	F5105 Vc (m/min)			N3620 Vc (m/min)			F2331 Vc (m/min)			F2335 Vc (m/min)			F4144 Vc (m/min)		
				F	R	HSC	F	R	HSC	F	R	HSC	F	R	HSC	F	R	HSC
P ACCIAIO NON LEGATO - NOT ALLOY STEEL	1-5	125-300	1	260	220	310				280	240		260	220		275	240	
ACCIAIO POCO LEGATO - LOW ALLOY STEEL	6-9	180-350	0,9	280	270	300				300	260		280	250		250	210	
ACCIAIO ALTO LEGATO - ALLOY STEEL	10-11	200-325	0,8	230	210	250				240	220		220	200		250	210	
INOX MARTENS. - STAINLESS STEEL MART	12-13	200-240	1	200	150	180				180	150		180	160		200	180	
M INOX AUST. DUPLEX - STAINLESS STEEL AUST	14.1-14.2	180-230	1							160	120		150	120		160	120	
K GHISA GRIGIA - GREY CAST IRON	15-16	180-260	1	300	260	330							290	250				
GHISA SFEROIDALE - SPHEROIDAL GRAPHITE	17-18	160-250	1,1	240	230	280							240	220				
GHISA MALLEABILE - MALLEABLE CAST IRON	19-20	130-230	1,2	260	230	280							250	220				
N ALLUMINIO E SUE LEGHE - ALUMINIUM	21-25	60-130	1,3				430	400	450									
RAME E SUE LEGHE - COPPER	26-28	90-110	1,2				280	250	335									
NON METALLICI - PLASTICS	29-30	/	1,3				380	350	400									
S LEGHE RESIST. CALORE - HIG. TEMP. ALLOY	31-35	200-320	0,9										70	40		80	60	
TITANIO E SUE LEGHE - TITANIUM	36-37	400-1050 ¹⁾	0,8										70	40		80	60	
H ACCIAIO TEMPRATO - HARDENED STEEL	38-41	45-60 ²⁾	0,8	120	80	140												

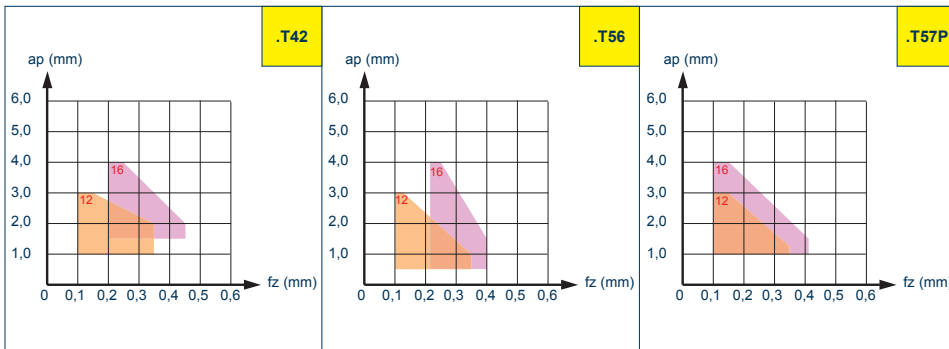

$$n = \frac{Vc \cdot 1000}{\varnothing D \cdot 3,14} = \text{giri/min (min}^{-1}\text{)}$$

$$fz = fz0 \cdot Kae \cdot Km = \text{mm}$$

$$fn = fz \cdot z = \text{mm}$$

$$Vf = fz \cdot z \cdot n = \text{mm/min}$$

ae/D	0,5-1	0,2	0,1	0,05	0,02
	50-100%	20%	10%	5%	2%
Kae	1	1,2	1,5	1,8	2

F = FINITURA, LAV. LEGGERA - FINISHING, LIGHT MACHINING
R = SGROSSATURA, LAV. PESANTE - ROUGHING, HEAVY MACHINING
HSC = LAVORAZIONE ALTA VELOCITÀ - HIGH SPEED CUTTING
Km = FATTORE DI AVANZAMENTO PER MATERIALE - FEED FACTOR FOR MATERIAL
Vc = m/min VELOCITÀ DI TAGLIO - CUTTING SPEED
n = giri/min (min⁻¹) NUMERO DI GIRI - NUMBER OF REV.
fz = mm AVANZAMENTO AL DENTE - TOOTH FEED
fn = mm AVANZAMENTO AL GIRO - FEED / REVOLUTION
Vf = mm/min VELOCITÀ DI AVANZAMENTO - FEED SPEED
Kae = FATTORE DI CORREZIONE - CORRECTION FACTOR

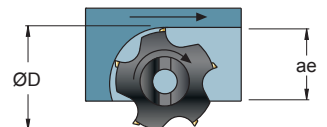

■ DISPONIBILI - IN STOCK - LIEFERBAR - DISPONIBLES / ■ NEW
 ●● APPLICAZIONE CONSIGLIATA - RECOMMENDED APPLICATION
 ○○ APPLICAZIONE POSSIBILE - POSSIBLE APPLICATION
 □ A RICHIESTA - ON REQUEST - AUF ANFRAGE - SUR DEMANDE / □ NEW
 MÖGLICHE ANWENDUNG - APPLICATION POSSIBLE

S 809W ..

Ø 10-42

CON INSERTI RDET.. .T56 / RDEX.. .T56 / RDHT.. .T57P NON È POSSIBILE UTILIZZARE LA STAFFA 24..
WITH RDET.. .T56 / RDEX.. .T56 / RDHT.. .T57P INSERTS THE CLAMPING SCREW 24.. CANNOT BE USED.D..
MIT RDET.. .T56 / RDEX.. .T56 / RDHT.. .T57P-WENDEPLATTEN IST DIE AUFSPANNSCHRAUBE 24.. NICHT EINSETZBAR.
AVEC LES PLAQUETTES RDET.. .T56 / RDEX.. .T56 / RDHT.. .T57P ON NE PEUT PAS UTILISER LA VIS DE BRIDAGE 24..

γ_p 0°
 γ_f 0°

RDGT.. .T42		
RDHX.. .T42		
RDET.. .T56		
RDEW.. .T56		
RDHT.. .T57P		

FORM A

FORM B

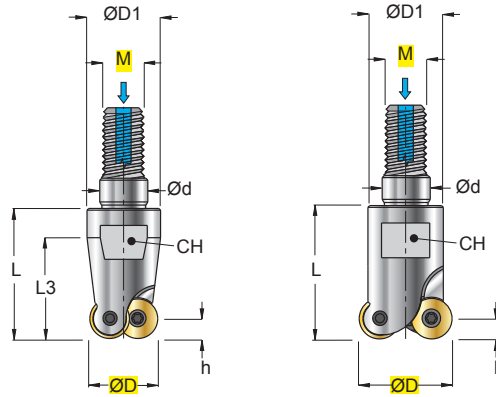

INSERTI - INSERTS
PAG. 531

ART.	FORM	ØD	M	Ød	ØD1	h	L	L3	β	Z	↻	CH	kg	Nm				
S 809W 10 23 02.05	A	10	8	8,5	13	2,5	23	17	28,9°	2	-	10	0,019	0,4+0,5	0501	121837P	-	5606P
S 809W 12 23 03.05	A	12	8	8,5	13	2,5	23	17	13,8°	3	-	10	0,020	0,4+0,5	0501	121837P	-	5606P
S 809W 15 23 04.05	B	15	8	8,5	13	2,5	23	-	8,6°	4	-	10	0,023	0,4+0,5				
S 809W 16 23 04.05	B	16	8	8,5	13	2,5	23	-	7,7°	4	-	10	0,025	0,4+0,5				
S 809W 20 30 05.05	B	20	10	10,5	18	2,5	30	-	6,9°	5	-	15	0,059	0,4+0,5				
S 809W 25 35 06.05	B	25	12	12,5	21	2,5	35	-	4,0°	6	-	17	0,099	0,4+0,5				
S 809W 12,5 23 02.71	A	12,5	8	8,5	13	3,5	23	17	22,7°	2	-	10	0,019	1,0+1,2				
S 809W 15 23 02.72	B	15	8	8,5	13	3,5	23	-	20,0°	2	-	10	0,020	1,0+1,2	0702	12254P	-	5607P
S 809W 15 23 03.72	B	15	8	8,5	13	3,5	23	-	20,0°	3	-	10	0,021	1,0+1,2				
S 809W 16 23 02.72	B	16	8	8,5	13	3,5	23	-	16,8°	2	-	10	0,022	1,0+1,2				
S 809W 16 23 03.72	B	16	8	8,5	13	3,5	23	-	16,8°	3	-	10	0,022	1,0+1,2				
S 809W 20 30 04.72	B	20	10	10,5	18	3,5	30	-	11,0°	4	-	15	0,054	1,0+1,2				
S 809W 25 35 05.72	B	25	12	12,5	21	3,5	35	-	7,3°	5	-	17	0,093	1,0+1,2				
S 809W 30 43 05.72	A	30	16	17	29	3,5	43	43	5,4°	5	-	24	0,208	1,0+1,2				
S 809W 32 43 06.72	B	32	16	17	29	3,5	43	-	4,9°	6	-	24	0,219	1,0+1,2				
S 809W 35 43 06.72	B	35	16	17	29	3,5	43	-	4,3°	6	-	24	0,233	1,0+1,2				
S 809W 20 30 02.10	B	20	10	10,5	18	5	30	-	39,0°	2	-	15	0,048	3,0+3,5				
S 809W 25 35 03.10	B	25	12	12,5	21	5	35	-	14,3°	3	-	17	0,083	3,0+3,5				
S 809W 30 43 04.10	A	30	16	17	29	5	43	43	9,3°	4	-	24	0,196	3,0+3,5				
S 809W 32 43 04.10	A	32	16	17	29	5	43	43	8,6°	4	-	24	0,200	3,0+3,5				
S 809W 35 43 04.10	B	35	16	17	29	5	43	-	7,3°	4	-	24	0,215	3,0+3,5				
S 809W 35 43 05.10	B	35	16	17	29	5	43	-	7,3°	5	-	24	0,216	3,0+3,5				
S 809W 40 43 05.10	B	40	16	17	29	5	43	-	5,8°	5	-	24	0,232	3,0+3,5				
S 809W 42 43 05.10	B	42	16	17	29	5	43	-	5,4°	5	-	24	0,243	3,0+3,5				
S 809W 42 43 06.10	B	42	16	17	29	5	43	-	5,4°	6	-	24	0,245	3,0+3,5				
S 809W 25 35 02.12	B	25	12	12,5	21	6	35	-	26,0°	2	-	17	0,076	3,0+3,5	12T3	123509P	2435P	5615P
S 809W 32 43 03.12	A	32	16	17	29	6	43	43	14,3°	3	-	24	0,178	3,0+3,5				
S 809W 35 43 03.12	B	35	16	17	29	6	43	-	11,9°	3	-	24	0,194	3,0+3,5				
S 809W 40 43 04.12	B	40	16	17	29	6	43	-	9,3°	4	-	24	0,212	3,0+3,5				
S 809W 42 43 04.12	B	42	16	17	29	6	43	-	8,3°	4	-	24	0,224	3,0+3,5				
S 809W 32 43 02.16	A	32	16	17	29	8	43	43	29,6°	2	-	24	0,169	4,0+5,0	1604	124510P	2445	5620P
S 809W 40 43 02.16	B	40	16	17	29	8	43	-	15°	2	-	24	0,226	4,0+5,0				

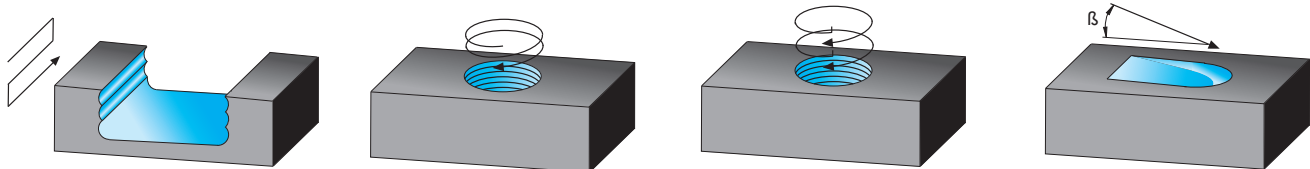

W = FORO PER LIQUIDO REFRIGERANTE - COOLANT BORE - KÜHLMITTELBOHRUNG - TROU DU LIQUIDE D'ARROSAGE
 ↻ = PASSO DIFFERENZIATO - DIFFERENTIAL PITCH - UNGLEICHE TEILUNG - PAS DIFFERENCIE

S 926W ..

Ø 8-32

FORM A

FORM B

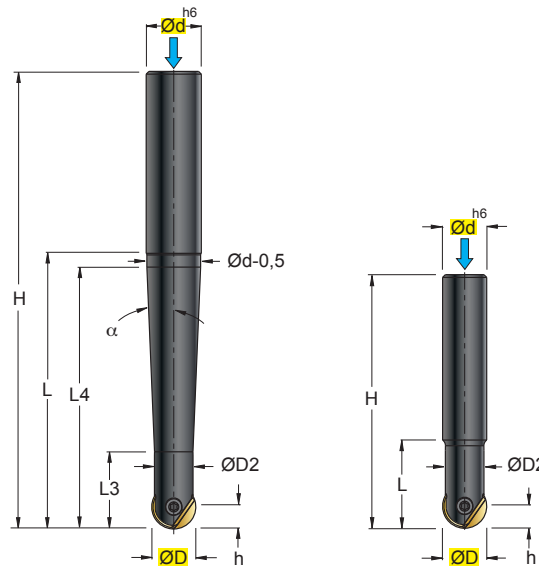

RA.. .F42	
RA.. .K32W	
RAET.. .F42	

INSERTI - INSERTS
 PAG. 530

ART.	FORM	ØD	Ød	ØD2	H	h	L	L3	L4	α	N	Z	kg	Nm			
S 926W 08 35 12	A	8	12	6,5	92	4	35	19	35	9,8°	1	2	0,062	0,8+1,0	08	12RA08	5407
S 926W 08 53 12	A	8	12	6,5	110	4	53	19	48	5,0°	1	2	0,072	0,8+1,0			
S 926W 08 75 12	A	8	12	6,5	132	4	75	19	70	2,8°	1	2	0,083	0,8+1,0			
S 926W 10 35 12	A	10	12	8	92	5	35	22	35	8,9°	1	2	0,065	1,8+2,0	10	12RA10	5408
S 926W 10 53 12	A	10	12	8	110	5	53	22	48	3,9°	1	2	0,076	1,8+2,0			
S 926W 10 75 12	A	10	12	8	132	5	75	22	70	2,1°	1	2	0,088	1,8+2,0			
S 926W 12 26 12	B	12	12	10	83	6	26	-	-	-	1	2	0,062	2,8+3,0	12	12RA12P	5410P
S 926W 12 53 12	B	12	12	10	110	6	53	-	-	-	1	2	0,078	2,8+3,0			
S 926W 12 85 16	A	12	16	10	145	6	85	22	80	2,8°	1	2	0,167	2,8+3,0			
S 926W 16 32 16	B	16	16	14	92	8	32	-	-	-	1	2	0,123	4,5+5,5	16	12RA16P	5415P
S 926W 16 63 16	B	16	16	14	123	8	63	-	-	-	1	2	0,159	4,5+5,5			
S 926W 16 100 20	A	16	20	14	166	8	100	28	95	2,4°	1	2	0,312	4,5+5,5			
S 926W 20 38 20	B	20	20	17	104	10	38	-	-	-	1	2	0,211	5,5+7,0	20	12RA20P	5420P
S 926W 20 75 20	B	20	20	17	141	10	75	-	-	-	1	2	0,277	5,5+7,0			
S 926W 20 115 25	A	20	25	17	191	10	115	34	110	2,8°	1	2	0,553	5,5+7,0			
S 926W 25 45 25	B	25	25	21	121	12,5	45	-	-	-	1	2	0,379	10+13	25	12RA25	5430
S 926W 25 90 25	B	25	25	21	166	12,5	90	-	-	-	1	2	0,501	10+13			
S 926W 25 135 32	A	25	32	21	215	12,5	135	41	130	2,9°	1	2	0,962	10+13			
S 926W 32 53 32	B	32	32	26	133	16	53	-	-	-	1	2	0,660	24+30	32	12RA32	5440
S 926W 32 106 32	B	32	32	26	186	16	106	-	-	-	1	2	0,879	24+30			
S 926W 32 160 32	A	32	32	26	240	16	160	49	155	1,5°	1	2	1,207	24+30			

$$n = \frac{Vc \cdot 1000}{\text{ØDe} \cdot 3,14} = \text{giri/min (min}^{-1}\text{)}$$

$$fz = fz0 \cdot Km = \text{mm}$$

$$Vf = fz0 \cdot Km \cdot z \cdot n = \text{mm/min}$$

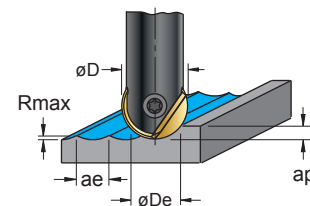

$$\text{ØDe} = 2 \cdot \sqrt{D \cdot ap - ap^2} = \text{mm}$$

$$R_{max} = 0,5 \cdot (\text{ØD} - \sqrt{\text{ØD}^2 - ae^2}) = \text{mm}$$

- F = FINITURA, LAV. LEGGERA - FINISHING, LIGHT MACHINING
- HSC = LAVORAZIONE ALTA VELOCITÀ - HIGH SPEED CUTTING
- Vc = m/min VELOCITÀ DI TAGLIO - CUTTING SPEED
- n = giri/min (min⁻¹) NUMERO DI GIRI - NUMBER OF REVOLUTIONS
- fz = mm AVANZAMENTO AL DENTE - TOOTH FEED
- Vf = mm/min VELOCITÀ DI AVANZAMENTO - FEED SPEED
- Km = FATTORE DI AVANZAMENTO PER MATERIALE - FEED FACTOR FOR MATERIAL
- De = mm DIAMETRO EFFETTIVO - EFFECTIVE DIAMETER
- Rmax = mm RUGOSITÀ TEORICA MASSIMA - THEORICAL MAXIMUM ROUGHNESS

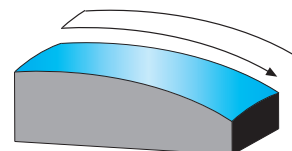
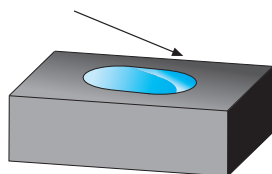

N = NUMERO D'INSERTI / INSERT NUMBER / WENDEPLATTENANZAHL / NOMBRE DES PLAQUETTES
 Z = NUMERO TAGLIENTI / NUMBER OF CUTTING EDGES / SCHNEIDENANZAHL / NOMBRE DU COUPANTS

S 929W ..

FORM A

FORM B

Ø 10-32

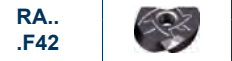
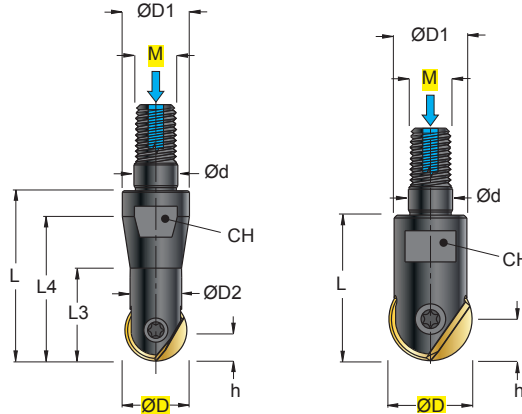

INSERTI - INSERTS
 PAG. 530

ART.	FORM	(mm)													CH	kg	Nm	ØD	12RA	54
		ØD	M	Ød	ØD1	ØD2	h	L	L3	L4	N	Z								
S 929W 10 33 08	A	10	8	8,5	13	8	5	33	18	28	1	2	10	0,022	1,8+2,0	10	12RA10	5408		
S 929W 12 33 08	A	12	8	8,5	13	10	6	33	18	28	1	2	10	0,026	2,8+3,0	12	12RA12P	5410P		
S 929W 16 28 08	B	16	8	8,5	14	14	8	28	-	-	1	2	10	0,029	4,5+5,5	16	12RA16P	5415P		
S 929W 20 28 10	B	20	10	10,5	17	17	10	28	-	-	1	2	15	0,042	5,5+7,0	20	12RA20P	5420P		
S 929W 25 41 12	B	25	12	12,5	21	21	12,5	41	-	-	1	2	17	0,093	10+13	25	12RA25	5430		
S 929W 32 49 16	B	32	16	17	26	26	16	49	-	-	1	2	24	0,174	24+30	32	12RA32	5440		

$$n = \frac{V_c \cdot 1000}{\text{ØDe} \cdot 3,14} = \text{giri/min (min}^{-1}\text{)}$$

$$f_z = fz0 \cdot Km = \text{mm}$$

$$V_f = fz0 \cdot Km \cdot z \cdot n = \text{mm/min}$$

- F = FINITURA , LAV. LEGGERA - FINISHING , LIGHT MACHINING
- HSC = LAVORAZIONE ALTA VELOCITÀ - HIGH SPEED CUTTING
- Vc = m/min VELOCITÀ DI TAGLIO - CUTTING SPEED
- n = giri/min (min⁻¹) NUMERO DI GIRI - NUMBER OF REVOLUTIONS
- fz = mm AVANZAMENTO AL DENTE - TOOTH FEED
- Vf = mm/min VELOCITÀ DI AVANZAMENTO - FEED SPEED
- Km = FATTORE DI AVANZAMENTO PER MATERIALE - FEED FACTOR FOR MATERIAL
- De = mm DIAMETRO EFFETTIVO - EFFECTIVE DIAMETER
- Rmax = mm RUGOSITÀ TEORICA MASSIMA - THEORETICAL MAXIMUM ROUGHNESS

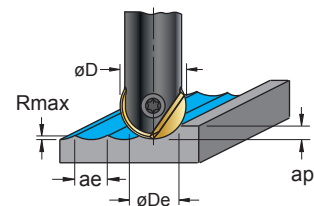

$$\text{ØDe} = 2 \cdot \sqrt{D \cdot ap - ap^2} = \text{mm}$$

$$R_{\text{max}} = 0,5 \cdot (\text{ØD} - \sqrt{\text{ØD}^2 - ae^2}) = \text{mm}$$

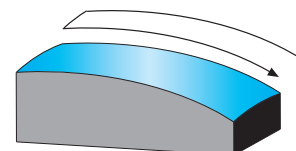
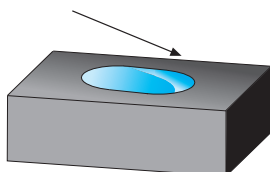

N = NUMERO D'INSERTI / INSERT NUMBER / WENDEPLATTENANZAHL / NOMBRE DES PLAQUETTES
 Z = NUMERO TAGLIENTI / NUMBER OF CUTTING EDGES / SCHNEIDENANZAHL / NOMBRE DU COUPANTS

S 9002-6W...-11

Ø 16-25

γ_p +10°
 γ_f -8°/-11°
 γ_o -8°/-11°

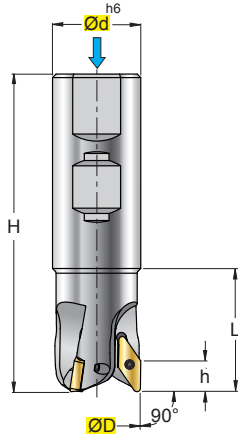

S 9002-9W...-11

Ø 16-25

γ_p +10°
 γ_f -8°/-11°
 γ_o -8°/-11°

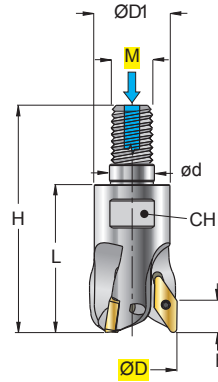

VDKT
11T2..
.K57P



INSERTI - INSERTS
PAG. 537

ART.	(mm)											kg	Nm	ISO 6462			
	ØD	M	Ød	ØD1	H	h	L	β	Z	CH							
S9002-6W-016-02-11	16	-	16	-	80	8	30	35°	2	-	-	0,10	1+1,2	-	11T2..	122545	5607
S9002-6W-020-02-11	20	-	20	-	85	8	35	26°	2	-	-	0,15	1+1,2	-	11T2..	122555PK	5608
S9002-6W-025-03-11	25	-	25	-	90	8	35	19,5°	3	-	-	0,25	1+1,2	-			
S9002-9W-016-02-11	16	8	8,5	12,7	52	8	35	35°	2	-	10	0,03	1+1,2	-	11T2..	122545	5607
S9002-9W-020-02-11	20	10	10,5	17,7	54	8	35	26°	2	-	15	0,05	1+1,2	-	11T2..	122555PK	5608
S9002-9W-025-03-11	25	12	12,5	20,7	57	8	35	19,5°	3	-	17	0,07	1+1,2	-			

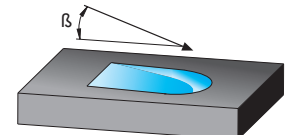
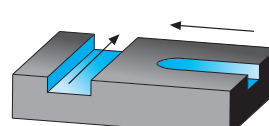
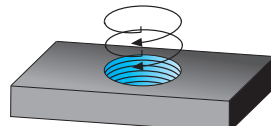
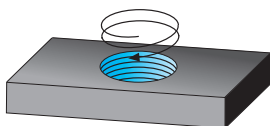

W = FORO PER LIQUIDO REFRIGERANTE - COOLANT BORE - KÜHLMITTELBOHRUNG - TROU DU LIQUIDE D'ARROSAGE

SCELTA VELOCE - QUICK PICK										Tenacità + ↑ Toughness - ↓		Pag. 538		HT	HW	HC													
COD.		P			M			K			N			S			H			CERMET	NON RIV. CEMENTED CARBIDE GRADES	RIVESTITI COATED GRADES BESCHICHTET RECOUVERTS		l	d	s	d1	r	a°
VDKT	11T210 N .K57P	F	M	R	F	M	R	F	M	R	F	M	R	F	M	R	F	M	R			T110	■						
											●	●	●																
CON ADDUZIONE LUBROREFRIGERANTE - WITH COOLANT SUPPLY										●																			
SENZA ADDUZIONE LUBROREFRIGERANTE - WITHOUT COOLANT SUPPLY										○																			

MATERIALI - MATERIALS Pag. 1199		VDI 3323 GR.	HB Rm ¹⁾ HRC ²⁾	fz0 mm			Vc m/min Pag. 552															
				F	M	R	T110															
P	ACCIAIO NON LEGATO - NOT ALLOY STEEL	1--5	125-300																			
	ACCIAIO POCO LEGATO - LOW ALLOY STEEL	6--9	180-350																			
	ACCIAIO ALTO LEGATO - ALLOY STEEL	10-11	200-325																			
	INOX MARTENS. - STAINLESS STEEL MART	12-13	200-240																			
M	INOX AUST. DUPLEX - STAINLESS STEEL AUST	14.1-14.2	180-230																			
	GHISA GRIGIA - GREY CAST IRON	15-16	180-260																			
	GHISA SFEROIDALE - SPHEROIDAL GRAPHITE	17-18	160-250																			
K	GHISA MALLEABILE - MALLEABLE CAST IRON	19-20	130-230																			
	ALLUMINIO E SUE LEGHE - ALUMINIUM	21--25	60-130	0,06	0,15	0,2	950															
	RAME E SUE LEGHE - COPPER	26--28	90-110	0,06	0,12	0,18	400															
N	NON METALLICI - PLASTICS	29-30	/	0,06	0,12	0,18	300															
	LEGHE RESIST. CALORE - HIG. TEMP. ALLOY	31--35	200-320																			
S	TITANIO E SUE LEGHE - TITANIUM	36-37	400-1050 ³⁾																			
H	ACCIAIO TEMPRATO - HARDENED STEEL	38--41	45-60 ³⁾																			

$$n = \frac{Vc \cdot 1000}{\varnothing D \cdot 3,14} = \text{giri/min (min}^{-1}\text{)}$$

$$fz = fz0 \cdot Kae = \text{mm}$$

$$fn = fz \cdot z = \text{mm}$$

$$Vf = fz \cdot z \cdot n = \text{mm/min}$$

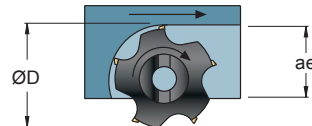

ae/D	0,5-1 50-100%	0,2 20%	0,1 10%	0,05 5%	0,02 2%
Kae	1	1,1	1,2	1,3	1,5

ae/D	0,5-1 50-100%	0,2 20%	0,1 10%	0,05 5%
Vc	Vc (min)-----Vc(max)			
Pag. 552				

- F = FINITURA , LAV. LEGGERA - FINISHING , LIGHT MACHINING
M = LAV. MEDIA , GENERICA - MEDIUM MACHINING , GENERIC
R = SGROSSATURA , LAV. PESANTE - ROUGHING , HEAVY MACHINING

- Vc = m/min VELOCITÀ DI TAGLIO - CUTTING SPEED
n = giri/min (min⁻¹) NUMERO DI GIRI - NUMBER OF REVOLUTIONS
fz = mm AVANZAMENTO AL DENTE -TOOTH FEED
fn = mm AVANZAMENTO AL GIRO - FEED / REVOLUTION
Vf = mm/min VELOCITÀ DI AVANZAMENTO - FEED SPEED
Kae = FATTORE DI CORREZIONE - CORRECTION FACTOR

S 9002-8W...-22

Ø 42-80

γ_p 0°
 γ_f -2,5°/-6°
 γ_o -2,5°/-6°

ISO 6462 ...

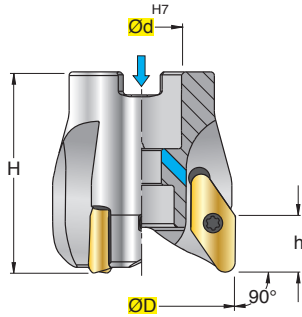
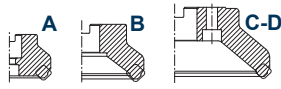

S 9002-9W...-22

Ø 32-42

γ_p 0°
 γ_f -5°/-6°
 γ_o -5°/-6°

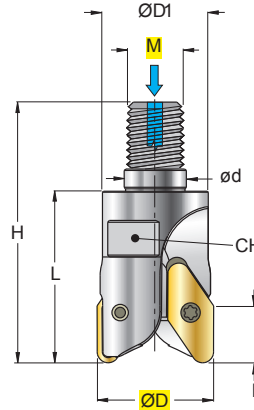

VCKT
2205..
.K57P



INSERTI - INSERTS
PAG. 537

ART.	(mm)											kg	Nm	ISO 6462				
	ØD	M	Ød	ØD1	H	h	L	β	Z	\leftrightarrow	CH							
S9002-8W-042-03-22	42	-	16	-	55	15	-	23°	3	-	-	0,20	4+5	A	2205..	124511P	5620P	VBSF08L
S9002-8W-052-03-22	52	-	22	-	55	15	-	17°	3	-	-	0,35	4+5	A	2205..	124511P	5620P	VBSF10
S9002-8W-066-04-22	66	-	27	-	56	15	-	12,5°	4	-	-	0,55	4+5	A	2205..	124511P	5620P	VBSF12
S9002-8W-080-04-22	80	-	27	-	56	15	-	10°	4	-	-	0,95	4+5	A				
S9002-9W-032-02-22	32	16	17	29	71	15	47	35°	2	-	24	0,15	4+5	-	2205..	124511P	5620P	-
S9002-9W-042-03-22	42	16	17	29	71	15	47	23°	3	-	24	0,20	4+5	-				

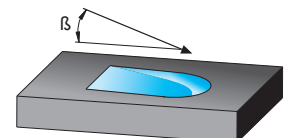
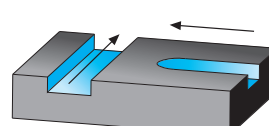
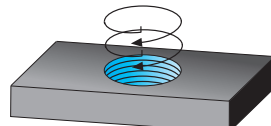
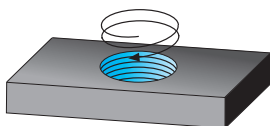

W = FORO PER LIQUIDO REFRIGERANTE - COOLANT BORE - KÜHLMITTELBOHRUNG - TROU DU LIQUIDE D'ARROSAGE

SCelta VELOCE - QUICK PICK		Tenacità + ↑		Toughness - ↓		Pag. 538		HT	HW	HC																
		CERMET		NON RIV. CEMENTED CARBIDE GRADES		RIVESTITI COATED GRADES BESCHICHTET RECOUVERTS																				
COD.		P		M		K		N		S		H														
		F	M	R	F	M	R	F	M	R	F	M	R	F	M	R	F	M	R	l	d	s	d1	r	a°	
VCKT	220530 .K57P							●	●	●										20,1	12,7	5,56	5,6	3,0	7	
CON ADDUZIONE LUBROREFRIGERANTE - WITH COOLANT SUPPLY								●																		
SENZA ADDUZIONE LUBROREFRIGERANTE - WITHOUT COOLANT SUPPLY								○																		

MATERIALI - MATERIALS		VDI 3323 GR.	HB Rm ¹⁾ HRC ²⁾	fz0 mm			Vc m/min												
Pag. 1199				F	M	R	T110												
P	ACCIAIO NON LEGATO - NOT ALLOY STEEL	1--5	125-300																
	ACCIAIO POCO LEGATO - LOW ALLOY STEEL	6--9	180-350																
	ACCIAIO ALTO LEGATO - ALLOY STEEL	10-11	200-325																
	INOX MARTENS. - STAINLESS STEEL MART	12-13	200-240																
M	INOX AUST. DUPLEX - STAINLESS STEEL AUST	14.1-14.2	180-230																
K	GHISA GRIGIA - GREY CAST IRON	15-16	180-260																
	GHISA SFEROIDALE - SPHEROIDAL GRAPHITE	17-18	160-250																
	GHISA MALLEABILE - MALLEABLE CAST IRON	19-20	130-230																
N	ALLUMINIO E SUE LEGHE - ALUMINIUM	21--25	60-130	0,08	0,2	0,35	950												
	RAME E SUE LEGHE - COPPER	26--28	90-110	0,06	0,18	0,3	400												
	NON METALLICI - PLASTICS	29-30	/	0,06	0,18	0,3	300												
S	LEGHE RESIST. CALORE - HIG. TEMP. ALLOY	31--35	200-320																
	TITANIO E SUE LEGHE - TITANIUM	36-37	400-1050 ³⁾																
H	ACCIAIO TEMPRATO - HARDENED STEEL	38--41	45-60 ³⁾																

$$n = \frac{Vc \cdot 1000}{\varnothing D \cdot 3,14} = \text{giri/min (min}^{-1}\text{)}$$

$$fz = fz0 \cdot Kae = \text{mm}$$

$$fn = fz \cdot z = \text{mm}$$

$$Vf = fz \cdot z \cdot n = \text{mm/min}$$

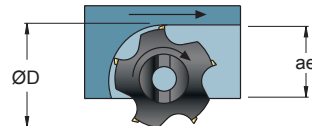

ae/D	0,5-1 50-100%	0,2 20%	0,1 10%	0,05 5%	0,02 2%
Kae	1	1,1	1,2	1,3	1,5

ae/D	0,5-1 50-100%	0,2 20%	0,1 10%	0,05 5%
Vc	Vc (min)-----Vc(max)			
Pag. 552				

- F = FINITURA , LAV. LEGGERA - FINISHING , LIGHT MACHINING
- M = LAV. MEDIA , GENERICA - MEDIUM MACHINING , GENERIC
- R = SGROSSATURA , LAV. PESANTE - ROUGHING , HEAVY MACHINING

- Vc = m/min VELOCITÀ DI TAGLIO - CUTTING SPEED
- n = giri/min (min⁻¹) NUMERO DI GIRI - NUMBER OF REVOLUTIONS
- fz = mm AVANZAMENTO AL DENTE -TOOTH FEED
- fn = mm AVANZAMENTO AL GIRO - FEED / REVOLUTION
- Vf = mm/min VELOCITÀ DI AVANZAMENTO - FEED SPEED
- Kae = FATTORE DI CORREZIONE - CORRECTION FACTOR



	DENOMINAZIONI DEGLI INSERTI PER FRESATURA	Pag. 524
	CATALOGO DISPONIBILITÀ INSERTI	Pag. 525
	COME SCEGLIERE I PARAMETRI DI LAVORO	Pag. 539
	PANORAMICA QUALITÀ DI FRESATURA	Pag. 541
	IMPIEGO DELLE QUALITÀ DI FRESATURA	Pag. 542
	VELOCITÀ DI TAGLIO DELLE QUALITÀ DI FRESATURA	Pag. 552

	INSERTS DESIGNATION FOR MILLING	Pag. 524
	INSERTS STOCK CATALOGUE	Pag. 525
	HOW TO CHOOSE CUTTING DATA	Pag. 539
	GENERAL VIEW OF THE MILLING GRADE	Pag. 541
	APPLICATION OF THE MILLING GRADE	Pag. 542
	CUTTING SPEED OF MILLING GRADES	Pag. 552

	BEZEICHNUNG DER FRÄSWENDEPLATTEN	Pag. 524
	WENDEPLATTEN-KATALOG	Pag. 525
	EINSTELLUNG DER SCHNITTDATEN	Pag. 539
	FRÄSSORTEN-ÜBERSICHT	Pag. 541
	EINSATZ DER FRÄSSORTEN	Pag. 542
	SCHNITTGESCHWINDIGKEIT DER FRÄSSORTEN (VC)	Pag. 552

	DÉNOMINATION DE LES PLAQUETTES POUR LE FRAISAGE	Pag. 524
	CATALOGUE DE DISPONIBILITÉ PLAQUETTES	Pag. 525
	COMMENT CHOISIR LES PARAMETRES DE SERVICE	Pag. 539
	VUE D' ENSEMBLE QUALITÉ DE FRAISAGE	Pag. 541
	UTILISATION DE LES QUALITÉES DE FRAISAGE	Pag. 542
	VITESSE DECOUPE DE LA QUALITÉ DE PLAQUETTES DE FRAISAGE	Pag. 552



INSERTI PER FRESATURA

MILLING INSERTS / WENDEPLATTEN ZUM FRÄSEN
PLAQUÉTTES DE FRAISAGE / PLAQUITAS DE FRESADO



A	P	K	T		10	03	P	D	T	R	.	-	-	-	P
1	2	3	4		5	6	7a/7b	8	9			10	11	12	13

1	FORMA INSERTO SHAPE OF INSERT	2	SPOGLIA INFER. RELIEF ANGLE	3	TOLLERANZA+/-{mm} TOLERANCE+/-{mm}	4	TIPO INSERTO TYPE OF INSERT	
A		A			A		N	
B		B			C		Q	
C		C			E		R	
D		D			F		T	
E		E			G		U	
H		F			H		W	
K		G			J		X	SPECIALE SPECIAL
L		N			K			
M		O			L			
O		P			M			
R					N			
S					U			
T								
V								
W								

5	LUNGHEZZA TAGLIANTE CUTTING EDGE LENGTH												
gd CERCHIO INSCRITTO CIRCLE	A	C	D	E	K	L	M	O	R	S	T	V	W
3,97											08		02
4,76											09		02-03
5,56		05											
6,00											11	11	04
6,35		06	07	06			06		06	11	11		04
6,70	10									07			
7,94										07			
8,00				08									05
9,45	16												
9,52	15-16	09	11	09	16	15	09		09	16	16	06	06
10,00									10				06
11,00									11				
11,50					12								
12,00									12				07
12,62					18								
12,70		12	15	12	15-20	05		12	22				08
15,87		16						15					
19,05		19						19					

6	SPESORE THICKNESS	
	S	mm
	01	1,59
	T1	1,97
	02	2,38
	T2	2,78
	03	3,18
	T3	3,97
	04	4,76
	05	5,56
	06	6,35
	07	7,94
	08	9,52

7a	RAGGIO RADIUS	
	00"	MO (mm)
	02	r=0,2
	04	r=0,4
	05	r=0,5
	06	r=0,6
	08	r=0,8
	10	r=1,0
	12	r=1,2
	16	r=1,6

7b	SMUSSO CHAMFER	
	K°	X°
	A=45°	D=15°
	D=60°	E=20°
	E=75°	F=25°
	F=85°	N=0°
	P=90°	P=11°
	Z=SPEC	Z=SPEC

8	
F	
E	
T	
S	

9	
R	
L	
N	

10	LETTERA DI IDENTIF. IDENTIFICATION LETTER
A	M
C	N
D	P
E	R
F	S
G	T
H	U
I	W
J	Y
K	Z
L	

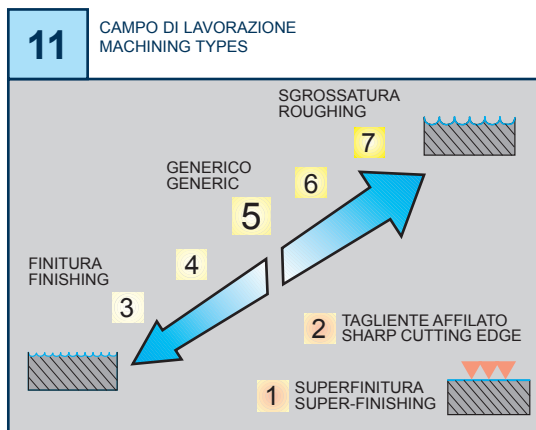

12	PREPARAZIONE TAGLIANTE CUTTING EDGE PREPARATION
1 =	SPECIFICO PER GHISA SPECIFIC FOR CAST IRON
3 =	SPECIFICO PER ACCIAIO INOX SPECIFIC FOR STAINLESS STEEL
7 =	SPECIFICO PER LEGHE DI ALLUMINIO SPECIFIC FOR ALUMINIUM ALLOYS
9 =	SPECIFICO PER ACCIAIO SPECIFIC FOR STEEL
2 =	
4 =	INTERMEDI DI USO GENERIC INTERMEDIATE FOR GENERAL USE
5 =	
6 =	
8 =	

13	LUCIDATO POLISH

156.15.. 154.15..								HT	HW	HC																
								CERMET	NON RIVESTITI CEMENTED CARBIDE GRADES	RIVESTITI COATED GRADES BESCHICHTET RECOUVERTS																
ART.	COD.	l	d	s	d1	W	T		N6315	N3440		F4340						F6315								
		TOLLERANZA W - W TOLERANCE																								
 C54	156.15-16110	.C54	16,0	9,52	3	4,5	1,10	3,0																		
	156.15-16130	.C54	16,0	9,52	3	4,5	1,30	3,0																		
	156.15-16160	.C54	16,0	9,52	3	4,5	1,60	3,0																		
	156.15-16185	.C54	16,0	9,52	3	4,5	1,85	3,0																		
	156.15-16215	.C54	16,0	9,52	3	4,5	2,15	3,0																		
	156.15-16265	.C54	16,0	9,52	3	4,5	2,65	3,0																		
	156.15-16315	.C54	16,0	9,52	3,5	4,5	3,15	3,3																		
156.15-16415	.C54	16,0	9,52	4,5	4,5	4,15	3,3																			
 C57	156.15-16110	.C57	16,0	9,52	3	4,5	1,10	3,0		■																
	156.15-16130	.C57	16,0	9,52	3	4,5	1,30	3,0		■																
	156.15-16160	.C57	16,0	9,52	3	4,5	1,60	3,0		■																
	156.15-16185	.C57	16,0	9,52	3	4,5	1,85	3,0		■																
	156.15-16215	.C57	16,0	9,52	3	4,5	2,15	3,0		■																
	156.15-16265	.C57	16,0	9,52	3	4,5	2,65	3,0		■																
	156.15-16315	.C57	16,0	9,52	3,5	4,5	3,15	3,3		■																
156.15-16415	.C57	16,0	9,52	4,5	4,5	4,15	3,3		■																	
		TOLLERANZA W - W TOLERANCE																								
	154.15-16110		16,0	9,52	2,5	4,5	1,25	1,2		■			■													
	154.15-16130		16,0	9,52	2,5	4,5	1,45	1,5		■			■													
	154.15-16160		16,0	9,52	2,5	4,5	1,80	1,8		■			■													
	154.15-16185		16,0	9,52	2,5	4,5	2,00	3		■			■													
	154.15-16215		16,0	9,52	2,8	4,5	2,30	3		■			■													
	154.15-16265		16,0	9,52	3,3	4,5	2,80	3		■			■													
	154.15-16315		16,0	9,52	3,8	4,5	3,35	3		■			■													
		TOLLERANZA W - W TOLERANCE																								
		SET 154.15-16110215 N3440 SET 154.15-16110215 F4340 Contenuto del kit / Content of the kit: Contenuto del kit / Content of the kit: - n°2 154.15-16110 N3440 - n°2 154.15-16110 F4340 - n°2 154.15-16130 N3440 - n°2 154.15-16130 F4340 - n°2 154.15-16160 N3440 - n°2 154.15-16160 F4340 - n°2 154.15-16185 N3440 - n°2 154.15-16185 F4340 - n°2 154.15-16215 N3440 - n°2 154.15-16215 F4340																								
		MATERIALE - MATERIAL - MATERIALIEN - MATÉRIAUX																								
P	ACCIAIO - STEEL - STAHL - ACIER																									
M	ACCIAIO INOX - STAINLESS STEEL - ROSTFREIER STAHL - ACIER INOXYDABLE																									
K	GHISA - CAST IRON - GRAUGUSS - FONTE GRISE																									
N	LEGHE DI ALLUMINIO - ALUMINIUM ALLOYS - ALUMINIUM-LEGIERUNGEN - ALLIAGES D'ALUMINIUM																									
S	LEGHE RESISTENTI AL CALORE - HEAT RESISTANT ALLOYS - WÄRMEBESTÄNDIGE LEGIERUNGEN - ALLIAGES RÉSISTANTES À LA CHALEUR																									
H	MATERIALI DURI E TEMPRATI - HARD AND HARDENED MATERIAL - HARTE UND GEHÄRTETE MATERIALIEN - MATERIAUX DURS ET TREMPÉS																									

APHT APKT APKX									HT	HW	HC											
	ART.	COD.	l	d	s	d1	r	a°	CERMET	NON RIVESTITI CEMENTED CARBIDE GRADES	RIVESTITI COATED GRADES BESCHICHTET RECOUVERTS											
									T120			T516	T526	T528N	T530			T525	F2330	F1035	F2335	
	APKT 1003 PDR .I52		10,5	6,70	3,5	2,8	0,5	11						■								
	APKT 1003 PDR .N52 NEW		10,5	6,70	3,5	2,8	0,5	11						■								
	APKT 1003 PDTR .S52		10,5	6,70	3,5	2,8	0,5*	11					■		■							
									* = RAGGIO PARZIALE / PARTIAL RADIUS/ TEILRADIUS / RAYON PARTIEL													
	APKX 1003 PDR .S52		10,5	6,70	3,5	2,8	0,5*	11													■	
									* = RAGGIO PARZIALE / PARTIAL RADIUS/ TEILRADIUS / RAYON PARTIEL													
	APKT 1003 PDER .Z54		10,5	6,70	3,5	2,8	0,5	11														■
	APKT 1003 PDSR .Z54		10,5	6,70	3,5	2,8	0,5	11						■								
	APKT 1003 PDER .T55		11,0	6,70	3,5	2,8	0,5	11													■	■
	APHT 1003 PDFR .S57		10,5	6,70	3,5	2,8	0,5	11		■												
MATERIALE - MATERIAL - MATERIALIEN - MATÉRIAUX									T120			T516	T526	T528N	T530			T525	F2330	F1035	F2335	
P	ACCIAIO - STEEL - STAHL - ACIER												●	●	●					●	○	○
M	ACCIAIO INOX - STAINLESS STEEL - ROSTFREIER STAHL - ACIER INOXYDABLE												○	○	●					●	●	●
K	GHISA - CAST IRON - GRAUGUSS - FONTE GRISE									●			●	●	○					○		○
N	LEGHE DI ALLUMINIO - ALUMINIUM ALLOYS - ALUMINIUM-LEGIERUNGEN - ALLIAGES D'ALUMINIUM									●				○								
S	LEGHE RESISTENTI AL CALORE - HEAT RESISTANT ALLOYS - WÄRMEBESTÄNDIGE LEGIERUNGEN - ALLIAGES RÉISTANTES À LA CHALEUR									○			○	○	○					○	●	●
H	MATERIALI DURI E TEMPRATI - HARD AND HARDENED MATERIAL - HARTE UND GEHÄRTETE MATERIALIEN - MATERIAUX DURS ET TREMPÉS																			○		

■ DISPONIBILI - IN STOCK - LIEFERBAR - DISPONIBLES / ■ NEW
● APPLICAZIONE CONSIGLIATA-RECOMMENDED APPLICATION-
EMPFÖHLENER EINSATZ - APPLICATION CONSEILLÉE

□ A RICHIESTA - ON REQUEST - AUF ANFRAGE - SUR DEMANDE / □ NEW
○ APPLICAZIONE POSSIBILE - POSSIBLE APPLICATION -
MÖGLICHE ANWENDUNG - APPLICATION POSSIBLE

APMT APFT APFX APKT APKX									HT	HW	HC								
									CERMET	NON RIVESTITI CEMENTED CARBIDE GRADES	RIVESTITI COATED GRADES BESCHICHTET RECOUVERTS								
											T110	T120	F4635	T516	T526	T528N	T530	T525	F2330
ART.	COD.	l	d	s	d1	r	a°												
.S51	APKT 1604 PDR .S51	17,0	9,45	5,26	4,4	0,4	11												
.I52	APMT 1604 PDR .I52	17,0	9,45	5,26	4,4	0,8	11												
.N52	APMT 1604 PDR .N52 NEW	17,0	9,45	5,26	4,4	0,8	11												
.S52	APKT 1604 PDTR .S52	17,0	9,45	5,26	4,4	0,8 *	11												
* = RAGGIO PARZIALE / PARTIAL RADIUS / TEILRADIUS / RAYON PARTIEL																			
.S52	APFT 1604 PDTR .S52	17,0	9,45	4,76	4,4	0,8	11												
.S52	APKX 1604 PDR .S52	17,0	9,45	5,76	4,4	0,8	11												
.S52	APFX 160416R .S52	17,0	9,45	4,76	4,4	1,6	11												
	APFX 160424R .S52	17,0	9,45	4,76	4,4	2,4	11												
	APFX 160430R .S52	17,0	9,45	4,76	4,4	3,0	11												
	APFX 160440R .S52	17,0	9,45	4,76	4,4	4,0	11												
	APFX 160448R .S52	17,0	9,45	4,76	4,4	4,8	11												
.S54	APKT 1604 PDTR .S54	17,0	9,45	5,26	4,4	0,4	11												
.Z54	APKT 1604 PDSR .Z54	17,0	9,45	5,26	4,4	0,8	11												
.T55	APKT 1604 PDR .T55	17,0	9,45	5,76	4,5	0,8	11												
.K57P	APKT 1604 PDFR .K57P	16,4	9,53	4,76	4,4	0,2	11												
MATERIALE - MATERIAL - MATERIALIEN - MATÉRIAUX																			
P	ACCIAIO - STEEL - STAHL - ACIER																		
M	ACCIAIO INOX - STAINLESS STEEL - ROSTFREIER STAHL - ACIER INOXYDABLE																		
K	GHISA - CAST IRON - GRAUGUSS - FONTE GRISE																		
N	LEGHE DI ALLUMINIO - ALUMINIUM ALLOYS - ALUMINIUM-LEGIERUNGEN - ALLIAGES D'ALUMINIUM																		
S	LEGHE RESISTENTI AL CALORE - HEAT RESISTANT ALLOYS - WÄRMEBESTÄNDIGE LEGIERUNGEN - ALLIAGES RÉSISTANTES À LA CHALEUR																		
H	MATERIALI DURI E TEMPRATI - HARD AND HARDENED MATERIAL - HARTE UND GEHÄRTETE MATERIALIEN - MATÉRIAUX DURS ET TREMPÉS																		

■ DISPONIBILI - IN STOCK - LIEFERBAR - DISPONIBLES / ■ NEW
 ● APPLICAZIONE CONSIGLIATA-RECOMMENDED APPLICATION-
 EMPFOHLENER EINSATZ - APPLICATION CONSEILLÉE
 □ A RICHIESTA - ON REQUEST - AUF ANFRAGE - SUR DEMANDE / □ NEW
 ○ APPLICAZIONE POSSIBILE - POSSIBLE APPLICATION -
 MÖGLICHE ANWENDUNG - APPLICATION POSSIBLE

BDMT BDGT		LNMM							HT	HW	HC															
		ART	COD.	l	d	s	d1		r	a°	CERMET	NON RIVESTITI CEMENTED CARBIDE GRADES	RIVESTITI COATED GRADES BESCHICHTET RECOUVERTS													
										N3015			F3710	T3116	F3120	F4725				F1325	F1335	F4345				
		BDGT 11T302FR .Y57	11,0	6,7	3,8	2,8	0,2	18																		
		BDGT 11T304FR .Y57	11,0	6,7	3,8	2,8	0,4	18																		
		BDGT 11T308FR .Y57	11,0	6,7	3,8	2,8	0,8	18																		
		BDGT 170404FR .Y57	17,0	9,6	4,9	4,4	0,4	18																		
		BDGT 170408FR .Y57	17,0	9,6	4,9	4,4	0,8	18																		
		BDGT 170420FR .Y57	17,0	9,6	4,9	4,4	2,0	18																		
		BDGT 170431FR .Y57	17,0	9,6	4,9	4,4	3,1	18																		
		BDMT 070304ER .Y42	6,7	4,6	2,6	2,3	0,4	16																		
		BDMT 11T304ER .Y42	11,0	6,7	3,8	2,8	0,4	18																		
		BDMT 11T308ER .Y42	11,0	6,7	3,8	2,8	0,8	18																		
		BDMT 170404ER .Y42	17,0	9,6	4,9	4,4	0,4	18																		
		BDMT 170408ER .Y42	17,0	9,6	4,9	4,4	0,8	18																		
		BDMT 070302ER .Y52	6,7	4,6	2,6	2,3	0,2	16																		
		BDMT 070304ER .Y52	6,7	4,6	2,6	2,3	0,4	16																		
		BDMT 11T308ER .Y52	11,0	6,7	3,8	2,8	0,8	18																		
		BDMT 11T312ER .Y52	11,0	6,7	3,8	2,8	1,2	18																		
		BDMT 11T316ER .Y52	11,0	6,7	3,8	2,8	1,6	18																		
		BDMT 11T320ER .Y52	11,0	6,7	3,8	2,8	2,0	18																		
		BDMT 11T324ER .Y52	11,0	6,7	3,8	2,8	2,4	18																		
		BDMT 11T331ER .Y52	11,0	6,7	3,8	2,8	3,1	18																		
		BDMT 170404ER .Y52	17,0	9,6	4,9	4,4	0,4	18																		
		BDMT 170408ER .Y52	17,0	9,6	4,9	4,4	0,8	18																		
		BDMT 170412ER .Y52	17,0	9,6	4,9	4,4	1,2	18																		
		BDMT 170416ER .Y52	17,0	9,6	4,9	4,4	1,6	18																		
		BDMT 170420ER .Y52	17,0	9,6	4,9	4,4	2,0	18																		
		BDMT 170424ER .Y52	17,0	9,6	4,9	4,4	2,4	18																		
BDMT 170431ER .Y52	17,0	9,6	4,9	4,4	3,1	18																				
BDMT 170440ER .Y52	17,0	9,6	4,9	4,4	4,0	18																				
		LNMM 100605 .F56	10	6,5	6,5	3,5	0,5	-																		
		LNMM 151008 .F56	15	10	10	4,5	0,8	-																		
		LNMM 100605 .F61	10	6,5	6,5	3,5	0,5	-																		
		LNMM 151008 .F61	15	10	10	4,5	0,8	-																		
MATERIALE - MATERIAL - MATERIALIEN - MATÉRIAUX										N3015			F3710	T3116	F3120	F4725				F1325	F1335	F4345				
P	ACCIAIO - STEEL - STAHL - ACIER																									
M	ACCIAIO INOX - STAINLESS STEEL - ROSTFREIER STAHL - ACIER INOXYDABLE																									
K	GHISA - CAST IRON - GRAUGUSS - FONTE GRISE																									
N	LEGHE DI ALLUMINIO - ALUMINIUM ALLOYS - ALUMINIUM-LEGIERUNGEN - ALLIAGES D'ALUMINIUM																									
S	LEGHE RESISTENTI AL CALORE - HEAT RESISTANT ALLOYS - WÄRMEBESTÄNDIGE LEGIERUNGEN - ALLIAGES RÉSISTANTES À LA CHALEUR																									
H	MATERIALI DURI E TEMPRATI - HARD AND HARDENED MATERIAL - HARTE UND GEHÄRTETE MATERIALIEN - MATERIAUX DURS ET TREMPÉS																									

■ DISPONIBILI - IN STOCK - LIEFERBAR - DISPONIBLES / ■ NEW
● APPLICAZIONE CONSIGLIATA-RECOMMENDED APPLICATION-
EMPFOLHENER EINSATZ - APPLICATION CONSEILLÉE

□ A RICHIESTA - ON REQUEST - AUF ANFRAGE - SUR DEMANDE / □ NEW
○ APPLICAZIONE POSSIBILE - POSSIBLE APPLICATION -
MÖGLICHE ANWENDUNG - APPLICATION POSSIBLE

LNMT		LNMX		ONMU		HT		HW		HC											
						CERMET		NON RIVESTITI CEMENTED CARBIDE GRADES		RIVESTITI COATED GRADES BESCHICHTET RECOUVERTS											
ART	COD.	l	d	H	s	d1	r			F7810	F2135	F2540 $\leq m/z$	F3120	F4128 $\leq m/z$	F4130	F7530 $\leq m/z$			F1325	F1335	
	LNMT 060312 .X52	6,2	-	10	3,65	3	1,2														
	LNMT 060312 .X56	6,2	-	10	3,65	3	1,2														
	LNMT 060312 .X58	6,2	-	10	3,65	3	1,2														
	LNMX 090708 .F51	9	7,21	-	5	2,5	0,8														
	LNMX 090708 .F58	9	7,21	-	5	2,5	0,8														
	LNMX 131308 .F58	13	13	-	7,00	4,6	0,8														
	LNMX 131308 .F61	13	13	-	7,00	4,6	0,8														
	ONMU 050608SN .F51	5,24	12,7	-	5,8	5,45	0,8														
	ONMU 050608SN .F53	5,24	12,7	-	5,8	5,45	0,8														
	ONMU 050608SN .F55	5,24	12,7	-	5,8	5,45	0,8														
	ONMU 050608SN .F58	5,24	12,7	-	5,8	5,45	0,8														
MATERIALE - MATERIAL - MATERIALIEN - MATÉRIAUX										F7810	F2135	F2540 $\leq m/z$	F3120	F4128 $\leq m/z$	F4130	F7530 $\leq m/z$			F1325	F1335	
P	ACCIAIO - STEEL - STAHL - ACIER																				
M	ACCIAIO INOX - STAINLESS STEEL - ROSTFREIER STAHL - ACIER INOXYDABLE																				
K	GHISA - CAST IRON - GRAUGUSS - FONTE GRISE																				
N	LEGHE DI ALLUMINIO - ALUMINIUM ALLOYS - ALUMINIUM-LEGIERUNGEN - ALLIAGES D'ALUMINIUM																				
S	LEGHE RESISTENTI AL CALORE - HEAT RESISTANT ALLOYS - WÄRMEBESTÄNDIGE LEGIERUNGEN - ALLIAGES RÉISTANTES À LA CHALEUR																				
H	MATERIALI DURI E TEMPRATI - HARD AND HARDENED MATERIAL - HARTE UND GEHÄRTETE MATERIALIEN - MATERIAUX DURS ET TREMPÉS																				

■ DISPONIBILI - IN STOCK - LIEFERBAR - DISPONIBLES / ■ NEW
 ● APPLICAZIONE CONSIGLIATA-RECOMMENDED APPLICATION-
 EMPFOHLENER EINSATZ - APPLICATION CONSEILLÉE

□ A RICHIESTA - ON REQUEST - AUF ANFRAGE - SUR DEMANDE / □ NEW
 ○ APPLICAZIONE POSSIBILE - POSSIBLE APPLICATION -
 MÖGLICHE ANWENDUNG - APPLICATION POSSIBLE

RA			RAET					HT	HW	HC		
	ART	COD.	d	s	d1	H	r	l/a°	CERMET	NON RIVESTITI CEMENTED CARBIDE GRADES	RIVESTITI COATED GRADES BESCHICHTET RECOUVERTS	
 .F42	RA 08.04	.F42	8,0	2,4	2,5	7	4	-			■	
	RA 10.04	.F42	10,0	2,6	3,0	8,5	5	-			■	
	RA 12.04	.F42	12,0	3,0	3,5	10	6	-			■	
	RA 16.04	.F42	16,0	4,0	4,0	12	8	-			■	
	RA 20.04	.F42	20,0	5,0	5,0	15	10	-			■	
	RA 25.04	.F42	25,0	6,0	6,0	18,5	12,5	-			■	
	RA 32.04	.F42	32,0	7,0	8,0	23,5	16	-			■	
 .K32W	RA 08.04	.K32W	8,0	2,4	2,5	7	4	-			■	
	RA 10.04	.K32W	10,0	2,6	3,0	8,5	5	-			■	
	RA 12.04	.K32W	12,0	3,0	3,5	10	6	-			■	
	RA 16.04	.K32W	16,0	4,0	4,0	12	8	-			■	
	RA 20.04	.K32W	20,0	5,0	5,0	15	10	-			■	
	RA 25.04	.K32W	25,0	6,0	6,0	18,5	12,5	-			■	
	RA 32.04	.K32W	32,0	7,0	8,0	23,5	16	-			■	
NEW												
 .F42	RAET 080006	.F42	8,0	2,4	2,5	7,0	0,6	1,6			■	
	RAET 080010	.F42	8,0	2,4	2,5	7,0	1,0	2,0			■	
	RAET 100005	.F42	10,0	2,6	3,0	8,5	0,5	1,5			■	
	RAET 100008	.F42	10,0	2,6	3,0	8,5	0,8	1,8			■	
	RAET 100010	.F42	10,0	2,6	3,0	8,5	1,0	2,0			■	
	RAET 120005	.F42	12,0	3,0	3,5	10,0	0,5	1,5			■	
	RAET 120010	.F42	12,0	3,0	3,5	10,0	1,0	2,0			■	
	RAET 120020	.F42	12,0	3,0	3,5	10,0	2,0	3,0			■	
	RAET 160010	.F42	16,0	4,0	4,0	12,0	1,0	2,0			■	
	RAET 160030	.F42	16,0	4,0	4,0	12,0	3,0	4,0			■	
	RAET 200010	.F42	20,0	5,0	5,0	15,0	1,0	2,0			■	
	RAET 200040	.F42	20,0	5,0	5,0	15,0	4,0	5,0			■	
	RAET 250010	.F42	25,0	6,0	6,0	18,5	1,0	2,0			■	
	RAET 250050	.F42	25,0	6,0	6,0	18,5	5,0	6,0			■	
MATERIALE - MATERIAL - MATERIALIEN - MATÉRIAUX												
P	ACCIAIO - STEEL - STAHL - ACIER										● ●	
M	ACCIAIO INOX - STAINLESS STEEL - ROSTFREIER STAHL - ACIER INOXYDABLE										○ ○	
K	GHISA - CAST IRON - GRAUGUSS - FONTE GRISE										● ●	
N	LEGHE DI ALLUMINIO - ALUMINIUM ALLOYS - ALUMINIUM-LEGIERUNGEN - ALLIAGES D'ALUMINIUM										○	
S	LEGHE RESISTENTI AL CALORE - HEAT RESISTANT ALLOYS - WÄRMEBESTÄNDIGE LEGIERUNGEN - ALLIAGES RÉISTANTES À LA CHALEUR											
H	MATERIALI DURI E TEMPRATI - HARD AND HARDENED MATERIAL - HARTE UND GEHÄRTETE MATERIALIEN - MATERIAUX DURS ET TREMPÉS										● ○	

RDGT RDET RDEW RDHT RDHX		SCMX SDMT						HT	HW	HC							
								CERMET	NON RIVESTITI CEMENTED CARBIDE GRADES	RIVESTITI COATED GRADES BESCHICHTET RECOUVERTS							
ART	COD.	l	d	s	d1	r	a°	N3620	F5105	F3120	T1730	F4140	F4144 EMZ	F2331	F1335	F2335	
.T42	RDGT 1604 MOT .T42 NEW	-	16,0	4,76	5,5	-	15						■				
.T42	RDHX 0501 MOE .T42	-	5,0	1,51	2,2	-	15			■							
	RDHX 07T1 MOT .T42	-	7,0	1,98	2,8	-	15			■							
	RDHX 0702 MOT .T42	-	7,0	2,38	2,8	-	15			■							
	RDHX 1003 MOT .T42	-	10,0	3,18	3,9	-	15			■							
	RDHX 12T3 MOT .T42	-	12,0	3,97	3,9	-	15			■							
	RDHX 1604 MOT .T42	-	16,0	4,76	5,2	-	15			■							
.T56	RDET 1003 MOSN .T56	-	10,0	3,18	4,4	-	15								■		
	RDET 12T3 MOSN .T56	-	12,0	3,97	4,4	-	15								■		
.T56	RDEW 1003 MOSN .T56	-	10,0	3,18	4,4	-	15								■		
	RDEW 12T3 MOSN .T56	-	12,0	3,97	4,4	-	15								■		
	RDEW 1604 MOSN .T56	-	16,0	4,76	5,5	-	15								■		
.T57P	RDHT 07T1 MO .T57P	-	7,0	1,98	2,8	-	15		■								
	RDHT 0702 MO .T57P	-	7,0	2,38	2,8	-	15		■								
	RDHT 1003 MO .T57P	-	10,0	3,18	3,9	-	15		■								
	RDHT 12T3 MO .T57P	-	12,0	3,97	3,9	-	15		■								
	RDHT 1604 MO .T57P	-	16,0	4,76	5,2	-	15		■								
.S52	SCMX 120408 ZN .S52	12,7	12,7	4,76	5,3	0,8	7					■					
.F58	SDMT 1205 PDSR .F58	12,7	12,7	5,0	5,5	0,8	15					■	■			■	
MATERIALE - MATERIAL - MATERIALIEN - MATÉRIAUX								N3620	F5105	F3120	T1730	F4140	F4144 EMZ	F2331	F1335	F2335	
P	ACCIAIO - STEEL - STAHL - ACIER									● ○	● ●	● ●				● ● ○	
M	ACCIAIO INOX - STAINLESS STEEL - ROSTFREIER STAHL - ACIER INOXYDABLE											● ●				● ○ ●	
K	GHISA - CAST IRON - GRAUGUSS - FONTE GRISE									● ●	● ●					○	
N	LEGHE DI ALLUMINIO - ALUMINIUM ALLOYS - ALUMINIUM-LEGIERUNGEN - ALLIAGES D'ALUMINIUM							●				○					
S	LEGHE RESISTENTI AL CALORE - HEAT RESISTANT ALLOYS - WÄRMEBESTÄNDIGE LEGIERUNGEN - ALLIAGES RÉISTANTES À LA CHALEUR											● ○				●	
H	MATERIALI DURI E TEMPRATI - HARD AND HARDENED MATERIAL - HARTE UND GEHÄRTETE MATERIALIEN - MATERIAUX DURS ET TREMPÉS									●							

■ DISPONIBILI - IN STOCK - LIEFERBAR - DISPONIBLES / ■ NEW
 ● APPLICAZIONE CONSIGLIATA-RECOMMENDED APPLICATION-
 EMPFOHLENER EINSATZ - APPLICATION CONSEILLÉE

□ A RICHIESTA - ON REQUEST - AUF ANFRAGE - SUR DEMANDE / □ NEW
 ○ APPLICAZIONE POSSIBILE - POSSIBLE APPLICATION -
 MÖGLICHE ANWENDUNG - APPLICATION POSSIBLE

	SEEX		SEHT SEKT SEKW		SEKX		HT			HW			HC									
							DT63	N3005	N3815	F2135	F2540	F3120	T1120	T528N	F1325	F1335						
ART	COD.		l	d	s	d1	r	a°														
	SEEX 13T3 AGTR .M12		8,2	13,4	3,97	4,1	1,5	20	■		■											
	SEHT 13T3 AZFN .F44P		13,4	13,4	3,97	4,2	-	20			■											
	SEKT 13T3 AFEN .F53		13,4	13,4	3,97	4,2	-	20				■	■									
	SEKT 13T3 AFSN .F58		13,4	13,4	3,97	4,2	-	20						■				■	■			
	SEKW 13T3 AFSN .F51		13,4	13,4	3,97	4,2	-	20							■							
	SEKX 1305 AGSR .Z52		3,9	15,17	5,58	4,1	1,0	20														
MATERIALE - MATERIAL - MATERIALIEN - MATÉRIAUX									DT63		N3005	N3815		F2135	F2540	F3120	T1120	T528N		F1325	F1335	
P	ACCIAIO - STEEL - STAHL - ACIER								●						○	●	●			●	●	
M	ACCIAIO INOX - STAINLESS STEEL - ROSTFREIER STAHL - ACIER INOXYDABLE								●					●	●		●				○	○
K	GHISA - CAST IRON - GRAUGUSS - FONTE GRISE								●	●						●	○				○	
N	LEGHE DI ALLUMINIO - ALUMINIUM ALLOYS - ALUMINIUM-LEGIERUNGEN - ALLIAGES D'ALUMINIUM										●											
S	LEGHE RESISTENTI AL CALORE - HEAT RESISTANT ALLOYS - WÄRMEBESTÄNDIGE LEGIERUNGEN - ALLIAGES RÉSIDANTES À LA CHALEUR													○		○						
H	MATERIALI DURI E TEMPRATI - HARD AND HARDENED MATERIAL - HARTE UND GEHÄRTETE MATERIALIEN - MATERIAUX DURS ET TREMPÉS																					

■ DISPONIBILI - IN STOCK - LIEFERBAR - DISPONIBLES / ■ NEW
● APPLICAZIONE CONSIGLIATA-RECOMMENDED APPLICATION-
EMPFOHLENER EINSATZ - APPLICATION CONSEILLÉE

□ A RICHIESTA - ON REQUEST - AUF ANFRAGE - SUR DEMANDE / □ NEW
○ APPLICAZIONE POSSIBILE - POSSIBLE APPLICATION -
MÖGLICHE ANWENDUNG - APPLICATION POSSIBLE

SNEX	SNCX SNMX		SNCX SNMX					HT	HW	HC							
	ART	COD.	l	d	s	d1	r	a°	CERMET	NON RIVESTITI CEMENTED CARBIDE GRADES	RIVESTITI COATED GRADES BESCHICHTET RECOUVERTS						
									N3815	F2540 $\leq m/z$	T3116	F3120	T1025	T1730	F3010	F1335	
	SNEX 1206NN	.K11	8,5	12,7	6,35	4,5	-	-									
	SNCX 1206ANFN	.F57P	12,7	12,7	6,35	5,4	-	-	■								
	SNMX 1206NN	.F51	12,7	12,7	6,35	5,4	-	-			■	■					
	SNMX 1206NN	.F52	12,7	12,7	6,35	5,4	-	-				■					
	SNMX 1206NN	.F53	12,7	12,7	6,35	5,4	-	-			■						
	SNMX 1206NN	.F58	12,7	12,7	6,35	5,4	-	-				■				■	
	SNMX 1206QNN	.F51	12,7	12,7	6,35	5,4	0,8	-				■	■				
	SNMX 1206QNN	.F53	12,7	12,7	6,35	5,4	0,8	-			■						
	SNMX 1206QNN	.F58	12,7	12,7	6,35	5,4	0,8	-				■				■	
	SNMX 120612	.F51	12,7	12,7	6,35	5,4	1,2	-				■					
	SNMX 120612	.F58	12,7	12,7	6,35	5,4	1,2	-				■				■	
MATERIALE - MATERIAL - MATERIALIEN - MATÉRIAUX									N3815	F2540 $\leq m/z$	T3116	F3120	T1025	T1730	F3010	F1335	
P	ACCIAIO - STEEL - STAHL - ACIER											○	●	●		○	
M	ACCIAIO INOX - STAINLESS STEEL - ROSTFREIER STAHL - ACIER INOXIDABLE										●						○
K	GHISA - CAST IRON - GRAUGUSS - FONTE GRISE											●	●			●	
N	LEGHE DI ALLUMINIO - ALUMINIUM ALLOYS - ALUMINIUM-LEGIERUNGEN - ALLIAGES D'ALUMINIUM								●								
S	LEGHE RESISTENTI AL CALORE - HEAT RESISTANT ALLOYS - WÄRMEBESTÄNDIGE LEGIERUNGEN - ALLIAGES RÉSIDANTES À LA CHALEUR																
H	MATERIALI DURI E TEMPRATI - HARD AND HARDENED MATERIAL - HARTE UND GEHÄRTETE MATERIALIEN - MATÉRIAUX DURS ET TREMPÉS																

■ DISPONIBILI - IN STOCK - LIEFERBAR - DISPONIBLES / ■ NEW
 ● APPLICAZIONE CONSIGLIATA-RECOMMENDED APPLICATION-
 EMPFOHLENER EINSATZ - APPLICATION CONSEILLÉE

□ A RICHIESTA - ON REQUEST - AUF ANFRAGE - SUR DEMANDE / □ NEW
 ○ APPLICAZIONE POSSIBILE - POSSIBLE APPLICATION -
 MÖGLICHE ANWENDUNG - APPLICATION POSSIBLE

SNHX									HT	HW	HC																					
	ART.	COD.	l	d	s	d1	r	a°	CERMET	NON RIVESTITI CEMENTED CARBIDE GRADES	RIVESTITI COATED GRADES BESCHICHTET RECOUVERTS																					
									T115			T5020	T528N								F1035											
 F M R .Z47	SNHX 1102	.Z47	11,0	11,0	2,3	4,4	-	-		■																						
	SNHX 1103	.Z47	11,0	11,0	2,7	4,4	-	-		■																						
	SNHX 1203	.Z47	12,7	12,7	3,2	5,0	-	-		■																						
	SNHX 1204	.Z47	12,7	12,7	4,0	5,0	-	-		■																						
	SNHX 12045	.Z47	12,7	12,7	4,5	5,0	-	-		■																						
	SNHX 1205	.Z47	12,7	12,7	5,4	5,0	-	-		■																						
	SNHX 1207	.Z47	12,7	12,7	7,0	5,0	-	-		■																						
 F M R .Z52	SNHX 1102	.Z52	11,0	11,0	2,3	4,4	-	-					■	■																		
	SNHX 1103	.Z52	11,0	11,0	2,7	4,4	-	-					■	■																		
	SNHX 1203	.Z52	12,7	12,7	3,2	5,0	-	-					■	■																		
	SNHX 1204	.Z52	12,7	12,7	4,0	5,0	-	-					■	■																		
	SNHX 12045	.Z52	12,7	12,7	4,5	5,0	-	-					■	■																		
	SNHX 1205	.Z52	12,7	12,7	5,4	5,0	-	-					■	■																		
	SNHX 1207	.Z52	12,7	12,7	7,0	5,0	-	-					■	■																		
 F M R .Z62	SNHX 1102	.Z62	11,0	11,0	2,3	4,4	-	-																						■		
	SNHX 1103	.Z62	11,0	11,0	2,7	4,4	-	-																						■		
	SNHX 1203	.Z62	12,7	12,7	3,2	5,0	-	-																						■		
	SNHX 1204	.Z62	12,7	12,7	4,0	5,0	-	-																						■		
	SNHX 12045	.Z62	12,7	12,7	4,5	5,0	-	-																						■		
	SNHX 1205	.Z62	12,7	12,7	5,4	5,0	-	-																						■		
	SNHX 1207	.Z62	12,7	12,7	7,0	5,0	-	-																						■		
MATERIALE - MATERIAL - MATERIALIEN - MATÉRIAUX									T115			T5020	T528N									F1035										
P	ACCIAIO - STEEL - STAHL - ACIER												●	○																	●	
M	ACCIAIO INOX - STAINLESS STEEL - ROSTFREIER STAHL - ACIER INOXYDABLE													●																		
K	GHISA - CAST IRON - GRAUGUSS - FONTE GRISE									●			●																			
N	LEGHE DI ALLUMINIO - ALUMINIUM ALLOYS - ALUMINIUM-LEGIERUNGEN - ALLIAGES D'ALUMINIUM									●																						
S	LEGHE RESISTENTI AL CALORE - HEAT RESISTANT ALLOYS - WÄRMEBESTÄNDIGE LEGIERUNGEN - ALLIAGES RÉSISTANTES À LA CHALEUR													○																		
H	MATERIALI DURI E TEMPRATI - HARD AND HARDENED MATERIAL - HARTE UND GEHÄRTETE MATERIALIEN - MATERIAUX DURS ET TREMPÉS																															

■ DISPONIBILI - IN STOCK - LIEFERBAR - DISPONIBLES / ■ NEW
 ● APPLICAZIONE CONSIGLIATA-RECOMMENDED APPLICATION-
 EMPFOHLENER EINSATZ - APPLICATION CONSEILLÉE

□ A RICHIESTA - ON REQUEST - AUF ANFRAGE - SUR DEMANDE / □ NEW
 ○ APPLICAZIONE POSSIBILE - POSSIBLE APPLICATION -
 MÖGLICHE ANWENDUNG - APPLICATION POSSIBLE

SPMT SPMW		TCMT TCMX							HT	HW	HC											
									CERMET	NON RIVESTITI CEMENTED CARBIDE GRADES	RIVESTITI COATED GRADES BESCHICHTET RECOUVERTS											
ART.	COD.	l	d	s	d1	r	a°	C4010	T120	F2425	F2435	T1415	T3115	T3220	T1425	T528N	T1130 <small>NEW</small>	F4140	T1435	T540		
	SPMT 060304 .N54	6,35	6,35	3,18	2,8	0,4	11															
	SPMT 09T308 .N54	9,52	9,52	3,97	4,5	0,8	11															
	SPMT 120408 .N54	12,7	12,7	4,76	5,5	0,8	11															
	SPMW 060304 .N51	6,35	6,35	3,18	2,8	0,4	11															
	SPMW 09T308 .N51	9,52	9,52	3,97	4,5	0,8	11															
	SPMW 120408 .N51	12,7	12,7	4,76	5,5	0,8	11															
	SPMW 060304 .N59	6,35	6,35	3,18	2,8	0,4	11															
	SPMW 09T308 .N59	9,52	9,52	3,97	4,5	0,8	11															
	SPMW 120408 .N59	12,7	12,7	4,76	5,5	0,8	11															
	TCMT 110204 .G39	11,0	6,35	2,38	2,8	0,4	11	■														
	TCMT 110202 .S42	11,0	6,35	2,38	2,8	0,2	7														■	
	TCMT 110204 .S42	11,0	6,35	2,38	2,8	0,4	7		■												■	
	TCMT 16T304 .S42	16,5	9,52	3,97	4,4	0,4	7		■													
	TCMT 16T308 .S42	16,5	9,52	3,97	4,4	0,8	7		■												■	
	TCMT 220404 .S42	22,0	12,7	4,76	5,6	0,4	7		■													
	TCMT 110204 .G52	11,0	6,35	2,38	2,8	0,4	7			■	■	■	■	■							■	
	TCMT 110208 .G52	11,0	6,35	2,38	2,8	0,8	7			■	■	■	■	■							■	
	TCMT 16T304 .G52	16,5	9,52	3,97	4,4	0,4	7			■			■	■							■	
	TCMT 16T308 .G52	16,5	9,52	3,97	4,4	0,8	7			■			■	■							■	
	TCMT 16T312 .G52	16,5	9,52	3,97	4,4	1,5	7			■				■								
	TCMT 220408 EN .E52	22,0	12,7	4,76	5,6	0,8	7														■	
	NEW																					
	TCMX 16T308ZN .S52	16,5	9,52	3,97	4,4	0,8	7														■	
MATERIALE - MATERIAL - MATERIALIEN - MATÉRIAUX								C4010	T120	F2425	F2435	T1415	T3115	T3220	T1425	T528N	T1130 <small>NEW</small>	F4140	T1435	T540		
P	ACCIAIO - STEEL - STAHL - ACIER							●			○	○	●	○	○	○	○	○	○	○	○	○
M	ACCIAIO INOX - STAINLESS STEEL - ROSTFREIER STAHL - ACIER INOXYDABLE							●	○	●	●				○	○	○	○	○	○	○	○
K	GHISA - CAST IRON - GRAUGUSS - FONTE GRISE							○	●				○	○	○							
N	LEGHE DI ALLUMINIO - ALUMINIUM ALLOYS - ALUMINIUM-LEGIERUNGEN - ALLIAGES D'ALUMINIUM								○													○
S	LEGHE RESISTENTI AL CALORE - HEAT RESISTANT ALLOYS - WÄRMEBESTÄNDIGE LEGIERUNGEN - ALLIAGES RÉISTANTES À LA CHALEUR								○							○	○					○
H	MATERIALI DURI E TEMPRATI - HARD AND HARDENED MATERIAL - HARTE UND GEHÄRTETE MATERIALIEN - MATERIAUX DURS ET TREMPÉS																					

■ DISPONIBILI - IN STOCK - LIEFERBAR - DISPONIBLES / **NEW**
 ● APPLICAZIONE CONSIGLIATA-RECOMMENDED APPLICATION-
 EMPFOHLENER EINSATZ - APPLICATION CONSEILLÉE

□ A RICHIESTA - ON REQUEST - AUF ANFRAGE - SUR DEMANDE / **NEW**
 ○ APPLICAZIONE POSSIBILE - POSSIBLE APPLICATION -
 MÖGLICHE ANWENDUNG - APPLICATION POSSIBLE

TNGX	60°		TOKX		HT		HW		HC								
	CERMET		NON RIVESTITI CEMENTED CARBIDE GRADES		RIVESTITI COATED GRADES BESCHICHTET RECOUVERTS												
ART.	COD.	l	d	s	d1	r	a°	N3620	T2035	F2635	F4635	F5105	F3110 $\leq m/z$	T5130	F2330	F2335	
 .X42	TNGX 060404 .X42	11	6,35	3,42	2,8	0,4	-					■			■	■	
	TNGX 060408 .X42	11	6,35	3,42	2,8	0,8	-					■			■	■	
	TNGX 100604 .X42	16,5	9,52	6,58	4,4	0,4	-					■			■	■	
	TNGX 100608 .X42	16,5	9,52	6,58	4,4	0,8	-					■			■	■	
 .X51	TNGX 060408 .X51	11	6,35	3,42	2,8	0,8	-					■					
	TNGX 100608 .X51	16,5	9,52	6,58	4,4	0,8	-					■					
 .X54	TNGX 060404 .X54	11	6,35	3,42	2,8	0,4	-					■			■	■	
	TNGX 060408 .X54	11	6,35	3,42	2,8	0,8	-					■			■	■	
	TNGX 100608 .X54	16,5	9,52	6,58	4,4	0,8	-					■			■	■	
	TNGX 100616 .X54	16,5	9,52	6,58	4,4	1,6	-					■			■	■	
 .X57P	TNGX 100608 .X57P	16,5	9,52	6,58	4,4	0,8	-	■									
	NEW																
 .G52	TOKX 09T308PDER .G52	13	9,58	3,85	3,35	0,8	12			■			■				
	TOKX 09T316PDER .G52	13	9,58	3,85	3,35	1,6	12			■			■				
 .G53	TOKX 09T308PDER .G53	13	9,58	3,85	3,35	0,8	12		■	■							
	TOKX 09T316PDER .G53	13	9,58	3,85	3,35	1,6	12		■	■							
MATERIALE - MATERIAL - MATERIALIEN - MATÉRIAUX								N3620	T2035	F2635	F4635	F5105	F3110 $\leq m/z$	T5130	F2330	F2335	
P	ACCIAIO - STEEL - STAHL - ACIER									○	●	○	●	○		○	○
M	ACCIAIO INOX - STAINLESS STEEL - ROSTFREIER STAHL - ACIER INOXYDABLE									●	●	○	○	○		●	●
K	GHISA - CAST IRON - GRAUGUSS - FONTE GRISE										○	○	●	○		○	
N	LEGHE DI ALLUMINIO - ALUMINIUM ALLOYS - ALUMINIUM-LEGIERUNGEN - ALLIAGES D'ALUMINIUM							●									
S	LEGHE RESISTENTI AL CALORE - HEAT RESISTANT ALLOYS - WÄRMEBESTÄNDIGE LEGIERUNGEN - ALLIAGES RÉSISTANTES À LA CHALEUR									●		○				○	○
H	MATERIALI DURI E TEMPRATI - HARD AND HARDENED MATERIAL - HARTE UND GEHÄRTETE MATERIALIEN - MATERIAUX DURS ET TREMPÉS																

VDKT VCKT	WNMT		WPMT WPMW			HT			HW			HC							
	CERMET		NON RIVESTITI CEMENTED CARBIDE GRADES			RIVESTITI COATED GRADES BESCHICHTET RECOUVERTS													
ART	COD.		l	d	s	d1	r	a°	T110			F4130 T5530 <small>≤mz</small> F4140			T5120				
.K57P	VDKT 11T210 N .K57P		11	6,35	2,87	2,8	1	7	■										
.K57P	VCKT 220530 .K57P		20,1	12,7	5,56	5,6	3,0	15	■										
.X52	WNMT 140525 .X52		7	13,7	5,5	4,9	2,5	-				■						■	
.N42	WPMT 06X415 ZSR .N42		6	9,52	4,20	4,3	1,5	11											
.N42	WPMT 080615 ZSR .N42		8	12,7	6,35	5,4	1,5	11											
.N52	WPMW 06X415 ZSR .N52		6	9,52	4,20	4,3	1,5	11										■	
.N52	WPMW 080615 ZSR .N52		8	12,7	6,35	5,4	1,5	11											
MATERIALE - MATERIAL - MATERIALIEN - MATÉRIAUX									T110			F4130 T5530 <small>≤mz</small> F4140			T5120				
P	ACCIAIO - STEEL - STAHL - ACIER												●	●	●				●
M	ACCIAIO INOX - STAINLESS STEEL - ROSTFREIER STAHL - ACIER INOXIDABLE												●	○	●				
K	GHISA - CAST IRON - GRAUGUSS - FONTE GRISE									○			○	●	○				●
N	LEGHE DI ALLUMINIO - ALUMINIUM ALLOYS - ALUMINIUM-LEGIERUNGEN - ALLIAGES D'ALUMINIUM									●									
S	LEGHE RESISTENTI AL CALORE - HEAT RESISTANT ALLOYS - WÄRMEBESTÄNDIGE LEGIERUNGEN - ALLIAGES RÉSIDANTES À LA CHALEUR													○	○				
H	MATERIALI DURI E TEMPRATI - HARD AND HARDENED MATERIAL - HARTE UND GEHÄRTETE MATERIALIEN - MATÉRIAUX DURS ET TREMPÉS													○				○	

■ DISPONIBILI - IN STOCK - LIEFERBAR - DISPONIBLES / ■ NEW
● APPLICAZIONE CONSIGLIATA-RECOMMENDED APPLICATION-
EMPFÖHLENER EINSATZ - APPLICATION CONSEILLÉE

□ A RICHIESTA - ON REQUEST - AUF ANFRAGE - SUR DEMANDE / □ NEW
○ APPLICAZIONE POSSIBILE - POSSIBLE APPLICATION -
MÖGLICHE ANWENDUNG - APPLICATION POSSIBLE

SCELTA VELOCE QUICK PICK

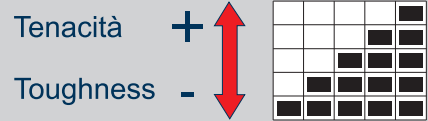

- METODO PER LA SCELTA VELOCE DEL GRADO DI METALLO DURO PIÙ IDONEO. CONTARE IL NUMERO DI RETTANGOLI COLORATI
- METHOD FOR A QUICK CHOICE OF THE MOST SUITABLE SOLID CARBIDE GRADE. COUNT THE NUMBER OF COLORED RECTANGLES
- METHODE ZUR RASCHEN AUSWAHL DER GEEIGNETSTEN HARTMETALLSORTE. DIE ANZAHL DER BUNTEN RECH TECKEZAHLLEN
- METHODE POUR CHOISIR RAPIDEMENT LE DEGRÉ LE PLUS APPROPRIÉ DU METAL DUR. COMPTEZ LES RECTANGLES EN COULEURS
- METODO PARA LA ELECCION RAPIDA DE EL GRADO MAS ADECUADO DE METAL DURO. CONTAR LOS NUMEROS DE RECTANGULOS COLORAEDOS

- GRADO MOLTO RESISTENTE ALL'USURA, SOLO PER FINITURA, LAVORAZIONI AD ALTE VELOCITÀ DI TAGLIO E CONDIZIONI MOLTO RIGIDE E STABILI
- GRADE WITH HIGH RESISTANCE TO WEAR; ONLY FOR FINISHING, MACHINING AT HIGH CUTTING SPEEDS, AND VERY RIGID AND STABLE CONDITIONS
- GRADO CON ALTA RESISTENZA ALL'USURA, DISCRETA TENACITÀ PER LAVORAZIONI A VELOCITÀ MEDIO ALTE ED AVANZAMENTI MEDI, IN CONDIZIONI NORMALI
- GRADE WITH HIGH RESISTANCE TO WEAR, GOOD TOUGHNESS, FOR MEDIUM-HIGH MACHINING AND MEDIUM FEED UNDER NORMAL CONDITIONS
- GRADO CON BUONA RESISTENZA ALL'USURA UNITA A BUONA TENACITÀ, PER LAVORAZIONI GENERICHE IN CONDIZIONI NORMALI
- GRADE WITH GOOD RESISTANCE TO WEAR; COMBINED WITH A GOOD DEGREE OF TOUGHNESS, FOR GENERAL MACHINING UNDER NORMAL CONDITIONS
- GRADO CON OTTIMA TENACITÀ PER LAVORAZIONI MEDIO PESANTI O IN CONDIZIONI POCO STABILI
- GRADE WITH EXCELLENTE TOUGHNESS, FOR MEDIUM HEAVY MACHINING OR MACHINING UNDER CONDITIONS OF LOW STABILITY
- GRADO CON ECCEZIONALE TENACITÀ PER LAVORAZIONI PESANTI CON BASSE VELOCITÀ DI TAGLIO, ALTI AVANZAMENTI O IN CONDIZIONI SFAVOREVOLI
- GRADE WITH EXCELLENTE TOUGHNESS, FOR HEAVY MACHINING WITH LOW CUTTING SPEEDS, HIGH FEED, OR UNDER UNFAVORABLE CONDITIONS

GUIDA FACILE EASY GUIDE

SAU QUALITY TOOLS ENGINEERING

APKT 1604 PDTR .S54 - T525

APKT 1604 PDTR .S54 T525

F	M	R	●	P	Vc = 100-200 m/min
			○	M	Vc = 90-160 m/min
				K	Vc = 120-250 m/min
				N	
				S	
				H	

fz = 0,1-0,3 mm

P15-35 / M20-35/ K30-40

T525

- GUIDA ALL'USO DELL'INSERTO. PRESENTE ANCHE SU OGNI ETICHETTA
- GUIDE FOR THE USE OF THE INSERT. ALSO LISTED ON EACH LABEL
- LEITFADEN ZUR VERWENDUNG DER WENDEPLATTE, AUCH AUF JEDEM AUFKLEBER VORHANDEN
- INSTRUCTIONS POUR L'UTILISATION DE LA PLAQUETTE. SE TROUVANT EGALEMENT SUR CHAQUE ETIQUETTE
- GUIA POR EL UTILIZO DE LA PLAQUITA, PRESENTE TAMBIEN EN CADA ETIQUETA

GR. VDI 3323	6	P	= ACCIAIO BASSO LEGATO HB 180	= LOW STEEL ALLOY
	14.1	M	= ACCIAIO INOSSIDABILE AUSTENITICO HB 180	= AUSTENITIC STAINLESS STEEL HB 180
	16	K	= GHISA GRIGIA HB 260	= GRAY CAST IRON HB 260
	21	N	= LEGHE DI ALLUMINIO HB 60	= ALUMINUM ALLOYS HB 60
	33	S	= LEGHE RESISTENTI AL CALORE (INCONEL) HB 250	= HEAT RESISTANT ALLOYS (INCONEL) HB 250
MATERIALI MATERIALS	38	H	= ACCIAIO TEMPRATO HRC 55	= TEMPERED STEEL HRC 55
Pag. 1199				

- | | | |
|---|---------------------------------------|---------------------------------|
| F | = FINITURA, LAVORAZIONI LEGGERE | = FINISHING, LIGHT MACHINING |
| M | = LAVORAZIONI MEDIE, IMPIEGO GENERICO | = MEDIUM MACHINING, GENERAL USE |
| R | = SGROSSATURA, LAVORAZIONI PESANTI | = ROUGHING, HEAVY MACHINING |

- | | | |
|------------|-----------------------------|---------------------------|
| fn (mm) | = AVANZAMENTO PER TORNITURA | = FEED FOR TURNING |
| fz (mm/z) | = AVANZAMENTO PER FRESATURA | = FEED FOR MILLING |
| Vc (m/min) | = VELOCITÀ DI TAGLIO | = CUTTING SPEED |
| ● | = APPLICAZIONE CONSIGLIATA | = RECOMMENDED APPLICATION |
| ○ | = APPLICAZIONE POSSIBILE | = POSSIBLE APPLICATION |

COME SCEGLIERE I PARAMETRI DI LAVORO
HOW TO CHOOSE CUTTING DATA
EINSTELLUNG DER SCHNITTDATEN
COMMENT CHOISIR LES PARAMETRES DE SERVICE

FASE 1 - PHASE 1

SCELTA GR. VDI IN FUNZIONE DEL MATERIALE
 CHOICE OF VDI GR. DEPENDING ON MATERIAL
 WAHL VDI-SORTE JE NACH WERKSTOFF
 CHOIX GR. VDI EN FONCTION DU MATERIEL

Tabella comparativa dei materiali - Materials comparison table
 Material vergleichstabelle - Tableau comparatif des matériaux

UNI	WISTOFF	DIN	SAISI	BS	AFNOR	JIS	kt,1	mc	VDI 3323 GR.
ACCIAIO NON LEGATO RICOTTO ANNEALED NOT-ALLOY STEEL									
C < 0,15% 125 HB									
CF 10 SPr 20	1.0722	10 SPr 20	11 L 08	-	10 PrF 2	-	SUM22	1350	0,22
CF 9 SPr 28	1.0715	9 SPr 28	1213	220 M 07	S 250	-	SUM22	1350	0,22
CF 8 SPr 36	1.0706	8 SPr 36	1215	240 M 07	S 300	-	SUM22	1350	0,22
CF 7 SPr 45	1.0701	7 SPr 45	12 L 13	12 L 13	S 350 Pb	-	SUM22	1350	0,22
CF 6 SPr 55	1.0692	6 SPr 55	12 L 14	1015	AF 37 C 12, XC 18	-	SUM22	1350	0,22
C15 C16	1.0401	C 15	1015	080 M 15	AF 37 C 12, XC 18	-	SUM22	1350	0,22
C20 C21	1.0402	C 20	1020	080 A 20	AF 43 C 20	-	SUM22	1350	0,22
C25 C26	1.1141	Ck 15	1015	080 M 15	XC 15, XC 18	-	SUM22	1350	0,22
ACCIAIO NON LEGATO RICOTTO ANNEALED NOT-ALLOY STEEL									
C 0,15-0,55% 180 HB									
-	-	28 Mh 6	1330	150 M 28	20 M 5	-	SUM22	1350	0,22
-	-	35 S 20	1140	212 M 36	35 M 4	-	SUM22	1350	0,22
-	-	38 Mh 5	-	-	-	-	SUM22	1350	0,22
-	-	40 Mh 4	1039	150 M 36	35 M 5	-	SUM22	1350	0,22
-	-	45 C 45	1045	080 M 45	AF 55 C 45	-	SUM22	1350	0,22
-	-	50 C 50	1049	080 M 49	XC 42	-	SUM22	1350	0,22
-	-	55 C 55	1045	080 M 45	XC 42	-	SUM22	1350	0,22
-	-	60 C 60	1045	080 M 45	XC 42	-	SUM22	1350	0,22
ACCIAIO NON LEGATO RICOTTO ANNEALED NOT-ALLOY STEEL									
C 0,15-0,55% 250 HB									
-	-	35 S 20	1330	150 M 35	35 M 5	-	SUM22	1350	0,22
-	-	38 Mh 5	1140	212 M 36	35 M 4	-	SUM22	1350	0,22
-	-	40 Mh 4	1039	150 M 36	35 M 5	-	SUM22	1350	0,22
-	-	45 C 45	1035	080 A 35	AF 55 C 35	-	SUM22	1350	0,22
-	-	50 C 50	1045	080 M 45	AF 55 C 45	-	SUM22	1350	0,22
-	-	55 C 55	1045	080 M 45	XC 42	-	SUM22	1350	0,22
-	-	60 C 60	1045	080 M 45	XC 42	-	SUM22	1350	0,22
ACCIAIO NON LEGATO RICOTTO ANNEALED NOT-ALLOY STEEL									
C > 0,55% 300 HB									
C 38 KU	1.1545	C 105 W1	W 110	-	Y1 105	-	SK3	1600	0,24
C 55	1.0535	C 125 W	W 112	-	Y2 120	-	SK2	1600	0,24
C 60	1.0501	C 60	1060	070 M 55	CC 55	-	SS5C	1600	0,24
C 65	1.1274	Ck 101	1095	080 A 96	SUP4	-	SS5C	1600	0,24
C 50	1.1203	Ck 55	1056	070 M 55	XC 55	-	SS5C	1600	0,24
C 60	1.1221	Ck 60	1060	080 A 62	XC 60	-	SS5C	1600	0,24
C 60	1.5710	38 NiCr 6	3135	640 A 35	35 NC 6	-	SNC236	1600	0,24
C 60	1.5120	38 NiCr 4	3015	640 A 35	35 NC 6	-	SNC236	1600	0,24
ACCIAIO NON LEGATO RICOTTO ANNEALED NOT-ALLOY STEEL									
C > 0,55% 300 HB									
C 38 KU	1.1545	C 105 W1	W 110	-	Y1 105	-	SK3	1700	0,24
C 55	1.0535	C 125 W	W 112	-	Y2 120	-	SK2	1700	0,24
C 60	1.0501	C 60	1060	070 M 55	CC 55	-	SS5C	1700	0,24
C 65	1.1274	Ck 101	1095	080 A 96	SUP4	-	SS5C	1700	0,24
C 50	1.1203	Ck 55	1056	070 M 55	XC 55	-	SS5C	1700	0,24
C 60	1.1221	Ck 60	1060	080 A 62	XC 60	-	SS5C	1700	0,24
C 60	1.5710	38 NiCr 6	3135	640 A 35	35 NC 6	-	SNC236	1700	0,24
C 60	1.5120	38 NiCr 4	3015	640 A 35	35 NC 6	-	SNC236	1700	0,24
ACCIAIO DEBOLMENTE LEGATO RICOTTO ANNEALED LOW ALLOY STEEL									
180 HB									
107 WCr 5	1.2607	100Cr 6	L 3	BL 3	100 C 6	-	SK52-2K53	1700	0,24
14 CrAl 4 5	1.2419	105 WCr 6	105 WCr 6	105 WCr 6	105 WCr 13	-	SK52-2K53	1700	0,24
14 Ni 6	1.7380	12 CrAl 9 10	A 182-F22	1501-822 Cr-11	10 CD 9 10	-	SK52-2K53	1700	0,24
16 NiCr 11	1.7336	13 CrAl 4 4	A 182-F11	1501-822 Cr-27	15 CD 3 5	-	SK52-2K53	1700	0,24
16 NiCr 11	1.7715	14 MoV 6 3	A 350-LF 5	1503-850-440	-	-	SK52-2K53	1700	0,24
16 NiCr 11	1.5922	14 Ni 6	-	-	16 N 6	-	SK52-2K53	1700	0,24
16 NiCr 11	1.5732	14 NiCr 10	3415	832 M 13	14 NC 11	-	SNC415H	1700	0,24
16 NiCr 11	1.5732	14 NiCr 14	3310-3514	832 M 13	12 NC 15	-	SNC415H	1700	0,24
16 NiCr 11	1.6557	14 NiCrMo 34	3015	832 M 13	12 C 3	-	SNC415H	1700	0,24
16 NiCr 11	1.7015	15 Cr 3	3015	832 M 15	12 C 3	-	SNC415H	1700	0,24

FASE 2 - PHASE 2

SCELTA INSERTO IN FUNZIONE DEL MATERIALE
 CHOICE OF INSERT DEPENDING ON MATERIAL
 WAHL DER WENDEPLATTE JE NACH WERKSTOFF
 CHOIX PLAQUETTE EN FONCTION DU MATERIEL

Fresatura - Milling - Fräsen - Fraiseage - Fresado

SEKX	SEKX	SEKX	SEKX	SEKX	SEKX	SEKX	SEKX	SEKX	SEKX
SEKT 13T3 AF S	SEKT 13T3 AFEN F44P	SEKT 13T3 AFEN F53	SEKT 13T3 AFEN F51	SEKT 13T3 AFEN F51	SEKT 13T3 AFEN F51	SEKT 13T3 AFEN F51	SEKT 13T3 AFEN F51	SEKT 13T3 AFEN F51	SEKT 13T3 AFEN F51
F58	F2140	F3120	T1120	T1528N	F2140	F3120	T1120	T1528N	F2140

COME SCEGLIERE I PARAMETRI DI LAVORO
HOW TO CHOOSE CUTTING DATA
EINSTELLUNG DER SCHNITTDATEN
COMMENT CHOISIR LES PARAMETRES DE SERVICE

FASE 3 - PHASE 3

SCelta VELOCE DEI PARAMETRI
 QUICK CHOICE OF PARAMETERS
 SCHNELLWAHL DER PARAMETER
 TRIAGE RAPIDE DES PARAMÈTRES

SAU
 SCELTA VELOCE - QUICK PICK
 COD. P M K N S H
 SEKX 1313 AG7R M10
 SEKT 1313 AG7R FAF
 SEKT 1313 AF5N F10
 SEKT 1313 AF5N F30
 SEKT 1313 AF5N F38
 SEKW 1313 AF5N F31
 SEKX 1305 AG5R Z52

PROFONDITÀ MASSIMA DI LAVORO = 2 (mm) PER ALTI AVANZAMENTI
 PROFONDITÀ MASSIMA DI LAVORO = 6 (mm) PER AVANZAMENTI STANDARD

Vc m/min 500

ae/D 0,5-1 0,2 0,1
 50-100% 1 20% 10% 5%

Vc (min) ----- Vc (max)

401

FASE 4 - PHASE 4

SCelta DI VC IN FUNZIONE DEL GR. VDI
 CHOICE OF VC DEPENDING ON VDI GR.
 WAHL VC JE NACH WERKSTOFF
 CHOIX DE VC EN FONCTION DU GR. VDI

SAU
 Vc(m/min)
 T1120 T3220 F3420 T5020 T1025 T1425 F4725 T526 T528N



VDI	HB	T1120	T3220	F3420	T5020	T1025	T1425	F4725	T526	T528N
1	125	190-290	200-340	200-340	190-290	120-240	170-240	120-290	130-300	160-260
2	180	190-290	200-340	200-340	190-290	120-240	170-240	120-290	110-320	130-220
3	250	190-290	200-340	200-340	190-290	110-190	170-240	120-290	90-280	90-160
4	220	190-290	200-340	200-340	190-290	110-190	170-240	120-290	100-280	100-200
5	300	190-290	200-340	200-340	190-290	110-190	170-240	120-290	80-250	150-220
10	200	140-210	150-290	150-290	150-290	100-220	100-190	120-250	60-210	110-190
11	350	140-210	150-290	150-290	150-290	100-220	100-190	120-250	60-210	110-190
12	200	110-170	150-290	150-290	150-290	100-220	100-190	120-250	60-210	110-190
13	330	110-170	150-290	150-290	150-290	100-220	100-190	120-250	60-210	110-190
14.1	180		150-290	150-290	150-290	100-220	100-190	120-250	110-200	120-180
14.2	230-280		150-290	150-290	150-290	100-220	100-190	120-250	110-200	120-180
16	180	180-300	180-300	150-400	150-290	130-210	130-210	120-250	120-220	160-220
17	180	130-250	140-230	200-450	180-350	100-250	120-240	120-240	80-170	120-180
18	250	100-200	140-250	200-450	180-340	100-250	120-240	120-240	70-180	90-180
19	130	100-320	110-220	200-550	180-340	100-250	120-240	120-240	70-180	90-180
20	230	120-250	110-220	200-550	150-300	100-250	120-240	120-240	70-180	80-160
21	60									
22	100									
23	75									
24	90									
25	130									
26	110									
27	90									
28	100									
29										
30										
31	200								80-90	40-70
32	280								80-90	35-60
33	290									30-50
34	350									30-50
36	320									40-50
38	400									60-80
37	100-1050									
39	65Hrc									
40	400									70-130
41	65Hrc									

502



PANORAMICA QUALITÀ DI FRESATURA
 GENERAL VIEW OF THE MILLING GRADE
 FRÄSSORTEN-ÜBERSICHT
 VUE D' ENSEMBLE QUALITÉ DE FRAISAGE
 VISTA GENERAL DE LA CALIDAD DE FRESADO

DIN ISO 513	P ACCIAI STEELS STAHL ACIERS					M ACCIAI INOSSIDABILI STAINLESS STEELS ROSTFREIER STAHL ACIER INOXYDABLE				K GHISE CAST IRON GRAUGUSS FONTE GRISE					N NON FERROSI NONFERROUS NICHTEISENMA PAS FERREUX				S MAT.DIFFICILI DIFFICULT MATERIAL SCHWIERIGE MATERIILIEN MAT.DIFICILES					H MATERIALI DURI HARD MATERIALS HARTE MATERIILIEN MATERIAUX DURS																																																																																
	01	10	20	30	40	50	10	20	30	40	01	10	20	30	40	01	10	20	30	01	10	20	30	40	01	10	20	30																																																																												
HT	C4010 DT63					C4010 DT63				C4010 DT63																																																																																														
HW						T120				N3005 T110 T115 T120 N3440					N3015 N3815 N6315 N3620 N3440				N3015																																																																																					
HC	F5105 F7810 T1415 F6315 F7115 T1120 F3120 T3220 T5020 T5120 T525 T1025 F1325 T1425 F2425 F4725 T526 T528N NEW F4128 T530 T1130 T1730 F2330 F4130 T5130 NEW T5530 F7530 F2331 F1035 F1335 T1435 T2035 F2335 F2435 F2635 F4635 T540 F4140 F4340 T544 F4144 F4345					F7810 F6315 F7115 T525 F1325 T1425 F4725 T526 T528N F4128 T530 F2330 F4130 T5130 T5530 F7530 F1035 F1335 T1435 F2135 F2335 F2435 F2635 F4635 T540 F4140 F4340 T544 F4144 F4345				F5105 F3010 NEW F3110 F3710 F7810 T1415 T3115 F6315 F7115 NEW T516 T3116 F3120 T3220 T5020 T5120 T525 F1325 T1425 F2425 T526 T528N T528N T530 T5130 T5530 F7530 F2331 F1035 F1335 T1435 F2135 F2335 F2435 F2635 F4635 T540 F4140 F4340 T544 F4144 F4345					F5105 F3710 F7810 T1415 T3115 F6315 F7115 NEW T516 T3116 F3120 T3220 T5020 T5120 T525 F1325 T1425 F2425 T526 T528N T528N T530 T5130 T5530 F7530 F2331 F1035 F1335 T1435 F2135 F2335 F2435 F2635 F4635 T540 F4140 F4340 T544 F4144 F4345				F5105 F7810 F3710 F7810 T1415 T3115 F6315 F7115 NEW T516 T3116 F3120 T3220 T5020 T5120 T525 F1325 T1425 F2425 T526 T528N T528N T530 T5130 T5530 F7530 F2331 F1035 F1335 T1435 F2135 F2335 F2435 F2635 F4635 T540 F4140 F4340 T544 F4144 F4345					F5105 F7810 F3710 F7810 T1415 T3115 F6315 F7115 NEW T516 T3116 F3120 T3220 T5020 T5120 T525 F1325 T1425 F2425 T526 T528N T528N T530 T5130 T5530 F7530 F2331 F1035 F1335 T1435 F2135 F2335 F2435 F2635 F4635 T540 F4140 F4340 T544 F4144 F4345				F5105 F7810 F3710 F7810 T1415 T3115 F6315 F7115 NEW T516 T3116 F3120 T3220 T5020 T5120 T525 F1325 T1425 F2425 T526 T528N T528N T530 T5130 T5530 F7530 F2331 F1035 F1335 T1435 F2135 F2335 F2435 F2635 F4635 T540 F4140 F4340 T544 F4144 F4345					F5105 F7810 F3710 F7810 T1415 T3115 F6315 F7115 NEW T516 T3116 F3120 T3220 T5020 T5120 T525 F1325 T1425 F2425 T526 T528N T528N T530 T5130 T5530 F7530 F2331 F1035 F1335 T1435 F2135 F2335 F2435 F2635 F4635 T540 F4140 F4340 T544 F4144 F4345				F5105 F7810 F3710 F7810 T1415 T3115 F6315 F7115 NEW T516 T3116 F3120 T3220 T5020 T5120 T525 F1325 T1425 F2425 T526 T528N T528N T530 T5130 T5530 F7530 F2331 F1035 F1335 T1435 F2135 F2335 F2435 F2635 F4635 T540 F4140 F4340 T544 F4144 F4345					F5105 F7810 F3710 F7810 T1415 T3115 F6315 F7115 NEW T516 T3116 F3120 T3220 T5020 T5120 T525 F1325 T1425 F2425 T526 T528N T528N T530 T5130 T5530 F7530 F2331 F1035 F1335 T1435 F2135 F2335 F2435 F2635 F4635 T540 F4140 F4340 T544 F4144 F4345				F5105 F7810 F3710 F7810 T1415 T3115 F6315 F7115 NEW T516 T3116 F3120 T3220 T5020 T5120 T525 F1325 T1425 F2425 T526 T528N T528N T530 T5130 T5530 F7530 F2331 F1035 F1335 T1435 F2135 F2335 F2435 F2635 F4635 T540 F4140 F4340 T544 F4144 F4345					F5105 F7810 F3710 F7810 T1415 T3115 F6315 F7115 NEW T516 T3116 F3120 T3220 T5020 T5120 T525 F1325 T1425 F2425 T526 T528N T528N T530 T5130 T5530 F7530 F2331 F1035 F1335 T1435 F2135 F2335 F2435 F2635 F4635 T540 F4140 F4340 T544 F4144 F4345				F5105 F7810 F3710 F7810 T1415 T3115 F6315 F7115 NEW T516 T3116 F3120 T3220 T5020 T5120 T525 F1325 T1425 F2425 T526 T528N T528N T530 T5130 T5530 F7530 F2331 F1035 F1335 T1435 F2135 F2335 F2435 F2635 F4635 T540 F4140 F4340 T544 F4144 F4345					F5105 F7810 F3710 F7810 T1415 T3115 F6315 F7115 NEW T516 T3116 F3120 T3220 T5020 T5120 T525 F1325 T1425 F2425 T526 T528N T528N T530 T5130 T5530 F7530 F2331 F1035 F1335 T1435 F2135 F2335 F2435 F2635 F4635 T540 F4140 F4340 T544 F4144 F4345				F5105 F7810 F3710 F7810 T1415 T3115 F6315 F7115 NEW T516 T3116 F3120 T3220 T5020 T5120 T525 F1325 T1425 F2425 T526 T528N T528N T530 T5130 T5530 F7530 F2331 F1035 F1335 T1435 F2135 F2335 F2435 F2635 F4635 T540 F4140 F4340 T544 F4144 F4345					F5105 F7810 F3710 F7810 T1415 T3115 F6315 F7115 NEW T516 T3116 F3120 T3220 T5020 T5120 T525 F1325 T1425 F2425 T526 T528N T528N T530 T5130 T5530 F7530 F2331 F1035 F1335 T1435 F2135 F2335 F2435 F2635 F4635 T540 F4140 F4340 T544 F4144 F4345				F5105 F7810 F3710 F7810 T1415 T3115 F6315 F7115 NEW T516 T3116 F3120 T3220 T5020 T5120 T525 F1325 T1425 F2425 T526 T528N T528N T530 T5130 T5530 F7530 F2331 F1035 F1335 T1435 F2135 F2335 F2435 F2635 F4635 T540 F4140 F4340 T544 F4144 F4345					F5105 F7810 F3710 F7810 T1415 T3115 F6315 F7115 NEW T516 T3116 F3120 T3220 T5020 T5120 T525 F1325 T1425 F2425 T526 T528N T528N T530 T5130 T5530 F7530 F2331 F1035 F1335 T1435 F2135 F2335 F2435 F2635 F4635 T540 F4140 F4340 T544 F4144 F4345				F5105 F7810 F3710 F7810 T1415 T3115 F6315 F7115 NEW T516 T3116 F3120 T3220 T5020 T5120 T525 F1325 T1425 F2425 T526 T528N T528N T530 T5130 T5530 F7530 F2331 F1035 F1335 T1435 F2135 F2335 F2435 F2635 F4635 T540 F4140 F4340 T544 F4144 F4345					F5105 F7810 F3710 F7810 T1415 T3115 F6315 F7115 NEW T516 T3116 F3120 T3220 T5020 T5120 T525 F1325 T1425 F2425 T526 T528N T528N T530 T5130 T5530 F7530 F2331 F1035 F1335 T1435 F2135 F2335 F2435 F2635 F4635 T540 F4140 F4340 T544 F4144 F4345				F5105 F7810 F3710 F7810 T1415 T3115 F6315 F7115 NEW T516 T3116 F3120 T3220 T5020 T5120 T525 F1325 T1425 F2425 T526 T528N T528N T530 T5130 T5530 F7530 F2331 F1035 F1335 T1435 F2135 F2335 F2435 F2635 F4635 T540 F4140 F4340 T544 F4144 F4345					F5105 F7810 F3710 F7810 T1415 T3115 F6315 F7115 NEW T516 T3116 F3120 T3220 T5020 T5120 T525 F1325 T1425 F2425 T526 T528N T528N T530 T5130 T5530 F7530 F2331 F1035 F1335 T1435 F2135 F2335 F2435 F2635 F4635 T540 F4140 F4340 T544 F4144 F4345				F5105 F7810 F3710 F7810 T1415 T3115 F6315 F7115 NEW T516 T3116 F3120 T3220 T5020 T5120 T525 F1325 T1425 F2425 T526 T528N T528N T530 T5130 T5530 F7530 F2331 F1035 F1335 T1435 F2135 F2335 F2435 F2635 F4635 T540 F4140 F4340 T544 F4144 F4345				
TENACITÀ - TOUGHNESS - ZÄHIGKEIT - TÉNACITÉ																																																																																																								
RESISTENZA ALL'USURA - RESISTANCE TO WEAR - VERSCHLEISSFESTIGKEIT - RÉSISTANCE À L'USURE																																																																																																								
AVANZAMENTO - FEED - VORSCHUB - AVANCE																																																																																																								
VELOCITÀ - SPEED - GESCHWINDIGKEIT - VITESSE																																																																																																								
HT	CERMET					HW	METALLO DURO NON RICOPERTO UNCOATED CARBIDE UNBESCHITETES HARTMETALL MÉTAL DUR PAS RECOUVERT					HC	METALLO DURO RICOPERTO COATED CARBIDE BESCHITETES HARTMETALL MÉTAL DUR RECOUVERT																																																																																											

SAU	DIN ISO 513	MATERIALE - MATERIAL MATERIALEN - MATÉRIAUX						PAG. 1199	QUICK PICK PAG. 538	 INDICAZIONI - USO	
		P	M	K	N	S	H				
		ACCIAI STEELS STAHL ACIER	ACCIAI INOX STAINLESS STEELS ROSTFREIER STAHL ACIER INOXYDABLE	GHISA CAST IRON GRAUGUSS FONTE GRISE	MATERIALI NON FERROSI NON FERROUS MAT. NICHT-EISENMATERIALIEN MAT. FERREUX	MATERIALI DURI HARD MATERIALS HARTE MATERIALIEN MATÉRIAUX DURS					
C4010	HT	P10-20 M05-15 K05-15	●	●	○				 Tenacità + Toughness -		- QUALITÀ UNIVERSALE - ALTA RESISTENZA AL CALORE E ALL'USURA, BUONA TENACITÀ - INDICATO PER LE ALTE VELOCITÀ DI TAGLIO
DT63	HT	P05-20 M05-20 K05-20	●	●	●						- QUALITÀ MICROGRANO MOLTO RESISTENTE ALLA ROTTURA ED ALL'USURA - INDICATO PER MEDIO-ALTE VELOCITÀ DI TAGLIO IN FINITURA.
N3005	HW	K01-10			●						- QUALITÀ ADATTA ALLA LAVORAZIONE DELLE GHISE IN GENERE - INDICATO PER LAVORAZIONI DI FINITURA A TAGLIO CONTINUO
N3015	HW	N01-20 S05-25				●	○				- QUALITÀ ADATTA ALLA LAVORAZIONE DI LEGHE IN ALLUMINIO
N3815	HW	N10-20				●					- GRADO LUCIDATO NON RIVESTITO SPECIFICO PER LA LAVORAZIONE DELL'ALLUMINIO E DEI MATERIALI NON FERROSI
N6315	HW	N05-25				●					- QUALITÀ PER LA LAVORAZIONE DI MATERIALI NON FERROSI
N3620	HW	N10-30				●					- SUBSTRATO IN NANOSTRUTTURA NON RIVESTITO. - INDICATO PER LAVORAZIONI CON SEZIONE DEL TRUCIOLO MEDIO, CON CONDIZIONI DI TAGLIO STABILE.
N3440	HW	K20-40 N20-30			●	●					- QUALITÀ UNIVERSALE PER GHISA E MATERIALI NON FERROSI - OTTIME PRESTAZIONI A UMIDO
T110	HW	K05-15			○	●					- QUALITÀ MICROGRANO CON ALTA RESISTENZA ALL' USURA E OTTIMA STABILITÀ DEI TAGLIANTI - INDICATO PER MEDIE VELOCITÀ DI TAGLIO SU GHISA GRIGIA E ALTE PER MATERIALI NON FERROSI. PER ASPORTAZIONI MEDIE IN SGROSSATURA
T115	HW	K10-25			●	●					- QUALITÀ MICROGRANO CON ALTA RESISTENZA ALL' USURA E BUONA TENACITÀ - INDICATO PER MEDIO-BASSE VELOCITÀ DI TAGLIO SU GHISA GRIGIA E MEDIO-ALTE PER MATERIALI NON FERROSI. PER ASPORTAZIONI MEDIE IN SGROSSATURA
T120	HW	M10-20 K10-25		○	●	●	○				- QUALITÀ MICROGRANO CON ELEVATA RESISTENZA ALL' USURA E BUONA TENACITÀ - INDICATO PER MEDIO-BASSE VELOCITÀ DI TAGLIO SU ACCIAI INOSSIDABILI AUSTENITICI E MEDIE PER GHISE GRIGIE E MATERIALI NON FERROSI. PER ASPORTAZIONI MEDIE IN SGROSSATURA
F7810	HC PVD	P05-20 M05-20 K05-20 H05-20	●	○	●		●				- RIVESTIMENTO IN PVD PER LA LAVORAZIONE DI ACCIAI CON GAMMA MAX. 58 HRC - QUALITÀ MICROGRANO STANDARD CON RIVESTIMENTO IN PVD MICROCRISTALLINO RESISTENTE ALL'USURA.
F7115 NEW	HC PVD	P10-25 M05-20 K05-15	●	○	●	○		○			- QUALITÀ CON SUBSTRATO IN MICROGRANO ULTRAFINE, ADATTO PER LA FINITURA DEGLI STAMPI.
F2425	HC PVD	P30-40 M15-35	○	●							- SUBSTRATO DI CARBURO APPPOSITAMENTE SVILUPPATO, RIVESTIMENTO IN PVD INNOVATIVO. - QUALITÀ CON UN'ECCELLENTI ROBUSTEZZA SENZA PREGIUDICARE LA DUREZZA A CALDO E LA RESISTENZA ALL'USURA SIA A BASSE CHE AD ALTE VELOCITÀ DI TAGLIO

● APPLICAZIONE CONSIGLIATA
RECOMMENDED APPLICATION
EMPFOHLENER EINSATZ
APPLICATION CONSEILLÉE

○ APPLICAZIONE POSSIBILE
POSSIBLE APPLICATION
MÖGLICHE ANWENDUNG
APPLICATION POSSIBLE

● APPLICAZIONE CONSIGLIATA
RECOMMENDED APPLICATION
EMPFOHLENER EINSATZ
APPLICATION CONSEILLÉE

○ APPLICAZIONE POSSIBILE
POSSIBLE APPLICATION
MÖGLICHE ANWENDUNG
APPLICATION POSSIBLE

 INDICATIONS - USE	 GEBRAUCHSANWEISUNGEN	 INDICATION - USAGE
<ul style="list-style-type: none"> - UNIVERSAL GRADE - HIGH HEAT AND WEAR RESISTANCE, GOOD TOUGHNESS - SUITABLE FOR HIGH CUTTING SPEEDS 	<ul style="list-style-type: none"> - UNIVERSALSORTE - HOHE HITZE- UND VERSCHLEIßBESTÄNDIGKEIT, GUTE ZÄHIGKEIT - FÜR HOHE SCHNITTGESCHWINDIGKEITEN GEEIGNET 	<ul style="list-style-type: none"> - QUALITE UNIVERSELLE - HAUTE RESISTANCE A LA CHALEUR ET A L'USURE, BONNE TENACITE - INDIQUEE POUR LES HAUTES VITESSES DE COUPE
<ul style="list-style-type: none"> - MICROGRAIN GRADE WITH VERY HIGH ULTIMATE STRENGTH AND RESISTANCE TO WEAR - SUITABLE FOR MEDIUM-HIGH CUTTING SPEEDS FOR FINISHING 	<ul style="list-style-type: none"> - MIKROKORNSORTE MIT SEHR HOHER BRUCH – UND VERSCHLEISSFESTIGKEIT - FÜR HOHE SCHNITTGESCHWINDIGKEITEN BEIM SCHLICHTEN GEEIGNET 	<ul style="list-style-type: none"> - QUALITE DE MICROGRAIN TRÈS RÉSISTANT À LA RUPTURE ET À L'USURE - INDIQUÉE POUR HAUTE VITESSE DE COUPE EN FINISSAGE
<ul style="list-style-type: none"> - GRADE SUITABLE FOR CAST IRON IN GENERAL - SUITABLE FOR FINISHING WITH CONTINUOUS CUT 	<ul style="list-style-type: none"> - ALLGEMEINE SORTE ZUR GUSSBEARBEITUNG - ZUM SCHLICHTEN MIT UNUNTERBROCHENEM SCHNITT GEEIGNET 	<ul style="list-style-type: none"> - QUALITÉ INDIQUÉ POUR USINAGE DE LA FONTE EN GENERAL - INDIQUÉE POUR FINISSAGE À COUPE CONTINU
<ul style="list-style-type: none"> - GRADE SUITABLE FOR ALUMINIUM ALLOYS 	<ul style="list-style-type: none"> - SORTE FÜR ALUMINIUMLEGIERUNGEN GEEIGNET 	<ul style="list-style-type: none"> - QUALITÉ INDIQUÉE POUR L'USINAGE DES ALLIAGE D'ALUMINIUM
<ul style="list-style-type: none"> - POLISHED UNCOATED GRADE, SPECIALLY DEVELOPED FOR ALUMINIUM AND NON-FERROUS MATERIALS 	<ul style="list-style-type: none"> - UNBESCHICHTETE SORTE, POLIERT UND SPEZIFISCH FÜR ALUMINIUM UND NICHT-EISERNE MATERIALIEN 	<ul style="list-style-type: none"> - NUANCE POLIE NON REVETUE SPECIFIQUE POUR L'USINAGE DE L'ALUMINIUM ET DES MATERIAUX NON FERREUX
<ul style="list-style-type: none"> - DEGREE FOR NON-FERROUS MATERIALS 	<ul style="list-style-type: none"> - SORTE FÜR NICHTEISENMATERIALIEN 	<ul style="list-style-type: none"> - QUALITÉ POUR L'USINAGE DE MATERIAUX NON FERREUX
<ul style="list-style-type: none"> - UNCOATED NANOSTRUCTURE SUBSTRATE. - SUITABLE FOR MEDIUM SECTION CHIP MACHINING, UNDER STABLE CUTTING CONDITIONS. 	<ul style="list-style-type: none"> - UNBESCHICHTETES NANOSTRUKTURIERTES SUBSTRAT. - FÜR BEARBEITUNGEN MIT MITTLEREM SPANQUERSCHNITT, UNTER STABILEN SCHNITTBEDINGUNGEN GEEIGNET. 	<ul style="list-style-type: none"> - SUBSTRAT EN NANOSTRUCTURE NON REVETU. - INDIQUE POUR DES USINAGES AVEC SECTION DU COPEAU MOYENNE, AVEC DES CONDITIONS DE COUPE STABLE.
<ul style="list-style-type: none"> - ALL-PURPOSE QUALITY FOR CAST IRON AND NON-FERROUS MATERIALS - EXCELLENT WET PERFORMANCE 	<ul style="list-style-type: none"> - UNIVERSALE QUALITÄT FÜR GUSS UND NICHTEISENMATERIALIEN - AUSGEZEICHNETE NASSLEISTUNGEN 	<ul style="list-style-type: none"> - QUALITÉ UNIVERSELLE POUR FONTE ET MATÉRIAUX NON FERREUX - PERFORMANCES EXCEPTIONNELLES À L'EAU
<ul style="list-style-type: none"> - MICROGRAIN GRADE WITH HIGH RESISTANCE TO WEAR AND EXCELLENT STABILITY OF THE CUTTING EDGES - SUITABLE FOR MEDIUM CUTTING SPEEDS ON GRAY IRON AND HIGH CUTTING SPEEDS ON NONFERROUS MATERIALS, FOR ROUGHING WITH MEDIUM REMOVAL OF MATERIAL. 	<ul style="list-style-type: none"> - MIKROKORNSORTE MIT HOHER VERSCHLEISSFESTIGKEIT UND AUSGEZEICHNETER STABILITÄT DER SCHNEIDEN - FÜR MITTLERE SCHNITTGESCHWINDIGKEITEN BEI GRAUGUSS UND FÜR HOHE SCHNITTGESCHWINDIGKEITEN BEI NE- MATERIALIEN FÜR MITTLERE ZERSPANUNG BEIM SCHRUPPEN GEEIGNET. 	<ul style="list-style-type: none"> - QUALITÉ DE MICROGRAIN AVEC HAUTE RÉSIDANCE À L'USURE ET TRÈS BONNE STABILITÉ DE LES COUPANTS. - INDIQUÉE POUR MOYENNE VITESSE DE COUPE SUR FONTE GRISE ET HAUTE SUR MATERIAL NON FERROUX, POUR MOYEN EMPORTATION EN ÉBAUCHAGE
<ul style="list-style-type: none"> - MICROGRAIN GRADE WITH HIGH RESISTANCE TO WEAR AND GOOD TOUGHNESS - SUITABLE FOR MEDIUM – LOW CUTTING SPEEDS ON AUSTENITIC STAINLESS STEEL AND MEDIUM-HIGH CUTTING SPEEDS FOR GRAY IRON AND NONFERROUS MATERIALS, FOR ROUGHING WITH MEDIUM REMOVAL OF MATERIAL. 	<ul style="list-style-type: none"> - MIKROKORNSORTE MIT HOHER VERSCHLEISSFESTIGKEIT UND GUTER ZÄHIGKEIT - FÜR MITTEL-NIEDRIGE SCHNITTGESCHWINDIGKEITEN BEI GRAUGUSS UND FÜR MITTEL-HOHE SCHNITTGESCHWINDIGKEITEN BEI NE-MATERIALIEN FÜR MITTLERE ZERSPANUNG BEIM SCHRUPPEN GEEIGNET 	<ul style="list-style-type: none"> - QUALITÉ DE MICROGRAIN AVEC HAUTE RÉSIDANCE À L'USURE ET BONNE TENACITÉ - INDIQUÉE POUR MOYENNE – FAIBLE VITESSE DE COUPE SUR ACIER INOX AUSTÉNITIQUE, MOYENNE-HAUTE POUR FONTE GRISE ET MATERIAL NON FERROUX, POUR MOYEN EMPORTATION EN ÉBAUCHAGE
<ul style="list-style-type: none"> - MICROGRAIN GRADE WITH HIGH RESISTANCE TO WEAR AND GOOD TOUGHNESS - SUITABLE FOR MEDIUM – LOW CUTTING SPEEDS ON AUSTENITIC STAINLESS STEEL AND MEDIUM CUTTING SPEEDS FOR GRAY IRON AND NONFERROUS MATERIALS, FOR ROUGHING WITH MEDIUM REMOVAL OF MATERIAL. 	<ul style="list-style-type: none"> - MIKROKORNSORTE MIT SEHR HOHER BRUCH UND GUTE ZÄHIGKEIT - SUITABLE FOR MEDIUM – LOW CUTTING SPEEDS ON AUSTENITIC STAINLESS STEEL AND MEDIUM CUTTING SPEEDS FOR GRAY IRON AND NONFERROUS MATERIALS, FOR ROUGHING WITH MEDIUM REMOVAL OF MATERIAL. 	<ul style="list-style-type: none"> - QUALITÉ DE MICROGRAIN AVEC HAUTE RÉSIDANCE À L'USURE ET BONNE TENANCITE - QUALITÉ DE MICROGRAIN AVEC HAUTE RÉSIDANCE À L'USURE ET BONNE TENANCITÉ
<ul style="list-style-type: none"> - PVD COATING FOR STEEL WITH MAX. 58 HRC - STANDARD MICROGRAIN GRADE WITH WEAR-RESISTANT MICROCRYSTALLINE PVD COATING 	<ul style="list-style-type: none"> - PVD-BESCHICHTUNG FÜR STAHL MIT MAX. 58 HRC - STANDARD-FEINSTKORN-SORTE MIT VERSCHLEISSFESTER MIKROKRISTALLINER PVD-BESCHICHTUNG 	<ul style="list-style-type: none"> - REVETEMENT EN PVD POUR L'USINAGE D'ACIERS AVEC GAMME MAX. 58 HRC - QUALITE MICROGRAIN STANDARD AVEC REVETEMENT EN PVD MICROCRISTALLIN RESISTANT A L'USURE.
<ul style="list-style-type: none"> - GRADE WITH ULTRAFINE MICRO GRAIN SUBSTRATE, SUITABLE FOR MOLD FINISHING. 	<ul style="list-style-type: none"> - SORTE MIT ULTRAFEINEM MIKROKORN-SUBSTRAT, ZUM FORMENSCHLICHTEN GEEIGNET. 	<ul style="list-style-type: none"> - QUALITE AVEC SUBSTRAT EN MICROGRAIN ULTRAFIN, INDIQUE DANS LA FINITION DES MOULES.
<ul style="list-style-type: none"> - SPECIALLY DEVELOPED CARBIDE SUBSTRATE, INNOVATIVE PVD COATING - GRADE WITH EXCELLENT TOUGHNESS WHICH DOES NOT AFFECT RED HARDNESS AND WEAR RESISTANCE, AT BOTH LOW AND HIGH CUTTING SPEEDS 	<ul style="list-style-type: none"> - SPEZIELL ENTWICKELTES KARBIDSUBSTRAT, INNOVATIVE PVD-BESCHICHTUNG. - SORTE MIT HERVORRAGENDER ROBUSTHEIT BEI UNVERÄNDERTER WARMHÄRTE UND VERSCHLEISSBESTÄNDIGKEIT SOWOHL MIT NIEDRIGEN ALS AUCH MIT HOHEN SCHNITTGESCHWINDIGKEITEN 	<ul style="list-style-type: none"> - SUBSTRAT DE CARBURE SPÉCIALEMENT DÉVELOPPÉ, REVÊTEMENT EN PVD INNOVANT. - QUALITÉ AVEC UNE ROBUSTESSE EXCELLENTE SANS PORTER PRÉJUDICE À LA DURETÉ À CHAUD ET À LA RÉSIDANCE À L'USURE À BASSES VITESSES COMME À HAUTES VITESSES DE COUPE

HT CERMET

HW METALLO DURO NON RICOPERTO
UNCOATED CARBIDE
UNBESCHICHTETES HARTMETALL
MÉTAL DUR PAS RECOUVERT

HC METALLO DURO RICOPERTO
COATED CARBIDE
BESCHICHTETES HARTMETALL
MÉTAL DUR RECOUVERT

SAU	DIN ISO 513		MATERIALE - MATERIAL MATERIALIEN - MATÉRIAUX PAG. 1199						QUICK PICK PAG. 538	 Tenacità + Toughness -		 INDICAZIONI - USO
			P	M	K	N	S	H				
			ACCIAI STEELS STAHL ACIER	ACCIAI INOX STAINLESS STEELS ROSTFREIER STAHL ACIER INOXYDABLE	GHISA CAST IRON GRAUGUSS	MAT. NON FERROSI NON FERROUS MAT. NICHTEISENMATERIALIEN	MAT. FERREUX	MAT. DIFFICILI DIFFICULT MATERIAL SCHWERGEMATERIALIEN				
T2035	HC	M20-40		●				●			- PARTICOLARMENTE IDONEO PER LA LAVORAZIONE DI ACCIAI RESISTENTI AL CALORE E LEGHE A BASE DI FERRO	
	CVD	S20-45						●				
F2135	HC	M25-40		●				○			- RIVESTIMENTO IN PVD A GRANA FINE, RESISTENTE ALL'USURA - ADATTO PER LAVORAZIONI DI ACCIAIO INOX	
	PVD	S25-40						○				
F2435	HC	P35-45	○	●							- SUBSTRATO DI CARBURO APPPOSITAMENTE SVILUPPATO - RIVESTIMENTO IN PVD INNOVATIVO, FORNISCE UN'ECCELLENTI ROBUSTEZZA E OTTIMA TENACITÀ SENZA PREGIUDICARE LA DUREZZA A CALDO SIA A BASSE CHE AD ALTE VELOCITÀ DI TAGLIO	
	PVD	M25-45										
F2635	HC	P20-40	○	●							- IDEALE PER LE LAVORAZIONI SU ACCIAIO INOX	
	PVD	M20-40										
F4635	HC	P25-45	●	●	○						- GRADO MOLTO TENACE, INDICATO PER LAVORAZIONE DI ACCIAI GENERICI E ACCIAI INOX FERRITICI. - INDICATO PER LAVORAZIONI GRAVOSE ANCHE CON TAGLIO INSTABILE.	
	PVD	M20-35 K20-35										
F2540 NEW	HC	M30-45		●							- GRADO IN MICROGRANO MOLTO TENACE, PERFORMANTE IN LAVORAZIONI DI SGROSSATURA A TAGLIO INTERROTTO. - INDICATO PER LA LAVORAZIONE DI ACCIAI INOSSIDABILI AUSTENITICI. - INDICATO PER LAVORAZIONI A UMIDO ANCHE MQL.	
	PVD											
F5105	HC	P01-10	●	○	○						- SUBSTRATO IN MICROGRANO CON RIVESTIMENTO MULTISTRATO TiAlSiN. - INDICATO IN CONDIZIONI DI TAGLIO STABILE PER LAVORAZIONI MEDIE E DI FINITURA.	
	PVD	K01-10 H05-15										
F3110 NEW	HC				●						- QUALITÀ RESISTENTE ALL'USURA, HA UN CONTROLLO PROGRESSIVO DEL DEGRADO TAGLIANTE - RESISTENTE ALLO SHOCK TERMICO E QUINDI MOLTO PERFORMANTE IN FRESATURA DI GHISA, ANCHE A VELOCITÀ DI TAGLIO ELEVATA.	
	PVD	K10-15										
F3710	HC				●						- ALTA RESISTENZA ALL' USURA E BUONA TENACITÀ - INDICATO PER MEDIO-ALTE VELOCITÀ DI TAGLIO IN FINITURA E SGROSSATURA PREVALENTEMENTE SU GHISA GRIGIA	
	PVD	K05-25 S05-25										
T1415	HC	P05-25	●		○						- GRADO INSERTO IDEALE PER LA PRODUZIONE AD ALTO VOLUME - BUONA RESISTENZA AL CALORE CHE LO RENDE PERFETTAMENTE ADATTO PER LA LAVORAZIONE A SECCO ANCHE AD ALTE VELOCITÀ DI TAGLIO	
	CVD	K10-35										
T3115	HC				●						- ALTA RESISTENZA ALL' USURA E BUONA TENACITÀ - INDICATO PER MEDIO-ALTE VELOCITÀ DI TAGLIO IN FINITURA E SGROSSATURA PREVALENTEMENTE SU GHISA	
	CVD	K05-20										
T516	HC				●						- ALTA RESISTENZA ALL' USURA E BUONA TENACITÀ - INDICATO PER MEDIO-ALTE VELOCITÀ DI TAGLIO IN FINITURA E SGROSSATURA PREVALENTEMENTE SU GHISA GRIGIA	
	CVD	K05-25										
T3116	HC				●						- MATERIE PRIME SELEZIONATE, PER GARANTIRE UN SUBSTRATO DURO E RESISTENTE ALL'USURA. - RIVESTIMENTO MULTISTRATO, LE MIGLIORI PRESTAZIONI SI OTTENGONO LAVORANDO A SECCO.	
	CVD	K10-20										
T1120	HC	P15-30	●								- ALTA RESISTENZA ALL'USURA, ADATTO PER LAVORAZIONI DI SPIANATURA IN CONDIZIONI STABILI	
	CVD											

● APPLICAZIONE CONSIGLIATA
RECOMMENDED APPLICATION
EMPFOHLENER EINSATZ
APPLICATION CONSEILLÉE

○ APPLICAZIONE POSSIBILE
POSSIBLE APPLICATION
MÖGLICHE ANWENDUNG
APPLICATION POSSIBLE

● APPLICAZIONE CONSIGLIATA
RECOMMENDED APPLICATION
EMPFOHLENER EINSATZ
APPLICATION CONSEILLÉE





○ APPLICAZIONE POSSIBILE
POSSIBLE APPLICATION
MÖGLICHE ANWENDUNG
APPLICATION POSSIBLE

 INDICATIONS - USE	 GEBRAUCHSANWEISUNGEN	 INDICATION - USAGE
<ul style="list-style-type: none"> - SPECIALLY SUITED FOR HEAT RESISTANT STEELS AND IRON-BASED ALLOYS 	<ul style="list-style-type: none"> - BESONDERS GEEIGNET FÜR HITZEBESTÄNDIGE STÄHLE UND EISENBASIERTE LEGIERUNGEN 	<ul style="list-style-type: none"> - PARTICULIEREMENT INDIQUE POUR L'USINAGE D'ACIERS RESISTANTS A LA CHALEUR ET AUX ALLIAGES A BASE DE FER
<ul style="list-style-type: none"> - FINE-GRAIN PVD COATING, RESISTANT TO WEAR - SUITABLE FOR MACHINING STAINLESS STEEL 	<ul style="list-style-type: none"> - FEINKORN-PVD-BESCHICHTUNG, VERSCHLEISSFEST - FÜR DIE BEARBEITUNG VON INOX-STAHL GEEIGNET 	<ul style="list-style-type: none"> - REVETEMENT EN PVD A GRAIN FIN, RESISTANT A L'USURE - PREVU POUR LES USINAGES D'ACIER INOX
<ul style="list-style-type: none"> - SPECIALLY DEVELOPED CARBIDE SUBSTRATE - INNOVATIVE PVD COATING PROVIDING EXCELLENT STRENGTH AND VERY GOOD TOUGHNESS WITHOUT AFFECTING RED HARDNESS AT BOTH LOW AND HIGH CUTTING SPEED 	<ul style="list-style-type: none"> - SPEZIELL ENTWICKELTES KARBID-SUBSTRAT - INNOVATIVE PVD-BESCHICHTUNG FÜR EXCELLENTE ROBUSTHEIT UND OPTIMALE ZÄHIGKEIT OHNE BEEINTRÄCHTIGUNG DER WARMHÄRTE BEI SOWOHL HOHEN ALS AUCH NIEDRIGEN SCHNITTGESCHWINDIGKEITEN 	<ul style="list-style-type: none"> - SUBSTRAT DE CARBURE SPECIALEMENT DEVELOPPE - REVETEMENT EN PVD INNOVANT, FOURNIT UNE ROBUSTESSE ET TENACITE EXCELLENTE, SANS POUR AUTANT PORTER PREJUDICE A LA DURETE A CHAUD A DE BASSES COMME A DE HAUTES VITESSES DE COUPE.
<ul style="list-style-type: none"> - IDEAL SOLUTION FOR STAINLESS STEEL APPLICATIONS 	<ul style="list-style-type: none"> - IDEALE LÖSUNG FÜR INOX-STAHL-ANWENDUNGEN 	<ul style="list-style-type: none"> - PREVU POUR LES USINAGES SUR ACIER INOX
<ul style="list-style-type: none"> - VERY TOUGH GRADE, SUITABLE FOR STANDARD AND FERRITIC STAINLESS STEEL - SUITABLE FOR HEAVY-DUTY MACHINING, ALSO UNDER UNSTABLE CUTTING CONDITIONS. 	<ul style="list-style-type: none"> - SEHR ZÄHE SORTE, ZUR BEARBEITUNG VON STANDARD- UND FERRITISCHEM EDELSTAHL GEEIGNET. - FÜR ANSPRUCHVOLLE BEARBEITUNGEN GEEIGNET, AUCH BEI INSTABILEN SCHNITTBEDINGUNGEN. 	<ul style="list-style-type: none"> - DEGRE TRES TENACE INDIQUE POUR L'USINAGE DES ACIERS GENERIQUES ET ACIERS INOXYDABLES FERRITISQUES - INDIQUE POUR LES USINAGES LOURDS MEME AVEC UNE COUPE INSTABLE.
<ul style="list-style-type: none"> - VERY TOUGH MICROGRAIN GRADE, PERFORMING IN INTERRUPTED-CUTTING ROUGHING MACHINING. - SUITABLE FOR THE MACHINING OF AUSTENITIC STAINLESS STEEL - SUITABLE FOR WET GRINDING ALSO MQL. 	<ul style="list-style-type: none"> - SEHR ZÄHE MIKROKORNSORTE MIT HOHER LEISTUNG BEIM SCHRUPPEN IM UNTERBROCHENEN SCHNITT. - GEEIGNET FÜR DIE BEARBEITUNG VON ROSTFREIEN, AUSTENITISCHEN STÄHLEN. - GEEIGNET FÜR NASSBEARBEITUNGEN, AUCH BEI MINIMALSCHMIERUNG MQL. 	<ul style="list-style-type: none"> - DEGRÉ EN MICRO GRAIN TRÈS TENACE, PERFORMANT DANS LES USINAGES DE DÉGROSSISSAGE À COUPE INTERROMPUE. - INDIQUÉ POUR L'USINAGE D'ACIERS INOXYDABLES AUSTÉNITIQUES. - INDIQUÉ POUR LES USINAGES PAR VOIE HUMIDE MEME MQL.
<ul style="list-style-type: none"> - MICROGRAIN SUBSTRATE WITH MULTILAYER TiAlSiN COATING. - SUITABLE FOR MEDIUM APPLICATIONS AND FINISHING UNDER STABLE CUTTING CONDITIONS. 	<ul style="list-style-type: none"> - MIKORKORNSUBSTRAT MIT MEHRFACH- TiAlSiN – BESCHICHTUNG. - FÜR MITTLERE- BIS SCHLICHTBEARBEITUNGEN UNTER STABILEN BEDINGUNGEN GEEIGNET. 	<ul style="list-style-type: none"> - SUBSTRAT EN MICROGRAIN AVEC REVETEMENT MULTICOUCHE TiAlSiN. - INDIQUE DANS DES CONDITIONS DE COUPE STABLE POUR USINAGES MOYENS ET DE FINITION.
<ul style="list-style-type: none"> - WEAR-RESISTANT GRADE WITH PROGRESSIVE CONTROL ON CUTTING EDGE DEGRADATION. - RESISTANT TO THERMAL SHOCK AND THEREFORE HIGHLY PERFORMING IN CAST IRON MILLING, ALSO AT HIGH CUTTING SPEED. 	<ul style="list-style-type: none"> - VERSCHLEISSFESTE SORTE MIT PROGRESSIVER KONTROLLE AUF DIE SCHNEIDKANTENVERSCHLECHTERUNG. - TEMPERATURWECHSELBESTÄNDIG UND DADURCH SEHR LEISTUNGSFÄHIG BEIM GUSSFRÄSEN, AUCH MIT HOHER SCHNITTGESCHWINDIGKEIT. 	<ul style="list-style-type: none"> - QUALITÉ RÉSISTANT À L'USURE AVEC UN CONTRÔLE PROGRESSIF DE LA DÉTÉRIORATION DU TRANCHANT. - RÉSISTANT AU CHOC THERMIQUE, D'OU UNE GRANDE PERFORMANCE DANS LE FRAISAGE DE FONTE MEME À UNE VITESSE DE COUPE ÉLEVÉE.
<ul style="list-style-type: none"> - HIGH RESISTANCE TO WEAR, GOOD TOUGHNESS - SUITABLE FOR MEDIUM – HIGH CUTTING SPEEDS FOR FINISHING AND ROUGHING MAINLY ON GRAY IRON 	<ul style="list-style-type: none"> - HOHE VERSCHLEISSFESTIGKEIT UND GUTE ZÄHIGKEIT - FÜR MITTEL – HOHE SCHNITTGESCHWINDIGKEITEN BEIM SCHLICHTEN UND SCHRUPPEN, ÜBERWIEGEND BEI GRAUGUSS, GEEIGNET 	<ul style="list-style-type: none"> - HAUTE RÉSISTANCE À L'USURE ET BONNE TENACITÉ - INDIQUÉE POUR MOYENNE – HAUTE VITESSE DE COUPE EN FINISSAGE ET ÉBAUCHAGE SURTOUT POUR FONTE GRISE
<ul style="list-style-type: none"> - IDEAL GRADE FOR HIGH VOLUME MACHINING - GOOD HEAT RESISTANCE AND THEREFORE PERFECTLY SUITABLE FOR DRY MACHINING, EVEN AT HIGH CUTTING SPEEDS 	<ul style="list-style-type: none"> - IDEALE SORTE FÜR HOCHVOLUMENFERTIGUNG - GUTE HITZEBESTÄNDIGKEIT UND DAHER PERFEKT FÜR DIE TROCKENBEARBEITUNG, AUCH MIT HOHEN SCHNITTGESCHWINDIGKEITEN 	<ul style="list-style-type: none"> - DEGRÉ PLAQUETTE IDÉAL POUR LA PRODUCTION À HAUT VOLUME - BONNE RÉSISTANCE À LA CHALEUR, QUI LE REND PARFAITEMENT INDIQUÉ POUR L'USINAGE À SEC MEME A DE HAUTES VITESSES DE COUPE
<ul style="list-style-type: none"> - EXTREMELY TOUGH WITH HIGH WEAR RESISTANCE - IDEAL FOR MEDIUM TO HIGH CUTTING SPEEDS FOR FINISHING AND ROUGHING WORK MAINLY ON CAST IRON 	<ul style="list-style-type: none"> - HOHE VERSCHLEISSFESTIGKEIT UND GUTE ZÄHIGKEIT - GEEIGNET FÜR MITTELHOHE UND HOHE SCHNITTGESCHWINDIGKEIT BEIM SCHLICHTEN UND SCHRUPPEN, ÜBERWIEGEND BEI GUSS 	<ul style="list-style-type: none"> - HAUTE RÉSISTANCE À L'USURE ET BONNE TENACITÉ - INDIQUÉ POUR DES VITESSES HAUTES ET MOYENNES DE COUPE EN FINITION ET DÉGROSSISSAGE PRINCIPALEMENT SUR FONTE
<ul style="list-style-type: none"> - HIGH RESISTANCE TO WEAR, GOOD TOUGHNESS - SUITABLE FOR MEDIUM – HIGH CUTTING SPEEDS FOR FINISHING AND ROUGHING MAINLY ON GRAY IRON 	<ul style="list-style-type: none"> - HOHE VERSCHLEISSFESTIGKEIT UND GUTE ZÄHIGKEIT - FÜR MITTEL – HOHE SCHNITTGESCHWINDIGKEITEN BEIM SCHLICHTEN UND SCHRUPPEN, ÜBERWIEGEND BEI GRAUGUSS, GEEIGNET 	<ul style="list-style-type: none"> - HAUTE RÉSISTANCE À L'USURE ET BONNE TENACITÉ - INDIQUÉE POUR MOYENNE – HAUTE VITESSE DE COUPE EN FINISSAGE ET ÉBAUCHAGE SURTOUT POUR FONTE GRISE
<ul style="list-style-type: none"> - CHOICE RAW MATERIALS, TO GUARANTEE A HARD AND WEAR-RESISTANT SUBSTRATE. - MULTILAYER COATING, BEST PERFORMANCE IS ACHIEVED THROUGH DRY-MACHINING. 	<ul style="list-style-type: none"> - AUSGEWÄHLTE ROHSTOFFE, UM EIN HARTES UND VERSCHLEISSFESTES SUBSTRAT ZU GEWÄHRLEISTEN. - MEHRSCICHT-BESCHICHTUNG, BESTE LEISTUNGEN WERDEN BEI TROCKENBEARBEITUNGEN ERZIELT. 	<ul style="list-style-type: none"> - MATIÈRES PREMIÈRES SÉLECTIONNÉES, AFIN D'ASSURER UN SUBSTRAT DUR ET RÉSISTANT À L'USURE. - REVÊTEMENT MULTICOUCHE, LES MEILLEURES PERFORMANCES SONT OBTENUES, EN TRAVAILLANT À SEC.
<ul style="list-style-type: none"> - HIGH RESISTANCE TO WEAR, SUITABLE FOR FACING UNDER STABLE CONDITIONS 	<ul style="list-style-type: none"> - HOHER VERSCHLEISSWIDERSTAND, FÜR DIE PLANBEARBEITUNG UNTER STABILEN BEDINGUNGEN GEEIGNET 	<ul style="list-style-type: none"> - HAUTE RÉSISTANCE A L'USURE, APPROPRIE POUR USINAGES DE PLANAGE DANS UN ETAT STABLE

HT CERMET

HW METALLO DURO NON RICOPERTO
UNCOATED CARBIDE
UNBESCHICHTETES HARTMETALL
MÉTAL DUR PAS RECOUVERT

HC METALLO DURO RICOPERTO
COATED CARBIDE
BESCHICHTETES HARTMETALL
MÉTAL DUR RECOUVERT

SAU	DIN ISO 513		MATERIALE - MATERIAL MATERIALIEN - MATÉRIAUX PAG. 1199							QUICK PICK PAG. 538	 Tenacità + Toughness -	 	 INDICAZIONI - USO
			P	M	K	N	S	H					
			ACCIAI STEELS STAHL ACIER	ACCIAI INOX STAINLESS STEELS ROSTFREIER STAHL ACIER INOXYDABLE	GHISA CAST IRON GRAUGUSS FONTE GRISE	MATTONI FERROSI NON FERROUS MAT. NICHT-EISENMATERIALIEN MAT. FERREUX	MAT. DIFFICILI DIFFICULT MATERIAL SCHWERIGE MATERIALIEN MAT. DIFICILES	MATERIALI DURI HARD MATERIALS HARTE MATERIALIEN MATÉRIAUX DURS					
F3120	HC	P05-15	○		●							- RIVESTIMENTO SPESSE INDICATO ALLA LAVORAZIONE DI GHISE ANCHE IN CONDIZIONE DI LUNGHE SPORGENZE. - BUONA LAVORABILITÀ DI ACCIAI DURI.	
	PVD	K15-25											
T3220	HC	P01-20	○		●							- GRADO DA TORNITURA PER LA LAVORAZIONE DELLA GHIA GRIGIA E SFEROIDALE	
	CVD	K10-30											
T5020	HC	P10-30	●		●					○		- QUALITÀ CON ALTA RESISTENZA ALL' USURA - INDICATO PER SGROSSATURA E MEDIE LAVORAZIONI CON CONDIZIONI STABILI ED ELEVATE VELOCITÀ DI TAGLIO	
	CVD	K15-35											
T1025	HC	P15-35	●									-GRADO INSERTO RESISTENTE ALL'USURA -IDEALE CON LAVORAZIONI AD ELEVATE VELOCITA' DI TAGLIO	
	CVD												
T1425	HC	P15-35	●	○	○							- VASTA GAMMA DI IMPIEGHI, IDEALE PER TUTTE LE LEGHE DI ACCIAIO E GHISA, BUONE PRESTAZIONI ANCHE SU INOX	
	CVD	M10-25 K25-35											
F4725	HC	P10-30	●									- ALTA TENACITÀ E OTTIMA RESISTENZA ALL'USURA TERMICA GRAZIE A UNO SPECIALE RIVESTIMENTO - INDICATO PER MEDIE VELOCITÀ DI TAGLIO IN FINITURA E SGROSSATURA	
	PVD	M10-35	●	●									
T526	HC	P10-35	●	○	●			○				- ALTA TENACITÀ , RESISTENZA ALL' USURA E ALLO SHOCK TERMICO - INDICATO PER MEDIO-ALTE VELOCITÀ DI TAGLIO E CON AVANZAMENTI MEDI IN CONDIZIONI NORMALI. OTTIMO SU ACCIAI LEGATI E GHISE SFEROIDALI	
	CVD	M20-35 K10-25											
T528N	HC	P25-35	●	●	○			○				- ALTA TENACITÀ, OTTIMA RESISTENZA ALLO SHOCK TERMICO E ALL'USURA - INDICATO PER MEDIO BASSE VELOCITÀ DI TAGLIO E CON MEDIO ALTI AVANZAMENTI ANCHE IN CONDIZIONI STABILI IN FINITURA E SGROSSATURA	
	CVD	M35-45 K25-35 S35-45											
F4128 NEW	HC	P20-30	●	●						●		- QUALITÀ PER MATERIALI GRAVOSI, OTTIMA RESISTENZA	
	PVD	M05-15 H05-35											
T530	HC	P30-40	●	●	○	○		●				- BUONA TENACITÀ E RESISTENZA ALLA SCHEGGIATURA - INDICATO PER MEDIO-BASSE VELOCITÀ DI TAGLIO E ALTI AVANZAMENTI	
	CVD	M20-25 S20-30											
T1130 NEW	HC	P10-40	●									- GRADO INSERTO TENACE, PER LAVORAZIONI DIFFICILI IN CONDIZIONI INSTABILI E A TAGLIO INTERROTTO	
	CVD												
T1730	HC	P25-35	●									- GRADO UNIVERSALE INDICATO PER SPIANATURA, ESSENDO TENACE GARANTISCE UNA STABILITÀ DI LAVORAZIONE. - MOLTO PERFORMANTE SU ACCIAIO CEMENTATO CON LAVORAZIONE A SECCO, MENTRE SU ACCIAI TENACI È CONSIGLIATO L'USO DELL'EMULSIONE.	
	CVD												
F4130	HC	P20-40	●	●	○					○		- QUALITÀ ALTAMENTE RESISTENTE ALL'USURA	
	PVD	M20-30											
T5130	HC	P25-35	●	○	●							- OTTIMO PER LE LAVORAZIONI A SECCO SU ACCIAIO CON ELEVATI VOLUMI DI ASPORTAZIONE	
	CVD	M20-30 K20-30											

● APPLICAZIONE CONSIGLIATA
RECOMMENDED APPLICATION
EMPFOHLENER EINSATZ
APPLICATION CONSEILLÉE

○ APPLICAZIONE POSSIBILE
POSSIBLE APPLICATION
MÖGLICHE ANWENDUNG
APPLICATION POSSIBLE

● APPLICAZIONE CONSIGLIATA
RECOMMENDED APPLICATION
EMPFOHLENER EINSATZ
APPLICATION CONSEILLÉE



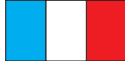

























○ APPLICAZIONE POSSIBILE
POSSIBLE APPLICATION
MÖGLICHE ANWENDUNG
APPLICATION POSSIBLE

 INDICATIONS - USE	 GEBRAUCHSANWEISUNGEN	 INDICATION - USAGE
<ul style="list-style-type: none"> - THIS COATING IS FREQUENTLY USED FOR CAST IRON MACHINING, ALSO WITH LONG PROJECTIONS. - GOOD MACHINABILITY OF HARD STEEL. 	<ul style="list-style-type: none"> - BESCHICHTUNG, DIE HÄUFIG ZUR BEARBEITUNG VON GUSS, AUCH MIT GROSSEM ÜBERSTAND, VERWENDET WIRD. - GUTE BEARBEITBARKEIT VON HARTSTÄHLEN. 	<ul style="list-style-type: none"> - REVÊTEMENT ÉPAIS S'ADAPTANT SOUVENT À L'USINAGE DE FONTES MÊME DANS LE CAS DE LONGUES SAILLIES. - BONNE MANIABILITÉ D'ACIERS DURS.
<ul style="list-style-type: none"> - GRADO DA TORNITURA PER LA LAVORAZIONE DELLA GHIA GRIGIA E SFEROIDALE 	<ul style="list-style-type: none"> - TURNING GRADE FOR GREY CAST IRON AND NODULAR CAST IRON 	<ul style="list-style-type: none"> - DEGRÉ DE TOURNAGE POUR L'USINAGE DE LA FONTE GRISE ET SPHEROÏDALE
<ul style="list-style-type: none"> - GRADE WITH HIGH RESISTANCE TO WEAR. - SUITABLE FOR ROUGHING AND MEDIUM MACHINING UNDER STABLE CONDITIONS AND AT HIGH CUTTING SPEEDS 	<ul style="list-style-type: none"> - SORTE MIT HOHER VERSCHLEIßBESTÄNDIGKEIT ZUM SCHRUPPEN UND ZUR MITTLEREN ZERSPANUNG UNTER STABILEN BEDINGUNGEN UND MIT HOHEN SCHNITTGESCHWINDIGKEITEN 	<ul style="list-style-type: none"> - QUALITÉ AVEC HAUTE RÉSIDANCE À L'USURE - INDIQUÉE POUR ÉBAUCHAGE ET USINAGES MOYENS AVEC CONDITIONS STABLES ET ÉLEVÉE VITESSE DE COUPE.
<ul style="list-style-type: none"> - WEAR RESISTANT QUALITY INSERT - IDEAL FOR HIGH CUTTING SPEED WORK 	<ul style="list-style-type: none"> - VERSCHLEISSFESTE WENDEPLATTE - IDEAL FÜR BEARBEITUNGEN MIT HOHER SCHNITTGESCHWINDIGKEIT 	<ul style="list-style-type: none"> - DEGRÉ PLAQUETTE RÉSISTANT À L'USURE - IDÉAL EN CAS D'USINAGES À DES VITESSES DE COUPE ÉLEVÉES
<ul style="list-style-type: none"> - WIDE RANGE OF APPLICATIONS, IDEAL FOR ALL STEEL AND CAST IRON ALLOYS, GOOD PERFORMANCE ALSO ON INOX 	<ul style="list-style-type: none"> - HOHE VIELSEITIGKEIT, IDEAL FÜR ALLE STAHL- UND GUSLEGIERUNGEN, GUTE LEISTUNG AUCH MIT INOXSTAHL 	<ul style="list-style-type: none"> - VASTE GAMME D'EMPLOIS, IDÉAL POUR TOUS LES ALLIAGES EN ACIER ET FONTE, BONNES PERFORMANCES MÊME SUR INOX
<ul style="list-style-type: none"> - HIGH TOUGHNESS AND EXCELLENT RESISTANCE TO THERMAL WEAR DUE TO THE SPECIAL COATING - SUITABLE FOR FINISHING AND ROUGHING AT MEDIUM CUTTING SPEEDS 	<ul style="list-style-type: none"> - HOHE ZÄHIGKEIT UND SEHR GUTE BESTÄNDIGKEIT GEGEN THERMISCHEN VERSCHLEIß AUFGRUND DER SPEZIALBESCHICHTUNG - FÜR MITTLERE SCHNITTGESCHWINDIGKEITEN ZUM SCHLICHTEN UND SCHRUPPEN GEEIGNET 	<ul style="list-style-type: none"> - HAUTE TÉNACITÉ ET TRÈS BONNE RÉSIDANCE À L'USURE THERMIQUE DÙ À UN SPÉCIAL REVÊTEMENT - INDIQUÉE POUR MOYENNE VITESSE DE COUPE EN FINISSAGE ET ÉBAUCHAGE
<ul style="list-style-type: none"> - HIGH TOUGHNESS, RESISTANCE TO WEAR AND TO THERMAL SHOCK - SUITABLE FOR MEDIUM – HIGH CUTTING SPEEDS AND WITH MEDIUM FEED UNDER NORMAL CONDITIONS - EXCELLENT ON STEEL ALLOYS AND SPHEROIDAL CAST IRON 	<ul style="list-style-type: none"> - HOHE ZÄHIGKEIT, VERSCHLEISSFESTIGKEIT UND TEMPERATURWECHSELBESTÄNDIGKEIT - FÜR MITTEL-HOHE SCHNITTGESCHWINDIGKEITEN UND BEI MITTLEREN VORSCHÜBEN UNTER NORMALEN BEDINGUNGEN GEEIGNET - FÜR EDELSTAHL UND SPHÄROGUSS OPTIMAL GEEIGNET 	<ul style="list-style-type: none"> - HAUTE TENACITÉ, RÉSIDANCE À L'USURE ET AU SHOCK THERMIQUE - INDIQUÉE POUR MOYENNE – HAUTE VITESSE DE COUPE ET MOYEN DÉPLACEMENT EN CONDITIONS NORMAUX - OPTIMUM SUR ACIER ALLIÉ ET FONTE SPHÉROÏDAL
<ul style="list-style-type: none"> - HIGH TOUGHNESS, EXCELLENT THERMAL SHOCK AND WEAR RESISTANCE - SUITABLE FOR MEDIUM-LOW CUTTING SPEEDS AND WITH MEDIUM-HIGH FEED FACTORS, ALSO UNDER STABLE MACHINING CONDITIONS FOR FINISHING AND ROUGHING 	<ul style="list-style-type: none"> - HOHE ZÄHIGKEIT, SEHR GUTE TEMPERATURWECHSELBESTÄNDIGKEIT UND VERSCHLEISSFESTIGKEIT - GEEIGNET FÜR MITTLERE BIS GERINGE SCHNITTGESCHWINDIGLEITEN UND MITTLERE UND HOHE VORSCHÜBE, AUCH UNTER STABILEN BEARBEITUNGSBEDINGUNGEN ZUM SCHLICHTEN UND SCHRUPPEN 	<ul style="list-style-type: none"> - HAUTE TENACITÉ, TRÈS BONNE RÉSIDANCE AU CHOC THERMIQUE ET À L'USURE - INDIQUÉE POUR MOYENNE BASSES VITESSE DE COUPE ET AVEC MOYENNES HAUTES AVANCES MÊME AVEC DE CONDITIONS STABLES EN FINISSAGE ET DÉGROSSISSAGE
<ul style="list-style-type: none"> - GRADE FOR CHALLENGING MATERIALS, EXCELLENT RESISTANCE 	<ul style="list-style-type: none"> - SORTE FÜR GRAVIERENDE MATERIALIEN, HERVORRAGENDE WIDERSTANDSFÄHIGKEIT 	<ul style="list-style-type: none"> - QUALITE POUR MATERIAUX DIFFICILES, RESISTANCE OPTIMALE
<ul style="list-style-type: none"> - GOOD TOUGHNESS AND RESISTANCE TO CHIPPING - SUITABLE FOR MEDIUM-LOW CUTTING SPEEDS AND HIGH FEED 	<ul style="list-style-type: none"> - GUTER ZÄHIGKEIT UND AUSBRUCHFESTIGKEIT - FÜR MITTEL-NIEDRIGE SCHNITTGESCHWINDIGKEITEN UND HOHE VORSCHÜBE GEIGNET 	<ul style="list-style-type: none"> - BONNE TENACITÉ ET RÉSIDANCE À L'ÉBRÈCHEMENT - INDIQUÉE POUR MOYENNE-FAIBLE VITESSE DE COUPE
<ul style="list-style-type: none"> - TOUGH DEGREE FOR DIFFICULT MACHINING UNDER UNSTABLE CONDITIONS AND WITH INTERRUPTED CUT 	<ul style="list-style-type: none"> - ZÄHE SORTE FÜR SCHWERE BEARBEITUNGEN UNTER UNSTABILEN BEDINGUNGEN UND MIT UNTERBROCHENEM SCHNITT 	<ul style="list-style-type: none"> - DEGRÉ PLAQUETTE TENACE POUR USINAGES DIFFICILES DANS DES CONDITIONS INSTABLES ET À COUPE INTERROMPUE
<ul style="list-style-type: none"> - UNIVERSAL GRADE SUITABLE FOR FACE MILLING, ENSURING MACHINING STABILITY GIVEN ITS TOUGHNESS. - HIGHLY PERFORMING ON CASE-HARDENED STEEL WITH DRY-MACHINING, WHILE IT IS ADVISABLE TO USE THE EMULSION ON TOUGH STEELS. 	<ul style="list-style-type: none"> - UNIVERSALE, ZUM PLANFRÄSEN GEEIGNETE SORTE, DIE AUFGRUND IHRER ZÄHHEIT DIE BEARBEITUNGSSTABILITÄT GARANTIERT. - HOHE LEISTUNGEN BEI EINSATZSTAHL MIT TROCKENBEARBEITUNG; BEI ZÄHEN STÄHLEN WIRD HINGEGEN DER GEBRAUCH DER EMULSION EMPFOHLEN. 	<ul style="list-style-type: none"> - DEGRÉ UNIVERSEL INDIQUÉ POUR LE PLANAGE, ÉTANT TENACE IL GARANTIT UNE STABILITÉ D'USINAGE. - TRÈS PERFORMANT SUR ACIER CÉMENTÉ AVEC USINAGE À SEC, TANDIS QUE SUR DES ACIERS TENACES IL EST CONSEILLÉ D'AVOIR RECOURS À L'ÉMULSION.
<ul style="list-style-type: none"> - HIGH WEAR RESISTANCE QUALITY 	<ul style="list-style-type: none"> - HOCH VERSCHLEISSFESTE QUALITÄT 	<ul style="list-style-type: none"> - QUALITÉ HAUTEMENT RÉSISTANTE À L'USURE
<ul style="list-style-type: none"> - EXCELLENT FOR DRY MACHINING ON STEEL WITH LARGE CHIP REMOVAL VOLUME 	<ul style="list-style-type: none"> - SEHR GUT FÜR DIE TROCKENBEARBEITUNG VON STAHL MIT HOHEM ZERSPANVOLUMEN 	<ul style="list-style-type: none"> - PARFAIT POUR LES USINAGES A SEC SUR ACIER AVEC DES VOLUMES D'ENLEVEMENT ELEVES

HT CERMET

HW METALLO DURO NON RICOPERTO UNCOATED CARBIDE UNBESCHICHTETES HARTMETALL MÉTAL DUR PAS RECOUVERT

HC METALLO DURO RICOPERTO COATED CARBIDE BESCHICHTETES HARTMETALL MÉTAL DUR RECOUVERT



SAU	DIN ISO 513	MATERIALE - MATERIAL MATERIALIEN - MATÉRIAUX						PAG. 1199	QUICK PICK PAG. 538	 INDICAZIONI - USO	
		P	M	K	N	S	H				
		ACCIAI STEELS STAHL ACIER	ACCIAI INOX STAINLESS STEELS ROSTFREIER STAHL ACIER INOXYDABLE	GHISA CAST IRON GRAUGUSS FONTE GRISE	MATERIALI NON FERROSI NON FERROUS MAT. NICHT FERROSE MATERIALIEN MAT. FERREUX	MATERIALI DIFFICILI DIFFICULT MATERIAL SCHWERIGE MATERIALIEN MAT. DIFCILES	MATERIALI DURI HARD MATERIALS HARTE MATERIALIEN MATÉRIAUX DURS				
T5530 NEW	HC	P30-40 M20-30 K25-35	●	○	●				 Tenacità + Toughness -		- PRIMA SCELTA PER ACCIAIO GRUPO P IN CONDIZIONI DI MEDIA STABILITÀ E MEDIE VC. - PRIMA SCELTA ANCHE PER MATERIALI GRUPPO M (INOX) E SUPERLEGHE, PER LAVORAZIONI IN CONDIZIONI STABILI.
	CVD	S05-35									
F7530 NEW	HC	P01-50 M15-25 K25-35	●	●	●	●	●		 Tenacità + Toughness -		- QUALITÀ PER SGROSSATURA E MEDIA SGROSSATURA CON CONDIZIONI STABILI AD ELEVATE VELOCITÀ DI TAGLIO. - QUALITÀ ECCELLENTE PER ACCIAI DURI, OTTIMO COMPORTAMENTO ANCHE NELLA SGROSSATURA DI GHISA GRIGIA E GHISA SFEROIDALE
	PVD	N05-25 S05-35									
F4140	HC	P30-50 M25-40	●	●	○	○	●		 Tenacità + Toughness -		- QUALITÀ PER FINITURA E MEDIA SGROSSATURA. PRIMA SCELTA PER OPERAZIONI CON BASSI AVANZAMENTI E/O BASSE VELOCITÀ DI TAGLIO. - ECCELLENTE PER LAVORAZIONI IN CONDIZIONI POCO STABILI E CON REFRIGERANTE. - CONSIGLIATO PER LAVORARE LE SUPERLEGHE
	PVD	S20-30									
F4340	HC	P20-40 M20-30	●	●					 Tenacità + Toughness -		- PER LA LAVORAZIONE DI ACCIAI E ACCIAI INOSSIDABILI A BASSE VELOCITÀ DI TAGLIO, CON AMPIO CAMPO APPLICATIVO - OTTIME PRESTAZIONI A UMIDO
	PVD										
F4144 NEW	HC	P30-50 M30-40	●	●					 Tenacità + Toughness -		- LA SUA STRUTTURA E IL SUO RIVESTIMENTO RENDE QUESTO GRADO MOLTO TENACE E RESISTENTE ALLE ALTE TEMPERATURE. - PARTICOLARMENTE ADATTO A LAVORAZIONI DI FORTE TAGLIO INTERROTTO E LAVORAZIONI GRAVOSE.
	PVD	S30-40									
T1435	HC	P25-45 M20-30	●	○					 Tenacità + Toughness -		- GRADO INSERTO TENACE, PER LAVORAZIONI DIFFICILI IN CONDIZIONI INSTABILI E A TAGLIO INTERROTTO
	CVD										
F3010	HC	K05-20			●				 Tenacità + Toughness -		- QUALITÀ PER LA FRESATURA DI GHISE - RIVESTIMENTO ULTRAFINE PER ELEVATE VELOCITÀ DI TAGLIO ADATTO ANCHE IN CONDIZIONI DI TAGLIO INSTABILI
	PVD										
F6315	HC	P10-30 M05-25 K05-25	●	●	●				 Tenacità + Toughness -		- OTTIMA RESISTENZA ALL'USURA - QUALITÀ UNIVERSALE PER VARI TIPI DI MATERIALE - INDICATO PER MEDIE-ALTE VELOCITÀ DI TAGLIO
	PVD										
T5120	HC	P10-30	●		●				 Tenacità + Toughness -		- QUALITÀ PER SGROSSATURA E MEDIA SGROSSATURA CON CONDIZIONI STABILI AD ELEVATE VELOCITÀ DI TAGLIO. - QUALITÀ ECCELLENTE PER ACCIAI DURI. OTTIMO COMPORTAMENTO ANCHE NELLA SGROSSATURA DI GHISA GRIGIA E GHISA SFEROIDALE
	CVD	K15-35									
T525	HC	P15-35 M20-35 K30-40	●	●	○		○	○	 Tenacità + Toughness -		- OTTIMO EQUILIBRIO TRA TENACITÀ E RESISTENZA ALL'USURA - INDICATO PER MEDIE VELOCITÀ DI TAGLIO E CON AVANZAMENTI MEDIO ALTI IN SGROSSATURA ANCHE IN CONDIZIONI INSTABILI
	CVD										
F1325	HC	P15-30 M20-30 K20-30	●	○	○				 Tenacità + Toughness -		- LAVORAZIONE GENERICHE DI ACCIAIO, ACCIAIO INOX E ANCHE BUONA LAVORABILITÀ PER GHISA. - CONSIGLIATO PER LA LAVORAZIONE CON VELOCITÀ DI TAGLIO ELEVATE SE IN CONDIZIONI DI LAVORO STABILI.
	PVD										
F2330	HC	P20-35 M20-35	○	●					 Tenacità + Toughness -		- LA SUA STRUTTURA IN MICROGRANO, LA COMPOSIZIONE E IL RIVESTIMENTO, RENDONO QUESTO GRADO MOLTO PERFORMANTE NELLE LAVORAZIONI DI MATERIALI ISO M E S. - INSERTO TENACE CHE PERMETTE LAVORAZIONI MEDIAMENTE INTERROTTE ANCHE DI MATERIALI ISO S.
	PVD	S10-30									
F2331	HC	P20-40 M20-35	●	●					 Tenacità + Toughness -		- SUBSTRATO RESISTENTE ALL'USURA - INSERTO VERSATILE ADATTO SIA PER SGROSSATURA CHE FINITURA ANCHE IN CONDIZIONI SFAVOREVOLI
	PVD										
F1035	HC	P25-40 M20-35	●	○					 Tenacità + Toughness -		- QUALITÀ MOLTO TENACE - OTTIMA RESISTENZA ALL'USURA
	PVD										

● APPLICAZIONE CONSIGLIATA
RECOMMENDED APPLICATION
EMPFOHLENER EINSATZ
APPLICATION CONSEILLÉE

○ APPLICAZIONE POSSIBILE
POSSIBLE APPLICATION
MÖGLICHE ANWENDUNG
APPLICATION POSSIBLE

● APPLICAZIONE CONSIGLIATA
RECOMMENDED APPLICATION
EMPFOHLENER EINSATZ
APPLICATION CONSEILLÉE

○ APPLICAZIONE POSSIBILE
POSSIBLE APPLICATION
MÖGLICHE ANWENDUNG
APPLICATION POSSIBLE

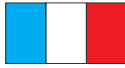
 INDICATIONS - USE	 GEBRAUCHSANWEISUNGEN	 INDICATION - USAGE
<ul style="list-style-type: none"> - FIRST CHOICE FOR STEEL GROUP P WITH MEDIUM STABILITY AND MEDIUM VC - FIRST CHOICE ALSO FOR MATERIAL GROUP M (INOX) AND SUPERALLOYS, FOR MACHINING APPLICATIONS UNDER STABLE CONDITIONS. 	<ul style="list-style-type: none"> - ERSTE WAHL FÜR STAHLGRUPPE P UNTER MITTELSTABILEN BEDINGUNGEN UND MIT MITTLEREN VC-WERTEN - ERSTE WAHL AUCH FÜR MATERIALGRUPPE M (INOX) UND SUPERLEGIERUNGEN, FÜR DIE BEARBEITUNG UNTER STABILEN BEDINGUNGEN 	<ul style="list-style-type: none"> - PREMIER CHOIX POUR ACIER GROUPE P DANS DES CONDITIONS DE STABILITÉ ET VITESSE DÉCOUPE MOYENNES - PREMIER CHOIX AUSSI POUR DES MATIÈRES GROUPE M (INOX) ET SUPERALLIAGES, POUR DES USINAGES DANS DES CONDITIONS STABLES.
<ul style="list-style-type: none"> - GRADE FOR MEDIUM AND ROUGHING OPERATIONS UNDER STABLE CONDITIONS AND AT HIGH CUTTING SPEEDS - EXCELLENT GRADE FOR HARD STEEL, ALSO HIGHLY PERFORMING IN ROUGHING OF GREY AND NODULAR CAST IRON 	<ul style="list-style-type: none"> - SORTE FÜR DAS SCHLICHTEN UND ZWISCHENSCHLICHTEN UNTER STABILEN BEDINGUNGEN UND BEI HOHEN SCHNITTGESCHWINDIGKEITEN - AUSGEZEICHNETE SORTE FÜR HARTSTAHL, HERVORRAGENDES VERHALTEN AUCH BEIM SCHRUPPEN VON GRAUGUSS UND SPHÄROGUSS 	<ul style="list-style-type: none"> - QUALITÉ POUR ÉBAUCHE ET ÉBAUCHE MOYENNE DANS DES CONDITIONS STABLES À DES VITESSES DE DÉCOUPE ÉLEVÉES. - QUALITÉ EXCELLENTE POUR ACIERS DURS, COMPORTEMENT OPTIMAL MÊME DANS L'ÉBAUCHE DE FONTE GRISE ET DE FONTE SPHÉROÏDALE
<ul style="list-style-type: none"> - PREMIUM QUALITY FOR MEDIUM ROUGHING AND FINISHING. - FIRST CHOICE FOR SLOW FEED AND/OR SLOW CUTTING SPEEDS - OUTSTANDING FOR WORKING IN UNSTABLE CONDITIONS WITH COOLANT - RECOMMENDED FOR MACHINING SUPER ALLOYS 	<ul style="list-style-type: none"> - QUALITÄT ZUM SCHLICHTEN UND MITTLEREM SCHRUPPEN. - ERSTE WAHL FÜR ARBEITSSCHRITTE MIT NIEDRIGEM VORSCHUB U/O NIEDRIGER SCHNITTGESCHWINDIGKEIT. - AUSGEZEICHNET FÜR BEARBEITUNGEN UNTER UNSTABILEN BEDINGUNGEN UND MIT KÜHLMITTEL. - EMPFOHLEN ZUR BEARBEITUNG VON SUPERLEGIERUNGEN 	<ul style="list-style-type: none"> - QUALITÉ POUR FINITION ET DÉGROSSISSAGE MOYEN. PREMIER CHOIX POUR DES OPÉRATIONS AVEC DES AVANCES MODIQUES ET/OU DE FAIBLES VITESSES DE COUPE. - PARFAIT POUR DES USINAGES DANS DES CONDITIONS PEU STABLES ET AVEC RÉFRIGÉRANT. - CONSEILLÉ POUR USINER LES SUPERALLIAGES
<ul style="list-style-type: none"> - FOR MACHINING STEELS AND STAINLESS STEELS AT SLOW CUTTING SPEEDS FOR A VAST RANGE OF APPLICATIONS - EXCELLENT WET PERFORMANCE 	<ul style="list-style-type: none"> - FÜR DIE BEARBEITUNG VON STAHL UND EDELSTAHL MIT NIEDRIGER SCHNITTGESCHWINDIGKEIT, GROSSER ANWENDUNGSBEREICH - AUSGEZEICHNETE NASSLEISTUNGEN 	<ul style="list-style-type: none"> - POUR L'USINAGE D'ACIERS ET ACIERS INOXYDABLES À DE FAIBLES VITESSES DE COUPE, AVEC AMPLÉ PLAGE D'APPLICATION - PERFORMANCES EXCEPTIONNELLES À L'EAU
<ul style="list-style-type: none"> - THIS GRADE'S STRUCTURE AND COATING MAKE IT VERY TOUGH AND HIGH TEMPERATURE-RESISTANT. - ESPECIALLY SUITED FOR STRONG INTERRUPTED-CUTTING MACHINING AND STRENUOUS MACHINING 	<ul style="list-style-type: none"> - AUFGRUND SEINER FEINKÖRNIEN STRUKTUR, ZUSAMMENSETZUNG UND BESCHICHTUNG IST DIESER TYP BEI DER BEARBEITUNG VON ISO-M- UND S-MATERIALIEN BESONDERS LEISTUNGSFÄHIG. - ZÄHE WENDESCHNEIDPLATTE, DIE AUCH DURCHSCHNITTLICH UNTERBROCHENE BEARBEITUNGEN VON ISO-MATERIALIEN ERMÖGLICHT. 	<ul style="list-style-type: none"> - SA STRUCTURE ET SON REVÊTEMENT RENDENT CE DEGRÉ TRÈS TENACE ET RESISTANT AUX TEMPÉRATURES ÉLEVÉES. - PARTICULIÈREMENT INDIQUE AUX USINAGES D'UNE COUPE FORTE INTERROMPUE ET D'USINAGES PENIBLES.
<ul style="list-style-type: none"> - TOUGH DEGREE FOR DIFFICULT MACHINING UNDER UNSTABLE CONDITIONS AND WITH INTERRUPTED CUT 	<ul style="list-style-type: none"> - ZÄHE SORTE FÜR SCHWERE BEARBEITUNGEN UNTER UNSTABILEN BEDINGUNGEN UND MIT UNTERBROCHENEM SCHNITT 	<ul style="list-style-type: none"> - DEGRÉ PLAQUETTE TENACE POUR USINAGES DIFFICILES DANS DES CONDITIONS INSTABLES ET À COUPE INTERROMPUE
<ul style="list-style-type: none"> - MILLING GRADE FOR CAST-IRON - ULTRA-FINE COATING FOR HIGH CUTTING SPEEDS, ALSO SUITABLE UNDER UNSTABLE CUTTING CONDITIONS 	<ul style="list-style-type: none"> - SORTE ZUM FRÄSEN VON GUSSEISEN - ULTRAFEINE BESCHICHTUNG FÜR HOHE SCHNITTGESCHWINDIGKEITEN, AUCH UNTER UNSTABILEN SCHNITTBEDINGUNGEN GEEIGNET 	<ul style="list-style-type: none"> - QUALITÉ POUR LE FRAISAGE DES FONTES - REVÊTEMENT TRÈS FINE POUR ÉLEVÉE VITESSE DE COUPE APPROPRIÉ MÊME AVEC CONDITIONS DE COUPE INSTABLES
<ul style="list-style-type: none"> - EXCELLENT RESISTANCE TO WEAR - UNIVERSAL DEGREE FOR DIFFERENT TYPES OF MATERIALS - SUITABLE FOR MEDIUM TO HIGH CUTTING SPEEDS 	<ul style="list-style-type: none"> - SEHR HOHE VERSCHLEISSFESTIGKEIT - UNIVERSALSORTE FÜR VERSCHIEDENE MATERIALIEN - FÜR MITTLERE BIS HOHE SCHNITTGESCHWINDIGKEITEN GEEIGNET 	<ul style="list-style-type: none"> - RESISTANCE EXCELLENTE À L'USURE - QUALITÉ UNIVERSELLE POUR DIFFÉRENTS TYPES DE MATÉRIAU - INDIQUE EN CAS DE VITESSES DE COUPE HAUTES-MOYENNES
<ul style="list-style-type: none"> - QUALITY FOR ROUGHING AND MEDIUM ROUGHING IN STABLE CONDITIONS WITH HIGH CUTTING SPEEDS - OUTSTANDING QUALITY FOR HARD STEELS. EXCELLENT BEHAVIOUR ALSO IN ROUGHING GREY CAST IRON AND SPHEROIDAL GRAPHITE CAST IRON 	<ul style="list-style-type: none"> - QUALITÄT ZUM SCHRUPPEN UND MITTLEREM SCHRUPPEN UNTER STABILEN BEDINGUNGEN UND BEI HOHER SCHNITTGESCHWINDIGKEIT. - HERVORRAGENDE QUALITÄT FÜR HARTSTAHL. - AUSGEZEICHNETES VERHALTEN AUCH BEIM SCHRUPPEN VON GRAUGUSS UND SPHÄROGUSS 	<ul style="list-style-type: none"> - QUALITÉ POUR DÉGROSSISSAGE ET DÉGROSSISSAGE MOYEN DANS DES CONDITIONS STABLES À DES VITESSES DE COUPE ÉLEVÉES. - QUALITÉ EXCELLENTE POUR ACIERS DURS. COMPORTEMENT PARFAIT MÊME DANS LE DÉGROSSISSAGE DE FONTE GRISE ET FONTE SPHÉROÏDALE
<ul style="list-style-type: none"> - EXCELLENT BALANCE BETWEEN TOUGHNESS AND RESISTANCE TO WEAR - SUITABLE FOR MEDIUM CUTTING SPEEDS AND WITH MEDIUM-HIGH FEED FOR ROUGHING UNDER STABLE CONDITIONS 	<ul style="list-style-type: none"> - OPTIMALE AUSGEWOGENHEIT ZWISCHEN ZÄHIGKEIT UND VERSCHLEISSFESTIGKEIT - FÜR MITTEL SCHNITTGESCHWINDIGKEITEN UND BEI MITTEL-GROSSEN VORSCHÜBEN, UNTER STABILEN BEDINGUNGEN, ZUM SCHRUPPEN GEEIGNET 	<ul style="list-style-type: none"> - TRÈS BON ÉQUILIBRE ENTRE TENACITÉ ET RÉSISTANCE À L'USURE - INDIQUÉE POUR MOYENNE VITESSE DE COUPE ET MOYENNE-HAUT DÉPLACEMENT POUR ÉBAUCHAGE EN CONDITION STABLE
<ul style="list-style-type: none"> - GENERAL MACHINING OF STEEL, STAINLESS STEEL AND GOOD MACHINABILITY FOR CAST IRON. - RECOMMENDED FOR HIGH CUTTING SPEED UNDER STABLE MACHINING CONDITIONS. 	<ul style="list-style-type: none"> - ALLGEMEINE BEARBEITUNG VON STAHL, EDELSTAHL UND GUTE BEARBEITBARKEIT VON GUSS. - EMPFOHLEN ZUR BEARBEITUNG MIT HOHEN SCHNITTGESCHWINDIGKEITEN, WENN DIE ARBEITSBEDINGUNGEN STABIL SIND. 	<ul style="list-style-type: none"> - USINAGES GÉNÉRIQUES D'ACIER, ACIER INOX ET ÉGALEMENT BONNE MANIABILITÉ POUR LA FONTE. - CONSEILLÉ POUR L'USINAGE AVEC DES VITESSES DE COUPE ÉLEVÉES, DANS LE CAS DE CONDITIONS DE TRAVAIL STABLES.
<ul style="list-style-type: none"> - THANKS TO ITS MICROGRAIN STRUCTURE, COMPOSITION AND COATING, THIS GRADE IS HIGHLY PERFORMING IN THE MACHINING OF ISO M E S MATERIALS. - TOUGH INSERT THAT ALLOWS AVERAGE INTERRUPTED MACHINING ALSO OF ISO S MATERIALS. 	<ul style="list-style-type: none"> - AUFGRUND SEINER FEINKÖRNIEN STRUKTUR, ZUSAMMENSETZUNG UND BESCHICHTUNG IST DIESER TYP BEI DER BEARBEITUNG VON ISO-M- UND S-MATERIALIEN BESONDERS LEISTUNGSFÄHIG. - ZÄHE WENDESCHNEIDPLATTE, DIE AUCH DURCHSCHNITTLICH UNTERBROCHENE BEARBEITUNGEN VON ISO-MATERIALIEN ERMÖGLICHT. 	<ul style="list-style-type: none"> - SA STRUCTURE EN MICROGRAIN, LA COMPOSITION ET LE REVÊTEMENT RENDENT CE DEGRÉ TRÈS PERFORMANT DANS LES USINAGES DE MATÉRIAUX ISO M E S. - PLAQUETTE À HAUTE RÉSISTANCE AUTORISANT DES USINAGES MOYENNEMENT INTERROMPUS MÊME DE MATÉRIAUX ISO S.
<ul style="list-style-type: none"> - WEAR-RESISTANT SUBSTRATE - VERSATILE INSERT, SUITABLE FOR BOTH ROUGHING AND FINISHING, ALSO UNDER UNFAVOURABLE CONDITIONS 	<ul style="list-style-type: none"> - VERSCHLEISSFESTES SUBSTRAT - VIELSEITIGE WENDEPLATTE, SOWOHL ZUM SCHRUPPEN ALS AUCH ZUM SCHLICHTEN GEEIGNET, AUCH UNTER UNGÜNSTIGEN BEDINGUNGEN 	<ul style="list-style-type: none"> - SUBSTRAT RÉSISTANT À L'USURE - PLAQUETTE POLYVALENTE, POUR ÉBAUCHE ET FINITION, MÊME EN CAS DE CONDITIONS DÉFAVORABLES
<ul style="list-style-type: none"> - VERY TOUGH GRADE - EXCELLENT RESISTANCE TO WEAR 	<ul style="list-style-type: none"> - SEHR ZÄHE SORTE - OPTIMALE VERSCHLEISSFESTIGKEIT 	<ul style="list-style-type: none"> - QUALITÉ TRÈS TENACE - TRÈS BONNE RÉSISTANCE À L'USURE



HT CERMET

HW METALLO DURO NON RICOPERTO
UNCOATED CARBIDE
UNBESCHICHTETES HARTMETALL
MÉTAL DUR PAS RECOUVERT

HC METALLO DURO RICOPERTO
COATED CARBIDE
BESCHICHTETES HARTMETALL
MÉTAL DUR RECOUVERT

SAU	DIN ISO 513		MATERIALE - MATERIAL MATERIALIEN - MATÉRIAUX PAG. 1199						QUICK PICK PAG. 538	 Tenacità + Toughness -	 INDICAZIONI - USO
			P	M	K	N	S	H			
			ACCIAI STEELS STAHL ACIER	ACCIAI INOX STAINLESS STEELS ROSTFREIER STAHL ACIER INOXYDABLE	GHISA CAST IRON GRAUGUSS FONTE GRISE	MATTONI FERROSI NON FERROSI MAT. NICHT-EISENMATERIALIEN MAT. FERREUX	MAT DIFFICILI DIFFICULT MATERIAL SCHWERGE MATERIALIEN MAT. DIFICILES	MATERIALI DURI HARD MATERIALS HARTE MATERIALIEN MATÉRIAUX DURS			
F1335	HC	P25-45 M30-40	●	○					 	 	- LAVORAZIONI DI ACCIAIO GENERICHE - INDICATO PER LAVORAZIONI SUI PIÙ COMUNI ACCIAI A MEDIO BASSE VELOCITÀ DI TAGLIO E IN CONDIZIONI DI INSTABILITÀ.
	PVD										
F2335	HC	P25-50 M20-40	●	●	○				 	 	- LA SUA STRUTTURA E IL SUO RIVESTIMENTO RENDE QUESTO GRADO MOLTO TENACE E RESISTENTE ALLE ALTE TEMPERATURE. - PARTICOLARMENTE ADATTO A LAVORAZIONI DI FORTE TAGLIO INTERROTTO E LAVORAZIONI GRAVOSE.
	PVD	K20-40 S20-30									
T540	HC	P25-45 M25-40	●	●		○			 	 	- ALTA TENACITÀ , BUONA RESISTENZA ALL' USURA E ALLO SHOCK TERMICO - INDICATO PER BASSE VELOCITÀ DI TAGLIO E ALTI AVANZAMENTI IN SGROSSATURA E SGROSSATURA PESANTE ANCHE IN CONDIZIONI PRECARE
	CVD										
T544	HC	P20-40 M20-35	●	●	○	○			 	 	- ALTA TENACITÀ MEDIA RESISTENZA ALL' USURA - INDICATO PER MEDIO-BASSE VELOCITÀ DI TAGLIO IN MEDIA SGROSSATURA ANCHE IN CONDIZIONI INSTABILI
	CVD										
F4345	HC	P35-45 M40-45	●	○					 	 	- GRADO MOLTO TENACE PER LAVORAZIONE DI INSTABILITÀ E LAVORAZIONE A TAGLIO MOLTO INTERROTTO. - INDICATO PER SGROSSATURA DI ACCIAI GENERICI.
	PVD										

- APPLICAZIONE CONSIGLIATA
RECOMMENDED APPLICATION
EMPFOHLENER EINSATZ
APPLICATION CONSEILLÉE
- APPLICAZIONE POSSIBILE
POSSIBLE APPLICATION
MÖGLICHE ANWENDUNG
APPLICATION POSSIBLE
- APPLICAZIONE CONSIGLIATA
RECOMMENDED APPLICATION
EMPFOHLENER EINSATZ
APPLICATION CONSEILLÉE
- APPLICAZIONE POSSIBILE
POSSIBLE APPLICATION
MÖGLICHE ANWENDUNG
APPLICATION POSSIBLE

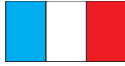
 INDICATIONS - USE	 GEBRAUCHSANWEISUNGEN	 INDICATION - USAGE
- GENERAL MACHINING OF STEEL. SPECIALLY - SUITABLE FOR MACHINING THE MOST COMMON STEEL TYPES WITH LOW-MEDIUM CUTTING SPEED UNDER STABLE MACHINING CONDITIONS.	- ALLGEMEINE STAHLBEARBEITUNG - GEEIGNET FÜR DIE BEARBEITUNG DER GÄNGIGSTEN STAHLSORTEN MIT NIEDRIG-MITTLEREN SCHNITTGESCHWINDIGKEITEN UNTER STABILEN ARBEITSBEDINGUNGEN.	- USINAGES D'ACIER GÉNÉRIQUES - PRÉVU POUR DES USINAGES SUR LES ACIERS LES PLUS COMMUNS À DES VITESSES DE COUPE BASSES-MOYENNES ET DANS UN ÉTAT D'INSTABILITÉ.
- THIS GRADE'S STRUCTURE AND COATING MAKE IT VERY TOUGH AND HIGH TEMPERATURE-RESISTANT. - ESPECIALLY SUITED FOR STRONG INTERRUPTED-CUTTING MACHINING AND STRENUOUS MACHINING	- AUFGRUND SEINER FEINKÖRNIGEN STRUKTUR, ZUSAMMENSETZUNG UND BESCHICHTUNG IST DIESER TYP BEI DER BEARBEITUNG VON ISO-M- UND S-MATERIALIEN BESONDERS LEISTUNGSFÄHIG. - ZÄHE WENDESCHNEIDPLATTE, DIE AUCH DURCHSCHNITTLICH UNTERBROCHENE BEARBEITUNGEN VON ISO-MATERIALIEN ERMÖGLICHT.	- SA STRUCTURE ET SON REVETEMENT RENDENT CE DEGRE TRES TENACE ET RESISTANT AUX TEMPERATURES ELEVEES. - PARTICULIEREMENT INDIQUE AUX USINAGES D'UNE COUPE FORTE INTERROMPUE ET D'USINAGES PENIBLES.
-HIGH TOUGHNESS, RESISTANCE TO WEAR AND TO THERMAL SHOCK -SUITABLE FOR LOW CUTTING SPEEDS AND HIGH FEED FOR ROUGHING AND HEAVY ROUGHING, EVEN UNDER UNSTABLE CONDITIONS	-FÜR MITTEL-HOHE SCHNITTGESCHWINDIGKEITEN UND BEI MITTLEREN VORSCHÜBEN UNTER NORMALEN BEDINGUNGEN GEEIGNET -FÜR NIEDRIGE SCHNITTGESCHWINDIGKEITEN UND GROSSVORSCHÜBE BEIM SCHRUPPEN UND STARKEN SCHRUPPEN, AUCH UNTER UNSTABILEN BEDINGUNGEN, GEEIGNET.	-HAUTE TENACITÉ, RÉSISTANCE À L'USURE ET AU SHOCK THERMIQUE -INDIQUÉE POUR FAIBLE VITESSE DE COUPE ET HAUT DÉPLACEMENT POUR ÉBAUCHAGE ET ÉBAUCHAGE LOURD, MÊME AVEC CONDITIONS INSTABLES.
-HIGH TOUGHNESS, MEDIUM RESISTANCE TO WEAR -SUITABLE FOR MEDIUM - LOW CUTTING SPEEDS FOR MEDIUM ROUGHING, EVEN UNDER UNSTABLE CONDITIONS	-FÜR MITTEL-HOHE SCHNITTGESCHWINDIGKEITEN UND BEI MITTLEREN VORSCHÜBEN -FÜR MITTEL - NIEDRIGE SCHNITTGESCHWINDIGKEITEN BEIM MITTEL - STARKEN SCHRUPPEN, AUCH UNTER UNSTABILEN BEDINGUNGEN, GEEIGNET	-HAUTE TENACITÉ, MOYENNE RÉSISTANCE À L'USURE -INDIQUÉE POUR MOYENNE - FAIBLE VITESSE DE COUPE EN ÉBAUCHAGE MOYEN MÊME AVEC CONDITIONS INSTABLES
- VERY TOUGH GRADE FOR INSTABILITY MACHINING AND VERY INTERRUPTED-CUTTING MACHINING. - SUITABLE FOR ROUGHING OF GENERAL STEELS.	- SEHR ZÄHE SORTE FÜR INSTABILE BEARBEITUNGEN UND BEARBEITUNGEN MIT STARK UNTERBROCHENEM SCHNITT. - GEEIGNET ZUM SCHRUPPEN VON ALLGEMEINEN STÄHLEN.	- DEGRÉ TRÈS TENACE POUR L'USINAGE D'INSTABILITÉ ET L'USINAGE À COUPE TRÈS INTERROMPUE. - INDIQUÉ POUR LE DÉGROSSISSAGE D'ACIERS GÉNÉRIQUES.

HT CERMET

HW METALLO DURO NON RICOPERTO UNCOATED CARBIDE UNBESCHICHTETES HARTMETALL MÉTAL DUR PAS RECOUVERT

HC METALLO DURO RICOPERTO COATED CARBIDE BESCHICHTETES HARTMETALL MÉTAL DUR RECOUVERT

MATERIALE MATERIAL MATERIALIEN MATERIAUX PAG 1199	VDI 3323 GR.	HB HRC Rm	C4010	N3015	N3815	N6315	N3620	N3440	T110	T115	T120	F7810	F7115 NEW
P ACCIAI STEELS STAHL ACIER	1	125	300-420									220-300	100-250
	2	180	280-350									220-300	100-250
	3	250	220-320									220-300	100-250
	4	220	250-300									220-300	100-250
	5	300	180-260									220-300	100-250
	6	180	140-200									180-250	100-250
	7-8	250-300	160-220									180-250	100-250
	9	350	100-160									180-250	80-150
	10	200	100-160									160-220	80-150
	11	350	240-350									160-220	80-150
	12	200	140-250									120-200	80-150
	13	330	140-250									120-200	80-150
	M ACCIAI INOX STAINLESS STEELS ROSTFREIER STAHL ACIER INOXYDABLE	14.1	180	100-280								80-120	80-150
14.2		230-260	100-220									80-150	80-150
K GHISA CAST IRON GRAUGUSS FONTE GRISE	15	180	180-400					100-200	90-160	90-160	90-145	180-320	100-200
	16	260	180-400					90-150	80-130	80-130	90-135	180-320	100-200
	17	160	150-250					100-180	90-160	100-160	90-135	180-300	100-200
	18	250	150-300					70-140	70-150	90-150	70-100	180-300	100-200
	19	130	150-300					90-180	90-160	100-160	90-145	180-300	100-200
	20	230	150-300					70-160	70-150	70-150	80-120	180-300	100-200
N MAT/NOI FERROSI NON-FERROUS MAT. NICHT-EISENMATERIALIEN MAT. FERREUX	21	60		200-800	300-950	250-350	400-450	100-800	200-950	200-950	300-950		200-300
	22	100		200-800	300-950	250-350	400-450	80-800	200-950	200-950	300-950		200-300
	23	75		200-800	300-950	250-350	400-450	80-500	200-950	200-950	300-950		200-300
	24	90		200-800	300-950	250-350	400-450	100-450	200-950	200-950	300-800		200-300
	25	130		200-800	300-950	250-350	400-450	100-450	200-950	200-950	300-600		200-300
	26	110		200-300	120-400	250-350	250-335	80-400	200-600	200-600	150-500		200-300
	27	90		200-300	120-400	250-350	250-335	200-600	250-950	250-950	300-600		200-300
	28	100		200-300	120-400	250-350	250-335	100-300	150-600	150-600	150-450		200-300
	29			200-300	120-400	250-350	350-400	80-500	70-500	70-500			200-300
	30			200-300	120-400	250-350	350-400	100-250	80-300	80-300			200-300
S MATDIFFICILI DIFFICULT MATERIAL SCHWIERIGE MATERIALIEN MAT. DIFICILES	31	200		30-130									
	32	280		30-130					20-30				
	33	250		30-130					16-24		20-25		
	34	350		30-130					13-20		10-20		
	35	320		30-130							10-20		
	36	Rm400		30-130							25-30		
	37	Rm1050		30-130									
H MATERIALI DURI HARD MATERIALS HARTE MATERIALIEN MATERIAUX DURS	38	55HRC									25-30	65-145	100-150
	39	60HRC										65-95	100-150
	40	400										65-95	100-150
	41	55HRC										65-95	100-150

MATERIALE MATERIAL MATERIALIEN MATÉRIAUX PAG 1199	VDI 3323 GR.	HB HRC Rm	F2425	T2035	F2135	F2435	F2635	F4635	F2540 NEW	F5105	F3110 NEW	F3710	T1415
P ACCIAI STEELS STAHL ACIER	1	125	130-250			170-190	60-280	120-260		220-310			220-400
	2	180	130-250			170-190	60-280	120-260		220-310			220-400
	3	250	130-250			170-190	60-280	120-260		220-310			220-400
	4	220	130-250			170-190	60-280	120-260		220-310			220-400
	5	300	130-250			170-190	60-280	120-260		220-310			220-400
	6	180	130-250			90-150	60-220	120-220		270-300			220-400
	7-8	250-300	60-180			90-150	60-220	100-180		270-300			200-320
	9	350	60-180			90-150	60-220	100-180		270-300			200-320
	10	200	80-200			120-200	60-200	80-150		210-250			180-320
	11	350	80-200			120-200	60-200	80-150		210-250			180-320
	12	200	120-250			140-180	60-200	80-150		150-200			200-320
	13	330	120-250			140-180	60-200	80-150		150-200			200-320
	M ACCIAI INOX STAINLESS STEELS ROSTFREIER STAHL ACIER INOXYDABLE	14.1	180	100-250	60-200	110-180	110-200	60-200	90-120	100-160	100-180		
14.2		230-260	40-160	60-200	80-130	55-150	60-200	80-140	70-120	100-180			
K GHISA CAST IRON GRAUGUSS FONTE GRISE	15	180						110-190		260-330	280-380	120-250	140-370
	16	260						110-190		260-330	280-380	120-250	140-370
	17	160						110-190		230-280	240-320	120-250	190-430
	18	250						110-190		230-280	240-320	100-200	190-430
	19	130						110-190		230-280	240-320	100-200	180-520
	20	230						110-190		230-280	240-320	100-200	180-520
N MAT/NOI FERROSI NON-FERROUS MAT. NICHT-EISENMATERIALIEN MAT. FERREUX	21	60											
	22	100											
	23	75											
	24	90											
	25	130											
	26	110											
	27	90											
	28	100											
	29												
	30												
S MAT/DIFFICILI DIFFICULT MATERIAL SCHWIERIGE MATERIALIEN MAT. DIFFICILES	31	200		25-75	30-65					40-80		30-70	
	32	280		25-75	30-65					40-80		30-70	
	33	250		25-75	30-65					40-80		30-70	
	34	350		25-75	30-65					40-80		30-70	
	35	320		25-75	30-65					40-80		30-70	
	36	Rm400		25-75	30-65					40-80		30-70	
	37	Rm1050		25-75	30-65					40-80		30-70	
H MATERIALI DURI HARD MATERIALS HARTE MATERIALIEN MATÉRIAUX DURS	38	55HRC								80-140			
	39	60HRC								80-140			
	40	400								80-140			
	41	55HRC								80-140			

MATERIALE MATERIAL MATERIALIEN MATERIAUX PAG 1199	VDI 3323 GR.	HB HRC Rm	T3115	T516	T3116	T1120	F3120	T3220	T5020	T1025	T1425	F4725	T526
P ACCIAI STEELS STAHL ACIER	1	125				190-290	200-300	200-340	150-250	120-240	170-240	120-250	130-350
	2	180				190-290	200-300	200-340	150-250	120-240	170-240	120-250	110-320
	3	250				190-290	200-300	200-340	150-250	150-220	170-240	120-250	90-280
	4	220				190-290	200-300	200-340	150-250	110-190	170-240	120-250	100-280
	5	300				190-290	200-300	200-340	150-250	110-190	170-240	120-250	90-250
	6	180				160-230	180-250	200-340	150-250	110-190	170-240	120-250	80-250
	7-8	250-300				160-230	180-250	150-290	150-250	100-220	100-190	120-250	60-210
	9	350				145-210	180-250	150-290	150-250	80-180	130-210	100-220	60-180
	10	200				145-210	160-220	160-290	150-250	70-160	130-210	100-220	60-210
	11	350				145-210	160-220	160-290	150-250	70-160	130-220	100-220	60-170
	12	200				110-170	120-180	160-290	150-250	90-160	130-220	80-180	80-190
	13	330				110-170	120-180	160-290	150-250	90-160	130-220	80-180	70-170
	M ACCIAI INOX STAINLESS STEELS ROSTFREIER STAHL ACIER INOXYDABLE	14.1	180									100-210	120-250
14.2		230-260									70-100	120-250	120-210
K GHISA CAST IRON GRAUGUSS FONTE GRISE	15	180	180-350	180-350	180-360		150-320	150-400	100-250		130-210		120-220
	16	260	140-250	140-280	180-360		150-320	150-400	100-250		130-210		80-170
	17	160	130-250	130-250	140-230		150-320	200-450	100-250		120-240		80-200
	18	250	100-200	100-200	140-250		110-180	200-450	100-250		120-240		70-180
	19	130	150-320	150-320	110-220		110-180	200-550	100-250		150-250		70-180
	20	230	120-250	120-250	110-220		110-180	200-550	100-250		150-250		70-160
N MATRON FERROSI NONFERROUS MAT. NICHTEISENMATERIALIEN MAT. FERREUX	21	60											
	22	100											
	23	75											
	24	90											
	25	130											
	26	110											
	27	90											
	28	100											
	29												
	30												
S MATDIFFICILI DIFFICULT MATERIAL SCHWIERIGE MATERIALIEN MAT. DIFCILES	31	200											60-90
	32	280											60-90
	33	250											
	34	350											
	35	320											
	36	Rm400											
	37	Rm1050											
H MATERIALI DURI HARD MATERIALS HARTE MATERIALIEN MATERIAUX DURS	38	55HRC											
	39	60HRC											
	40	400											70-130
	41	55HRC											

MATERIALE MATERIAL MATERIALIEN MATÉRIEAUX PAG 1199	VDI 3323 GR.	HB HRC Rm	T528N	F4128 NEW	T530	T1130 NEW	T1730	F4130	T5130	T5530 NEW	F7530 NEW	F4140	F4340
P ACCIAI STEELS STAHL ACIER	1	125	160-260		170-260	170-190	150-230	180-300	120-280	200-400	130-250	210-345	150-300
	2	180	130-220		150-240	170-190	150-230	180-300	100-250	200-400	130-250	210-345	100-250
	3	250	90-160		130-180	170-190	150-230	180-300	100-200	200-400	130-250	210-345	100-200
	4	220			120-170	170-190	150-230	180-300	120-250	200-400	130-250	175-290	100-220
	5	300			120-160	170-190	130-180	180-300	100-200	190-270	130-250	175-290	70-170
	6	180	150-220		140-200	170-190	130-180	130-250	80-180	190-270	100-220	145-240	100-220
	7-8	250-300	110-190		120-180	90-150	130-180	130-250	80-180	190-270	100-220	145-240	100-180
	9	350	90-160		100-120	120-200	130-180	130-250	80-180	190-270	100-220	145-240	100-160
	10	200	120-200	180-300	110-160	120-200	110-160	150-250	70-150	170-240		125-205	90-150
	11	350	90-140	180-300	80-100	140-180	110-160	150-250	70-150	170-240		125-205	70-150
	12	200	110-220	130-250	120-150	140-180	110-160	130-190	70-150	150-220		105-170	120-250
	13	330	90-180	130-250	80-120	140-200	110-160	130-190	70-150	150-220		105-170	60-120
	M ACCIAI INOX STAINLESS STEELS ROSTFREIER STAHL ACIER INOXYDABLE	14.1	180	120-180		100-150			130-270	90-150		100-200	110-235
14.2		230-260	80-120		80-120			100-180	90-150		60-160	85-150	70-130
K GHISA CAST IRON GRAUGUSS FONTE GRISE	15	180	160-220	180-300	160-190			120-220	150-300	200-280		110-180	
	16	260	120-180	180-300	100-120			120-220	100-200	200-280		110-180	
	17	160	110-210	120-160	140-180			120-220	100-200	190-240		95-150	
	18	250	90-180	120-160	120-150			120-220	100-200	160-230		95-150	
	19	130	90-180	90-150	140-200			100-170	100-200	150-220		85-130	
	20	230	80-160	90-150	130-165			100-170	100-200	150-220		85-110	
N MAT/IRON FERROSI NONFERROUS MAT. NICHT-EISENMATERIALIEN MAT. FERREUX	21	60			300-1000							500-900	
	22	100			300-1000							500-900	
	23	75			150-1000							500-900	
	24	90			150-1000							500-700	
	25	130			150-700							500-700	
	26	110			100-400							330-550	
	27	90			100-400							330-550	
	28	100			100-400							330-550	
	29											500-900	
	30											500-900	
S MAT/DIFFICILI DIFFICULT MATERIAL SCHWIERIGE MATERIALIEN MAT. DIFICILES	31	200	40-70								20-60	30-50	
	32	280	30-40								20-60	30-50	
	33	250	30-50		40-60						20-60	30-50	
	34	350	30-50		30-40						20-60	25-50	
	35	320	40-50		40-50						20-60	25-50	
	36	Rm400	60-80		40-70						40-80	50-80	
	37	Rm1050			30-50						40-80	50-80	
H MATERIALI DURI HARD MATERIALS HARTE MATERIALIEN MATÉRIEAUX DURS	38	55HRC		60-100				40-90				100-140	
	39	60HRC		50-70				30-60				80-110	
	40	400		80-140				50-100				100-140	
	41	55HRC		60-100				40-90				100-140	

MATERIALE MATERIAL MATERIALIEN MATERIAUX PAG 1199	VDI 3323 GR.	HB HRC Rm	F4144 NEW	T1435	F3010	F6315	T5120	T525	F1325	F2330	F2331	F1035	F1335
P ACCIAI STEELS STAHL ACIER	1	125	220-280	170-190		110-160	200-400	200-400	175-265	220-290	220-300	70-180	150-230
	2	180	220-280	170-190		110-160	200-400	170-320	175-265	220-290	220-300	70-180	150-230
	3	250	220-280	170-190		110-160	200-400	170-280	175-265	220-290	220-300	70-180	150-230
	4	220	220-280	170-190		110-160	200-400	180-280	175-265	220-290	220-300	70-180	150-230
	5	300	220-280	170-190		110-160	190-270	140-230	145-215	220-290	220-300	70-170	130-180
	6	180	180-220	170-190		110-160	190-270	190-310	145-215	180-240	170-240	70-170	130-180
	7-8	250-300	180-220	90-150		110-160	190-270	130-240	145-215	180-240	170-240	70-170	130-180
	9	350	180-220	120-200		110-160	190-270	100-170	145-215	180-240	170-240	70-170	130-180
	10	200	140-200	120-200		110-160	170-240	170-240	130-190	160-220	140-220	60-140	110-160
	11	350	140-200	140-180		110-160	170-240	100-160	130-190	160-220	140-220	60-140	110-160
	12	200	120-180	140-180		110-160	150-220	200-300	130-190	140-200	140-220	60-140	110-160
	13	330	120-180	140-200		110-160	150-220	100-150	130-190	140-200	140-220	60-140	110-160
	M ACCIAI INOX STAINLESS STEELS ROSTFREIER STAHL ACIER INOXYDABLE	14.1	180	135-165			90-120		160-260	90-150	155-190	120-180	40-140
14.2		230-260	100-140			90-120		130-220	60-110	120-150	100-160	40-140	80-140
K GHISA CAST IRON GRAUGUSS FONTE GRISE	15	180			130-200	80-120	200-280	150-250	140-300				
	16	260			130-200	80-120	200-280	150-200	140-300				
	17	160			130-200	80-120	190-240	150-220	140-300				
	18	250			130-200	80-120	160-230	120-160	140-300				
	19	130			100-150	80-120	150-220	150-240	100-160				
	20	230			100-150	80-120	150-220	120-180	100-160				
N MAT. NON FERROSI NON FERROUS MAT. NICHT-EISENMATERIALIEN MAT. FERREUX	21	60											
	22	100											
	23	75											
	24	90											
	25	130											
	26	110											
	27	90											
	28	100											
	29												
	30												
S MAT. DIFFICILI DIFFICULT MATERIAL SCHWERIGE MATERIALIEN MAT. DIFFICILES	31	200	40-65							40-75			
	32	280	40-65							40-75			
	33	250	40-65					35-40		40-75			
	34	350	40-65					35-40		40-75			
	35	320	40-65					35-40		40-75			
	36	Rm400	40-65					50-75		40-75			
	37	Rm1050	40-65							40-75			
H MATERIALI DURI HARD MATERIALS HARTE MATERIALIEN MATERIAUX DURS	38	55HRC						40-70					
	39	60HRC											
	40	400											
	41	55HRC											

MATERIALE MATERIAL MATERIALIEN MATÉRIAUX PAG 1199	VDI 3323 GR.	HB HRC Rm	F2335	T540	T544	F4345							
P ACCIAI STEELS STAHL ACIER	1	125	220-280	170-250	170-260	100-220							
	2	180	220-280	140-200	150-240	100-220							
	3	250	220-280	120-150	130-180	100-220							
	4	220	220-280	110-150	120-170	100-220							
	5	300	220-280	100-120	120-160	140-215							
	6	180	180-220	140-200	140-200	140-215							
	7-8	250-300	180-220	100-140	120-180	140-215							
	9	350	180-220	70-100	100-120	140-215							
	10	200	140-200	90-130	110-160	130-190							
	11	350	140-200	60-100	80-100	130-190							
	12	200	120-180	120-170	120-150	130-190							
	13	330	120-180	80-130	80-120	130-190							
	M ACCIAI INOX STAINLESS STEELS ROSTFREIER STAHL ACIER INOXYDABLE	14.1	180	135-165	70-180	100-150	70-130						
14.2		230-260	100-140	60-130	80-120								
K GHISA CAST IRON GRAUGUSS FONTE GRISE	15	180	215-265		160-190								
	16	260	215-265		100-120								
	17	160	180-240		140-180								
	18	250	180-240		120-150								
	19	130	180-240		140-200								
	20	230	180-240		130-165								
N MAT. NON FERROSI NON FERROUS MAT. NICHT-EISENMATERIALIEN MAT. FERREUX	21	60		300-1000	300-1000								
	22	100		300-700	300-1000								
	23	75		300-700	150-1000								
	24	90		300-500	150-1000								
	25	130		250-350	150-700								
	26	110		400-500	100-400								
	27	90		250-350	100-400								
	28	100			100-400								
	29												
	30												
S MAT. DIFFICILI DIFFICULT MATERIAL SCHWERIGE MATERIALIEN MAT. DIFICILES	31	200	40-65	35-100									
	32	280	40-65	35-70									
	33	250	40-65		40-60								
	34	350	40-65	20-60	30-40								
	35	320	40-65	40-60	40-50								
	36	Rm400	40-65	40-60	40-70								
	37	Rm1050	40-65		30-50								
H MATERIALI DURI HARD MATERIALS HARTE MATERIALIEN MATÉRIAUX DURS	38	55HRC											
	39	60HRC											
	40	400											
	41	55HRC											

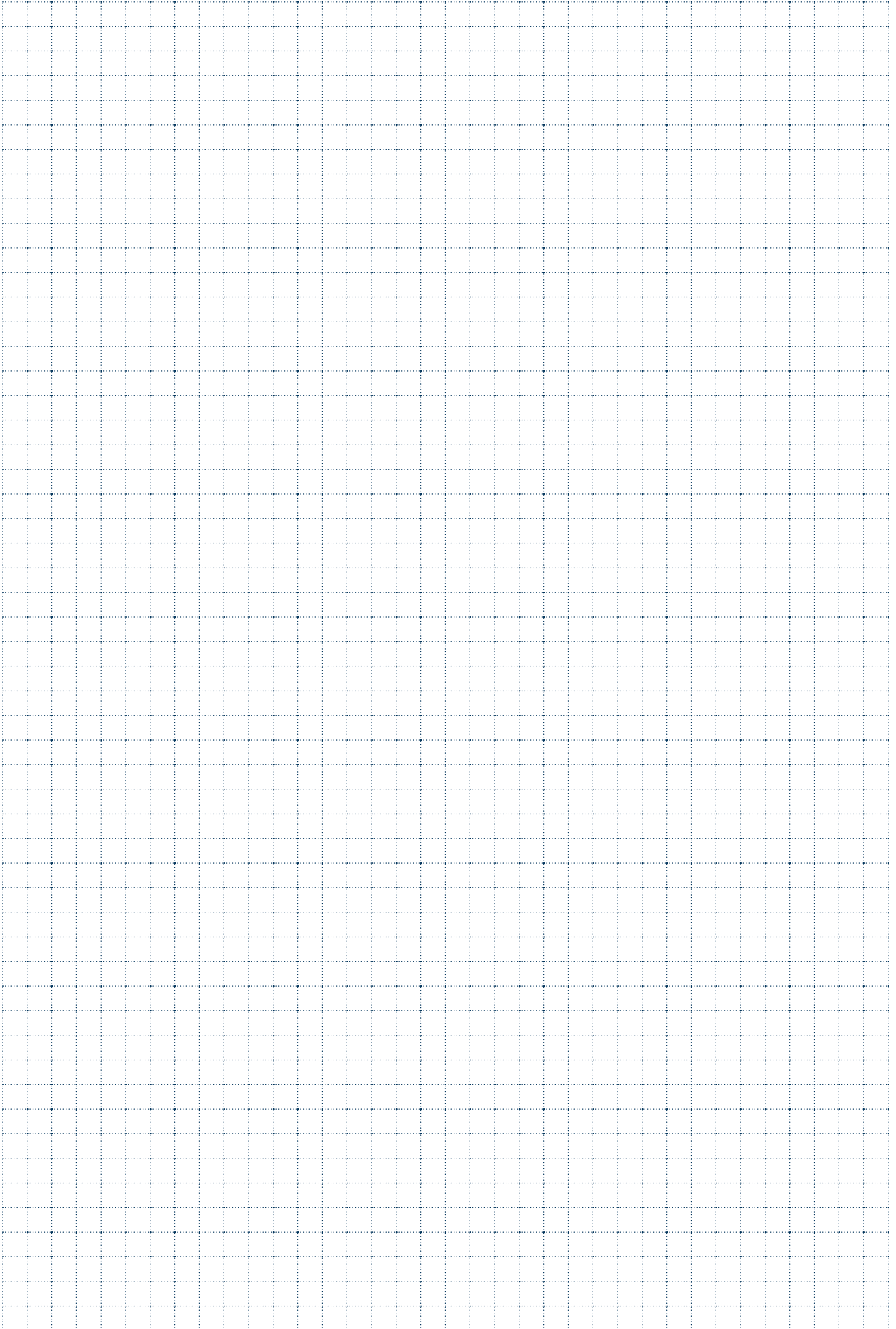



FORATURA LAVORAZIONE FORI

DRILLING - MACHINING OF BORES / BOHREN - BEARBEITUNG VON BOHRUNGEN /
PERÇAGE - USINAGE DES TROUS / TALADRAR - TRABAJO DE LOS AGUJEROS





	PUNTE INTEGRALI IN METALLO DURO	
	SOLID CARBIDE DRILLS	
	HM VOLLBOHRER	
	FORETS EN CARBURE MONOBLOC	
	BROCAS INTEGRALES EN METAL DURO	

Pag. 563

	PUNTE AD INSERTI	
	INDEXABLE INSERTS DRILLING TOOLS	
	WENDEPLATTEVOLLBOHRER	
	FORET À PLAQUETTES	
	BROCAS CON PLAQUITAS	

Pag. 650

	UTENSILI PER LAVORAZIONE FORI	
	TOOLS FOR MACHINING BORES	
	WERKZEUGE ZUR BEARBEITUNG VON BOHRUNGEN	
	OUTILS POUR USINAGE TROUS	
	HERRAMIENTAS PARA TRABAJO DE LOS AGUJEROS	

Pag. 666

	INSERTI PER FORATURA	
	DRILLING INSERTS	
	WENDEPLATTEN ZUM BOHREN	
	PLAQUÉTTES POUR PERÇAGE	
	PLAQUITAS DE TALADRADO	

Pag. 683

	INSERTI PER LAVORAZIONE FORI	
	INSERTS FOR MACHINING BORES	
	WENDEPLATTEN ZUR BEARBEITUNG VON BOHRUNGEN	
	PLAQUETTES POUR USINAGE TROUS	
	PLAQUITAS PARA TRABAJO DE LOS AGUJEROS	

Pag. 697

**INDICAZIONI DI LETTURA
READING INSTRUCTIONS
HINWEISE ZUR ABLESUNG
INDICATIONS DE LÉCTURE**

SAU SDF1201 technical manual page. It includes a diagram of a drill with a coolant bore, callouts 1-7, and a large table of technical data. Callouts 1-7 point to various parts of the diagram and table. Callouts 1B-5B point to specific sections of the table.



- 1 = DESCRIZIONE ARTICOLO
- 2 = PRESSIONE/VOLUME DEL REFRIGERANTE PER PUNTE FORATE
- 3 = CARATTERISTICHE TECNICHE (PAG. 565)
- 4 = TOLLERANZE COSTRUTTIVE
- 5 = ELENCO ARTICOLI
- 6 = MISURE E DATI
- 7 = ULTERIORI DATI TECNICI E CONSIGLIO D'USO
- 1B = LAVORAZIONI ESEGUIBILI
- 2B = GRUPPI MATERIALI
- 3B = INDICAZIONE MATERIALI LAVORABILI E CAMPI D'IMPIEGO
- 4B = PARAMETRI DI LAVORO
- 5B = FORMULE E PARAMETRI



- 1 = ITEM DESCRIPTION
- 2 = COOLANT PRESSURE/VOLUME FOR DRILLS WITH COOLANT BORE
- 3 = TECHNICAL FEATURES (PAG. 565)
- 4 = CONSTRUCTIVE TOLERANCE
- 5 = ITEM
- 6 = MEASURES AND DATA
- 7 = FURTHER TECHNICAL DATA AND SUGGESTIONS
- 1B = POSSIBLE MACHINING OPERATIONS
- 2B = MATERIAL GROUPS
- 3B = INFORMATION ON WORKABLE MATERIALS AND FIELDS OF APPLICATION
- 4B = MACHINING PARAMETERS
- 5B = FORMULAS AND PARAMETERS



- 1 = ARTIKELBESCHREIBUNG
- 2 = SCHMIERSTOFFDRUCK-/VOLUMEN FÜR KÜHLKANALBOHRER
- 3 = TECHNISCHE HAUPTMERKMALE (PAG. 565)
- 4 = KONSTRUKTIONSTOLERANZEN
- 5 = ARTIKEL
- 6 = ABMESSUNGEN UND DATEN
- 7 = WEITERE TECHNISCHE DATEN UND TIPPS
- 1B = MÖGLICHE BEARBEITUNGEN
- 2B = MATERIALGRUPPEN
- 3B = ANGABE DER BEARBEITBAREN MATERIALIEN UND ANWENDUNGSGEBIETE
- 4B = SCHNITTDATEN
- 5B = FORMELN UND PARAMETER



- 1 = DESCRIPTION ARTICLES
- 2 = PRESSION/VOLUME DU RÉFRIGÉRANT POUR FORETS AVEC TROUS D'ARROSAGE
- 3 = CARACTERISTIQUES TECHNIQUES (PAG. 565)
- 4 = TOLÉRANCE CONSTRUCTIVES
- 5 = ARTICLES
- 6 = DIMENSIONS ET DONNÉES
- 7 = ULTÉRIEURES DONNÉES TECHNIQUE ET CONSEILLE D'USAGE
- 1B = USINAGES A EXECUTER
- 2B = GROUPES DE MATERIAUX
- 3B = INDICATION MATERIAUX A USINER ET PLACES D'APPLICATION
- 4B = PARAMÈTRES DE TRAVAIL
- 5B = FORMULES ET PARAMÈTRES

SAU SDF1201 technical manual page. It includes a diagram of a drill with a coolant bore, callouts 1-10, and a large table of technical data. Callouts 1-10 point to various parts of the diagram and table. Callouts 1B-10B point to specific sections of the table.



- 1 = ARTICOLO + GAMMA DIAMETRI
- 2 = INSERTI CONSIGLIATI
- 3 = ELENCO ARTICOLI
- 4 = MISURE, DATI, INDICAZIONI
- 5 = ACCESSORI IN DOTAZIONE
- 6 = ACCESSORI E RICAMBI OPZIONALI A RICHIESTA
- 7 = GRANDEZZA INSERTO
- 8 = LAVORAZIONI POSSIBILI
- 9 = PROFONDITÀ DI FORATURA L2/D
- 10 = DATI TECNICI E CONSIGLI D'USO
- 1B = ELENCO INSERTI
- 2B = INDICAZIONE MATERIALI LAVORABILI
- 3B = DISPONIBILITÀ GRADI
- 4B = MISURE E DATI
- 5B = SCELTA DEL GRADO (QUICK PICK)
- 6B = SCELTA DELL'INSERTO
- 7B = GRUPPI MATERIALI
- 8B = AVANZAMENTO AL GIRO fn
- 9B = VELOCITÀ DI TAGLIO Vc
- 10B = FORMULE E PARAMETRI



















- 1 = ITEM + DIAMETER RANGE
- 2 = RECOMMENDED INSERTS
- 3 = ITEMS
- 4 = MEASURES, DATA, INDICATIONS
- 5 = ACCESSORIES EQUIPMENT
- 6 = OPTIONAL ACCESSORIES AND SPARE PARTS ON REQUEST
- 7 = INSERT SIZE
- 8 = POSSIBLE TYPES OF MACHINING
- 9 = DRILLING DEPTH L2/D
- 10 = TECHNICAL DATA AND SUGGESTIONS
- 1B = AVAILABLE INSERTS
- 2B = RECOMMENDED MACHINING MATERIALS
- 3B = AVAILABLE GRADES
- 4B = MEASURES AND DATA
- 5B = GRADE CHOICE (QUICK PICK)
- 6B = INSERT CHOICE
- 7B = MATERIAL GROUPS
- 8B = fn FEED/REVOLUTION
- 9B = CUTTING SPEED Vc
- 10B = FORMULAS AND PARAMETERS





- 1 = ARTIKEL + DURCHMESSERBEREICH
- 2 = EMPFOHLENE WENDESCHNEIDPLATTEN
- 3 = ARTIKEL
- 4 = ABMESSUNGEN, DATEN, HINWEISE
- 5 = ZUBEHÖR AUSSTATTUNG
- 6 = OPTIONALZUBEHÖR UND ERSATZTEILE AUF ANFRAGE
- 7 = WENDEPLATTENGROSSE
- 8 = MÖGLICHE BEARBEITUNGSARTEN
- 9 = BOHRRTIEFE L2/D
- 10 = TECHNISCHE DATEN UND TIPPS
- 1B = LIEFERBARE WENDEPLATTEN
- 2B = EMPFOHLENE WERKMATERIALIEN
- 3B = LIEFERBARE HM-QUALITÄTEN
- 4B = ABMESSUNGEN UND DATEN
- 5B = SORTENAUSWAHL (QUICK PICK)
- 6B = WAHL DER PLATTE
- 7B = MATERIALGRUPPEN
- 8B = VORSCHUB/UMDREHUNG
- 9B = SCHNITTGESCHWINDIGKEIT Vc
- 10B = FORMELN UND PARAMETER

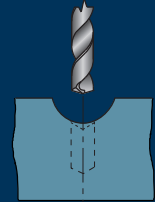
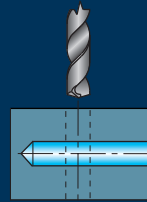
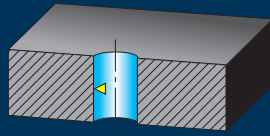
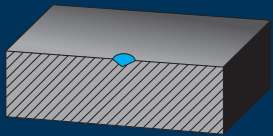

- 1 = ARTICLE + GAMME DE DIAMÈTRES
- 2 = PLAQUETTES CONSEILLÉES
- 3 = ARTICLES
- 4 = DIMENSIONS, DONNÉES, INDICATIONS
- 5 = ACCESSOIRES EN DOTATION
- 6 = ACCESSOIRES ET RECHANGE OPTIONNEL SUR DEMANDE
- 7 = DIMENSION DE LA PLAQUETTE
- 8 = USINAGES POSSIBLES
- 9 = PROFONDEUR DE PERÇAGE L2/D
- 10 = DONNÉES TECHNIQUES ET CONSEILLES D'USAGE
- 1B = PLAQUETTES DISPONIBLES
- 2B = INDICATIONS SUR LES MATERIAUX USINABLES
- 3B = DISPONIBILITÉ DE DEGRÉS
- 4B = DIMENSIONS ET DONNÉES
- 5B = CHOIX DU DEGRÉ (QUICK PICK)
- 6B = CHOIX DE LA PLAQUETTE
- 7B = GROUPES DE MATERIAUX
- 8B = DÉPLACEMENT PAR TOUR fn
- 9B = VITESSE DE COUPE Vc
- 10B = FORMULES ET PARAMÈTRES

	ART.	LUNGHEZZA ELICA LENGTH FLUTES	ØD	Z	MATERIALE MATERIAL	Materiali - Materials Pag. 1199							Pag.		
						P	M	K	N	S	H	G			
MICROPUNTE - MICRO-DRILLS															
	TIALN		SDM0301	3xD	0,4-2,9	2	MG	●	●	●	●	○	○	○	568
			SDMN0301	3xD	0,4-2,9	2	MG	●	○	●	●	○	○	○	570
	TIALN		SDM0501	5xD	0,7-2,9	2	MG	●	●	●	●	○	○	○	572
			SDMN0501	5xD	0,7-2,9	2	MG	●	○	●	●	○	○	○	574
	TIALN		SDM0310	3xD	0,5-2,9	2	MG	●	●	●	●	○	○	○	576
			SDMN0310	3xD	0,5-2,9	2	MG	●	○	●	●	○	○	○	578
	TIALN		SDM0510	5xD	0,5-2,9	2	MG	●	●	●	●	○	○	○	580
			SDMN0510	5xD	0,5-2,9	2	MG	●	○	●	●	○	○	○	582
PUNTE INTEGRALI IN HM - SOLID CARBIDE DRILLS															
	NRW		SD1800	2xD	1,5-12	2	MG	●	●	●	○	○	○	○	586
	TIALN		SDR0341	3xD	3-12	2	MG	●	○	○	○	○	○	○	588
	TIALN		SDR0302	3xD	3-20	2	MG	●	○	●	○	○	○	○	590
	TIALN		SDF0302	3xD	3-20	2	MG	●	●	●	○	○	○	○	592
	TIALN		SDR0502	5xD	3-20	2	MG	●	○	○	○	○	○	○	594
	TIALN		SDF0502	5xD	3-20	2	MG	●	○	○	○	○	○	○	596
	TIALN		SDF0802	8xD	3-16	2	MG	●	●	●	○	○	○	○	598
	TIALN		SDF1201	12xD	3-16	2	MG	●	●	●	○	○	○	○	600









		ART.	ANGOLO ELICA ANGLE FLUTES	ØD	Z	MATERIALE MATERIAL	Materiali - Materials Pag. 1199							Pag.
							P	M	K	N	S	H	G	
PUNTE A GRADINO - STEP DRILLS														
	TIALN		SDN0102	30°	3,4-11	2	MG	●	●	●	●	●	●	604
	TIALN		SDR0102	30°	2,5-14	2	MG	●	●	●	●	●	●	606
PUNTE A CENTRARE - PUNTA PILOTA - CENTER DRILLS - PILOT DRILL														
	TIALN		SCR0184	30°	3-20	2	MG	●	○	●	○	●	●	610
	TIALN		SCR0185	30°	6-20	2	MG	●	○	●	○	●	●	612
	TIALN		SCR0186	30°	6-20	2	MG	●	○	●	○	●	●	614
	TIALN		SDF0371	30°	2-12	2	MG	●	●	●	●	●	●	616
PUNTE FORALESA - REAMER-DRILLS														
	TIALN		SPFAR3	30°	2,97-20,02	2	MG	●	●	●	●	●	●	620
	TIALN		SPFAR5	30°	2,97-20,02	2	MG	●	●	●	●	●	●	622
ALESATORI - REAMERS														
			SAN0508	6°	3-18	4/8	MG	●	●	●	●	●	●	626
			SAN0509	6°	2,97-18,20	4/8	MG	●	●	●	●	●	●	628
			SAN0708	6°	1-20,2	4/8	MG	●	●	●	●	●	●	630
			SAN0709	6°	0,90-20,20	4/8	MG	●	●	●	●	●	●	632
			SAN0808	6°	1,5-12,2	4/6	MG	●	●	●	●	●	●	634
			SAN0809	6°	2,00-12,20	4/6	MG	●	●	●	●	●	●	636
	NEW		SAN0308	5°	12-25	6	MG	●	●	●	●	●	●	638
	NEW		SAN0309	5°	12-25,21	6	MG	●	●	●	●	●	●	640
	NEW		SAN0408	5°	6-25	4/6	MG	●	●	●	●	●	●	642
	NEW		SAN0409	5°	5,90-25,21	4/6	MG	●	●	●	●	●	●	644
			SAN0208	6°	1-35,2	4/10	HSSE	●	●	●	●	●	●	646
			SAN0209	6°	0,70-35,20	4/10	HSSE	●	●	●	●	●	●	648

SIMBOLOGIA - SYMBOL - SYMBOLE - SYMBOLES





RIVESTIMENTI - COATED - BESCHICHTUNG - RECOUVREMENT

RIVESTIM. COATED	TIALN: Elevata durezza e resistenza al calore, basso coefficiente di attrito, si può usare con refrigerante oppure a secco con aria.	RIVESTIM. COATED	Bronze: Rivestimento innovativo dalle ottime prestazioni, che offre resistenza all'ossidazione, stabilità termica elevata ed una notevole resistenza all'usura nella lavorazione di acciai, materiali sfidanti come titanio, leghe di nichel e acciaio inossidabile.
TIALN	TIALN: High degree of hardness and heat resistance, low friction coefficient; it can be used with coolant or with air and no coolant	BRONZE	Bronze: innovative coating with excellent performance providing oxidation resistance, high thermal stability, and remarkable wear resistance in the machining of steels and challenging materials such as titanium, nickel alloys and stainless steel.









AFFILATURA TESTA - HEAD SHARPENING - KOPFSCHLIFF - AFFUTAGE TETE

	- Autocentrante - Tipo S - Self centering - S Type - Selbstzentrierend - Type S - A centrage automatique - Type S		- Autocentrante - Tipo 4F - Self centering - 4F Type - Selbstzentrierend - Type 4F - A centrage automatique - Type 4F		- Autocentrante - refrigerata - Tipo 4F - Self centering - with coolant - 4F Type - Selbstzentrierend - gekühlt - Type 4F - A centrage automatique-refrigere - Type 4F
	- Doppio pattino - Tipo 4F - Double ski drills - 4F Type - Doppel-Ski-Bohrer - Type 4F - Double de ski perceuses - Type 4F		- Doppio pattino - refrigerata - Tipo 4F - Double ski drills - with coolant - 4F Type - Doppel-Ski-Bohrer - gekühlt - Type 4F - Double de ski perceuses - refrigere - Type 4F		- Punta a centrare - Center drills - Zentrierbohrer - Pointes a centrer
	- Punta Foralesa - Reamer-Drills - Reibählen-Bohrer - Forets de perçage et alésage				

ANGOLO ELICA - FLUTES DEGREES - SPIRALWINKEL - ANGLE HELICE

	■ 20°		■ 30°		■ 6°		■ 5°
---	-------	---	-------	---	------	---	------

ANGOLO DI TESTA - HEAD ANGLE - KOPFKEGELWINKEL - ANGLE DE TETE

	■ 90°		■ 118°		■ 120°		■ 135°
	■ 140°		■ 142°		■ 145°		■ 180°

NORME - STANDARDS - NORMEN - NORMES

DIN 338	■ DIN 338	DIN 1897	■ DIN 1897	DIN 6535	■ DIN 6535
DIN 6537	■ DIN 6537	DIN 6539	■ DIN 6539		

LUNGHEZZA PUNTA - DRILL LENGHT - BOHRERLÄNGE - LONGUEUR POINTE

2xD	- 2 volte il diametro - Two times the diameter - Zweimal den Durchmesser - 2 fois le diamètre	3xD	- 3 volte il diametro - Three times the diameter - Dreimal den Durchmesser - 3 fois le diamètre	5xD	- 5 volte il diametro - Five times the diameter - Fünfmal den Durchmesser - 5 fois le diamètre	8xD	- 8 volte il diametro - Eight times the diameter - Achtmal den Durchmesser - 8 fois le diamètre
12xD	- 12 volte il diametro - Twelve times the diameter - Zwölfmal den Durchmesser - 12 fois le diamètre						

SIMBOLI GENERALI - GENERAL SYMBOLS - ALLGEMEINE SYMBOLE - SYMBOLES GÉNÉRAUX

	- Punta autocentrante - Self-centering drill - Selbstzentrierender bohrer - Pointe a centrage automatique	MG	- Micrograno 0,7 µm (K 20) - Micrograin 0,7 µm (K 20) - Feinstkorn 0,7 µm (K 20) - Microgrenu 0,7 µm (K 20)	HSSE	- Acciaio rapido al Cobalto - Cobalt high speed steel - Kobaltschnellstahl - Acier rapide au cobalt
---	--	-----------	--	-------------	--

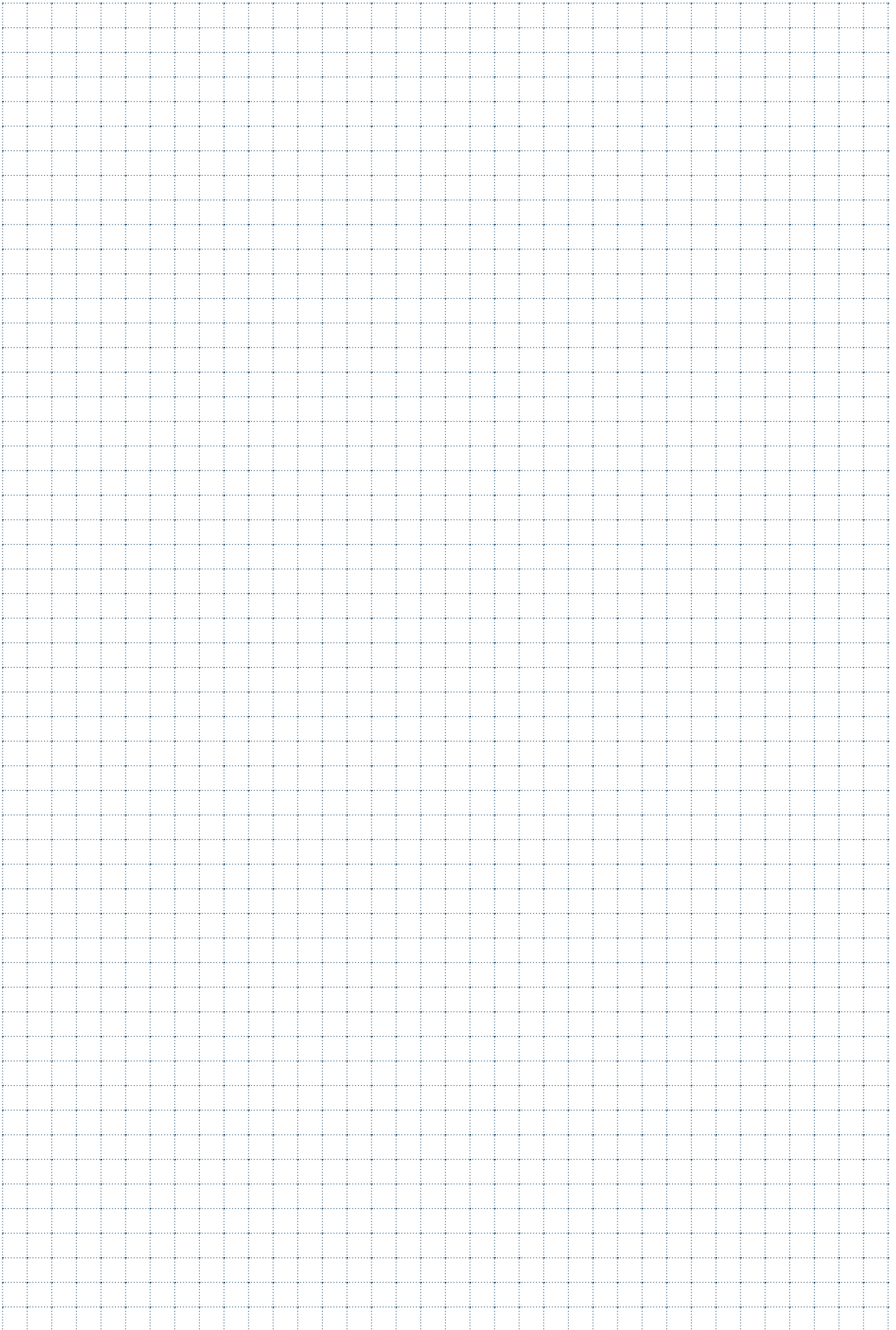



MICROPUNTE

MICRO-DRILLS / MIKROBOHRER / MICRO-FORETS / MICROBROCAS

SDM0301

$\varnothing D = 0,4 - 2,9$

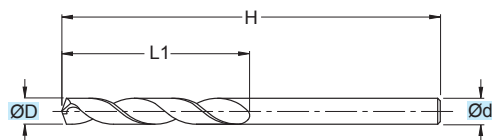

TOLLERANZE	D	d
TOLERANCE RANGE	h7	h7

RIVESTIM. COATED TIALN	3xD
	DIN 6539
	MG

(mm)				
ART.	ØD	Ød	H	L1
SDM0301004	0,4	0,4	26	6
SDM0301005	0,5	0,5	26	6
SDM0301006	0,6	0,6	26	6
SDM0301007	0,7	0,7	26	6
SDM0301008	0,8	0,8	26	6
SDM0301009	0,9	0,9	26	6
SDM0301010	1,0	1,0	26	6
SDM0301011	1,1	1,1	28	7
SDM0301012	1,2	1,2	30	8
SDM0301013	1,3	1,3	30	8
SDM0301014	1,4	1,4	32	9
SDM0301015	1,5	1,5	32	9
SDM0301016	1,6	1,6	34	10
SDM0301017	1,7	1,7	34	10
SDM0301018	1,8	1,8	36	11
SDM0301019	1,9	1,9	36	11
SDM0301020	2,0	2,0	38	12
SDM0301021	2,1	2,1	38	12
SDM0301022	2,2	2,2	40	13
SDM0301023	2,3	2,3	40	13
SDM0301024	2,4	2,4	43	14
SDM0301025	2,5	2,5	43	14
SDM0301026	2,6	2,6	43	14
SDM0301027	2,7	2,7	46	16
SDM0301028	2,8	2,8	46	16
SDM0301029	2,9	2,9	46	16

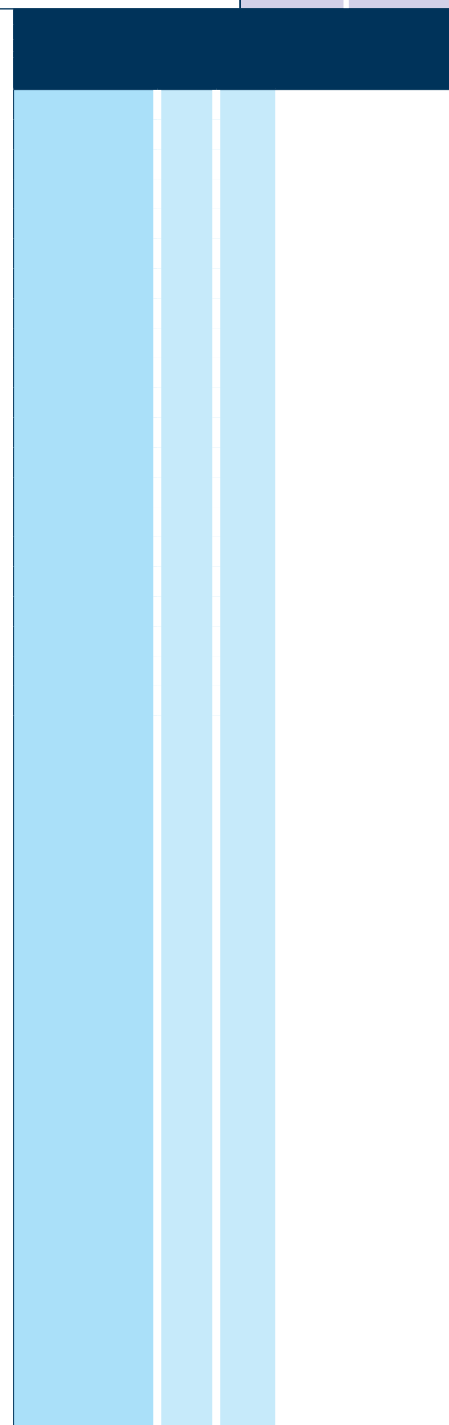
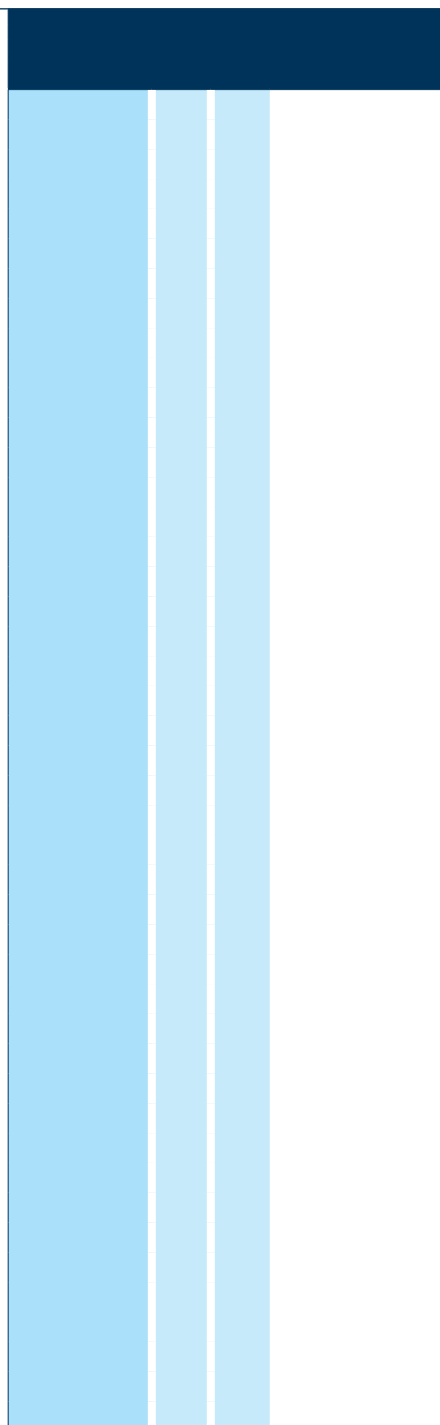

MATERIALI - MATERIALS Pag. 1199

Applicazione - Application

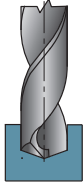

Applicazione - Application	MATERIALI - MATERIALS													ØD	Vc	fn	n (giri/min) (min ⁻¹)	Vf (mm/min)		
	P			M		K			N			S							H	G
	ACCIAIO NON LEGATO NOT ALLOY STEEL	ACCIAIO POCO LEGATO LOW ALLOY STEEL	ACCIAIO ALTO LEGATO ALLOY STEEL	INOX MARTENSITICO STAINLESS STEEL MART.	INOX AUST. DUPLEX STAINLESS STEEL AUST.	GHISA GRIGIA GREY CAST IRON	GHISA SFEROIDALE SPHEROIDAL GRAPHITE	GHISA MALLEABILE MALLEABLE CAST IRON	ALLUMINIO E SUE LEGHE ALUMINIUM	RAME E SUE LEGHE COPPER	NON METALLICI PLASTICS	LEGHE RESIST. CALORE HIGH TEMP. ALLOY	TITANIO E SUE LEGHE TITANIUM						ACCIAIO TEMPRATO HARDENED STEEL	GRAFITE GRAPHITE
●																0,4+0,8	50	0,07	-	-
●																0,8+1,2	50	0,07	-	-
●																1,2+1,6	50	0,10	-	-
●																1,6+2,0	50	0,10	-	-
●																2,0+2,4	50	0,12	-	-
●																2,4+2,9	50	0,14	-	-
			●													0,4+0,8	40	0,07	-	-
			●													0,8+1,2	40	0,07	-	-
			●													1,2+1,6	40	0,10	-	-
			●													1,6+2,0	40	0,10	-	-
			●													2,0+2,4	40	0,12	-	-
			●													2,4+2,9	40	0,14	-	-
				●												0,4+0,8	30	0,04	-	-
				●												0,8+1,2	30	0,04	-	-
				●												1,2+1,6	30	0,06	-	-
				●												1,6+2,0	30	0,06	-	-
				●												2,0+2,4	30	0,07	-	-
				●												2,4+2,9	30	0,08	-	-
					●											0,4+0,8	65	0,07	-	-
					●											0,8+1,2	65	0,07	-	-
					●											1,2+1,6	65	0,10	-	-
					●											1,6+2,0	65	0,10	-	-
					●											2,0+2,4	65	0,12	-	-
					●											2,4+2,9	65	0,14	-	-
								●								0,4+0,8	115	0,07	-	-
								●								0,8+1,2	115	0,07	-	-
								●								1,2+1,6	115	0,10	-	-
								●								1,6+2,0	115	0,10	-	-
								●								2,0+2,4	115	0,12	-	-
								●								2,4+2,9	115	0,14	-	-
												○				0,4+0,8	15	0,03	-	-
												○				0,8+1,2	15	0,03	-	-
												○				1,2+1,6	15	0,04	-	-
												○				1,6+2,0	15	0,04	-	-
												○				2,0+2,4	15	0,05	-	-
												○				2,4+2,9	15	0,06	-	-
													○			0,4+0,8	15	0,025	-	-
													○			0,8+1,2	15	0,025	-	-
													○			1,2+1,6	15	0,025	-	-
													○			1,6+2,0	15	0,025	-	-
													○			2,0+2,4	15	0,035	-	-
													○			2,4+2,9	15	0,035	-	-
														○		0,4+0,8	15	0,015	-	-
														○		0,8+1,2	15	0,015	-	-
														○		1,2+1,6	15	0,015	-	-
														○		1,6+2,0	15	0,015	-	-
														○		2,0+2,4	15	0,025	-	-
														○		2,4+2,9	15	0,025	-	-

● APPLICAZIONE CONSIGLIATA-RECOMMENDED APPLICATION
EMPFOLLENER EINSATZ - APPLICATION CONSEILLÉE

○ APPLICAZIONE POSSIBILE - POSSIBLE APPLICATION
MÖGLICHE ANWENDUNG - APPLICATION POSSIBLE

Vc = m/min VELOCITÀ DI TAGLIO - CUTTING SPEED

n = giri/min (min⁻¹) NUMERO DI GIRI - NUMBER OF REVOLUTIONS

fn = mm AVANZAMENTO AL GIRO - FEED / REVOLUTION

Vf = mm/min VELOCITÀ DI AVANZAMENTO - FEED SPEED

$$n = \frac{Vc \cdot 1000}{\text{ØD} \cdot 3,14} = \text{giri/min (min}^{-1}\text{)}$$

$$Vf = fn \cdot n = \text{mm/min}$$

SDMN0301

$\varnothing D = 0,4 - 2,9$

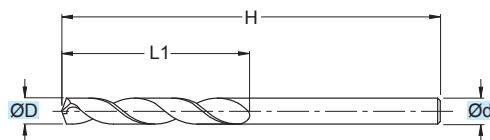

TOLLERANZE	D	d
TOLLERANCE RANGE	h7	h7

	3xD
	DIN 6539
	MG

(mm)				
ART.	ØD	Ød	H	L1
SDMN0301004	0,4	0,4	26	6
SDMN0301005	0,5	0,5	26	6
SDMN0301006	0,6	0,6	26	6
SDMN0301007	0,7	0,7	26	6
SDMN0301008	0,8	0,8	26	6
SDMN0301009	0,9	0,9	26	6
SDMN0301010	1,0	1,0	26	6
SDMN0301011	1,1	1,1	28	7
SDMN0301012	1,2	1,2	30	8
SDMN0301013	1,3	1,3	30	8
SDMN0301014	1,4	1,4	32	9
SDMN0301015	1,5	1,5	32	9
SDMN0301016	1,6	1,6	34	10
SDMN0301017	1,7	1,7	34	10
SDMN0301018	1,8	1,8	36	11
SDMN0301019	1,9	1,9	36	11
SDMN0301020	2,0	2,0	38	12
SDMN0301021	2,1	2,1	38	12
SDMN0301022	2,2	2,2	40	13
SDMN0301023	2,3	2,3	40	13
SDMN0301024	2,4	2,4	43	14
SDMN0301025	2,5	2,5	43	14
SDMN0301026	2,6	2,6	43	14
SDMN0301027	2,7	2,7	46	16
SDMN0301028	2,8	2,8	46	16
SDMN0301029	2,9	2,9	46	16

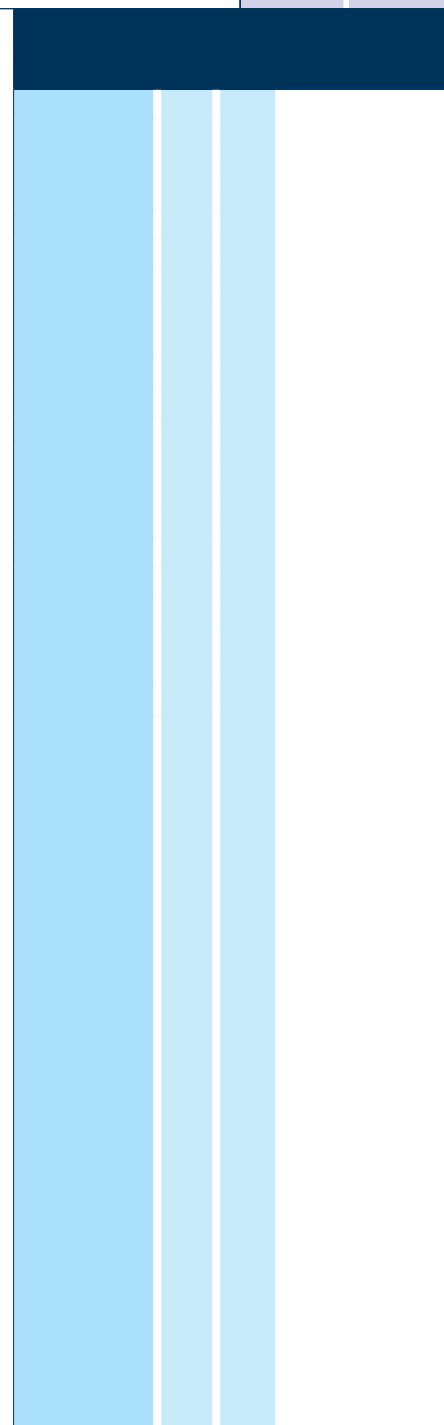
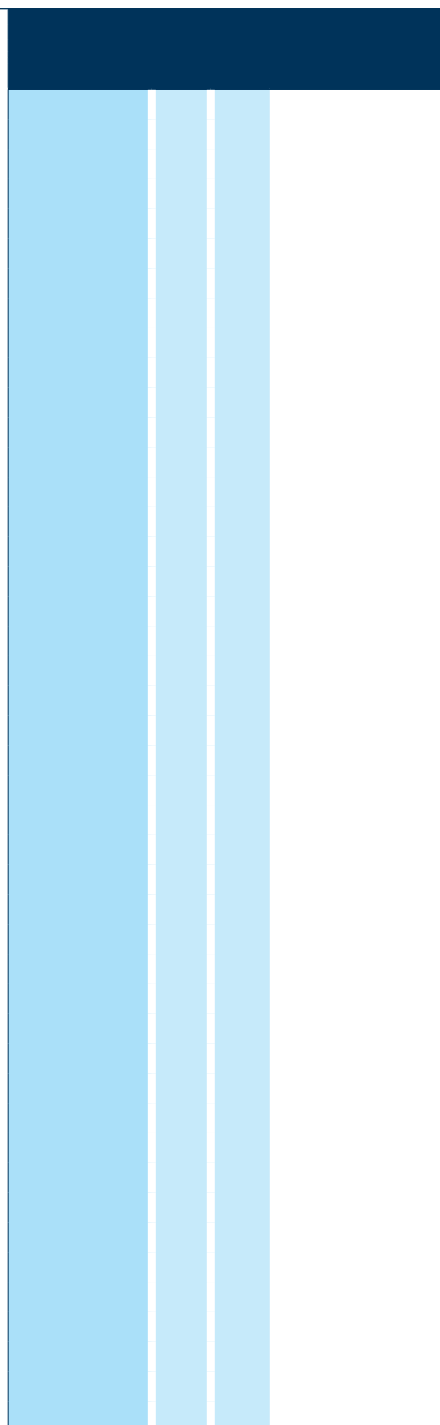

MATERIALI - MATERIALS Pag. 1199

Applicazione - Application

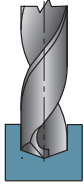

	MATERIALI - MATERIALS													ØD	Vc	fn	n	Vf		
	P			M			K			N			S						H	G
	ACCIAIO NON LEGATO NOT ALLOY STEEL	ACCIAIO POCO LEGATO LOW ALLOY STEEL	ACCIAIO ALTO LEGATO ALLOY STEEL	INOX MARTENSITICO STAINLESS STEEL MART.	INOX AUST. DUPLEX STAINLESS STEEL AUST.	GHISA GRIGIA GREY CAST IRON	GHISA SFEROIDALE SPHEROIDAL GRAPHITE	GHISA MALLEABILE MALLEABLE CAST IRON	ALLUMINIO E SUE LEGHE ALUMINIUM	RAME E SUE LEGHE COPPER	NON METALLICI PLASTICS	LEGHE RESIST. CALORE HIGH TEMP. ALLOY	TITANIO E SUE LEGHE TITANIUM	ACCIAIO TEMPRATO HARDENED STEEL	GRAFITE GRAPHITE	(mm)	(m/min)	(mm)	(giri/min) (min ⁻¹)	(mm/min)
●																0,4+0,8	40	0,04	-	-
●																0,8+1,2	40	0,04	-	-
●																1,2+1,6	40	0,06	-	-
●																1,6+2,0	40	0,06	-	-
●																2,0+2,4	40	0,08	-	-
●																2,4+2,9	40	0,08	-	-
○																0,4+0,8	30	0,04	-	-
○																0,8+1,2	30	0,04	-	-
○																1,2+1,6	30	0,06	-	-
○																1,6+2,0	30	0,06	-	-
○																2,0+2,4	30	0,08	-	-
○																2,4+2,9	30	0,08	-	-
○																0,4+0,8	20	0,03	-	-
○																0,8+1,2	20	0,03	-	-
○																1,2+1,6	20	0,04	-	-
○																1,6+2,0	20	0,04	-	-
○																2,0+2,4	20	0,05	-	-
○																2,4+2,9	20	0,05	-	-
○																0,4+0,8	50	0,03	-	-
○																0,8+1,2	50	0,03	-	-
○																1,2+1,6	50	0,04	-	-
○																1,6+2,0	50	0,04	-	-
○																2,0+2,4	50	0,05	-	-
○																2,4+2,9	50	0,05	-	-
○																0,4+0,8	80	0,04	-	-
○																0,8+1,2	80	0,04	-	-
○																1,2+1,6	80	0,06	-	-
○																1,6+2,0	80	0,06	-	-
○																2,0+2,4	80	0,08	-	-
○																2,4+2,9	80	0,08	-	-

● APPLICAZIONE CONSIGLIATA-RECOMMENDED APPLICATION
EMPFOHLENER EINSATZ - APPLICATION CONSEILLÉE

○ APPLICAZIONE POSSIBILE - POSSIBLE APPLICATION
MÖGLICHE ANWENDUNG - APPLICATION POSSIBLE

Vc = m/min VELOCITÀ DI TAGLIO - CUTTING SPEED

n = giri/min (min⁻¹) NUMERO DI GIRI - NUMBER OF REVOLUTIONS

fn = mm AVANZAMENTO AL GIRO - FEED / REVOLUTION

Vf = mm/min VELOCITÀ DI AVANZAMENTO - FEED SPEED

$$n = \frac{Vc \cdot 1000}{\text{ØD} \cdot 3,14} = \text{giri/min (min}^{-1}\text{)}$$

$$Vf = fn \cdot n = \text{mm/min}$$

SDM0501

$\varnothing D = 0,7 - 2,9$

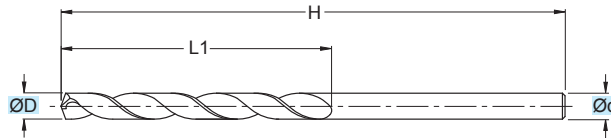

TOLLERANZE	D	d
TOLLERANCE RANGE	h7	h7

RIVESTIM. COATED TIALN	5xD
	DIN 338
	MG

(mm)				
ART.	ØD	Ød	H	L1
SDM0501007	0,7	0,7	28	9
SDM0501008	0,8	0,8	30	10
SDM0501009	0,9	0,9	32	11
SDM0501010	1,0	1,0	34	12
SDM0501011	1,1	1,1	36	14
SDM0501012	1,2	1,2	38	16
SDM0501013	1,3	1,3	38	16
SDM0501014	1,4	1,4	40	18
SDM0501015	1,5	1,5	40	18
SDM0501016	1,6	1,6	43	20
SDM0501017	1,7	1,7	43	20
SDM0501018	1,8	1,8	46	22
SDM0501019	1,9	1,9	46	22
SDM0501020	2,0	2,0	49	24
SDM0501021	2,1	2,1	49	24
SDM0501022	2,2	2,2	53	27
SDM0501023	2,3	2,3	53	27
SDM0501024	2,4	2,4	57	30
SDM0501025	2,5	2,5	57	30
SDM0501026	2,6	2,6	57	30
SDM0501027	2,7	2,7	61	33
SDM0501028	2,8	2,8	61	33
SDM0501029	2,9	2,9	61	33

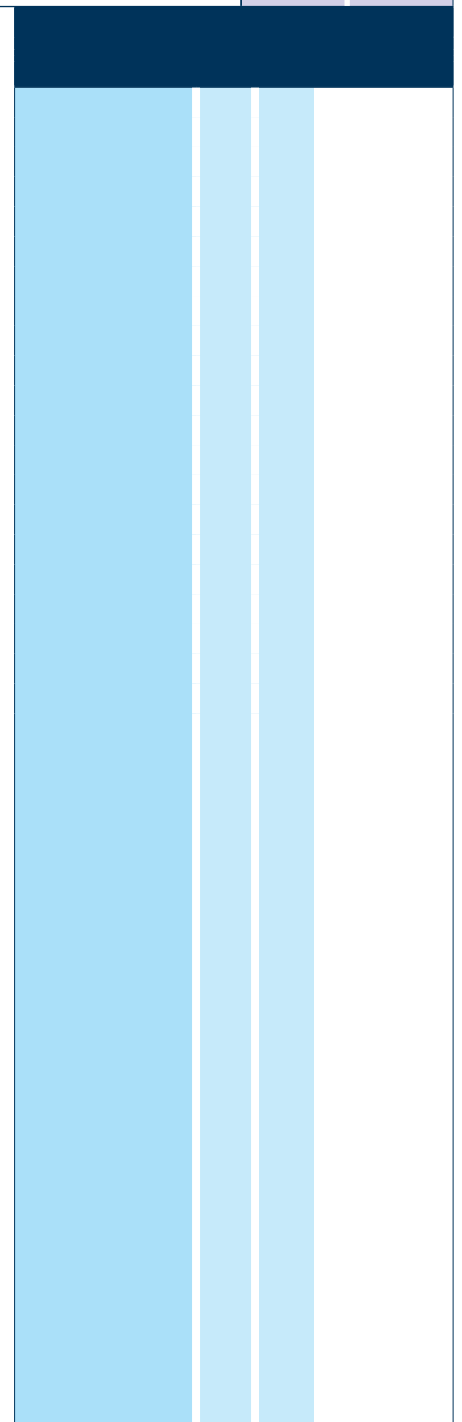
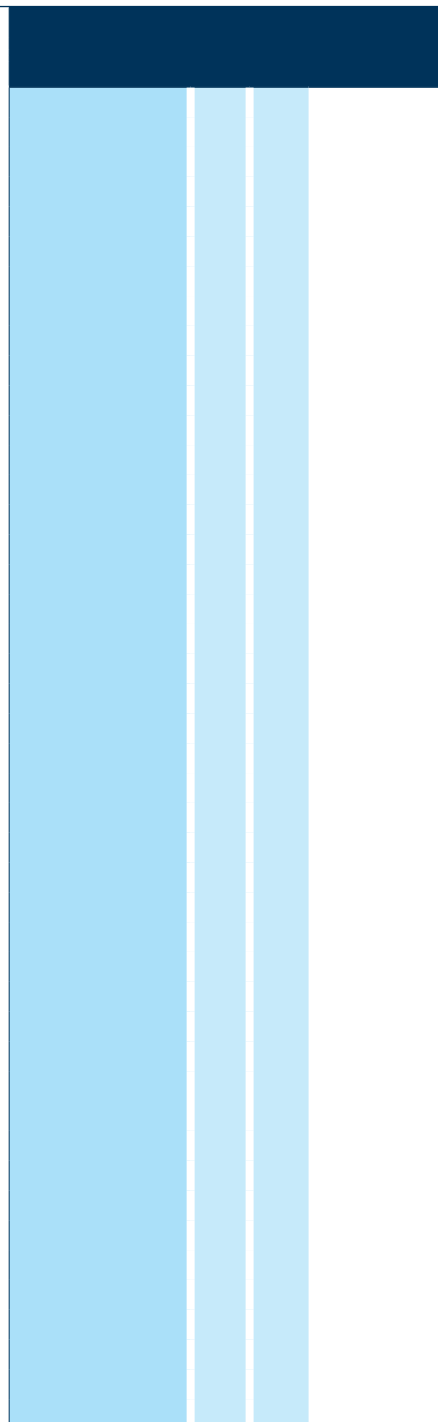

MATERIALI - MATERIALS Pag. 1199

Applicazione - Application

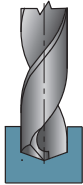

Applicazione - Application	MATERIALI - MATERIALS													ØD	Vc	fn	n (giri/min) (min ⁻¹)	Vf (mm/min)		
	P			M		K			N			S							H	G
	ACCIAIO NON LEGATO NOT ALLOY STEEL	ACCIAIO POCO LEGATO LOW ALLOY STEEL	ACCIAIO ALTO LEGATO ALLOY STEEL	INOX MARTENSITICO STAINLESS STEEL MART.	INOX AUST. DUPLEX STAINLESS STEEL AUST.	GHISA GRIGIA GREY CAST IRON	GHISA SFEROIDALE SPHEROIDAL GRAPHITE	GHISA MALLEABILE MALLEABLE CAST IRON	ALLUMINIO E SUE LEGHE ALUMINIUM	RAME E SUE LEGHE COPPER	NON METALLICI PLASTICS	LEGHE RESIST. CALORE HIGH TEMP. ALLOY	TITANIO E SUE LEGHE TITANIUM						ACCIAIO TEMPRATO HARDENED STEEL	GRAFITE GRAPHITE
●																0,4+0,8	50	0,07	-	-
●																0,8+1,2	50	0,07	-	-
●																1,2+1,6	50	0,10	-	-
●																1,6+2,0	50	0,10	-	-
●																2,0+2,4	50	0,12	-	-
●																2,4+2,9	50	0,14	-	-
			●													0,4+0,8	40	0,07	-	-
			●													0,8+1,2	40	0,07	-	-
			●													1,2+1,6	40	0,10	-	-
			●													1,6+2,0	40	0,10	-	-
			●													2,0+2,4	40	0,12	-	-
			●													2,4+2,9	40	0,14	-	-
				●												0,4+0,8	30	0,04	-	-
				●												0,8+1,2	30	0,04	-	-
				●												1,2+1,6	30	0,06	-	-
				●												1,6+2,0	30	0,06	-	-
				●												2,0+2,4	30	0,07	-	-
				●												2,4+2,9	30	0,08	-	-
							●									0,4+0,8	65	0,07	-	-
							●									0,8+1,2	65	0,07	-	-
							●									1,2+1,6	65	0,10	-	-
							●									1,6+2,0	65	0,10	-	-
							●									2,0+2,4	65	0,12	-	-
							●									2,4+2,9	65	0,14	-	-
								●								0,4+0,8	115	0,07	-	-
								●								0,8+1,2	115	0,07	-	-
								●								1,2+1,6	115	0,10	-	-
								●								1,6+2,0	115	0,10	-	-
								●								2,0+2,4	115	0,12	-	-
								●								2,4+2,9	115	0,14	-	-
												○				0,4+0,8	15	0,03	-	-
												○				0,8+1,2	15	0,03	-	-
												○				1,2+1,6	15	0,04	-	-
												○				1,6+2,0	15	0,04	-	-
												○				2,0+2,4	15	0,05	-	-
												○				2,4+2,9	15	0,06	-	-
													○			0,4+0,8	15	0,025	-	-
													○			0,8+1,2	15	0,025	-	-
													○			1,2+1,6	15	0,025	-	-
													○			1,6+2,0	15	0,025	-	-
													○			2,0+2,4	15	0,035	-	-
													○			2,4+2,9	15	0,035	-	-
														○		0,4+0,8	15	0,015	-	-
														○		0,8+1,2	15	0,015	-	-
														○		1,2+1,6	15	0,015	-	-
														○		1,6+2,0	15	0,015	-	-
														○		2,0+2,4	15	0,025	-	-
														○		2,4+2,9	15	0,025	-	-

● APPLICAZIONE CONSIGLIATA-RECOMMENDED APPLICATION
EMPFOLHENER EINSATZ - APPLICATION CONSEILLÉE

○ APPLICAZIONE POSSIBILE - POSSIBLE APPLICATION
MÖGLICHE ANWENDUNG - APPLICATION POSSIBLE

Vc = m/min VELOCITÀ DI TAGLIO - CUTTING SPEED

n = giri/min (min⁻¹) NUMERO DI GIRI - NUMBER OF REVOLUTIONS

fn = mm AVANZAMENTO AL GIRO - FEED / REVOLUTION

Vf = mm/min VELOCITÀ DI AVANZAMENTO - FEED SPEED

$$n = \frac{Vc \cdot 1000}{\text{ØD} \cdot 3,14} = \text{giri/min (min}^{-1}\text{)}$$

$$Vf = fn \cdot n = \text{mm/min}$$

SDMN0501

$\varnothing D = 0,7 - 2,9$

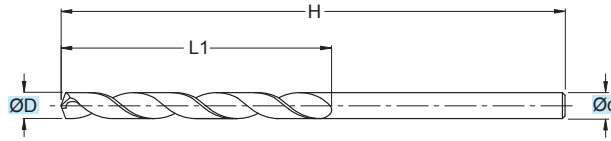

TOLLERANZE	D	d
TOLERANCE RANGE	h7	h7

	5xD
	DIN 338
	MG

ART.	(mm)			
	ØD	Ød	H	L1
SDMN0501007	0,7	0,7	28	9
SDMN0501008	0,8	0,8	30	10
SDMN0501009	0,9	0,9	32	11
SDMN0501010	1,0	1,0	34	12
SDMN0501011	1,1	1,1	36	14
SDMN0501012	1,2	1,2	38	16
SDMN0501013	1,3	1,3	38	16
SDMN0501014	1,4	1,4	40	18
SDMN0501015	1,5	1,5	40	18
SDMN0501016	1,6	1,6	43	20
SDMN0501017	1,7	1,7	43	20
SDMN0501018	1,8	1,8	46	22
SDMN0501019	1,9	1,9	46	22
SDMN0501020	2,0	2,0	49	24
SDMN0501021	2,1	2,1	49	24
SDMN0501022	2,2	2,2	53	27
SDMN0501023	2,3	2,3	53	27
SDMN0501024	2,4	2,4	57	30
SDMN0501025	2,5	2,5	57	30
SDMN0501026	2,6	2,6	57	30
SDMN0501027	2,7	2,7	61	33
SDMN0501028	2,8	2,8	61	33
SDMN0501029	2,9	2,9	61	33

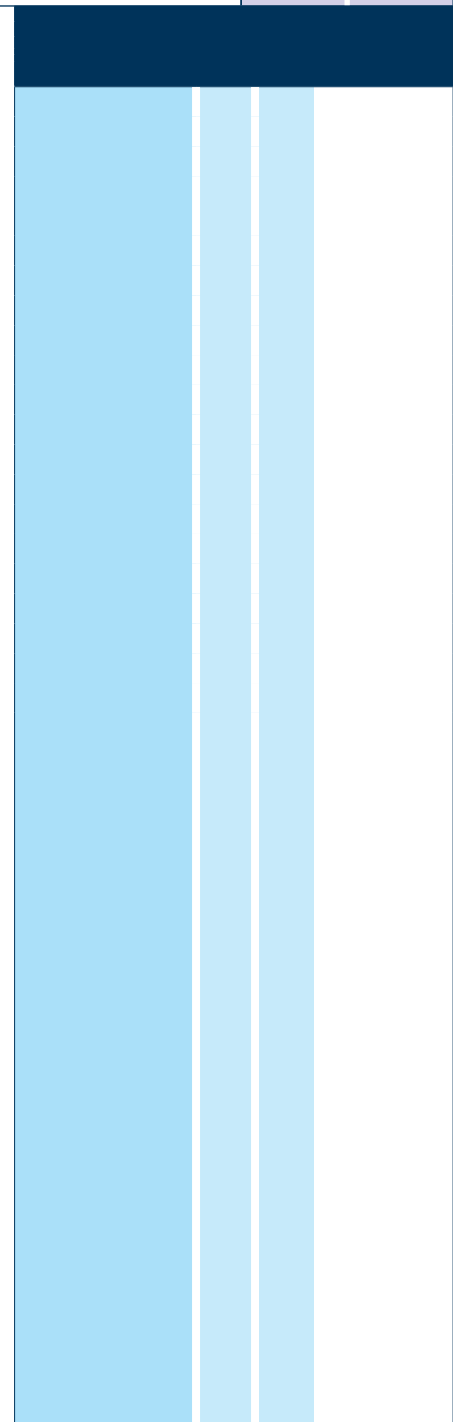
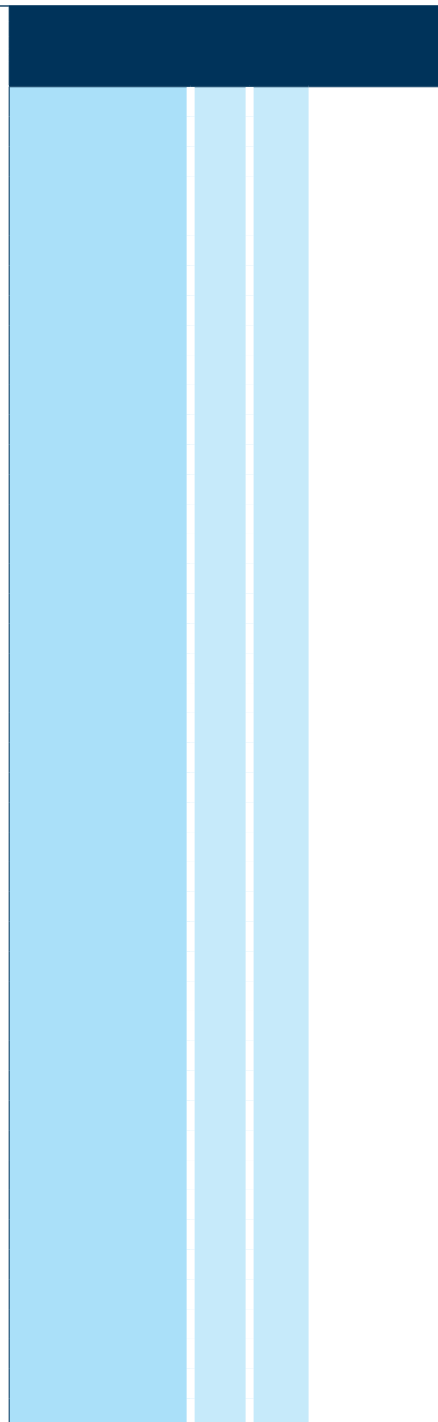

MATERIALI - MATERIALS Pag. 1199

Applicazione - Application

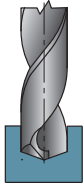

	MATERIALI - MATERIALS													ØD	Vc	fn	n (giri/min (min ⁻¹))	Vf (mm/min)		
	P	M	K			N			S		H	G								
	ACCIAIO NON LEGATO NOT ALLOY STEEL	ACCIAIO POCO LEGATO LOW ALLOY STEEL	ACCIAIO ALTO LEGATO ALLOY STEEL	INOX MARTENSITICO STAINLESS STEEL MART.	INOX AUST. DUPLEX STAINLESS STEEL AUST.	GHISA GRIGIA GREY CAST IRON	GHISA SFEROIDALE SPHEROIDAL GRAPHITE	GHISA MALLEABILE MALLEABLE CAST IRON	ALLUMINIO E SUE LEGHE ALUMINIUM	RAMME E SUE LEGHE COPPER	NON METALLICI PLASTICS	LEGHE RESIST. CALORE HIGH TEMP. ALLOY	TITANIO E SUE LEGHE TITANIUM	ACCIAIO TEMPRATO HARDENED STEEL	GRAFITE GRAPHITE					
●																0,4+0,8	40	0,04	-	-
●																0,8+1,2	40	0,04	-	-
●																1,2+1,6	40	0,06	-	-
●																1,6+2,0	40	0,06	-	-
●																2,0+2,4	40	0,08	-	-
●																2,4+2,9	40	0,08	-	-
		●														0,4+0,8	30	0,04	-	-
		●														0,8+1,2	30	0,04	-	-
		●														1,2+1,6	30	0,06	-	-
		●														1,6+2,0	30	0,06	-	-
		●														2,0+2,4	30	0,08	-	-
		●														2,4+2,9	30	0,08	-	-
				○												0,4+0,8	20	0,03	-	-
				○												0,8+1,2	20	0,03	-	-
				○												1,2+1,6	20	0,04	-	-
				○												1,6+2,0	20	0,04	-	-
				○												2,0+2,4	20	0,05	-	-
				○												2,4+2,9	20	0,05	-	-
						●										0,4+0,8	50	0,03	-	-
						●										0,8+1,2	50	0,03	-	-
						●										1,2+1,6	50	0,04	-	-
						●										1,6+2,0	50	0,04	-	-
						●										2,0+2,4	50	0,05	-	-
						●										2,4+2,9	50	0,05	-	-
								●								0,4+0,8	80	0,04	-	-
								●								0,8+1,2	80	0,04	-	-
								●								1,2+1,6	80	0,06	-	-
								●								1,6+2,0	80	0,06	-	-
								●								2,0+2,4	80	0,08	-	-
								●								2,4+2,9	80	0,08	-	-

● APPLICAZIONE CONSIGLIATA-RECOMMENDED APPLICATION
EMPFÖHLENER EINSATZ - APPLICATION CONSEILLÉE

○ APPLICAZIONE POSSIBILE - POSSIBLE APPLICATION
MÖGLICHE ANWENDUNG - APPLICATION POSSIBLE

Vc = m/min VELOCITÀ DI TAGLIO - CUTTING SPEED

n = giri/min (min⁻¹) NUMERO DI GIRI - NUMBER OF REVOLUTIONS

fn = mm AVANZAMENTO AL GIRO - FEED / REVOLUTION

Vf = mm/min VELOCITÀ DI AVANZAMENTO - FEED SPEED

$$n = \frac{Vc \cdot 1000}{\text{ØD} \cdot 3,14} = \text{giri/min (min}^{-1}\text{)}$$

$$Vf = fn \cdot n = \text{mm/min}$$

SDM0310

$\varnothing D = 0,5 - 2,9$

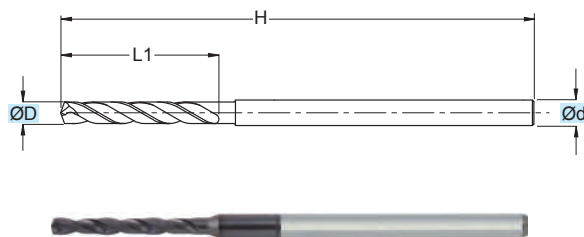

TOLLERANZE	D	d
TOLLERANCE RANGE	h7	h7

RIVESTIM. COATED TIALN	3xD
	DIN 6537
	MG

(mm)				
ART.	ØD	Ød	H	L1
SDM0310005	0,5	3	38	6
SDM0310006	0,6	3	38	6
SDM0310007	0,7	3	38	6
SDM0310008	0,8	3	38	6
SDM0310009	0,9	3	38	6
SDM0310010	1,0	3	38	6
SDM0310011	1,1	3	38	12
SDM0310012	1,2	3	38	12
SDM0310013	1,3	3	38	12
SDM0310014	1,4	3	38	12
SDM0310015	1,5	3	50	12
SDM0310016	1,6	3	50	12
SDM0310017	1,7	3	50	12
SDM0310018	1,8	3	50	12
SDM0310019	1,9	3	50	12
SDM0310020	2,0	3	50	12
SDM0310021	2,1	3	60	18
SDM0310022	2,2	3	60	18
SDM0310023	2,3	3	60	18
SDM0310024	2,4	3	60	18
SDM0310025	2,5	3	60	18
SDM0310026	2,6	3	60	18
SDM0310027	2,7	3	60	18
SDM0310028	2,8	3	60	18
SDM0310029	2,9	3	60	18

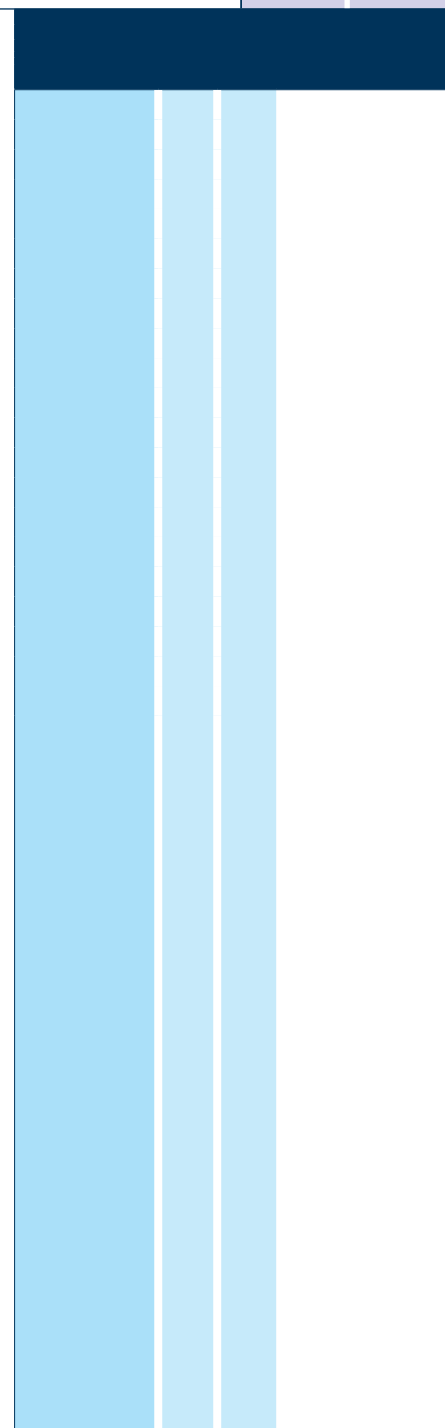
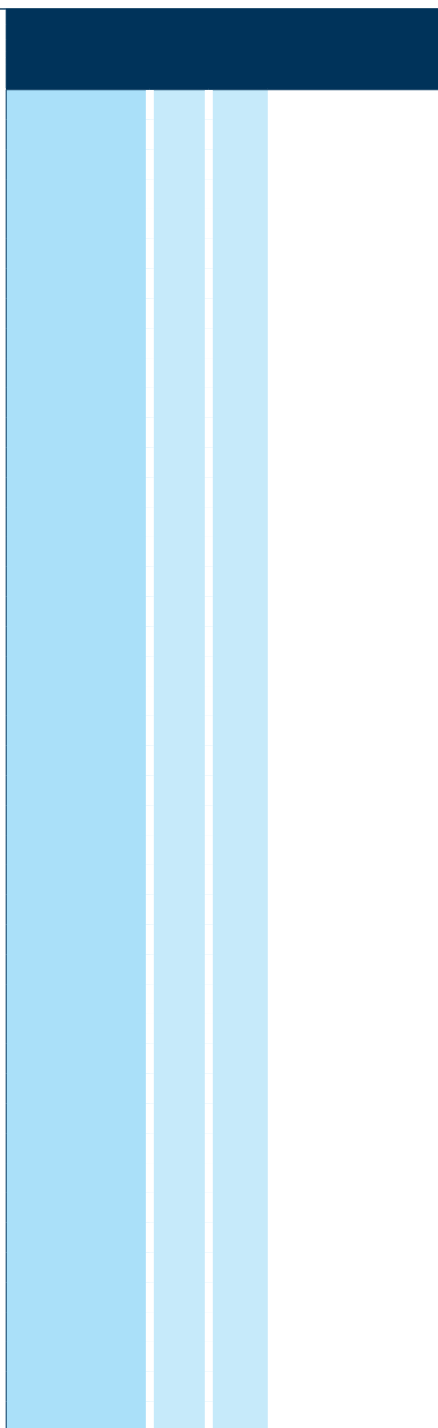

MATERIALI - MATERIALS Pag. 1199

Applicazione - Application

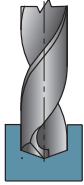

Applicazione - Application	MATERIALI - MATERIALS													ØD	Vc	fn	n (giri/min) (min ⁻¹)	Vf (mm/min)		
	P			M		K			N			S							H	G
	ACCIAIO NON LEGATO NOT ALLOY STEEL	ACCIAIO POCO LEGATO LOW ALLOY STEEL	ACCIAIO ALTO LEGATO ALLOY STEEL	INOX MARTENSITICO STAINLESS STEEL MART.	INOX AUST. DUPLEX STAINLESS STEEL AUST.	GHISA GRIGIA GREY CAST IRON	GHISA SFEROIDALE SPHEROIDAL GRAPHITE	GHISA MALLEABILE MALLEABLE CAST IRON	ALLUMINIO E SUE LEGHE ALUMINIUM	RAME E SUE LEGHE COPPER	NON METALLICI PLASTICS	LEGHE RESIST. CALORE HIGH TEMP. ALLOY	TITANIO E SUE LEGHE TITANIUM						ACCIAIO TEMPRATO HARDENED STEEL	GRAFITE GRAPHITE
●																0,5+1,0	50	0,07	-	-
																1,0+1,5	50	0,10	-	-
																1,5+2,0	50	0,10	-	-
																2,0+2,5	50	0,12	-	-
																2,5+2,9	50	0,14	-	-
●																0,5+1,0	40	0,07	-	-
																1,0+1,5	40	0,10	-	-
																1,5+2,0	40	0,10	-	-
																2,0+2,5	40	0,12	-	-
																2,5+2,9	40	0,14	-	-
●																0,5+1,0	30	0,04	-	-
																1,0+1,5	30	0,06	-	-
																1,5+2,0	30	0,06	-	-
																2,0+2,5	30	0,07	-	-
																2,5+2,9	30	0,08	-	-
●																0,5+1,0	65	0,07	-	-
																1,0+1,5	65	0,10	-	-
																1,5+2,0	65	0,10	-	-
																2,0+2,5	65	0,12	-	-
																2,5+2,9	65	0,14	-	-
●																0,5+1,0	115	0,07	-	-
																1,0+1,5	115	0,10	-	-
																1,5+2,0	115	0,10	-	-
																2,0+2,5	115	0,12	-	-
																2,5+2,9	115	0,14	-	-
○																0,5+1,0	15	0,03	-	-
																1,0+1,5	15	0,04	-	-
																1,5+2,0	15	0,04	-	-
																2,0+2,5	15	0,05	-	-
																2,5+2,9	15	0,06	-	-
○																0,5+1,0	15	0,025	-	-
																1,0+1,5	15	0,025	-	-
																1,5+2,0	15	0,025	-	-
																2,0+2,5	15	0,035	-	-
																2,5+2,9	15	0,035	-	-
○																0,5+1,0	15	0,015	-	-
																1,0+1,5	15	0,015	-	-
																1,5+2,0	15	0,015	-	-
																2,0+2,5	15	0,025	-	-
																2,5+2,9	15	0,025	-	-

● APPLICAZIONE CONSIGLIATA-RECOMMENDED APPLICATION
EMPFOLLENER EINSATZ - APPLICATION CONSEILLÉE

○ APPLICAZIONE POSSIBILE - POSSIBLE APPLICATION
MÖGLICHE ANWENDUNG - APPLICATION POSSIBLE

Vc = m/min VELOCITÀ DI TAGLIO - CUTTING SPEED

n = giri/min (min⁻¹) NUMERO DI GIRI - NUMBER OF REVOLUTIONS

fn = mm AVANZAMENTO AL GIRO - FEED / REVOLUTION

Vf = mm/min VELOCITÀ DI AVANZAMENTO - FEED SPEED

$$n = \frac{Vc \cdot 1000}{\text{ØD} \cdot 3,14} = \text{giri/min (min}^{-1}\text{)}$$

$$Vf = fn \cdot n = \text{mm/min}$$

SDMN0310

$\varnothing D = 0,5 - 2,9$

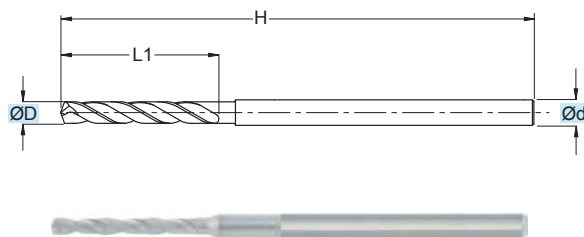

TOLLERANZE	D	d
TOLLERANCE RANGE	h7	h7

	3xD
	DIN 6537
	MG

(mm)				
ART.	ØD	Ød	H	L1
SDMN0310005	0,5	3	38	6
SDMN0310006	0,6	3	38	6
SDMN0310007	0,7	3	38	6
SDMN0310008	0,8	3	38	6
SDMN0310009	0,9	3	38	6
SDMN0310010	1,0	3	38	6
SDMN0310011	1,1	3	38	12
SDMN0310012	1,2	3	38	12
SDMN0310013	1,3	3	38	12
SDMN0310014	1,4	3	38	12
SDMN0310015	1,5	3	50	12
SDMN0310016	1,6	3	50	12
SDMN0310017	1,7	3	50	12
SDMN0310018	1,8	3	50	12
SDMN0310019	1,9	3	50	12
SDMN0310020	2,0	3	50	12
SDMN0310021	2,1	3	60	18
SDMN0310022	2,2	3	60	18
SDMN0310023	2,3	3	60	18
SDMN0310024	2,4	3	60	18
SDMN0310025	2,5	3	60	18
SDMN0310026	2,6	3	60	18
SDMN0310027	2,7	3	60	18
SDMN0310028	2,8	3	60	18
SDMN0310029	2,9	3	60	18

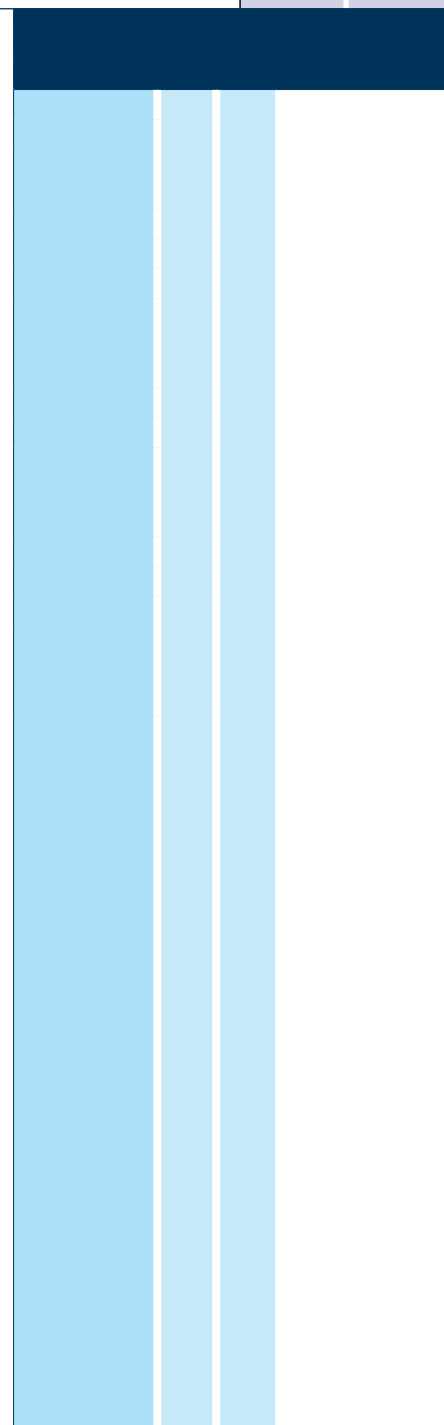
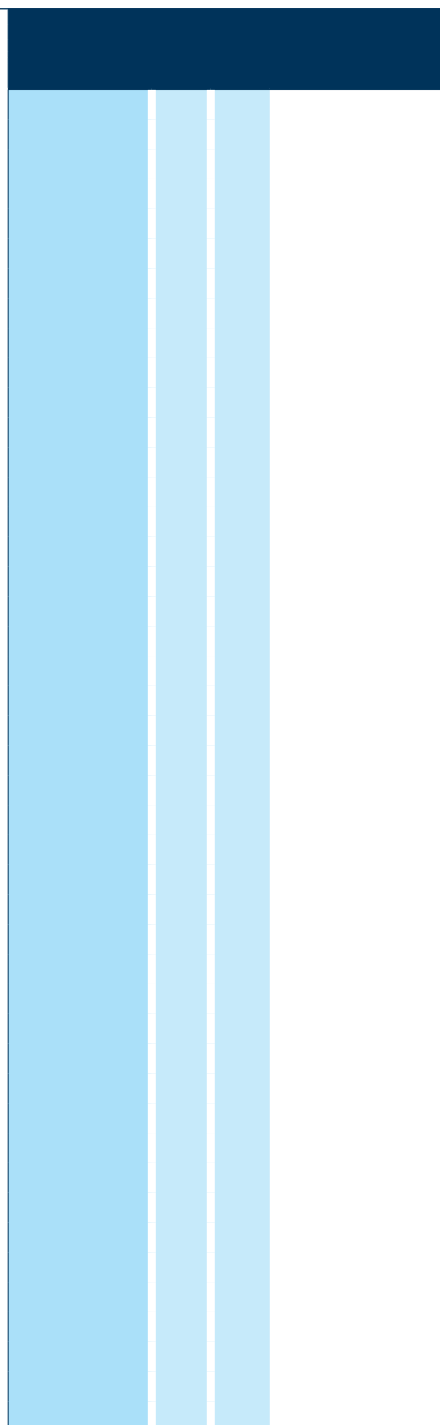

MATERIALI - MATERIALS Pag. 1199

Applicazione - Application

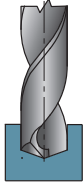

	MATERIALI - MATERIALS													ØD	Vc	fn	n	Vf		
	P			M			K			N			S						H	G
	ACCIAIO NON LEGATO NOT ALLOY STEEL	ACCIAIO POCO LEGATO LOW ALLOY STEEL	ACCIAIO ALTO LEGATO ALLOY STEEL	INOX MARTENSITICO STAINLESS STEEL MART.	INOX AUST. DUPLEX STAINLESS STEEL AUST.	GHISA GRIGIA GREY CAST IRON	GHISA SFEROIDALE SPHEROIDAL GRAPHITE	GHISA MALLEABILE MALLEABLE CAST IRON	ALLUMINIO E SUE LEGHE ALUMINIUM	RAME E SUE LEGHE COPPER	NON METALLICI PLASTICS	LEGHE RESIST. CALORE HIGH TEMP. ALLOY	TITANIO E SUE LEGHE TITANIUM	ACCIAIO TEMPRATO HARDENED STEEL	GRAFITE GRAPHITE	(mm)	(m/min)	(mm)	(giri/min) (min ⁻¹)	(mm/min)
●																0,5+1,0	40	0,04	-	-
●																1,0+1,5	40	0,04	-	-
●																1,5+2,0	40	0,06	-	-
●																2,0+2,5	40	0,06	-	-
●																2,5+2,9	40	0,08	-	-
○																0,5+1,0	30	0,04	-	-
○																1,0+1,5	30	0,04	-	-
○																1,5+2,0	30	0,06	-	-
○																2,0+2,5	30	0,06	-	-
○																2,5+2,9	30	0,08	-	-
○																0,5+1,0	20	0,03	-	-
○																1,0+1,5	20	0,03	-	-
○																1,5+2,0	20	0,04	-	-
○																2,0+2,5	20	0,04	-	-
○																2,5+2,9	20	0,05	-	-
○																0,5+1,0	50	0,03	-	-
○																1,0+1,5	50	0,03	-	-
○																1,5+2,0	50	0,04	-	-
○																2,0+2,5	50	0,04	-	-
○																2,5+2,9	50	0,05	-	-
○																0,5+1,0	80	0,04	-	-
○																1,0+1,5	80	0,04	-	-
○																1,5+2,0	80	0,06	-	-
○																2,0+2,5	80	0,06	-	-
○																2,5+2,9	80	0,08	-	-

● APPLICAZIONE CONSIGLIATA-RECOMMENDED APPLICATION
EMPFOHLENER EINSATZ - APPLICATION CONSEILLÉE

○ APPLICAZIONE POSSIBILE - POSSIBLE APPLICATION
MÖGLICHE ANWENDUNG - APPLICATION POSSIBLE

Vc = m/min VELOCITÀ DI TAGLIO - CUTTING SPEED

n = giri/min (min⁻¹) NUMERO DI GIRI - NUMBER OF REVOLUTIONS

fn = mm AVANZAMENTO AL GIRO - FEED / REVOLUTION

Vf = mm/min VELOCITÀ DI AVANZAMENTO - FEED SPEED

$$n = \frac{Vc \cdot 1000}{\text{ØD} \cdot 3,14} = \text{giri/min (min}^{-1}\text{)}$$

$$Vf = fn \cdot n = \text{mm/min}$$

SDM0510

$\varnothing D = 0,5 - 2,9$

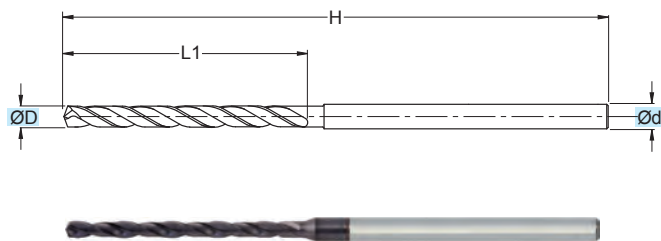

TOLLERANZE	D	d
TOLLERANCE RANGE	h7	h7

RIVESTIM. COATED TIALN	5xD
	DIN 6537
	MG

(mm)				
ART.	ØD	Ød	H	L1
SDM0510005	0,5	3	50	10
SDM0510006	0,6	3	50	10
SDM0510007	0,7	3	50	10
SDM0510008	0,8	3	50	10
SDM0510009	0,9	3	50	10
SDM0510010	1,0	3	50	10
SDM0510011	1,1	3	60	20
SDM0510012	1,2	3	60	20
SDM0510013	1,3	3	60	20
SDM0510014	1,4	3	60	20
SDM0510015	1,5	3	60	20
SDM0510016	1,6	3	60	20
SDM0510017	1,7	3	60	20
SDM0510018	1,8	3	60	20
SDM0510019	1,9	3	60	20
SDM0510020	2,0	3	60	20
SDM0510021	2,1	3	66	28
SDM0510022	2,2	3	66	28
SDM0510023	2,3	3	66	28
SDM0510024	2,4	3	66	28
SDM0510025	2,5	3	66	28
SDM0510026	2,6	3	66	28
SDM0510027	2,7	3	66	28
SDM0510028	2,8	3	66	28
SDM0510029	2,9	3	66	28

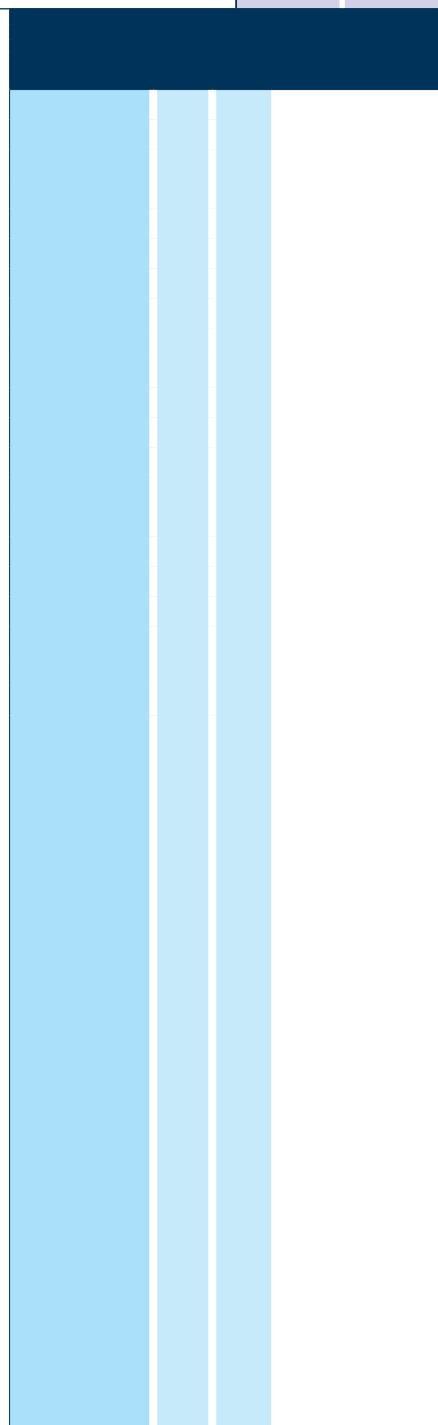
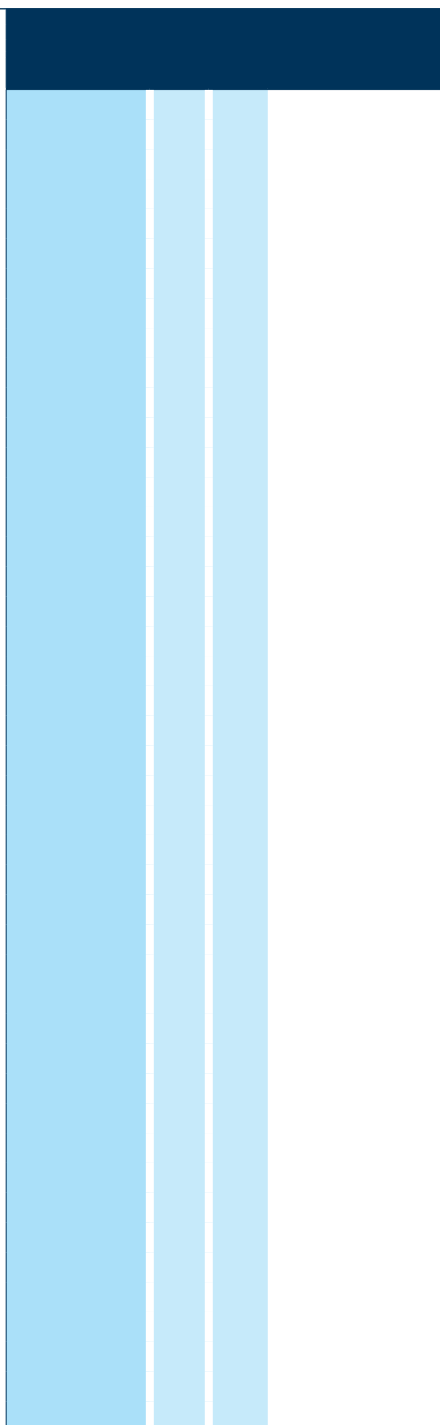

MATERIALI - MATERIALS Pag. 1199

Applicazione - Application

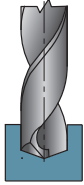

Applicazione - Application	MATERIALI - MATERIALS													ØD	Vc	fn	n (giri/min) (min ⁻¹)	Vf (mm/min)		
	P			M		K			N			S							H	G
	ACCIAIO NON LEGATO NOT ALLOY STEEL	ACCIAIO POCO LEGATO LOW ALLOY STEEL	ACCIAIO ALTO LEGATO ALLOY STEEL	INOX MARTENSITICO STAINLESS STEEL MART.	INOX AUST. DUPLEX STAINLESS STEEL AUST.	GHISA GRIGIA GREY CAST IRON	GHISA SFEROIDALE SPHEROIDAL GRAPHITE	GHISA MALLEABILE MALLEABLE CAST IRON	ALLUMINIO E SUE LEGHE ALUMINIUM	RAME E SUE LEGHE COPPER	NON METALLICI PLASTICS	LEGHE RESIST. CALORE HIGH TEMP. ALLOY	TITANIO E SUE LEGHE TITANIUM						ACCIAIO TEMPRATO HARDENED STEEL	GRAFITE GRAPHITE
●																0,5+1,0	50	0,07	-	-
●																1,0+1,5	50	0,10	-	-
●																1,5+2,0	50	0,10	-	-
●																2,0+2,5	50	0,12	-	-
●																2,5+2,9	50	0,14	-	-
			●													0,5+1,0	40	0,07	-	-
			●													1,0+1,5	40	0,10	-	-
			●													1,5+2,0	40	0,10	-	-
			●													2,0+2,5	40	0,12	-	-
			●													2,5+2,9	40	0,14	-	-
				●												0,5+1,0	30	0,04	-	-
				●												1,0+1,5	30	0,06	-	-
				●												1,5+2,0	30	0,06	-	-
				●												2,0+2,5	30	0,07	-	-
				●												2,5+2,9	30	0,08	-	-
																0,5+1,0	65	0,07	-	-
																1,0+1,5	65	0,10	-	-
																1,5+2,0	65	0,10	-	-
																2,0+2,5	65	0,12	-	-
																2,5+2,9	65	0,14	-	-
																0,5+1,0	115	0,07	-	-
																1,0+1,5	115	0,10	-	-
																1,5+2,0	115	0,10	-	-
																2,0+2,5	115	0,12	-	-
																2,5+2,9	115	0,14	-	-
																0,5+1,0	15	0,03	-	-
																1,0+1,5	15	0,04	-	-
																1,5+2,0	15	0,04	-	-
																2,0+2,5	15	0,05	-	-
																2,5+2,9	15	0,06	-	-
																0,5+1,0	15	0,025	-	-
																1,0+1,5	15	0,025	-	-
																1,5+2,0	15	0,025	-	-
																2,0+2,5	15	0,035	-	-
																2,5+2,9	15	0,035	-	-
																0,5+1,0	15	0,015	-	-
																1,0+1,5	15	0,015	-	-
																1,5+2,0	15	0,015	-	-
																2,0+2,5	15	0,025	-	-
																2,5+2,9	15	0,025	-	-

● APPLICAZIONE CONSIGLIATA-RECOMMENDED APPLICATION
EMPFÖHLENER EINSATZ - APPLICATION CONSEILLÉE

○ APPLICAZIONE POSSIBILE - POSSIBLE APPLICATION
MÖGLICHE ANWENDUNG - APPLICATION POSSIBLE

Vc = m/min VELOCITÀ DI TAGLIO - CUTTING SPEED

n = giri/min (min⁻¹) NUMERO DI GIRI - NUMBER OF REVOLUTIONS

fn = mm AVANZAMENTO AL GIRO - FEED / REVOLUTION

Vf = mm/min VELOCITÀ DI AVANZAMENTO - FEED SPEED

$$n = \frac{Vc \cdot 1000}{\text{ØD} \cdot 3,14} = \text{giri/min (min}^{-1}\text{)}$$

$$Vf = fn \cdot n = \text{mm/min}$$

SDMN0510

$\varnothing D = 0,5 - 2,9$

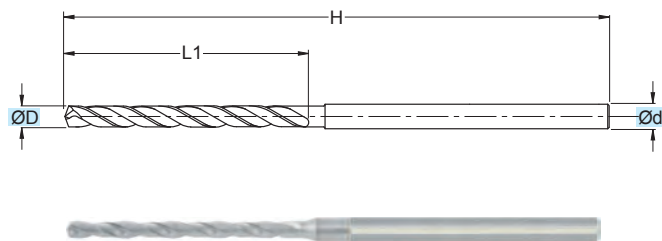

TOLLERANZE	D	d
TOLLERANCE RANGE	h7	h7

	5xD
	DIN 6537
	MG

(mm)				
ART.	ØD	Ød	H	L1
SDMN0510005	0,5	3	50	10
SDMN0510006	0,6	3	50	10
SDMN0510007	0,7	3	50	10
SDMN0510008	0,8	3	50	10
SDMN0510009	0,9	3	50	10
SDMN0510010	1,0	3	50	10
SDMN0510011	1,1	3	60	20
SDMN0510012	1,2	3	60	20
SDMN0510013	1,3	3	60	20
SDMN0510014	1,4	3	60	20
SDMN0510015	1,5	3	60	20
SDMN0510016	1,6	3	60	20
SDMN0510017	1,7	3	60	20
SDMN0510018	1,8	3	60	20
SDMN0510019	1,9	3	60	20
SDMN0510020	2,0	3	60	20
SDMN0510021	2,1	3	66	28
SDMN0510022	2,2	3	66	28
SDMN0510023	2,3	3	66	28
SDMN0510024	2,4	3	66	28
SDMN0510025	2,5	3	66	28
SDMN0510026	2,6	3	66	28
SDMN0510027	2,7	3	66	28
SDMN0510028	2,8	3	66	28
SDMN0510029	2,9	3	66	28

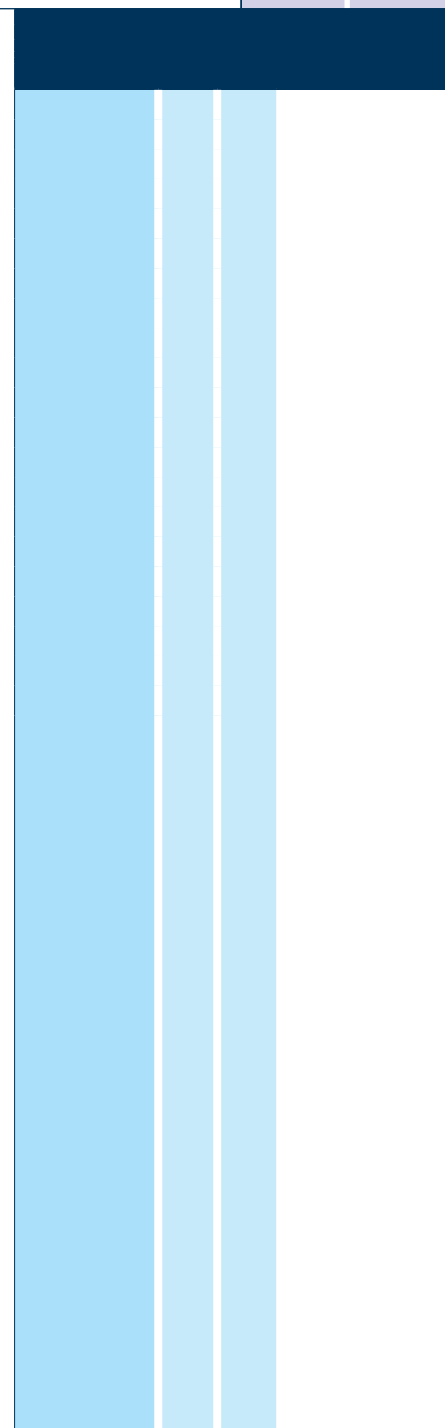
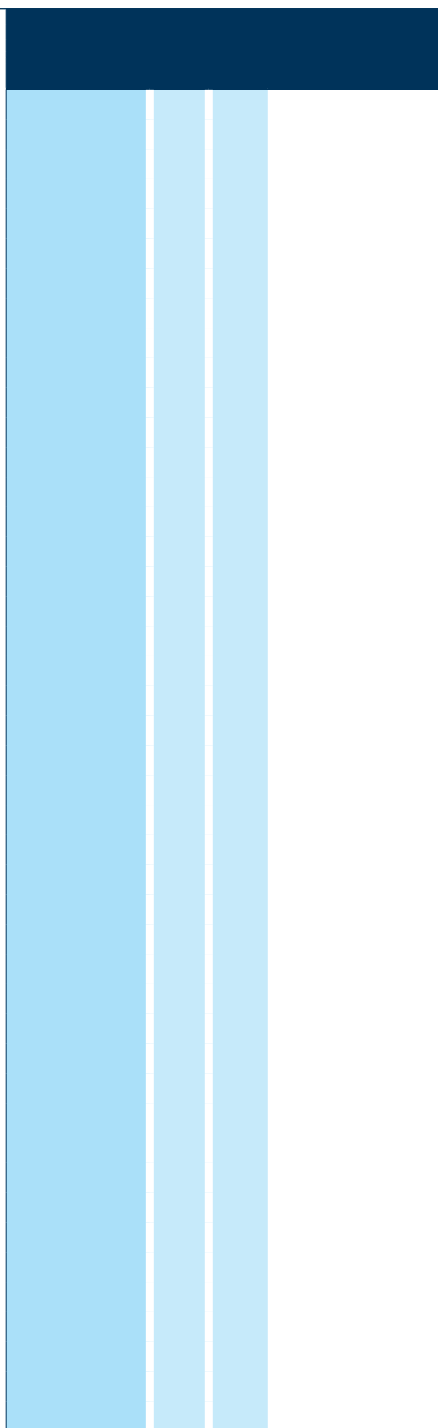

MATERIALI - MATERIALS Pag. 1199

Applicazione - Application

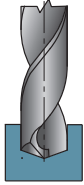

	MATERIALI - MATERIALS											ØD	Vc	fn	n (giri/min) (min ⁻¹)	Vf (mm/min)				
	P			M		K			N		S						H	G		
	ACCIAIO NON LEGATO NOT ALLOY STEEL	ACCIAIO POCO LEGATO LOW ALLOY STEEL	ACCIAIO ALTO LEGATO ALLOY STEEL	INOX MARTENSITICO STAINLESS STEEL MART.	INOX AUST. DUPLEX STAINLESS STEEL AUST.	GHISA GRIGIA GREY CAST IRON	GHISA SFEROIDALE SPHEROIDAL GRAPHITE	GHISA MALLEABILE MALLEABLE CAST IRON	ALLUMINIO E SUE LEGHE ALUMINIUM	RAME E SUE LEGHE COPPER	NON METALLICI PLASTICS	LEGHE RESIST. CALORE HIGH TEMP. ALLOY	TITANIO E SUE LEGHE TITANIUM	ACCIAIO TEMPRATO HARDENED STEEL	GRAFITE GRAPHITE					
●																0,5+1,0	40	0,04	-	-
●																1,0+1,5	40	0,04	-	-
●																1,5+2,0	40	0,06	-	-
●																2,0+2,5	40	0,06	-	-
●																2,5+2,9	40	0,08	-	-
			●													0,5+1,0	30	0,04	-	-
			●													1,0+1,5	30	0,04	-	-
			●													1,5+2,0	30	0,06	-	-
			●													2,0+2,5	30	0,06	-	-
			●													2,5+2,9	30	0,08	-	-
					○											0,5+1,0	20	0,03	-	-
					○											1,0+1,5	20	0,03	-	-
					○											1,5+2,0	20	0,04	-	-
					○											2,0+2,5	20	0,04	-	-
					○											2,5+2,9	20	0,05	-	-
							●									0,5+1,0	50	0,03	-	-
							●									1,0+1,5	50	0,03	-	-
							●									1,5+2,0	50	0,04	-	-
							●									2,0+2,5	50	0,04	-	-
							●									2,5+2,9	50	0,05	-	-
								●								0,5+1,0	80	0,04	-	-
								●								1,0+1,5	80	0,04	-	-
								●								1,5+2,0	80	0,06	-	-
								●								2,0+2,5	80	0,06	-	-
								●								2,5+2,9	80	0,08	-	-

● APPLICAZIONE CONSIGLIATA-RECOMMENDED APPLICATION
EMPFÖHLENER EINSATZ - APPLICATION CONSEILLÉE

○ APPLICAZIONE POSSIBILE - POSSIBLE APPLICATION
MÖGLICHE ANWENDUNG - APPLICATION POSSIBLE

Vc = m/min VELOCITÀ DI TAGLIO - CUTTING SPEED

n = giri/min (min⁻¹) NUMERO DI GIRI - NUMBER OF REVOLUTIONS

fn = mm AVANZAMENTO AL GIRO - FEED / REVOLUTION

Vf = mm/min VELOCITÀ DI AVANZAMENTO - FEED SPEED

$$n = \frac{Vc \cdot 1000}{\text{ØD} \cdot 3,14} = \text{giri/min (min}^{-1}\text{)}$$

$$Vf = fn \cdot n = \text{mm/min}$$

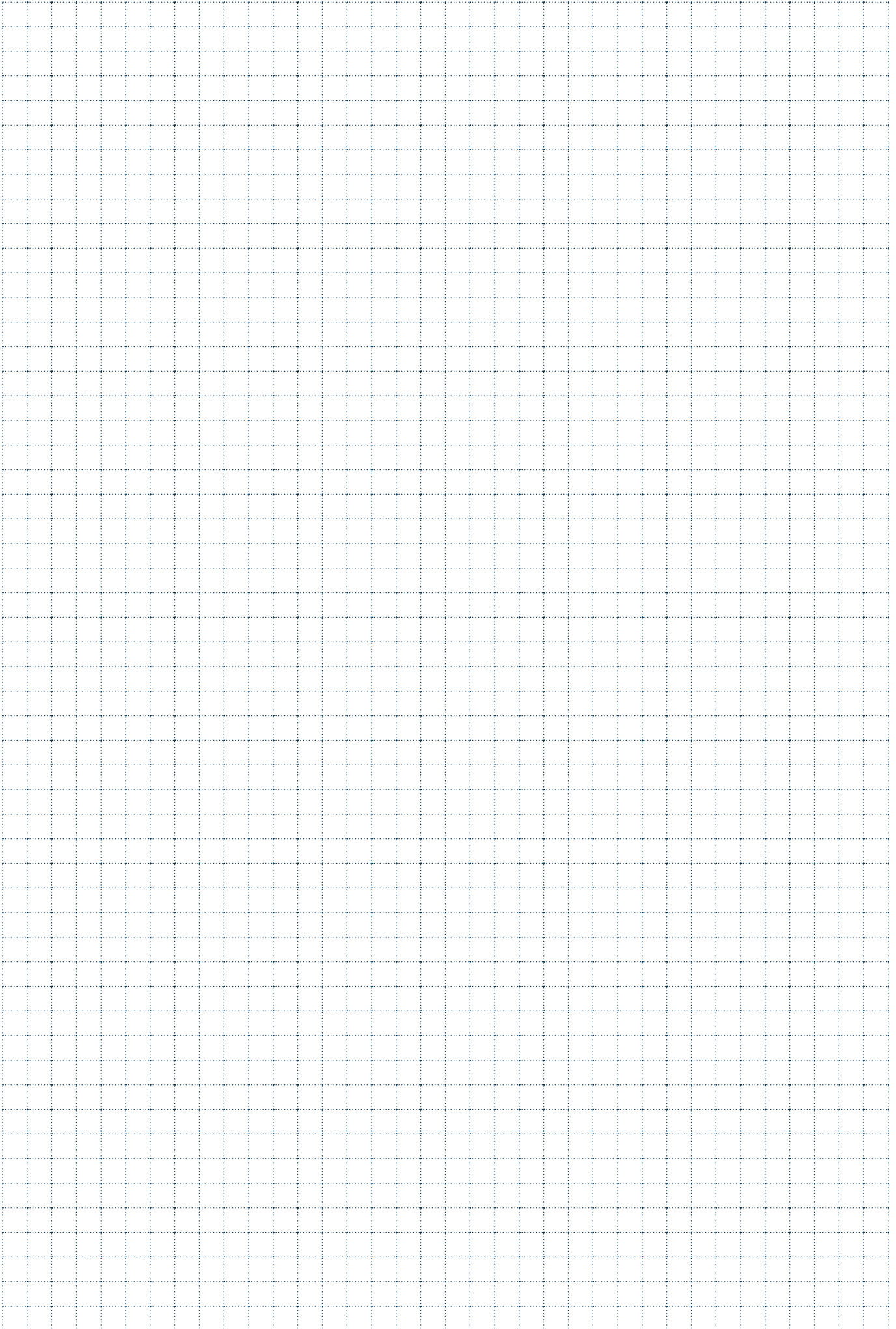



PUNTE INTEGRALI IN HM

SOLID CARBIDE DRILLS / HM VOLLBOHRER /
FORETS EN CARBURE MONOBLOC / BROCAS INTEGRALES EN METAL DURO

SD1800

ØD = 1,5 - 12

NEW

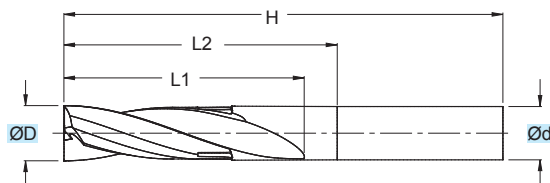

TOLLERANZE	D	d
TOLERANCE RANGE	h7	h6

RIVESTIM. COATED	2xD
BRONZE	
MG	

ART.	(mm)				
ART.	ØD	Ød	H	L1	L2
SD18002015	1,5	3	46	4,9	5,5
SD18002020	2,0	4	50	9	9,5
SD18002022	2,2	4	50	11	11,5
SD18002023	2,3	4	50	11	11,5
SD18002025	2,5	4	50	12	12,5
SD18002028	2,8	4	50	14	14,5
SD18002030	3,0	6	50	14	14,5
SD18002031	3,1	6	50	15	15,5
SD18002032	3,2	6	50	15	15,5
SD18002033	3,3	6	50	15	15,5
SD18002034	3,4	6	50	16	16,5
SD18002035	3,5	6	50	16	16,5
SD18002036	3,6	6	50	16	16,5
SD18002037	3,7	6	50	18	18,5
SD18002038	3,8	6	50	18	18,5
SD18002039	3,9	6	50	18	18,5
SD18002040	4,0	6	50	18	18,5
SD18002041	4,1	6	50	19	20,0
SD18002042	4,2	6	60	19	20,0
SD18002043	4,3	6	60	19	20,0
SD18002044	4,4	6	60	19	20,0
SD18002045	4,5	6	60	21	22,0
SD18002046	4,6	6	60	21	22,0
SD18002047	4,7	6	60	22	23,0
SD18002048	4,8	6	60	22	23,0
SD18002049	4,9	6	60	22	23,0
SD18002050	5,0	6	60	23	24,0
SD18002051	5,1	6	60	24	26,5
SD18002052	5,2	6	60	24	26,5
SD18002053	5,3	6	60	24	26,5
SD18002054	5,4	6	60	25	27,5
SD18002055	5,5	6	60	25	27,5
SD18002056	5,6	6	60	25	27,5
SD18002057	5,7	6	60	27	29,5
SD18002058	5,8	6	60	27	29,5
SD18002059	5,9	6	60	27	29,5
SD18002060	6,0	6	60	27	30,0
SD18002061	6,1	8	73	28	31,0
SD18002062	6,2	8	73	28	31,0
SD18002063	6,3	8	73	28	31,0
SD18002064	6,4	8	73	30	33,0
SD18002065	6,5	8	73	30	33,0
SD18002066	6,6	8	73	30	33,0
SD18002067	6,7	8	73	31	34,0
SD18002068	6,8	8	73	31	34,0

ART.	(mm)				
ART.	ØD	Ød	H	L1	L2
SD18002069	6,9	8	73	31	34,0
SD18002070	7,0	8	73	32	35,0
SD18002072	7,2	8	73	33	36,0
SD18002075	7,5	8	73	34	37,0
SD18002078	7,8	8	73	36	39,0
SD18002080	8,0	8	73	36	39,0
SD18002082	8,2	10	83	37	40,0
SD18002083	8,3	10	83	37	40,0
SD18002085	8,5	10	83	39	42,0
SD18002088	8,8	10	83	40	43,0
SD18002090	9,0	10	83	41	44,0
SD18002092	9,2	10	83	42	45,0
SD18002093	9,3	10	83	42	45,0
SD18002095	9,5	10	83	43	46,0
SD18002098	9,8	10	83	45	48,0
SD18002100	10,0	10	83	45	48,0
SD18002102	10,2	12	93	46	49,0
SD18002103	10,3	12	93	46	49,0
SD18002105	10,5	12	93	48	51,0
SD18002108	10,8	12	93	49	52,0
SD18002110	11,0	12	93	50	53,0
SD18002115	11,5	12	93	52	55,0
SD18002118	11,8	12	93	54	57,0
SD18002120	12,0	12	93	54	57,0

MATERIALI - MATERIALS Pag. 1199

Applicazione - Application

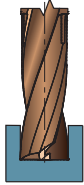

P	M	K	N	S	H	G	ØD	Vc	fn	n	Vf
●							1,5-2	70	0,024	14862	360
●							2-3	70	0,040	8917	360
●							3-4	75	0,062	6824	420
●							4-5	75	0,079	5308	420
●							5-6	75	0,097	4343	420
●							6-7	75	0,114	3675	420
●							7-8	75	0,132	3185	420
●							8-9	75	0,149	2810	420
●							9-10	75	0,167	2514	420
●							10-11	75	0,185	2275	420
●							11-12	75	0,202	2077	420
●							1,5-2	60	0,022	12739	280
●							2-3	60	0,041	7643	310
●							3-4	65	0,061	5914	360
●							4-5	65	0,078	4600	360
●							5-6	65	0,096	3764	360
●							6-7	65	0,113	3185	360
●							7-8	65	0,130	2760	360
●							8-9	65	0,148	2435	360
●							9-10	65	0,165	2179	360
●							10-11	65	0,183	1971	360
●							11-12	65	0,200	1800	360
●							1,5-2	35	0,017	7431	130
●							2-3	35	0,036	4459	160
●							3-4	35	0,053	3185	170
●							4-5	35	0,069	2477	170
●							5-6	35	0,084	2027	170
●							6-7	35	0,099	1715	170
●							7-8	35	0,114	1486	170
●							8-9	35	0,130	1311	170
●							9-10	35	0,145	1173	170
●							10-11	35	0,160	1062	170
●							11-12	35	0,175	969	170
●		●					1,5-2	70	0,015	14862	220
●		●					2-3	70	0,028	8917	250
●		●					3-4	75	0,045	6824	310
●		●					4-5	75	0,058	5308	310
●		●					5-6	75	0,071	4343	310
●		●					6-7	75	0,084	3675	310
●		●					7-8	75	0,097	3185	310
●		●					8-9	75	0,110	2810	310
●		●					9-10	75	0,123	2514	310
●		●					10-11	75	0,136	2275	310
●		●					11-12	75	0,149	2077	310
●			●				1,5-2	150	0,024	31847	770
●			●				2-3	150	0,043	19108	830
●			●				3-4	160	0,070	14559	1020
●			●				4-5	160	0,090	11323	1020
●			●				5-6	160	0,110	9265	1020
●			●				6-7	160	0,130	7839	1020
●			●				7-8	160	0,150	6794	1020
●			●				8-9	160	0,170	5995	1020
●			●				9-10	160	0,190	5364	1020
●			●				10-11	160	0,210	4853	1020
●			●				11-12	160	0,230	4431	1020
●				●			1,5-2	100	0,023	21231	490
●				●			2-3	100	0,042	12739	530
●				●			3-4	160	0,045	14559	660
●				●			4-5	160	0,058	11323	660
●				●			5-6	160	0,071	9265	660
●				●			6-7	160	0,084	7839	660
●				●			7-8	160	0,097	6794	660
●				●			8-9	160	0,110	5995	660
●				●			9-10	160	0,123	5364	660
●				●			10-11	160	0,136	4853	660
●				●			11-12	160	0,149	4431	660
○					○		1,5-2	25	0,009	5308	50
○					○		2-3	25	0,022	3185	70
○					○		3-4	25	0,035	2275	80
○					○		4-5	25	0,045	1769	80
○					○		5-6	25	0,055	1448	80
○					○		6-7	25	0,065	1225	80
○					○		7-8	25	0,075	1062	80
○					○		8-9	25	0,085	937	80
○					○		9-10	25	0,095	838	80
○					○		10-11	25	0,106	758	80
○					○		11-12	25	0,116	692	80

● APPLICAZIONE CONSIGLIATA-RECOMMENDED APPLICATION
EMPFÖHLENER EINSATZ - APPLICATION CONSEILLÉE

○ APPLICAZIONE POSSIBILE - POSSIBLE APPLICATION
MÖGLICHE ANWENDUNG - APPLICATION POSSIBLE

Vc = m/min VELOCITÀ DI TAGLIO - CUTTING SPEED

n = giri/min (min⁻¹) NUMERO DI GIRI - NUMBER OF REVOLUTIONS

fn = mm AVANZAMENTO AL GIRO - FEED / REVOLUTION

Vf = mm/min VELOCITÀ DI AVANZAMENTO - FEED SPEED

$$n = \frac{Vc \cdot 1000}{\text{ØD} \cdot 3,14} = \text{giri/min (min}^{-1}\text{)}$$

$$Vf = fn \cdot n = \text{mm/min}$$

SDR0341

$\varnothing D = 3 - 12$

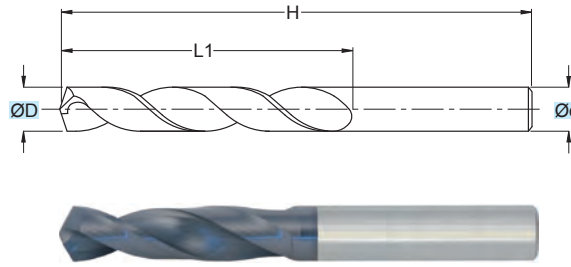

TOLLERANZE	D	d
TOLLERANCE RANGE	h7	h7

RIVESTIM. COATED TIALN	3xD
	DIN 1897
	MG

ART.	(mm)			
	$\varnothing D$	$\varnothing d$	H	L1
SDR0341030	3,0	3,0	46	16
SDR0341031	3,1	3,1	49	18
SDR0341032	3,2	3,2	49	18
SDR0341033	3,3	3,3	49	18
SDR0341034	3,4	3,4	52	20
SDR0341035	3,5	3,5	52	20
SDR0341036	3,6	3,6	52	20
SDR0341037	3,7	3,7	52	20
SDR0341038	3,8	3,8	55	22
SDR0341039	3,9	3,9	55	22
SDR0341040	4,0	4,0	55	22
SDR0341041	4,1	4,1	55	22
SDR0341042	4,2	4,2	55	22
SDR0341043	4,3	4,3	58	24
SDR0341044	4,4	4,4	58	24
SDR0341045	4,5	4,5	58	24
SDR0341046	4,6	4,6	58	24
SDR0341047	4,7	4,7	58	24
SDR0341048	4,8	4,8	62	26
SDR0341049	4,9	4,9	62	26
SDR0341050	5,0	5,0	62	26
SDR0341051	5,1	5,1	62	26
SDR0341052	5,2	5,2	62	26
SDR0341053	5,3	5,3	62	26
SDR0341054	5,4	5,4	66	28
SDR0341055	5,5	5,5	66	28
SDR0341056	5,6	5,6	66	28
SDR0341057	5,7	5,7	66	28
SDR0341058	5,8	5,8	66	28
SDR0341059	5,9	5,9	66	28
SDR0341060	6,0	6,0	66	28
SDR0341061	6,1	6,1	70	31
SDR0341062	6,2	6,2	70	31
SDR0341063	6,3	6,3	70	31
SDR0341064	6,4	6,4	70	31
SDR0341065	6,5	6,5	70	31
SDR0341066	6,6	6,6	70	31
SDR0341067	6,7	6,7	70	31
SDR0341068	6,8	6,8	74	34
SDR0341069	6,9	6,9	74	34
SDR0341070	7,0	7,0	74	34
SDR0341071	7,1	7,1	74	34
SDR0341072	7,2	7,2	74	34
SDR0341073	7,3	7,3	74	34
SDR0341074	7,4	7,4	74	34

ART.	(mm)			
	$\varnothing D$	$\varnothing d$	H	L1
SDR0341075	7,5	7,5	74	34
SDR0341076	7,6	7,6	79	37
SDR0341077	7,7	7,7	79	37
SDR0341078	7,8	7,8	79	37
SDR0341079	7,9	7,9	79	37
SDR0341080	8,0	8,0	79	37
SDR0341081	8,1	8,1	79	37
SDR0341082	8,2	8,2	79	37
SDR0341083	8,3	8,3	79	37
SDR0341084	8,4	8,4	79	37
SDR0341085	8,5	8,5	79	37
SDR0341086	8,6	8,6	84	40
SDR0341087	8,7	8,7	84	40
SDR0341088	8,8	8,8	84	40
SDR0341089	8,9	8,9	84	40
SDR0341090	9,0	9,0	84	40
SDR0341091	9,1	9,1	84	40
SDR0341092	9,2	9,2	84	40
SDR0341093	9,3	9,3	84	40
SDR0341094	9,4	9,4	84	40
SDR0341095	9,5	9,5	84	40
SDR0341096	9,6	9,6	89	43
SDR0341097	9,7	9,7	89	43
SDR0341098	9,8	9,8	89	43
SDR0341099	9,9	9,9	89	43
SDR0341100	10,0	10,0	89	43
SDR0341102	10,2	10,2	89	43
SDR0341105	10,5	10,5	89	43
SDR0341110	11,0	11,0	95	47
SDR0341115	11,5	11,5	95	47
SDR0341120	12,0	12,0	102	51

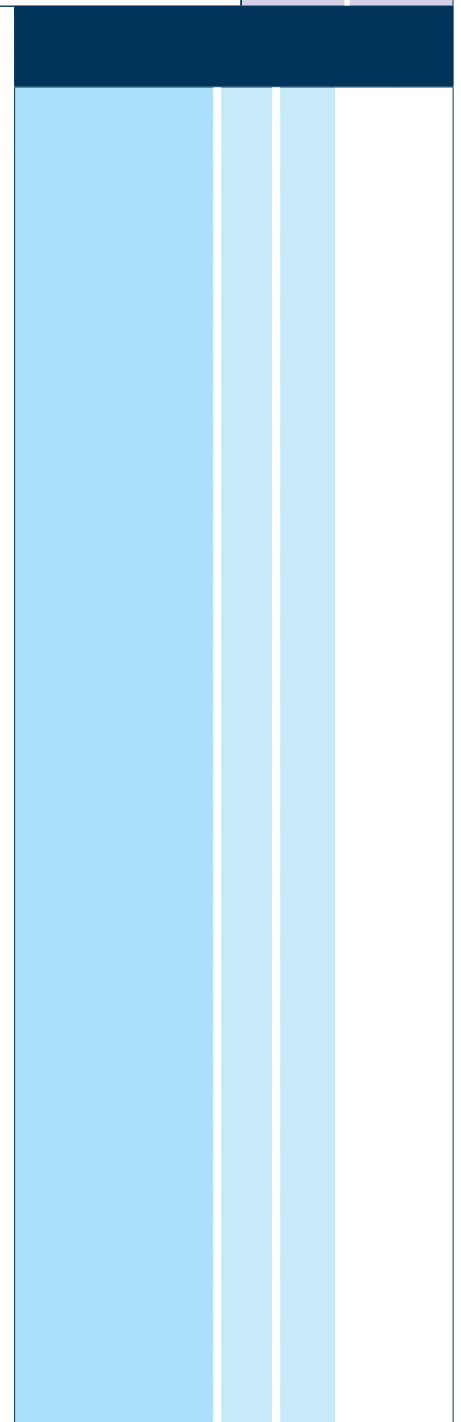

MATERIALI - MATERIALS Pag. 1199

Applicazione - Application

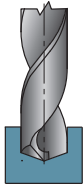

P	M	K	N	S	H	G	ØD	Vc	fn	n	Vf			
												ACCAIO NON LEGATO NOT ALLOY STEEL	ACCAIO POCO LEGATO LOW ALLOY STEEL	ACCAIO ALTO LEGATO ALLOY STEEL
●							3÷4	80	0,040	7279	291			
●							4÷5	80	0,050	5662	283			
●							5÷6	80	0,075	4632	347			
●							6÷7	80	0,090	3920	353			
●							7÷8	80	0,110	3397	374			
●							8÷9	80	0,125	2997	375			
●							9÷10	80	0,135	2682	362			
●							10÷12	80	0,150	2316	347			
●							3÷4	60	0,040	5460	218			
●							4÷5	60	0,050	4246	212			
●							5÷6	60	0,075	3474	261			
●							6÷7	60	0,090	2940	265			
●							7÷8	60	0,110	2548	280			
●							8÷9	60	0,125	2248	281			
●							9÷10	60	0,135	2011	272			
●							10÷12	60	0,150	1737	261			
							3÷4	84	0,045	7643	344			
							4÷5	84	0,070	5945	416			
							5÷6	84	0,090	4864	438			
							6÷7	84	0,110	4116	453			
							7÷8	84	0,130	3567	464			
							8÷9	84	0,145	3147	456			
							9÷10	84	0,155	2816	436			
							10÷12	84	0,170	2432	413			
							3÷4	70	0,045	6369	287			
							4÷5	70	0,070	4954	347			
							5÷6	70	0,090	4053	365			
							6÷7	70	0,110	3430	377			
							7÷8	70	0,130	2972	386			
							8÷9	70	0,145	2623	380			
							9÷10	70	0,155	2347	364			
							10÷12	70	0,170	2027	345			
							3÷4	130	0,014	11829	166			
							4÷5	130	0,018	9200	166			
							5÷6	130	0,025	7528	188			
							6÷7	130	0,045	6369	287			
							7÷8	130	0,055	5520	304			
							8÷9	130	0,065	4871	317			
							9÷10	130	0,075	4358	327			
							10÷12	130	0,090	3764	339			
							3÷4	100	0,006	9099	55			
							4÷5	100	0,012	7077	85			
							5÷6	100	0,016	5790	93			
							6÷7	100	0,025	4900	122			
							7÷8	100	0,040	4246	170			
							8÷9	100	0,055	3747	206			
							9÷10	100	0,065	3352	218			
							10÷12	100	0,085	2895	246			

● APPLICAZIONE CONSIGLIATA-RECOMMENDED APPLICATION
EMPFOLLENER EINSATZ - APPLICATION CONSEILLÉE

○ APPLICAZIONE POSSIBILE - POSSIBLE APPLICATION
MÖGLICHE ANWENDUNG - APPLICATION POSSIBLE

Vc = m/min VELOCITÀ DI TAGLIO - CUTTING SPEED

n = giri/min (min⁻¹) NUMERO DI GIRI - NUMBER OF REVOLUTIONS

fn = mm AVANZAMENTO AL GIRO - FEED / REVOLUTION

Vf = mm/min VELOCITÀ DI AVANZAMENTO - FEED SPEED

$$n = \frac{Vc \cdot 1000}{\text{ØD} \cdot 3,14} = \text{giri/min (min}^{-1}\text{)}$$

$$Vf = fn \cdot n = \text{mm/min}$$

SDR0302

ØD = 3 - 20

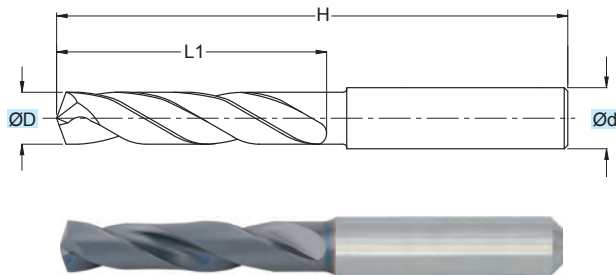

TOLLERANZE	D	d
TOLERANCE RANGE	m7	h6

RIVESTIM.
COATED
TIALN

3xD

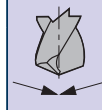
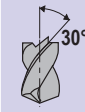
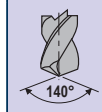

DIN 6535



MG

ART.	(mm)			
	ØD	Ød	H	L1
SDR0302030	3,0	6	62	20
SDR0302031	3,1	6	62	20
SDR0302032	3,2	6	62	20
SDR0302033	3,3	6	62	20
SDR0302034	3,4	6	62	20
SDR0302035	3,5	6	62	20
SDR0302036	3,6	6	62	20
SDR0302037	3,7	6	62	20
SDR0302038	3,8	6	66	24
SDR0302039	3,9	6	66	24
SDR0302040	4,0	6	66	24
SDR0302041	4,1	6	66	24
SDR0302042	4,2	6	66	24
SDR0302043	4,3	6	66	24
SDR0302044	4,4	6	66	24
SDR0302045	4,5	6	66	24
SDR0302046	4,6	6	66	24
SDR03020465 New	4,65	6	66	24
SDR0302047	4,7	6	66	24
SDR0302048	4,8	6	66	28
SDR0302049	4,9	6	66	28
SDR0302050	5,0	6	66	28
SDR0302051	5,1	6	66	28
SDR0302052	5,2	6	66	28
SDR0302053	5,3	6	66	28
SDR0302054	5,4	6	66	28
SDR0302055	5,5	6	66	28
SDR03020555 New	5,55	6	66	28
SDR0302056	5,6	6	66	28
SDR0302057	5,7	6	66	28
SDR0302058	5,8	6	66	28
SDR0302059	5,9	6	66	28
*SDR0302060	6,0	6	66	28
SDR0302061	6,1	8	79	34
SDR0302062	6,2	8	79	34
SDR0302063	6,3	8	79	34
SDR0302064	6,4	8	79	34
SDR0302065	6,5	8	79	34
SDR0302066	6,6	8	79	34
SDR0302067	6,7	8	79	34
SDR0302068	6,8	8	79	34
SDR0302069	6,9	8	79	34
SDR0302070	7,0	8	79	34
SDR0302071	7,1	8	79	41
SDR0302072	7,2	8	79	41

ART.	(mm)			
	ØD	Ød	H	L1
SDR0302073	7,3	8	79	41
SDR0302074	7,4	8	79	41
SDR0302075	7,5	8	79	41
SDR0302076	7,6	8	79	41
SDR0302077	7,7	8	79	41
SDR0302078	7,8	8	79	41
SDR0302079	7,9	8	79	41
*SDR0302080	8,0	8	79	41
SDR0302081	8,1	10	89	47
SDR0302082	8,2	10	89	47
SDR0302083	8,3	10	89	47
SDR0302084	8,4	10	89	47
SDR0302085	8,5	10	89	47
SDR0302086	8,6	10	89	47
SDR0302087	8,7	10	89	47
SDR0302088	8,8	10	89	47
SDR0302089	8,9	10	89	47
SDR0302090	9,0	10	89	47
SDR0302091	9,1	10	89	47
SDR0302092	9,2	10	89	47
SDR0302093	9,3	10	89	47
SDR0302094	9,4	10	89	47
SDR0302095	9,5	10	89	47
SDR0302096	9,6	10	89	47
SDR0302097	9,7	10	89	47
SDR0302098	9,8	10	89	47
SDR0302099	9,9	10	89	47
*SDR0302100	10,0	10	89	47
SDR0302102	10,2	12	102	55
SDR0302105	10,5	12	102	55
SDR0302108	10,8	12	102	55
SDR0302110	11,0	12	102	55
SDR0302112	11,2	12	102	55
SDR0302115	11,5	12	102	55
SDR0302118	11,8	12	102	55
*SDR0302120	12,0	12	102	55
SDR0302122	12,2	14	107	60
SDR0302125	12,5	14	107	60
SDR0302128	12,8	14	107	60
SDR0302130	13,0	14	107	60
SDR0302131 New	13,1	14	107	60
SDR0302135	13,5	14	107	60
SDR0302138	13,8	14	107	60
*SDR0302140	14,0	14	107	60
SDR0302142	14,2	16	115	65

ART.	(mm)			
	ØD	Ød	H	L1
SDR0302145	14,5	16	115	65
SDR0302148	14,8	16	115	65
SDR0302150	15,0	16	115	65
SDR0302151 New	15,1	16	115	65
SDR0302152	15,2	16	115	65
SDR0302155	15,5	16	115	65
SDR0302158	15,8	16	115	65
*SDR0302160	16,0	16	115	65
SDR0302165	16,5	18	123	73
SDR0302168	16,8	18	123	73
SDR0302170	17,0	18	123	73
SDR0302175	17,5	18	123	73
*SDR0302180	18,0	18	123	73
SDR0302185	18,5	20	131	79
SDR0302188	18,8	20	131	79
SDR0302190	19,0	20	131	79
SDR0302195	19,5	20	131	79
*SDR0302200	20,0	20	131	79

* = COSTRUITI IN TOLLERANZA h7
 * = MADE WITH h7 TOLERANCE
 * = GEBAUT MIT TOLERANZ h7
 * = RÉALISÉS EN TOLÉRANCE h7

MATERIALI - MATERIALS Pag. 1199

Applicazione - Application

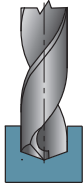

P	M	K	N	S	H	G	ØD	Vc	fn	n	Vf			
												ACCAIO NON LEGATO NOT ALLOY STEEL	ACCAIO POCO LEGATO LOW ALLOY STEEL	ACCAIO ALTO LEGATO ALLOY STEEL
•							3÷4	90	0,035	8189	287			
•							4÷5	90	0,045	6369	287			
•							5÷6	90	0,060	5211	313			
•							6÷7	90	0,070	4410	309			
•							7÷8	90	0,080	3822	306			
•							8÷9	90	0,100	3372	337			
•							9÷10	90	0,110	3017	332			
•							10÷12	90	0,120	2606	313			
•							12÷14	90	0,130	2205	287			
•							14÷16	90	0,165	1911	315			
•							16÷18	90	0,190	1686	320			
•							18÷20	90	0,210	1509	317			
•							3÷4	80	0,035	7279	255			
•							4÷5	80	0,045	5662	255			
•							5÷6	80	0,060	4632	278			
•							6÷7	80	0,070	3920	274			
•							7÷8	80	0,080	3397	272			
•							8÷9	80	0,100	2997	300			
•							9÷10	80	0,110	2682	295			
•							10÷12	80	0,120	2316	278			
•							12÷14	80	0,130	1960	255			
•							14÷16	80	0,165	1699	280			
•							16÷18	80	0,190	1499	285			
•							18÷20	80	0,210	1341	282			
							3÷4	40	0,080	3640	291			
							4÷5	40	0,080	2831	226			
							5÷6	40	0,120	2316	278			
							6÷7	40	0,120	1960	235			
							7÷8	40	0,120	1699	204			
							8÷9	40	0,150	1499	225			
							9÷10	40	0,150	1341	201			
							10÷12	40	0,150	1158	174			
							12÷14	40	0,200	980	196			
							14÷16	40	0,200	849	170			
							16÷18	40	0,250	749	187			
							18÷20	40	0,250	670	168			
							3÷4	110	0,090	10009	901			
							4÷5	110	0,120	7785	934			
							5÷6	110	0,150	6369	955			
							6÷7	110	0,170	5390	916			
							7÷8	110	0,190	4671	887			
							8÷9	110	0,210	4121	865			
							9÷10	110	0,230	3688	848			
							10÷12	110	0,260	3185	828			
							12÷14	110	0,300	2695	808			
							14÷16	110	0,340	2335	794			
							16÷18	110	0,370	2061	762			
							18÷20	110	0,410	1844	756			
							3÷4	90	0,090	8189	737			
							4÷5	90	0,120	6369	764			
							5÷6	90	0,150	5211	782			
							6÷7	90	0,170	4410	750			
							7÷8	90	0,190	3822	726			
							8÷9	90	0,210	3372	708			
							9÷10	90	0,230	3017	694			
							10÷12	90	0,260	2606	677			
							12÷14	90	0,300	2205	661			
							14÷16	90	0,340	1911	650			
							16÷18	90	0,370	1686	624			
							18÷20	90	0,410	1509	619			

• APPLICAZIONE CONSIGLIATA-RECOMMENDED APPLICATION
EMPFÖHLENER EINSATZ - APPLICATION CONSEILLÉE

○ APPLICAZIONE POSSIBILE - POSSIBLE APPLICATION
MÖGLICHE ANWENDUNG - APPLICATION POSSIBLE

Vc = m/min VELOCITÀ DI TAGLIO - CUTTING SPEED

n = giri/min (min⁻¹) NUMERO DI GIRI - NUMBER OF REVOLUTIONS

fn = mm AVANZAMENTO AL GIRO - FEED / REVOLUTION

Vf = mm/min VELOCITÀ DI AVANZAMENTO - FEED SPEED

$$n = \frac{Vc \cdot 1000}{\text{ØD} \cdot 3,14} = \text{giri/min (min}^{-1}\text{)}$$

$$Vf = fn \cdot n = \text{mm/min}$$

SDF0302

ØD = 3 - 20

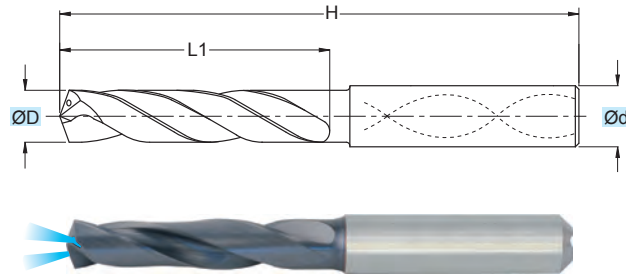

TOLLERANZE	D	d
TOLLERANCE RANGE	m7	h6

RIVESTIM. COATED TIALN	3xD
	DIN 6535
	MG

ART.	(mm)			
	ØD	Ød	H	L1
SDF0302030	3,0	6,0	62,0	20,0
SDF0302031	3,1	6,0	62,0	20,0
SDF0302032	3,2	6,0	62,0	20,0
SDF0302033	3,3	6,0	62,0	20,0
SDF0302034	3,4	6,0	62,0	20,0
SDF0302035	3,5	6,0	62,0	20,0
SDF0302036	3,6	6,0	62,0	20,0
SDF0302037	3,7	6,0	62,0	20,0
SDF0302038	3,8	6,0	66,0	24,0
SDF0302039	3,9	6,0	66,0	24,0
SDF0302040	4,0	6,0	66,0	24,0
SDF0302041	4,1	6,0	66,0	24,0
SDF0302042	4,2	6,0	66,0	24,0
SDF0302043	4,3	6,0	66,0	24,0
SDF0302044	4,4	6,0	66,0	24,0
SDF0302045	4,5	6,0	66,0	24,0
SDF0302046	4,6	6,0	66,0	24,0
SDF03020465 New	4,65	6,0	66,0	24,0
SDF0302047	4,7	6,0	66,0	24,0
SDF0302048	4,8	6,0	66,0	28,0
SDF0302049	4,9	6,0	66,0	28,0
SDF0302050	5,0	6,0	66,0	28,0
SDF0302051	5,1	6,0	66,0	28,0
SDF0302052	5,2	6,0	66,0	28,0
SDF0302053	5,3	6,0	66,0	28,0
SDF0302054	5,4	6,0	66,0	28,0
SDF0302055	5,5	6,0	66,0	28,0
SDF03020555 New	5,55	6,0	66,0	28,0
SDF0302056	5,6	6,0	66,0	28,0
SDF0302057	5,7	6,0	66,0	28,0
SDF0302058	5,8	6,0	66,0	28,0
SDF0302059	5,9	6,0	66,0	28,0
*SDF0302060	6,0	6,0	66,0	28,0
SDF0302061	6,1	8,0	79,0	34,0
SDF0302062	6,2	8,0	79,0	34,0
SDF0302063	6,3	8,0	79,0	34,0
SDF0302064	6,4	8,0	79,0	34,0
SDF0302065	6,5	8,0	79,0	34,0
SDF0302066	6,6	8,0	79,0	34,0
SDF0302067	6,7	8,0	79,0	34,0
SDF0302068	6,8	8,0	79,0	34,0
SDF0302069	6,9	8,0	79,0	34,0
SDF0302070	7,0	8,0	79,0	34,0
SDF0302071	7,1	8,0	79,0	41,0
SDF0302072	7,2	8,0	79,0	41,0

ART.	(mm)			
	ØD	Ød	H	L1
SDF0302073	7,3	8,0	79,0	41,0
SDF0302074	7,4	8,0	79,0	41,0
SDF0302075	7,5	8,0	79,0	41,0
SDF0302076	7,6	8,0	79,0	41,0
SDF0302077	7,7	8,0	79,0	41,0
SDF0302078	7,8	8,0	79,0	41,0
SDF0302079	7,9	8,0	79,0	41,0
*SDF0302080	8,0	8,0	79,0	41,0
SDF0302081	8,1	10,0	89,0	47,0
SDF0302082	8,2	10,0	89,0	47,0
SDF0302083	8,3	10,0	89,0	47,0
SDF0302084	8,4	10,0	89,0	47,0
SDF0302085	8,5	10,0	89,0	47,0
SDF0302086	8,6	10,0	89,0	47,0
SDF0302087	8,7	10,0	89,0	47,0
SDF0302088	8,8	10,0	89,0	47,0
SDF0302089	8,9	10,0	89,0	47,0
SDF0302090	9,0	10,0	89,0	47,0
SDF0302091	9,1	10,0	89,0	47,0
SDF0302092	9,2	10,0	89,0	47,0
SDF0302093	9,3	10,0	89,0	47,0
SDF0302094	9,4	10,0	89,0	47,0
SDF0302095	9,5	10,0	89,0	47,0
SDF0302096	9,6	10,0	89,0	47,0
SDF0302097	9,7	10,0	89,0	47,0
SDF0302098	9,8	10,0	89,0	47,0
SDF0302099	9,9	10,0	89,0	47,0
*SDF0302100	10,0	10,0	89,0	47,0
SDF0302101 New	10,1	12,0	102,0	55,0
SDF0302102	10,2	12,0	102,0	55,0
SDF0302105	10,5	12,0	102,0	55,0
SDF0302108	10,8	12,0	102,0	55,0
SDF0302110	11,0	12,0	102,0	55,0
SDF0302112	11,2	12,0	102,0	55,0
SDF0302115	11,5	12,0	102,0	55,0
SDF0302118	11,8	12,0	102,0	55,0
*SDF0302120	12,0	12,0	102,0	55,0
SDF0302122	12,2	14,0	107,0	60,0
SDF0302125	12,5	14,0	107,0	60,0
SDF0302128	12,8	14,0	107,0	60,0
SDF0302130	13,0	14,0	107,0	60,0
SDF0302131 New	13,1	14,0	107,0	60,0
SDF0302135	13,5	14,0	107,0	60,0
SDF0302138	13,8	14,0	107,0	60,0
*SDF0302140	14,0	14,0	107,0	60,0

ART.	(mm)			
	ØD	Ød	H	L1
SDF0302142	14,2	16,0	115,0	65,0
SDF0302145	14,5	16,0	115,0	65,0
SDF0302148	14,8	16,0	115,0	65,0
SDF0302150	15,0	16,0	115,0	65,0
SDF0302151 New	15,1	16,0	115,0	65,0
SDF0302152	15,2	16,0	115,0	65,0
SDF0302155	15,5	16,0	115,0	65,0
SDF0302158	15,8	16,0	115,0	65,0
*SDF0302160	16,0	16,0	115,0	65,0
SDF0302165	16,5	18,0	123,0	73,0
SDF0302170	17,0	18,0	123,0	73,0
SDF0302175	17,5	18,0	123,0	73,0
*SDF0302180	18,0	18,0	123,0	73,0
SDF0302185	18,5	20,0	131,0	79,0
SDF0302190	19,0	20,0	131,0	79,0
SDF0302195	19,5	20,0	131,0	79,0
*SDF0302200	20,0	20,0	131,0	79,0

* = COSTRUITI IN TOLLERANZA h7
 * = MADE WITH h7 TOLERANCE
 * = GEBAUT MIT TOLERANZ h7
 * = RÉALISÉS EN TOLÉRANCE h7

MATERIALI - MATERIALS Pag. 1199

Applicazione - Application

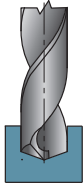

P	M	K	N	S	H	G	(mm)	(m/min)	(mm)	(giri/min)	(mm/min)
							ØD	Vc	fn	n	Vf
●							3÷4	120	0,160	10919	1747
●							4÷5	120	0,160	8493	1359
●							5÷6	120	0,220	6948	1529
●							6÷7	120	0,220	5879	1293
●							7÷8	120	0,220	5096	1121
●							8÷9	120	0,280	4496	1259
●							9÷10	120	0,280	4023	1126
●							10÷12	120	0,280	3474	973
●							12÷14	120	0,340	2940	1000
●							14÷16	120	0,340	2548	866
●							16÷18	120	0,380	2248	854
●							18÷20	120	0,380	2011	764
●							3÷4	110	0,080	10009	801
●							4÷5	110	0,080	7785	623
●							5÷6	110	0,120	6369	764
●							6÷7	110	0,120	5390	647
●							7÷8	110	0,120	4671	561
●							8÷9	110	0,150	4121	618
●							9÷10	110	0,150	3688	553
●							10÷12	110	0,150	3185	478
●							12÷14	110	0,200	2695	539
●							14÷16	110	0,200	2335	467
●							16÷18	110	0,250	2061	515
●							18÷20	110	0,250	1844	461
●							3÷4	70	0,080	6369	510
●							4÷5	70	0,080	4954	396
●							5÷6	70	0,120	4053	486
●							6÷7	70	0,120	3430	412
●							7÷8	70	0,120	2972	357
●							8÷9	70	0,150	2623	393
●							9÷10	70	0,150	2347	352
●							10÷12	70	0,150	2027	304
●							12÷14	70	0,200	1715	343
●							14÷16	70	0,200	1486	297
●							16÷18	70	0,250	1311	328
●							18÷20	70	0,250	1173	293
●							3÷4	45	0,080	4095	328
●							4÷5	45	0,080	3185	255
●							5÷6	45	0,120	2606	313
●							6÷7	45	0,120	2205	265
●							7÷8	45	0,120	1911	229
●							8÷9	45	0,150	1686	253
●							9÷10	45	0,150	1509	226
●							10÷12	45	0,150	1303	195
●							12÷14	45	0,200	1102	220
●							14÷16	45	0,200	955	191
●							16÷18	45	0,250	843	211
●							18÷20	45	0,250	754	189
●		●					3÷4	110	0,125	10009	1251
●		●					4÷5	110	0,125	7785	973
●		●					5÷6	110	0,175	6369	1115
●		●					6÷7	110	0,175	5390	943
●		●					7÷8	110	0,175	4671	817
●		●					8÷9	110	0,225	4121	927
●		●					9÷10	110	0,225	3688	830
●		●					10÷12	110	0,225	3185	717
●		●					12÷14	110	0,300	2695	808
●		●					14÷16	110	0,300	2335	701
●		●					16÷18	110	0,375	2061	773
●		●					18÷20	110	0,375	1844	691
							3÷4	30	0,040	2730	109
							4÷5	30	0,040	2123	85
							5÷6	30	0,080	1737	139
							6÷7	30	0,080	1470	118
							7÷8	30	0,080	1274	102
							8÷9	30	0,120	1124	135
							9÷10	30	0,120	1006	121
							10÷12	30	0,120	869	104
							12÷14	30	0,160	735	118
							14÷16	30	0,160	637	102
							16÷18	30	0,200	562	112
							18÷20	30	0,200	503	101

● APPLICAZIONE CONSIGLIATA-RECOMMENDED APPLICATION
EMPFÖHLENER EINSATZ - APPLICATION CONSEILLÉE

○ APPLICAZIONE POSSIBILE - POSSIBLE APPLICATION
MÖGLICHE ANWENDUNG - APPLICATION POSSIBLE

Vc = m/min VELOCITÀ DI TAGLIO - CUTTING SPEED

n = giri/min (min⁻¹) NUMERO DI GIRI - NUMBER OF REVOLUTIONS

fn = mm AVANZAMENTO AL GIRO - FEED / REVOLUTION

Vf = mm/min VELOCITÀ DI AVANZAMENTO - FEED SPEED

$$n = \frac{Vc \cdot 1000}{\varnothing D \cdot 3,14} = \text{giri/min (min}^{-1}\text{)}$$

$$Vf = fn \cdot n = \text{mm/min}$$

SDR0502

ØD = 3 - 20

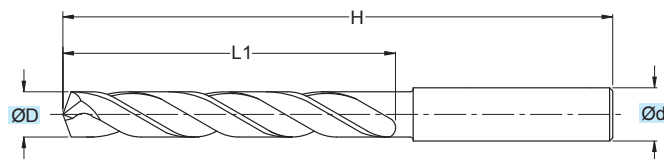

TOLLERANZE	D	d
TOLERANCE RANGE	m7	h6

RIVESTIM.
COATED
TIALN

5xD

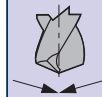
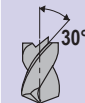

DIN 6535



MG

ART.	(mm)			
	ØD	Ød	H	L1
SDR0502030	3,0	6,0	66,0	28,0
SDR0502031	3,1	6,0	66,0	28,0
SDR0502032	3,2	6,0	66,0	28,0
SDR0502033	3,3	6,0	66,0	28,0
SDR0502034	3,4	6,0	66,0	28,0
SDR0502035	3,5	6,0	66,0	28,0
SDR0502036	3,6	6,0	66,0	28,0
SDR0502037	3,7	6,0	66,0	28,0
SDR0502038	3,8	6,0	74,0	36,0
SDR0502039	3,9	6,0	74,0	36,0
SDR0502040	4,0	6,0	74,0	36,0
SDR0502041	4,1	6,0	74,0	36,0
SDR0502042	4,2	6,0	74,0	36,0
SDR0502043	4,3	6,0	74,0	36,0
SDR0502044	4,4	6,0	74,0	36,0
SDR0502045	4,5	6,0	74,0	36,0
SDR0502046	4,6	6,0	74,0	36,0
SDR05020465 New	4,65	6,0	74,0	36,0
SDR0502047	4,7	6,0	74,0	36,0
SDR0502048	4,8	6,0	82,0	44,0
SDR0502049	4,9	6,0	82,0	44,0
SDR0502050	5,0	6,0	82,0	44,0
SDR0502051	5,1	6,0	82,0	44,0
SDR0502052	5,2	6,0	82,0	44,0
SDR0502053	5,3	6,0	82,0	44,0
SDR0502054	5,4	6,0	82,0	44,0
SDR0502055	5,5	6,0	82,0	44,0
SDR05020555 New	5,55	6,0	82,0	44,0
SDR0502056	5,6	6,0	82,0	44,0
SDR0502057	5,7	6,0	82,0	44,0
SDR0502058	5,8	6,0	82,0	44,0
SDR0502059	5,9	6,0	82,0	44,0
*SDR0502060	6,0	6,0	82,0	44,0
SDR0502061	6,1	8,0	91,0	53,0
SDR0502062	6,2	8,0	91,0	53,0
SDR0502063	6,3	8,0	91,0	53,0
SDR0502064	6,4	8,0	91,0	53,0
SDR0502065	6,5	8,0	91,0	53,0
SDR0502066	6,6	8,0	91,0	53,0
SDR0502067	6,7	8,0	91,0	53,0
SDR0502068	6,8	8,0	91,0	53,0
SDR0502069	6,9	8,0	91,0	53,0
SDR0502070	7,0	8,0	91,0	53,0
SDR0502071	7,1	8,0	91,0	53,0
SDR0502072	7,2	8,0	91,0	53,0

ART.	(mm)			
	ØD	Ød	H	L1
SDR0502073	7,3	8,0	91,0	53,0
SDR0502074	7,4	8,0	91,0	53,0
SDR0502075	7,5	8,0	91,0	53,0
SDR0502076	7,6	8,0	91,0	53,0
SDR0502077	7,7	8,0	91,0	53,0
SDR0502078	7,8	8,0	91,0	53,0
SDR0502079	7,9	8,0	91,0	53,0
*SDR0502080	8,0	8,0	91,0	53,0
SDR0502081	8,1	10,0	103,0	61,0
SDR0502082	8,2	10,0	103,0	61,0
SDR0502083	8,3	10,0	103,0	61,0
SDR0502084	8,4	10,0	103,0	61,0
SDR0502085	8,5	10,0	103,0	61,0
SDR0502086	8,6	10,0	103,0	61,0
SDR0502087	8,7	10,0	103,0	61,0
SDR0502088	8,8	10,0	103,0	61,0
SDR0502089	8,9	10,0	103,0	61,0
SDR0502090	9,0	10,0	103,0	61,0
SDR0502091	9,1	10,0	103,0	61,0
SDR0502092	9,2	10,0	103,0	61,0
SDR0502093	9,3	10,0	103,0	61,0
SDR0502094	9,4	10,0	103,0	61,0
SDR0502095	9,5	10,0	103,0	61,0
SDR0502096	9,6	10,0	103,0	61,0
SDR0502097	9,7	10,0	103,0	61,0
SDR0502098	9,8	10,0	103,0	61,0
SDR0502099	9,9	10,0	103,0	61,0
*SDR0502100	10,0	10,0	103,0	61,0
SDR0502102	10,2	12,0	118,0	71,0
SDR0502105	10,5	12,0	118,0	71,0
SDR0502108	10,8	12,0	118,0	71,0
SDR0502110	11,0	12,0	118,0	71,0
SDR0502112	11,2	12,0	118,0	71,0
SDR0502115	11,5	12,0	118,0	71,0
SDR0502118	11,8	12,0	118,0	71,0
*SDR0502120	12,0	12,0	118,0	71,0
SDR0502122	12,2	14,0	124,0	77,0
SDR0502125	12,5	14,0	124,0	77,0
SDR0502128	12,8	14,0	124,0	77,0
SDR0502130	13,0	14,0	124,0	77,0
SDR0502131 New	13,1	14,0	124,0	77,0
SDR0502132	13,2	14,0	124,0	77,0
SDR0502135	13,5	14,0	124,0	77,0
SDR0502138	13,8	14,0	124,0	77,0
*SDR0502140	14,0	14,0	124,0	77,0

ART.	(mm)			
	ØD	Ød	H	L1
SDR0502142	14,2	16,0	133,0	83,0
SDR0502145	14,5	16,0	133,0	83,0
SDR0502148	14,8	16,0	133,0	83,0
SDR0502150	15,0	16,0	133,0	83,0
SDR0502151 New	15,1	16,0	133,0	83,0
SDR0502152	15,2	16,0	133,0	83,0
SDR0502155	15,5	16,0	133,0	83,0
SDR0502158	15,8	16,0	133,0	83,0
*SDR0502160	16,0	16,0	133,0	83,0
SDR0502165	16,5	18,0	143,0	93,0
SDR0502170	17,0	18,0	143,0	93,0
SDR0502175	17,5	18,0	143,0	93,0
*SDR0502180	18,0	18,0	143,0	93,0
SDR0502185	18,5	20,0	153,0	101,0
SDR0502190	19,0	20,0	153,0	101,0
SDR0502195	19,5	20,0	153,0	101,0
*SDR0502200	20,0	20,0	153,0	101,0

* = COSTRUITI IN TOLLERANZA h7
 * = MADE WITH h7 TOLERANCE
 * = GEBAUT MIT TOLERANZ h7
 * = RÉALISÉS EN TOLÉRANCE h7

MATERIALI - MATERIALS Pag. 1199

Applicazione - Application

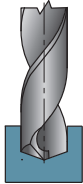

Applicazione - Application	MATERIALI - MATERIALS											ØD	Vc	fn	n (giri/min) (min ⁻¹)	Vf (mm/min)				
	P		M		K		N		S		H						G			
	ACCIAIO NON LEGATO NOT ALLOY STEEL	ACCIAIO POCO LEGATO LOW ALLOY STEEL	ACCIAIO ALTO LEGATO ALLOY STEEL	INOX MARTENSITICO STAINLESS STEEL MART.	INOX AUST. DUPLEX STAINLESS STEEL AUST.	GHISA GRIGIA GREY CAST IRON	GHISA SFEROIDALE SPHEROIDAL GRAPHITE	GHISA MALLEABILE MALLEABLE CAST IRON	ALLUMINIO E SUE LEGHE ALUMINIUM	RAMME E SUE LEGHE COPPER	NON METALLICI PLASTICS						LEGHE RESIST. CALORE HIGH TEMP. ALLOY	TITANIO E SUE LEGHE TITANIUM	ACCIAIO TEMPRATO HARDENED STEEL	GRAFITE GRAPHITE
●																3÷4	90	0,035	8189	287
●																4÷5	90	0,045	6369	287
●																5÷6	90	0,060	5211	313
●																6÷7	90	0,070	4410	309
●																7÷8	90	0,080	3822	306
●																8÷9	90	0,100	3372	337
●																9÷10	90	0,110	3017	332
●																10÷12	90	0,120	2606	313
●																12÷14	90	0,130	2205	287
●																14÷16	90	0,165	1911	315
●																16÷18	90	0,190	1686	320
●																18÷20	90	0,210	1509	317
●																3÷4	80	0,035	7279	255
●																4÷5	80	0,045	5662	255
●																5÷6	80	0,060	4632	278
●																6÷7	80	0,070	3920	274
●																7÷8	80	0,080	3397	272
●																8÷9	80	0,100	2997	300
●																9÷10	80	0,110	2682	295
●																10÷12	80	0,120	2316	278
●																12÷14	80	0,130	1960	255
●																14÷16	80	0,165	1699	280
●																16÷18	80	0,190	1499	285
●																18÷20	80	0,210	1341	282
○																3÷4	40	0,080	3640	291
○																4÷5	40	0,080	2831	226
○																5÷6	40	0,120	2316	278
○																6÷7	40	0,120	1960	235
○																7÷8	40	0,120	1699	204
○																8÷9	40	0,150	1499	225
○																9÷10	40	0,150	1341	201
○																10÷12	40	0,150	1158	174
○																12÷14	40	0,200	980	196
○																14÷16	40	0,200	849	170
○																16÷18	40	0,250	749	187
○																18÷20	40	0,250	670	168
○																3÷4	110	0,090	10009	901
○																4÷5	110	0,120	7785	934
○																5÷6	110	0,150	6369	955
○																6÷7	110	0,170	5390	916
○																7÷8	110	0,190	4671	887
○																8÷9	110	0,210	4121	865
○																9÷10	110	0,230	3688	848
○																10÷12	110	0,260	3185	828
○																12÷14	110	0,300	2695	808
○																14÷16	110	0,340	2335	794
○																16÷18	110	0,370	2061	762
○																18÷20	110	0,410	1844	756
○																3÷4	90	0,090	8189	737
○																4÷5	90	0,120	6369	764
○																5÷6	90	0,150	5211	782
○																6÷7	90	0,170	4410	750
○																7÷8	90	0,190	3822	726
○																8÷9	90	0,210	3372	708
○																9÷10	90	0,230	3017	694
○																10÷12	90	0,260	2606	677
○																12÷14	90	0,300	2205	661
○																14÷16	90	0,340	1911	650
○																16÷18	90	0,370	1686	624
○																18÷20	90	0,410	1509	619

● APPLICAZIONE CONSIGLIATA-RECOMMENDED APPLICATION
EMPFÖHLENER EINSATZ - APPLICATION CONSEILLÉE

○ APPLICAZIONE POSSIBILE - POSSIBLE APPLICATION
MÖGLICHE ANWENDUNG - APPLICATION POSSIBLE

Vc = m/min VELOCITÀ DI TAGLIO - CUTTING SPEED

n = giri/min (min⁻¹) NUMERO DI GIRI - NUMBER OF REVOLUTIONS

fn = mm AVANZAMENTO AL GIRO - FEED / REVOLUTION

Vf = mm/min VELOCITÀ DI AVANZAMENTO - FEED SPEED

$$n = \frac{Vc \cdot 1000}{\text{ØD} \cdot 3,14} = \text{giri/min (min}^{-1}\text{)}$$

$$Vf = fn \cdot n = \text{mm/min}$$

SDF0502

ØD = 3 - 20

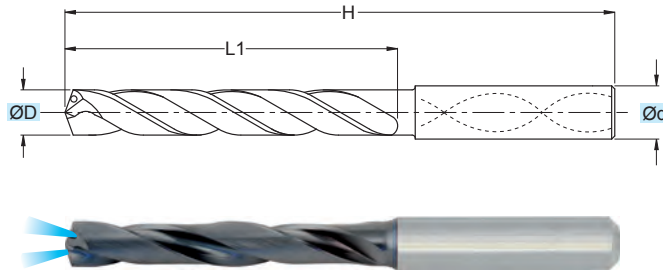

RIVESTIM. COATED TIALN	5xD
	DIN 6535
	MG

- * = COSTRUITI IN TOLLERANZA h7
- * = MADE WITH h7 TOLERANCE
- * = GEBAUT MIT TOLERANZ h7
- * = RÉALISÉS EN TOLÉRANCE h7

TOLLERANZE TOLERANCE RANGE	D	d
	m7	h6

ART.	(mm)			
	ØD	Ød	H	L1
SDF0502030	3,0	6	66	28
SDF0502031	3,1	6	66	28
SDF0502032	3,2	6	66	28
SDF0502033	3,3	6	66	28
SDF0502034	3,4	6	66	28
SDF0502035	3,5	6	66	28
SDF0502036	3,6	6	66	28
SDF0502037	3,7	6	66	28
SDF0502038	3,8	6	74	36
SDF0502039	3,9	6	74	36
SDF0502040	4,0	6	74	36
SDF0502041	4,1	6	74	36
SDF0502042	4,2	6	74	36
SDF0502043	4,3	6	74	36
SDF0502044	4,4	6	74	36
SDF0502045	4,5	6	74	36
SDF0502046	4,6	6	74	36
SDF05020465 New	4,65	6	74	36
SDF0502047	4,7	6	74	36
SDF0502048	4,8	6	82	44
SDF0502049	4,9	6	82	44
SDF0502050	5,0	6	82	44
SDF0502051	5,1	6	82	44
SDF0502052	5,2	6	82	44
SDF0502053	5,3	6	82	44
SDF0502054	5,4	6	82	44
SDF0502055	5,5	6	82	44
SDF05020555 New	5,55	6	82	44
SDF0502056	5,6	6	82	44
SDF0502057	5,7	6	82	44
SDF0502058	5,8	6	82	44
SDF0502059	5,9	6	82	44
*SDF0502060	6,0	6	82	44
SDF0502061	6,1	8	91	53
SDF0502062	6,2	8	91	53
SDF0502063	6,3	8	91	53
SDF0502064	6,4	8	91	53
SDF0502065	6,5	8	91	53
SDF0502066	6,6	8	91	53
SDF0502067	6,7	8	91	53
SDF0502068	6,8	8	91	53
SDF0502069	6,9	8	91	53
SDF0502070	7,0	8	91	53
SDF0502071	7,1	8	91	53
SDF0502072	7,2	8	91	53
SDF0502073	7,3	8	91	53
SDF0502074	7,4	8	91	53
SDF0502075	7,5	8	91	53
SDF0502076	7,6	8	91	53

ART.	(mm)			
	ØD	Ød	H	L1
SDF0502077	7,7	8	91	53
SDF0502078	7,8	8	91	53
SDF0502079	7,9	8	91	53
*SDF0502080	8,0	8	91	53
SDF0502081	8,1	10	103	61
SDF0502082	8,2	10	103	61
SDF0502083	8,3	10	103	61
SDF0502084	8,4	10	103	61
SDF0502085	8,5	10	103	61
SDF0502086	8,6	10	103	61
SDF0502087	8,7	10	103	61
SDF0502088	8,8	10	103	61
SDF0502089	8,9	10	103	61
SDF0502090	9,0	10	103	61
SDF0502091	9,1	10	103	61
SDF0502092	9,2	10	103	61
SDF0502093	9,3	10	103	61
SDF0502094	9,4	10	103	61
SDF0502095	9,5	10	103	61
SDF0502096	9,6	10	103	61
SDF0502097	9,7	10	103	61
SDF0502098	9,8	10	103	61
SDF0502099	9,9	10	103	61
*SDF0502100	10,0	10	103	61
SDF0502101	10,1	12	118	71
SDF0502102	10,2	12	118	71
SDF0502103	10,3	12	118	71
SDF0502104	10,4	12	118	71
SDF0502105	10,5	12	118	71
SDF0502106	10,6	12	118	71
SDF0502107	10,7	12	118	71
SDF0502108	10,8	12	118	71
SDF0502109	10,9	12	118	71
SDF0502110	11,0	12	118	71
SDF0502111	11,1	12	118	71
SDF0502112	11,2	12	118	71
SDF0502113	11,3	12	118	71
SDF0502114	11,4	12	118	71
SDF0502115	11,5	12	118	71
SDF0502116	11,6	12	118	71
SDF0502117	11,7	12	118	71
SDF0502118	11,8	12	118	71
SDF0502119	11,9	12	118	71
*SDF0502120	12,0	12	118	71
SDF0502121	12,1	14	124	77
SDF0502122	12,2	14	124	77
SDF0502123	12,3	14	124	77
SDF0502124	12,4	14	124	77
SDF0502125	12,5	14	124	77

ART.	(mm)			
	ØD	Ød	H	L1
SDF0502126	12,6	14	124	77
SDF0502127	12,7	14	124	77
SDF0502128	12,8	14	124	77
SDF0502129	12,9	14	124	77
SDF0502130	13,0	14	124	77
SDF0502131	13,1	14	124	77
SDF0502132	13,2	14	124	77
SDF0502133	13,3	14	124	77
SDF0502134	13,4	14	124	77
SDF0502135	13,5	14	124	77
SDF0502136	13,6	14	124	77
SDF0502137	13,7	14	124	77
SDF0502138	13,8	14	124	77
SDF0502139	13,9	14	124	77
*SDF0502140	14,0	14	124	77
SDF0502141	14,1	16	133	83
SDF0502142	14,2	16	133	83
SDF0502143	14,3	16	133	83
SDF0502144	14,4	16	133	83
SDF0502145	14,5	16	133	83
SDF0502146	14,6	16	133	83
SDF0502147	14,7	16	133	83
SDF0502148	14,8	16	133	83
SDF0502149	14,9	16	133	83
SDF0502150	15,0	16	133	83
SDF0502151	15,1	16	133	83
SDF0502152	15,2	16	133	83
SDF0502153	15,3	16	133	83
SDF0502154	15,4	16	133	83
SDF0502155	15,5	16	133	83
SDF0502156	15,6	16	133	83
SDF0502157	15,7	16	133	83
SDF0502158	15,8	16	133	83
SDF0502159	15,9	16	133	83
*SDF0502160	16,0	16	133	83
SDF0502165	16,5	18	143	93
SDF0502168 New	16,8	18	143	93
SDF0502170	17,0	18	143	93
SDF0502175	17,5	18	143	93
SDF0502178 New	17,8	18	143	93
*SDF0502180	18,0	18	143	93
SDF0502185	18,5	20	153	101
SDF0502188 New	18,8	20	153	101
SDF0502190	19,0	20	153	101
SDF0502195	19,5	20	153	101
SDF0502198 New	19,8	20	153	101
*SDF0502200	20,0	20	153	101

MATERIALI - MATERIALS Pag. 1199

Applicazione - Application

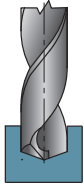

P	M	K	N	S	H	G	(mm)	(m/min)	(mm)	(giri/min)	(mm/min)
							ØD	Vc	fn	n	Vf
●							3÷4	120	0,160	10919	1747
●							4÷5	120	0,160	8493	1359
●							5÷6	120	0,220	6948	1529
●							6÷7	120	0,220	5879	1293
●							7÷8	120	0,220	5096	1121
●							8÷9	120	0,280	4496	1259
●							9÷10	120	0,280	4023	1126
●							10÷12	120	0,280	3474	973
●							12÷14	120	0,340	2940	1000
●							14÷16	120	0,340	2548	866
●							16÷18	120	0,380	2248	854
●							18÷20	120	0,380	2011	764
●							3÷4	110	0,080	10009	801
●							4÷5	110	0,080	7785	623
●							5÷6	110	0,120	6369	764
●							6÷7	110	0,120	5390	647
●							7÷8	110	0,120	4671	561
●							8÷9	110	0,150	4121	618
●							9÷10	110	0,150	3688	553
●							10÷12	110	0,150	3185	478
●							12÷14	110	0,200	2695	539
●							14÷16	110	0,200	2335	467
●							16÷18	110	0,250	2061	515
●							18÷20	110	0,250	1844	461
●							3÷4	70	0,080	6369	510
●							4÷5	70	0,080	4954	396
●							5÷6	70	0,120	4053	486
●							6÷7	70	0,120	3430	412
●							7÷8	70	0,120	2972	357
●							8÷9	70	0,150	2623	393
●							9÷10	70	0,150	2347	352
●							10÷12	70	0,150	2027	304
●							12÷14	70	0,200	1715	343
●							14÷16	70	0,200	1486	297
●							16÷18	70	0,250	1311	328
●							18÷20	70	0,250	1173	293
○							3÷4	45	0,080	4095	328
○							4÷5	45	0,080	3185	255
○							5÷6	45	0,120	2606	313
○							6÷7	45	0,120	2205	265
○							7÷8	45	0,120	1911	229
○							8÷9	45	0,150	1686	253
○							9÷10	45	0,150	1509	226
○							10÷12	45	0,150	1303	195
○							12÷14	45	0,200	1102	220
○							14÷16	45	0,200	955	191
○							16÷18	45	0,250	843	211
○							18÷20	45	0,250	754	189
○		○					3÷4	110	0,125	10009	1251
○		○					4÷5	110	0,125	7785	973
○		○					5÷6	110	0,175	6369	1115
○		○					6÷7	110	0,175	5390	943
○		○					7÷8	110	0,175	4671	817
○		○					8÷9	110	0,225	4121	927
○		○					9÷10	110	0,225	3688	830
○		○					10÷12	110	0,225	3185	717
○		○					12÷14	110	0,300	2695	808
○		○					14÷16	110	0,300	2335	701
○		○					16÷18	110	0,375	2061	773
○		○					18÷20	110	0,375	1844	691
○					○		3÷4	30	0,040	2730	109
○					○		4÷5	30	0,040	2123	85
○					○		5÷6	30	0,080	1737	139
○					○		6÷7	30	0,080	1470	118
○					○		7÷8	30	0,080	1274	102
○					○		8÷9	30	0,120	1124	135
○					○		9÷10	30	0,120	1006	121
○					○		10÷12	30	0,120	869	104
○					○		12÷14	30	0,160	735	118
○					○		14÷16	30	0,160	637	102
○					○		16÷18	30	0,200	562	112
○					○		18÷20	30	0,200	503	101

● APPLICAZIONE CONSIGLIATA-RECOMMENDED APPLICATION
EMPFÖHLENER EINSATZ - APPLICATION CONSEILLÉE

○ APPLICAZIONE POSSIBILE - POSSIBLE APPLICATION
MÖGLICHE ANWENDUNG - APPLICATION POSSIBLE

Vc = m/min VELOCITÀ DI TAGLIO - CUTTING SPEED

n = giri/min (min⁻¹) NUMERO DI GIRI - NUMBER OF REVOLUTIONS

fn = mm AVANZAMENTO AL GIRO - FEED / REVOLUTION

Vf = mm/min VELOCITÀ DI AVANZAMENTO - FEED SPEED

$$n = \frac{Vc \cdot 1000}{\varnothing D \cdot 3,14} = \text{giri/min (min}^{-1}\text{)}$$

$$Vf = fn \cdot n = \text{mm/min}$$

SDF0802

ØD = 3 - 16

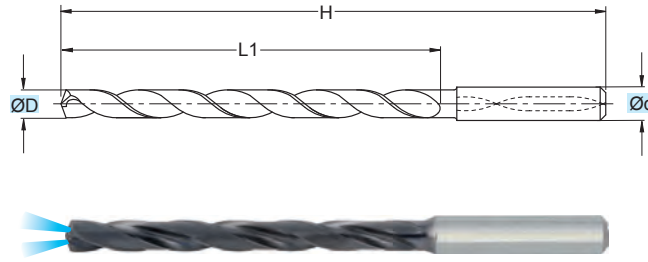
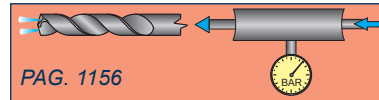

TOLLERANZE	D	d
TOLERANCE RANGE	m7	h6

RIVESTIM. COATED TIALN	8xD
	DIN 6535
	MG

ART.	(mm)			
	ØD	Ød	H	L1
SDF0802030	3,0	6	74	34
SDF0802031	3,1	6	74	34
SDF0802032	3,2	6	74	34
SDF0802033	3,3	6	74	34
SDF0802034	3,4	6	74	34
SDF0802035	3,5	6	74	34
SDF0802036	3,6	6	74	34
SDF0802037	3,7	6	74	34
SDF0802038	3,8	6	85	45
SDF0802039	3,9	6	85	45
SDF0802040	4,0	6	85	45
SDF0802041	4,1	6	85	45
SDF0802042	4,2	6	85	45
SDF0802043	4,3	6	85	45
SDF0802044	4,4	6	85	45
SDF0802045	4,5	6	85	45
SDF0802046	4,6	6	85	45
SDF0802047	4,7	6	85	45
SDF0802048	4,8	6	97	57
SDF0802049	4,9	6	97	57
SDF0802050	5,0	6	97	57
SDF0802051	5,1	6	97	57
SDF0802052	5,2	6	97	57
SDF0802053	5,3	6	97	57
SDF0802054	5,4	6	97	57
SDF0802055	5,5	6	97	57
SDF0802056	5,6	6	97	57
SDF0802057	5,7	6	97	57
SDF0802058	5,8	6	97	57
SDF0802059	5,9	6	97	57
*SDF0802060	6,0	6	97	57
SDF0802061	6,1	8	106	66
SDF0802062	6,2	8	106	66
SDF0802063	6,3	8	106	66
SDF0802064	6,4	8	106	66
SDF0802065	6,5	8	106	66
SDF0802066	6,6	8	106	66
SDF0802067	6,7	8	106	66
SDF0802068	6,8	8	106	66
SDF0802069	6,9	8	106	66
SDF0802070	7,0	8	106	66
SDF0802071	7,1	8	116	76
SDF0802072	7,2	8	116	76
SDF0802073	7,3	8	116	76
SDF0802074	7,4	8	116	76

ART.	(mm)			
	ØD	Ød	H	L1
SDF0802075	7,5	8	116	76
SDF0802076	7,6	8	116	76
SDF0802077	7,7	8	116	76
SDF0802078	7,8	8	116	76
SDF0802079	7,9	8	116	76
*SDF0802080	8,0	8	116	76
SDF0802081	8,1	10	139	95
SDF0802082	8,2	10	139	95
SDF0802083	8,3	10	139	95
SDF0802084	8,4	10	139	95
SDF0802085	8,5	10	139	95
SDF0802086	8,6	10	139	95
SDF0802087	8,7	10	139	95
SDF0802088	8,8	10	139	95
SDF0802089	8,9	10	139	95
SDF0802090	9,0	10	139	95
SDF0802091	9,1	10	139	95
SDF0802092	9,2	10	139	95
SDF0802093	9,3	10	139	95
SDF0802094	9,4	10	139	95
SDF0802095	9,5	10	139	95
SDF0802096	9,6	10	139	95
SDF0802097	9,7	10	139	95
SDF0802098	9,8	10	139	95
SDF0802099	9,9	10	139	95
*SDF0802100	10,0	10	139	95
SDF0802101	10,1	12	163	114
SDF0802102	10,2	12	163	114
SDF0802103	10,3	12	163	114
SDF0802104	10,4	12	163	114
SDF0802105	10,5	12	163	114
SDF0802106	10,6	12	163	114
SDF0802107	10,7	12	163	114
SDF0802108	10,8	12	163	114
SDF0802109	10,9	12	163	114
SDF0802110	11,0	12	163	114
SDF0802111	11,1	12	163	114
SDF0802112	11,2	12	163	114
SDF0802113	11,3	12	163	114
SDF0802114	11,4	12	163	114
SDF0802115	11,5	12	163	114
SDF0802116	11,6	12	163	114
SDF0802117	11,7	12	163	114
SDF0802118	11,8	12	163	114
SDF0802119	11,9	12	163	114

ART.	(mm)			
	ØD	Ød	H	L1
*SDF0802120	12,0	12	163	114
SDF0802125	12,5	14	182	133
SDF0802128	12,8	14	182	133
SDF0802130	13,0	14	182	133
SDF0802135	13,5	14	182	133
SDF0802138	13,8	14	182	133
*SDF0802140	14,0	14	182	133
SDF0802145	14,5	16	204	152
SDF0802148	14,8	16	204	152
SDF0802150	15,0	16	204	152
SDF0802155	15,5	16	204	152
SDF0802158	15,8	16	204	152
*SDF0802160	16,0	16	204	152

* = COSTRUITI IN TOLLERANZA h7
 * = MADE WITH h7 TOLERANCE
 * = GEBAUT MIT TOLERANZ h7
 * = RÉALISÉS EN TOLÉRANCE h7

MATERIALI - MATERIALS Pag. 1199

Applicazione - Application

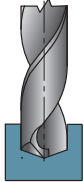

	MATERIALI - MATERIALS										ØD	Vc	fn	n	Vf					
	P	M	K			N			S	H						G				
	ACCIAIO NON LEGATO NOT ALLOY STEEL	ACCIAIO POCO LEGATO LOW ALLOY STEEL	ACCIAIO ALTO LEGATO ALLOY STEEL	INOX MARTENSITICO STAINLESS STEEL MART.	INOX AUST. DUPLEX STAINLESS STEEL AUST.	GHISA GRIGIA GREY CAST IRON	GHISA SFEROIDALE SPHEROIDAL GRAPHITE	GHISA MALLEABILE MALLEABLE CAST IRON	ALLUMINIO E SUE LEGHE ALUMINIUM	RAME E SUE LEGHE COPPER	NON METALLICI PLASTICS	LEGHE RESIST. CALORE HIGH TEMP. ALLOY	TITANIO E SUE LEGHE TITANIUM	ACCIAIO TEMPRATO HARDENED STEEL	GRAFITE GRAPHITE					
●																3÷4	85	0,050	7734	387
●																4÷5	85	0,080	6016	481
●																5÷6	85	0,110	4922	541
●																6÷7	85	0,130	4165	541
●																7÷8	85	0,150	3609	541
●																8÷9	85	0,170	3185	541
●																9÷10	85	0,190	2849	541
●																10÷11	85	0,200	2707	541
●																11÷12	85	0,210	2461	517
●																12÷13	85	0,220	2256	496
●																13÷14	85	0,230	2082	479
●																14÷15	85	0,240	1934	464
●																15÷16	85	0,250	1805	451
○																3÷4	75	0,035	6824	239
○																4÷5	75	0,045	5308	239
○																5÷6	75	0,060	4343	261
○																6÷7	75	0,075	3675	276
○																7÷8	75	0,085	3185	271
○																8÷9	75	0,095	2810	267
○																9÷10	75	0,105	2514	264
○																10÷11	75	0,110	2275	250
○																11÷12	75	0,115	2077	239
○																12÷13	75	0,120	1911	229
○																13÷14	75	0,130	1769	230
○																14÷15	75	0,140	1647	231
○																15÷16	75	0,150	1541	231
○			●													3÷4	55	0,035	5005	175
○			●													4÷5	55	0,045	3892	175
○			●													5÷6	55	0,060	3185	191
○			●													6÷7	55	0,075	2695	202
○			●													7÷8	55	0,085	2335	199
○			●													8÷9	55	0,095	2061	196
○			●													9÷10	55	0,105	1844	194
○			●													10÷11	55	0,110	1668	184
○			●													11÷12	55	0,115	1523	175
○			●													12÷13	55	0,120	1401	168
○			●													13÷14	55	0,130	1297	169
○			●													14÷15	55	0,140	1208	169
○			●													15÷16	55	0,150	1130	170
○				●												3÷4	50	0,035	4550	159
○				●												4÷5	50	0,045	3539	159
○				●												5÷6	50	0,060	2895	174
○				●												6÷7	50	0,075	2450	184
○				●												7÷8	50	0,085	2123	180
○				●												8÷9	50	0,095	1873	178
○				●												9÷10	50	0,105	1676	176
○				●												10÷11	50	0,110	1517	167
○				●												11÷12	50	0,115	1385	159
○				●												12÷13	50	0,120	1274	153
○				●												13÷14	50	0,120	1180	142
○				●												14÷15	50	0,125	1098	137
○				●												15÷16	50	0,125	1027	128
○					●											3÷4	80	0,075	7279	546
○					●											4÷5	80	0,100	5662	566
○					●											5÷6	80	0,130	4632	602
○					●											6÷7	80	0,150	3920	588
○					●											7÷8	80	0,170	3397	577
○					●											8÷9	80	0,190	2997	570
○					●											9÷10	80	0,215	2682	577
○					●											10÷11	80	0,230	2548	586
○					●											11÷12	80	0,255	2316	591
○					●											12÷13	80	0,280	2123	594
○					●											13÷14	80	0,290	1960	568
○					●											14÷15	80	0,300	1820	546
○					●											15÷16	80	0,310	1699	527

● APPLICAZIONE CONSIGLIATA-RECOMMENDED APPLICATION
EMPFOHLENER EINSATZ - APPLICATION CONSEILLÉE

○ APPLICAZIONE POSSIBILE - POSSIBLE APPLICATION
MÖGLICHE ANWENDUNG - APPLICATION POSSIBLE

Vc = m/min VELOCITÀ DI TAGLIO - CUTTING SPEED

n = giri/min (min⁻¹) NUMERO DI GIRI - NUMBER OF REVOLUTIONS

fn = mm AVANZAMENTO AL GIRO - FEED / REVOLUTION

Vf = mm/min VELOCITÀ DI AVANZAMENTO - FEED SPEED

$$n = \frac{Vc \cdot 1000}{\text{ØD} \cdot 3,14} = \text{giri/min (min}^{-1}\text{)}$$

$$Vf = fn \cdot n = \text{mm/min}$$

SDF1201

ØD = 3 - 16

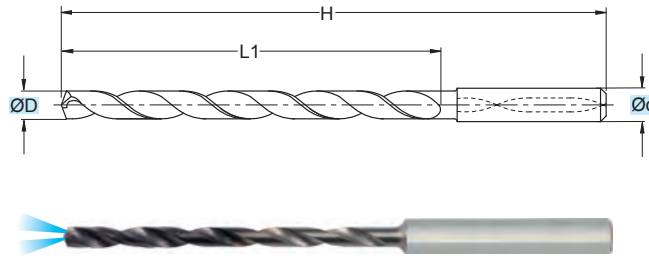
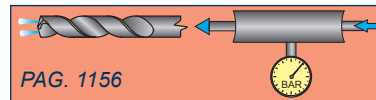

TOLLERANZE	D	d
TOLERANCE RANGE	h7	h6

RIVESTIM. COATED
TIALN **12xD**

DIN 6535

MG

ART.	(mm)			
	ØD	Ød	H	L1
SDF1201030	3,0	6	92	54
SDF1201031	3,1	6	92	54
SDF1201032	3,2	6	92	54
SDF1201033	3,3	6	92	54
SDF1201034	3,4	6	92	54
SDF1201035	3,5	6	92	54
SDF1201036	3,6	6	92	54
SDF1201037	3,7	6	92	54
SDF1201038	3,8	6	102	64
SDF1201039	3,9	6	102	64
SDF1201040	4,0	6	102	64
SDF1201041	4,1	6	102	64
SDF1201042	4,2	6	102	64
SDF1201043	4,3	6	102	64
SDF1201044	4,4	6	102	64
SDF1201045	4,5	6	102	64
SDF1201046	4,6	6	102	64
SDF1201047	4,7	6	102	64
SDF1201048	4,8	6	116	78
SDF1201049	4,9	6	116	78
SDF1201050	5,0	6	116	78
SDF1201051	5,1	6	116	78
SDF1201052	5,2	6	116	78
SDF1201053	5,3	6	116	78
SDF1201054	5,4	6	116	78
SDF1201055	5,5	6	116	78
SDF1201056	5,6	6	116	78
SDF1201057	5,7	6	116	78
SDF1201058	5,8	6	116	78
SDF1201059	5,9	6	116	78
SDF1201060	6,0	6	116	78
SDF1201061	6,1	8	146	108
SDF1201062	6,2	8	146	108
SDF1201063	6,3	8	146	108
SDF1201064	6,4	8	146	108
SDF1201065	6,5	8	146	108
SDF1201066	6,6	8	146	108
SDF1201067	6,7	8	146	108
SDF1201068	6,8	8	146	108
SDF1201069	6,9	8	146	108
SDF1201070	7,0	8	146	108
SDF1201071	7,1	8	146	108
SDF1201072	7,2	8	146	108
SDF1201073	7,3	8	146	108
SDF1201074	7,4	8	146	108

ART.	(mm)			
	ØD	Ød	H	L1
SDF1201075	7,5	8	146	108
SDF1201076	7,6	8	146	108
SDF1201077	7,7	8	146	108
SDF1201078	7,8	8	146	108
SDF1201079	7,9	8	146	108
SDF1201080	8,0	8	146	108
SDF1201081	8,1	10	162	120
SDF1201082	8,2	10	162	120
SDF1201083	8,3	10	162	120
SDF1201084	8,4	10	162	120
SDF1201085	8,5	10	162	120
SDF1201086	8,6	10	162	120
SDF1201087	8,7	10	162	120
SDF1201088	8,8	10	162	120
SDF1201089	8,9	10	162	120
SDF1201090	9,0	10	162	120
SDF1201091	9,1	10	162	120
SDF1201092	9,2	10	162	120
SDF1201093	9,3	10	162	120
SDF1201094	9,4	10	162	120
SDF1201095	9,5	10	162	120
SDF1201096	9,6	10	162	120
SDF1201097	9,7	10	162	120
SDF1201098	9,8	10	162	120
SDF1201099	9,9	10	162	120
SDF1201100	10,0	10	162	120
SDF1201101	10,1	12	204	156
SDF1201102	10,2	12	204	156
SDF1201103	10,3	12	204	156
SDF1201104	10,4	12	204	156
SDF1201105	10,5	12	204	156
SDF1201106	10,6	12	204	156
SDF1201107	10,7	12	204	156
SDF1201108	10,8	12	204	156
SDF1201109	10,9	12	204	156
SDF1201110	11,0	12	204	156
SDF1201111	11,1	12	204	156
SDF1201112	11,2	12	204	156
SDF1201113	11,3	12	204	156
SDF1201114	11,4	12	204	156
SDF1201115	11,5	12	204	156
SDF1201116	11,6	12	204	156
SDF1201117	11,7	12	204	156
SDF1201118	11,8	12	204	156
SDF1201119	11,9	12	204	156

ART.	(mm)			
	ØD	Ød	H	L1
SDF1201120	12,0	12	204	156
SDF1201125	12,5	14	230	182
SDF1201128	12,8	14	230	182
SDF1201130	13,0	14	230	182
SDF1201135	13,5	14	230	182
SDF1201138	13,8	14	230	182
SDF1201140	14,0	14	230	182
SDF1201145	14,5	16	260	208
SDF1201148	14,8	16	260	208
SDF1201150	15,0	16	260	208
SDF1201155	15,5	16	260	208
SDF1201158	15,8	16	260	208
SDF1201160	16,0	16	260	208

!

IT -PRIMA DELL'UTILIZZO DELLA PUNTA LEGGERE GLI ACCORGIMENTI DI PAG 1159 -PER ESEGUIRE IL PREFORO UTILIZZARE ART. SDF0371 PAG 616

EN -BEFORE USING THE DRILL READ THE TIPS ON PAGE 1159 -USE ART. SDF0371 PAGE 616 TO MAKE THE PRE-BORE

DE -VOR DEM GEBRAUCH SIEHE DIE HINWEISE AUF SEITE 1159 -ZUM VORBOHREN ART. SDF0371, SEITE 616 VERWENDEN

FR -AVANT D'UTILISER LA POINTE, LIRE LES CONSIGNES DE PAGE 1159 -POUR EXECUTER LE PRE-TRou, UTILISER ART. SDF0371 PAGE 616

MATERIALI - MATERIALS Pag. 1199

Applicazione - Application

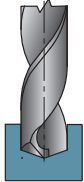

	MATERIALI - MATERIALS										ØD	Vc	fn	n	Vf					
	P	M	K			N			S	H						G				
	ACCIAIO NON LEGATO NOT ALLOY STEEL	ACCIAIO POCO LEGATO LOW ALLOY STEEL	ACCIAIO ALTO LEGATO ALLOY STEEL	INOX MARTENSITICO STAINLESS STEEL MART.	INOX AUST. DUPLEX STAINLESS STEEL AUST.	GHISA GRIGIA GREY CAST IRON	GHISA SFEROIDALE SPHEROIDAL GRAPHITE	GHISA MALLEABILE MALLEABLE CAST IRON	ALLUMINIO E SUE LEGHE ALUMINIUM	RAME E SUE LEGHE COPPER	NON METALLICI PLASTICS	LEGHE RESIST. CALORE HIGH TEMP. ALLOY	TITANIO E SUE LEGHE TITANIUM	ACCIAIO TEMPRATO HARDENED STEEL	GRAFITE GRAPHITE					
●																3÷4	80	0,050	7279	364
●																4÷5	80	0,080	5662	453
●																5÷6	80	0,110	4632	510
●																6÷7	80	0,130	3920	510
●																7÷8	80	0,150	3397	510
●																8÷9	80	0,170	2997	510
●																9÷10	80	0,190	2682	510
●																10÷11	80	0,200	2548	510
●																11÷12	80	0,210	2316	486
●																12÷13	80	0,220	2123	467
●																13÷14	80	0,230	1960	451
●																14÷15	80	0,240	1820	437
●																15÷16	80	0,250	1699	425
○																3÷4	50	0,035	4550	159
○																4÷5	50	0,045	3539	159
○																5÷6	50	0,060	2895	174
○																6÷7	50	0,075	2450	184
○																7÷8	50	0,085	2123	180
○																8÷9	50	0,095	1873	178
○																9÷10	50	0,105	1676	176
○																10÷11	50	0,110	1592	175
○																11÷12	50	0,115	1448	166
○																12÷13	50	0,120	1327	159
○																13÷14	50	0,130	1225	159
○																14÷15	50	0,140	1137	159
○																15÷16	50	0,150	1062	159
○			●													3÷4	30	0,035	2730	96
○			●													4÷5	30	0,045	2123	96
○			●													5÷6	30	0,060	1737	104
○			●													6÷7	30	0,075	1470	110
○			●													7÷8	30	0,085	1274	108
○			●													8÷9	30	0,095	1124	107
○			●													9÷10	30	0,105	1006	106
○			●													10÷11	30	0,110	955	105
○			●													11÷12	30	0,115	869	100
○			●													12÷13	30	0,120	796	96
○			●													13÷14	30	0,130	735	96
○			●													14÷15	30	0,140	682	96
○			●													15÷16	30	0,150	637	96
○				●												3÷4	50	0,035	4550	159
○				●												4÷5	50	0,045	3539	159
○				●												5÷6	50	0,060	2895	174
○				●												6÷7	50	0,075	2450	184
○				●												7÷8	50	0,085	2123	180
○				●												8÷9	50	0,095	1873	178
○				●												9÷10	50	0,105	1676	176
○				●												10÷11	50	0,110	1517	167
○				●												11÷12	50	0,115	1385	159
○				●												12÷13	50	0,120	1274	153
○				●												13÷14	50	0,120	1180	142
○				●												14÷15	50	0,125	1098	137
○				●												15÷16	50	0,125	1027	128
○					●											3÷4	75	0,075	6824	512
○					●											4÷5	75	0,100	5308	531
○					●											5÷6	75	0,130	4343	565
○					●											6÷7	75	0,150	3675	551
○					●											7÷8	75	0,170	3185	541
○					●											8÷9	75	0,190	2810	534
○					●											9÷10	75	0,215	2514	541
○					●											10÷11	75	0,230	2389	549
○					●											11÷12	75	0,255	2171	554
○					●											12÷13	75	0,280	1990	557
○					●											13÷14	75	0,290	1837	533
○					●											14÷15	75	0,300	1706	512
○					●											15÷16	75	0,310	1592	494

● APPLICAZIONE CONSIGLIATA-RECOMMENDED APPLICATION
EMPFOHLENER EINSATZ - APPLICATION CONSEILLÉE

○ APPLICAZIONE POSSIBILE - POSSIBLE APPLICATION
MÖGLICHE ANWENDUNG - APPLICATION POSSIBLE

Vc = m/min VELOCITÀ DI TAGLIO - CUTTING SPEED

n = giri/min (min⁻¹) NUMERO DI GIRI - NUMBER OF REVOLUTIONS

fn = mm AVANZAMENTO AL GIRO - FEED / REVOLUTION

Vf = mm/min VELOCITÀ DI AVANZAMENTO - FEED SPEED

$$n = \frac{Vc \cdot 1000}{\text{ØD} \cdot 3,14} = \text{giri/min (min}^{-1}\text{)}$$

$$Vf = fn \cdot n = \text{mm/min}$$

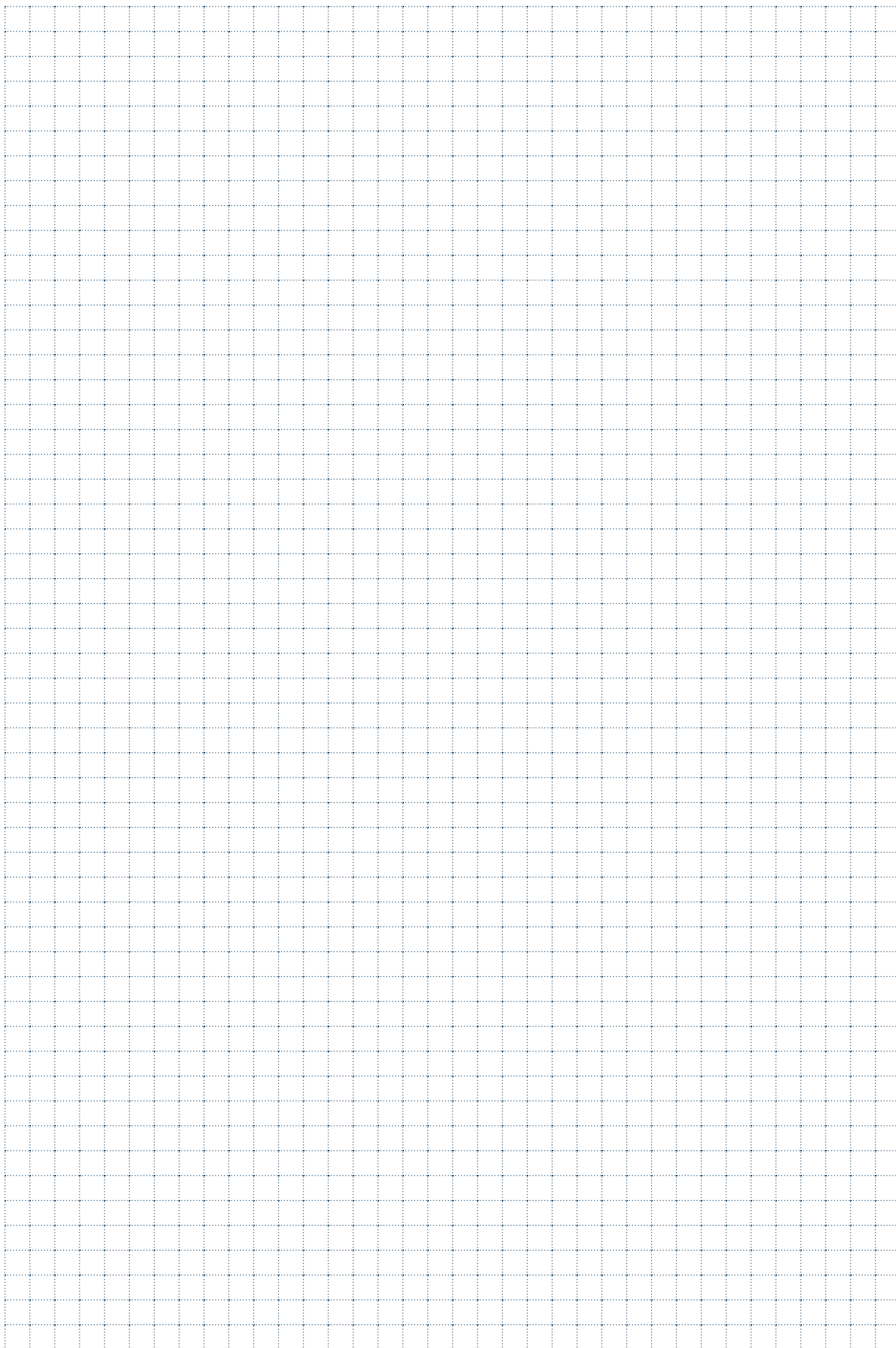



PUNTE A GRADINO

STEP DRILLS / STUFENBOHRER / POINTES A GRADIN /
BROCAS ESCALÓN

SDN0102

GENERICO / ALL PURPOSE

$\varnothing D = 3,4 - 11$

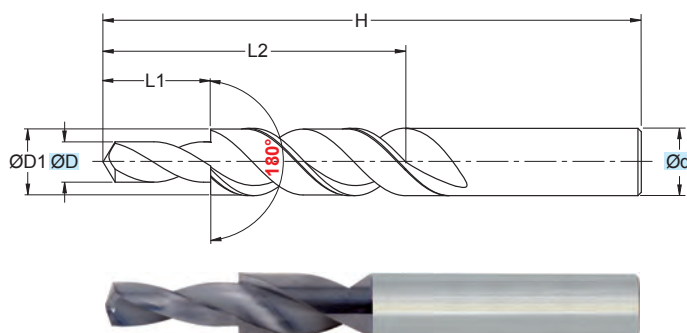

> ANGOLO DI SVASATURA 180°
 > PER ALLOGGIAMENTI TESTE VITI SECONDO DIN
 84-912-6912-7513-7984

> COUNTER SINK 180°
 > SFOR HEAD SCREW DIN 84-912-6912-7513-7984

RIVESTIM.
 COATED
TIALN

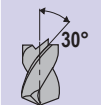

MG

(mm)

ART.	$\varnothing D$	$\varnothing d$	$\varnothing D1$	H	L1	L2
SDN0102030	3,4	6	6	66	9	28
SDN0102040	4,5	8	8	80	11	37
SDN0102050	5,5	10	10	89	13	43
SDN0102060	6,6	12	11	95	15	47
SDN0102080	9,0	16	15	110	19	56
SDN0102100	11,0	18	18	123	23	62

Applicazione - Application		MATERIALI - MATERIALS Pag. 1199																			
		P		M		K			N			S		H	G	ØD (mm)	Vc (m/min)	fn (mm)	n (giri/min) (min ⁻¹)	Vf (mm/min)	
		ACCIAIO NON LEGATO NOT ALLOY STEEL	ACCIAIO POCO LEGATO LOW ALLOY STEEL	ACCIAIO ALTO LEGATO ALLOY STEEL	INOX MARTENSITICO STAINLESS STEEL MART.	INOX AUST. DUPLEX STAINLESS STEEL AUST.	GHISA GRIGIA GREY CAST IRON	GHISA SFEROIDALE SPHEROIDAL GRAPHITE	GHISA MALLEABILE MALLEABLE CAST IRON	ALLUMINIO E SUE LEGHE ALUMINIUM	RAME E SUE LEGHE COPPER	NON METALLICI PLASTICS	LEGHE RESIST. CALORE HIGH TEMP. ALLOY	TITANIO E SUE LEGHE TITANIUM	ACCIAIO TEMPRATO HARDENED STEEL	GRAFITE GRAPHITE					
	●																3,4	80	0,180	7493	1349
	●																4,5	80	0,180	5662	1019
	●																5,5	80	0,240	4632	1112
	●																6,6	80	0,240	3860	926
	●																9,0	80	0,300	2831	849
	●																11,0	80	0,300	2316	695
		●															3,4	50	0,150	4683	703
		●															4,5	50	0,150	3539	531
		●															5,5	50	0,210	2895	608
		●															6,6	50	0,210	2413	507
		●															9,0	50	0,270	1769	478
		●															11,0	50	0,270	1448	391
							●										3,4	75	0,230	7025	1616
							●										4,5	75	0,230	5308	1221
							●										5,5	75	0,335	4343	1455
							●										6,6	75	0,335	3619	1212
							●										9,0	75	0,425	2654	1128
						●										11,0	75	0,425	2171	923	
							●									3,4	75	0,200	7025	1405	
							●									4,5	75	0,200	5308	1062	
							●									5,5	75	0,250	4343	1086	
							●									6,6	75	0,250	3619	905	
							●									9,0	75	0,350	2654	929	
							●									11,0	75	0,350	2171	760	

● APPLICAZIONE CONSIGLIATA-RECOMMENDED APPLICATION
EMPFOLLENER EINSATZ - APPLICATION CONSEILLÉE

○ APPLICAZIONE POSSIBILE - POSSIBLE APPLICATION
MÖGLICHE ANWENDUNG - APPLICATION POSSIBLE

Vc = m/min VELOCITÀ DI TAGLIO - CUTTING SPEED

n = giri/min (min⁻¹) NUMERO DI GIRI - NUMBER OF REVOLUTIONS

fz = mm AVANZAMENTO AL DENTE -TOOTH FEED

fn = mm AVANZAMENTO AL GIRO - FEED / REVOLUTION

Vf = mm/min VELOCITÀ DI AVANZAMENTO - FEED SPEED

SDR0102

GENERIC / ALL PURPOSE

$\varnothing D = 2,5 - 14$

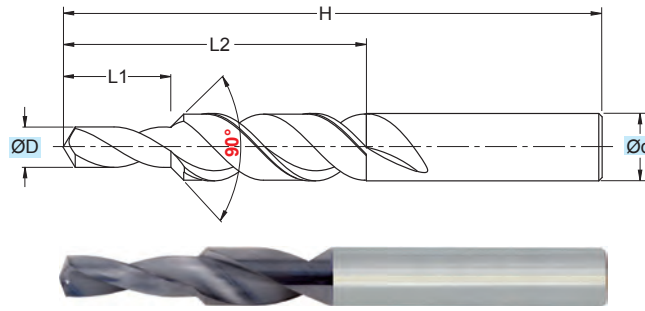

> ANGOLO DI SVASATURA 90°
 > RIVESTIMENTO TIALN

> CHAMFER 90°
 > TIALN COATED

RIVESTIM. COATED TIALN	
	MG

(mm)					
ART.	ØD	Ød	H	L1	L2
SDR0102030	2,5	6	66	8,8	20
SDR0102040	3,3	6	66	11,4	24
SDR0102050	4,2	6	66	13,6	28
SDR0102060	5,0	8	79	16,5	34
SDR0102080	6,8	10	89	21,0	47
SDR0102100	8,5	12	102	25,5	55
SDR0102120	10,2	14	107	30,0	60
SDR0102140	12,0	16	115	34,5	65
SDR0102160	14,0	18	123	38,5	73

MATERIALI - MATERIALS Pag. 1199

Applicazione - Application

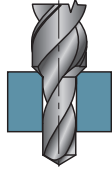

	MATERIALI - MATERIALS											ØD	Vc	fn	n (giri/min min ⁻¹)	Vf (mm/min)				
	P	M	K			N			S	H	G									
	ACCIAIO NON LEGATO NOT ALLOY STEEL	ACCIAIO POCO LEGATO LOW ALLOY STEEL	ACCIAIO ALTO LEGATO ALLOY STEEL	INOX MARTENSITICO STAINLESS STEEL MART.	INOX AUST. DUPLEX STAINLESS STEEL AUST.	GHISA GRIGIA GREY CAST IRON	GHISA SFEROIDALE SPHEROIDAL GRAPHITE	GHISA MALLEABILE MALLEABLE CAST IRON	ALLUMINIO E SUE LEGHE ALUMINIUM	RAME E SUE LEGHE COPPER	NON METALLICI PLASTICS	LEGHE RESIST. CALORE HIGH TEMP. ALLOY	TITANIO E SUE LEGHE TITANIUM	ACCIAIO TEMPRATO HARDENED STEEL	GRAFITE GRAPHITE					
●																2,5	80	0,100	10191	1019
●																3,3	80	0,180	7721	1390
●																4,2	80	0,180	6066	1092
●																5,0	80	0,240	5096	1223
●																6,8	80	0,240	3747	899
●																8,5	80	0,300	2997	899
●																10,2	80	0,300	2498	749
●																12,0	80	0,350	2123	743
●																14,0	80	0,350	1820	637
	●															2,5	50	0,080	6369	510
	●															3,3	50	0,150	4825	724
	●															4,2	50	0,150	3791	569
	●															5,0	50	0,210	3185	669
	●															6,8	50	0,210	2342	492
	●															8,5	50	0,270	1873	506
	●															10,2	50	0,270	1561	422
	●															12,0	50	0,320	1327	425
	●															14,0	50	0,320	1137	364
						●										2,5	75	0,150	9554	1433
						●										3,3	75	0,230	7238	1665
						●										4,2	75	0,230	5687	1308
						●										5,0	75	0,335	4777	1600
						●										6,8	75	0,335	3513	1177
						●										8,5	75	0,425	2810	1194
						●										10,2	75	0,425	2342	995
						●										12,0	75	0,520	1990	1035
						●										14,0	75	0,520	1706	887
							●									2,5	75	0,125	9554	1194
							●									3,3	75	0,200	7238	1448
							●									4,2	75	0,200	5687	1137
							●									5,0	75	0,250	4777	1194
							●									6,8	75	0,250	3513	878
							●									8,5	75	0,350	2810	984
							●									10,2	75	0,350	2342	820
							●									12,0	75	0,400	1990	796
							●									14,0	75	0,400	1706	682

● APPLICAZIONE CONSIGLIATA-RECOMMENDED APPLICATION
EMPFÖHLENER EINSATZ - APPLICATION CONSEILLÉE

○ APPLICAZIONE POSSIBILE - POSSIBLE APPLICATION
MÖGLICHE ANWENDUNG - APPLICATION POSSIBLE

Vc = m/min VELOCITÀ DI TAGLIO - CUTTING SPEED

n = giri/min (min⁻¹) NUMERO DI GIRI - NUMBER OF REVOLUTIONS

fz = mm AVANZAMENTO AL DENTE -TOOTH FEED

fn = mm AVANZAMENTO AL GIRO - FEED / REVOLUTION

Vf = mm/min VELOCITÀ DI AVANZAMENTO - FEED SPEED

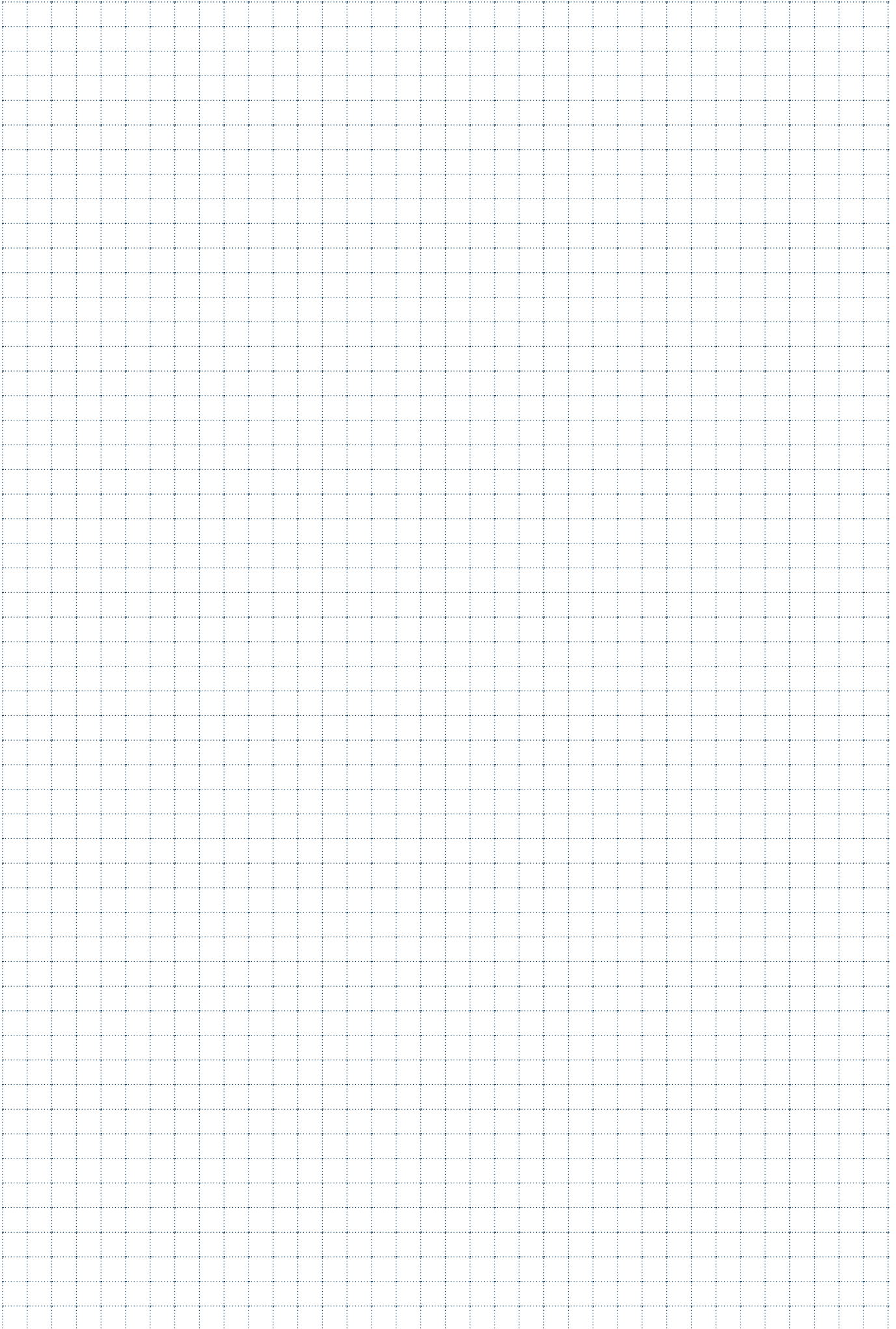



PUNTE A CENTRARE PUNTA PILOTA

CENTER DRILLS - PILOT DRILL / ZENTRIERBOHRER - PILOTBOHRER /
FORETS À CENTRER - FORETS PILOT / BROCAS CENTRADORAS - BROCA PILOTO

SCR0184

GENERICO / ALL PURPOSE

ØD = 3 - 20

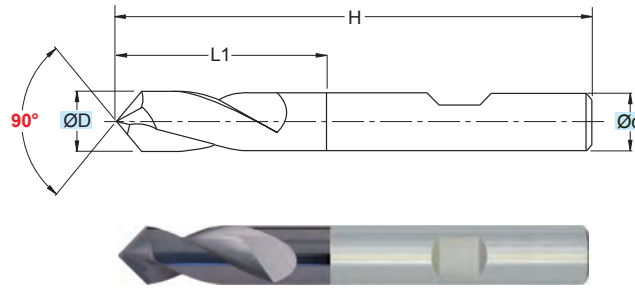

RIVESTIM.
 COATED
TIALN

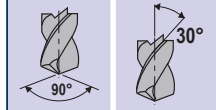

> PUNTA A CENTRARE PER MACCHINE CN
 > ANGOLO DI TESTA 90°
 > ATTACCO DIN 6535 HB

> CENTER DRILL ON NC-AND DRILLING MACHINES
 > HEAD ANGLE 90°
 > SHANK DIN 6535 HB

(mm)					
ART.	ØD	Ød	H	L1	Z
SCR0184030	3	3	38	8	2
SCR0184040	4	4	50	10	2
SCR0184050	5	5	50	13	2
SCR0184060	6	6	57	13	2
SCR0184080	8	8	63	19	2
SCR0184100	10	10	66	20	2
SCR0184120	12	12	73	22	2
SCR0184160	16	16	82	24	2
SCR0184200	20	20	92	30	2

MATERIALI - MATERIALS Pag. 1199

Applicazione - Application

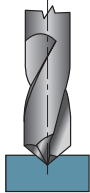

Applicazione - Application	MATERIALI - MATERIALS											ØD (mm)	Vc (m/min)	fn (mm)	n (giri/min)	Vf (mm/min)				
	P	M	K			N			S	H	G									
	ACCIAIO NON LEGATO NOT ALLOY STEEL	ACCIAIO POCO LEGATO LOW ALLOY STEEL	ACCIAIO ALTO LEGATO ALLOY STEEL	INOX MARTENSITICO STAINLESS STEEL MART.	INOX AUST. DUPLEX STAINLESS STEEL AUST.	GHISA GRIGIA GREY CAST IRON	GHISA SFEROIDALE SPHEROIDAL GRAPHITE	GHISA MALLEABILE MALLEABLE CAST IRON	ALLUMINIO E SUE LEGHE ALUMINIUM	RAME E SUE LEGHE COPPER	NON METALLICI PLASTICS	LEGHE RESIST. CALORE HIGH TEMP. ALLOY	TITANIO E SUE LEGHE TITANIUM	ACCIAIO TEMPRATO HARDENED STEEL	GRAFITE GRAPHITE					
●																3	80	0,100	8493	849
●																4	80	0,140	6369	892
●																5	80	0,140	5096	713
●																6	80	0,200	4246	849
●																8	80	0,200	3185	637
●																10	80	0,275	2548	701
●																12	80	0,275	2123	584
●																16	80	0,350	1592	557
●																20	80	0,450	1274	573
●																3	50	0,075	5308	398
●																4	50	0,100	3981	398
●																5	50	0,100	3185	318
●																6	50	0,150	2654	398
●																8	50	0,150	1990	299
●																10	50	0,200	1592	318
●																12	50	0,200	1327	265
●																16	50	0,260	995	259
●																20	50	0,325	796	259
						●										3	70	0,075	7431	557
						●										4	70	0,125	5573	697
						●										5	70	0,125	4459	557
						●										6	70	0,175	3715	650
						●										8	70	0,175	2787	488
						●										10	70	0,225	2229	502
						●										12	70	0,225	1858	418
						●										16	70	0,300	1393	418
						●										20	70	0,375	1115	418
							●									3	70	0,075	7431	557
							●									4	70	0,100	5573	557
							●									5	70	0,100	4459	446
							●									6	70	0,150	3715	557
							●									8	70	0,150	2787	418
							●									10	70	0,200	2229	446
							●									12	70	0,200	1858	372
							●									16	70	0,260	1393	362
							●									20	70	0,325	1115	362
								○								3	200	0,020	21231	425
								○								4	200	0,030	15924	478
								○								5	200	0,030	12739	382
								○								6	200	0,070	10616	743
								○								8	200	0,070	7962	557
								○								10	200	0,110	6369	701
								○								12	200	0,110	5308	584
								○								16	200	0,150	3981	597
								○								20	200	0,200	3185	637

● APPLICAZIONE CONSIGLIATA-RECOMMENDED APPLICATION
EMPFÖHLENER EINSATZ - APPLICATION CONSEILLÉE

○ APPLICAZIONE POSSIBILE - POSSIBLE APPLICATION
MÖGLICHE ANWENDUNG - APPLICATION POSSIBLE

Vc = m/min VELOCITÀ DI TAGLIO - CUTTING SPEED

n = giri/min (min⁻¹) NUMERO DI GIRI - NUMBER OF REVOLUTIONS

fn = mm AVANZAMENTO AL GIRO - FEED / REVOLUTION

Vf = mm/min VELOCITÀ DI AVANZAMENTO - FEED SPEED

SCR0185

GENERICO / ALL PURPOSE

ØD = 6 - 20

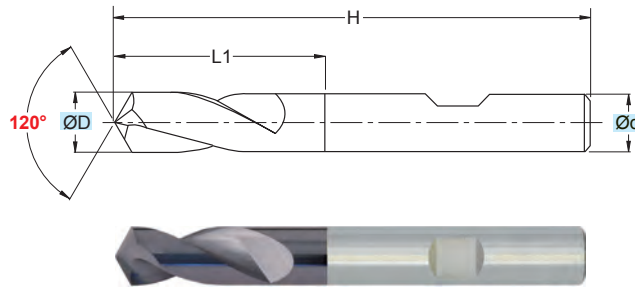

RIVESTIM.
COATED

TIALN

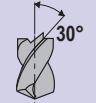

MG

> PUNTA A CENTRARE PER MACCHINE CN
 > ANGOLO DI TESTA 120°
 > ATTACCO DIN 6535 HB

> CENTER DRILL ON NC-AND DRILLING MACHINES
 > HEAD ANGLE 120°
 > SHANK DIN 6535 HB

(mm)					
ART.	ØD	Ød	H	L1	Z
SCR0185060	6	6	57	13	2
SCR0185080	8	8	63	19	2
SCR0185100	10	10	66	20	2
SCR0185120	12	12	73	22	2
SCR0185160	16	16	82	24	2
SCR0185200	20	20	92	30	2

MATERIALI - MATERIALS Pag. 1199

Applicazione - Application

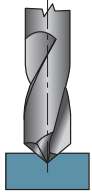

Applicazione - Application	MATERIALI - MATERIALS											ØD (mm)	Vc (m/min)	fn (mm)	n (giri/min)	Vf (mm/min)				
	P	M	K			N			S	H	G									
	ACCIAIO NON LEGATO NOT ALLOY STEEL	ACCIAIO POCO LEGATO LOW ALLOY STEEL	ACCIAIO ALTO LEGATO ALLOY STEEL	INOX MARTENSITICO STAINLESS STEEL, MART.	INOX AUST. DUPLEX STAINLESS STEEL, AUST.	GHISA GRIGIA GREY CAST IRON	GHISA SFEROIDALE SPHEROIDAL GRAPHITE	GHISA MALLEABILE MALLEABLE CAST IRON	ALLUMINIO E SUE LEGHE ALUMINIUM	RAME E SUE LEGHE COPPER	NON METALLICI PLASTICS	LEGHE RESIST. CALORE HIGH TEMP. ALLOY	TITANIO E SUE LEGHE TITANIUM	ACCIAIO TEMPRATO HARDENED STEEL	GRAFITE GRAPHITE					
●																6	50	0,035	2654	186
●																8	50	0,040	1990	159
●																10	50	0,045	1592	143
●																12	50	0,050	1327	133
●																16	50	0,055	995	109
●																20	50	0,060	796	96
●																6	25	0,020	1327	53
●																8	25	0,030	995	60
●																10	25	0,035	796	56
●																12	25	0,040	663	53
●																16	25	0,045	498	45
●																20	25	0,050	398	40
						●										6	72	0,045	3822	172
						●										8	72	0,060	2866	172
						●										10	72	0,065	2293	149
						●										12	72	0,070	1911	134
						●										16	72	0,075	1433	107
						●										20	72	0,080	1146	92
							●									6	60	0,045	3185	287
							●									8	60	0,060	2389	287
							●									10	60	0,065	1911	248
							●									12	60	0,070	1592	223
							●									16	60	0,075	1194	179
							●									20	60	0,080	955	153
																6	150	0,050	7962	796
																8	150	0,060	5971	717
																10	150	0,070	4777	669
																12	150	0,080	3981	637
																16	150	0,090	2986	537
																20	150	0,100	2389	478

● APPLICAZIONE CONSIGLIATA-RECOMMENDED APPLICATION
EMPFÖHLENER EINSATZ - APPLICATION CONSEILLÉE

○ APPLICAZIONE POSSIBILE - POSSIBLE APPLICATION
MÖGLICHE ANWENDUNG - APPLICATION POSSIBLE

Vc = m/min VELOCITÀ DI TAGLIO - CUTTING SPEED

n = giri/min (min⁻¹) NUMERO DI GIRI - NUMBER OF REVOLUTIONS

fn = mm AVANZAMENTO AL GIRO - FEED / REVOLUTION

Vf = mm/min VELOCITÀ DI AVANZAMENTO - FEED SPEED

SCR0186

GENERICO / ALL PURPOSE

ØD = 6 - 20

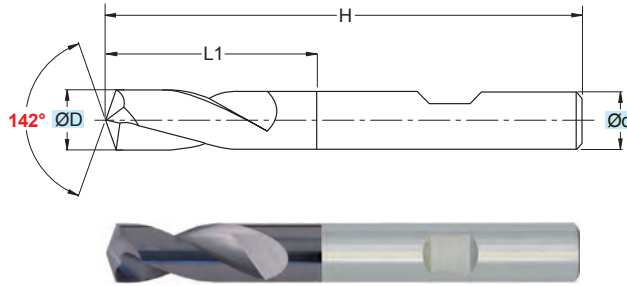

RIVESTIM.
COATED

TIALN

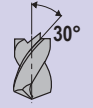

MG

> PUNTA A CENTRARE PER MACCHINE CN
 > ANGOLO DI TESTA 142°
 > ATTACCO DIN 6535 HB

> CENTER DRILL ON NC-AND DRILLING MACHINES
 > HEAD ANGLE 142°
 > SHANK DIN 6535 HB

(mm)					
ART.	ØD	Ød	H	L1	Z
SCR0186060	6	6	57	11	2
SCR0186080	8	8	63	19	2
SCR0186100	10	10	66	20	2
SCR0186120	12	12	73	22	2
SCR0186160	16	16	82	24	2
SCR0186200	20	20	92	30	2

SDF0371

$\varnothing D = 2 - 12$

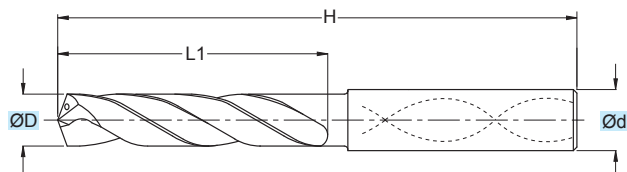

PER PREPARAZIONE FORI $\geq 12xD$
FOR THE PREPARATION OF BORES $\geq 12xD$
ZUR VORBEREITUNG VON BOHRUNGEN $\geq 12xD$
POUR LA PRÉPARATION DE TROUS $\geq 12xD$

TOLLERANZE	D	d
TOLLERANCE RANGE	+0,030 +0,005	h6

RIVESTIM.
COATED
TIALN

3xD

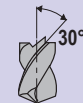

**DIN
6535**



MG

(mm)

ART.	$\varnothing D$	$\varnothing d$	H	L1
SDF0371020	2,0	4	50,0	12,0
SDF0371022	2,2	4	50,0	12,0
SDF0371023	2,3	4	50,0	12,0
SDF0371024	2,4	4	50,0	12,0
SDF0371025	2,5	4	50,0	12,0
SDF0371027	2,7	4	50,0	12,0
SDF0371028	2,8	4	50,0	12,0
SDF0371030	3,0	6	62,0	20,0
SDF0371032	3,2	6	62,0	20,0
SDF0371033	3,3	6	62,0	20,0
SDF0371035	3,5	6	62,0	20,0
SDF0371038	3,8	6	66,0	24,0
SDF0371040	4,0	6	66,0	24,0
SDF0371042	4,2	6	66,0	24,0
SDF0371045	4,5	6	66,0	24,0
SDF0371048	4,8	6	66,0	28,0
SDF0371050	5,0	6	66,0	28,0
SDF0371055	5,5	6	66,0	28,0
SDF0371058	5,8	6	66,0	28,0
SDF0371060	6,0	6	66,0	28,0
SDF0371065	6,5	8	79,0	34,0
SDF0371068	6,8	8	79,0	34,0
SDF0371070	7,0	8	79,0	34,0
SDF0371075	7,5	8	79,0	41,0
SDF0371078	7,8	8	79,0	41,0
SDF0371080	8,0	8	79,0	41,0
SDF0371085	8,5	10	89,0	47,0
SDF0371088	8,8	10	89,0	47,0
SDF0371090	9,0	10	89,0	47,0
SDF0371098	9,8	10	89,0	47,0
SDF0371100	10,0	10	89,0	47,0
SDF0371102	10,2	12	102,0	55,0
SDF0371108	10,8	12	102,0	55,0
SDF0371118	11,8	12	102,0	55,0
SDF0371120	12,0	12	102,0	55,0

MATERIALI - MATERIALS Pag. 1199

Applicazione - Application

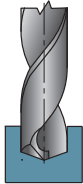

	MATERIALI - MATERIALS										ØD	Vc	fn	n	Vf					
	P	M	K	N	S	H	G	(mm)	(m/min)	(mm)						(giri/min)	(mm/min)			
	ACCIAIO NON LEGATO NOT ALLOY STEEL	ACCIAIO POCO LEGATO LOW ALLOY STEEL	ACCIAIO ALTO LEGATO ALLOY STEEL	INOX MARTENSITICO STAINLESS STEEL MART.	INOX AUST. DUPLEX STAINLESS STEEL AUST.	GHISA GRIGIA GREY CAST IRON	GHISA SFEROIDALE SPHEROIDAL GRAPHITE	GHISA MALLEABILE MALLEABLE CAST IRON	ALLUMINIO E SUE LEGHE ALUMINIUM	RAME E SUE LEGHE COPPER	NON METALLICI PLASTICS	LEGHE RESIST. CALORE HIGH TEMP. ALLOY	TITANIO E SUE LEGHE TITANIUM	ACCIAIO TEMPRATO HARDENED STEEL	GRAFITE GRAPHITE	(mm)	(m/min)	(mm)	(giri/min)	(mm/min)
●																2+3	120	0,130	15287	1987
●																3+4	120	0,150	10919	1638
●																4+5	120	0,170	8493	1444
●																5+6	120	0,200	6948	1390
●																6+7	120	0,230	5879	1352
●																7+8	120	0,260	5096	1325
●																8+9	120	0,300	4496	1349
●																9+10	120	0,330	4023	1328
●																10+11	120	0,350	3640	1274
●																11+12	120	0,380	3323	1263
○		●														2+3	110	0,130	14013	1822
○		●														3+4	110	0,150	10009	1501
○		●														4+5	110	0,170	7785	1323
○		●														5+6	110	0,200	6369	1274
○		●														6+7	110	0,230	5390	1240
○		●														7+8	110	0,260	4671	1214
○		●														8+9	110	0,300	4121	1236
○		●														9+10	110	0,330	3688	1217
○		●														10+11	110	0,350	3336	1168
○		●														11+12	110	0,380	3046	1158
○				●												2+3	45	0,100	5732	573
○				●												3+4	45	0,110	4095	450
○				●												4+5	45	0,130	3185	414
○				●												5+6	45	0,150	2606	391
○				●												6+7	45	0,170	2205	375
○				●												7+8	45	0,200	1911	382
○				●												8+9	45	0,220	1686	371
○				●												9+10	45	0,250	1509	377
○				●												10+11	45	0,270	1365	369
○				●												11+12	45	0,280	1246	349
○					●											2+3	120	0,130	15287	1987
○					●											3+4	120	0,150	10919	1638
○					●											4+5	120	0,170	8493	1444
○					●											5+6	120	0,200	6948	1390
○					●											6+7	120	0,230	5879	1352
○					●											7+8	120	0,260	5096	1325
○					●											8+9	120	0,300	4496	1349
○					●											9+10	120	0,330	4023	1328
○					●											10+11	120	0,350	3640	1274
○					●											11+12	120	0,380	3323	1263
○						●										2+3	110	0,100	14013	1401
○						●										3+4	110	0,110	10009	1101
○						●										4+5	110	0,130	7785	1012
○						●										5+6	110	0,150	6369	955
○						●										6+7	110	0,170	5390	916
○						●										7+8	110	0,200	4671	934
○						●										8+9	110	0,220	4121	907
○						●										9+10	110	0,250	3688	922
○						●										10+11	110	0,270	3336	901
○						●										11+12	110	0,280	3046	853

● APPLICAZIONE CONSIGLIATA-RECOMMENDED APPLICATION
EMPFOLHENER EINSATZ - APPLICATION CONSEILLÉE

○ APPLICAZIONE POSSIBILE - POSSIBLE APPLICATION
MÖGLICHE ANWENDUNG - APPLICATION POSSIBLE

Vc = m/min VELOCITÀ DI TAGLIO - CUTTING SPEED

n = giri/min (min⁻¹) NUMERO DI GIRI - NUMBER OF REVOLUTIONS

fn = mm AVANZAMENTO AL GIRO - FEED / REVOLUTION

Vf = mm/min VELOCITÀ DI AVANZAMENTO - FEED SPEED

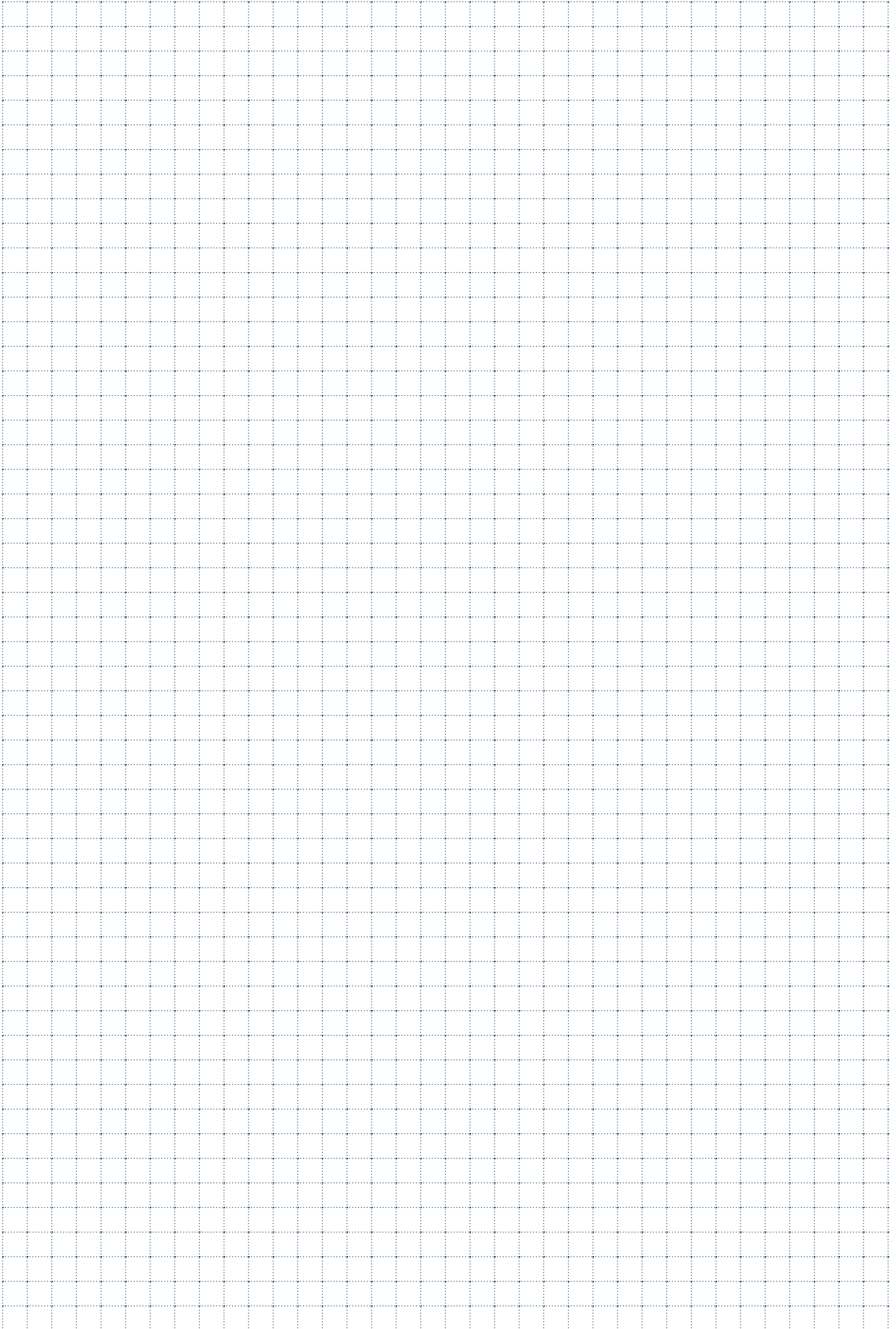



PUNTE FORALESA

REAMER-DRILLS / REIBAHLEN-BOHRER / FORETS DE PERÇAGE ET ALÉSAGE /
BROCAS ESCARIADORAS

SPFAR3

GENERIC / ALL PURPOSE

ØD = 2,97 - 20,02

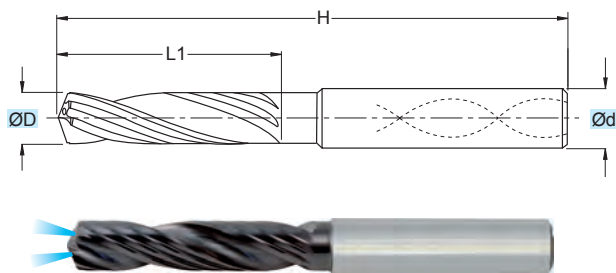

RIVESTIM.
COATED
TIALN

3xD

MG

TOLLERANZE TOLERANCE RANGE	D	d
	±0,003	h6

(mm)				
ART.	ØD	Ød	H	L1
SPFAR3 2.97	2,97	6,0	62	20
SPFAR3 2.98	2,98	6,0	62	20
SPFAR3 2.99	2,99	6,0	62	20
SPFAR3 3.00	3,00	6,0	62	20
*SPFAR3 3.01	3,01	6,0	62	20
SPFAR3 3.02	3,02	6,0	62	20
SPFAR3 3.97	3,97	6,0	66	24
SPFAR3 3.98	3,98	6,0	66	24
SPFAR3 3.99	3,99	6,0	66	24
SPFAR3 4.00	4,00	6,0	66	24
*SPFAR3 4.01	4,01	6,0	66	24
SPFAR3 4.02	4,02	6,0	66	24
SPFAR3 4.97	4,97	6,0	66	28
SPFAR3 4.98	4,98	6,0	66	28
SPFAR3 4.99	4,99	6,0	66	28
SPFAR3 5.00	5,00	6,0	66	28
*SPFAR3 5.01	5,01	6,0	66	28
SPFAR3 5.02	5,02	6,0	66	28
SPFAR3 5.97	5,97	6,0	66	28
SPFAR3 5.98	5,98	6,0	66	28
SPFAR3 5.99	5,99	6,0	66	28
SPFAR3 6.00	6,00	6,0	66	28
*SPFAR3 6.01	6,01	6,0	66	28
SPFAR3 6.02	6,02	6,0	66	28
SPFAR3 6.97	6,97	8,0	79	34
SPFAR3 6.98	6,98	8,0	79	34
SPFAR3 6.99	6,99	8,0	79	34
SPFAR3 7.00	7,00	8,0	79	34
*SPFAR3 7.01	7,01	8,0	79	34
SPFAR3 7.02	7,02	8,0	79	34
SPFAR3 7.97	7,97	8,0	79	34
SPFAR3 7.98	7,98	8,0	79	34
SPFAR3 7.99	7,99	8,0	79	34
SPFAR3 8.00	8,00	8,0	79	34
*SPFAR3 8.01	8,01	8,0	79	34
SPFAR3 8.02	8,02	8,0	79	34
SPFAR3 8.97	8,97	10,0	89	47
SPFAR3 8.98	8,98	10,0	89	47
SPFAR3 8.99	8,99	10,0	89	47
SPFAR3 9.00	9,00	10,0	89	47
*SPFAR3 9.01	9,01	10,0	89	47
SPFAR3 9.02	9,02	10,0	89	47
SPFAR3 9.97	9,97	10,0	89	47
SPFAR3 9.98	9,98	10,0	89	47
SPFAR3 9.99	9,99	10,0	89	47

(mm)				
ART.	ØD	Ød	H	L1
SPFAR3 10.00	10,00	10,0	89	47
*SPFAR3 10.01	10,01	10,0	89	47
SPFAR3 10.02	10,02	10,0	89	47
SPFAR3 10.97	10,97	12,0	102	55
SPFAR3 10.98	10,98	12,0	102	55
SPFAR3 10.99	10,99	12,0	102	55
SPFAR3 11.00	11,00	12,0	102	55
*SPFAR3 11.01	11,01	12,0	102	55
SPFAR3 11.02	11,02	12,0	102	55
SPFAR3 11.97	11,97	12,0	102	55
SPFAR3 11.98	11,98	12,0	102	55
SPFAR3 11.99	11,99	12,0	102	55
SPFAR3 12.00	12,00	12,0	102	55
*SPFAR3 12.01	12,01	12,0	102	55
SPFAR3 12.02	12,02	12,0	102	55
SPFAR3 12.97	12,97	14,0	107	60
SPFAR3 12.98	12,98	14,0	107	60
SPFAR3 12.99	12,99	14,0	107	60
SPFAR3 13.00	13,00	14,0	107	60
*SPFAR3 13.01	13,01	14,0	107	60
SPFAR3 13.02	13,02	14,0	107	60
SPFAR3 13.97	13,97	14,0	107	60
SPFAR3 13.98	13,98	14,0	107	60
SPFAR3 13.99	13,99	14,0	107	60
SPFAR3 14.00	14,00	14,0	107	60
*SPFAR3 14.01	14,01	14,0	107	60
SPFAR3 14.02	14,02	14,0	107	60
SPFAR3 14.97	14,97	16,0	115	65
SPFAR3 14.98	14,98	16,0	115	65
SPFAR3 14.99	14,99	16,0	115	65
SPFAR3 15.00	15,00	16,0	115	65
*SPFAR3 15.01	15,01	16,0	115	65
SPFAR3 15.02	15,02	16,0	115	65
SPFAR3 15.97	15,97	16,0	115	65
SPFAR3 15.98	15,98	16,0	115	65
SPFAR3 15.99	15,99	16,0	115	65
SPFAR3 16.00	16,00	16,0	115	65
*SPFAR3 16.01	16,01	16,0	115	65
SPFAR3 16.02	16,02	16,0	115	65
SPFAR3 16.97	16,97	18,0	123	73
SPFAR3 16.98	16,98	18,0	123	73
SPFAR3 16.99	16,99	18,0	123	73
SPFAR3 17.00	17,00	18,0	123	73
*SPFAR3 17.01	17,01	18,0	123	73
SPFAR3 17.02	17,02	18,0	123	73

(mm)				
ART.	ØD	Ød	H	L1
SPFAR3 17.97	17,97	18,0	123	73
SPFAR3 17.98	17,98	18,0	123	73
SPFAR3 17.99	17,99	18,0	123	73
SPFAR3 18.00	18,00	18,0	123	73
*SPFAR3 18.01	18,01	18,0	123	73
SPFAR3 18.02	18,02	18,0	123	73
SPFAR3 18.97	18,97	20,0	131	79
SPFAR3 18.98	18,98	20,0	131	79
SPFAR3 18.99	18,99	20,0	131	79
SPFAR3 19.00	19,00	20,0	131	79
*SPFAR3 19.01	19,01	20,0	131	79
SPFAR3 19.02	19,02	20,0	131	79
SPFAR3 19.97	19,97	20,0	131	79
SPFAR3 19.98	19,98	20,0	131	79
SPFAR3 19.99	19,99	20,0	131	79
SPFAR3 20.00	20,00	20,0	131	79
*SPFAR3 20.01	20,01	20,0	131	79
SPFAR3 20.02	20,02	20,0	131	79

* = PER OTTENERE FORI IN TOLLERANZA H7
 * = TO OBTAIN BORES IN H7 TOLERANCE
 * = UM BOHRUNGEN IN H7-TOLERANZ ZU ERHALTEN
 * = POUR OBTENIR DES TROUS DANS LA TOLÉRANCE H7

MATERIALI - MATERIALS Pag. 1199

Applicazione - Application



Applicazione - Application	MATERIALI - MATERIALS											ØD (mm)	Vc (m/min)	fn (mm)	n (giri/min)	Vf (mm/min)				
	P	M	K		N		S		H	G										
	ACCIAIO NON LEGATO NOT ALLOY STEEL	ACCIAIO POCO LEGATO LOW ALLOY STEEL	ACCIAIO ALTO LEGATO ALLOY STEEL	INOX MARTENSITICO STAINLESS STEEL MART.	INOX AUST. DUPLEX STAINLESS STEEL AUST.	GHISA GRIGIA GREY CAST IRON	GHISA SFEROIDALE SPHEROIDAL GRAPHITE	GHISA MALLEABILE MALLEABLE CAST IRON	ALLUMINIO E SUE LEGHE ALUMINIUM	RAME E SUE LEGHE COPPER	NON METALLICI PLASTICS	LEGHE RESIST. CALORE HIGH TEMP. ALLOY	TITANIO E SUE LEGHE TITANIUM	ACCIAIO TEMPRATO HARDENED STEEL	GRAFITE GRAPHITE					
●																3+5	80	0,05	6369	318
																5+8	80	0,08	3920	314
																8+12	80	0,10	2548	255
																12+16	80	0,12	1820	218
																16+20	80	0,14	1415	198
●																3+5	50	0,05	3981	199
																5+8	50	0,08	2450	196
																8+12	50	0,10	1592	159
																12+16	50	0,10	1137	114
																16+20	50	0,12	885	106
●																3+5	45	0,05	3583	179
																5+8	45	0,08	2205	176
																8+12	45	0,10	1433	143
																12+16	45	0,10	1024	102
																16+20	45	0,12	796	96
●																3+5	70	0,07	5573	390
																5+8	70	0,10	3430	343
																8+12	70	0,14	2229	312
																12+16	70	0,16	1592	255
																16+20	70	0,16	1238	198
●																3+5	60	0,05	4777	239
																5+8	60	0,08	2940	235
																8+12	60	0,10	1911	191
																12+16	60	0,12	1365	164
																16+20	60	0,14	1061	149
●																3+5	50	0,06	3981	239
																5+8	50	0,09	2450	221
																8+12	50	0,11	1592	175
																12+16	50	0,14	1137	159
																16+20	50	0,15	885	133

● APPLICAZIONE CONSIGLIATA-RECOMMENDED APPLICATION
EMPFOLLENER EINSATZ - APPLICATION CONSEILLÉE

○ APPLICAZIONE POSSIBILE - POSSIBLE APPLICATION
MÖGLICHE ANWENDUNG - APPLICATION POSSIBLE

Vc = m/min VELOCITÀ DI TAGLIO - CUTTING SPEED

n = giri/min (min⁻¹) NUMERO DI GIRI - NUMBER OF REVOLUTIONS

fn = mm AVANZAMENTO AL GIRO - FEED / REVOLUTION

Vf = mm/min VELOCITÀ DI AVANZAMENTO - FEED SPEED

SPFAR5

GENERICO / ALL PURPOSE

ØD = 2,97 - 20,02

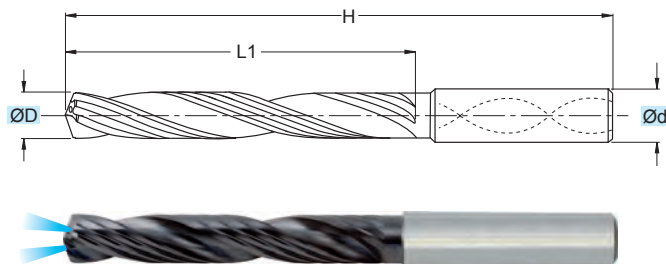

RIVESTIM. COATED
TIALN **5xD**

MG

TOLLERANZE	D	d
TOLERANCE RANGE	±0,003	h6

ART.	(mm)			
ART.	ØD	Ød	H	L1
SPFAR5 2.97	2,97	6,0	66	28
SPFAR5 2.98	2,98	6,0	66	28
SPFAR5 2.99	2,99	6,0	66	28
SPFAR5 3.00	3,00	6,0	66	28
*SPFAR5 3.01	3,01	6,0	66	28
SPFAR5 3.02	3,02	6,0	66	28
SPFAR5 3.97	3,97	6,0	74	36
SPFAR5 3.98	3,98	6,0	74	36
SPFAR5 3.99	3,99	6,0	74	36
SPFAR5 4.00	4,00	6,0	74	36
*SPFAR5 4.01	4,01	6,0	74	36
SPFAR5 4.02	4,02	6,0	74	36
SPFAR5 4.97	4,97	6,0	82	44
SPFAR5 4.98	4,98	6,0	82	44
SPFAR5 4.99	4,99	6,0	82	44
SPFAR5 5.00	5,00	6,0	82	44
*SPFAR5 5.01	5,01	6,0	82	44
SPFAR5 5.02	5,02	6,0	82	44
SPFAR5 5.97	5,97	6,0	82	44
SPFAR5 5.98	5,98	6,0	82	44
SPFAR5 5.99	5,99	6,0	82	44
SPFAR5 6.00	6,00	6,0	82	44
*SPFAR5 6.01	6,01	6,0	82	44
SPFAR5 6.02	6,02	6,0	82	44
SPFAR5 6.97	6,97	8,0	91	53
SPFAR5 6.98	6,98	8,0	91	53
SPFAR5 6.99	6,99	8,0	91	53
SPFAR5 7.00	7,00	8,0	91	53
*SPFAR5 7.01	7,01	8,0	91	53
SPFAR5 7.02	7,02	8,0	91	53
SPFAR5 7.97	7,97	8,0	91	53
SPFAR5 7.98	7,98	8,0	91	53
SPFAR5 7.99	7,99	8,0	91	53
SPFAR5 8.00	8,00	8,0	91	53
*SPFAR5 8.01	8,01	8,0	91	53
SPFAR5 8.02	8,02	8,0	91	53
SPFAR5 8.97	8,97	10,0	103	61
SPFAR5 8.98	8,98	10,0	103	61
SPFAR5 8.99	8,99	10,0	103	61
SPFAR5 9.00	9,00	10,0	103	61
*SPFAR5 9.01	9,01	10,0	103	61
SPFAR5 9.02	9,02	10,0	103	61
SPFAR5 9.97	9,97	10,0	103	61
SPFAR5 9.98	9,98	10,0	103	61
SPFAR5 9.99	9,99	10,0	103	61

ART.	(mm)			
ART.	ØD	Ød	H	L1
SPFAR5 10.00	10,00	10,0	103	61
*SPFAR5 10.01	10,01	10,0	103	61
SPFAR5 10.02	10,02	10,0	103	61
SPFAR5 10.97	10,97	12,0	118	71
SPFAR5 10.98	10,98	12,0	118	71
SPFAR5 10.99	10,99	12,0	118	71
SPFAR5 11.00	11,00	12,0	118	71
*SPFAR5 11.01	11,01	12,0	118	71
SPFAR5 11.02	11,02	12,0	118	71
SPFAR5 11.97	11,97	12,0	118	71
SPFAR5 11.98	11,98	12,0	118	71
SPFAR5 11.99	11,99	12,0	118	71
SPFAR5 12.00	12,00	12,0	118	71
*SPFAR5 12.01	12,01	12,0	118	71
SPFAR5 12.02	12,02	12,0	118	71
SPFAR5 12.97	12,97	14,0	124	77
SPFAR5 12.98	12,98	14,0	124	77
SPFAR5 12.99	12,99	14,0	124	77
SPFAR5 13.00	13,00	14,0	124	77
*SPFAR5 13.01	13,01	14,0	124	77
SPFAR5 13.02	13,02	14,0	124	77
SPFAR5 13.97	13,97	14,0	124	77
SPFAR5 13.98	13,98	14,0	124	77
SPFAR5 13.99	13,99	14,0	124	77
SPFAR5 14.00	14,00	14,0	124	77
*SPFAR5 14.01	14,01	14,0	124	77
SPFAR5 14.02	14,02	14,0	124	77
SPFAR5 14.97	14,97	16,0	133	83
SPFAR5 14.98	14,98	16,0	133	83
SPFAR5 14.99	14,99	16,0	133	83
SPFAR5 15.00	15,00	16,0	133	83
*SPFAR5 15.01	15,01	16,0	133	83
SPFAR5 15.02	15,02	16,0	133	83
SPFAR5 15.97	15,97	16,0	133	83
SPFAR5 15.98	15,98	16,0	133	83
SPFAR5 15.99	15,99	16,0	133	83
SPFAR5 16.00	16,00	16,0	133	83
*SPFAR5 16.01	16,01	16,0	133	83
SPFAR5 16.02	16,02	16,0	133	83
SPFAR5 16.97	16,97	18,0	143	93
SPFAR5 16.98	16,98	18,0	143	93
SPFAR5 16.99	16,99	18,0	143	93
SPFAR5 17.00	17,00	18,0	143	93
*SPFAR5 17.01	17,01	18,0	143	93
SPFAR5 17.02	17,02	18,0	143	93

ART.	(mm)			
ART.	ØD	Ød	H	L1
SPFAR5 17.97	17,97	18,0	143	93
SPFAR5 17.98	17,98	18,0	143	93
SPFAR5 17.99	17,99	18,0	143	93
SPFAR5 18.00	18,00	18,0	143	93
*SPFAR5 18.01	18,01	18,0	143	93
SPFAR5 18.02	18,02	18,0	143	93
SPFAR5 18.97	18,97	20,0	153	101
SPFAR5 18.98	18,98	20,0	153	101
SPFAR5 18.99	18,99	20,0	153	101
SPFAR5 19.00	19,00	20,0	153	101
*SPFAR5 19.01	19,01	20,0	153	101
SPFAR5 19.02	19,02	20,0	153	101
SPFAR5 19.97	19,97	20,0	153	101
SPFAR5 19.98	19,98	20,0	153	101
SPFAR5 19.99	19,99	20,0	153	101
SPFAR5 20.00	20,00	20,0	153	101
*SPFAR5 20.01	20,01	20,0	153	101
SPFAR5 20.02	20,02	20,0	153	101

* = PER OTTENERE FORI IN TOLLERANZA H7
 * = TO OBTAIN BORES IN H7 TOLERANCE
 * = UM BOHRUNGEN IN H7-TOLERANZ ZU ERHALTEN
 * = POUR OBTENIR DES TROUS DANS LA TOLÉRANCE H7

MATERIALI - MATERIALS Pag. 1199

Applicazione - Application



Applicazione - Application	MATERIALI - MATERIALS											ØD (mm)	Vc (m/min)	fn (mm)	n (giri/min)	Vf (mm/min)				
	P	M	K		N		S		H	G										
	ACCIAIO NON LEGATO NOT ALLOY STEEL	ACCIAIO POCO LEGATO LOW ALLOY STEEL	ACCIAIO ALTO LEGATO ALLOY STEEL	INOX MARTENSITICO STAINLESS STEEL MART.	INOX AUST. DUPLEX STAINLESS STEEL AUST.	GHISA GRIGIA GREY CAST IRON	GHISA SFEROIDALE SPHEROIDAL GRAPHITE	GHISA MALLEABILE MALLEABLE CAST IRON	ALLUMINIO E SUE LEGHE ALUMINIUM	RAME E SUE LEGHE COPPER	NON METALLICI PLASTICS	LEGHE RESIST. CALORE HIGH TEMP. ALLOY	TITANIO E SUE LEGHE TITANIUM	ACCIAIO TEMPRATO HARDENED STEEL	GRAFITE GRAPHITE					
●																3+5	80	0,04	6369	255
																5+8	80	0,06	3920	235
																8+12	80	0,08	2548	204
																12+16	80	0,10	1820	182
																16+20	80	0,12	1415	170
●																3+5	50	0,04	3981	159
																5+8	50	0,07	2450	172
																8+12	50	0,09	1592	143
																12+16	50	0,09	1137	102
																16+20	50	0,10	885	89
●																3+5	45	0,04	3583	143
																5+8	45	0,07	2205	154
																8+12	45	0,09	1433	129
																12+16	45	0,09	1024	92
																16+20	45	0,10	796	80
●																3+5	70	0,06	5573	334
																5+8	70	0,09	3430	309
																8+12	70	0,12	2229	267
																12+16	70	0,14	1592	223
																16+20	70	0,14	1238	173
●																3+5	60	0,04	4777	191
																5+8	60	0,06	2940	176
																8+12	60	0,08	1911	153
																12+16	60	0,10	1365	137
																16+20	60	0,12	1061	127
●																3+5	50	0,05	3981	199
																5+8	50	0,08	2450	196
																8+12	50	0,10	1592	159
																12+16	50	0,12	1137	136
																16+20	50	0,14	885	124

● APPLICAZIONE CONSIGLIATA-RECOMMENDED APPLICATION
EMPFOLHENER EINSATZ - APPLICATION CONSEILLÉE

○ APPLICAZIONE POSSIBILE - POSSIBLE APPLICATION
MÖGLICHE ANWENDUNG - APPLICATION POSSIBLE

Vc = m/min VELOCITÀ DI TAGLIO - CUTTING SPEED

n = giri/min (min⁻¹) NUMERO DI GIRI - NUMBER OF REVOLUTIONS

fn = mm AVANZAMENTO AL GIRO - FEED / REVOLUTION

Vf = mm/min VELOCITÀ DI AVANZAMENTO - FEED SPEED

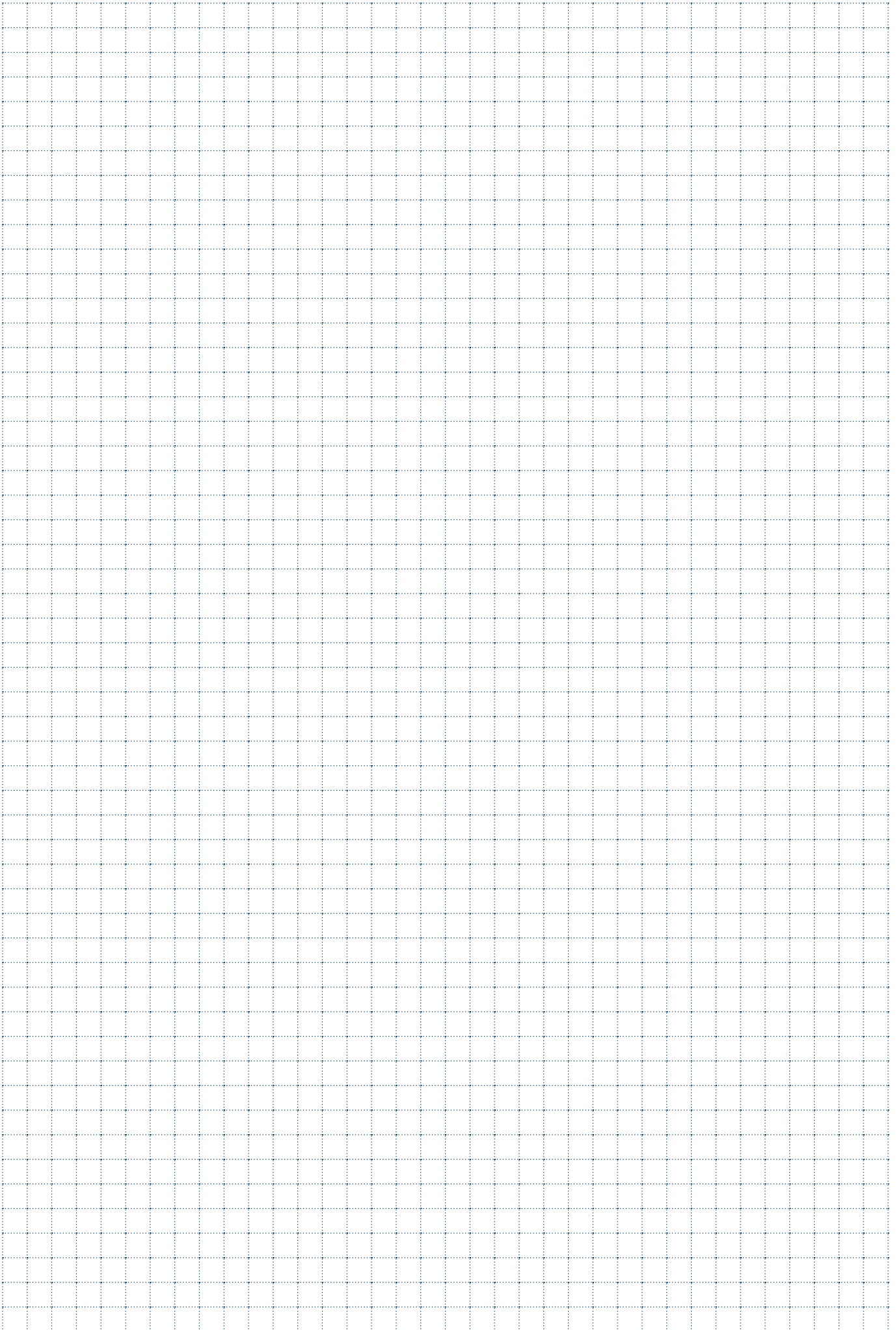



ALESATORI

REAMERS / REIBAHLEN / ALESOIRS / ESCARIADORES

SAN0508

ØD = 3 - 18

* RIVESTIMENTO A RICHIESTA
 * COATING ON REQUEST



MG

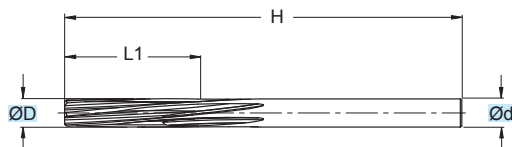

In figura alesatore non rivestito - Uncoated Reamer shown

TOLLERANZE	D	d
TOLLERANCE RANGE	H7	h8

ART.	ØD (mm)	Ød (mm)	H (mm)	L1 (mm)	Z
*SAN0508030	3,0	3,0	56	16	4
*SAN0508035	3,5	3,0	56	18	4
*SAN0508040	4,0	3,5	56	20	6
*SAN0508045	4,5	4,0	63	22	6
*SAN0508050	5,0	4,0	63	22	6
*SAN0508055	5,5	5,0	63	22	6
SAN0508060	6,0	5,0	63	22	6
SAN0508065	6,5	5,0	63	22	6
SAN0508070	7,0	6,0	71	25	6
SAN0508075	7,5	6,0	71	25	6
SAN0508080	8,0	6,0	71	25	6
SAN0508085	8,5	6,0	71	25	6
SAN0508090	9,0	8,0	71	25	6
SAN0508095	9,5	8,0	71	25	6
SAN0508100	10,0	8,0	71	25	6
SAN0508105	10,5	8,0	80	28	6
SAN0508110	11,0	10,0	80	28	6
SAN0508115	11,5	10,0	80	28	6
SAN0508120	12,0	10,0	80	28	6
SAN0508130	13,0	10,0	80	28	6
SAN0508140	14,0	12,0	90	32	6
SAN0508150	15,0	12,0	90	32	8
SAN0508160	16,0	14,0	90	32	8
SAN0508170	17,0	14,0	90	32	8
SAN0508180	18,0	16,0	100	36	8

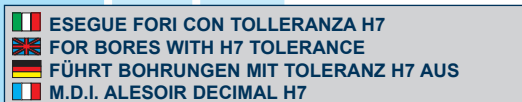
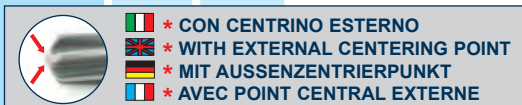

* Per ordinare alesatori rivestiti sostituire al codice art. la "N" con una "R"
 * To order coated reamers, replace the article code "N" with "R."
 * Um beschichtete Reibahlen zu bestellen, ersetzen Sie den Artikelcode "N" durch ein "R".
 * Pour commander des alésoirs revêtus, remplacez le numéro d'article "N" par un "R".

EX. Ø = 10,0 COD. = SAR0508100

SAN0509

ØD = 2,97 - 18,20

* RIVESTIMENTO A RICHIESTA
 * COATING ON REQUEST

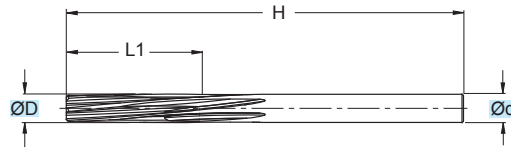

MG

In figura alesatore non rivestito - Uncoated Reamer shown

TOLLERANZE	D	d
TOLLERANCE RANGE	-0/+0,004	h8

ART.	(mm)				
	ØD	Ød	H	L1	Z
*SAN0509 ...	2,97-3,10	3,0	56	16	4
*SAN0509 ...	3,11-3,60	3,0	56	18	4
*SAN0509 ...	3,61-4,10	3,5	56	20	6
*SAN0509 ...	4,11-4,60	4,0	63	22	6
*SAN0509 ...	4,61-5,10	4,0	63	22	6
*SAN0509 ...	5,11-5,60	5,0	63	22	6
SAN0509 ...	5,61-6,15	5,0	63	22	6
SAN0509 ...	6,16-6,65	5,0	63	22	6
SAN0509 ...	6,66-7,15	6,0	71	25	6
SAN0509 ...	7,16-7,65	6,0	71	25	6
SAN0509 ...	7,66-8,15	6,0	71	25	6
SAN0509 ...	8,16-8,65	6,0	71	25	6
SAN0509 ...	8,66-9,20	8,0	71	25	6
SAN0509 ...	9,21-9,70	8,0	71	25	6
SAN0509 ...	9,71-10,20	8,0	71	25	6
SAN0509 ...	10,21-10,70	8,0	80	28	6
SAN0509 ...	10,71-11,20	10,0	80	28	6
SAN0509 ...	11,21-11,70	10,0	80	28	6
SAN0509 ...	11,71-12,20	10,0	80	28	6
SAN0509 ...	12,21-13,20	10,0	80	28	6
SAN0509 ...	13,21-14,20	12,0	90	32	6
SAN0509 ...	14,21-15,20	12,0	90	32	8
SAN0509 ...	15,21-16,20	14,0	90	32	8
SAN0509 ...	16,21-17,20	14,0	90	32	8
SAN0509 ...	17,21-18,20	16,0	100	36	8

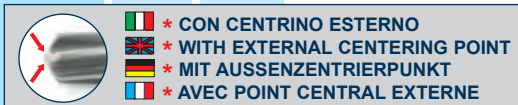

* Nell'ordine inserire sempre il "Ø" scelto dopo il codice dell'alesatore
 * When ordering always indicate the chosen diameter after the reamer code
 * Bei der Bestellung bitte immer den gewählten "Ø" hinter dem Reibahlencode angeben
 * Entrer toujours dans la commande le "Ø" choisi après le code de l'alesoir

EX. Ø = 13,21 COD. = **SAN05091321**
 EX. Ø = 3,80 COD. = **SAN05090380**

* Per ordinare alesatori rivestiti sostituire al codice art. la "N" con una "R"
 * To order coated reamers, replace the article code "N" with "R."
 * Um beschichtete Reibahlen zu bestellen, ersetzen Sie den Artikelcode "N" durch ein "R".
 * Pour commander des alésoirs revêtus, remplacez le numéro d'article "N" par un "R".

EX. Ø = 13,21 COD. = **SAR05091321**
 EX. Ø = 3,80 COD. = **SAR05090380**

MATERIALI - MATERIALS Pag. 1199

Applicazione - Application

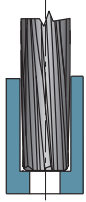

	MATERIALI - MATERIALS													ØD	Vc	fn	n (giri/min) (min ⁻¹)	Vf (mm/min)			
	P			M	K			N			S		H						G		
	ACCIAIO NON LEGATO NOT ALLOY STEEL	ACCIAIO POCO LEGATO LOW ALLOY STEEL	ACCIAIO ALTO LEGATO ALLOY STEEL	INOX MARTENSITICO STAINLESS STEEL MART.	INOX AUST. DUPLEX STAINLESS STEEL AUST.	GHISA GRIGIA GREY CAST IRON	GHISA SFEROIDALE SPHEROIDAL GRAPHITE	GHISA MALLEABILE MALLEABLE CAST IRON	ALLUMINIO E SUE LEGHE ALUMINIUM	RAME E SUE LEGHE COPPER	NON METALLICI PLASTICS	LEGHE RESIST. CALORE HIGH TEMP. ALLOY	TITANIO E SUE LEGHE TITANIUM	ACCIAIO TEMPRATO HARDENED STEEL	GRAFITE GRAPHITE						
●																	1+5	20-30	0,15	-	-
●																	5+10	20-30	0,25	-	-
●																	10+20	20-30	0,40	-	-
●																	1+5	10-15	0,12	-	-
●																	5+10	10-15	0,20	-	-
●																	10+20	10-15	0,30	-	-
●																	1+5	5-10	0,08	-	-
●																	5+10	5-10	0,15	-	-
●																	10+20	5-10	0,25	-	-
●																	1+5	10-15	0,08	-	-
●																	5+10	10-15	0,15	-	-
●																	10+20	10-15	0,20	-	-
●																	1+5	10-12	0,15	-	-
●																	5+10	10-12	0,30	-	-
●																	10+20	10-12	0,50	-	-
●																	1+5	10-12	0,15	-	-
●																	5+10	10-12	0,30	-	-
●																	10+20	10-12	0,50	-	-
●																	1+5	25-35	0,15	-	-
●																	5+10	25-35	0,25	-	-
●																	10+20	25-35	0,40	-	-
●																	1+5	25-35	0,20	-	-
●																	5+10	25-35	0,25	-	-
●																	10+20	25-35	0,40	-	-
●																	1+5	25-30	0,15	-	-
●																	5+10	25-30	0,25	-	-
●																	10+20	25-30	0,45	-	-

● APPLICAZIONE CONSIGLIATA-RECOMMENDED APPLICATION
EMPFOLLENER EINSATZ - APPLICATION CONSEILLÉE

○ APPLICAZIONE POSSIBILE - POSSIBLE APPLICATION
MÖGLICHE ANWENDUNG - APPLICATION POSSIBLE

Vc = m/min VELOCITÀ DI TAGLIO - CUTTING SPEED

n = giri/min (min⁻¹) NUMERO DI GIRI - NUMBER OF REVOLUTIONS

fn = mm AVANZAMENTO AL GIRO - FEED / REVOLUTION

Vf = mm/min VELOCITÀ DI AVANZAMENTO - FEED SPEED

$$n = \frac{Vc \cdot 1000}{\text{ØD} \cdot 3,14} = \text{giri/min (min}^{-1}\text{)}$$

$$Vf = fn \cdot n = \text{mm/min}$$

SAN0708

ØD = 1,0 - 20,2

* RIVESTIMENTO A RICHIESTA
 * COATING ON REQUEST



MG

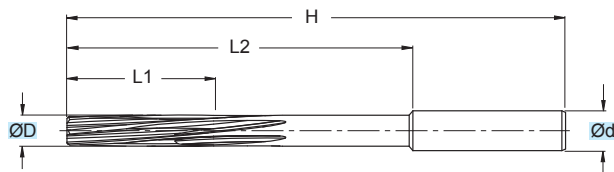

* Per ordinare alesatori rivestiti sostituire al codice art. la "N" con una "R"
 * To order coated reamers, replace the article code "N" with "R."
 * Um beschichtete Reibahlen zu bestellen, ersetzen Sie den Artikelcode "N" durch ein "R".
 * Pour commander des alésoirs revêtus, remplacez le numéro d'article "N" par un "R".
 EX. Ø = 12,3 COD. = SAR07080123
 EX. Ø = 3,1 COD. = SAR07080031

TOLLERANZE	D	d
TOLLERANCE RANGE	H7	h8

ART.	(mm)					
	ØD	Ød	H	L1	L2	Z
*SAN07080010	1,0	1,0	40	8	-	4
*SAN0708 ...	1,1-1,4	-	40	8	-	4
*SAN07080015	1,5	1,5	40	8	-	4
*SAN0708 ...	1,6-1,9	-	43	9	-	4
*SAN07080020	2,0	2,0	49	11	-	4
*SAN07080021	2,1	2,0	49	11	-	4
*SAN0708 ...	2,2-2,3	2,0	53	12	-	4
*SAN07080024	2,4	2,3	57	14	-	4
*SAN07080025	2,5	2,5	57	14	-	4
*SAN07080026	2,6	2,5	57	14	-	4
*SAN0708 ...	2,7-2,9	2,5	61	15	-	4
*SAN07080030	3,0	3,0	65	16	-	4
*SAN0708 ...	3,1-3,3	3,0	65	16	-	4
*SAN07080034	3,4	3,5	70	18	45	4
*SAN07080035	3,5	3,5	70	18	45	4
*SAN0708 ...	3,6-3,7	3,5	70	18	45	4
*SAN0708 ...	3,8-3,9	4,0	75	19	47	6
*SAN07080040	4,0	4,0	75	19	47	6
*SAN0708 ...	4,1-4,2	4,0	75	19	47	6
*SAN0708 ...	4,3-4,4	4,5	80	21	51	6
*SAN07080045	4,5	4,5	80	21	51	6
*SAN0708 ...	4,6-4,7	4,5	80	21	51	6
*SAN0708 ...	4,8-4,9	5,0	86	23	56	6
*SAN07080050	5,0	5,0	86	23	56	6
*SAN07080051	5,1	5,0	86	23	56	6
SAN0708 ...	5,2-5,4	5,0	93	26	58	6
SAN07080055	5,5	5,0	93	26	58	6
SAN07080056	5,6	5,0	93	26	58	6
SAN0708 ...	5,7-5,9	6,0	93	26	58	6
SAN07080060	6,0	6,0	93	26	58	6
SAN07080061	6,1	6,0	93	26	58	6
SAN0708 ...	6,2-6,4	6,0	101	28	63	6
SAN07080065	6,5	6,0	101	28	63	6
SAN0708 ...	6,6-6,7	6,0	101	28	63	6
SAN0708 ...	6,8-6,9	7,0	109	31	71	6
SAN07080070	7,0	7,0	109	31	71	6
SAN0708 ...	7,1-7,4	7,0	109	31	71	6
SAN07080075	7,5	7,0	109	31	71	6
SAN07080076	7,6	7,0	109	31	71	6
SAN0708 ...	7,7-7,9	8,0	117	33	77	6
SAN07080080	8,0	8,0	117	33	77	6
SAN0708 ...	8,1-8,4	8,0	117	33	77	6
SAN07080085	8,5	8,0	117	33	77	6
SAN07080086	8,6	8,0	117	33	77	6

ART.	(mm)					
	ØD	Ød	H	L1	L2	Z
SAN0708 ...	8,7-8,9	9,0	125	36	80	6
SAN07080090	9,0	9,0	125	36	80	6
SAN0708 ...	9,1-9,4	9,0	125	36	80	6
SAN07080095	9,5	9,0	125	36	80	6
SAN07080096	9,6	9,0	125	36	80	6
SAN0708 ...	9,7-9,9	10,0	133	38	85	6
SAN07080100	10,0	10,0	133	38	85	6
SAN0708 ...	10,1-10,4	10,0	133	38	85	6
SAN07080105	10,5	10,0	133	38	85	6
SAN07080106	10,6	10,0	133	38	85	6
SAN0708 ...	10,7-10,9	10,0	142	41	92	6
SAN07080110	11,0	10,0	142	41	92	6
SAN0708 ...	11,1-11,4	10,0	142	41	92	6
SAN07080115	11,5	10,0	142	41	92	6
SAN07080116	11,6	10,0	142	41	92	6
SAN0708 ...	11,7-11,9	12,0	151	44	99	6
SAN07080120	12,0	12,0	151	44	99	6
SAN0708 ...	12,1-12,2	12,0	151	44	99	6
SAN0708 ...	12,3-12,4	12,0	151	44	99	6
SAN07080125	12,5	12,0	151	44	99	6
SAN0708 ...	12,6-12,9	12,0	151	44	99	6
SAN07080130	13,0	12,0	151	44	99	6
SAN0708 ...	13,1-13,6	12,0	151	44	99	6
SAN0708 ...	13,7-13,9	14,0	160	47	105	6
SAN07080140	14,0	14,0	160	47	105	6
SAN0708 ...	14,1-14,2	14,0	160	47	105	6
SAN0708 ...	14,3-14,9	14,0	162	50	107	8
SAN07080150	15,0	14,0	162	50	107	8
SAN0708 ...	15,1-15,6	14,0	162	50	107	8
SAN0708 ...	15,7-15,9	16,0	170	52	115	8
SAN07080160	16,0	16,0	170	52	115	8
SAN0708 ...	16,1-16,2	16,0	170	52	115	8
SAN0708 ...	16,3-16,9	16,0	170	52	115	8
SAN07080170	17,0	16,0	170	52	115	8
SAN0708 ...	17,1-17,2	16,0	170	52	115	8
SAN0708 ...	17,3-17,9	16,0	170	52	115	8
SAN07080180	18,0	16,0	170	52	115	8
SAN0708 ...	18,1-18,2	16,0	170	52	115	8
SAN0708 ...	18,3-18,9	18,0	170	52	115	8
SAN07080190	19,0	18,0	170	52	115	8
SAN0708 ...	19,1-19,2	18,0	170	52	115	8
SAN0708 ...	19,3-19,9	20,0	170	52	115	8
SAN07080200	20,0	20,0	170	52	115	8
SAN0708 ...	20,1-20,2	20,0	170	52	115	8



* CON CENTRINO ESTERNO
 * WITH EXTERNAL CENTERING POINT
 * MIT AUSSENZENTRIERPUNKT
 * AVEC POINT CENTRAL EXTERNE

ESEGUE FORI CON TOLLERANZA H7
 FOR BORES WITH H7 TOLERANCE
 FÜHRT BOHRUNGEN MIT TOLERANZ H7 AUS
 M.D.I. ALESOIR DECIMAL H7

* Nell'ordine inserire sempre il "Ø" scelto dopo il codice dell'alesatore
 * When ordering always indicate the chosen diameter after the reamer code
 * Bei der Bestellung bitte immer den gewählten "Ø" hinter dem Reibahlencode angeben
 * Entrer toujours dans la commande le "Ø" choisi après le code de l'alesoir

EX. Ø = 12,3 COD. = SAN07080123
 EX. Ø = 3,1 COD. = SAN07080031

MATERIALI - MATERIALS Pag. 1199

Applicazione - Application

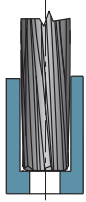

Applicazione - Application	MATERIALI - MATERIALS											ØD (mm)	Vc (m/min)	fn (mm)	n (giri/min (min ⁻¹))	Vf (mm/min)				
	P			M	K			N		S							H	G		
	ACCIAIO NON LEGATO NOT ALLOY STEEL	ACCIAIO POCO LEGATO LOW ALLOY STEEL	ACCIAIO ALTO LEGATO ALLOY STEEL	INOX MARTENSITICO STAINLESS STEEL MART.	INOX AUST. DUPLEX STAINLESS STEEL AUST.	GHISA GRIGIA GREY CAST IRON	GHISA SFEROIDALE SPHEROIDAL GRAPHITE	GHISA MALLEABILE MALLEABLE CAST IRON	ALLUMINIO E SUE LEGHE ALUMINIUM	RAME E SUE LEGHE COPPER	NON METALLICI PLASTICS	LEGHE RESIST. CALORE HIGH TEMP. ALLOY	TITANIO E SUE LEGHE TITANIUM	ACCIAIO TEMPRATO HARDENED STEEL	GRAFITE GRAPHITE					
●																1+5	20-30	0,15	-	-
																5+10	20-30	0,25	-	-
																10+20,2	20-30	0,40	-	-
●																1+5	10-15	0,12	-	-
																5+10	10-15	0,20	-	-
																10+20,2	10-15	0,30	-	-
●																1+5	5-10	0,08	-	-
																5+10	5-10	0,15	-	-
																10+20,2	5-10	0,25	-	-
●																1+5	10-15	0,08	-	-
																5+10	10-15	0,15	-	-
																10+20,2	10-15	0,20	-	-
●																1+5	10-12	0,15	-	-
																5+10	10-12	0,30	-	-
																10+20,2	10-12	0,50	-	-
●																1+5	10-12	0,15	-	-
																5+10	10-12	0,30	-	-
																10+20,2	10-12	0,50	-	-
○																1+5	25-35	0,15	-	-
																5+10	25-35	0,25	-	-
																10+20,2	25-35	0,40	-	-
○																1+5	25-35	0,20	-	-
																5+10	25-35	0,25	-	-
																10+20,2	25-35	0,40	-	-
○																1+5	25-30	0,15	-	-
																5+10	25-30	0,25	-	-
																10+20,2	25-30	0,45	-	-

● APPLICAZIONE CONSIGLIATA-RECOMMENDED APPLICATION
EMPFOLLENER EINSATZ - APPLICATION CONSEILLÉE

○ APPLICAZIONE POSSIBILE - POSSIBLE APPLICATION
MÖGLICHE ANWENDUNG - APPLICATION POSSIBLE

Vc = m/min VELOCITÀ DI TAGLIO - CUTTING SPEED

n = giri/min (min⁻¹) NUMERO DI GIRI - NUMBER OF REVOLUTIONS

fn = mm AVANZAMENTO AL GIRO - FEED / REVOLUTION

Vf = mm/min VELOCITÀ DI AVANZAMENTO - FEED SPEED

$$n = \frac{Vc \cdot 1000}{\text{ØD} \cdot 3,14} = \text{giri/min (min}^{-1}\text{)}$$

$$Vf = fn \cdot n = \text{mm/min}$$

SAN0709

* RIVESTIMENTO A RICHIESTA
 * COATING ON REQUEST

$\varnothing D = 0,90 - 20,20$

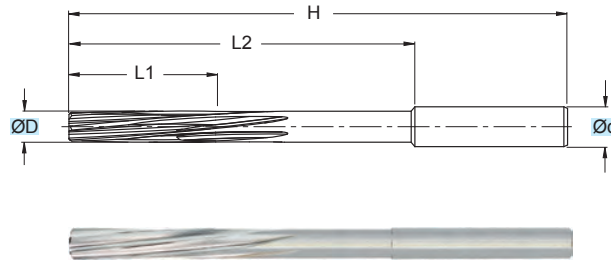

MG

In figura alesatore non rivestito - Uncoated Reamer shown

TOLLERANZE	D	d
TOLLERANCE RANGE	-0/+0,004	h8

ART.	(mm)					
	$\varnothing D$	$\varnothing d$	H	L1	L2	Z
*SAN0709 ...	0,90-0,99	-	40	8	-	4
*SAN0709 ...	1,00-1,50	-	40	8	-	4
*SAN0709 ...	1,51-1,90	-	43	9	-	4
*SAN0709 ...	1,91-2,12	2,0	49	11	26	4
*SAN0709 ...	2,13-2,36	2,0	53	12	-	4
*SAN0709 ...	2,37-2,48	2,3	57	14	-	4
*SAN0709 ...	2,49-2,65	2,5	57	14	-	4
*SAN0709 ...	2,66-2,96	2,5	61	15	-	4
*SAN0709 ...	2,97-3,35	3,0	65	16	40	4
*SAN0709 ...	3,36-3,75	3,5	70	18	45	4
*SAN0709 ...	3,76-4,25	4,0	75	19	47	6
*SAN0709 ...	4,26-4,75	4,5	80	21	51	6
*SAN0709 ...	4,76-5,15	5,0	86	23	56	6
*SAN0709 ...	5,16-5,65	5,0	93	26	58	6
SAN0709 ...	5,66-6,15	6,0	93	26	58	6
SAN0709 ...	6,16-6,70	6,0	101	28	63	6
SAN0709 ...	6,71-7,65	7,0	109	31	71	6
SAN0709 ...	7,66-8,65	8,0	117	33	77	6
SAN0709 ...	8,66-9,65	9,0	125	36	80	6
SAN0709 ...	9,66-10,65	10,0	133	38	85	6
SAN0709 ...	10,66-11,65	10,0	142	41	92	6
SAN0709 ...	11,66-12,20	12,0	151	44	99	6
SAN0709 ...	12,21-13,65	12,0	151	44	99	6
SAN0709 ...	13,66-14,20	14,0	160	47	105	6
SAN0709 ...	14,21-15,65	14,0	162	50	107	8
SAN0709 ...	15,66-16,20	16,0	170	52	115	8
SAN0709 ...	16,21-17,20	16,0	170	52	115	8
SAN0709 ...	17,21-18,20	16,0	170	52	115	8
SAN0709 ...	18,21-19,20	18,0	170	52	115	8
SAN0709 ...	19,21-20,20	20,0	170	52	115	8

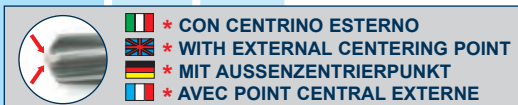

ESEGUE FORI CON TOLLERANZA -0/+0,004
FOR BORES WITH -0/+0,004 TOLERANCE
FÜHRT BOHRUNGEN MIT -0/+0,004 TOLERANZ AUS
EXECUTE TROUS AVEC TOLERANCE -0/+0,004

* Nell'ordine inserire sempre il "Ø" scelto dopo il codice dell'alesatore
 * When ordering always indicate the chosen diameter after the reamer code
 * Bei der Bestellung bitte immer den gewählten "Ø" hinter dem Reibahlencode angeben
 * Entrer toujours dans la commande le "Ø" choisi après le code de l'alesoir

EX. $\varnothing = 10,66$ COD. = **SAN07091066**
 EX. $\varnothing = 1,00$ COD. = **SAN07090100**

* Per ordinare alesatori rivestiti sostituire al codice art. la "N" con una "R"
 * To order coated reamers, replace the article code "N" with "R."
 * Um beschichtete Reibahlen zu bestellen, ersetzen Sie den Artikelcode "N" durch ein "R".
 * Pour commander des alésoirs revêtus, remplacez le numéro d'article "N" par un "R".

EX. $\varnothing = 10,66$ COD. = **SAR07091066**
 EX. $\varnothing = 1,00$ COD. = **SAR07090100**

MATERIALI - MATERIALS Pag. 1199

Applicazione - Application

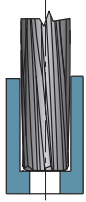

	MATERIALI - MATERIALS											ØD (mm)	Vc (m/min)	fn (mm)	n (giri/min) (min ⁻¹)	Vf (mm/min)				
	P			M	K			N		S							H	G		
	ACCIAIO NON LEGATO NOT ALLOY STEEL	ACCIAIO POCO LEGATO LOW ALLOY STEEL	ACCIAIO ALTO LEGATO ALLOY STEEL	INOX MARTENSITICO STAINLESS STEEL MART.	INOX AUST. DUPLEX STAINLESS STEEL AUST.	GHISA GRIGIA GREY CAST IRON	GHISA SFEROIDALE SPHEROIDAL GRAPHITE	GHISA MALLEABILE MALLEABLE CAST IRON	ALLUMINIO E SUE LEGHE ALUMINIUM	RAME E SUE LEGHE COPPER	NON METALLICI PLASTICS	LEGHE RESIST. CALORE HIGH TEMP. ALLOY	TITANIO E SUE LEGHE TITANIUM	ACCIAIO TEMPRATO HARDENED STEEL	GRAFITE GRAPHITE					
●																0,90+5	20-30	0,15	-	-
●																5+10	20-30	0,25	-	-
●																10+20,2	20-30	0,40	-	-
●																0,90+5	10-15	0,12	-	-
●																5+10	10-15	0,20	-	-
●																10+20,2	10-15	0,30	-	-
●																0,90+5	5-10	0,08	-	-
●																5+10	5-10	0,15	-	-
●																10+20,2	5-10	0,25	-	-
●																0,90+5	10-15	0,08	-	-
●																5+10	10-15	0,15	-	-
●																10+20,2	10-15	0,20	-	-
●																0,90+5	10-12	0,15	-	-
●																5+10	10-12	0,30	-	-
●																10+20,2	10-12	0,50	-	-
●																0,90+5	10-12	0,15	-	-
●																5+10	10-12	0,30	-	-
●																10+20,2	10-12	0,50	-	-
●																0,90+5	25-35	0,15	-	-
●																5+10	25-35	0,25	-	-
●																10+20,2	25-35	0,40	-	-
●																0,90+5	25-35	0,20	-	-
●																5+10	25-35	0,25	-	-
●																10+20,2	25-35	0,40	-	-
●																0,90+5	25-30	0,15	-	-
●																5+10	25-30	0,25	-	-
●																10+20,2	25-30	0,45	-	-

● APPLICAZIONE CONSIGLIATA-RECOMMENDED APPLICATION
EMPFOLLENER EINSATZ - APPLICATION CONSEILLÉE

○ APPLICAZIONE POSSIBILE - POSSIBLE APPLICATION
MÖGLICHE ANWENDUNG - APPLICATION POSSIBLE

Vc = m/min VELOCITÀ DI TAGLIO - CUTTING SPEED

n = giri/min (min⁻¹) NUMERO DI GIRI - NUMBER OF REVOLUTIONS

fn = mm AVANZAMENTO AL GIRO - FEED / REVOLUTION

Vf = mm/min VELOCITÀ DI AVANZAMENTO - FEED SPEED

$$n = \frac{Vc \cdot 1000}{\text{ØD} \cdot 3,14} = \text{giri/min (min}^{-1}\text{)}$$

$$Vf = fn \cdot n = \text{mm/min}$$

SAN0808

$\varnothing D = 1,5 - 12,2$

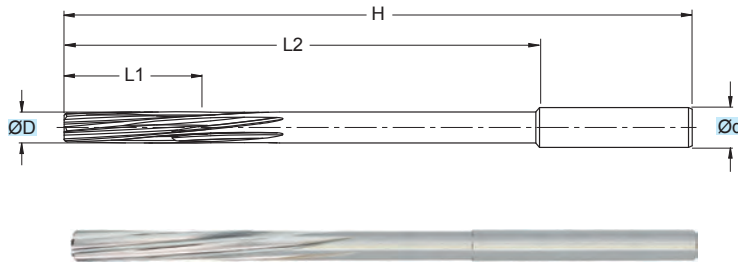

MG

In figura alesatore non rivestito - Uncoated Reamer shown

TOLLERANZE	D	d
TOLLERANCE RANGE	H7	h8

ART.	(mm)					
	$\varnothing D$	$\varnothing d$	H	L1	L2	Z
*SAN08080015	1,5	1,5	110	18	65	4
*SAN08080020	2,0	2,0	110	18	65	4
*SAN0808 ...	2,1-2,3	2,0	110	18	65	4
*SAN08080024	2,4	2,3	120	20	65	4
*SAN08080025	2,5	2,5	120	20	65	4
*SAN0808 ...	2,6-2,9	2,5	120	20	65	4
*SAN08080030	3,0	3,0	120	20	65	4
*SAN08080031	3,1	3,0	120	20	65	4
*SAN0808 ...	3,2-3,3	3,0	150	30	90	4
*SAN08080034	3,4	3,5	150	30	90	4
*SAN08080035	3,5	3,5	150	30	90	4
*SAN0808 ...	3,6-3,9	3,5	150	30	90	4
*SAN08080040	4,0	4,0	150	30	90	6
*SAN0808 ...	4,1-4,2	4,0	150	30	90	6
*SAN0808 ...	4,3-4,4	4,0	180	35	115	6
*SAN08080045	4,5	4,0	180	35	115	6
*SAN0808 ...	4,6-4,9	4,0	180	35	115	6
*SAN08080050	5,0	5,0	180	35	115	6
*SAN08080051	5,1	5,0	180	35	115	6
*SAN0808 ...	5,2-5,4	5,0	200	40	130	6
*SAN08080055	5,5	5,0	200	40	130	6
*SAN0808 ...	5,6-5,9	5,0	200	40	130	6
*SAN08080060	6,0	6,0	200	40	130	6
*SAN08080061	6,1	6,0	200	40	130	6
*SAN0808 ...	6,2-6,4	6,0	200	45	130	6
*SAN08080065	6,5	6,0	200	45	130	6
*SAN0808 ...	6,6-6,9	6,0	200	45	130	6
*SAN08080070	7,0	7,0	200	45	130	6
*SAN08080071	7,1	7,0	200	45	130	6
*SAN0808 ...	7,2-7,4	7,0	200	45	130	6
*SAN08080075	7,5	7,0	200	45	130	6
*SAN0808 ...	7,6-7,9	7,0	200	45	130	6
*SAN08080080	8,0	8,0	200	45	130	6
SAN08080081	8,1	8,0	200	45	130	6

ART.	(mm)					
	$\varnothing D$	$\varnothing d$	H	L1	L2	Z
SAN0808 ...	8,2-8,4	8,0	220	50	145	6
SAN08080085	8,5	8,0	220	50	145	6
SAN0808 ...	8,6-8,9	8,0	220	50	145	6
SAN08080090	9,0	9,0	220	50	145	6
SAN08080091	9,1	9,0	220	50	145	6
SAN0808 ...	9,2-9,4	9,0	220	50	145	6
SAN08080095	9,5	9,0	220	50	145	6
SAN0808 ...	9,6-9,9	9,0	220	50	145	6
SAN08080100	10,0	10,0	220	50	145	6
SAN0808 ...	10,1-10,2	10,0	220	50	145	6
SAN0808 ...	10,3-10,4	10,0	250	55	170	6
SAN08080105	10,5	10,0	250	55	170	6
SAN0808 ...	10,6-10,7	10,0	250	55	170	6
SAN0808 ...	10,8-10,9	11,0	250	55	170	6
SAN08080110	11,0	11,0	250	55	170	6
SAN0808 ...	11,1-11,2	11,0	250	55	170	6
SAN0808 ...	11,3-11,4	11,0	250	55	170	6
SAN08080115	11,5	11,0	250	55	170	6
SAN0808 ...	11,6-11,7	11,0	250	55	170	6
SAN0808 ...	11,8-11,9	12,0	250	55	170	6
SAN08080120	12,0	12,0	250	55	170	6
SAN0808 ...	12,1-12,2	12,0	250	55	170	6

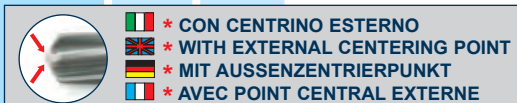

- * CON CENTRINO ESTERNO
- * WITH EXTERNAL CENTERING POINT
- * MIT AUSSENZENTRIERPUNKT
- * AVEC POINT CENTRAL EXTERNE

- ESEGUE FORI CON TOLLERANZA H7
- FOR BORES WITH H7 TOLERANCE
- FÜHRT BOHRUNGEN MIT TOLERANZ H7 AUS
- M.D.I. ALESOIR DECIMAL H7

* Nell'ordine inserire sempre il "Ø" scelto dopo il codice dell'alesatore
 * When ordering always indicate the chosen diameter after the reamer code
 * Bei der Bestellung bitte immer den gewählten "Ø" hinter dem Reibahlencode angeben
 * Entrer toujours dans la commande le "Ø" choisi après le code de l'alesoir

EX. $\varnothing = 11,3$ COD. = SAN08080113
 EX. $\varnothing = 2,6$ COD. = SAN08080026

MATERIALI - MATERIALS Pag. 1199

Applicazione - Application

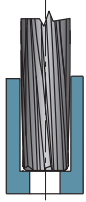

P	M	K			N		S		H	G	ØD	Vc	fn	n	Vf
		GHISA GRIGIA	GHISA SFEROIDALE	GHISA MALLEABILE	ALLUMINIO E SUE LEGHE	RAME E SUE LEGHE	NON METALLICI	LEGHE RESIST. CALORE							
●											1+5	20-30	0,15	-	-
●											5+10	20-30	0,25	-	-
●											10+20	20-30	0,40	-	-
●											1+5	10-15	0,12	-	-
●											5+10	10-15	0,20	-	-
●											10+20	10-15	0,30	-	-
●											1+5	5-10	0,08	-	-
●											5+10	5-10	0,15	-	-
●											10+20	5-10	0,25	-	-
			●								1+5	10-15	0,08	-	-
			●								5+10	10-15	0,15	-	-
			●								10+20	10-15	0,20	-	-
				●							1+5	10-12	0,15	-	-
				●							5+10	10-12	0,30	-	-
				●							10+20	10-12	0,50	-	-
							●				1+5	25-35	0,15	-	-
							●				5+10	25-35	0,25	-	-
							●				10+20	25-35	0,40	-	-
								●			1+5	25-35	0,20	-	-
								●			5+10	25-35	0,25	-	-
								●			10+20	25-35	0,40	-	-
									●		1+5	25-30	0,15	-	-
									●		5+10	25-30	0,25	-	-
									●		10+20	25-30	0,45	-	-

● APPLICAZIONE CONSIGLIATA-RECOMMENDED APPLICATION
EMPFOLLENER EINSATZ - APPLICATION CONSEILLÉE

○ APPLICAZIONE POSSIBILE - POSSIBLE APPLICATION
MÖGLICHE ANWENDUNG - APPLICATION POSSIBLE

Vc = m/min VELOCITÀ DI TAGLIO - CUTTING SPEED

n = giri/min (min⁻¹) NUMERO DI GIRI - NUMBER OF REVOLUTIONS

fn = mm AVANZAMENTO AL GIRO - FEED / REVOLUTION

Vf = mm/min VELOCITÀ DI AVANZAMENTO - FEED SPEED

$$n = \frac{Vc \cdot 1000}{\text{ØD} \cdot 3,14} = \text{giri/min (min}^{-1}\text{)}$$

$$Vf = fn \cdot n = \text{mm/min}$$

SAN0809

$\varnothing D = 2,00 - 12,20$

* RIVESTIMENTO A RICHIESTA
 * COATING ON REQUEST



MG

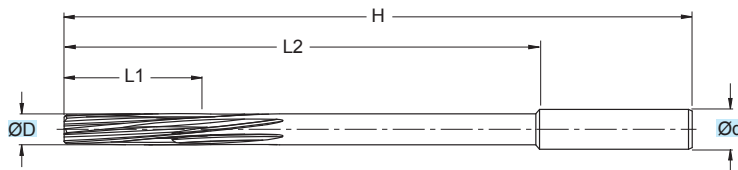

In figura alesatore non rivestito - Uncoated Reamer shown

TOLLERANZE	D	d
TOLLERANCE RANGE	-0/+0,004	h8

ART.	(mm)					
	$\varnothing D$	$\varnothing d$	H	L1	L2	Z
*SAN0809 ...	2,00-2,31	2,0	110	18	65	4
*SAN0809 ...	2,32-2,41	2,3	120	20	65	4
*SAN0809 ...	2,42-2,91	2,5	120	20	65	4
*SAN0809 ...	2,92-3,11	3,0	120	20	65	4
*SAN0809 ...	3,12-3,31	3,0	150	30	90	4
*SAN0809 ...	3,32-3,91	3,5	150	30	90	4
*SAN0809 ...	3,92-4,24	4,0	150	30	90	6
*SAN0809 ...	4,25-4,91	4,0	180	35	115	6
*SAN0809 ...	4,92-5,11	5,0	180	35	115	6
*SAN0809 ...	5,12-5,91	5,0	200	40	130	6
*SAN0809 ...	5,92-6,11	6,0	200	40	130	6
*SAN0809 ...	6,12-6,91	6,0	200	45	130	6
*SAN0809 ...	6,92-7,11	7,0	200	45	130	6
*SAN0809 ...	7,12-7,91	7,0	200	45	130	6
*SAN0809 ...	7,92-8,11	8,0	200	45	130	6
*SAN0809 ...	8,12-8,91	8,0	220	50	145	6
*SAN0809 ...	8,92-9,11	9,0	220	50	145	6
*SAN0809 ...	9,12-9,91	9,0	220	50	145	6
SAN0809 ...	9,92-10,20	10,0	220	50	145	6
SAN0809 ...	10,21-10,80	10,0	250	55	170	6
SAN0809 ...	10,81-11,20	11,0	250	55	170	6
SAN0809 ...	11,21-11,80	11,0	250	55	170	6
SAN0809 ...	11,81-12,20	12,0	250	55	170	6

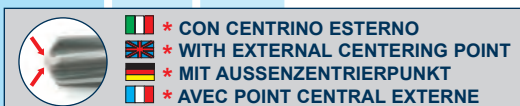

* Nell'ordine inserire sempre il "Ø" scelto dopo il codice dell'alesatore
 * When ordering always indicate the chosen diameter after the reamer code
 * Bei der Bestellung bitte immer den gewählten "Ø" hinter dem Reibahlencode angeben
 * Entrer toujours dans la commande le "Ø" choisi après le code de l'alesoir

EX. $\varnothing = 10,21$ COD. = **SAN08091021**
 EX. $\varnothing = 2,00$ COD. = **SAN08090200**

* Per ordinare alesatori rivestiti sostituire al codice art. la "N" con una "R"
 * To order coated reamers, replace the article code "N" with "R."
 * Um beschichtete Reibahlen zu bestellen, ersetzen Sie den Artikelcode "N" durch ein "R".
 * Pour commander des alésoirs revêtus, remplacez le numéro d'article "N" par un "R".

EX. $\varnothing = 10,21$ COD. = **SAR08091021**
 EX. $\varnothing = 2,00$ COD. = **SAR08090200**

MATERIALI - MATERIALS Pag. 1199

Applicazione - Application

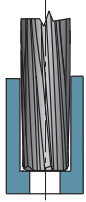

Applicazione - Application	MATERIALI - MATERIALS											ØD	Vc	fn	n (giri/min) (min ⁻¹)	Vf (mm/min)				
	P	M	K			N		S		H	G									
	ACCIAIO NON LEGATO NOT ALLOY STEEL	ACCIAIO POCO LEGATO LOW ALLOY STEEL	ACCIAIO ALTO LEGATO ALLOY STEEL	INOX MARTENSITICO STAINLESS STEEL MART.	INOX AUST. DUPLEX STAINLESS STEEL AUST.	GHISA GRIGIA GREY CAST IRON	GHISA SFEROIDALE SPHEROIDAL GRAPHITE	GHISA MALLEABILE MALLEABLE CAST IRON	ALLUMINIO E SUE LEGHE ALUMINIUM	RAME E SUE LEGHE COPPER	NON METALLICI PLASTICS	LEGHE RESIST. CALORE HIGH TEMP. ALLOY	TITANIO E SUE LEGHE TITANIUM	ACCIAIO TEMPRATO HARDENED STEEL	GRAFITE GRAPHITE					
●																1+5	20-30	0,15	-	-
																5+10	20-30	0,25	-	-
																10+20	20-30	0,40	-	-
●																1+5	10-15	0,12	-	-
																5+10	10-15	0,20	-	-
																10+20	10-15	0,30	-	-
●																1+5	5-10	0,08	-	-
																5+10	5-10	0,15	-	-
																10+20	5-10	0,25	-	-
●																1+5	10-15	0,08	-	-
																5+10	10-15	0,15	-	-
																10+20	10-15	0,20	-	-
●																1+5	10-12	0,15	-	-
																5+10	10-12	0,30	-	-
																10+20	10-12	0,50	-	-
●																1+5	10-12	0,15	-	-
																5+10	10-12	0,30	-	-
																10+20	10-12	0,50	-	-
○																1+5	25-35	0,15	-	-
																5+10	25-35	0,25	-	-
																10+20	25-35	0,40	-	-
○																1+5	25-35	0,20	-	-
																5+10	25-35	0,25	-	-
																10+20	25-35	0,40	-	-
○																1+5	25-30	0,15	-	-
																5+10	25-30	0,25	-	-
																10+20	25-30	0,45	-	-

● APPLICAZIONE CONSIGLIATA-RECOMMENDED APPLICATION
EMPFOLLENER EINSATZ - APPLICATION CONSEILLÉE

○ APPLICAZIONE POSSIBILE - POSSIBLE APPLICATION
MÖGLICHE ANWENDUNG - APPLICATION POSSIBLE

Vc = m/min VELOCITÀ DI TAGLIO - CUTTING SPEED

n = giri/min (min⁻¹) NUMERO DI GIRI - NUMBER OF REVOLUTIONS

fn = mm AVANZAMENTO AL GIRO - FEED / REVOLUTION

Vf = mm/min VELOCITÀ DI AVANZAMENTO - FEED SPEED

$$n = \frac{Vc \cdot 1000}{\text{ØD} \cdot 3,14} = \text{giri/min (min}^{-1}\text{)}$$

$$Vf = fn \cdot n = \text{mm/min}$$

SAN0308

ØD = 12 - 25

NEW

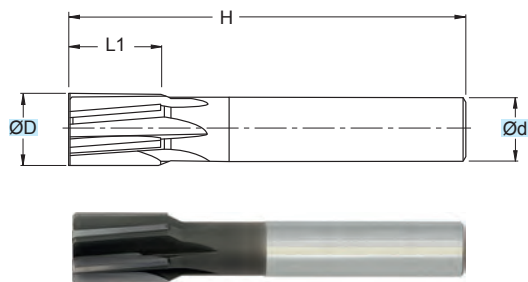

MG

TOLLERANZE	D	d
TOLLERANCE RANGE	H7	h8

ART.	(mm)				
	ØD	Ød	H	L1	Z
SAN0308120	12	10,0	80	20	6
SAN0308130	13	10,0	80	20	6
SAN0308140	14	12,5	90	20	6
SAN0308150	15	12,5	90	20	6
SAN0308160	16	12,5	90	25	6
SAN0308170	17	12,5	90	25	6
SAN0308180	18	16,0	100	25	6
SAN0308190	19	16,0	100	25	6
SAN0308200	20	16,0	100	25	6
SAN0308220	22	16,0	100	25	6
SAN0308240	24	20,0	100	25	6
SAN0308250	25	20,0	100	25	6



MATERIALI - MATERIALS Pag. 1199

Applicazione - Application

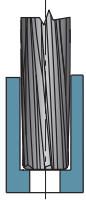

Applicazione - Application	MATERIALI - MATERIALS											ØD (mm)	Vc (m/min)	fn (mm)	n (giri/min (min ⁻¹))	Vf (mm/min)					
	P	M	K			N		S		H	G										
	ACCIAIO NON LEGATO NOT ALLOY STEEL	ACCIAIO POCO LEGATO LOW ALLOY STEEL	ACCIAIO ALTO LEGATO ALLOY STEEL	INOX MARTENSITICO STAINLESS STEEL MART.	INOX AUST. DUPLEX STAINLESS STEEL AUST.	GHISA GRIGIA GREY CAST IRON	GHISA SFEROIDALE SPHEROIDAL GRAPHITE	GHISA MALLEABILE MALLEABLE CAST IRON	ALLUMINIO E SUE LEGHE ALUMINIUM	RAME E SUE LEGHE COPPER	NON METALLICI PLASTICS	LEGHE RESIST. CALORE HIGH TEMP. ALLOY	TITANIO E SUE LEGHE TITANIUM	ACCIAIO TEMPRATO HARDENED STEEL	GRAFITE GRAPHITE						
●																12-15	15-25	0,30	-	-	
●																15-20	15-25	0,35	-	-	
●																20-25	15-25	0,40	-	-	
		●														12-15	10-20	0,20	-	-	
		●														15-20	10-20	0,25	-	-	
		●														20-25	10-20	0,30	-	-	
			●													12-15	5-12	0,10	-	-	
			●													15-20	5-12	0,15	-	-	
			●													20-25	5-12	0,20	-	-	
				●												12-15	5-12	0,15	-	-	
				●												15-20	5-12	0,20	-	-	
				●												20-25	5-12	0,25	-	-	
						●										12-15	8-10	0,25	-	-	
						●										15-20	8-10	0,30	-	-	
						●										20-25	8-10	0,40	-	-	
							●									12-15	5-10	0,20	-	-	
							●									15-20	5-10	0,25	-	-	
							●									20-25	5-10	0,35	-	-	
								●								12-15	15-20	0,30	-	-	
								●								15-20	15-20	0,35	-	-	
								●								20-25	15-20	0,40	-	-	
									●							12-15	15-20	0,30	-	-	
									●							15-20	15-20	0,35	-	-	
									●							20-25	15-20	0,40	-	-	

● APPLICAZIONE CONSIGLIATA-RECOMMENDED APPLICATION
EMPFÖHLENER EINSATZ - APPLICATION CONSEILLÉE

○ APPLICAZIONE POSSIBILE - POSSIBLE APPLICATION
MÖGLICHE ANWENDUNG - APPLICATION POSSIBLE

Vc = m/min VELOCITÀ DI TAGLIO - CUTTING SPEED

n = giri/min (min⁻¹) NUMERO DI GIRI - NUMBER OF REVOLUTIONS

fn = mm AVANZAMENTO AL GIRO - FEED / REVOLUTION

Vf = mm/min VELOCITÀ DI AVANZAMENTO - FEED SPEED

$$n = \frac{Vc \cdot 1000}{\text{ØD} \cdot 3,14} = \text{giri/min (min}^{-1}\text{)}$$

$$Vf = fn \cdot n = \text{mm/min}$$

SAN0309

ØD = 12,00-25,21 **NEW**

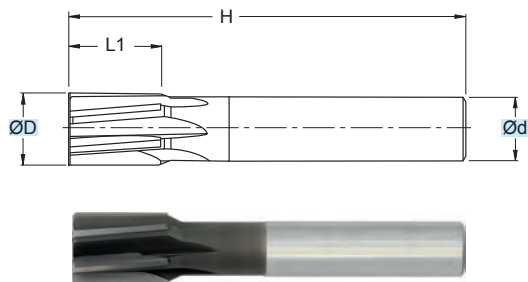

MG

TOLLERANZE	D	d
TOLLERANCE RANGE	-0/+0,004	h8

(mm)					
ART.	ØD	Ød	H	L1	Z
SAN0309 ...	12,00-12,21	10,0	80	20	6
SAN0309 ...	12,22-13,21	10,0	80	20	6
SAN0309 ...	13,22-14,21	12,5	90	20	6
SAN0309 ...	14,22-15,21	12,5	90	20	6
SAN0309 ...	15,22-16,21	12,5	90	25	6
SAN0309 ...	16,22-17,21	12,5	90	25	6
SAN0309 ...	17,22-18,21	16,0	100	25	6
SAN0309 ...	18,22-19,21	16,0	100	25	6
SAN0309 ...	19,22-20,21	16,0	100	25	6
SAN0309 ...	20,22-22,21	16,0	100	25	6
SAN0309 ...	22,22-24,21	20,0	100	25	6
SAN0309 ...	24,22-25,21	20,0	100	25	6

ESEGUE FORI CON TOLLERANZA -0/+0,004
 FOR BORES WITH -0/+0,004 TOLERANCE
 FÜHRT BOHRUNGEN MIT -0/+0,004 TOLERANZ AUS
 EXECUTE TROUS AVEC TOLERANCE -0/+0,004

* Nell'ordine inserire sempre il "Ø" scelto dopo il codice dell'alesatore
 * When ordering always indicate the chosen diameter after the reamer code
 * Bei der Bestellung bitte immer den gewählten "Ø" hinter dem Reibahlencode angeben
 * Entrer toujours dans la commande le "Ø" choisi après le code de l'alesoir

EX. Ø = 13,21 COD. = **SAN03091321**
 EX. Ø = 18,25 COD. = **SAN03091825**

MATERIALI - MATERIALS Pag. 1199

Applicazione - Application

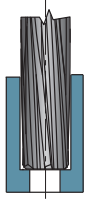

Applicazione - Application	MATERIALI - MATERIALS											ØD (mm)	Vc (m/min)	fn (mm)	n (giri/min (min ⁻¹))	Vf (mm/min)				
	P	M	K		N		S		H	G										
	ACCIAIO NON LEGATO NOT ALLOY STEEL	ACCIAIO POCO LEGATO LOW ALLOY STEEL	ACCIAIO ALTO LEGATO ALLOY STEEL	INOX MARTENSITICO STAINLESS STEEL MART.	INOX AUST. DUPLEX STAINLESS STEEL AUST.	GHISA GRIGIA GREY CAST IRON	GHISA FERROIDALE SPHEROIDAL GRAPHITE	GHISA MALLEABILE MALLEABLE CAST IRON	ALLUMINIO E SUE LEGHE ALUMINIUM	RAMIE E SUE LEGHE COPPER	NON METALLICI PLASTICS	LEGHE RESIST. CALORE HIGH TEMP. ALLOY	TITANIO E SUE LEGHE TITANIUM	ACCIAIO TEMPRATO HARDENED STEEL	GRAFITE GRAPHITE					
●																12-15	15-25	0,30	-	-
●																15-20	15-25	0,35	-	-
●																20-25	15-25	0,40	-	-
			●													12-15	10-20	0,20	-	-
			●													15-20	10-20	0,25	-	-
			●													20-25	10-20	0,30	-	-
			●													12-15	5-12	0,10	-	-
			●													15-20	5-12	0,15	-	-
			●													20-25	5-12	0,20	-	-
				●												12-15	5-12	0,15	-	-
				●												15-20	5-12	0,20	-	-
				●												20-25	5-12	0,25	-	-
						●										12-15	8-10	0,25	-	-
						●										15-20	8-10	0,30	-	-
						●										20-25	8-10	0,40	-	-
							●									12-15	5-10	0,20	-	-
							●									15-20	5-10	0,25	-	-
							●									20-25	5-10	0,35	-	-
									●							12-15	15-20	0,30	-	-
									●							15-20	15-20	0,35	-	-
									●							20-25	15-20	0,40	-	-
										●						12-15	15-20	0,30	-	-
										●						15-20	15-20	0,35	-	-
										●						20-25	15-20	0,40	-	-

● APPLICAZIONE CONSIGLIATA-RECOMMENDED APPLICATION
EMPFÖHLENER EINSATZ - APPLICATION CONSEILLÉE

○ APPLICAZIONE POSSIBILE - POSSIBLE APPLICATION
MÖGLICHE ANWENDUNG - APPLICATION POSSIBLE

Vc = m/min VELOCITÀ DI TAGLIO - CUTTING SPEED

n = giri/min (min⁻¹) NUMERO DI GIRI - NUMBER OF REVOLUTIONS

fn = mm AVANZAMENTO AL GIRO - FEED / REVOLUTION

Vf = mm/min VELOCITÀ DI AVANZAMENTO - FEED SPEED

$$n = \frac{Vc \cdot 1000}{\text{ØD} \cdot 3,14} = \text{giri/min (min}^{-1}\text{)}$$

$$Vf = fn \cdot n = \text{mm/min}$$

SAN0408

ØD = 6 - 25

NEW

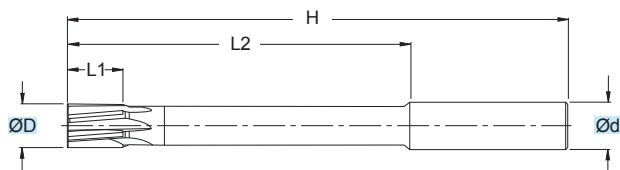

MG

TOLLERANZE	D	d
TOLLERANCE RANGE	H7	h8

ART.	(mm)					
ART.	ØD	Ød	H	L1	L2	Z
SAN0408060	6	6	100	12	70	4
SAN0408070	7	8	100	16	70	4
SAN0408080	8	8	118	16	85	4
SAN0408090	9	10	125	20	85	4
SAN0408100	10	10	132	20	90	4
SAN0408110	11	12	132	20	90	4
SAN0408120	12	12	150	20	100	6
SAN0408130	13	14	160	20	110	6
SAN0408140	14	14	170	20	115	6
SAN0408150	15	16	170	20	115	6
SAN0408160	16	16	180	25	120	6
SAN0408170	17	18	190	25	130	6
SAN0408180	18	18	190	25	130	6
SAN0408190	19	20	200	25	130	6
SAN0408200	20	20	200	25	130	6
SAN0408220	22	20	200	25	130	6
SAN0408240	24	20	200	25	130	6
SAN0408250	25	20	200	25	130	6



Applicazione - Application

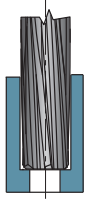

Applicazione - Application	MATERIALI - MATERIALS											ØD	Vc	fn	n	Vf				
	P	M	K		N		S		H	G										
	ACCIAIO NON LEGATO NOT ALLOY STEEL	ACCIAIO POCO LEGATO LOW ALLOY STEEL	ACCIAIO ALTO LEGATO ALLOY STEEL	INOX MARTENSITICO STAINLESS STEEL MART.	INOX AUST. DUPLEX STAINLESS STEEL AUST.	GHISA GRIGIA GREY CAST IRON	GHISA FERROIDALE SPHEROIDAL GRAPHITE	GHISA MALLEABILE MALLEABLE CAST IRON	ALLUMINIO E SUE LEGHE ALUMINIUM	RAMIE E SUE LEGHE COPPER	NON METALLICI PLASTICS	LEGHE RESIST. CALORE HIGH TEMP. ALLOY	TITANIO E SUE LEGHE TITANIUM	ACCIAIO TEMPRATO HARDENED STEEL	GRAFITE GRAPHITE	(mm)	(m/min)	(mm)	(giri/min) n	(mm/min)
●																6-10	15-25	0,25	-	-
																10-15	15-25	0,30	-	-
																15-20	15-25	0,35	-	-
																20-25	15-25	0,40	-	-
●																6-10	10-20	0,15	-	-
																10-15	10-20	0,20	-	-
																15-20	10-20	0,25	-	-
																20-25	10-20	0,30	-	-
●																6-10	5-12	0,07	-	-
																10-15	5-12	0,10	-	-
																15-20	5-12	0,15	-	-
																20-25	5-12	0,20	-	-
●																6-10	5-12	0,10	-	-
																10-15	5-12	0,15	-	-
																15-20	5-12	0,20	-	-
																20-25	5-12	0,25	-	-
●																6-10	8-10	0,20	-	-
																10-15	8-10	0,25	-	-
																15-20	8-10	0,30	-	-
																20-25	8-10	0,40	-	-
●																6-10	5-10	0,15	-	-
																10-15	5-10	0,20	-	-
																15-20	5-10	0,25	-	-
																20-25	5-10	0,35	-	-
●																6-10	15-20	0,25	-	-
																10-15	15-20	0,30	-	-
																15-20	15-20	0,35	-	-
																20-25	15-20	0,40	-	-
●																6-10	15-25	0,25	-	-
																10-15	15-25	0,30	-	-
																15-20	15-25	0,35	-	-
																20-25	15-25	0,40	-	-
●																6-10	15-20	0,30	-	-
																10-15	15-20	0,35	-	-
																15-20	15-20	0,40	-	-
																20-25	15-20	0,45	-	-

● APPLICAZIONE CONSIGLIATA-RECOMMENDED APPLICATION
EMPFOLLENER EINSATZ - APPLICATION CONSEILLÉE

○ APPLICAZIONE POSSIBILE - POSSIBLE APPLICATION
MÖGLICHE ANWENDUNG - APPLICATION POSSIBLE

Vc = m/min VELOCITÀ DI TAGLIO - CUTTING SPEED

n = giri/min (min⁻¹) NUMERO DI GIRI - NUMBER OF REVOLUTIONS

fn = mm AVANZAMENTO AL GIRO - FEED / REVOLUTION

Vf = mm/min VELOCITÀ DI AVANZAMENTO - FEED SPEED

$$n = \frac{Vc \cdot 1000}{\text{ØD} \cdot 3,14} = \text{giri/min (min}^{-1}\text{)}$$

$$Vf = fn \cdot n = \text{mm/min}$$

SAN0409

ØD = 12,00-25,21 **NEW**

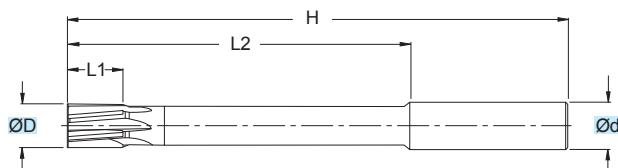

MG

TOLLERANZE	D	d
TOLLERANCE RANGE	-0/+0,004	h8

(mm)						
ART.	ØD	Ød	H	L1	L2	Z
SAN0409 ...	5,90-6,21	6	100	12	70	4
SAN0409 ...	6,22-7,21	8	100	16	70	4
SAN0409 ...	7,22-8,21	8	118	16	85	4
SAN0409 ...	8,22-9,21	10	125	20	85	4
SAN0409 ...	9,22-10,21	10	132	20	90	4
SAN0409 ...	10,22-11,21	12	132	20	90	4
SAN0409 ...	11,22-12,21	12	150	20	100	6
SAN0409 ...	12,22-13,21	14	160	20	110	6
SAN0409 ...	13,22-14,21	14	170	20	115	6
SAN0409 ...	14,22-15,21	16	170	20	115	6
SAN0409 ...	15,22-16,21	16	180	25	120	6
SAN0409 ...	16,22-17,21	18	190	25	130	6
SAN0409 ...	17,22-18,21	18	190	25	130	6
SAN0409 ...	18,22-19,21	20	200	25	130	6
SAN0409 ...	19,22-20,21	20	200	25	130	6
SAN0409 ...	20,22-22,21	20	200	25	130	6
SAN0409 ...	22,22-24,21	20	200	25	130	6
SAN0409 ...	24,22-25,21	20	200	25	130	6

ESEGUE FORI CON TOLLERANZA -0/+0,004
 FOR BORES WITH -0/+0,004 TOLERANCE
 FÜHRT BOHRUNGEN MIT -0/+0,004 TOLERANZ AUS
 EXECUTE TROUS AVEC TOLERANCE -0/+0,004

* Nell'ordine inserire sempre il "Ø" scelto dopo il codice dell'alesatore
 * When ordering always indicate the chosen diameter after the reamer code
 * Bei der Bestellung bitte immer den gewählten "Ø" hinter dem Reibahlencode angeben
 * Entrer toujours dans la commande le "Ø" choisi après le code de l'alesoir

EX. Ø = 13,21 COD. = **SAN04091321**
 EX. Ø = 18,25 COD. = **SAN04091825**



MATERIALI - MATERIALS Pag. 1199

Applicazione - Application

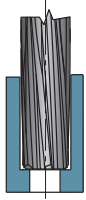

P	M	K	N	S	H	G	ØD	Vc	fn	n	Vf
●							5,90-10	15-25	0,25	-	-
●							10-15	15-25	0,30	-	-
●							15-20	15-25	0,35	-	-
●							20-25,21	15-25	0,40	-	-
●							5,90-10	10-20	0,15	-	-
●							10-15	10-20	0,20	-	-
●							15-20	10-20	0,25	-	-
●							20-25,21	10-20	0,30	-	-
●							5,90-10	5-12	0,07	-	-
●							10-15	5-12	0,10	-	-
●							15-20	5-12	0,15	-	-
●							20-25,21	5-12	0,20	-	-
●							5,90-10	5-12	0,10	-	-
●							10-15	5-12	0,15	-	-
●							15-20	5-12	0,20	-	-
●							20-25,21	5-12	0,25	-	-
●							5,90-10	8-10	0,20	-	-
●							10-15	8-10	0,25	-	-
●							15-20	8-10	0,30	-	-
●							20-25,21	8-10	0,40	-	-
●							5,90-10	5-10	0,15	-	-
●							10-15	5-10	0,20	-	-
●							15-20	5-10	0,25	-	-
●							20-25,21	5-10	0,35	-	-
●							5,90-10	15-20	0,25	-	-
●							10-15	15-20	0,30	-	-
●							15-20	15-20	0,35	-	-
●							20-25,21	15-20	0,40	-	-
●							5,90-10	15-25	0,25	-	-
●							10-15	15-25	0,30	-	-
●							15-20	15-25	0,35	-	-
●							20-25,21	15-25	0,40	-	-
●							5,90-10	15-20	0,30	-	-
●							10-15	15-20	0,35	-	-
●							15-20	15-20	0,40	-	-
●							20-25,21	15-20	0,45	-	-

● APPLICAZIONE CONSIGLIATA-RECOMMENDED APPLICATION
EMPFÖHLENER EINSATZ - APPLICATION CONSEILLÉE

○ APPLICAZIONE POSSIBILE - POSSIBLE APPLICATION
MÖGLICHE ANWENDUNG - APPLICATION POSSIBLE

Vc = m/min VELOCITÀ DI TAGLIO - CUTTING SPEED

n = giri/min (min⁻¹) NUMERO DI GIRI - NUMBER OF REVOLUTIONS

fn = mm AVANZAMENTO AL GIRO - FEED / REVOLUTION

Vf = mm/min VELOCITÀ DI AVANZAMENTO - FEED SPEED

$$n = \frac{Vc \cdot 1000}{\text{ØD} \cdot 3,14} = \text{giri/min (min}^{-1}\text{)}$$

$$Vf = fn \cdot n = \text{mm/min}$$

SAN0208

$\varnothing D = 1 - 35,2$

RIVESTIMENTO A RICHIESTA
 * COATING ON REQUEST

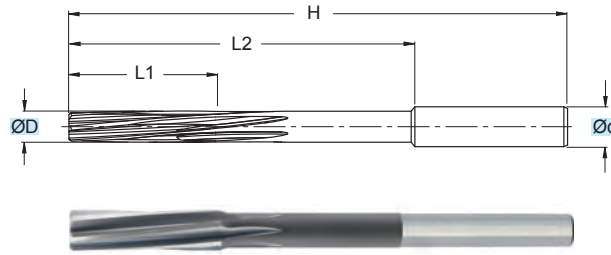

HSSE

- ESEGUE FORI CON TOLLERANZA H7
- FOR BORES WITH H7 TOLERANCE
- FÜHRT BOHRUNGEN MIT TOLERANZ H7 AUS
- M.D.I. ALESOIR DECIMAL H7

TOLLERANZE	D	d
TOLLERANCE RANGE	H7	h8

ART.	(mm)					
	ØD	Ød	H	L1	L2	Z
SAN0208 ...	1,0	1,0	40	8	—	4
SAN0208 ...	1,1-1,4	—	40	8	—	4
SAN0208 ...	1,5	1,5	40	8	—	4
SAN0208 ...	1,6-1,9	—	43	9	—	4
SAN0208 ...	2,0	2,0	49	11	—	4
SAN0208 ...	2,1	2,0	49	11	26	4
SAN0208 ...	2,2-2,3	2,0	53	12	—	4
SAN0208 ...	2,4	2,3	57	14	—	4
SAN0208 ...	2,5	2,5	57	14	—	4
SAN0208 ...	2,6	2,5	57	14	—	4
SAN0208 ...	2,7-2,9	2,5	61	15	—	4
SAN0208 ...	3,0	3,0	65	16	—	4
SAN0208 ...	3,1-3,3	3,0	65	16	40	4
SAN0208 ...	3,4	3,5	70	18	45	4
SAN0208 ...	3,5	3,5	70	18	45	4
SAN0208 ...	3,6-3,7	3,5	70	18	45	4
SAN0208 ...	3,8-3,9	4,0	75	19	47	4
SAN0208 ...	4,0	4,0	75	19	47	6
SAN0208 ...	4,1-4,2	4,0	75	19	47	6
SAN0208 ...	4,3-4,4	4,5	80	21	51	6
SAN0208 ...	4,5	4,5	80	21	51	6
SAN0208 ...	4,6-4,7	4,5	80	21	51	6
SAN0208 ...	4,8-4,9	5,0	86	23	56	6
SAN0208 ...	5,0	5,0	86	23	56	6
SAN0208 ...	5,1	5,0	86	23	56	6
SAN0208 ...	5,2-5,4	5,0	93	26	58	6
SAN0208 ...	5,5	5,0	93	26	58	6
SAN0208 ...	5,6	5,0	93	26	58	6
SAN0208 ...	5,7-5,9	6,0	93	26	58	6
SAN0208 ...	6,0	6,0	93	26	58	6
SAN0208 ...	6,1	6,0	93	26	58	6
SAN0208 ...	6,2-6,4	6,0	101	28	63	6
SAN0208 ...	6,5	6,0	101	28	63	6
SAN0208 ...	6,6-6,7	6,0	101	28	63	6
SAN0208 ...	6,8-6,9	7,0	109	31	71	6
SAN0208 ...	7,0	7,0	109	31	71	6
SAN0208 ...	7,1-7,4	7,0	109	31	71	6
SAN0208 ...	7,5	7,0	109	31	71	6
SAN0208 ...	7,6	7,0	109	31	71	6
SAN0208 ...	7,7-7,9	8,0	117	33	77	6
SAN0208 ...	8,0	8,0	117	33	77	6
SAN0208 ...	8,1-8,4	8,0	117	33	77	6
SAN0208 ...	8,5	8,0	117	33	77	6
SAN0208 ...	8,6	8,0	117	33	77	6
SAN0208 ...	8,7-8,9	9,0	125	36	80	6
SAN0208 ...	9,0	9,0	125	36	80	6
SAN0208 ...	9,1-9,4	9,0	125	36	80	6
SAN0208 ...	9,5	9,0	125	36	80	6
SAN0208 ...	9,6	9,0	125	36	80	6
SAN0208 ...	9,7-9,9	10,0	133	38	85	6
SAN0208 ...	10,0	10,0	133	38	85	6
SAN0208 ...	10,1-10,4	10,0	133	38	85	6
SAN0208 ...	10,5	10,0	133	38	85	6
SAN0208 ...	10,6	10,0	133	38	85	6
SAN0208 ...	10,7-10,9	10,0	142	41	92	6
SAN0208 ...	11,0	10,0	142	41	92	6
SAN0208 ...	11,1-11,4	10,0	142	41	92	6
SAN0208 ...	11,5	10,0	142	41	92	6
SAN0208 ...	11,6-11,8	10,0	142	41	92	6
SAN0208 ...	11,9	10,0	151	44	99	6
SAN0208 ...	12,0	10,0	151	44	99	6
SAN0208 ...	12,1-12,4	10,0	151	44	99	6
SAN0208 ...	12,5	10,0	151	44	99	6
SAN0208 ...	12,6-12,9	10,0	151	44	99	6
SAN0208 ...	13,0	10,0	151	44	99	6

ART.	(mm)					
	ØD	Ød	H	L1	L2	Z
SAN0208 ...	13,1-13,2	10,0	151	44	99	6
SAN0208 ...	13,3-13,4	12,5	160	47	105	6
SAN0208 ...	13,5	12,5	160	47	105	6
SAN0208 ...	13,6-13,9	12,5	160	47	105	6
SAN0208 ...	14,0	12,5	160	47	105	6
SAN0208 ...	14,1	12,5	160	47	105	6
SAN0208 ...	14,2-14,4	12,5	162	50	107	6
SAN0208 ...	14,5	12,5	162	50	107	8
SAN0208 ...	14,6-14,9	12,5	162	50	107	8
SAN0208 ...	15,0	12,5	162	50	107	8
SAN0208 ...	15,1	12,5	162	50	107	8
SAN0208 ...	15,2-15,4	12,5	170	52	115	8
SAN0208 ...	15,5	12,5	170	52	115	8
SAN0208 ...	15,6-15,9	12,5	170	52	115	8
SAN0208 ...	16,0	12,5	170	52	115	8
SAN0208 ...	16,1	12,5	170	52	115	8
SAN0208 ...	16,2-16,4	14,0	175	54	119	8
SAN0208 ...	16,5	14,0	175	54	119	8
SAN0208 ...	16,6-16,9	14,0	175	54	119	8
SAN0208 ...	17,0	14,0	175	54	119	8
SAN0208 ...	17,1	14,0	175	54	119	8
SAN0208 ...	17,2-17,4	14,0	182	56	122	8
SAN0208 ...	17,5	14,0	182	56	122	8
SAN0208 ...	17,6-17,9	14,0	182	56	122	8
SAN0208 ...	18,0	14,0	182	56	122	8
SAN0208 ...	18,1	14,0	182	56	122	8
SAN0208 ...	18,2-18,4	16,0	189	58	127	8
SAN0208 ...	18,5	16,0	189	58	127	8
SAN0208 ...	18,6-18,9	16,0	189	58	127	8
SAN0208 ...	19,0	16,0	189	58	127	8
SAN0208 ...	19,1	16,0	189	58	127	8
SAN0208 ...	19,2-19,4	16,0	195	60	130	8
SAN0208 ...	19,5	16,0	195	60	130	8
SAN0208 ...	19,6-19,9	16,0	195	60	130	8
SAN0208 ...	20,0	16,0	195	60	130	8
SAN0208 ...	20,1	16,0	195	60	130	8
SAN0208 ...	20,2-21,2	16,0	195	60	130	8
SAN0208 ...	21,3-21,9	16,0	200	65	134	8
SAN0208 ...	21,9	16,0	200	65	134	8
SAN0208 ...	22,0	16,0	200	65	134	8
SAN0208 ...	22,1-22,2	16,0	200	65	134	8
SAN0208 ...	22,3-23,9	20,0	200	65	134	10
SAN0208 ...	24,0	20,0	200	65	134	10
SAN0208 ...	24,1-24,2	20,0	200	65	134	10
SAN0208 ...	24,3-24,9	20,0	200	65	134	10
SAN0208 ...	25,0	20,0	200	65	134	10
SAN0208 ...	25,1-25,2	20,0	200	65	134	10
SAN0208 ...	25,3-25,9	20,0	205	70	139	10
SAN0208 ...	26,0	20,0	205	70	139	10
SAN0208 ...	26,1-26,2	20,0	205	70	139	10
SAN0208 ...	26,3-27,9	25,0	205	70	139	10
SAN0208 ...	28,0	25,0	205	70	139	10
SAN0208 ...	28,1-28,2	25,0	205	70	139	10
SAN0208 ...	28,3-29,9	25,0	205	70	139	10
SAN0208 ...	30,0	25,0	205	70	139	10
SAN0208 ...	30,1-30,2	25,0	205	70	139	10
SAN0208 ...	30,3-31,9	25,0	205	70	139	10
SAN0208 ...	32,0	25,0	205	70	139	10
SAN0208 ...	32,1-32,2	25,0	205	70	139	10
SAN0208 ...	32,3-33,9	25,0	205	70	139	10
SAN0208 ...	34,0	25,0	205	70	139	10
SAN0208 ...	34,1-34,9	25,0	205	70	139	10
SAN0208 ...	35,0	25,0	205	70	139	10
SAN0208 ...	35,1-35,2	25,0	205	70	139	10

MATERIALI - MATERIALS Pag. 1199

Applicazione - Application

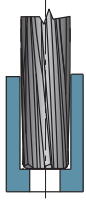

P	M	K	N	S	H	G	ØD	Vc	fn	n	Vf			
												ACCAIO NON LEGATO NOT ALLOY STEEL	ACCAIO POCO LEGATO LOW ALLOY STEEL	ACCAIO ALTO LEGATO ALLOY STEEL
●							1+5	10-12	0,10	-	-			
●							5+10	10-12	0,15	-	-			
●							10+20	10-12	0,25	-	-			
●							20+35,2	10-12	0,30	-	-			
●							1+5	8-10	0,10	-	-			
●							5+10	8-10	0,15	-	-			
●							10+20	8-10	0,25	-	-			
●							20+35,2	8-10	0,30	-	-			
●							1+5	4-6	0,08	-	-			
●							5+10	4-6	0,10	-	-			
●							10+20	4-6	0,20	-	-			
●							20+35,2	4-6	0,30	-	-			
●							1+5	3-5	0,10	-	-			
●							5+10	3-5	0,15	-	-			
●							10+20	3-5	0,20	-	-			
●							20+35,2	3-5	0,30	-	-			
●		●					1+5	8-10	0,18	-	-			
●		●					5+10	8-10	0,23	-	-			
●		●					10+20	8-10	0,30	-	-			
●		●					20+35,2	8-10	0,35	-	-			
●		●					1+5	4-6	0,12	-	-			
●		●					5+10	4-6	0,17	-	-			
●		●					10+20	4-6	0,25	-	-			
●		●					20+35,2	4-6	0,30	-	-			
●				●			1+5	18-20	0,15	-	-			
●				●			5+10	18-20	0,20	-	-			
●				●			10+20	18-20	0,30	-	-			
●				●			20+35,2	18-20	0,35	-	-			
●					●		1+5	10-15	0,20	-	-			
●					●		5+10	10-15	0,30	-	-			
●					●		10+20	10-15	0,40	-	-			
●					●		20+35,2	10-15	0,45	-	-			
●						●	1+5	4-6	0,20	-	-			
●						●	5+10	4-6	0,30	-	-			
●						●	10+20	4-6	0,40	-	-			
●						●	20+35,2	4-6	0,45	-	-			

● APPLICAZIONE CONSIGLIATA-RECOMMENDED APPLICATION
EMPFÖHLENER EINSATZ - APPLICATION CONSEILLÉE

○ APPLICAZIONE POSSIBILE - POSSIBLE APPLICATION
MÖGLICHE ANWENDUNG - APPLICATION POSSIBLE

Vc = m/min VELOCITÀ DI TAGLIO - CUTTING SPEED

n = giri/min (min⁻¹) NUMERO DI GIRI - NUMBER OF REVOLUTIONS

fn = mm AVANZAMENTO AL GIRO - FEED / REVOLUTION

Vf = mm/min VELOCITÀ DI AVANZAMENTO - FEED SPEED

$$n = \frac{Vc \cdot 1000}{\varnothing D \cdot 3,14} = \text{giri/min (min}^{-1}\text{)}$$

$$Vf = fn \cdot n = \text{mm/min}$$

SAN0209

ØD = 0,70 - 35,20

RIVESTIMENTO A RICHIESTA
*** COATING ON REQUEST**

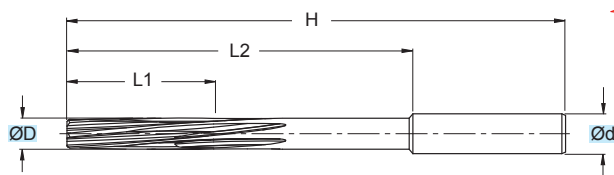

HSSE

TOLLERANZE	D	d
TOLERANCE RANGE	-0/+0,004	h8

ART.	(mm)					
	ØD	Ød	H	L1	L2	Z
SAN0209 ...	0,70-0,79	-	40	8	-	4
SAN0209 ...	0,80-0,89	-	40	8	-	4
SAN0209 ...	0,90-0,96	-	40	8	-	4
SAN0209 ...	0,97-1,50	-	40	8	-	4
SAN0209 ...	1,51-1,93	-	43	9	-	4
SAN0209 ...	1,94-2,12	2,0	49	11	26	4
SAN0209 ...	2,13-2,36	2,0	53	12	-	4
SAN0209 ...	2,37-2,48	2,3	57	14	-	4
SAN0209 ...	2,49-2,65	2,5	57	14	-	4
SAN0209 ...	2,66-2,96	2,5	61	15	-	4
SAN0209 ...	2,97-3,35	3,0	65	16	40	4
SAN0209 ...	3,36-3,75	3,5	70	18	45	4
SAN0209 ...	3,76-4,25	4,0	75	19	47	6
SAN0209 ...	4,26-4,75	4,5	80	21	51	6
SAN0209 ...	4,76-5,15	5,0	86	23	56	6
SAN0209 ...	5,16-5,65	5,0	93	26	58	6
SAN0209 ...	5,66-6,15	6,0	93	26	58	6
SAN0209 ...	6,16-6,71	6,0	101	28	63	6
SAN0209 ...	6,72-7,65	7,0	109	31	71	6
SAN0209 ...	7,66-8,65	8,0	117	33	77	6
SAN0209 ...	8,66-9,65	9,0	125	36	80	6
SAN0209 ...	9,66-10,60	10,0	133	38	85	6
SAN0209 ...	10,61-11,80	10,0	142	41	92	6
SAN0209 ...	11,81-12,20	10,0	151	44	99	6
SAN0209 ...	12,21-13,20	10,0	151	44	99	6
SAN0209 ...	13,21-14,15	12,5	160	47	105	6
SAN0209 ...	14,16-15,15	12,5	162	50	107	6
SAN0209 ...	15,16-16,15	12,5	170	52	115	8
SAN0209 ...	16,16-17,15	14,0	175	54	119	8
SAN0209 ...	17,16-18,15	14,0	182	56	122	8
SAN0209 ...	18,16-19,15	16,0	189	58	127	8
SAN0209 ...	19,16-20,15	16,0	195	60	130	8
SAN0209 ...	20,16-21,20	16,0	195	60	130	8
SAN0209 ...	21,21-22,20	16,0	200	65	134	8
SAN0209 ...	22,21-24,20	20,0	200	65	134	10
SAN0209 ...	24,21-25,20	20,0	200	65	134	10
SAN0209 ...	25,21-26,20	20,0	200	65	134	10
SAN0209 ...	26,21-28,20	25,0	205	70	139	10
SAN0209 ...	28,21-30,20	25,0	205	70	139	10
SAN0209 ...	30,21-32,20	25,0	205	70	139	10
SAN0209 ...	32,21-35,20	25,0	205	70	139	10

* Nell'ordine inserire sempre il "Ø" scelto dopo il codice dell'alesatore
 * When ordering always indicate the chosen diameter after the reamer code
 * Bei der Bestellung bitte immer den gewählten "Ø" hinter dem Reibahlencode angeben
 * Entrer toujours dans la commande le "Ø" choisi après le code de l'alesoir

EX. Ø = 13,21 COD. = SAN02091321
EX. Ø = 3,80 COD. = SAN02090380

* Per ordinare alesatori rivestiti sostituire al codice art. la "N" con una "R"
 * To order coated reamers, replace the article code "N" with "R."
 * Um beschichtete Reibahlen zu bestellen, ersetzen Sie den Artikelcode "N" durch ein "R".
 * Pour commander des alésoirs revêtus, remplacez le numéro d'article "N" par un "R".

EX. Ø = 13,21 COD. = SAR02091321
EX. Ø = 3,80 COD. = SAR02090380

ESEGUE FORI CON TOLLERANZA -0/+0,004
 FOR BORES WITH -0/+0,004 TOLERANCE
 FÜHRT BOHRUNGEN MIT -0/+0,004 TOLERANZ AUS
 EXECUTE TROUS AVEC TOLERANCE -0/+0,004

MATERIALI - MATERIALS Pag. 1199

Applicazione - Application

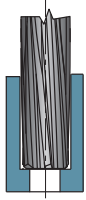

P	M	K	N	S	H	G	ØD	Vc	fn	n	Vf
●							0,7÷5	10-12	0,10	-	-
●							5÷10	10-12	0,15	-	-
●							10÷20	10-12	0,25	-	-
●							20÷35,2	10-12	0,30	-	-
●							0,7÷5	8-10	0,10	-	-
●							5÷10	8-10	0,15	-	-
●							10÷20	8-10	0,25	-	-
●							20÷35,2	8-10	0,30	-	-
●							0,7÷5	4-6	0,08	-	-
●							5÷10	4-6	0,10	-	-
●							10÷20	4-6	0,20	-	-
●							20÷35,2	4-6	0,30	-	-
●							0,7÷5	3-5	0,10	-	-
●							5÷10	3-5	0,15	-	-
●							10÷20	3-5	0,20	-	-
●							20÷35,2	3-5	0,30	-	-
●							0,7÷5	8-10	0,18	-	-
●							5÷10	8-10	0,23	-	-
●							10÷20	8-10	0,30	-	-
●							20÷35,2	8-10	0,35	-	-
●							0,7÷5	4-6	0,12	-	-
●							5÷10	4-6	0,17	-	-
●							10÷20	4-6	0,25	-	-
●							20÷35,2	4-6	0,30	-	-
●							0,7÷5	18-20	0,15	-	-
●							5÷10	18-20	0,20	-	-
●							10÷20	18-20	0,30	-	-
●							20÷35,2	18-20	0,35	-	-
●							0,7÷5	10-15	0,20	-	-
●							5÷10	10-15	0,30	-	-
●							10÷20	10-15	0,40	-	-
●							20÷35,2	10-15	0,45	-	-
●							0,7÷5	4-6	0,20	-	-
●							5÷10	4-6	0,30	-	-
●							10÷20	4-6	0,40	-	-
●							20÷35,2	4-6	0,45	-	-

● APPLICAZIONE CONSIGLIATA-RECOMMENDED APPLICATION
EMPFÖHLENER EINSATZ - APPLICATION CONSEILLÉE

○ APPLICAZIONE POSSIBILE - POSSIBLE APPLICATION
MÖGLICHE ANWENDUNG - APPLICATION POSSIBLE

Vc = m/min VELOCITÀ DI TAGLIO - CUTTING SPEED

n = giri/min (min⁻¹) NUMERO DI GIRI - NUMBER OF REVOLUTIONS





















fn = mm AVANZAMENTO AL GIRO - FEED / REVOLUTION

Vf = mm/min VELOCITÀ DI AVANZAMENTO - FEED SPEED

$$n = \frac{Vc \cdot 1000}{\text{ØD} \cdot 3,14} = \text{giri/min (min}^{-1}\text{)}$$

$$Vf = fn \cdot n = \text{mm/min}$$

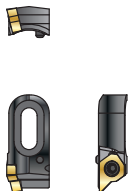
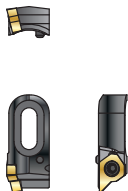

SDQ...20		Pag. 652	TDC...30		Pag. 658	TDBC...25		Pag. 664
 <p>2 x D</p>	$\varnothing D = 15 - 40$	 <p>QCMX</p> <p>010204 020204 030308 040308 050412 060412</p>	 <p>3 x D</p>	$\varnothing D = 17,5 - 59$	 <p>WCMX</p> <p>06T308 080412</p>	 <p>2,5 x D</p>	$\varnothing D = 19 - 54$	 <p>WCMX</p> <p>040208 050308 06T308 080412</p>
	SDQ..20 R - SDQM..20 R			TDC..30 R/L			TDBC..25 R/L	
 <p>3 x D</p>		Pag. 654	 <p>4 x D</p>		Pag. 660			
 <p>3 x D</p>	$\varnothing D = 15 - 60$	 <p>QCMX</p> <p>010204 020204 030308 040308 050412 060412 080412</p>	 <p>4 x D</p>	$\varnothing D = 17,5 - 50$	 <p>WCMX</p> <p>030208 040208 050308 06T308 080412</p>			
	SDQ..30 R - SDQM..30 R			TDC..40 R/L				
 <p>4 x D</p>		Pag. 656	 <p>3 x D</p>		Pag. 662			
 <p>4 x D</p>	$\varnothing D = 15 - 50$	 <p>QCMX</p> <p>010204 020204 030308 040308 050412 060412 080412</p>	 <p>3 x D</p>	$\varnothing D = 17,5 - 40$	 <p>WCMX</p> <p>030208 040208 050308 06T308</p>			
	SDQ..40 R			TDCS.. R/L				
			 <p>SPU...</p>		Pag. 663			
			 <p>SM0702</p>	 <p>-30 -45 -55</p>				
					SPU 1840-07			

SDQ ..20R
SDQM ..20R

Ø 15-40

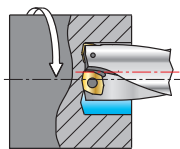

DISASSAMENTO TEORICO
THEORETICAL OFFSET

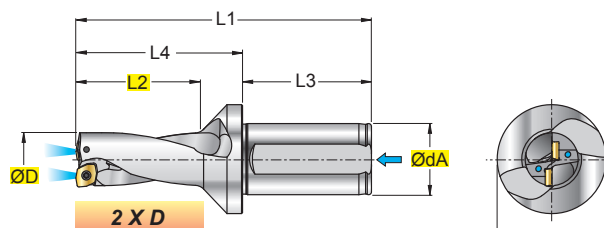

QCMXX36	
QCMXX42	
QCMXX52	
INSERTI - INSERTS PAG. 685	

ART.	(mm)								kg	Nm					
	ØD	ØdA	ØD1	L1	L2	L3	L4								
SDQ 15020R	15,0	20	32	90	35	40	50	0,18	0,9+1,0	010204	12225P	5607P			
SDQ 15520R	15,5	20	32	91	36	40	51	0,18	0,9+1,0						
SDQ 16020R	16,0	20	32	92	37	40	52	0,18	0,9+1,0						
SDQ 16520R	16,5	20	32	93	38	40	53	0,19	0,9+1,0						
SDQ 17020R	17,0	20	32	94	39	40	54	0,19	0,9+1,0						
SDQ 17520R	17,5	25	37	112	41	54	58	0,33	0,9+1,0						
SDQ 18020R	18,0	25	37	113	42	54	59	0,33	0,9+1,0						
SDQ 18520R	18,5	25	37	114	43	54	60	0,34	0,9+1,0						
SDQ 19020R	19,0	25	37	115	44	54	61	0,34	0,9+1,0						
SDQ 19520R	19,5	25	37	116	45	54	62	0,34	0,9+1,0						
SDQ 20020R	20,0	25	37	117	46	54	63	0,34	0,9+1,0	020204	12225P	5607P			
SDQ 20520R	20,5	25	37	118	47	54	64	0,34	0,9+1,0						
SDQ 21020R	21,0	25	37	119	48	54	65	0,35	0,9+1,0						
SDQ 21520R	21,5	25	37	120	49	54	66	0,35	0,9+1,0						
SDQ 22020R	22,0	25	37	121	50	54	67	0,36	0,9+1,0						
SDQ 22520R	22,5	25	37	122	51	54	68	0,36	0,9+1,0						
SDQ 23020R	23,0	25	37	123	52	54	69	0,37	0,9+1,0						
SDQ 23520R	23,5	25	37	124	53	54	70	0,37	1,2+1,5				030308	123008P	5608P
SDQ 24020R	24,0	25	37	125	54	54	71	0,37	1,2+1,5						
SDQ 24520R	24,5	25	37	126	55	54	72	0,38	1,2+1,5						
SDQ 25020R	25,0	32	49	133	56	58	75	0,62	1,2+1,5						
SDQ 25520R	25,5	32	49	134	57	58	76	0,63	1,2+1,5						
SDQ 26020R	26,0	32	49	135	58	58	77	0,64	1,2+1,5						
SDQ 26520R	26,5	32	49	136	59	58	78	0,64	1,2+1,5						
SDQ 27020R	27,0	32	49	137	60	58	79	0,65	1,2+1,5						
SDQ 27520R	27,5	32	49	138	61	58	80	0,65	1,2+1,5						
SDQ 28020R	28,0	32	49	139	62	58	81	0,65	1,2+1,5	040308	123008P	5608P			
SDQ 28520R	28,5	32	49	140	63	58	82	0,66	1,2+1,5						
SDQ 29020R	29,0	32	49	141	64	58	83	0,67	1,2+1,5						
SDQ 29520R	29,5	32	49	142	65	58	84	0,68	1,2+1,5						
SDQ 30020R	30,0	32	49	143	66	58	85	0,68	1,2+1,5						
SDQ 30520R	30,5	32	49	144	67	58	86	0,69	1,2+1,5						
SDQ 31020R	31,0	32	49	145	68	58	87	0,69	1,2+1,5						
SDQ 31520R	31,5	32	49	146	69	58	88	0,71	1,2+1,5						
SDQ 32020R	32,0	40	59	161	71	68	93	1,11	1,2+1,5						
SDQM 32020R	32,0	32	49	151	71	58	93	0,76	1,2+1,5				050412	123511P	5615P
SDQ 32520R	32,5	40	59	162	72	68	94	1,14	1,2+1,5						
SDQ 33020R	33,0	40	59	163	73	68	95	1,15	1,2+1,5						
SDQM 33020R	33,0	32	49	153	73	58	95	0,77	1,2+1,5						
SDQ 33520R	33,5	40	59	164	74	68	96	1,16	1,2+1,5						
SDQ 34020R	34,0	40	59	165	75	68	97	1,17	1,2+1,5						
SDQM 34020R	34,0	32	49	155	75	58	97	0,81	1,2+1,5						
SDQ 35020R	35,0	40	59	167	77	68	99	1,19	3,0+3,5						
SDQM 35020R	35,0	32	49	157	77	58	99	0,82	3,0+3,5						
SDQ 36020R	36,0	40	59	169	79	68	101	1,21	3,0+3,5	060412	123511P	5615P			
SDQM 36020R	36,0	32	49	159	79	58	101	0,85	3,0+3,5						
SDQ 37020R	37,0	40	59	171	81	68	103	1,24	3,0+3,5						
SDQM 37020R	37,0	32	49	161	81	58	103	0,87	3,0+3,5						
SDQ 38020R	38,0	40	59	173	83	68	105	1,25	3,0+3,5						
SDQM 38020R	38,0	32	49	163	83	58	105	0,89	3,0+3,5						
SDQ 39020R	39,0	40	59	175	85	68	107	1,29	3,0+3,5						
SDQM 39020R	39,0	32	49	165	85	58	107	0,93	3,0+3,5						
SDQ 40020R	40,0	40	59	177	87	68	109	1,30	3,0+3,5						
SDQM 40020R	40,0	32	49	167	87	58	109	0,94	3,0+3,5						

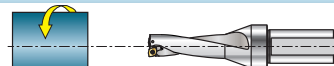
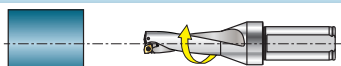

(■) LAVORAZIONE OTTIMALE - OPTIMUM MACHINING - OPTIMALE BEARBEITUNG - USINAGE OPTIMALE
(□) LAVORAZIONE POSSIBILE - POSSIBLE MACHINING - MOEGICHE BEARBEITUNG - USINAGE POSSIBLE

SCELTA VELOCE - QUICK PICK							Tenacit� + Toughness -		Pag. 688		HT	HW	HC											
							CERMET		NON RIV. CEMENTED CARBIDE GRADES		RIVESTITI COATED GRADES BESCHICHTET RECOUVERTS													
COD.		P	M	K	N	S	H				T3610	T5320	T5322	T530					l	d	s	d1	r	a°
QCMX	010204 .X36	●	○		○														5,4	5,8	2,38	2,5	0,4	7
QCMX	020204 .X36	●	○		○														6,6	7,1	2,38	2,5	0,4	7
QCMX	030308 .X36	●	○		○														8,3	8,8	3,18	3,4	0,8	7
QCMX	040308 .X36	●	○		○														9,6	10,2	3,18	3,4	0,8	7
QCMX	050412 .X36	●	○		○														11,3	12,1	4,76	4,3	1,2	7
QCMX	060412 .X36	●	○		○														13,8	14,8	4,76	4,3	1,2	7
QCMX	010204 .X42	●	●		○														5,4	5,8	2,38	2,5	0,4	7
QCMX	020204 .X42	●	●		○														6,6	7,1	2,38	2,5	0,4	7
QCMX	030308 .X42	●	●		○														8,3	8,8	3,18	3,4	0,8	7
QCMX	040308 .X42	●	●		○														9,6	10,2	3,18	3,4	0,8	7
QCMX	050412 .X42	●	●		○														11,3	12,1	4,76	4,3	1,2	7
QCMX	060412 .X42	●	●		○														13,8	14,8	4,76	4,3	1,2	7
QCMX	010204 .X52	●	○	○															5,4	5,8	2,38	2,5	0,4	7
QCMX	020204 .X52	●	○	○															6,6	7,1	2,38	2,5	0,4	7
QCMX	030308 .X52	●	○	○															8,3	8,8	3,18	3,4	0,8	7
QCMX	040308 .X52	●	○	○															9,6	10,2	3,18	3,4	0,8	7
QCMX	050412 .X52	●	○	○															11,3	12,1	4,76	4,3	1,2	7
QCMX	060412 .X52	●	○	○															13,8	14,8	4,76	4,3	1,2	7
QCMX	010204 .X52	○		●															5,4	5,8	2,38	2,5	0,4	7
QCMX	020204 .X52	○		●															6,6	7,1	2,38	2,5	0,4	7
QCMX	030308 .X52	○		●															8,3	8,8	3,18	3,4	0,8	7
QCMX	040308 .X52	○		●															9,6	10,2	3,18	3,4	0,8	7
QCMX	050412 .X52	○		●															11,3	12,1	4,76	4,3	1,2	7
QCMX	060412 .X52	○		●															13,8	14,8	4,76	4,3	1,2	7



QCMXX36 = CONSIGLIATO PER ACCIAIO NON LEGATO RECOMMENDED FOR NOT ALLOY STEEL



QCMXX42 = CONSIGLIATO PER ACCIAIO INOX RECOMMENDED FOR STAINLESS STEEL



QCMXX52 = CONSIGLIATO PER ACCIAIO RECOMMENDED FOR STEEL



QCMXX52 = CONSIGLIATO PER GHISA RECOMMENDED FOR CAST IRON

MATERIALI - MATERIALS Pag. 1199		VDI 3323 GR.	HB Rm ¹⁾ HRC ²⁾	fn mm					Vc m/min Pag. 694					
				Ø15-19,5	Ø20-23	Ø23,5-29,5	Ø30-39	Ø40	T3610	T5320	T5322	T530		
P	ACCIAIO NON LEGATO - NOT ALLOY STEEL	1-5	125-300	0,05-0,12	0,05-0,14	0,05-0,16	0,07-0,18	0,07-0,21				300	180	
	ACCIAIO POCO LEGATO - LOW ALLOY STEEL	6-9	180-350	0,05-0,14	0,05-0,18	0,05-0,23	0,07-0,25	0,07-0,29				280	280	170
	ACCIAIO ALTO LEGATO - ALLOY STEEL	10-11	200-325	0,05-0,14	0,05-0,18	0,05-0,23	0,07-0,25	0,07-0,29				240	250	
	INOX MARTENS. - STAINLESS STEEL MART	12-13	200-240	0,05-0,12	0,05-0,12	0,05-0,14	0,07-0,17	0,07-0,23				180	200	
M	INOX AUST. DUPLEX - STAINLESS STEEL AUST	14.1-14.2	180-230	0,05-0,09	0,05-0,14	0,07-0,21	0,07-0,23	0,07-0,25				140	200	120
K	GHISA GRIGIA - GREY CAST IRON	15-16	180-260	0,07-0,17	0,07-0,21	0,07-0,25	0,07-0,28	0,09-0,30				350	280	
	GHISA SFEROIDALE - SPHEROIDAL GRAPHITE	17-18	160-250	0,07-0,17	0,07-0,21	0,07-0,25	0,07-0,28	0,09-0,30				280	240	
	GHISA MALLEABILE - MALLEABLE CAST IRON	19-20	130-230	0,07-0,17	0,07-0,21	0,07-0,25	0,07-0,28	0,09-0,30				300	260	
N	ALLUMINIO E SUE LEGHE - ALUMINIUM	21-25	60-130	0,06-0,16	0,09-0,21	0,12-0,25	0,12-0,28	0,12-0,32					400	400
	RAME E SUE LEGHE - COPPER	26-28	90-110	0,05-0,16	0,05-0,18	0,07-0,23	0,07-0,23	0,12-0,29					300	300
	NON METALLICI - PLASTICS	29-30	/	0,05-0,16	0,05-0,18	0,07-0,23	0,07-0,23	0,12-0,29					300	300
S	LEGHE RESIST. CALORE - HIG. TEMP. ALLOY	31-35	200-320											
	TITANIO E SUE LEGHE - TITANIUM	36-37	400-1050 ¹⁾											
H	ACCIAIO TEMPRATO - HARDENED STEEL	38-41	45-60 ²⁾											

Vc = m/min VELOCIT  DI TAGLIO - CUTTING SPEED
n = giri/min (min⁻¹) NUMERO DI GIRI - NUMBER OF REVOLUTIONS
fn = mm AVANZAMENTO AL GIRO - FEED / REVOLUTION
Vf = mm/min VELOCIT  DI AVANZAMENTO - FEED SPEED

$$Vf = fn \cdot n = \text{mm/min}$$

$$n = \frac{Vc \cdot 1000}{\text{ØD} \cdot 3,14} = \text{giri/min (min}^{-1}\text{)}$$

● DISPONIBILI - IN STOCK - LIEFERBAR - DISPONIBLES / ■ NEW
●● APPLICAZIONE CONSIGLIATA-RECOMMENDED APPLICATION
EMPFÖHLENER EINSATZ - APPLICATION CONSEILLÉE

□ A RICHIESTA - ON REQUEST - AUF ANFRAGE - SUR DEMANDE / □ NEW
○ APPLICAZIONE POSSIBILE - POSSIBLE APPLICATION
MÖGLICHE ANWENDUNG - APPLICATION POSSIBLE

SDQ ..30R
SDQM ..30R

Ø 15-60

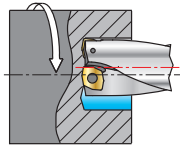

DISASSAMENTO TEORICO
THEORETICAL OFFSET

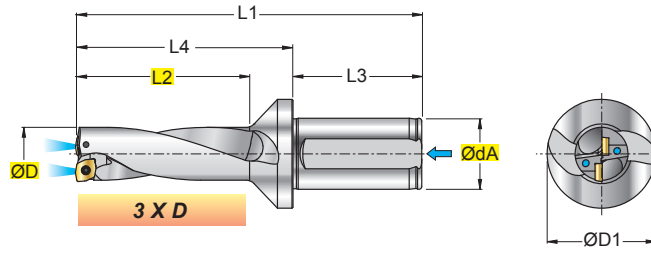

QCMXX36	
QCMXX42	
QCMXX52	
INSERTI - INSERTS PAG. 685	

ART.	(mm)								kg	Nm			
	ØD	ØdA	ØD1	L1	L2	L3	L4						
SDQ 15030R	15.0	20	32	102	47	40	62	0.18	0.9+1.0	010204	12225P	5607P	
SDQ 15530R	15.5	20	32	103.5	48.5	40	63.5	0.18	0.9+1.0				
SDQ 16030R	16.0	20	32	105	50	40	65	0.18	0.9+1.0				
SDQ 16530R	16.5	20	32	106.5	51.5	40	66.5	0.19	0.9+1.0				
SDQ 17030R	17.0	20	32	108	53	40	68	0.19	0.9+1.0				
SDQ 17530R	17.5	25	37	126.5	55.5	54	72.5	0.33	0.9+1.0				
SDQ 18030R	18.0	25	37	128	57	54	74	0.34	0.9+1.0				
SDQ 18530R	18.5	25	37	129.5	58.5	54	75.5	0.34	0.9+1.0				
SDQ 19030R	19.0	25	37	131	60	54	77	0.35	0.9+1.0				
SDQ 19530R	19.5	25	37	132.5	61.5	54	78.5	0.35	0.9+1.0				
SDQ 20030R	20.0	25	37	134	63	54	80	0.35	0.9+1.0				
SDQ 20530R	20.5	25	37	135.5	64.5	54	81.5	0.36	0.9+1.0				
SDQ 21030R	21.0	25	37	137	66	54	83	0.37	0.9+1.0				
SDQ 21530R	21.5	25	37	138.5	67.5	54	84.5	0.37	0.9+1.0				
SDQ 22030R	22.0	25	37	140	69	54	86	0.38	0.9+1.0				
SDQ 22530R	22.5	25	37	141.5	70.5	54	87.5	0.39	0.9+1.0				
SDQ 23030R	23.0	25	37	143	72	54	89	0.40	0.9+1.0				
SDQ 23530R	23.5	25	37	144.5	73.5	54	90.5	0.40	1.2+1.5				
SDQ 24030R	24.0	25	37	146	75	54	92	0.40	1.2+1.5				
SDQ 24530R	24.5	25	37	147.5	76.5	54	93.5	0.42	1.2+1.5				
SDQ 25030R	25.0	32	49	156	79	58	98	0.65	1.2+1.5				
SDQ 25530R	25.5	32	49	157.5	80.5	58	99.5	0.66	1.2+1.5				
SDQ 26030R	26.0	32	49	159	82	58	101	0.67	1.2+1.5				
SDQ 26530R	26.5	32	49	160.5	83.5	58	102.5	0.68	1.2+1.5				
SDQ 27030R	27.0	32	49	162	85	58	104	0.68	1.2+1.5				
SDQ 27530R	27.5	32	49	163.5	86.5	58	105.5	0.68	1.2+1.5				
SDQ 28030R	28.0	32	49	165	88	58	107	0.69	1.2+1.5				
SDQ 28530R	28.5	32	49	166.5	89.5	58	108.5	0.70	1.2+1.5				
SDQ 29030R	29.0	32	49	168	91	58	110	0.72	1.2+1.5				
SDQ 29530R	29.5	32	49	169.5	92.5	58	111.5	0.74	1.2+1.5				
SDQ 30030R	30.0	32	49	171	94	58	113	0.74	1.2+1.5				
SDQ 30530R	30.5	32	49	172.5	95.5	58	114.5	0.75	1.2+1.5				
SDQ 31030R	31.0	32	49	174	97	58	116	0.76	1.2+1.5				
SDQ 31530R	31.5	32	49	175.5	98.5	58	117.5	0.80	1.2+1.5				
SDQ 32030R	32.0	40	59	191	101	68	123	1.18	1.2+1.5				
SDQM 32030R	32.0	32	49	181	101	58	123	0.85	1.2+1.5				
SDQ 32530R	32.5	40	59	192.5	102.5	68	124.5	1.19	1.2+1.5				
SDQ 33030R	33.0	40	59	194	104	68	126	1.20	1.2+1.5				
SDQM 33030R	33.0	32	49	184	104	58	126	0.88	1.2+1.5				
SDQ 33530R	33.5	40	59	195.5	105.5	68	127.5	1.23	1.2+1.5				
SDQ 34030R	34.0	40	59	197	107	68	129	1.26	1.2+1.5				
SDQM 34030R	34.0	32	49	187	107	58	129	0.92	1.2+1.5				
SDQ 34530R	34.5	40	59	198.5	108.5	68	130.5	1.27	3.0+3.5				
SDQ 35030R	35.0	40	59	200	110	68	132	1.28	3.0+3.5				
SDQM 35030R	35.0	32	49	190	110	58	132	0.94	3.0+3.5				
SDQ 35530R	35.5	40	59	201.5	111.5	68	133.5	1.30	3.0+3.5				
SDQ 36030R	36.0	40	59	203	113	68	135	1.32	3.0+3.5				
SDQM 36030R	36.0	32	49	193	113	58	135	0.99	3.0+3.5				
SDQ 36530R	36.5	40	59	204.5	114.5	68	136.5	1.33	3.0+3.5				
SDQ 37030R	37.0	40	59	206	116	68	138	1.35	3.0+3.5				
SDQM 37030R	37.0	32	49	196	116	58	138	1.01	3.0+3.5				
SDQ 37530R	37.5	40	59	207.5	117.5	68	139.5	1.37	3.0+3.5				
SDQ 38030R	38.0	40	59	209	119	68	141	1.39	3.0+3.5				
SDQM 38030R	38.0	32	49	199	119	58	141	1.05	3.0+3.5				
SDQ 38530R	38.5	40	59	210.5	120.5	68	142.5	1.42	3.0+3.5				
SDQ 39030R	39.0	40	59	212	122	68	144	1.44	3.0+3.5				
SDQM 39030R	39.0	32	49	202	122	58	144	1.10	3.0+3.5				
SDQ 39530R	39.5	40	59	213.5	123.5	68	145.5	1.49	3.0+3.5				
SDQ 40030R	40.0	40	59	215	125	68	147	1.44	3.0+3.5				
SDQM 40030R	40.0	32	49	205	125	58	147	1.12	3.0+3.5				
SDQ 41030R	41.0	40	59	218	128	68	150	1.50	3.0+3.5				
SDQ 42030R	42.0	40	59	221	131	68	153	1.56	3.0+3.5				
SDQ 43030R	43.0	40	59	224	134	68	156	1.64	3.0+3.5				
SDQ 44030R	44.0	40	59	227	137	68	159	1.69	3.0+3.5				
SDQ 45030R	45.0	40	59	230	140	68	162	1.73	3.0+3.5				
SDQ 46030R	46.0	40	59	241	143	68	173	1.78	3.0+3.5				
SDQ 47030R	47.0	40	59	244	146	68	176	1.86	3.0+3.5				
SDQ 48030R	48.0	40	59	247	149	68	179	1.93	3.0+3.5				
SDQ 49030R	49.0	40	59	250	152	68	182	2.05	3.0+3.5				
SDQ 50030R	50.0	40	59	253	158	68	185	2.11	3.0+3.5				
SDQ 51030R	51.0	40	59	256	161	68	188	2.17	3.0+3.5				
SDQ 52030R	52.0	40	59	259	164	68	191	2.27	3.0+3.5				
SDQ 53030R	53.0	40	59	262	167	68	194	2.37	3.0+3.5				
SDQ 54030R	54.0	40	59	265	170	68	197	2.47	3.0+3.5				
SDQ 55030R	55.0	40	59	268	173	68	200	2.59	3.0+3.5				
SDQ 56030R	56.0	40	59	271	176	68	203	2.70	3.0+3.5				
SDQ 57030R	57.0	40	59	274	179	68	206	2.81	3.0+3.5				
SDQ 58030R	58.0	40	59	277	182	68	209	2.88	3.0+3.5				
SDQ 59030R	59.0	40	59	280	185	68	212	3.05	3.0+3.5				
SDQ 60030R	60.0	40	59	283	188	68	215	3.17	3.0+3.5				
SDQ 60030R	60.0	40	59	283	188	68	215	3.17	3.0+3.5				
SDQ 60030R	60.0	40	59	283	188	68	215	3.17	3.0+3.5				



(■) LAVORAZIONE OTTIMALE - OPTIMUM MACHINING - OPTIMALE BEARBEITUNG - USINAGE OPTIMALE
(○) LAVORAZIONE POSSIBILE - POSSIBLE MACHINING - MOEGELICHE BEARBEITUNG - USINAGE POSSIBLE

SDQ ..40R N

Ø 15-50

NEW

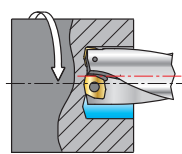

DISASSAMENTO TEORICO
THEORETICAL OFFSET

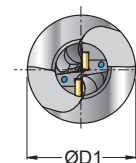
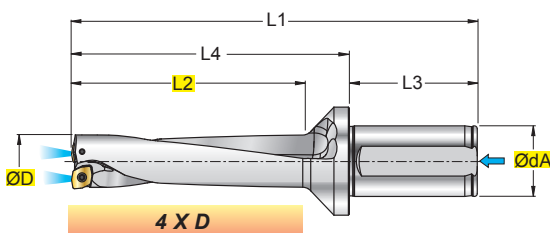

QCMXX36	
QCMXX42	
QCMXX52	
 INSERTI - INSERTS PAG. 685	

ART.	(mm)								kg	Nm					
	ØD ^{+/-0,1}	ØdA	ØD1	L1	L2	L3	L4								
SDQ 15040R N	15,0	20	32	120	65	40	80	0,20	0,9+1,0	010204	12225P	5607P			
SDQ 15540R N	15,5	20	32	122	67	40	82	0,20	0,9+1,0						
SDQ 16040R N	16,0	20	32	124	69	40	84	0,20	0,9+1,0						
SDQ 16540R N	16,5	20	32	126	71	40	86	0,21	0,9+1,0						
SDQ 17040R N	17,0	20	32	128	73	40	88	0,21	0,9+1,0						
SDQ 17540R N	17,5	25	37	147	76	54	93	0,37	0,9+1,0						
SDQ 18040R N	18,0	25	37	149	78	54	95	0,38	0,9+1,0						
SDQ 18540R N	18,5	25	37	151	80	54	97	0,38	0,9+1,0						
SDQ 19040R N	19,0	25	37	153	82	54	99	0,39	0,9+1,0						
SDQ 19540R N	19,5	25	37	155	84	54	101	0,39	0,9+1,0						
SDQ 20040R N	20,0	25	37	157	86	54	103	0,39	0,9+1,0	020204	12225P	5607P			
SDQ 20540R N	20,5	25	37	159	88	54	105	0,40	0,9+1,0						
SDQ 21040R N	21,0	25	37	161	90	54	107	0,41	0,9+1,0						
SDQ 21540R N	21,5	25	37	163	92	54	109	0,41	0,9+1,0						
SDQ 22040R N	22,0	25	37	165	94	54	111	0,42	0,9+1,0						
SDQ 22540R N	22,5	25	37	167	96	54	113	0,43	0,9+1,0						
SDQ 23040R N	23,0	25	37	169	98	54	115	0,44	0,9+1,0						
SDQ 23540R N	23,5	25	37	170	99	54	116	0,44	1,2+1,5				030308	123008P	5608P
SDQ 24040R N	24,0	25	37	173	102	54	119	0,45	1,2+1,5						
SDQ 24540R N	24,5	25	37	175	104	54	121	0,47	1,2+1,5						
SDQ 25040R N	25,0	32	49	184	107	58	126	0,72	1,2+1,5						
SDQ 25540R N	25,5	32	49	186	109	58	128	0,73	1,2+1,5						
SDQ 26040R N	26,0	32	49	188	111	58	130	0,74	1,2+1,5						
SDQ 26540R N	26,5	32	49	190	113	58	132	0,75	1,2+1,5						
SDQ 27040R N	27,0	32	49	192	115	58	134	0,75	1,2+1,5						
SDQ 27540R N	27,5	32	49	194	117	58	136	0,76	1,2+1,5						
SDQ 28040R N	28,0	32	49	196	119	58	138	0,77	1,2+1,5	040308	123008P	5608P			
SDQ 28540R N	28,5	32	49	198	121	58	140	0,78	1,2+1,5						
SDQ 29040R N	29,0	32	49	200	123	58	142	0,80	1,2+1,5						
SDQ 29540R N	29,5	32	49	202	125	58	144	0,82	1,2+1,5						
SDQ 30040R N	30,0	32	49	204	127	58	146	0,82	1,2+1,5						
SDQ 31040R N	31,0	32	49	208	131	58	150	0,84	1,2+1,5						
SDQ 32040R N	32,0	40	59	226	136	68	158	1,33	1,2+1,5						
SDQ 33040R N	33,0	40	59	230	140	68	162	1,36	1,2+1,5						
SDQ 34040R N	34,0	40	59	234	144	68	166	1,42	1,2+1,5						
SDQ 35040R N	35,0	40	59	238	148	68	170	1,45	3,0+3,5	050412	123511P	5615P			
SDQ 36040R N	36,0	40	59	242	152	68	174	1,49	3,0+3,5						
SDQ 37040R N	37,0	40	59	246	156	68	178	1,52	3,0+3,5						
SDQ 38040R N	38,0	40	59	250	160	68	182	1,57	3,0+3,5						
SDQ 39040R N	39,0	40	59	254	164	68	186	1,62	3,0+3,5						
SDQ 40040R N	40,0	40	59	258	168	68	190	1,62	3,0+3,5				060412	123511P	5615P
SDQ 41040R N	41,0	40	59	262	172	68	194	1,70	3,0+3,5						
SDQ 42040R N	42,0	40	59	266	176	68	198	1,76	3,0+3,5						
SDQ 43040R N	43,0	40	59	270	180	68	202	1,85	3,0+3,5						
SDQ 44040R N	44,0	40	59	274	184	68	206	1,90	3,0+3,5						
SDQ 45040R N	45,0	40	59	278	188	68	210	1,95	3,0+3,5						
SDQ 46040R N	46,0	40	59	290	192	68	222	2,01	3,0+3,5						
SDQ 47040R N	47,0	40	59	294	196	68	226	2,10	3,0+3,5						
SDQ 48040R N	48,0	40	59	298	200	68	230	2,18	3,0+3,5						
SDQ 49040R N	49,0	40	59	302	204	68	234	2,32	3,0+3,5	080412	123511P	5615P			
SDQ 50040R N	50,0	40	59	306	211	68	238	2,38	3,0+3,5						

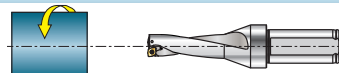
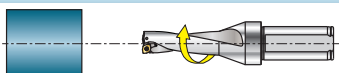

(■) LAVORAZIONE OTTIMALE - OPTIMUM MACHINING - OPTIMALE BEARBEITUNG - USINAGE OPTIMALE
 (○) LAVORAZIONE POSSIBILE - POSSIBLE MACHINING - MOEGICHE BEARBEITUNG - USINAGE POSSIBLE



SCelta VELOCE - QUICK PICK

Tenacità + ↑
Toughness - ↓

Pag. 688

COD.	P	M	K	N	S	H	HT		HW	HC				l	d	s	d1	r	a°
							CERMET	NON RIV. CEMENTED CARBIDE GRADES	RIVESTITI COATED GRADES BESCHICHTET RECOUVERTS										
										T3610	T5320	T5322	T530						
QCMX 010204 .X36	●	○		○										5,4	5,8	2,38	2,5	0,4	7
QCMX 020204 .X36	●	○		○										6,6	7,1	2,38	2,5	0,4	7
QCMX 030308 .X36	●	○		○										8,3	8,8	3,18	3,4	0,8	7
QCMX 040308 .X36	●	○		○										9,6	10,2	3,18	3,4	0,8	7
QCMX 050412 .X36	●	○		○										11,3	12,1	4,76	4,3	1,2	7
QCMX 060412 .X36	●	○		○										13,8	14,8	4,76	4,3	1,2	7
QCMX 080412 .X36	●	○		○										17,2	18,5	4,76	4,3	1,2	7
QCMX 010204 .X42	●	●		○										5,4	5,8	2,38	2,5	0,4	7
QCMX 020204 .X42	●	●		○										6,6	7,1	2,38	2,5	0,4	7
QCMX 030308 .X42	●	●		○										8,3	8,8	3,18	3,4	0,8	7
QCMX 040308 .X42	●	●		○										9,6	10,2	3,18	3,4	0,8	7
QCMX 050412 .X42	●	●		○										11,3	12,1	4,76	4,3	1,2	7
QCMX 060412 .X42	●	●		○										13,8	14,8	4,76	4,3	1,2	7
QCMX 080412 .X42	●	●		○										17,2	18,5	4,76	4,3	1,2	7
QCMX 010204 .X52	●	○	○											5,4	5,8	2,38	2,5	0,4	7
QCMX 020204 .X52	●	○	○											6,6	7,1	2,38	2,5	0,4	7
QCMX 030308 .X52	●	○	○											8,3	8,8	3,18	3,4	0,8	7
QCMX 040308 .X52	●	○	○											9,6	10,2	3,18	3,4	0,8	7
QCMX 050412 .X52	●	○	○											11,3	12,1	4,76	4,3	1,2	7
QCMX 060412 .X52	●	○	○											13,8	14,8	4,76	4,3	1,2	7
QCMX 080412 .X52	●	○	○											17,2	18,5	4,76	4,3	1,2	7
QCMX 010204 .X52	○		●											5,4	5,8	2,38	2,5	0,4	7
QCMX 020204 .X52	○		●											6,6	7,1	2,38	2,5	0,4	7
QCMX 030308 .X52	○		●											8,3	8,8	3,18	3,4	0,8	7
QCMX 040308 .X52	○		●											9,6	10,2	3,18	3,4	0,8	7
QCMX 050412 .X52	○		●											11,3	12,1	4,76	4,3	1,2	7
QCMX 060412 .X52	○		●											13,8	14,8	4,76	4,3	1,2	7
QCMX 080412 .X52	○		●											17,2	18,5	4,76	4,3	1,2	7



QCMX ...X36 = CONSIGLIATO PER ACCIAIO NON LEGATO RECOMMENDED FOR NOT ALLOY STEEL



QCMX ...X42 = CONSIGLIATO PER ACCIAIO INOX RECOMMENDED FOR STAINLESS STEEL



QCMX ...X52 = CONSIGLIATO PER ACCIAIO RECOMMENDED FOR STEEL



QCMX ...X52 = CONSIGLIATO PER GHISA RECOMMENDED FOR CAST IRON

MATERIALI - MATERIALS Pag. 1199		VDI 3323 GR.	HB Rm ¹⁾ HRC ²⁾	fn mm						Vc m/min Pag. 694			
				Ø15-19,5	Ø20-23	Ø23,5-29,5	Ø30-39	Ø40-49	Ø50	T3610	T5320	T5322	T530
P	ACCIAIO NON LEGATO - NOT ALLOY STEEL	1-5	125-300	0,04-0,09	0,04-0,11	0,04-0,13	0,05-0,14	0,05-0,16	0,07-0,18			300	180
	ACCIAIO POCO LEGATO - LOW ALLOY STEEL	6-9	180-350	0,04-0,11	0,04-0,14	0,04-0,18	0,05-0,20	0,05-0,23	0,07-0,27		280	280	170
	ACCIAIO ALTO LEGATO - ALLOY STEEL	10-11	200-325	0,04-0,11	0,04-0,14	0,04-0,18	0,05-0,20	0,05-0,23	0,07-0,27	240	250		
	INOX MARTENS. - STAINLESS STEEL MART	12-13	200-240	0,04-0,09	0,04-0,09	0,04-0,11	0,05-0,14	0,05-0,18	0,07-0,20	180	200		
M	INOX AUST. DUPLEX - STAINLESS STEEL AUST	14.1-14.2	180-230	0,04-0,07	0,04-0,11	0,05-0,16	0,05-0,18	0,05-0,20	0,07-0,23		140	200	120
K	GHISA GRIGIA - GREY CAST IRON	15-16	180-260	0,05-0,14	0,05-0,16	0,05-0,20	0,05-0,22	0,07-0,23	0,07-0,27	350	280		
	GHISA SFEROIDALE - SPHEROIDAL GRAPHITE	17-18	160-250	0,05-0,14	0,05-0,16	0,05-0,20	0,05-0,22	0,07-0,23	0,07-0,27	280	240		
	GHISA MALLEABILE - MALLEABLE CAST IRON	19-20	130-230	0,05-0,14	0,05-0,16	0,05-0,20	0,05-0,22	0,07-0,23	0,07-0,27	300	260		
N	ALLUMINIO E SUE LEGHE - ALUMINIUM	21-25	60-130	0,05-0,13	0,07-0,16	0,09-0,20	0,09-0,22	0,09-0,25	0,11-0,27			400	400
	RAME E SUE LEGHE - COPPER	26-28	90-110	0,04-0,13	0,04-0,14	0,05-0,18	0,05-0,18	0,09-0,23	0,09-0,23			300	300
	NON METALLICI - PLASTICS	29-30	/	0,04-0,13	0,04-0,14	0,05-0,18	0,05-0,18	0,09-0,23	0,09-0,23			300	300
S	LEGHE RESIST. CALORE - HIG. TEMP. ALLOY	31-35	200-320										
	TITANIO E SUE LEGHE - TITANIUM	36-37	400-1050 ¹⁾										
H	ACCIAIO TEMPRATO - HARDENED STEEL	38-41	45-60 ²⁾										

Vc = m/min VELOCITÀ DI TAGLIO - CUTTING SPEED
n = giri/min (min⁻¹) NUMERO DI GIRI - NUMBER OF REVOLUTIONS
fn = mm AVANZAMENTO AL GIRO - FEED / REVOLUTION
Vf = mm/min VELOCITÀ DI AVANZAMENTO - FEED SPEED

$$Vf = fn \cdot n = \text{mm/min}$$

$$n = \frac{Vc \cdot 1000}{\varnothing D \cdot 3,14} = \text{giri/min (min}^{-1}\text{)}$$

■ DISPONIBILI - IN STOCK - LIEFERBAR - DISPONIBLES / ■ NEW
●● APPLICAZIONE CONSIGLIATA-RECOMMENDED APPLICATION
EMPFÖHLENER EINSATZ - APPLICATION CONSEILLÉE

□ A RICHIESTA - ON REQUEST - AUF ANFRAGE - SUR DEMANDE / □ NEW
○ ○ APPLICAZIONE POSSIBILE - POSSIBLE APPLICATION
MÖGLICHE ANWENDUNG - APPLICATION POSSIBLE

TDC ..30R/L

Ø 17,5-59

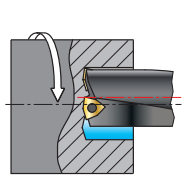

DISASSAMENTO TEORICO
THEORETICAL OFFSET

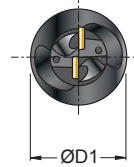
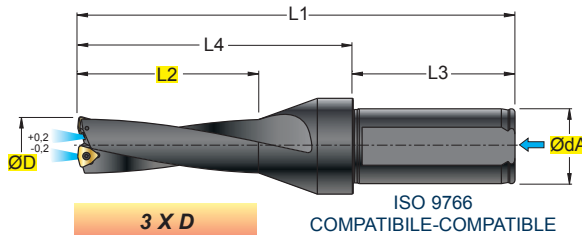

WCMTK58		
WCMXS42		
WCMXS62/.O62		
INSERTI - INSERTS PAG. 685		

ART.	(mm)								kg	Nm					
	ØD ^{+0,2} / _{-0,2}	ØdA	ØD1	L1	L2	L3	L4								
TDC 17530R/L	17,5	25	32	138,5	54,5	54	84,5	0,38	1,1+1,3	030208	12256P	5608P			
TDC 18030R/L	18	25	32	140	56	54	86	0,38	1,1+1,3						
TDC 18530R/L	18,5	25	32	141,5	57,5	54	87,5	0,38	1,1+1,3						
TDC 19030R/L	19	25	32	143	59	54	89	0,38	1,1+1,3						
TDC 19530R/L	19,5	25	32	144,5	60,5	54	90,5	0,39	1,1+1,3						
TDC 20030R/L	20	25	32	146	62	54	92	0,39	1,1+1,3						
TDC 20530R/L	20,5	25	32	147,5	63,5	54	93,5	0,40	1,1+1,3						
TDC 21030R/L	21	25	32	149	65	54	95	0,41	1,1+1,3	040208	12256P	5608P			
TDC 21530R/L	21,5	25	32	150,5	66,5	54	96,5	0,41	1,1+1,3						
TDC 22030R/L	22	25	32	152	68	54	98	0,42	1,1+1,3						
TDC 22530R/L	22,5	25	32	153,5	69,5	54	99,5	0,42	1,1+1,3						
TDC 23030R/L	23	25	32	155	71	54	101	0,43	1,1+1,3						
TDC 23530R/L	23,5	25	32	156,5	72,5	54	102,5	0,44	1,1+1,3						
TDC 24030R/L	24	25	32	158	74	54	104	0,45	1,1+1,3						
TDC 24530R/L	24,5	25	32	159,5	75,5	54	105,5	0,45	1,1+1,3						
TDC 25030R/L	25	25	32	161	77	54	107	0,46	1,1+1,3						
TDC 25530R/L	25,5	25	32	162,5	78,5	54	108,5	0,47	1,1+1,3						
TDC 26030R/L	26	25	32	164	80	54	110	0,48	1,2+1,5	050308	123008P	5608P			
TDC 26530R/L	26,5	25	32	165,5	81,5	54	111,5	0,49	1,2+1,5						
TDC 27030R/L	27	25	32	167	83	54	113	0,50	1,2+1,5						
TDC 28030R/L	28	25	32	170	86	54	116	0,52	1,2+1,5						
TDC 29030R/L	29	25	32	173	89	54	119	0,55	1,2+1,5						
TDC 30030R/L	30	32	49	180	92	58	122	0,84	1,2+1,5				050308	123008P	5608P
TDC 31030R/L	31	32	49	183	95	58	125	0,87	2,0+3,0	06T308	123009P	5610P			
TDC 32030R/L	32	32	49	186	98	58	128	0,88	2,0+3,0						
TDC 33030R/L	33	32	49	189	101	58	131	0,91	2,0+3,0						
TDC 34030R/L	34	32	49	192	104	58	134	0,95	2,0+3,0						
TDC 35030R/L	35	32	49	195	107	58	137	0,98	2,0+3,0						
TDC 36030R/L	36	32	49	198	110	58	140	1,02	2,0+3,0						
TDC 37030R/L	37	32	49	201	113	58	143	1,06	2,0+3,0						
TDC 38030R/L	38	32	49	204	116	58	146	1,09	2,0+3,0						
TDC 39030R/L	39	32	49	207	119	58	149	1,13	2,0+3,0						
TDC 40030R/L	40	32	49	210	122	58	152	1,18	2,0+3,0						
TDC 41030R/L	41	32	49	213	125	58	155	1,23	2,0+3,0						
TDC 42030R/L	42	32	49	216	128	58	158	1,27	3,8+5,0				080412	C04011P	5615P
TDC 43030R/L	43	32	49	219	131	58	161	1,31	3,8+5,0						
TDC 44030R/L	44	32	49	222	134	58	164	1,35	3,8+5,0						
TDC 45030R/L	45	40	59	240	137	68	172	1,91	3,8+5,0	080412	C04011P	5615P			
TDC 46030R/L	46	40	59	243	140	68	175	1,93	3,8+5,0						
TDC 47030R/L	47	40	59	246	143	68	178	2,02	3,8+5,0						
TDC 48030R/L	48	40	59	249	146	68	181	2,09	3,8+5,0						
TDC 49030R/L	49	40	59	252	149	68	184	2,12	3,8+5,0						
TDC 50030R/L	50	40	59	255	152	68	187	2,22	3,8+5,0						
TDC 51030R/L	51	40	59	258	155	68	190	2,27	3,8+5,0						
TDC 52030R/L	52	40	59	261	158	68	193	2,32	3,8+5,0						
TDC 53030R/L	53	40	59	264	161	68	196	2,52	3,8+5,0						
TDC 54030R/L	54	40	59	267	164	68	199	2,57	3,8+5,0						
TDC 55030R/L	55	40	59	270	167	68	202	2,82	3,8+5,0						
TDC 56030R/L	56	40	59	273	170	68	205	2,92	3,8+5,0						
TDC 57030R/L	57	40	59	276	173	68	208	3,02	3,8+5,0						
TDC 58030R/L	58	40	59	279	176	68	211	3,12	3,8+5,0						
TDC 59030R/L	59	40	59	282	179	68	214	3,22	3,8+5,0						



(■) LAVORAZIONE OTTIMALE - OPTIMUM MACHINING - OPTIMALE BEARBEITUNG - USINAGE OPTIMALE
 (○) LAVORAZIONE POSSIBILE - POSSIBLE MACHINING - MOEGICHE BEARBEITUNG - USINAGE POSSIBLE

SCelta VELOCE - QUICK PICK							Tenacità + ↑ Toughness - ↓			Pag. 688			HT		HW		HC										
COD.	P	M	K	N	S	H	CERMET		NON RIV. CEMENTED CARBIDE GRADES		RIVESTITI COATED GRADES BESCHICHTET RECOUVERTS					l	d	s	d1	r	a°						
							T120	T7530	T540																		
WCMT 030204 .K58	●	●																				3,8	5,56	2,38	2,5	0,4	7°
WCMT 040204 .K58	●	●																				4,3	6,35	2,38	2,8	0,4	7°
WCMT 050308 .K58	●	●																				5,4	7,94	3,18	3,4	0,8	7°
WCMT 06T308 .K58	●	●																				6,5	9,52	3,97	4,0	0,8	7°
WCMT 080408 .K58	●	●																				8,7	12,7	4,76	4,3	0,8	7°
WCMX 030208 .S62			○	●	○		■															3,46	5,56	2,38	2,5	0,8	7°
WCMX 040208 .S62			○	●	○		■															3,99	6,35	2,38	2,8	0,8	7°
WCMX 050308 .S62			○	●	○		■															5,07	7,94	3,18	3,4	0,8	7°
WCMX 06T308 .O62			○	●	○		■															6,14	9,52	3,97	3,8	0,8	7°
WCMX 080412 .S62			○	●	○		■															8,14	12,7	4,76	4,4	1,2	7°
WCMX 030208 .S62	●	●	○		○																	3,46	5,56	2,38	2,5	0,8	7°
WCMX 040208 .S62	●	●	○		○																	3,99	6,35	2,38	2,8	0,8	7°
WCMX 050308 .S62	●	●	○		○																	5,07	7,94	3,18	3,4	0,8	7°
WCMX 06T308 .S62	●	●	○		○																	6,14	9,52	3,97	3,8	0,8	7°
WCMX 080412 .S62	●	●	○		○																	8,14	12,7	4,76	4,4	1,2	7°
WCMX 040208 .S42	●	●	○		●																	3,99	6,35	2,38	2,8	0,8	7°
WCMX 050308 .S42	●	●	○		●																	5,07	7,94	3,18	3,4	0,8	7°
WCMX 06T308 .S42	●	●	○		●																	6,14	9,52	3,97	3,8	0,8	7°
WCMX 080412 .S42	●	●	○		●																	8,14	12,7	4,76	4,4	1,2	7°



WCMX .S62/O62 = 1° SCELTA PER IMPIEGO GENERICO

1° CHOICE FOR GENERIC USE



WCMX ... S42 = CONTROLLO DEL TRUCIOLO A BASSI AVANZAMENTI

CHIP CONTROL WITH LOW FEEDS



WCMT ... K58 = CONSIGLIATO PER ACCIAIO INOX

RECOMMENDED FOR STAINLESS STEEL

MATERIALI - MATERIALS Pag. 1199		VDI 3323 GR.	HB Rm ¹⁾ HRC ²⁾	fn mm					Vc m/min Pag. 694					
				Ø17,5-20,5	Ø21-25,5	Ø26-30	Ø31-41	Ø42-59		T120	T7530	T540		
P	ACCIAIO NON LEGATO - NOT ALLOY STEEL	1--5	125-300	0,04-0,12	0,06-0,14	0,10-0,18	0,12-0,2	0,12-0,20			180	150		
	ACCIAIO POCO LEGATO - LOW ALLOY STEEL	6--9	180-350	0,04-0,12	0,06-0,14	0,10-0,18	0,12-0,2	0,12-0,20			150	150		
	ACCIAIO ALTO LEGATO - ALLOY STEEL	10-11	200-325	0,04-0,12	0,06-0,14	0,10-0,18	0,12-0,2	0,12-0,20			130			
	INOX MARTENS. - STAINLESS STEEL MART	12-13	200-240	0,04-0,12	0,06-0,14	0,10-0,18	0,12-0,2	0,12-0,20			130			
M	INOX AUST. DUPLEX - STAINLESS STEEL AUST	14.1-14.2	180-230	0,04-0,12	0,06-0,12	0,10-0,14	0,12-0,16	0,12-0,18			140	130		
K	GHISA GRIGIA - GREY CAST IRON	15-16	180-260	0,08-0,16	0,08-0,18	0,12-0,2	0,14-0,26	0,15-0,28		80	110			
	GHISA SFEROIDALE - SPHEROIDAL GRAPHITE	17-18	160-250	0,08-0,14	0,08-0,14	0,12-0,18	0,14-0,2	0,15-0,22			110			
	GHISA MALLEABILE - MALLEABLE CAST IRON	19-20	130-230	0,08-0,16	0,08-0,18	0,12-0,2	0,14-0,26	0,15-0,28			110			
N	ALLUMINIO E SUE LEGHE - ALUMINIUM	21--25	60-130	0,06-0,16	0,06-0,16	0,10-0,18	0,12-0,22	0,14-0,26		350				
	RAME E SUE LEGHE - COPPER	26--28	90-110	0,06-0,16	0,06-0,16	0,10-0,18	0,12-0,22	0,14-0,26		200				
	NON METALLICI - PLASTICS	29-30	/	-	-	-	-	-						
S	LEGHE RESIST. CALORE - HIG. TEMP. ALLOY	31--35	200-320	0,04-0,08	0,04-0,08	0,06-0,1	0,08-0,12	0,09-0,14			40			
	TITANIO E SUE LEGHE - TITANIUM	36-37	400-1050 ¹⁾	0,08-0,14	0,08-0,14	0,12-0,16	0,14-0,18	0,16-0,2			40			
H	ACCIAIO TEMPRATO - HARDENED STEEL	38--41	45-60 ²⁾											

Vc = m/min VELOCITÀ DI TAGLIO - CUTTING SPEED
n = giri/min (min⁻¹) NUMERO DI GIRI - NUMBER OF REVOLUTIONS
fn = mm AVANZAMENTO AL GIRO - FEED / REVOLUTION
Vf = mm/min VELOCITÀ DI AVANZAMENTO - FEED SPEED

$$Vf = fn \cdot n = \text{mm/min}$$

$$n = \frac{Vc \cdot 1000}{\varnothing D \cdot 3,14} = \text{giri/min (min}^{-1}\text{)}$$

TDC ..40R/L

Ø 17,5-50

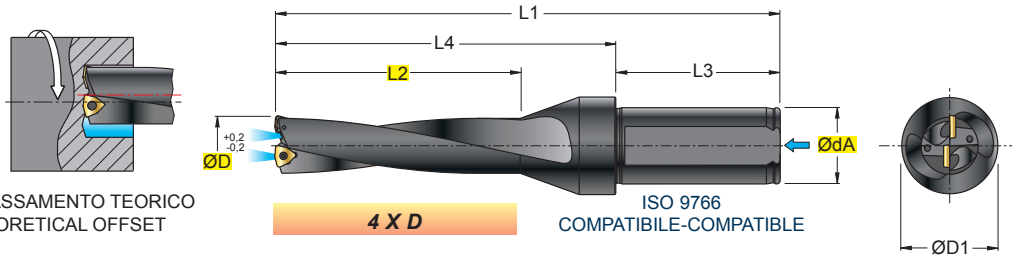

WCMTK58		
WCMXS42		
WCMXS62/.O62		
INSERTI - INSERTS PAG. 685		

ART.	(mm)								kg	Nm					
	ØD ^{+0,2} / _{-0,2}	ØdA	ØD1	L1	L2	L3	L4								
TDC 17540R/L	17,5	25	32	156	72	54	102	0,41	1,1+1,3	030208	12256P	5608P			
TDC 18040R/L	18	25	32	158	74	54	104	0,41	1,1+1,3						
TDC 18540R/L	18,5	25	32	160	76	54	106	0,42	1,1+1,3						
TDC 19040R/L	19	25	32	162	78	54	108	0,42	1,1+1,3						
TDC 19540R/L	19,5	25	32	164	80	54	110	0,44	1,1+1,3						
TDC 20040R/L	20	25	32	166	82	54	112	0,44	1,1+1,3						
TDC 20540R/L	20,5	25	32	168	84	54	114	0,45	1,1+1,3						
TDC 21040R/L	21	25	32	170	86	54	116	0,45	1,1+1,3	040208	12256P	5608P			
TDC 21540R/L	21,5	25	32	172	88	54	118	0,47	1,1+1,3						
TDC 22040R/L	22	25	32	174	90	54	120	0,47	1,1+1,3						
TDC 22540R/L	22,5	25	32	176	92	54	122	0,49	1,1+1,3						
TDC 23040R/L	23	25	32	178	94	54	124	0,49	1,1+1,3						
TDC 23540R/L	23,5	25	32	180	96	54	126	0,49	1,1+1,3						
TDC 24040R/L	24	25	32	182	98	54	128	0,49	1,1+1,3						
TDC 24540R/L	24,5	25	32	184	100	54	130	0,53	1,1+1,3						
TDC 25040R/L	25	25	32	186	102	54	132	0,53	1,1+1,3						
TDC 25540R/L	25,5	25	32	188	104	54	134	0,55	1,1+1,3						
TDC 26040R/L	26	25	32	190	106	54	136	0,55	1,2+1,5	050308	123008P	5608P			
TDC 26540R/L	26,5	25	32	192	108	54	138	0,57	1,2+1,5						
TDC 27040R/L	27	25	32	194	110	54	140	0,57	1,2+1,5						
TDC 28040R/L	28	25	32	198	114	54	144	0,60	1,2+1,5						
TDC 29040R/L	29	25	32	202	118	54	148	0,63	1,2+1,5						
TDC 30040R/L	30	32	49	210	122	58	152	0,96	1,2+1,5				050308	123008P	5608P
TDC 31040R/L	31	32	49	214	126	58	156	1,00	2,0+3,0	06T308	123009P	5610P			
TDC 32040R/L	32	32	49	218	130	58	160	1,02	2,0+3,0						
TDC 33040R/L	33	32	49	222	134	58	164	1,06	2,0+3,0						
TDC 34040R/L	34	32	49	226	138	58	168	1,10	2,0+3,0						
TDC 35040R/L	35	32	49	230	142	58	172	1,15	2,0+3,0						
TDC 36040R/L	36	32	49	234	146	58	176	1,19	2,0+3,0						
TDC 37040R/L	37	32	49	238	150	58	180	1,24	2,0+3,0						
TDC 38040R/L	38	32	49	242	154	58	184	1,30	2,0+3,0						
TDC 39040R/L	39	32	49	246	158	58	188	1,35	2,0+3,0						
TDC 40040R/L	40	32	49	250	162	58	192	1,41	2,0+3,0						
TDC 41040R/L	41	32	49	254	166	58	196	1,47	2,0+3,0						
TDC 42040R/L	42	32	49	258	170	58	200	1,54	3,8+5,0				080412	C04011P	5615P
TDC 43040R/L	43	32	49	262	174	58	204	1,58	3,8+5,0						
TDC 44040R/L	44	32	49	266	178	58	208	1,66	3,8+5,0				080412	C04011P	5615P
TDC 45040R/L	45	40	59	285	182	68	217	2,22	3,8+5,0						
TDC 46040R/L	46	40	59	289	186	68	221	2,31	3,8+5,0						
TDC 47040R/L	47	40	59	293	190	68	225	2,38	3,8+5,0						
TDC 48040R/L	48	40	59	297	194	68	229	2,42	3,8+5,0						
TDC 49040R/L	49	40	59	301	198	68	233	2,52	3,8+5,0						
TDC 50040R/L	50	40	59	305	202	68	237	2,62	3,8+5,0						

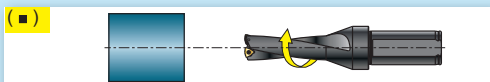

(■) LAVORAZIONE OTTIMALE - OPTIMUM MACHINING - OPTIMALE BEARBEITUNG - USINAGE OPTIMALE
(□) LAVORAZIONE POSSIBILE - POSSIBLE MACHINING - MOEGISCHE BEARBEITUNG - USINAGE POSSIBLE

SCelta VELOCE - QUICK PICK							Tenacità + ↑ Toughness - ↓			Pag. 688			HT	HW	HC						
							CERMET			NON RIV. CEMENTED CARBIDE GRADES			RIVESTITI COATED GRADES BESCHICHTET RECOUVERTS						l	d	s
COD.	P	M	K	N	S	H	T120	T7530	T540												
WCMT 030204 .K58	●	●							■												
WCMT 040204 .K58	●	●							■												
WCMT 050308 .K58	●	●							■												
WCMT 06T308 .K58	●	●							■												
WCMT 080408 .K58	●	●							■												
WCMX 030208 .S62			○	●	○		■														
WCMX 040208 .S62			○	●	○		■														
WCMX 050308 .S62			○	●	○		■														
WCMX 06T308 .O62			○	●	○		■														
WCMX 080412 .S62			○	●	○		■														
WCMX 030208 .S62	●	●	○		○				■												
WCMX 040208 .S62	●	●	○		○				■												
WCMX 050308 .S62	●	●	○		○				■												
WCMX 06T308 .S62	●	●	○		○				■												
WCMX 080412 .S62	●	●	○		○				■												
WCMX 040208 .S42	●	●	○		●				■												
WCMX 050308 .S42	●	●	○		●				■												
WCMX 06T308 .S42	●	●	○		●				■												
WCMX 080412 .S42	●	●	○		●				■												

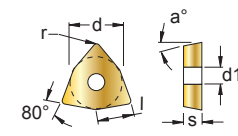

WCMX .S62/O62 = 1° SCELTA PER IMPIEGO GENERICO

1° CHOICE FOR GENERIC USE



WCMX ... S42 = CONTROLLO DEL TRUCIOLO A BASSI AVANZAMENTI

CHIP CONTROL WITH LOW FEEDS



WCMT ... K58 = CONSIGLIATO PER ACCIAIO INOX

RECOMMENDED FOR STAINLESS STEEL

MATERIALI - MATERIALS Pag. 1199		VDI 3323 GR.	HB Rm ¹⁾ HRC ²⁾	fn mm					Vc m/min Pag. 694				
				Ø17,5-20,5	Ø21-25,5	Ø26-30	Ø31-41	Ø42-50	T120	T7530	T540		
P	ACCIAIO NON LEGATO - NOT ALLOY STEEL	1-5	125-300	0,04-0,10	0,06-0,14	0,10-0,18	0,12-0,2	0,12-0,20		180	150		
	ACCIAIO POCO LEGATO - LOW ALLOY STEEL	6-9	180-350	0,04-0,10	0,06-0,14	0,10-0,18	0,12-0,2	0,12-0,20		150	150		
	ACCIAIO ALTO LEGATO - ALLOY STEEL	10-11	200-325	0,04-0,10	0,06-0,14	0,10-0,18	0,12-0,2	0,12-0,20		130			
	INOX MARTENS. - STAINLESS STEEL MART	12-13	200-240	0,04-0,10	0,06-0,14	0,10-0,18	0,12-0,2	0,12-0,20		130			
M	INOX AUST. DUPLEX - STAINLESS STEEL AUST	14.1-14.2	180-230	0,04-0,14	0,06-0,12	0,10-0,14	0,12-0,16	0,12-0,18		140	130		
K	GHISA GRIGIA - GREY CAST IRON	15-16	180-260	0,08-0,16	0,08-0,18	0,12-0,2	0,14-0,26	0,15-0,28	80	110			
	GHISA SFEROIDALE - SPHEROIDAL GRAPHITE	17-18	160-250	0,08-0,14	0,08-0,14	0,12-0,18	0,14-0,2	0,15-0,22		110			
	GHISA MALLEABILE - MALLEABLE CAST IRON	19-20	130-230	0,08-0,16	0,08-0,18	0,12-0,2	0,14-0,26	0,15-0,28		110			
N	ALLUMINIO E SUE LEGHE - ALUMINIUM	21-25	60-130	0,06-0,16	0,06-0,16	0,10-0,18	0,12-0,22	0,14-0,26	350				
	RAME E SUE LEGHE - COPPER	26-28	90-110	0,06-0,16	0,06-0,16	0,10-0,18	0,12-0,22	0,14-0,26	200				
	NON METALLICI - PLASTICS	29-30	/	-	-	-	-	-					
S	LEGHE RESIST. CALORE - HIG. TEMP. ALLOY	31-35	200-320	0,04-0,08	0,04-0,08	0,06-0,1	0,08-0,12	0,09-0,14		40			
	TITANIO E SUE LEGHE - TITANIUM	36-37	400-1050 ¹⁾	0,08-0,14	0,08-0,14	0,12-0,16	0,14-0,18	0,16-0,2		40			
H	ACCIAIO TEMPRATO - HARDENED STEEL	38-41	45-60 ²⁾										

Vc = m/min VELOCITÀ DI TAGLIO - CUTTING SPEED
n = giri/min (min⁻¹) NUMERO DI GIRI - NUMBER OF REVOLUTIONS
fn = mm AVANZAMENTO AL GIRO - FEED / REVOLUTION
Vf = mm/min VELOCITÀ DI AVANZAMENTO - FEED SPEED

$$Vf = fn \cdot n = \text{mm/min}$$

$$n = \frac{Vc \cdot 1000}{\varnothing D \cdot 3,14} = \text{giri/min (min}^{-1}\text{)}$$

■ DISPONIBILI - IN STOCK - LIEFERBAR - DISPONIBLES / ■ NEW
●● APPLICAZIONE CONSIGLIATA - RECOMMENDED APPLICATION
EMPFÖHLENER EINSATZ - APPLICATION CONSEILLÉE

□ A RICHIESTA - ON REQUEST - AUF ANFRAGE - SUR DEMANDE / □ NEW
○● APPLICAZIONE POSSIBILE - POSSIBLE APPLICATION
MÖGLICHE ANWENDUNG - APPLICATION POSSIBLE

TDCS ..30R

Ø 17,5-40

IN ESAURIMENTO
END OF STOCK
AUSLAUFEND
EN ÉPUISEMENT

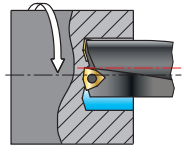

DISASSAMENTO TEORICO
THEORETICAL OFFSET

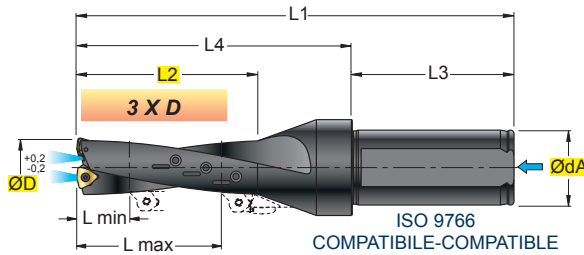

ISO 9766
COMPATIBILE-COMPATIBLE

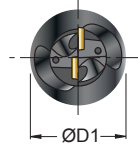

WCMTK58		
WCMXS42		
WCMXS62/.O62		
INSERTI - INSERTS PAG. 685		

ART.	(mm)											kg	Nm					
	ØD	ØdA	ØD1	Lmin	Lmax	L1	L2	L3	L4	Lmin	Lmax							
TDCS 17530R	17,5	25	32	12,0	48,0	138,5	54,5	54	84,5	0,38	1,1+1,3	030208	12256P	5608P	n°6 12404P	-		
TDCS 18030R	18,0	25	32	13,5	49,5	140,0	56,0	54	86,0	0,38	1,1+1,3							
TDCS 18530R	18,5	25	32	15,0	51,0	141,5	57,5	54	87,5	0,38	1,1+1,3							
TDCS 19030R	19,0	25	32	16,5	52,5	143,0	59,0	54	89,0	0,38	1,1+1,3							
TDCS 19530R	19,5	25	32	12,0	54,0	144,5	60,5	54	90,5	0,39	1,1+1,3	030208	12256P	5608P	n°7 12404P	-		
TDCS 20030R	20,0	25	32	13,5	55,5	146,0	62,0	54	92,0	0,39	1,1+1,3							
TDCS 20530R	20,5	25	32	15,0	57,0	147,5	63,5	54	93,5	0,40	1,1+1,3							
TDCS 21030R	21,0	25	32	16,5	58,5	149,0	65,0	54	95,0	0,41	1,1+1,3							
TDCS 21530R	21,5	25	32	18,0	60,0	150,5	66,5	54	96,5	0,41	1,1+1,3	040208	12256P	5608P	n°7 12404P	-		
TDCS 22030R	22,0	25	32	19,5	61,5	152,0	68,0	54	98,0	0,42	1,1+1,3							
TDCS 22530R	22,5	25	32	15,0	63,0	153,5	69,5	54	99,5	0,42	1,1+1,3							
TDCS 23030R	23,0	25	32	16,5	64,5	155,0	71,0	54	101,0	0,43	1,1+1,3							
TDCS 23530R	23,5	25	32	18,0	66,0	156,5	72,5	54	102,5	0,44	1,1+1,3	040208	12256P	5608P	n°8 12404P	-		
TDCS 24030R	24,0	25	32	19,5	67,5	158,0	74,0	54	104,0	0,45	1,1+1,3							
TDCS 24530R	24,5	25	32	21,0	69,0	159,5	75,5	54	105,5	0,45	1,1+1,3							
TDCS 25030R	25,0	25	32	22,5	70,5	161,0	77,0	54	107,0	0,46	1,1+1,3							
TDCS 25530R	25,5	25	32	18,0	72,0	162,5	78,5	54	108,5	0,47	1,1+1,3	040208	12256P	5608P	n°9 12404P	-		
TDCS 26030R	26,0	25	32	19,5	73,5	164,0	80,0	54	110,0	0,48	1,2+1,5							
TDCS 26530R	26,5	25	32	21,0	75,0	165,5	81,5	54	111,5	0,49	1,2+1,5							
TDCS 27030R	27,0	25	32	22,5	76,5	167,0	83,0	54	113,0	0,50	1,2+1,5							
TDCS 27530R	27,5	25	32	24,0	78,0	168,5	84,5	54	114,5	0,51	1,2+1,5	050308	123008P	5608P	n°10 12404P	-		
TDCS 28030R	28,0	25	32	25,5	79,5	170,0	86,0	54	116,0	0,52	1,2+1,5							
TDCS 28530R	28,5	25	32	21,0	81,0	171,5	87,5	54	117,5	0,53	1,2+1,5							
TDCS 29030R	29,0	25	32	22,5	82,5	173,0	89,0	54	119,0	0,55	1,2+1,5							
TDCS 29530R	29,5	25	32	24,0	84,5	174,5	90,5	54	120,5	0,56	1,2+1,5	050308	123008P	5608P	n°10 12404P	-		
TDCS 30030R	30,0	32	49	25,5	85,5	180,0	92,0	58	122,0	0,84	1,2+1,5							
TDCS 30530R	30,5	32	49	27,0	87,0	181,5	93,5	58	123,5	0,85	1,2+1,5							
TDCS 31030R	31,0	32	49	28,5	88,5	183,0	95,0	58	125,0	0,87	2,0+3,0							
TDCS 31530R	31,5	32	49	24,0	90,0	184,5	96,5	58	126,5	0,87	2,0+3,0	06T308	123009P	5610P	n°10 12404P	5608P		
TDCS 32030R	32,0	32	49	25,5	91,5	186,0	98,0	58	128,0	0,88	2,0+3,0							
TDCS 32530R	32,5	32	49	27,0	93,0	187,5	99,5	58	129,5	0,90	2,0+3,0							
TDCS 33030R	33,0	32	49	28,5	94,5	189,0	101,0	58	131,0	0,91	2,0+3,0							
TDCS 33530R	33,5	32	49	30,0	96,0	190,5	102,5	58	132,5	0,92	2,0+3,0	06T308	123009P	5610P	n°11 12404P	5608P		
TDCS 34030R	34,0	32	49	31,5	97,5	192,0	104,0	58	134,0	0,95	2,0+3,0							
TDCS 34530R	34,5	32	49	27,0	99,0	193,5	105,5	58	135,5	0,96	2,0+3,0							
TDCS 35030R	35,0	32	49	28,5	100,5	195,0	107,0	58	137,0	0,98	2,0+3,0							
TDCS 35530R	35,5	32	49	30,0	102,0	196,5	108,5	58	138,5	1,00	2,0+3,0	06T308	123009P	5610P	n°12 12404P	5608P		
TDCS 36030R	36,0	32	49	31,5	103,5	198,0	110,0	58	140,0	1,02	2,0+3,0							
TDCS 36530R	36,5	32	49	33,0	105,0	199,5	111,5	58	141,5	1,04	2,0+3,0							
TDCS 37030R	37,0	32	49	34,5	106,5	201,0	113,0	58	143,0	1,06	2,0+3,0							
TDCS 37530R	37,5	32	49	30,0	108,0	202,5	114,5	58	144,5	1,07	2,0+3,0	06T308	123009P	5610P	n°13 12404P	5608P		
TDCS 38030R	38,0	32	49	31,5	109,5	204,0	116,0	58	146,0	1,09	2,0+3,0							
TDCS 38530R	38,5	32	49	33,0	111,0	205,5	117,5	58	147,5	1,11	2,0+3,0							
TDCS 39030R	39,0	32	49	34,5	112,5	207,0	119,0	58	149,0	1,13	2,0+3,0							
TDCS 39530R	39,5	32	49	36,0	114,0	208,5	120,5	58	150,5	1,15	2,0+3,0	06T308	123009P	5610P	n°13 12404P	5608P		
TDCS 40030R	40,0	32	49	37,5	115,5	210,0	122,0	58	152,0	1,18	2,0+3,0							

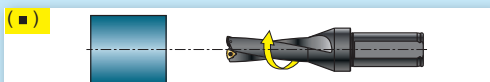

(■) LAVORAZIONE OTTIMALE - OPTIMUM MACHINING - OPTIMALE BEARBEITUNG - USINAGE OPTIMALE
(○) LAVORAZIONE POSSIBILE - POSSIBLE MACHINING - MOEGICHE BEARBEITUNG - USINAGE POSSIBLE

SCelta VELOCE - QUICK PICK							Tenacità + ↑ Toughness - ↓			Pag. 688		HT	HW	HC													
							CERMET		NON RIV. CEMENTED CARBIDE GRADES		RIVESTITI COATED GRADES BESCHICHTET RECOUVERTS					T120	T7530	T540									
COD.	P	M	K	N	S	H																					
WCMT 030204 .K58	●	●																									
WCMT 040204 .K58	●	●																									
WCMT 050308 .K58	●	●																									
WCMT 06T308 .K58	●	●																									
WCMT 080408 .K58	●	●																									
WCMX 030208 .S62			○	●	○																						
WCMX 040208 .S62			○	●	○																						
WCMX 050308 .S62			○	●	○																						
WCMX 06T308 .O62			○	●	○																						
WCMX 080412 .S62			○	●	○																						
WCMX 030208 .S62	●	●	○	○	○																						
WCMX 040208 .S62	●	●	○	○	○																						
WCMX 050308 .S62	●	●	○	○	○																						
WCMX 06T308 .S62	●	●	○	○	○																						
WCMX 080412 .S62	●	●	○	○	○																						
WCMX 040208 .S42	●	●	○	○	○																						
WCMX 050308 .S42	●	●	○	○	○																						
WCMX 06T308 .S42	●	●	○	○	○																						
WCMX 080412 .S42	●	●	○	○	○																						

WCMX.S62/O62 = 1° SCELTA PER IMPIEGO GENERICO / 1° CHOICE FOR GENERIC USE
 WCMX ... S42 = CONTROLLO DEL TRUCIOLO A BASSI AVANZAMENTI / CHIP CONTROL WITH LOW FEEDS
 WCMT ... K58 = CONSIGLIATO PER ACCIAIO INOX / RECOMMENDED FOR STAINLESS STEEL

QUANDO LO SMUSSATORE "SPU 1840-07" SI AVVICINA AL MATERIALE DA LAVORARE, RIDURRE L'AVANZAMENTO DEL 50%
 AS THE "SPU 1840-07" CHAMFERING TOOL APPROACHES THE WORKPIECE, REDUCE FEED BY 50%

MATERIALI - MATERIALS		VDI 3323 GR.	HB Rm ¹⁾ HRC ²⁾	fn mm				Vc m/min					
Pag. 1199				Ø17,5-20,5	Ø21-25,5	Ø26-30,5	Ø31-40	T120	T7530	T540			
P	ACCIAIO NON LEGATO - NOT ALLOY STEEL	1-5	125-300	0,04-0,12	0,06-0,14	0,10-0,18	0,12-0,2						
	ACCIAIO POCO LEGATO - LOW ALLOY STEEL	6-9	180-350	0,04-0,12	0,06-0,14	0,10-0,18	0,12-0,2		180	150			
	ACCIAIO ALTO LEGATO - ALLOY STEEL	10-11	200-325	0,04-0,12	0,06-0,14	0,10-0,18	0,12-0,2		150	150			
	INOX MARTENS. - STAINLESS STEEL MART	12-13	200-240	0,04-0,12	0,06-0,14	0,10-0,18	0,12-0,2		130				
M	INOX AUST. DUPLEX - STAINLESS STEEL AUST	14.1-14.2	180-230	0,04-0,12	0,06-0,12	0,10-0,14	0,12-0,16			140	130		
	GHISA GRIGIA - GREY CAST IRON	15-16	180-260	0,08-0,16	0,08-0,18	0,12-0,2	0,14-0,26		80	110			
	GHISA SFEROIDALE - SPHEROIDAL GRAPHITE	17-18	160-250	0,08-0,14	0,08-0,14	0,12-0,18	0,14-0,2			110			
K	GHISA MALLEABILE - MALLEABLE CAST IRON	19-20	130-230	0,08-0,16	0,08-0,18	0,12-0,2	0,14-0,26			110			
	ALLUMINIO E SUE LEGHE - ALUMINIUM	21-25	60-130	0,06-0,16	0,06-0,16	0,10-0,18	0,12-0,22		350				
N	RAME E SUE LEGHE - COPPER	26-28	90-110	0,06-0,16	0,06-0,16	0,10-0,18	0,12-0,22		200				
	NON METALLICI - PLASTICS	29-30	/	-	-	-	-						
S	LEGHE RESIST. CALORE - HIG. TEMP. ALLOY	31-35	200-320	0,04-0,08	0,04-0,08	0,06-0,1	0,08-0,12		40				
	TITANIO E SUE LEGHE - TITANIUM	36-37	400-1050 ¹⁾	0,08-0,14	0,08-0,14	0,12-0,16	0,14-0,18		80	40			
H	ACCIAIO TEMPRATO - HARDENED STEEL	38-41	45-60 ²⁾										

Smussatore - Chamfering tool - Werkzeug zum abschrägen - Outil à chanfreiner

SPU 1840-07

IN ESAURIMENTO
END OF STOCK
AUSLAUFEND
EN ÉPUÏSEMENT

SM0702 -30	
SM0702 -45	
SM0702 -55	

ART.	l1	h	h1	Rman	Rmix	kg	Nm	SM	1	2	3			
SPU 1840-07	24	10	4	19,5	8,2	0,03	1,1±1,3	SM0702	12256P	5608P	1240P	5615P	RSPU04	2063

Inserti per Smussatore - Inserts for Chamfering tool - Wendeplatten für Werkzeug zum abschrägen - Plaquettes pour Outil à chanfreiner									MATERIALI-MATERIALS Pag.1199						
ART.	α	S	l	d	h	SM	GRADO GRADE	QUICK PICK	P	M	K	N	S	H	
SM 0702 - 30	30°	2,38	6,35	2,8	1,3	2,2	T519D HC		●	○	●	○			
SM 0702 - 45	45°	2,38	6,35	2,8	2,3	2,3									
SM 0702 - 55	55°	2,38	6,35	2,8	5,6	3,9									

TDBC ..25R/L

Ø 19-54

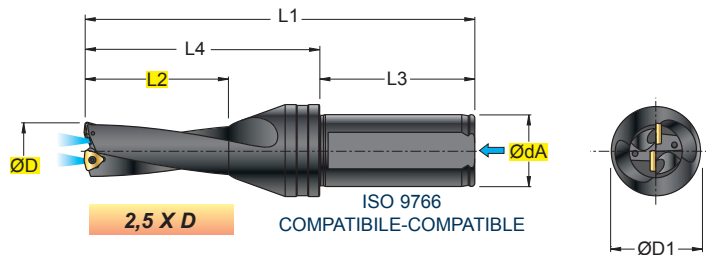

WCMTK58		NEW
WCMXS42		
WCMXS62/O62		
INSERTI - INSERTS PAG. 685		

ART.	(mm)											kg	Nm			
	ØD min-max	ØdA	ØD1	X max	L1	L2	L3	L4								
2,5 x D	TDBC 19025R/L	19-24	25	32	2,5	134	50	54	80	0,39	1,1+1,3	040208	12256P	5608P		
	TDBC 24025R/L	24-30	25	32	3,0	146	62	54	92	0,45	1,2+1,5	050308	123008P	5608P		
	TDBC 30025R/L	30-38	32	49	4,0	165	77	58	107	0,84	2,0+3,0	06T308	123009P	5610P		
	TDBC 38025R/L	38-48	32	49	5,0	185	95	58	127	1,07	3,8+5,0	080412	C04011P	5615P		
	TDBC 48025R/L	48-54	40	59	3,0	225	120	68	157	1,99	3,8+5,0	080412	C04011P	5615P		

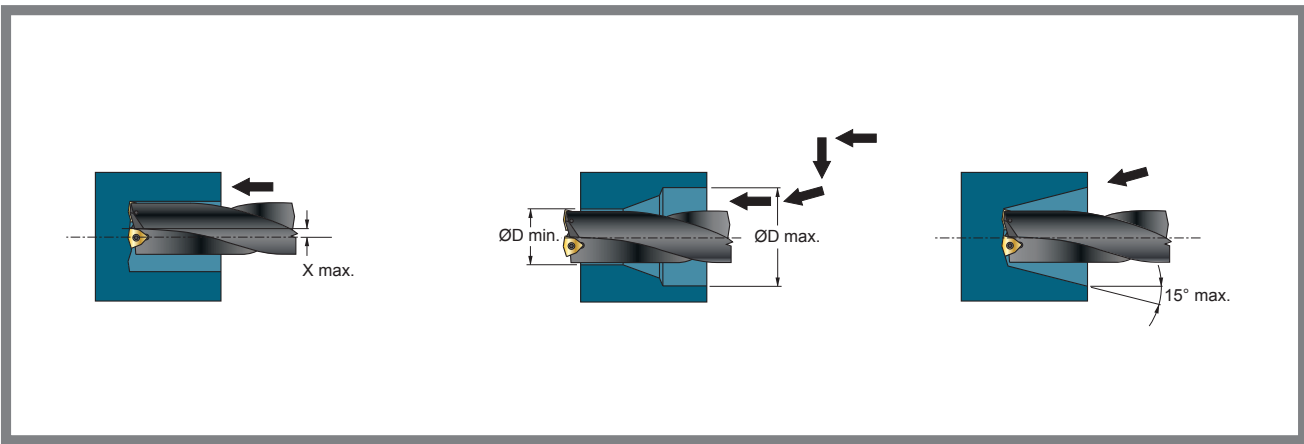

(■) LAVORAZIONE OTTIMALE - OPTIMUM MACHINING - OPTIMALE BEARBEITUNG - USINAGE OPTIMALE
(□) LAVORAZIONE POSSIBILE - POSSIBLE MACHINING - MOEGICHE BEARBEITUNG - USINAGE POSSIBLE

SCelta VELOCE - QUICK PICK							HT			HW			HC								
							CERMET			NON RIV. CEMENTED CARBIDE GRADES			RIVESTITI COATED GRADES BESCHICHTET RECOUVERTS			l	d	s	d1	r	a°
COD.	P	M	K	N	S	H	T120	T7530	T540												
WCMT 030204 .K58	●	●							■												
WCMT 040204 .K58	●	●							■												
WCMT 050308 .K58	●	●							■												
WCMT 06T308 .K58	●	●							■												
WCMT 080408 .K58	●	●							■												
WCMX 030208 .S62			○	●	○		■														
WCMX 040208 .S62			○	●	○		■														
WCMX 050308 .S62			○	●	○		■														
WCMX 06T308 .O62			○	●	○		■														
WCMX 080412 .S62			○	●	○		■														
WCMX 030208 .S62	●	●	○		○				■												
WCMX 040208 .S62	●	●	○		○				■												
WCMX 050308 .S62	●	●	○		○				■												
WCMX 06T308 .S62	●	●	○		○				■												
WCMX 080412 .S62	●	●	○		○				■												
WCMX 040208 .S42	●	●	○		●				■												
WCMX 050308 .S42	●	●	○		●				■												
WCMX 06T308 .S42	●	●	○		●				■												
WCMX 080412 .S42	●	●	○		●				■												



WCMX .S62/O62 = 1° SCELTA PER IMPIEGO GENERICO

1° CHOICE FOR GENERIC USE



WCMX ... S42 = CONTROLLO DEL TRUCIOLO A BASSI AVANZAMENTI

CHIP CONTROL WITH LOW FEEDS



WCMT ... K58 = CONSIGLIATO PER ACCIAIO INOX

RECOMMENDED FOR STAINLESS STEEL

MATERIALI - MATERIALS Pag. 1199		VDI 3323 GR.	HB Rm ¹⁾ HRC ²⁾	fn mm				Vc m/min Pag. 694					
				Ø19-24	Ø24-30	Ø30-38	Ø38-48	T120	T7530	T540			
P	ACCIAIO NON LEGATO - NOT ALLOY STEEL	1-5	125-300	0,08	0,10	0,1	0,12			180	150		
	ACCIAIO POCO LEGATO - LOW ALLOY STEEL	6-9	180-350	0,08	0,10	0,1	0,12			150	150		
	ACCIAIO ALTO LEGATO - ALLOY STEEL	10-11	200-325	0,08	0,10	0,1	0,12			130			
	INOX MARTENS. - STAINLESS STEEL MART	12-13	200-240	0,08	0,10	0,1	0,12			130			
M	INOX AUST. DUPLEX - STAINLESS STEEL AUST	14.1-14.2	180-230	0,08	0,10	0,1	0,11			140	130		
K	GHISA GRIGIA - GREY CAST IRON	15-16	180-260	0,08	0,12	0,14	0,15		80	110			
	GHISA SFEROIDALE - SPHEROIDAL GRAPHITE	17-18	160-250	0,08	0,12	0,14	0,15			110			
	GHISA MALLEABILE - MALLEABLE CAST IRON	19-20	130-230	0,08	0,12	0,14	0,15			110			
N	ALLUMINIO E SUE LEGHE - ALUMINIUM	21-25	60-130	0,06	0,10	0,12	0,14		350				
	RAME E SUE LEGHE - COPPER	26-28	90-110	0,06	0,10	0,12	0,14		200				
	NON METALLICI - PLASTICS	29-30	/	-	-	-	-						
S	LEGHE RESIST. CALORE - HIG. TEMP. ALLOY	31-35	200-320	0,04	0,06	0,08	0,09			40			
	TITANIO E SUE LEGHE - TITANIUM	36-37	400-1050 ¹⁾	0,08	0,12	0,14	0,16		80	40			
H	ACCIAIO TEMPRATO - HARDENED STEEL	38-41	45-60 ²⁾										

Vc = m/min VELOCITÀ DI TAGLIO - CUTTING SPEED
n = giri/min (min⁻¹) NUMERO DI GIRI - NUMBER OF REVOLUTIONS
fn = mm AVANZAMENTO AL GIRO - FEED / REVOLUTION
Vf = mm/min VELOCITÀ DI AVANZAMENTO - FEED SPEED

$$Vf = fn \cdot n = \text{mm/min}$$

$$n = \frac{Vc \cdot 1000}{\varnothing D \cdot 3,14} = \text{giri/min (min}^{-1}\text{)}$$

■ DISPONIBILI - IN STOCK - LIEFERBAR - DISPONIBLES / ■ NEW
●● APPLICAZIONE CONSIGLIATA-RECOMMENDED APPLICATION
EMPFÖHLENER EINSATZ - APPLICATION CONSEILLÉE

□ A RICHIESTA - ON REQUEST - AUF ANFRAGE - SUR DEMANDE / □ NEW
○ APPLICAZIONE POSSIBILE - POSSIBLE APPLICATION
MÖGLICHE ANWENDUNG - APPLICATION POSSIBLE

S656		Pag. 668	S636		Pag. 672	SEC ... R/L		Pag. 676
	$\varnothing D = 11 - 50$	XCGT XCNT 0401.. 0502.. 0602.. 0703.. 0803.. 09T3.. 10T3.. 1304.. 1705..		$\varnothing D = 9,8 - 31,8$	CC.. 060202		$\varnothing D = 8 - 32$	
								
	S656W ..			S636W .. 06			SEC ... R/L ..	
S659		Pag. 669	S646		Pag. 673	SMT ... R/L		Pag. 678
	$\varnothing D = 11 - 30$	XCGT XCNT 0401.. 0502.. 0602.. 0703.. 0803.. 09T3.. 10T3..		$\varnothing D = 15 - 32$	CC.. 0602..		$\varnothing D = 8 - 26$	
								
	S659W ..			S646W .. 05			SMT ... R/L ..	
S662W		Pag. 670	SMU.C...10W		Pag. 674	S626		Pag. 680
	$\varnothing D = 18 - 33$	CC.. 0602.. 09T3..			SMU45.. 10T2..		$\varnothing D = 10 - 33$	
								
	S662W ..						SMU.C... 10W	S626 ..
S663W		Pag. 671	SMU.ER...10		Pag. 675			
	$\varnothing D = 15 - 31$	TC.. 0802 1102			SMU45.. 10T2..			
								
	S663W ..					SMU.ER... 10		

Bareno a 2 tagli per lamatura-allargatura
 Spot-facing and widening boring bar with 2 cutting edges
 2 Schneiden-bohrstange zum ansenken und aufbohren
 Barre à aléser avec 2 tranchants pour lamage et élargissement

S 656W ..

Ø 11-50

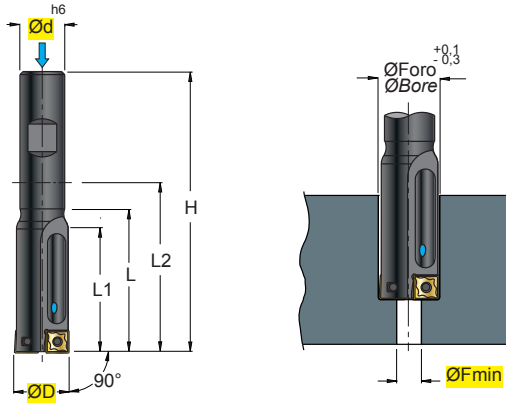

XCGTN57P	
XCGTN53	
XCNTN54	
INSERTI - INSERTS PAG. 702	

ART.	(mm)															
	ØD	Ød	ØFmin	H	L	L1	L2	Z	kg	Nm						
S 656W 011.04	11	16	3,0	99	29	22	51	2	0,11	0,4+0,5	M6	0401..	121837P	5506P		
S 656W 011.5.04	11,5	16	3,5	99	29	22	51	2	0,11	0,4+0,5						
S 656W 012.04	12	16	4,0	101	31	24	53	2	0,11	0,4+0,5						
S 656W 012.5.04	12,5	16	4,5	101	31	24	53	2	0,11	0,4+0,5						
S 656W 013.04	13	16	5,0	105	35	26	57	2	0,12	0,4+0,5						
S 656W 013.5.04	13,5	16	5,5	105	35	26	57	2	0,12	0,4+0,5						
S 656W 014.05	14	16	3,4	86	36,5	28	38	2	0,09	0,5+0,6	M8	0502..	12204P	5506P		
S 656W 014.5.05	14,5	16	3,9	86	36,5	28	38	2	0,09	0,5+0,6						
S 656W 015.05	15	16	4,5	88	38	30	40	2	0,10	0,5+0,6						
S 656W 015.5.05	15,5	16	5,0	88	38	30	40	2	0,10	0,5+0,6						
S 656W 016.06	16	16	4,1	92	42	32	44	2	0,10	0,9+1,0		0602..	12225P	5507P		
S 656W 016.5.06	16,5	16	4,6	92	42	32	44	2	0,10	0,9+1,0						
S 656W 017.06	17	16	5,1	94	44	35	46	2	0,11	0,9+1,0						
S 656W 017.5.07	17,5	16	3,4	96	46	35	48	2	0,11	1,0+1,2	M10	0703..	1225P	5507P		
S 656W 018.07	18	16	3,9	97	48	36	49	2	0,11	1,0+1,2						
S 656W 018.5.07	18,5	16	4,4	97	48	36	49	2	0,11	1,0+1,2						
S 656W 019.07	19	16	4,9	100	50	38	52	2	0,12	1,0+1,2						
S 656W 019.5.07	19,5	16	5,4	100	50	38	52	2	0,12	1,0+1,2						
S 656W 020.08	20	16	4,2	102	52	40	54	2	0,13	1,2+1,5	M12	0803..	123008P	5508P		
S 656W 020.5.08	20,5	16	4,7	102	52	40	54	2	0,13	1,2+1,5						
S 656W 021.08	21	20	5,2	114	54	42	64	2	0,20	1,2+1,5						
S 656W 021.5.08	21,5	20	5,7	114	54	42	64	2	0,20	1,2+1,5						
S 656W 022.09	22	20	4,0	116	56	44	66	2	0,20	1,2+1,5		09T3..	123008P	5508P		
S 656W 022.5.09	22,5	20	4,5	116	56	44	66	2	0,20	1,2+1,5						
S 656W 023.09	23	20	5,0	119	59	46	69	2	0,22	1,2+1,5	M14					
S 656W 023.5.09	23,5	20	5,5	119	59	46	69	2	0,22	1,2+1,5						
S 656W 024.10	24	20	4,0	122	62	48	72	2	0,22	3,0+3,5		10T3..	123509P	5515P		
S 656W 024.5.10	24,5	20	4,5	122	62	48	72	2	0,22	3,0+3,5						
S 656W 025.10	25	20	5,0	125	65	50	75	2	0,24	3,0+3,5						
S 656W 025.5.10	25,5	20	5,5	125	65	50	75	2	0,24	3,0+3,5	M16					
S 656W 026.10	26	25	6,0	136	66	52	80	2	0,37	3,0+3,5						
S 656W 026.5.10	26,5	25	6,5	136	66	52	80	2	0,37	3,0+3,5						
S 656W 027.10	27	25	7,0	139	69	54	83	2	0,40	3,0+3,5						
S 656W 027.5.10	27,5	25	7,5	139	69	54	83	2	0,40	3,0+3,5						
S 656W 028.10	28	25	8,0	142	72	56	86	2	0,42	3,0+3,5						
S 656W 028.5.10	28,5	25	8,5	142	72	56	86	2	0,42	3,0+3,5						
S 656W 029.10	29	25	9,0	144	74	58	88	2	0,46	3,0+3,5	M18					
S 656W 029.5.10	29,5	25	9,5	144	74	58	88	2	0,46	3,0+3,5						
S 656W 030.10	30	25	10,0	146	76	58	90	2	0,48	3,0+3,5						
S 656W 030.5.10	30,5	25	10,5	146	76	58	90	2	0,48	3,0+3,5						
S 656W 031.13	31	25	5,3	149	79	62	93	2	0,46	4,0+5,0		1304..	124510P	5520P		
S 656W 031.5.13	31,5	25	5,8	149	79	62	93	2	0,46	4,0+5,0						
S 656W 032.13	32	25	6,3	152	82	64	96	2	0,49	4,0+5,0	M20					
S 656W 032.5.13	32,5	25	6,8	152	82	64	96	2	0,49	4,0+5,0						
S 656W 033.13	33	32	7,2	163	83	66	103	2	0,74	4,0+5,0						
S 656W 033.5.13	33,5	32	7,7	163	83	66	103	2	0,74	4,0+5,0						
S 656W 034.13	34	32	8,2	167	87	68	107	2	0,78	4,0+5,0						
S 656W 034.5.13	34,5	32	8,7	167	87	68	107	2	0,78	4,0+5,0						
S 656W 035.13	35	32	9,2	169	89	70	109	2	0,85	4,0+5,0	M22					
S 656W 035.5.13	35,5	32	9,7	169	89	70	109	2	0,85	4,0+5,0						
S 656W 036.13	36	32	10,2	169	89	70	109	2	0,85	4,0+5,0						
S 656W 036.5.13	36,5	32	10,7	169	89	70	109	2	0,85	4,0+5,0						
S 656W 037.13	37	32	11,2	169	89	70	109	2	0,88	4,0+5,0						
S 656W 037.5.13	37,5	32	11,7	169	89	70	109	2	0,88	4,0+5,0						
S 656W 038.13	38	32	12,2	170	90	70	110	2	0,91	4,0+5,0						
S 656W 038.5.13	38,5	32	12,7	170	90	70	110	2	0,91	4,0+5,0						
S 656W 039.17	39	32	6,2	171	91	70	111	2	0,84	4,0+5,0	M24	1705..	124510P	5520P		
S 656W 039.5.17	39,5	32	6,7	171	91	70	111	2	0,84	4,0+5,0						
S 656W 040.17	40	32	7,2	172	92	70	112	2	0,88	4,0+5,0						
S 656W 040.5.17	40,5	32	7,7	172	92	70	112	2	0,88	4,0+5,0						
S 656W 041.17	41	32	8,2	173	93	70	113	2	0,92	4,0+5,0						
S 656W 041.5.17	41,5	32	8,7	173	93	70	113	2	0,92	4,0+5,0						
S 656W 042.17	42	32	9,2	174	94	70	114	2	0,96	4,0+5,0						
S 656W 042.5.17	42,5	32	9,7	174	94	70	114	2	0,96	4,0+5,0						
S 656W 043.17	43	32	10,2	186	106	80	126	2	1,06	4,0+5,0	M27					
S 656W 043.5.17	43,5	32	10,7	186	106	80	126	2	1,06	4,0+5,0						
S 656W 044.17	44	32	11,2	186	106	80	126	2	1,10	4,0+5,0						
S 656W 044.5.17	44,5	32	11,7	186	106	80	126	2	1,10	4,0+5,0						
S 656W 045.17	45	32	12,2	187	107	80	127	2	1,15	4,0+5,0						
S 656W 045.5.17	45,5	32	12,7	187	107	80	127	2	1,15	4,0+5,0						
S 656W 046.17	46	32	13,2	187	107	80	127	2	1,19	4,0+5,0						
S 656W 046.5.17	46,5	32	13,7	187	107	80	127	2	1,19	4,0+5,0						
S 656W 047.17	47	32	14,2	187	107	80	127	2	1,24	4,0+5,0						
S 656W 047.5.17	47,5	32	14,7	187	107	80	127	2	1,24	4,0+5,0						
S 656W 048.17	48	32	15,2	188	108	80	128	2	1,30	4,0+5,0	M30					
S 656W 048.5.17	48,5	32	15,7	188	108	80	128	2	1,30	4,0+5,0						
S 656W 049.17	49	32	16,2	188	108	80	128	2	1,34	4,0+5,0						
S 656W 049.5.17	49,5	32	16,7	188	108	80	128	2	1,34	4,0+5,0						
S 656W 050.17	50,0	32	17,2	188	108	80	128	2	1,39	4,0+5,0						

ØF min = DIAMETRO MINIMO DI PREFORO, DA UTILIZZARE SOLAMENTE IN CASO DI NECESSITÀ
 ØF min = MINIMUM PRE-BORE DIAMETER, TO BE USED ONLY IN CASE OF NEED

S 659W ..

Ø 11-30

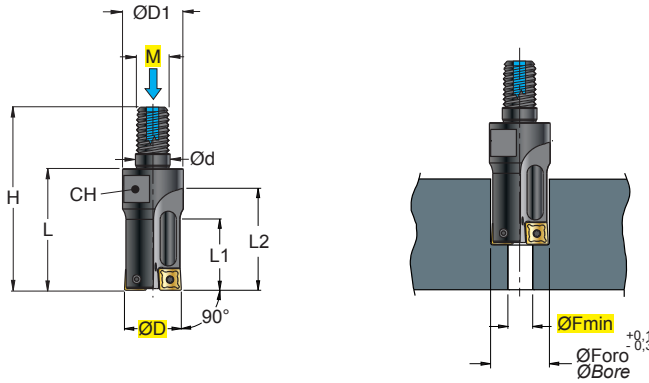

XCGT ...
.N57P



XCGT ...
.N53



XCNT ...
.N54



INSERTI - INSERTS
PAG. 702

ART.		(mm)																
ØD	M	Ød	ØFmin	ØD1	H	L	L1	L2	Z	CH	kg	Nm						
S 659W	011-04	11	8	8,5	3,0	13	43	26	15,0	22	2	10	0,02	0,4+0,5	M6	0401..	121837P	5506P
S 659W	012-04	12	8	8,5	4,0	13	44	27	16,0	23	2	10	0,02	0,4+0,5				
S 659W	013-04	13	8	8,5	5,0	13	45	28	17,0	24	2	10	0,03	0,4+0,5				
S 659W	014-05	14	10	10,5	3,4	18	52	33	18,6	27	2	15	0,04	0,5+0,6	M8	0502..	12204P	5506P
S 659W	015-05	15	10	10,5	4,5	18	53	34	19,6	28	2	15	0,05	0,5+0,6				
S 659W	016-06	16	10	10,5	4,1	18	54	35	20,0	29	2	15	0,05	0,9+1,0				
S 659W	017-06	17	10	10,5	5,1	18	55	36	21,0	30	2	15	0,05	0,9+1,0				
S 659W	018-07	18	12	12,5	3,9	21	60	38	23,0	33	2	17	0,06	1,0+1,2	M10	0703..	1225P	5507P
S 659W	019-07	19	12	12,5	4,9	21	61	39	24,0	34	2	17	0,07	1,0+1,2				
S 659W	020-08	20	12	12,5	4,2	21	62	40	25,0	36	2	17	0,07	1,2+1,5	M12	0803..	123008P	5508P
S 659W	021-08	21	12	12,5	5,2	21	63	41	26,0	37	2	17	0,08	1,2+1,5				
S 659W	022-09	22	16	17,0	4,0	29	71	47	28,0	41	2	24	0,13	1,2+1,5				
S 659W	023-09	23	16	17,0	5,0	29	72	48	29,0	42	2	24	0,14	1,2+1,5	M14	09T3..	123008P	5508P
S 659W	024-10	24	16	17,0	4,0	29	74	50	30,0	44	2	24	0,14	3,0+3,5				
S 659W	025-10	25	16	17,0	5,0	29	75	51	31,0	45	2	24	0,15	3,0+3,5				
S 659W	026-10	26	16	17,0	6,0	29	76	52	32,0	46	2	24	0,16	3,0+3,5	M16	10T3..	123509P	5515P
S 659W	027-10	27	16	17,0	7,0	29	77	53	33,0	47	2	24	0,17	3,0+3,5				
S 659W	028-10	28	16	17,0	8,0	29	78	54	34,0	48	2	24	0,19	3,0+3,5				
S 659W	029-10	29	16	17,0	9,0	29	79	55	35,0	49	2	24	0,21	3,0+3,5	M18			
S 659W	030-10	30	16	17,0	10,0	29	80	56	36,0	50	2	24	0,22	3,0+3,5				

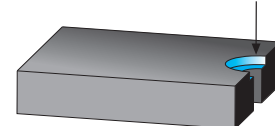
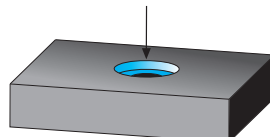

W = FORO PER LIQUIDO REFRIGERANTE - COOLANT BORE - KÜHLMITTELBOHRUNG - TROU DU LIQUIDE D'ARROSAGE

ØF min = DIAMETRO MINIMO DI PREFORO, DA UTILIZZARE SOLAMENTE IN CASO DI NECESSITÀ
 ØF min = MINIMUM PRE-BORE DIAMETER, TO BE USED ONLY IN CASE OF NEED

S 662W ..

Ø 18-33

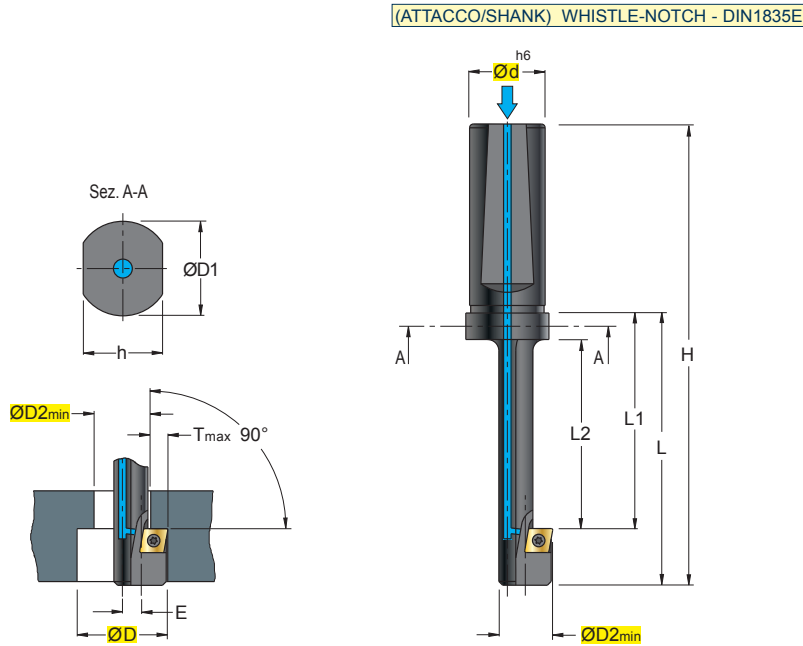

CC.. 0602	
CC.. 09T3	
INSERTI - INSERTS PAG. 699	

ART.		(mm)																
ART.		ØD	ØD2min	ØD1	Ød	Tmax	E	H	L	L1	L2	h	kg	Nm				
S 662	018-06 (*)	18	10,5	25	20	3,8	4,0	112	62	47	40	20,5	0,14	1,0+1,2	M10	060204	12253	5607
S 662W	020-06	20	13,0	25	20	3,5	3,75	117	67	52	45	20,5	0,15	1,1+1,3	M12	060204	12256CP	5608P
S 662W	024-06	24	15,0	25	20	4,5	4,75	122	72	57	50	20,5	0,16	1,1+1,3	M14	060204	12256P	5608P
S 662W	026-06	26	17,0	25	20	4,5	5,0	132	82	67	60	20,5	0,19	1,1+1,3	M16			
S 662W	030-06	30	19,0	25	20	5,5	6,0	142	92	72	65	20,5	0,22	1,1+1,3	M18			
S 662W	033-09	33	21,0	25	20	6,0	6,6	152	102	82	75	20,5	0,25	3,8+5,0	M20	09T308	C04008P	5615P

M19 = UTENSILE ORIENTATO, NON ROTANTE - NONROTATING ORIENTED TOOL
 M3 = UTENSILE IN ROTAZIONE - ROTATING TOOL

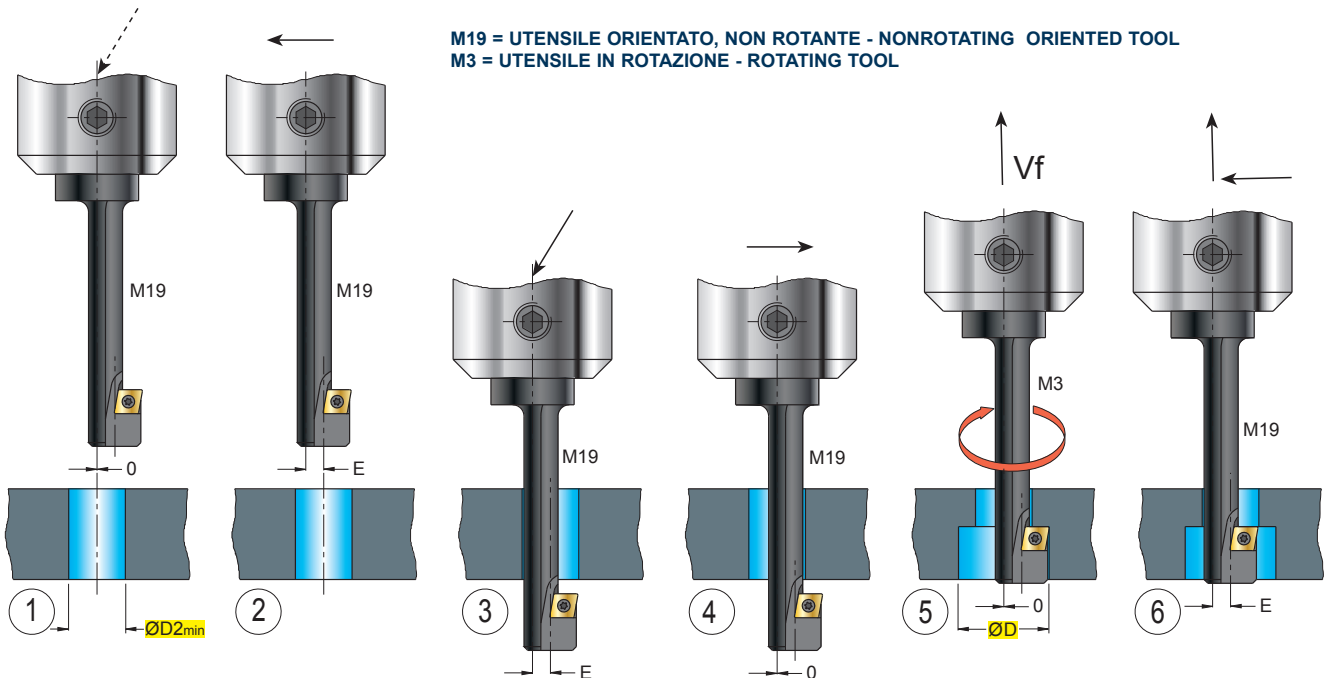

M3 = PEZZO IN ROTAZIONE - ROTATING WORK PIECE

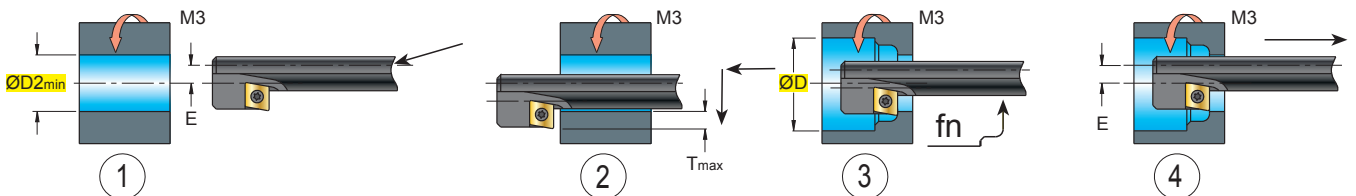

W = FORO PER LIQUIDO REFRIGERANTE - COOLANT BORE - KÜHLMITTELBOHRUNG - TROU DU LIQUIDE D'ARROSAGE
 (*) = SENZA FORO REFRIGERANTE - WITHOUT COOLANT BORE - OHNE KÜHLMITTELBOHRUNG - SANS TROU RÉFRIGÉRANT

S 663W ..

Ø 15-31

(ATTACCO/SHANK) WHISTLE-NOTCH - DIN1835E

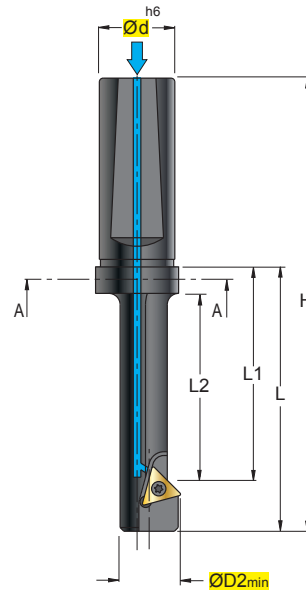
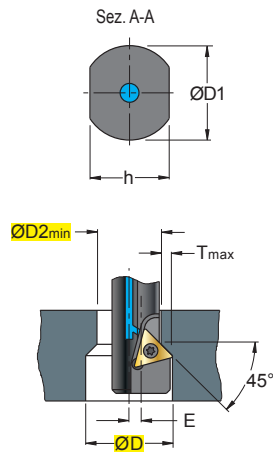

TC.. 0802



TC.. 1102



INSERTI - INSERTS
 PAG. 701

(mm)

ART.		ØD	ØD2min	ØD1	Ød	Tmax	E	H	L	L1	L2	h	kg	Nm
S 663	015-08 (*)	15	10,0	25	20	2,5	2,7	105	55	42	35	20,5	0,13	0,9+1,0
S 663W	020-08	20	14,0	25	20	3,0	3,2	110	60	47	40	20,5	0,15	0,9+1,0
S 663W	023-11	23	17,0	25	20	3,0	3,2	120	70	57	50	20,5	0,18	1,1+1,3
S 663W	027-11	27	21,0	25	20	3,0	3,2	140	90	77	70	20,5	0,27	1,1+1,3
S 663W	031-11	31	24,0	25	20	3,5	3,7	150	100	87	80	20,5	0,34	1,1+1,3



M19 = UTENSILE ORIENTATO, NON ROTANTE - NONROTATING ORIENTED TOOL
 M3 = UTENSILE IN ROTAZIONE - ROTATING TOOL

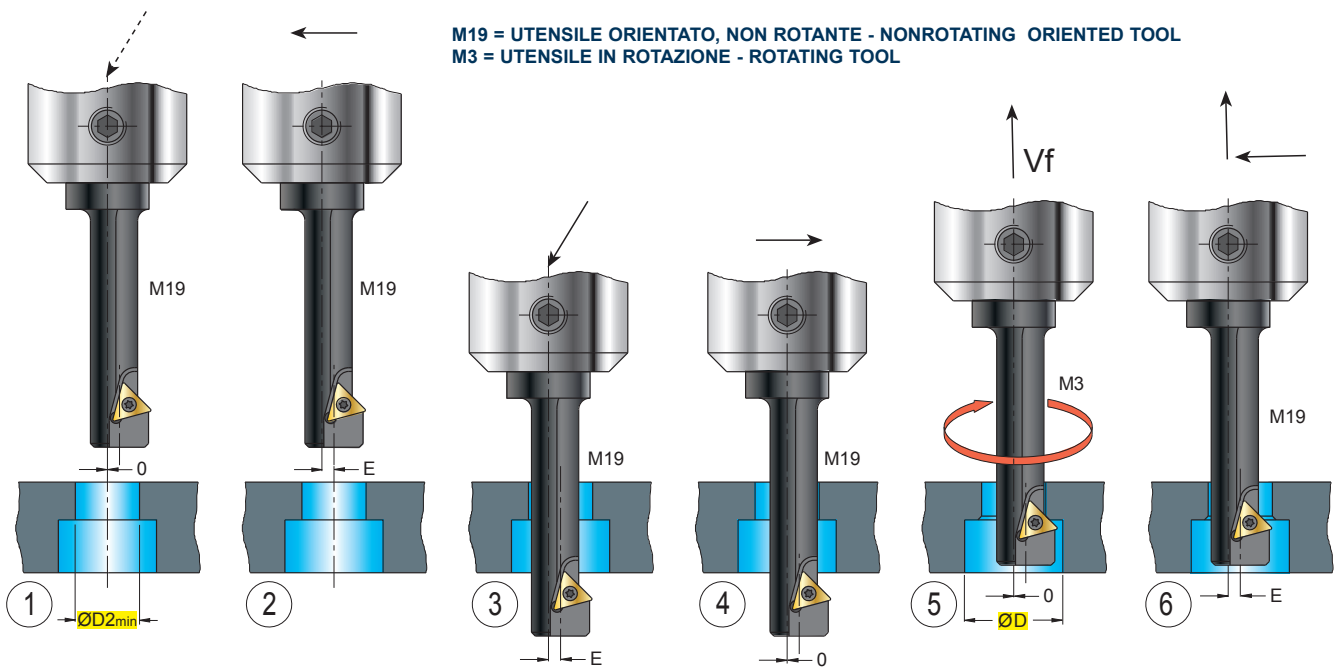

M3 = PEZZO IN ROTAZIONE - ROTATING WORK PIECE

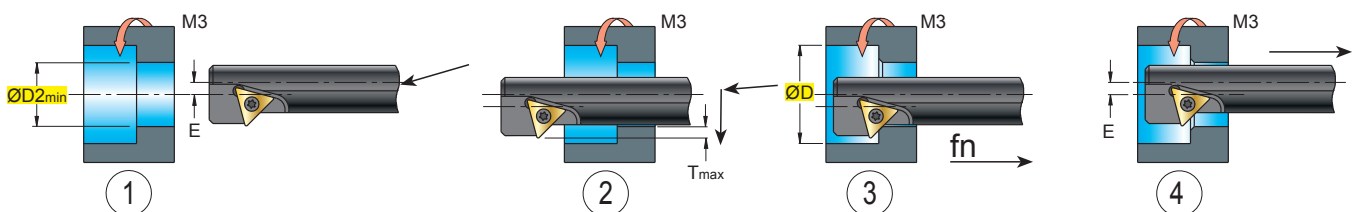

W = FORO PER LIQUIDO REFRIGERANTE - COOLANT BORE - KÜHLMITTELBOHRUNG - TROU DU LIQUIDE D'ARROSAGE
 (*) = SENZA FORO REFRIGERANTE - WITHOUT COOLANT BORE - OHNE KÜHLMITTELBOHRUNG - SANS TROU RÉFRIGÉRANT

S 636W .. 06

Ø 9,8-31,8

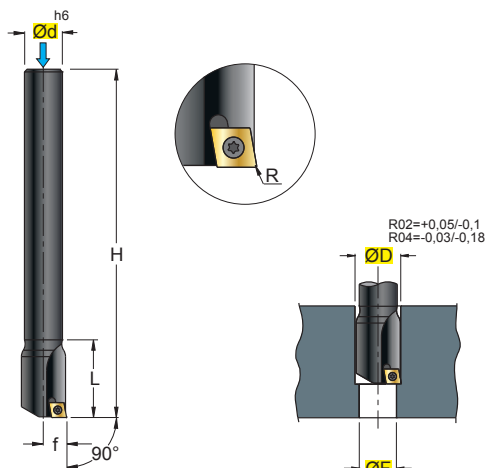

CCET 0602 .B22	
CCGT 0602 .F47	
CCGT 0602 .G13	
CCGT 0602 .G57P	
CCGW 0602 .X47	
CCMT 0602 .F32	
CCMT 0602 .F33	
CCMT 0602 .G39	
CCMT 0602 .G42	
CCMT 0602 .G52	

INSERTI - INSERTS
PAG. 699

		(mm)							kg	Nm			
ART.		ØD	Ød	ØF	f	H	L	Z					
S 636W	09.8-06	9,8	8	4,5	4,9	85	23	1	0,03	1,0+1,2	0602	12254P	5607P
S 636W	10.8-06	10,8	10	3,5	5,4	95	24	1	0,05	1,0+1,2			
S 636W	11.8-06	11,8	10	3,0	5,9	100	25	1	0,05	1,0+1,2			
S 636W	12.8-06	12,8	10	2,5	6,4	105	26	1	0,06	1,0+1,2			
S 636W	13.8-06	13,8	10	3,0	6,9	110	27	1	0,06	1,0+1,2			
S 636W	14.8-06	14,8	12	3,5	7,4	120	28	1	0,10	1,0+1,2			
S 636W	15.8-06	15,8	12	4,0	7,9	125	29	1	0,11	1,1+1,3			
S 636W	16.8-06	16,8	16	5,0	8,4	133	30	1	0,20	1,1+1,3			
S 636W	17.8-06	17,8	16	6,0	8,9	138	31	1	0,21	1,1+1,3			
S 636W	18.8-06	18,8	16	7,0	9,4	143	32	1	0,22	1,1+1,3			
S 636W	19.8-06	19,8	16	8,0	9,9	148	33	1	0,24	1,1+1,3			
S 636W	20.8-06	20,8	16	9,0	10,4	154	34	1	0,25	1,1+1,3			
S 636W	21.8-06	21,8	16	10,0	10,9	158	35	1	0,27	1,1+1,3			
S 636W	22.8-06	22,8	20	11,0	11,4	165	36	1	0,40	1,1+1,3			
S 636W	23.8-06	23,8	20	12,0	11,9	170	37	1	0,42	1,1+1,3			
S 636W	24.8-06	24,8	20	13,0	12,4	175	38	1	0,44	1,1+1,3			
S 636W	25.8-06	25,8	20	14,0	12,9	180	39	1	0,46	1,1+1,3			
S 636W	26.8-06	26,8	20	15,0	13,4	185	40	1	0,48	1,1+1,3			
S 636W	27.8-06	27,8	20	16,0	13,9	190	41	1	0,50	1,1+1,3			
S 636W	28.8-06	28,8	20	17,0	14,4	195	42	1	0,52	1,1+1,3			
S 636W	29.8-06	29,8	20	18,0	14,9	195	43	1	0,53	1,1+1,3			
S 636W	30.8-06	30,8	25	19,0	15,4	195	44	1	0,55	1,1+1,3			
S 636W	31.8-06	31,8	25	20,0	15,9	195	45	1	0,77	1,1+1,3			

- PREFORO MINIMO POSSIBILE, INDICAZIONE PURAMENTE TEORICA, NON CONSIGLIATO
- MINIMUM POSSIBLE PRE-HOLE, MERELY THEORETICAL INDICATION, NOT RECOMMENDED
- KLEINSTMÖGLICHE VORBOHRUNG, REIN THEORETISCHE ANGABE, NICHT EMPFOHLEN
- PRE-TROU MINIMUM, INDICATION SEULEMENT THÉORIQUE, PAS CONSEILLÉE

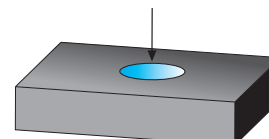

W = FORO PER LIQUIDO REFRIGERANTE - COOLANT BORE - KÜHLMITTELBOHRUNG - TROU DU LIQUIDE D'ARROSAGE

S 646W .. 06

Ø 15-32

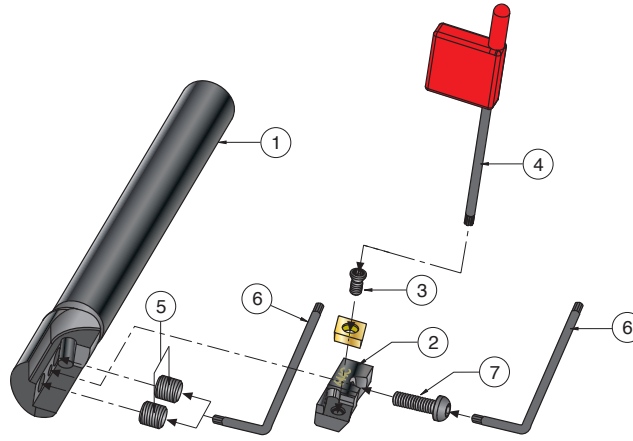
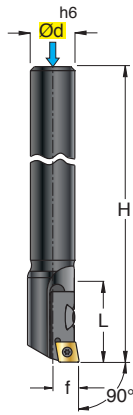
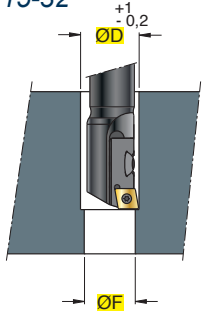

CC.. 0602..

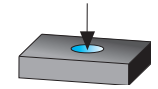
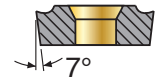

										INSERTI - INSERTS PAG. 699						
										1	2	3	4	5	6	7
.B22	.F47	.G13	.G57P	.X47	.F32	.F33	.G39	.G42	.G52							
(mm)										1	2	3	4	5	6	7
ART.	ØD	Ød	ØF	f	H	L	Z	kg								
S 646W 15.0 - 06	15	12	9	7,4	120	28	1	0,09	0602	645	644-06	12256CP	5508P	GR505FP	5509	1803N
S 646W 16.0 - 06	16	12	10	7,9	125	29	1	0,09								
S 646W 17.0 - 06	17	16	11	8,4	133	30	1	0,13								
S 646W 18.0 - 06	18	16	12	8,9	138	31	1	0,14								
S 646W 19.0 - 06	19	16	13	9,4	143	32	1	0,14								
S 646W 20.0 - 06	20	16	14	9,9	148	33	1	0,21								
S 646W 21.0 - 06	21	16	15	10,4	154	34	1	0,23								
S 646W 22.0 - 06	22	16	16	10,9	158	35	1	0,24								
S 646W 23.0 - 06	23	20	17	11,4	165	36	1	0,37								
S 646W 24.0 - 06	24	20	18	11,9	170	37	1	0,38								
S 646W 25.0 - 06	25	20	19	12,4	175	38	1	0,40								
S 646W 26.0 - 06	26	20	20	12,9	180	39	1	0,41								
S 646W 27.0 - 06	27	20	21	13,4	185	40	1	0,42								
S 646W 28.0 - 06	28	20	22	13,9	190	41	1	0,43								
S 646W 29.0 - 06	29	20	23	14,4	195	42	1	0,44								
S 646W 30.0 - 06	30	20	24	14,9	195	43	1	0,45								
S 646W 31.0 - 06	31	25	25	15,4	195	44	1	0,46								
S 646W 32.0 - 06	32	25	26	15,9	195	45	1	0,47								

- PREFORO MINIMO POSSIBILE, INDICAZIONE PURAMENTE TEORICA, NON CONSIGLIATO
 - MINIMUM POSSIBLE PRE-HOLE, MERELY THEORETICAL INDICATION, NOT RECOMMENDED
 - KLEINSTMÖGLICHE VORBOHRUNG, REIN THEORETISCHE ANGABE, NICHT EMPFOHLEN
 - PRE-TRou MINIMUM, INDICATION SEULEMENT THÉORIQUE, PAS CONSEILLÉE

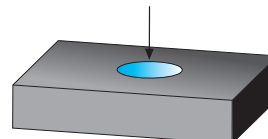

W = FORO PER LIQUIDO REFRIGERANTE - COOLANT BORE - KÜHLMITTELBOHRUNG - TROU DU LIQUIDE D'ARROSAGE

SMU.C...10W

art. HSK..WEH..
HSK..PU..

art. 375..

art. ISO.A..WEC..
ISO.B..WE..
ISO.B..PUH..

art. MAS.A..WEC..
MAS...WE..
MAS.B..PUH..

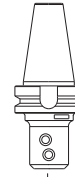
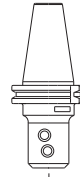
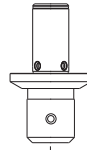
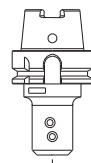

SMU45
10T2
.X55

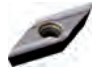

TAGLIANTE PUNTA
DRILL CUTTING EDGE

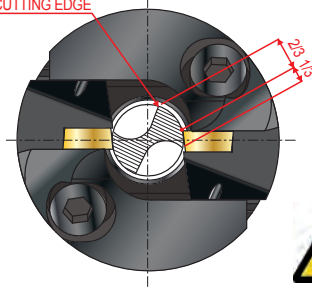

- Posizionare il vertice inserto dello smussatore a 2/3 del dorso dell' elica della punta dal filo tagliente, come mostrato in figura.
"Non utilizzare punte con doppio pattino".
- Place the top of the chamferer insert at 2/3 of the drill pitch flank from the cutting edge, as shown in the figure.
"DO not use double-guide drills".
- Spitze der abschräg-wendeschneidplatte auf 2/3 des schraubenrückens des bohrers ab der schneidkante positionieren, wie in der abbildung dargestellt.
"Keine Doppelschlitzen-Bohrer verwenden".
- Positionner le sommet de la plaquette du dispositif de biseautage a 2/3 du dos de l'helice de la pointe a partir du fil tranchant, comme indique sur la figure.
"Ne pas utiliser de pointes pourvues d'un double patin".

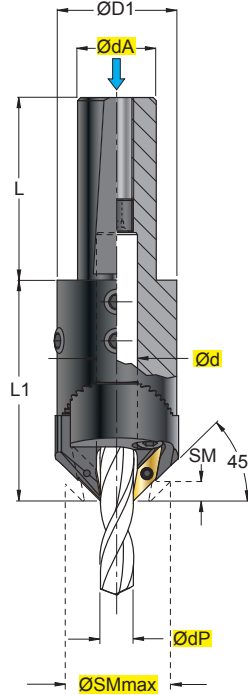

INSERTI
INSERTS
PAG.701



SCHEMA
MONTAGGIO
ASSEMBLY
SCHEME
PAG.1167

ART.	(mm)							kg	Nm	10T2	Accessories							
	Ødp	Ød	ØdA	ØD1	SM	L	L1				n°2	n°2	n°2	n°4	n°1			
SMU.C025.0506.10W	>5-6	6	25	35	0-3	56	56	0,46	1,1+1,3	10T2	LMA.CIL.0618.10W	905.005.080.012	12256P	GR05	GWR05	5004	5508P	5025
SMU.C025.0608.10W	>6-8	8	25	35	0-3	56	56	0,45	1,1+1,3	10T2	LMA.CIL.0618.10W	905.005.080.012	12256P	GR612	GWR06	5004	5508P	5003
SMU.C025.0810.10W	>8-10	10	25	37	0-3	56	64	0,50	1,1+1,3	10T2	LMA.CIL.0618.10W	905.005.080.012	12256P	GR612	GWR08	5004	5508P	5003
SMU.C025.1012.10W	>10-12	12	25	39	0-3	56	69	0,52	1,1+1,3	10T2	LMA.CIL.0618.10W	905.005.080.012	12256P	GR810F	GWR10	5004	5508P	5004
SMU.C025.1214.10W	>12-14	14	25	41	0-3	56	69	0,50	1,1+1,3									
SMU.C032.1416.10W	>14-16	16	32	43	0-3	60	68	0,69	1,1+1,3	10T2	LMA.CIL.0618.10W	905.005.080.012	12256P	GR1010F	GWR10	5004	5508P	5005
SMU.C032.1618.10W	>16-18	18	32	45	0-3	60	68	0,70	1,1+1,3									

- DIMENSIONE INGOMBRI PAG. 1168
- OVERALL SIZES PAGE 1168
- AUSSENABMESSUNGEN SEITE 1168
- DIMENSION HORS TOUT PAGE 1168

- SMUSSO Max ESEGUIBILE 3mm
- Max. CHAMFERING POSSIBLE 3mm
- Max. AUSFÜHRBARE ABCHRÄGUNG 3mm
- BISEAU Maxi EXÉCUTABLE 3mm

SMU.ER...10

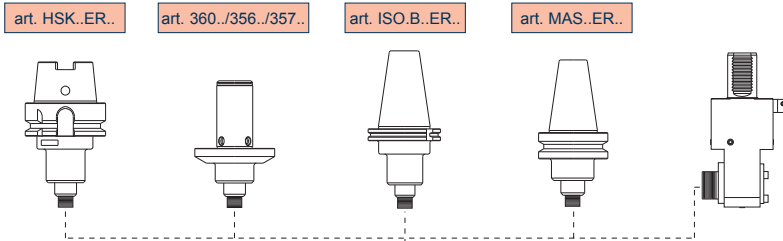

**SMU45
10T2
.X55**



**TAGLIANTE PUNTA
DRILL CUTTING EDGE**

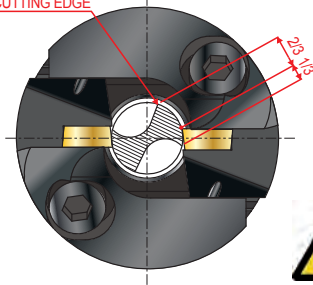

- Posizionare il vertice inserto dello smussatore a 2/3 del dorso dell' elica della punta dal filo tagliente, come mostrato in figura.
“Non utilizzare punte con doppio pattino”.
- Place the top of the chamferer insert at 2/3 of the drill pitch flank from the cutting edge, as shown in the figure.
“DO not use double-guide drills”.
- Spitze der abschräg-wendescheidplatte auf 2/3 des schraubenrückens des bohrers ab der schneidkante positionieren, wie in der abbildung dargestellt.
“Keine Doppelschlitten-Bohrer verwenden”.
- Positionner le sommet de la plaquette du dispositif de biseautage a 2/3 du dos de l'helic de la pointe a partir du fil tranchant, comme indique sur la figure.
“Ne pas utiliser de pointes pourvues d'un double patin”.

art. 228..
228Q..
230..
230Q..

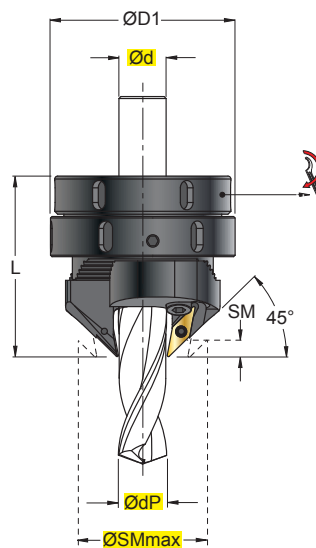

**INSERTI
INSERTS
PAG.701**



**SCHEMA
MONTAGGIO
ASSEMBLY
SCHEME
PAG.1167**

ART.	(mm)					kg	Nm	Nm	Icon 1	Icon 2	Icon 3	Icon 4	Icon 5	Icon 6	Icon 7	Icon 8	Icon 9				
	Ødp	Ød	ØD1	SM	L																
SMU.ER25.0616.10	>5-16	6-16	52	0-3	60	0,39	1,1+1,3	130	--025---	10T2	n°2	n°2	n°1	n°2	LMA.ER.0618.10	905.005.080.012	SMU-ER25-00	12256P	5004	5508P	925.040
SMU.ER32.0618.10	>5-18	6-18	62	0-3	62	0,53	1,1+1,3	160	--032---	10T2	n°2	n°2	n°1	n°2	LMA.ER.0618.10	905.005.080.012	SMU-ER32-00	12256P	5004	5508P	925.058
SMU.ER40.0618.10	>5-18	6-18	70	0-3	65	0,64	1,1+1,3	230	--040---	10T2	n°2	n°2	n°1	n°2	LMA.ER.0618.10	905.005.080.012	SMU-ER40-00	12256P	5004	5508P	925.068

- DIMENSIONE INGOMBRI PAG. 1169
- OVERALL SIZES PAGE 1169
- AUSSENABMESSUNGEN SEITE 1169
- DIMENSION HORS TOUT PAGE 1169

- SMUSSO Max ESEGUIBILE 3mm
- Max. CHAMFERING POSSIBLE 3mm
- Max. AUSFÜHRBARE ABCHRÄGUNG 3mm
- BISEAU Maxi EXÉCUTABLE 3mm

SEC ... R/L

Ø 8-32

NEW

FORM A

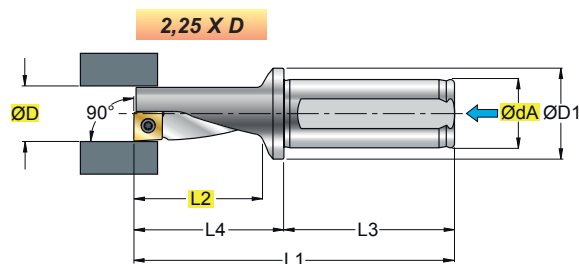

FORM B

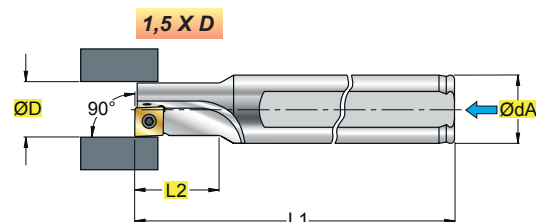

XCGTN57P	
XCGTN53	
XCNTN54	
XCNT ...EL .Z54	

INSERTI - INSERTS
PAG. 702

(mm)														
ART.	FORM	ØD	ØdA	ØD1	L1	L2	L3	L4	Z					
SEC 08-150.04R/L	B	8	12	-	80,0	12,0	-	-	1	0,06	0,4+0,5	0401..	121837P	5506P
SEC 08-225.04R/L	A	8	10	15	60,5	18	38	22,5	1	0,03	0,4+0,5			
SEC 10-150.05R/L	B	10	12	-	90,0	15,0	-	-	1	0,07	0,5+0,6	0502..	12204P	5506P
SEC 10-225.05R/L	A	10	12	18	70	22,5	42	28	1	0,05	0,5+0,6			
SEC 12-150.06R/L	B	12	16	-	100,0	18,0	-	-	1	0,13	0,9+1,0	0602..	12225P	5507P
SEC 12-225.06R/L	A	12	16	23	79	27	45	34	1	0,09	0,9+1,0			
SEC 14-150.07R/L	B	14	16	-	110,0	21,0	-	-	1	0,14	1,0+1,2	0703..	1225P	5507P
SEC 14-225.07R/L	A	14	16	23	83	31,5	45	38	1	0,10	1,0+1,2			
SEC 16-150.08R/L	B	16	20	-	125,0	24,0	-	-	1	0,24	1,2+1,5	0803..	123008P	5508P
SEC 16-225.08R/L	A	16	20	28	93,5	36	50	43,5	1	0,17	1,2+1,5			
SEC 18-150.09R/L	B	18	25	-	135,0	27,0	-	-	1	0,30	1,2+1,5	09T3..	123008P	5508P
SEC 18-225.09R/L	A	18	25	36	108,5	40,5	56	52,5	1	0,30	1,2+1,5			
SEC 20-150.10R/L	B	20	25	-	150,0	30,0	-	-	1	0,50	3,0+3,5	10T3..	123509P	5515P
SEC 20-225.10R/L	A	20	25	36	111,0	45	56	55	1	0,30	3,0+3,5			
SEC 25-150.13R/L	B	25	32	-	180,0	37,5	-	-	1	0,90	4,0+5,0	1304..	124510P	5520P
SEC 25-225.13R/L	A	25	32	44	129	56,3	60	69	1	0,56	4,0+5,0			
SEC 32-150.17R/L	B	32	40	-	200,0	48,0	-	-	1	1,60	4,0+5,0	1705..	124510P	5520P
SEC 32-225.17R/L	A	32	40	54	157	72	70	87	1	1,07	4,0+5,0			

PER UTENSILI SEC 08..L MONTARE INSERTO XCNT 04...L .Z54, PER UTENSILI SEC 08..R MONTARE INSERTI XC.. 04...R...
 TOOL TYPE SEC 08..L REQUIRES INSERT XCNT 04...L .Z54, TOOL TYPE 08..R REQUIRES INSERTS XC.. 04...R
 FÜR WERKZEUGTYPE SEC 08..L DIE PLATTE XCNT 04...L .Z54, FÜR SEC 08..R DIE PLATTEN XC.. 04...R...EINSETZEN
 DANS LE CAS D'OUTILS SEC 08..L MONTER LA PLAQUETTE XCNT 04...L .Z54, DANS LE CAS D'OUTILS SEC 08..R MONTER LES PLAQUETTES XC.. 04...R...



SMT ... R/L

Ø 8-26

FORM A

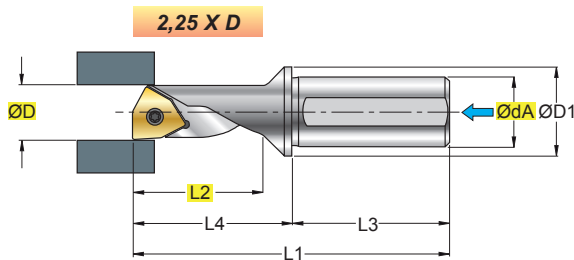

FORM B

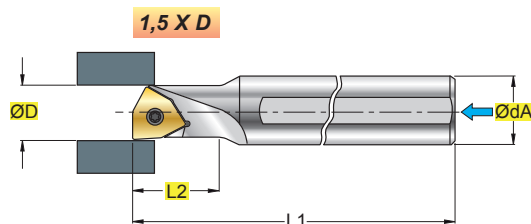

XCHX ...
F44



XCHX ...
F47P



INSERTI - INSERTS
PAG. 703

ART.	FORM	(mm)								kg	Nm			
		ØD ^{H13}	ØdA	ØD1	L1	L2	L3	L4	Z					
SMT 08225.04R/L	A	8	10	12	60,5	18,0	38	22,5	1	0,05	0,5+0,6	0401	122033	5606
SMT 08150.04R/L	B	8	12	-	80,0	12,0	-	-	1	0,03	0,5+0,6			
SMT 10225.05R/L	A	10	12	16	70,0	22,5	42	28,0	1	0,06	1,0+1,2	05T1	12253	5607
SMT 10150.05R/L	B	10	12	-	90,0	15,0	-	-	1	0,04	1,0+1,2			
SMT 11225.06R/L	A	11	16	20	77,0	27,75	45	32,0	1	0,13	1,0+1,2	0602	122549	5607
SMT 11150.06R/L	B	11	16	-	100,0	16,5	-	-	1	0,08	1,0+1,2			
SMT 15225.07R/L	A	15	20	25	93,0	33,75	50	43	1	0,24	1,2+1,5	0703	123008P	5608P
SMT 15150.07R/L	B	15	20	-	125,0	22,5	-	-	1	0,15	1,2+1,5			
SMT 18225.09R/L	A	18	25	32	109,0	40,5	56	53	1	0,40	3,0+3,5	0903	123509	5615P
SMT 18150.09R/L	B	18	25	-	135,0	27,0	-	-	1	0,28	3,0+3,5			
SMT 20225.10R/L	A	20	25	32	112,0	45,0	56	56	1	0,46	5,5+7,0	10T3	125088	5620
SMT 20150.10R/L	B	20	25	-	150,0	30,0	-	-	1	0,29	5,5+7,0			
SMT 26225.13R/L	A	26	32	40	133,0	58,5	60	73	1	0,91	7,5+9,0	1305	126012	5625
SMT 26150.13R/L	B	26	32	-	180,0	39,0	-	-	1	0,57	7,5+9,0			

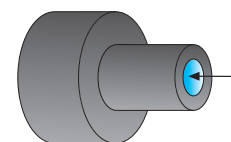
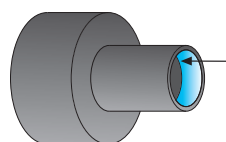
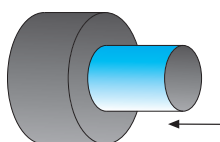
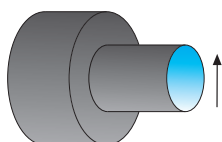

SCELTA VELOCE - QUICK PICK

Tenacità + ↑

Toughness - ↓

Pag. 704

COD.	P M K N S H												HT			HW			HC			Geometric Parameters					
	F		M		R		F		M		R		N3015			F2430			T1225			l	d	b°	s	d1	r
	F	M	R	F	M	R	F	M	R	F	M	R	F	M	R	F	M	R	F	M	R						
XCHX 040102 .F44	●	●		●	●																4,0	6,35	88	1,59	2,25	0,2	
XCHX 040104 .F44	●	●		●	●																4,0	6,35	88	1,59	2,25	0,4	
XCHX 05T102 .F44	●	●		●	●																5,0	7,94	88	1,98	2,8	0,2	
XCHX 05T104 .F44	●	●		●	●																5,0	7,94	88	1,98	2,8	0,4	
XCHX 060202 .F44	●	●		●	●																5,5	8,73	88	2,38	2,8	0,2	
XCHX 060204 .F44	●	●		●	●																5,5	8,73	88	2,38	2,8	0,4	
XCHX 070304 .F44	●	●		●	●																7,5	12,0	88	3,18	3,4	0,4	
XCHX 070308 .F44	●	●		●	●																7,5	12,0	88	3,18	3,4	0,8	
XCHX 090304 .F44	●	●		●	●																9,0	14,29	88	3,18	4,4	0,4	
XCHX 090308 .F44	●	●		●	●																9,0	14,29	88	3,18	4,4	0,8	
XCHX 10T304 .F44	●	●		●	●																10,0	15,88	88	3,97	5,9	0,4	
XCHX 10T308 .F44	●	●		●	●																10,0	15,88	88	3,97	5,9	0,8	
XCHX 130508 .F44	●	●		●	●																13,0	21,0	88	5,56	7,0	0,8	
XCHX 040102 .F47P									●	●											4,0	6,35	88	1,59	2,25	0,2	
XCHX 040104 .F47P									●	●											4,0	6,35	88	1,59	2,25	0,4	
XCHX 05T102 .F47P									●	●											5,0	7,94	88	1,98	2,8	0,2	
XCHX 05T104 .F47P									●	●											5,0	7,94	88	1,98	2,8	0,4	
XCHX 060202 .F47P									●	●											5,5	8,73	88	2,38	2,8	0,2	
XCHX 060204 .F47P									●	●											5,5	8,73	88	2,38	2,8	0,4	
XCHX 070304 .F47P									●	●											7,5	12,0	88	3,18	3,4	0,4	
XCHX 070308 .F47P									●	●											7,5	12,0	88	3,18	3,4	0,8	
XCHX 090304 .F47P									●	●											9,0	14,29	88	3,18	4,4	0,4	
XCHX 090308 .F47P									●	●											9,0	14,29	88	3,18	4,4	0,8	
XCHX 10T304 .F47P									●	●											10,0	15,88	88	3,97	5,9	0,4	
XCHX 10T308 .F47P									●	●											10,0	15,88	88	3,97	5,9	0,8	
XCHX 130508 .F47P									●	●											13,0	21,0	88	5,56	7,0	0,8	

CON ADDUZIONE LUBROREFRIGERANTE - WITH COOLANT SUPPLY

SENZA ADDUZIONE LUBROREFRIGERANTE - WITHOUT COOLANT SUPPLY

MATERIALI - MATERIALS Pag. 1199		VDI 3323 GR.	HB Rm ¹ HRC ²	Vc m/min Pag. 714		
				N3015	T1225	F2430
P	ACCIAIO NON LEGATO - NOT ALLOY STEEL	1-5	125-300		160	
	ACCIAIO POCO LEGATO - LOW ALLOY STEEL	6-9	180-350		110	
	ACCIAIO ALTO LEGATO - ALLOY STEEL	10-11	200-325		120	
	INOX MARTENS. - STAINLESS STEEL MART	12-13	200-240		120	
M	INOX AUST. DUPLEX - STAINLESS STEEL AUST	14.1-14.2	180-230		120	150
	GHISA GRIGIA - GREY CAST IRON	15-16	180-260			
K	GHISA SFEROIDALE - SPHEROIDAL GRAPHITE	17-18	160-250			
	GHISA MALLEABILE - MALLEABLE CAST IRON	19-20	130-230			
N	ALLUMINIO E SUE LEGHE - ALUMINIUM	21-25	60-130	500		
	RAME E SUE LEGHE - COPPER	26-28	90-110	400		
	NON METALLICI - PLASTICS	29-30	/	400		
S	LEGHE RESIST. CALORE - HIG. TEMP. ALLOY	31-35	200-320			30
	TITANIO E SUE LEGHE - TITANIUM	36-37	400-1050 ¹			20
H	ACCIAIO TEMPRATO - HARDENED STEEL	38-41	45-60 ²			

Cinque lavorazioni, un unico utensile
Five machining operations, one tool

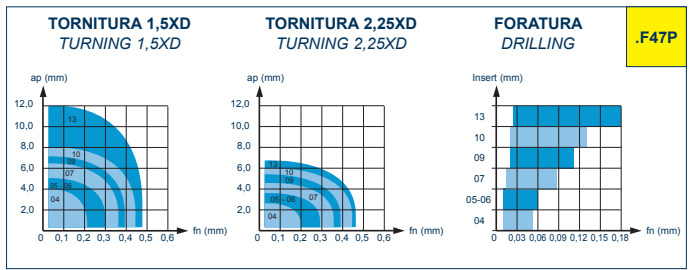
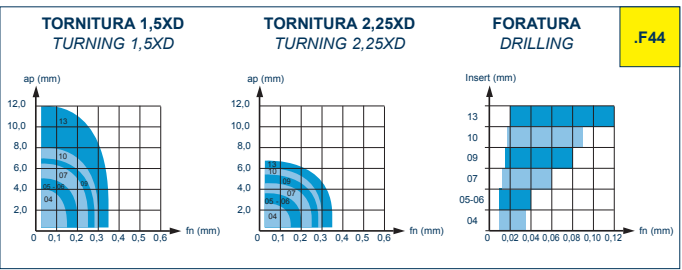

Vc = m/min VELOCITÀ DI TAGLIO - CUTTING SPEED
n = giri/min (min⁻¹) NUMERO DI GIRI - NUMBER OF REVOLUTIONS
fn = mm AVANZAMENTO AL GIRO - FEED / REVOLUTION
Vf = mm/min VELOCITÀ DI AVANZAMENTO - FEED SPEED
W = mm LARGHEZZA TAGLIANTE - CUTTING EDGE WIDTH

$$n = \frac{Vc \cdot 1000}{\varnothing D \cdot 3,14} = \text{giri/min (min}^{-1}\text{)}$$

$$Vf = fn \cdot n = \text{mm/min}$$

S 626 ..

$\varnothing 10-33$

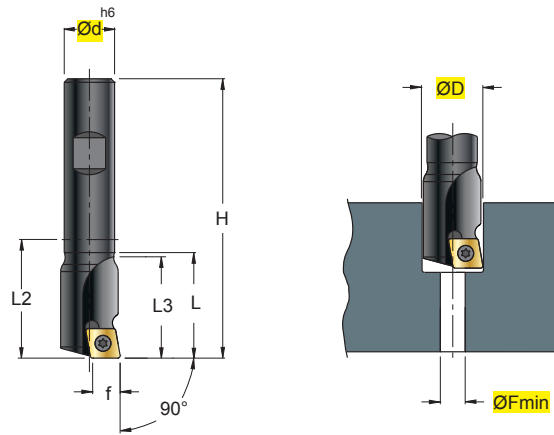

CC.. 0602







CC.. 09T3



INSERTI - INSERTS
 PAG. 699

(mm)

ART.	$\varnothing D$	$\varnothing d$	$\varnothing Fmin$	f	H	L	L2	L3	Z	kg	Nm				
S 626 10-06	10	8	4,0	5,0	61	23	25	22	1	0,02	1,0+1,2		060204	12254P	5607P
S 626 11-06	11	10	4,0	5,5	70	24	30	23	1	0,04	1,0+1,2	M6	060204	12254P	5607P
S 626 12-06	12	10	4,0	6,0	70	25	37,5	24	1	0,04	1,0+1,2				
S 626 13-06	13	12	5,0	6,5	80	27	35	25	1	0,06	1,0+1,2				
S 626 14-06	14	12	5,0	7,0	80	28	35	26	1	0,07	1,0+1,2	M8			
S 626 15-06	15	12	5,0	7,5	80	29	35	27	1	0,07	1,0+1,2				
S 626 16-06	16	12	5,0	8,0	80	30	35	28	1	0,08	1,0+1,2				
S 626 17-09	17	16	6,0	8,5	90	31	42	29	1	0,13	3,5+4,0	M10			
S 626 18-09	18	16	6,0	9,0	90	33	42	30	1	0,13	3,5+4,0				
S 626 19-09	19	16	6,0	9,5	90	34	42	31	1	0,14	3,5+4,0				
S 626 20-09	20	16	6,0	10,0	90	35	42	32	1	0,14	3,5+4,0	M12			
S 626 21-09	21	20	6,0	10,5	100	36	51	33	1	0,22	3,5+4,0				
S 626 22-09	22	20	7,0	11,0	100	37	51	34	1	0,22	3,5+4,0				
S 626 23-09	23	20	7,0	11,5	100	38	51	35	1	0,23	3,5+4,0	M14			
S 626 24-09	24	20	8,0	12,0	100	39	51	36	1	0,23	3,5+4,0				
S 626 25-09	25	20	9,0	12,5	100	40	51	37	1	0,24	3,5+4,0				
S 626 26-09	26	25	10,0	13,0	120	41	64	38	1	0,41	3,8+5,0	M16	09T308	12409P	5615P
S 626 27-09	27	25	10,5	13,5	120	42	64	39	1	0,42	3,8+5,0				
S 626 28-09	28	25	11,0	14,0	120	43	64	40	1	0,43	3,8+5,0				
S 626 29-09	29	25	12,0	14,5	120	44	64	41	1	0,44	3,8+5,0	M18			
S 626 30-09	30	25	13,0	15,0	120	45	64	42	1	0,45	3,8+5,0				
S 626 31-09	31	25	14,0	15,5	120	46	64	43	1	0,46	3,8+5,0				
S 626 32-09	32	25	15,0	16,0	120	47	64	44	1	0,47	3,8+5,0	M20			
S 626 33-09	33	25	16,0	16,5	120	48	64	45	1	0,49	3,8+5,0				

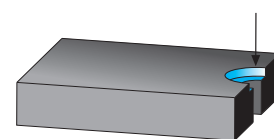
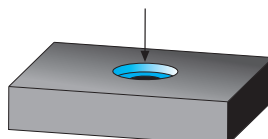

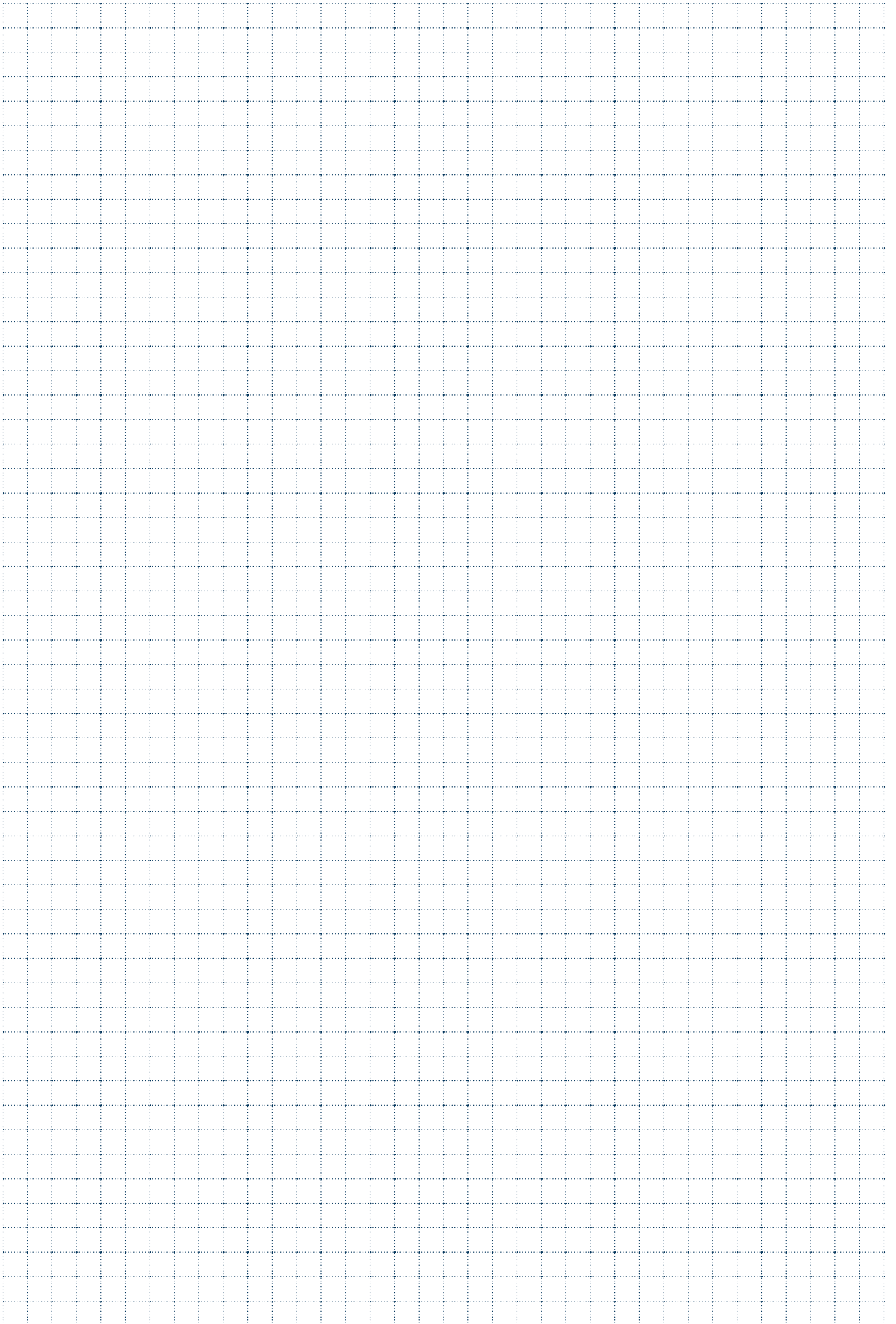



	DENOMINAZIONI DEGLI INSERTI PER FORATURA	Pag. 684
	CATALOGO DISPONIBILITÀ INSERTI	Pag. 685
	COME SCEGLIERE I PARAMETRI DI LAVORO	Pag. 689
	PANORAMICA QUALITÀ DI FORATURA	Pag. 691
	IMPIEGO DELLE QUALITÀ DI FORATURA	Pag. 692
	VELOCITÀ DI TAGLIO DELLE QUALITÀ DI FORATURA	Pag. 694

	INSERTS DESIGNATION FOR DRILLING	Pag. 684
	INSERTS STOCK CATALOGUE	Pag. 685
	HOW TO CHOOSE CUTTING DATA	Pag. 689
	GENERAL VIEW OF THE DRILLING GRADE	Pag. 691
	APPLICATION OF THE DRILLING GRADE	Pag. 692
	CUTTING SPEED OF DRILLING GRADE	Pag. 694

	BEZEICHNUNG DER WENDEPLATTEN ZUM BOHREN	Pag. 684
	WENDEPLATTENBESTAND-KATALOG	Pag. 685
	EINSTELLUNG DER SCHNITTDATEN	Pag. 689
	BOHREN-ÜBERSICHT	Pag. 691
	EINSATZ DER BOHREN	Pag. 692
	SCHNITTGESCHWINDIGKEIT DER BOHREN (VC)	Pag. 694

	DÉNOMINATION DE LES PLAQUETTES POUR LE PERÇAGE	Pag. 684
	CATALOGUE DE DISPONIBILITÉ PLAQUETTES	Pag. 685
	COMMENT CHOISIR LES PARAMETRES DE SERVICE	Pag. 689
	VUE D' ENSEMBLE QUALITÉ DE PERÇAGE	Pag. 691
	UTILISATION DE LES QUALITÉES DE PERÇAGE	Pag. 692
	VITESSE DE COUPE DE LA QUALITÉ DE PLAQUETTES DE PERÇAGE	Pag. 694



INSERTI PER FORATURA

DRILLING INSERTS / WENDEPLATTEN ZUM BOHREN / PLAQUÉTTES POUR PERÇAGE
PLAQUITAS DE TALADRADO



W	C	G	T
1	2	3	4

06	03	04
5	6	7

S	N
8	9

-	-	-	P
10	11	12	13

1 FORMA INSERTO
SHAPE OF INSERT

A	B
C	D
E	H
K	L
M	R
S	T
V	W

2 SPOGLIA INFER.
RELIEF ANGLE

A
B
C
D
E
F
G
N
P

3 TOLLERANZA+/- (mm)
TOLERANCE+/- (mm)

	m	s	d
A	+/-0,005	+/-0,025	+/-0,025
C	+/-0,013	+/-0,025	+/-0,025
E	+/-0,025	+/-0,025	+/-0,025
F	+/-0,005	+/-0,025	+/-0,013
G	+/-0,025	+/-0,05 +/-0,13	+/-0,025
H	+/-0,013	+/-0,025	+/-0,013
J	+/-0,005	+/-0,025	+/-0,05 +/-0,13
K	+/-0,013	+/-0,025	+/-0,05 +/-0,13
L	+/-0,05	+/-0,013	+/-0,025
M	+/-0,08 +/-0,18	+/-0,13	+/-0,05 +/-0,18
N	+/-0,08 +/-0,18	+/-0,025	+/-0,05 +/-0,13
U	+/-0,13 +/-0,38	+/-0,05 +/-0,13	+/-0,08 +/-0,32

4 TIPO INSERTO
TYPE OF INSERT

A	N
B	Q
C	R
F	T
G	U
H	W
J	X SPECIALE SPECIAL
M	

5 LUNGHEZZA TAGLIANTE
CUTTING EDGE LENGTH

Ød CERCHIO INSCRITTO CIRCLE	A	C	D	E	K	L	M	R	S	T	V	W
3,97												02
4,76										08		02-03
5,56		05								09		
6,00												03
6,35		06	07	06			06		06	11	11	04
6,70	10											
7,94									07			
8,00				08								05
9,45	16											
9,52	15-16	09	11	09	16	15	09		09	16	16	06
10,00								10				06
11,00									11			
11,50						12						
12,00								12				07
12,62						18						
12,70		12	15	12		15-20			12	22		08
15,87		16							15			
19,05		19							19			

6 SPESSORE
THICKNESS

S	mm
01	1,59
T1	1,97
02	2,38
T2	2,78
H3	2,80
X3	3,00
03	3,18
T3	3,97
04	4,76
05	5,56
06	6,35
07	7,94
09	9,52

7 RAGGIO
RADIUS

R	MO (mm)
02	r=0,2
04	r=0,4
05	r=0,5
06	r=0,6
08	r=0,8
10	r=1,0
12	r=1,2
16	r=1,6

8

F
E
T
S

9

L
N

10 LETTERA DI IDENTIF.
IDENTIFICATION LETTER

A	N
C	P
D	R
E	S
H	T
I	U
J	W
K	Y
L	Z
M	

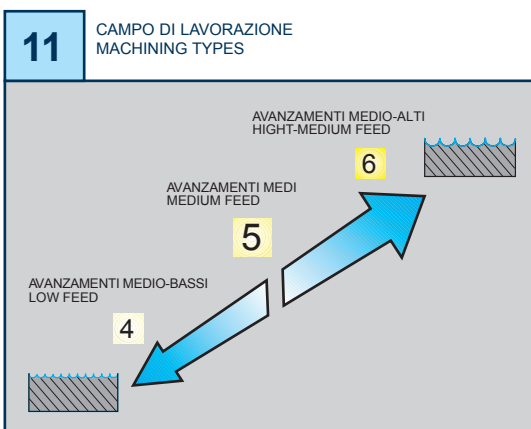

12 PREPARAZIONE TAGLIANTE
CUTTING EDGE PREPARATION

1 =	SPECIFICO PER GHISA SPECIFIC FOR CAST IRON
3 =	SPECIFICO PER ACCIAIO INOX SPECIFIC FOR STAINLESS STEEL
7 =	SPECIFICO PER LEGHE DI ALLUMINIO SPECIFIC FOR ALUMINIUM ALLOYS
9 =	SPECIFICO PER ACCIAIO SPECIFIC FOR STEEL
2 =	
4 =	
5 =	INTERMEDI DI USO GENERIC INTERMEDIATE FOR GENERAL USE
6 =	
8 =	

13 LUCIDATO
POLISH

QCMX			WCMT WCMX							HW			HC				
										NON RIVESTITI CEMENTED CARBIDE GRADES			RIVESTITI COATED GRADES BESCHICHTET RECOUVRETS				
ART	COD.		l	d	s	d1	r	a°	b°	T120	T3610	T7530 $\leq m/z$	T5320	T5322	T530	T540 $\leq m/z$	
	QCMX 010204 .X36	5,4	5,8	2,38	2,5	0,4	7	-									
	QCMX 020204 .X36	6,6	7,1	2,38	2,5	0,4	7	-									
	QCMX 030308 .X36	8,3	8,8	3,18	3,4	0,8	7	-									
	QCMX 040308 .X36	9,6	10,2	3,18	3,4	0,8	7	-									
	QCMX 050412 .X36	11,3	12,1	4,76	4,3	1,2	7	-									
	QCMX 060412 .X36	13,8	14,8	4,76	4,3	1,2	7	-									
	QCMX 080412 .X36	17,2	18,5	4,76	4,3	1,2	7	-									
	QCMX 010204 .X42	5,4	5,8	2,38	2,5	0,4	7	-									
	QCMX 020204 .X42	6,6	7,1	2,38	2,5	0,4	7	-									
	QCMX 030308 .X42	8,3	8,8	3,18	3,4	0,8	7	-									
	QCMX 040308 .X42	9,6	10,2	3,18	3,4	0,8	7	-									
	QCMX 050412 .X42	11,3	12,1	4,76	4,3	1,2	7	-									
	QCMX 060412 .X42	13,8	14,8	4,76	4,3	1,2	7	-									
	QCMX 080412 .X42	17,2	18,5	4,76	4,3	1,2	7	-									
	QCMX 010204 .X52	5,4	5,8	2,38	2,5	0,4	7	-									
	QCMX 020204 .X52	6,6	7,1	2,38	2,5	0,4	7	-									
	QCMX 030308 .X52	8,3	8,8	3,18	3,4	0,8	7	-									
	QCMX 040308 .X52	9,6	10,2	3,18	3,4	0,8	7	-									
	QCMX 050412 .X52	11,3	12,1	4,76	4,3	1,2	7	-									
	QCMX 060412 .X52	13,8	14,8	4,76	4,3	1,2	7	-									
	QCMX 080412 .X52	17,2	18,5	4,76	4,3	1,2	7	-									
	WCMT 030204 .K58	3,8	5,56	2,38	2,5	0,4	7°	80°									
	WCMT 040204 .K58	4,3	6,35	2,38	2,8	0,4	7°	80°									
	WCMT 050308 .K58	5,4	7,94	3,18	3,4	0,8	7°	80°									
	WCMT 06T308 .K58	6,5	9,52	3,97	4,0	0,8	7°	80°									
	WCMT 080408 .K58	8,7	12,7	4,76	4,3	0,8	7°	80°									
	NEW																
	WCMX 040208 .S42	3,99	6,35	2,38	2,8	0,8	7°	80°									
	WCMX 050308 .S42	5,07	7,94	3,18	3,4	0,8	7°	80°									
	WCMX 06T308 .S42	6,14	9,52	3,97	3,8	0,8	7°	80°									
	WCMX 080412 .S42	8,14	12,7	4,76	4,4	1,2	7°	80°									
	WCMX 030208 .S62	3,46	5,56	2,38	2,5	0,8	7°	80°									
	WCMX 040208 .S62	3,99	6,35	2,38	2,8	0,8	7°	80°									
	WCMX 050308 .S62	5,07	7,94	3,18	3,4	0,8	7°	80°									
	WCMX 06T308 .O62	6,14	9,52	3,97	3,8	0,8	7°	80°									
	WCMX 06T308 .S62	6,14	9,52	3,97	3,8	0,8	7°	80°									
WCMX 080412 .S62	8,14	12,7	4,76	4,4	1,2	7°	80°										
MATERIALE - MATERIAL - MATERIALIEN - MATÉRIAUX										T120	T3610	T7530 $\leq m/z$	T5320	T5322	T530	T540 $\leq m/z$	
P	ACCIAIO - STEEL - STAHL - ACIER										○	●		●	●	●	●
M	ACCIAIO INOX - STAINLESS STEEL - ROSTFREIER STAHL - ACIER INOXYDABLE											●		○	●	○	●
K	GHISA - CAST IRON - GRAUGUSS - FONTE GRISE									○		●	○		○		
N	LEGHE DI ALLUMINIO - ALUMINIUM ALLOYS - ALUMINIUM-LEGIERUNGEN - ALLIAGES D'ALUMINIUM									●					○		
S	LEGHE RESISTENTI AL CALORE - HEAT RESISTANT ALLOYS - WÄRMEBESTÄNDIGE LEGIERUNGEN - ALLIAGES RÉISTANTES À LA CHALEUR									○		●					
H	MATERIALI DURI E TEMPRATI - HARD AND HARDENED MATERIAL - HARTE UND GEHÄRTETE MATERIALIEN - MATERIAUX DURS ET TREMPÉS																

● DISPONIBILI - IN STOCK - LIEFERBAR - DISPONIBLES / ■ NEW
 ● APPLICAZIONE CONSIGLIATA-RECOMMENDED APPLICATION-
 EMPFOHLENER EINSATZ - APPLICATION CONSEILLÉE

□ A RICHIESTA - ON REQUEST - AUF ANFRAGE - SUR DEMANDE / □ NEW
 ○ APPLICAZIONE POSSIBILE - POSSIBLE APPLICATION -
 MÖGLICHE ANWENDUNG - APPLICATION POSSIBLE

SM...30 SM...45 SM...55								HW		HC									
								NON RIVESTITI CEMENTED CARBIDE GRADES		RIVESTITI COATED GRADES BESCHICHTET RECOUVERTS									
ART	COD.	l	s	d1	SM	h	α											T519D	
	SM 0702 - 30	6,35	2,38	2,8	2,2	1,3	30°											■	
	SM 0702 - 45	6,35	2,38	2,8	2,3	2,3	45°											■	
	SM 0702 - 55	6,35	2,38	2,8	3,9	5,6	55°											■	
MATERIALE - MATERIAL - MATERIALIEN - MATÉRIAUX																		T519D	
P	ACCIAIO - STEEL - STAHL - ACIER											●							
M	ACCIAIO INOX - STAINLESS STEEL - ROSTFREIER STAHL - ACIER INOXYDABLE											○							
K	GHISA - CAST IRON - GRAUGUSS - FONTE GRISE											●							
N	LEGHE DI ALLUMINIO - ALUMINIUM ALLOYS - ALUMINIUM-LEGIERUNGEN - ALLIAGES D'ALUMINIUM											○							
S	LEGHE RESISTENTI AL CALORE - HEAT RESISTANT ALLOYS - WÄRMEBESTÄNDIGE LEGIERUNGEN - ALLIAGES RÉSISSANTES À LA CHALEUR																		
H	MATERIALI DURI E TEMPRATI - HARD AND HARDENED MATERIAL - HARTE UND GEHÄRTETE MATERIALIEN - MATERIAUX DURS ET TREMPÉS																		

IN ESAURIMENTO
END OF STOCK
AUSLAUFEND
EN ÉPUISEMENT

■ DISPONIBILI - IN STOCK - LIEFERBAR - DISPONIBLES / ■ NEW
● APPLICAZIONE CONSIGLIATA-RECOMMENDED APPLICATION-
EMPFOLHENER EINSATZ - APPLICATION CONSEILLÉE

□ A RICHIESTA - ON REQUEST - AUF ANFRAGE - SUR DEMANDE / □ NEW
○ APPLICAZIONE POSSIBILE - POSSIBLE APPLICATION -
MÖGLICHE ANWENDUNG - APPLICATION POSSIBLE

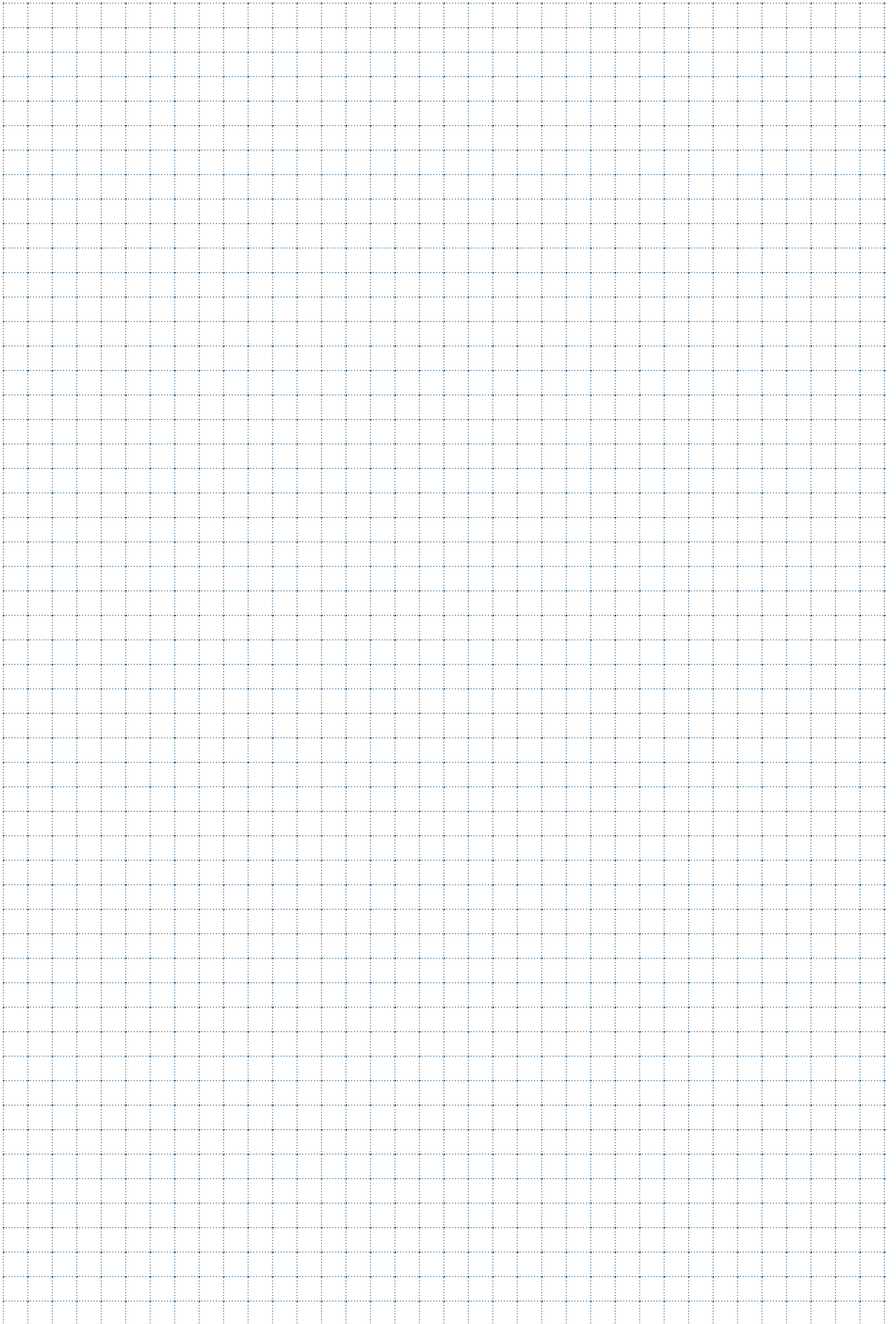

SCelta VELOCE QUICK PICK

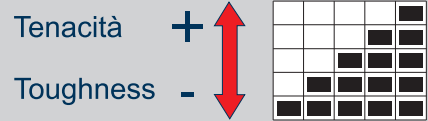

- METODO PER LA SCELTA VELOCE DEL GRADO DI METALLO DURO PIÙ IDONEO. CONTARE IL NUMERO DI RETTANGOLI COLORATI
- METHOD FOR A QUICK CHOICE OF THE MOST SUITABLE SOLID CARBIDE GRADE. COUNT THE NUMBER OF COLORED RECTANGLES
- METHODE ZUR RASCHEN AUSWAHL DER GEEIGNETSTEN HARTMETALLSORTE. DIE ANZAHL DER BUNTEN RECHTECKE ZÄHLEN
- METHODE POUR CHOISIR RAPIDEMENT LE DEGRÉ LE PLUS APPROPRIÉ DU METAL DUR. COMPTEZ LES RECTANGLES EN COULEURS
- METODO PARA LA ELECCION RAPIDA DE EL GRADO MAS ADECUADO DE METAL DURO. CONTAR LOS NUMEROS DE RECTANGULOS COLORADOS

- GRADO MOLTO RESISTENTE ALL'USURA, SOLO PER FINITURA, LAVORAZIONI AD ALTE VELOCITÀ DI TAGLIO E CONDIZIONI MOLTO RIGIDE E STABILI
- GRADE WITH HIGH RESISTANCE TO WEAR; ONLY FOR FINISHING, MACHINING AT HIGH CUTTING SPEEDS, AND VERY RIGID AND STABLE CONDITIONS
- GRADO CON ALTA RESISTENZA ALL'USURA, DISCRETA TENACITÀ PER LAVORAZIONI A VELOCITÀ MEDIO ALTE ED AVANZAMENTI MEDI, IN CONDIZIONI NORMALI
- GRADE WITH HIGH RESISTANCE TO WEAR, GOOD TOUGHNESS, FOR MEDIUM-HIGH MACHINING AND MEDIUM FEED UNDER NORMAL CONDITIONS
- GRADO CON BUONA RESISTENZA ALL'USURA UNITA A BUONA TENACITÀ, PER LAVORAZIONI GENERICHE IN CONDIZIONI NORMALI
- GRADE WITH GOOD RESISTANCE TO WEAR; COMBINED WITH A GOOD DEGREE OF TOUGHNESS, FOR GENERAL MACHINING UNDER NORMAL CONDITIONS
- GRADO CON OTTIMA TENACITÀ PER LAVORAZIONI MEDIO PESANTI O IN CONDIZIONI POCO STABILI
- GRADE WITH EXCELLENTE TOUGHNESS, FOR MEDIUM HEAVY MACHINING OR MACHINING UNDER CONDITIONS OF LOW STABILITY
- GRADO CON ECCEZIONALE TENACITÀ PER LAVORAZIONI PESANTI CON BASSE VELOCITÀ DI TAGLIO, ALTI AVANZAMENTI O IN CONDIZIONI SFAVOREVOLI
- GRADE WITH EXCELLENTE TOUGHNESS, FOR HEAVY MACHINING WITH LOW CUTTING SPEEDS, HIGH FEED, OR UNDER UNFAVORABLE CONDITIONS

GUIDA FACILE EASY GUIDE

QCMX 060412 .X42
T5322

	F	M	R	fn = 0,06-0,25 mm
	●			P Vc = 200-380 m/min
	●			M Vc = 100-200 m/min
				K
	○			N Vc = 200-500 m/min
				S
				H

QCMX 060412 .X42 - T5322

P10-30 / M15-30 / K15-25

T5322

- GUIDA ALL'USO DELL'INSERTO. PRESENTE ANCHE SU OGNI ETICHETTA
- GUIDE FOR THE USE OF THE INSERT. ALSO LISTED ON EACH LABEL
- LEITFADEN ZUR VERWENDUNG DER WENDEPLATTE, AUCH AUF JEDEM AUFKLEBER VORHANDEN
- INSTRUCTIONS POUR L'UTILISATION DE LA PLAQUETTE. SE TROUVANT EGALEMENT SUR CHAQUE ETIQUETTE
- GUIA POR EL UTILIZO DE LA PLAQUITA, PRESENTE TAMBIEN EN CADA ETIQUETA

GR. VDI 3323	6	P	= ACCIAIO BASSO LEGATO HB 180		= LOW STEEL ALLOY
	14.1	M	= ACCIAIO INOSSIDABILE AUSTENITICO HB 180		= AUSTENITIC STAINLESS STEEL HB 180
	16	K	= GHISA GRIGIA HB 260		= GRAY CAST IRON HB 260
	21	N	= LEGHE DI ALLUMINIO HB 60		= ALUMINUM ALLOYS HB 60
	33	S	= LEGHE RESISTENTI AL CALORE (INCONEL) HB 250		= HEAT RESISTANT ALLOYS (INCONEL) HB 250
38	H	= ACCIAIO TEMPRATO HRC 55		= TEMPERED STEEL HRC 55	

- | | |
|--|---|
| <p>F = FINITURA, LAVORAZIONI LEGGERE</p> <p>M = LAVORAZIONI MEDIE, IMPIEGO GENERICO</p> <p>R = SGROSSATURA, LAVORAZIONI PESANTI</p> | <p>- FINISHING, LIGHT MACHINING</p> <p>- MEDIUM MACHINING, GENERAL USE</p> <p>- ROUGHING, HEAVY MACHINING</p> |
| <p>fn (mm) = AVANZAMENTO PER TORNITURA</p> <p>fz (mm/z) = AVANZAMENTO PER FRESATURA</p> <p>Vc (m/min) = VELOCITÀ DI TAGLIO</p> | <p>- FEED FOR TURNING</p> <p>- FEED FOR MILLING</p> <p>- CUTTING SPEED</p> |
| <p>● = APPLICAZIONE CONSIGLIATA</p> <p>○ = APPLICAZIONE POSSIBILE</p> | <p>- RECOMMENDED APPLICATION</p> <p>- POSSIBLE APPLICATION</p> |

COME SCEGLIERE I PARAMETRI DI LAVORO
HOW TO CHOOSE CUTTING DATA
EINSTELLUNG DER SCHNITTDATEN
COMMENT CHOISIR LES PARAMETRES DE SERVICE

FASE 1 - PHASE 1

SCelta GR. VDI IN FUNZIONE DEL MATERIALE
 CHOICE OF VDI GR. DEPENDING ON MATERIAL
 WAHL VDI-SORTE JE NACH WERKSTOFF
 CHOIX GR. VDI EN FONCTION DU MATERIEL

Tabella comparativa dei materiali - Materials comparison table
 Material vergleichstabelle - Tableau comparatif des matériaux



UNI	WISTOFF	DIN	SAE	BS	AFNOR	JIS	Act.1	mc	VDI 3323 GR.
ACCIAIO NON LEGATO RICOTTO ANNEALED NOT-ALLOY STEEL									
C < 0,15% 125 HB									
CF 10 SPS 20	1.0722	10 SPS 20	11 L 08	-	10 PUF 2	-	-	-	0,22
CF 9 SMO 28	1.0715	9 SMO 28	1213	202 M 07	S 200	-	-	-	0,22
CF 9 SMO 36	1.0726	9 SMO 36	1216	202 M 07	S 200	-	-	-	0,22
CF 9 SMO-Pb 28	1.0718	9 SMO-Pb 28	12 L 13	-	S 200 Pb	-	-	-	0,22
CF 9 SMO-Pb 36	1.0727	9 SMO-Pb 36	12 L 14	-	S 200 Pb	-	-	-	0,22
C15 C16	1.0401	C 15	1015	080 M 15	AF 37 C 12, XC 18	-	-	-	0,22
C20 C21	1.0402	C 20	1020	080 A 20	AF 43 C 20	-	-	-	0,22
C 16	1.1441	Ck 15	1015	080 M 15	XC 15, XC 18	-	-	-	0,22
ACCIAIO NON LEGATO RICOTTO ANNEALED NOT-ALLOY STEEL									
C 0,15-0,55%									
-	1.1770	28 M 6	1330	150 M 28	20 M 5	-	-	-	0,22
-	1.1728	38 S 20	1140	212 M 38	35 M 4	-	-	-	0,22
-	1.1727	38 M 8	1140	212 M 38	35 M 4	-	-	-	0,22
-	1.1157	40 M 4	1039	150 M 36	35 M 4	-	-	-	0,22
-	1.0501	C 35	1035	080 A 35	AF 35 C 35	-	-	-	0,22
-	1.0503	C 45	1045	080 M 46	AF 45 C 45	-	-	-	0,22
-	1.0511	C 53	1045	080 M 46	AF 45 C 45	-	-	-	0,22
-	1.1710	28 M 6	1330	150 M 28	20 M 5	-	-	-	0,22
-	1.1726	35 S 20	1140	212 M 35	35 M 4	-	-	-	0,22
-	1.1727	38 M 8	1140	212 M 38	35 M 4	-	-	-	0,22
-	1.1157	40 M 4	1039	150 M 36	35 M 4	-	-	-	0,22
-	1.0501	C 35	1035	080 A 35	AF 35 C 35	-	-	-	0,22
-	1.0503	C 45	1045	080 M 46	AF 45 C 45	-	-	-	0,22
-	1.0511	C 53	1045	080 M 46	AF 45 C 45	-	-	-	0,22
-	1.1710	28 M 6	1330	150 M 28	20 M 5	-	-	-	0,22
-	1.1726	35 S 20	1140	212 M 35	35 M 4	-	-	-	0,22
-	1.1727	38 M 8	1140	212 M 38	35 M 4	-	-	-	0,22
-	1.1157	40 M 4	1039	150 M 36	35 M 4	-	-	-	0,22
-	1.0501	C 35	1035	080 A 35	AF 35 C 35	-	-	-	0,22
-	1.0503	C 45	1045	080 M 46	AF 45 C 45	-	-	-	0,22
-	1.0511	C 53	1045	080 M 46	AF 45 C 45	-	-	-	0,22
-	1.1710	28 M 6	1330	150 M 28	20 M 5	-	-	-	0,22
-	1.1726	35 S 20	1140	212 M 35	35 M 4	-	-	-	0,22
-	1.1727	38 M 8	1140	212 M 38	35 M 4	-	-	-	0,22
-	1.1157	40 M 4	1039	150 M 36	35 M 4	-	-	-	0,22
-	1.0501	C 35	1035	080 A 35	AF 35 C 35	-	-	-	0,22
-	1.0503	C 45	1045	080 M 46	AF 45 C 45	-	-	-	0,22
-	1.0511	C 53	1045	080 M 46	AF 45 C 45	-	-	-	0,22
-	1.1710	28 M 6	1330	150 M 28	20 M 5	-	-	-	0,22
-	1.1726	35 S 20	1140	212 M 35	35 M 4	-	-	-	0,22
-	1.1727	38 M 8	1140	212 M 38	35 M 4	-	-	-	0,22
-	1.1157	40 M 4	1039	150 M 36	35 M 4	-	-	-	0,22
-	1.0501	C 35	1035	080 A 35	AF 35 C 35	-	-	-	0,22
-	1.0503	C 45	1045	080 M 46	AF 45 C 45	-	-	-	0,22
-	1.0511	C 53	1045	080 M 46	AF 45 C 45	-	-	-	0,22
-	1.1710	28 M 6	1330	150 M 28	20 M 5	-	-	-	0,22
-	1.1726	35 S 20	1140	212 M 35	35 M 4	-	-	-	0,22
-	1.1727	38 M 8	1140	212 M 38	35 M 4	-	-	-	0,22
-	1.1157	40 M 4	1039	150 M 36	35 M 4	-	-	-	0,22
-	1.0501	C 35	1035	080 A 35	AF 35 C 35	-	-	-	0,22
-	1.0503	C 45	1045	080 M 46	AF 45 C 45	-	-	-	0,22
-	1.0511	C 53	1045	080 M 46	AF 45 C 45	-	-	-	0,22
-	1.1710	28 M 6	1330	150 M 28	20 M 5	-	-	-	0,22
-	1.1726	35 S 20	1140	212 M 35	35 M 4	-	-	-	0,22
-	1.1727	38 M 8	1140	212 M 38	35 M 4	-	-	-	0,22
-	1.1157	40 M 4	1039	150 M 36	35 M 4	-	-	-	0,22
-	1.0501	C 35	1035	080 A 35	AF 35 C 35	-	-	-	0,22
-	1.0503	C 45	1045	080 M 46	AF 45 C 45	-	-	-	0,22
-	1.0511	C 53	1045	080 M 46	AF 45 C 45	-	-	-	0,22
-	1.1710	28 M 6	1330	150 M 28	20 M 5	-	-	-	0,22
-	1.1726	35 S 20	1140	212 M 35	35 M 4	-	-	-	0,22
-	1.1727	38 M 8	1140	212 M 38	35 M 4	-	-	-	0,22
-	1.1157	40 M 4	1039	150 M 36	35 M 4	-	-	-	0,22
-	1.0501	C 35	1035	080 A 35	AF 35 C 35	-	-	-	0,22
-	1.0503	C 45	1045	080 M 46	AF 45 C 45	-	-	-	0,22
-	1.0511	C 53	1045	080 M 46	AF 45 C 45	-	-	-	0,22
-	1.1710	28 M 6	1330	150 M 28	20 M 5	-	-	-	0,22
-	1.1726	35 S 20	1140	212 M 35	35 M 4	-	-	-	0,22
-	1.1727	38 M 8	1140	212 M 38	35 M 4	-	-	-	0,22
-	1.1157	40 M 4	1039	150 M 36	35 M 4	-	-	-	0,22
-	1.0501	C 35	1035	080 A 35	AF 35 C 35	-	-	-	0,22
-	1.0503	C 45	1045	080 M 46	AF 45 C 45	-	-	-	0,22
-	1.0511	C 53	1045	080 M 46	AF 45 C 45	-	-	-	0,22
-	1.1710	28 M 6	1330	150 M 28	20 M 5	-	-	-	0,22
-	1.1726	35 S 20	1140	212 M 35	35 M 4	-	-	-	0,22
-	1.1727	38 M 8	1140	212 M 38	35 M 4	-	-	-	0,22
-	1.1157	40 M 4	1039	150 M 36	35 M 4	-	-	-	0,22
-	1.0501	C 35	1035	080 A 35	AF 35 C 35	-	-	-	0,22
-	1.0503	C 45	1045	080 M 46	AF 45 C 45	-	-	-	0,22
-	1.0511	C 53	1045	080 M 46	AF 45 C 45	-	-	-	0,22
-	1.1710	28 M 6	1330	150 M 28	20 M 5	-	-	-	0,22
-	1.1726	35 S 20	1140	212 M 35	35 M 4	-	-	-	0,22
-	1.1727	38 M 8	1140	212 M 38	35 M 4	-	-	-	0,22
-	1.1157	40 M 4	1039	150 M 36	35 M 4	-	-	-	0,22
-	1.0501	C 35	1035	080 A 35	AF 35 C 35	-	-	-	0,22
-	1.0503	C 45	1045	080 M 46	AF 45 C 45	-	-	-	0,22
-	1.0511	C 53	1045	080 M 46	AF 45 C 45	-	-	-	0,22
-	1.1710	28 M 6	1330	150 M 28	20 M 5	-	-	-	0,22
-	1.1726	35 S 20	1140	212 M 35	35 M 4	-	-	-	0,22
-	1.1727	38 M 8	1140	212 M 38	35 M 4	-	-	-	0,22
-	1.1157	40 M 4	1039	150 M 36	35 M 4	-	-	-	0,22
-	1.0501	C 35	1035	080 A 35	AF 35 C 35	-	-	-	0,22
-	1.0503	C 45	1045	080 M 46	AF 45 C 45	-	-	-	0,22
-	1.0511	C 53	1045	080 M 46	AF 45 C 45	-	-	-	0,22
-	1.1710	28 M 6	1330	150 M 28	20 M 5	-	-	-	0,22
-	1.1726	35 S 20	1140	212 M 35	35 M 4	-	-	-	0,22
-	1.1727	38 M 8	1140	212 M 38	35 M 4	-	-	-	0,22
-	1.1157	40 M 4	1039	150 M 36	35 M 4	-	-	-	0,22
-	1.0501	C 35	1035	080 A 35	AF 35 C 35	-	-	-	0,22
-	1.0503	C 45	1045	080 M 46	AF 45 C 45	-	-	-	0,22
-	1.0511	C 53	1045	080 M 46	AF 45 C 45	-	-	-	0,22
-	1.1710	28 M 6	1330	150 M 28	20 M 5	-	-	-	0,22
-	1.1726	35 S 20	1140	212 M 35	35 M 4	-	-	-	0,22
-	1.1727	38 M 8	1140	212 M 38	35 M 4	-	-	-	0,22
-	1.1157	40 M 4	1039	150 M 36	35 M 4	-	-	-	0,22
-	1.0501	C 35	1035	080 A 35	AF 35 C 35	-	-	-	0,22
-	1.0503	C 45	1045	080 M 46	AF 45 C 45	-	-	-	0,22
-	1.0511	C 53	1045	080 M 46	AF 45 C 45	-	-	-	0,22
-	1.1710	28 M 6	1330	150 M 28	20 M 5	-	-	-	0,22
-	1.1726	35 S 20	1140	212 M 35	35 M 4	-	-	-	0,22
-	1.1727	38 M 8	1140	212 M 38	35 M 4	-	-	-	0,22
-	1.1157	40 M 4	1039	150 M 36	35 M 4	-	-	-	0,22
-	1.0501	C 35	1035	080 A 35	AF 35 C 35	-	-	-	0,22
-	1.0503	C 45	1045	080 M 46	AF 45 C 45	-	-	-	0,22
-	1.0511	C 53	1045	080 M 46	AF 45 C 45	-	-	-	0,22
-	1.1710	28 M 6	1330	150 M 28	20 M 5	-	-	-	0,22
-	1.1726	35 S 20	1140	212 M 35	35 M 4	-	-	-	0,22
-	1.1727	38 M 8	1140	212 M 38	35 M 4	-	-	-	0,22
-	1.1157	40 M 4	1039	150 M 36	35 M 4	-	-	-	0,22
-	1.0501	C 35	1035	080 A 35	AF 35 C 35	-	-	-	0,22
-	1.0503	C 45	1045	080 M 46	AF 45 C 45	-	-	-	0,22





- PANORAMICA QUALITÀ DI FORATURA**
- GENERAL VIEW OF THE DRILLING GRADE**
- BOHREN-ÜBERSICHT**
- VUE D' ENSEMBLE QUALITÉ DE PERÇAGE**
- VISTA GENERAL DE LA CALIDAD DE TALADRADO**

DIN ISO 513	P ACCIAI STEELS STAHL ACIERS					M ACCIAI INOSSIDABILI STAINLESS STEELS ROSTFREIER STAHL ACIER INOXYDABLE				K GHISE CAST IRON GRAUGUSS FONTE GRISE					N NON FERROSI NONFERROUS NICHT-EISENMA PAS FERREUX				S MAT.DIFFICILI DIFFICULT MATERIAL SCHWIERIGE MATERIEN MAT.DIFICILES					H MATERIALI DURI HARD MATERIALS HARTE MATERIEN MATÉRIEAUX DURS			
	01	10	20	30	40	50	10	20	30	40	01	10	20	30	40	01	10	20	30	01	10	20	30	40	01	10	20
HW						T120				T120																	
HC	T3610									T3610																	
	T7530					T7530				T7530					T7530				NEW								
	T519D					T519D				T519D																	
	T5320					T5320				T5320																	
	T5322					T5322				T5322																	
	T530					T530																					
	T540					T540				NEW																	
TENACITÀ - TOUGHNESS - ZÄHIGKEIT - TÉNACITÉ																											
←→					←→				←→					←→				←→					←→				
RESISTENZA ALL'USURA - RESISTANCE TO WEAR - VERSCHLEISSFESTIGKEIT - RÉSISTANCE À L'USURE																											
AVANZAMENTO - FEED - VORSCHUB - AVANCE																											
←→					←→				←→					←→				←→					←→				
VELOCITÀ - SPEED - GESCHWINDIGKEIT - VITESSE																											
HT CERMET					HW METALLO DURO NON RICOPERTO UNCOATED CARBIDE UNBESCHICHTETES HARTMETALL MÉTAL DUR PAS RECOUVERT				HC METALLO DURO RICOPERTO COATED CARBIDE BESCHICHTETES HARTMETALL MÉTAL DUR RECOUVERT																		

SAU	DIN ISO 513		MATERIALE - MATERIAL MATERIALIEN - MATÉRIAUX PAG. 1199							QUICK PICK PAG. 688	 Tenacità + Toughness -	 INDICAZIONI - USO
			P	M	K	N	S	H				
			ACCIAI STEELS STAHL ACIER	ACCIAI INOX STAINLESS STEELS ROSTFREIER STAHL ACIER INOXYDABLE	GHISA CAST IRON GRAUGUSS	MAT. NON FERROSI NON FERROUS MAT. NICHT-EISENMATERIALIEN MAT. FERREUX	MAT. DIFFICILI DIFFICULT MATERIAL SCHWERIGE MATERIALIEN MAT. DIFICILES	MATERIALI DURI HARD MATERIALS HARTE MATERIALIEN MATÉRIAUX DURS				
T120	HW	M10-20 K10-20			○	●	○			●	- ALTA RESISTENZA ALL' USURA E BUONA TENACITÀ - INDICATO PER MEDIE VELOCITÀ DI TAGLIO E MEDI AVANZAMENTI	
T3610	HC CVD	P10-30 K10-25	○		●					●	-INSERTO RESISTENTE ALL'USURA -INDICATO PER MEDIE ALTE VELOCITÀ DI TAGLIO -ADATTO PER LA LAVORAZIONE DELLA GHISA	
T7530 NEW	HC CVD	P30-40 M15-25 K01-25 S01-25	●	●	○		●			●	-QUALITÀ TENACE PER LA MASSIMA SICUREZZA OPERATIVA	
T519D	HC CVD	P20-25 M15-25 K20-25	●	○	●	○				●	- QUALITÀ MICROGRANO CON ELEVATA TENACITÀ - INDICATO PER MEDIO-BASSE VELOCITÀ DI TAGLIO	
T5320	HC CVD	P10-30 M20-35 K15-30	●	○	○					●	-INSERTO CON MEDIA TENACITÀ -INDICATO PER MEDIE ALTE VELOCITÀ DI TAGLIO -ADATTO PER LA LAVORAZIONE DEGLI ACCIAI LEGATI E DEBOLMENTE LEGATI	
T5322	HC CVD	P10-30 M15-30 K15-30	●	●		○				●	-INSERTO CON MEDIA TENACITÀ -INDICATO PER MEDIE ALTE VELOCITÀ DI TAGLIO -ADATTO PER LA LAVORAZIONE DEGLI ACCIAI BASSO LEGATI E INOX	
T530	HC CVD	P30-40 M20-25	●	○						●	-GRADO MOLTO TENACE PARTICOLARMENTE INDICATO ALLA LAVORAZIONE A BASSE VELOCITÀ DI TAGLIO E SU MATERIALI MOLTO TENACI (ES. FE O ACCIAIO ALTA VELOCITÀ AL PIOMBO). -POSSIBILE IMPIEGO ANCHE SU ACCIAIO INOX E MATERIALI NON FERROSI.	
T540 NEW	HC CVD	P25-45 M25-40	●	●						●	-BUONA RESISTENZA AGLI URTI -PER SGROSSATURA DI ACCIAI E ACCIAI INOSSIDABILI.	

- APPLICAZIONE CONSIGLIATA
RECOMMENDED APPLICATION
EMPFOHLENER EINSATZ
APPLICATION CONSEILLÉE
- APPLICAZIONE POSSIBILE
POSSIBLE APPLICATION
MÖGLICHE ANWENDUNG
APPLICATION POSSIBLE
- APPLICAZIONE CONSIGLIATA
RECOMMENDED APPLICATION
EMPFOHLENER EINSATZ
APPLICATION CONSEILLÉE
- APPLICAZIONE POSSIBILE
POSSIBLE APPLICATION
MÖGLICHE ANWENDUNG
APPLICATION POSSIBLE

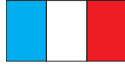
 INDICATIONS - USE	 GEBRAUCHSANWEISUNGEN	 INDICATION - USAGE
-HIGH RESISTANCE TO WEAR WITH GOOD TOUGHNESS -SUITABLE FOR MEDIUM CUTTING SPEEDS AND MEDIUM FEED	-HOHE VERSCHLEISSFESTIGKEIT MIT SEHR ZÄHIGKET -FÜR MITTEL SCHNITTGESCHWINDIGKEITEN UND MITTEL VORSCHÜBE	-HAUTE RESISTANCE ET BONNE TENACITÉ -INDIQUÉE POUR LE MOYENNE VITESSE DE COUPE ET MOYENNE DÉPLACEMENT
- WEAR-RESISTANT INSERT - IDEAL FOR MEDIUM TO HIGH CUTTING SPEEDS - SUITABLE FOR MACHINING CAST IRON	- VERSCHLEISSFESTE WENDEPLATTE - GEEIGNET FÜR MITTLERE/HOHE SCHNITTGESCHWINDIGKEITEN - GEEIGNET FÜR GUSSBEARBEITUNGEN	- PLAQUETTE RÉSIANT À L'USURE - PRÉVUE POUR DES VITESSES DE COUPE HAUTES ET MOYENNES - PRÉVUE POUR L'USINAGE DE LA FONTE
- TOUGH GRADE FOR MAXIMUM OPERATIONAL SAFETY	- ZÄHE SORTE FÜR HÖCHSTE BETRIEBSSICHERHEIT	- QUALITÉ DE TÉNACITÉ POUR LA PLUS GRANDE SÉCURITÉ DE FONCTIONNEMENT
-MICROGRAIN GRADE WITH HIGH TOUGHNESS -SUITABLE FOR MEDIUM AND LOW CUTTING SPEEDS	-MIKROKORNSORTE MIT HOHER ZÄHIGKET -FÜR MITTEL UND GERINGE SCHNITTGESCHWINDIGKEITEN GEEIGNET	-QUALITÉ DE MICROGRAIN AVEC TENACITÉ ÉLEVÉE -INDIQUÉE POUR LE MOYENNE-FAIBLE VITESSE DE COUPE
- MEDIUM TOUGH INSERT - IDEAL FOR MEDIUM TO HIGH CUTTING SPEEDS - SUITABLE FOR MACHINING ALLOYED AND WEAKLY ALLOYED STEELS	- WENDEPLATTE MIT MITTLERER ZÄHIGKEIT - GEEIGNET FÜR MITTLERE/HOHE SCHNITTGESCHWINDIGKEITEN - GEEIGNET FÜR BEARBEITUNGEN VON LEGIERTEM UND SCHWACH LEGIERTEM STAHL	- PLAQUETTE AVEC TÉNACITÉ MOYENNE - PRÉVUE POUR DES VITESSES DE COUPE HAUTES ET MOYENNES - PRÉVUE POUR L'USINAGE DES ACIERS ALLIÉS ET FAIBLEMENT ALLIÉS
- MEDIUM TOUGH INSERT - IDEAL FOR MEDIUM TO HIGH CUTTING SPEEDS - SUITABLE FOR BOTH LOW-ALLOY AND INOX STEEL	- WENDEPLATTE MIT MITTLERER ZÄHIGKEIT - GEEIGNET FÜR MITTLERE/HOHE SCHNITTGESCHWINDIGKEITEN - GEEIGNET SOWOHL FÜR NIEDERLEGIERTE ALS AUCH FÜR INOX-STÄHLE	- PLAQUETTE AVEC TÉNACITÉ MOYENNE - PRÉVUE POUR DES VITESSES DE COUPE HAUTES ET MOYENNES - INDIQUE POUR L'USINAGE DES ACIERS FAIBLEMENT ALLIÉS ET INOX
- VERY TOUGH GRADE, PARTICULARLY SUITABLE FOR LOW CUTTING SPEED AND FOR VERY TOUGH MATERIALS (E.G FE OR HIGH SPEED LEADED STEEL) - ALSO SUITABLE FOR STAINLESS STEEL AND NON-FERROUS MATERIALS	- SEHR ZÄHE SORTE, BESONDERS FÜR DIE BEARBEITUNG MIT NIEDRIGER SCHNITTGESCHWINDIGKEIT UND FÜR SEHR ZÄHE MATERIALIEN (Z.B. FE ODER BLEIHALTIGEN HOCHGESCHWINDIGKEITSSTAHL) GEEIGNET - AUCH BEI EDELSTAHL UND NICHT EISERNEN MATERIALIEN EINSETZBAR	- DEGRE TRES TENACE PARTICULIEREMENT INDIQUE POUR L'USINAGE A DE FAIBLES VITESSES DE COUPE ET SUR DES MATERIAUX TRES TENACES (PAR EXEMPLE FE OU ACIER A HAUTE VITESSE AU PLOMB). - EMPLOI POSSIBLE MEME SUR ACIER INOX ET MATERIAUX NON FERREUX.
- GOOD IMPACT RESISTANCE FOR ROUGHING OPERATIONS ON STEEL AND STAINLESS STEEL	- GUTE STOSSFESTIGKEIT FÜR DAS SCHRUPPEN VON STÄHLEN UND ROSTFREIEN STÄHLEN	- BONNE RESISTANCE AUX CHOCS POUR L'EBAUCHE D'ACIERS ET ACIERS INOXYDABLES.

HT CERMET

HW METALLO DURO NON RICOPERTO
UNCOATED CARBIDE
UNBESCHICHTETES HARTMETALL
MÉTAL DUR PAS RECOUVERT

HC METALLO DURO RICOPERTO
COATED CARBIDE
BESCHICHTETES HARTMETALL
MÉTAL DUR RECOUVERT

MATERIALE MATERIAL MATERIALIEN MATERIAUX PAG 1199	VDI 3323 GR.	HB HRC Rm	T120	T3610	T7530 NEW	T5320	T5322	T530	T540 NEW	
P ACCIAI STEELS STÄHL ACIER	1	125			100-220			180-350	100-180	100-200
	2	180			100-220			180-320	100-180	100-200
	3	250			100-220			160-300	100-180	100-200
	4	220			100-220			160-300	100-180	100-200
	5	300			100-220			150-280	90-160	100-200
	6	180			110-220	100-180	120-250			
	7-8	250-300			70-170	100-180	70-200			
	9	350			100-210	100-150	100-250			
	10	200			70-180	100-150	70-200			
	11	350			100-230	100-150	100-250			
	12	200			100-180	100-150	100-230			
	13	330			100-200	100-150	100-230			
	M ACCIAI INOX STAINLESS STEELS ROSTFREIER STAHL ACIER INOXYDABLE	14.1	180			100-180	100-140	120-200	70-130	100-160
14.2		230-260			80-150	80-120	100-180	60-100	60-140	
K GHISA CAST IRON GRAUGUSS FONTE GRISE	15	180	60-100	80-220	80-150	80-120				
	16	260	60-100	70-180	80-150	70-150				
	17	160		130-280	80-150	110-250				
	18	250		75-230	80-150	70-180				
	19	130		80-200	80-150	70-150				
	20	230		70-180	80-150	70-140				
N MAT. NON FERROSI NON FERROUS MAT. NICHT-EISENMATERIALIEN MAT. FERREUX	21	60	200-500				200-550	200-550		
	22	100	200-500				200-550	200-550		
	23	75	200-500				200-550	200-550		
	24	90	200-500				200-550	200-550		
	25	130	200-500				200-550	200-550		
	26	110	250-350				200-400	200-400		
	27	90	180-240				200-400	200-400		
	28	100	180-240				200-400	200-400		
	29		50-180							
	30		50-200							
S MAT. DIFFICILI DIFFICULT MATERIAL SCHWERIGE MATERIALIEN MAT. DIFFICILES	31	200			20-60					
	32	280			20-60					
	33	250			20-60					
	34	350			20-60					
	35	320			20-60					
	36	Rm400	40-120		20-60					
	37	Rm1050	40-120		20-60					
H MATERIALI DURI HARD MATERIALS HARTE MATERIALIEN MATERIAUX DURS	38	55HRC								
	39	60HRC								
	40	400								
	41	55HRC								

MATERIALE MATERIAL MATERIALIEN MATÉRIAUX PAG 1199	VDI 3323 GR.	HB HRC Rm												
P ACCIAI STEELS STAHL ACIER	1	125												
	2	180												
	3	250												
	4	220												
	5	300												
	6	180												
	7-8	250-300												
	9	350												
	10	200												
	11	350												
	12	200												
	13	330												
	M ACCIAI INOX STAINLESS STEELS ROSTFREIER STAHL ACIER INOXYDABLE	14.1	180											
14.2		230-260												
K GHISA CAST IRON GRAUGUSS FONTE GRISE	15	180												
	16	260												
	17	160												
	18	250												
	19	130												
	20	230												
N MAT. NON FERROSI NON FERROUS MAT. NICHT-EISEN MATERIALIEN MAT. FERREUX	21	60												
	22	100												
	23	75												
	24	90												
	25	130												
	26	110												
	27	90												
	28	100												
	29													
	30													
S MAT. DIFFICILI DIFFICULT MATERIAL SCHWERIGE MATERIALIEN MAT. DIFCILES	31	200												
	32	280												
	33	250												
	34	350												
	35	320												
	36	Rm400												
	37	Rm1050												
H MATERIALI DURI HARD MATERIALS HARTE MATERIALIEN MATÉRIAUX DURS	38	55HRC												
	39	60HRC												
	40	400												
	41	55HRC												



	DENOMINAZIONI DEGLI INSERTI LAVORAZIONE FORI	Pag. 698
	CATALOGO DISPONIBILITÀ INSERTI	Pag. 699
	COME SCEGLIERE I PARAMETRI DI LAVORO	Pag. 705
	PANORAMICA QUALITÀ LAVORAZIONE FORI	Pag. 707
	IMPIEGO DELLE QUALITÀ LAVORAZIONE FORI	Pag. 708
	VELOCITÀ DI TAGLIO DELLE QUALITÀ LAVORAZIONE FORI	Pag. 714
	CAMPI DI IMPIEGO DEI ROMPIRUCIOLI LAVORAZIONE FORI	Pag. 718

	INSERTS DESIGNATION FOR MACHINING BORES	Pag. 698
	INSERTS STOCK CATALOGUE	Pag. 699
	HOW TO CHOOSE CUTTING DATA	Pag. 705
	GENERAL VIEW MACHINING BORES GRADE	Pag. 707
	APPLICATION MACHINING BORES GRADE	Pag. 708
	CUTTING SPEED MACHINING BORES GRADE	Pag. 714
	FIELDS OF APPLICATION FOR CHIP BREAKERS	Pag. 718

	BEZEICHNUNG DER WENDEPLATTEN ZUM BEARBEITUNG VON BOHRUNGEN	Pag. 698
	WENDEPLATTEN-KATALOG	Pag. 699
	EINSTELLUNG DER SCHNITTDATEN	Pag. 705
	BEARBEITUNG VON BOHRUNGEN-ÜBERSICHT	Pag. 707
	EINSATZ DER BEARBEITUNG VON BOHRUNGEN	Pag. 708
	SCHNITTGESCHWINDIGKEIT BEARBEITUNG VON BOHRUNGEN (VC)	Pag. 714
	EINSATZGEBIETE DER SPANBRECHER	Pag. 718

	DÉNOMINATION DE LES PLAQUETTES POUR USINAGE TROUS	Pag. 698
	CATALOGUE DE DISPONIBILITÉ PLAQUETTES	Pag. 699
	COMMENT CHOISIR LES PARAMETRES DE SERVICE	Pag. 705
	VUE D' ENSEMBLE QUALITÉ USINAGE TROUS	Pag. 707
	UTILISATION DE LES QUALITÉES USINAGE TROUS	Pag. 708
	VITESSE DECOUPE DE LA QUALITÉ DE PLAQUETTES USINAGE TROUS	Pag. 714
	CHAMPS D'USINAGE DE LE BRISE-COPEAUX	Pag. 718

INSERTI PER LAVORAZIONE FORI

INSERTS FOR MACHINING BORES / WENDEPLATTEN ZUR BEARBEITUNG VON BOHRUNGEN
PLAQUETTES POUR USINAGE TROUS / PLAQUITAS PARA TRABAJO DE LOS AGUJEROS



C	N	M	G
1	2	3	4

12	04	08
5	6	7

-	-
8	9

W	5	2	P
10	11	12	13

1 FORMA INSERTO
SHAPE OF INSERT

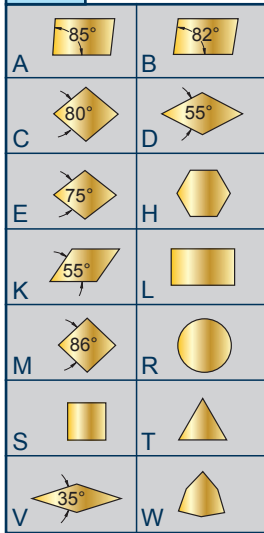

2 SPOGLIA INFER.
RELIEF ANGLE

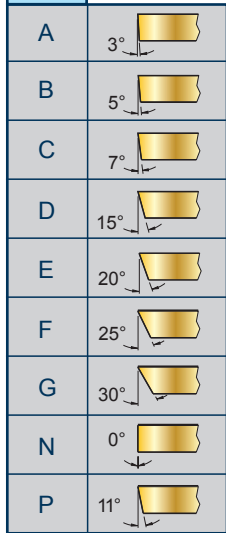

3 TOLLERANZA+/- (mm)
TOLERANCE+/- (mm)

	m	s	d
A	+/-0,005	+/-0,025	+/-0,025
C	+/-0,013	+/-0,025	+/-0,025
E	+/-0,025	+/-0,025	+/-0,025
F	+/-0,005	+/-0,025	+/-0,013
G	+/-0,025	+/-0,05 +/-0,13	+/-0,025
H	+/-0,013	+/-0,025	+/-0,013
J	+/-0,005	+/-0,025	+/-0,05 +/-0,13
K	+/-0,013	+/-0,025	+/-0,05 +/-0,13
L	+/-0,05	+/-0,013	+/-0,025
M	+/-0,08 +/-0,18	+/-0,13	+/-0,05 +/-0,18
N	+/-0,08 +/-0,18	+/-0,025	+/-0,05 +/-0,13
U	+/-0,13 +/-0,38	+/-0,05 +/-0,13	+/-0,08 +/-0,32

4 TIPO INSERTO
TYPE OF INSERT

A	N
B 70°-90°	Q 40°-60°
C 70°-90°	R
F	T 40°-60°
G	U 40°-60°
H 70°-90°	W 40°-60°
J 70°-90°	X SPECIALE SPECIAL
M	

5 LUNGHEZZA TAGLIANTE
CUTTING EDGE LENGTH

Ød CERCHIO INSCRITTO INSCRIBED CIRCLE	A	C	D	E	K	L	M	R	S	T	V	W
3,97												02
4,76										08		02-03
5,56		05								09		
6,00												03
6,35		06	07	06			06	06	11	11		04
6,70	10								07			
7,94				08								05
8,00												
9,45	16											
9,52	15-16	09	11	09	16	15	09		09	16	16	06
10,00								10				06
11,00									11			
11,50						12						
12,00								12				07
12,62						18						
12,70		12	15	12	15-20			12	22			08
15,87		16							15			
19,05		19							19			

6 SPESSORE
THICKNESS

S	mm
01	1,59
T1	1,97
02	2,38
T2	2,78
03	3,18
T3	3,97
04	4,76
05	5,56
06	6,35
07	7,94
09	9,52

7 RAGGIO
RADIUS

MO (mm)	r (mm)
02	r=0,2
04	r=0,4
05	r=0,5
06	r=0,6
08	r=0,8
10	r=1,0
12	r=1,2
16	r=1,6

8

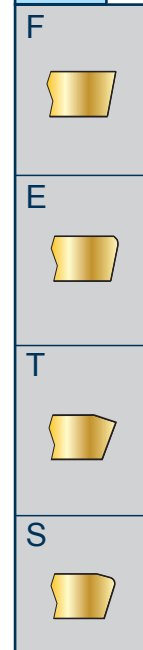

9

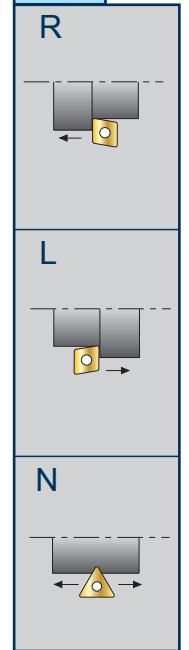

10 LETTERA DI IDENTIF.
IDENTIFICATION LETTER

A	N
C	P
D	R
E	S
H	T
I	U
J	W
K	Y
L	Z
M	

11 CAMPO DI LAVORAZIONE
MACHINING TYPES

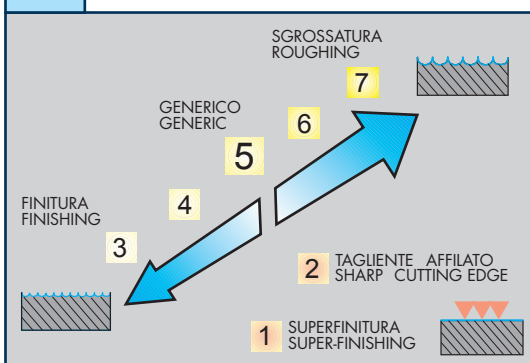

12 PREPARAZIONE TAGLIANTE
CUTTING EDGE PREPARATION

1 =	SPECIFICO PER GHISA SPECIFIC FOR CAST IRON
3 =	SPECIFICO PER ACCIAIO INOX SPECIFIC FOR STAINLESS STEEL
7 =	SPECIFICO PER LEGHE DI ALLUMINIO SPECIFIC FOR ALUMINIUM ALLOYS
9 =	SPECIFICO PER ACCIAIO SPECIFIC FOR STEEL
2 =	
4 =	
5 =	INTERMEDI DI USO GENERIC INTERMEDIATE FOR GENERAL USE
6 =	
8 =	

13

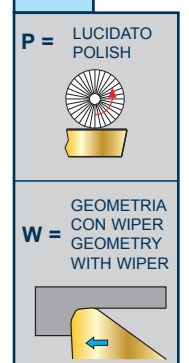

CCET CCGT CCGW CCMT							HT		HW			HC						DP				
	ART.		COD.				l	d	s	d1	r	C4010	DT63	T115	T3310 $\leq mZ$	F2120	F2326 $\leq mZ$	T531	T1215 $\leq mZ$	T1225 $\leq mZ$	D3010	
 .B22	CCET 060202 L .B22		6,5	6,35	2,38	2,8	0,2				■											
	CCET 060204 L .B22		6,5	6,35	2,38	2,8	0,4				■											
	CCET 09T304 L .B22		9,7	9,52	3,97	4,4	0,4				■											
 .F47	CCGT 060202 .F47		6,5	6,35	2,38	2,8	0,2							■								
	CCGT 060204 .F47		6,5	6,35	2,38	2,8	0,4							■								
	CCGT 09T302 .F47		9,7	9,52	3,97	4,4	0,2							■								
	CCGT 09T304 .F47		9,7	9,52	3,97	4,4	0,4							■								
	CCGT 09T308 .F47		9,7	9,52	3,97	4,4	0,8							■								
 .G13	CCGT 060200 .G13		6,5	6,35	2,38	2,8	0,0								■							
	CCGT 060201 .G13		6,5	6,35	2,38	2,8	0,1								■							
	CCGT 09T300 .G13		9,7	9,52	3,97	4,4	0,0								■							
	CCGT 09T301 .G13		9,7	9,52	3,97	4,4	0,1								■							
 .G57P	CCGT 060201 .G57P		6,5	6,35	2,38	2,8	0,1															
	CCGT 060202 .G57P		6,5	6,35	2,38	2,8	0,2															
	CCGT 060204 .G57P		6,5	6,35	2,38	2,8	0,4															
	CCGT 09T302 .G57P		9,7	9,52	3,97	4,4	0,2															
	CCGT 09T304 .G57P		9,7	9,52	3,97	4,4	0,4															
	CCGT 09T308 .G57P		9,7	9,52	3,97	4,4	0,8															
 .X47	CCGW 060202 .X47		6,5	6,35	2,38	2,8	0,2															
	CCGW 060204 .X47		6,5	6,35	2,38	2,8	0,4															
	CCGW 09T302 .X47		9,7	9,52	3,97	4,4	0,2															
	CCGW 09T304 .X47		9,7	9,52	3,97	4,4	0,4															
	CCGW 09T308 .X47		9,7	9,52	3,97	4,4	0,8															
 .F32	CCMT 060202 .F32		6,5	6,35	2,38	2,8	0,2															
	CCMT 060204 .F32		6,5	6,35	2,38	2,8	0,4															
	CCMT 060208 .F32		6,5	6,35	2,38	2,8	0,8															
	CCMT 09T304 .F32		9,7	9,52	3,97	4,4	0,4															
	CCMT 09T308 .F32		9,7	9,52	3,97	4,4	0,8															
 .F33	CCMT 060202 .F33		6,5	6,35	2,38	2,8	0,2															
	CCMT 060204 .F33		6,5	6,35	2,38	2,8	0,4															
	CCMT 09T304 .F33		9,7	9,52	3,97	4,4	0,4															
 .G39	CCMT 060204 .G39		6,5	6,35	2,38	2,8	0,4				■											
	CCMT 09T304 .G39		9,7	9,52	3,97	4,4	0,4				■											
MATERIALE - MATERIAL - MATERIALIEN - MATÉRIAUX											C4010	DT63	T115	T3310 $\leq mZ$	F2120	F2326 $\leq mZ$	T531	T1215 $\leq mZ$	T1225 $\leq mZ$	D3010		
P	ACCIAIO - STEEL - STAHL - ACIER										●	●			○	○	○			●	●	
M	ACCIAIO INOX - STAINLESS STEEL - ROSTFREIER STAHL - ACIER INOXYDABLE										●	●			○	●	●	●			○	
K	GHISA - CAST IRON - GRAUGUSS - FONTE GRISE										○	●	○		○	○				○		
N	LEGHE DI ALLUMINIO - ALUMINIUM ALLOYS - ALUMINIUM-LEGIERUNGEN - ALLIAGES D'ALUMINIUM												●		●	○					●	
S	LEGHE RESISTENTI AL CALORE - HEAT RESISTANT ALLOYS - WÄRMEBESTÄNDIGE LEGIERUNGEN - ALLIAGES RÉSISTANTES À LA CHALEUR												○		○							
H	MATERIALI DURI E TEMPRATI - HARD AND HARDENED MATERIAL - HARTE UND GEHÄRTETE MATERIALIEN - MATERIAUX DURS ET TREMPÉS																					

■ DISPONIBILI - IN STOCK - LIEFERBAR - DISPONIBLES / ■ NEW
● APPLICAZIONE CONSIGLIATA-RECOMMENDED APPLICATION-
EMPFOHLENER EINSATZ - APPLICATION CONSEILLÉE

□ A RICHIESTA - ON REQUEST - AUF ANFRAGE - SUR DEMANDE / □ NEW
○ APPLICAZIONE POSSIBILE - POSSIBLE APPLICATION -
MÖGLICHE ANWENDUNG - APPLICATION POSSIBLE

CCMT CCMX							HT	HW	HC							DP					
							CERMET	NON RIVESTITI CEMENTED CARBIDE GRADES	RIVESTITI COATED GRADES BESCHICHTET RECOUVERTS							PCD					
INSERTI POSITIVI - POSITIVE INSERTS - POSITIVE WENDEPLATTEN - PLAQUÉTTES POSITIVES											F2425	T1126	F2435	T1415	T1425	T3112 ΣMZ	T3121 ΣMZ	T3220	T1435		
ART.	COD.	l	d	s	d1	r															
 .G42	CCMT 060202 .G42	6,5	6,35	2,38	2,8	0,2						■									
	CCMT 060204 .G42	6,5	6,35	2,38	2,8	0,4						■									
	CCMT 09T302 .G42	9,7	9,52	3,97	4,4	0,2						■									
	CCMT 09T304 .G42	9,7	9,52	3,97	4,4	0,4						■									
	CCMT 09T308 .G42	9,7	9,52	3,97	4,4	0,8						■									
 .F51	CCMT 09T304 .F51	9,7	9,52	3,97	4,4	0,4									■	■					
	CCMT 09T308 .F51	9,7	9,52	3,97	4,4	0,8									■	■					
	NEW																				
 .G52	CCMT 060204 .G52	6,5	6,35	2,38	2,8	0,4						■									
	CCMT 060208 .G52	6,5	6,35	2,38	2,8	0,8						■									
	CCMT 09T304 .G52	9,7	9,52	3,97	4,4	0,4						■	■	■	■		■				
	CCMT 09T308 .G52	9,7	9,52	3,97	4,4	0,8						■	■	■	■		■				
 .G32W	CCMX 09T304 .G32W	9,7	9,52	3,97	4,4	0,4									■						
MATERIALE - MATERIAL - MATERIALIEN - MATÉRIAUX											F2425	T1126	F2435	T1415	T1425	T3112 ΣMZ	T3121 ΣMZ	T3220	T1435		
P	ACCIAIO - STEEL - STAHL - ACIER											○	●	○	●	●					
M	ACCIAIO INOX - STAINLESS STEEL - ROSTFREIER STAHL - ACIER INOXYDABLE											●	●	●	○					○	
K	GHISA - CAST IRON - GRAUGUSS - FONTE GRISE											●		○	○	●	●	●			
N	LEGHE DI ALLUMINIO - ALUMINIUM ALLOYS - ALUMINIUM-LEGIERUNGEN - ALLIAGES D'ALUMINIUM																				
S	LEGHE RESISTENTI AL CALORE - HEAT RESISTANT ALLOYS - WÄRMEBESTÄNDIGE LEGIERUNGEN - ALLIAGES RÉISTANTES À LA CHALEUR																				
H	MATERIALI DURI E TEMPRATI - HARD AND HARDENED MATERIAL - HARTE UND GEHÄRTETE MATERIALIEN - MATERIAUX DURS ET TREMPÉS																				

SMU45		TCGT TCGW TCMT		HT		HW			HC						DP											
				CERMET		NON RIVESTITI CEMENTED CARBIDE GRADES			RIVESTITI COATED GRADES BESCHICHTET RECOUVERTS						PCD											
INSERTI POSITIVI - POSITIVE INSERTS - POSITIVE WENDEPLATTEN - PLAQUÉTTES POSITIVES														C4010	T115	T120	T5610	F2425	F2435	T1415	T1425	T3220	F4425	T1435	T540	D3010
ART.	COD.		l	d	s	d1	r	C4010	T115	T120	T5610	F2425	F2435	T1415	T1425	T3220	F4425	T1435	T540	D3010						
.X55	SMU45 10T2 .X55		9,5	6,1	2,83	2,8	-		■		■															
.G39	TCGT 110202 .G39		11,0	6,35	2,38	2,8	0,2	■																		
.G57P	TCGT 110204 .G57P		11,0	6,35	2,38	2,8	0,4		■																	
.X47	TCGW 110202 .X47 / .X37		11,0	6,35	2,38	2,8	0,2																			
	TCGW 110204 .X47 / .X37		11,0	6,35	2,38	2,8	0,4															■				
.X37																										
.G39	TCMT 110204 .G39		11,0	6,35	2,38	2,8	0,4	■																		
.S42	TCMT 110202 .S42		11,0	6,35	2,38	2,8	0,2			■											■					
	TCMT 110204 .S42		11,0	6,35	2,38	2,8	0,4			■												■				
.G52	TCMT 080204 .G52		8,2	4,76	2,38	2,3	0,4														■					
	TCMT 110204 .G52		11,0	6,35	2,38	2,8	0,4					■	■	■	■	■					■					
	TCMT 110208 .G52		11,0	6,35	2,38	2,8	0,8					■	■	■	■	■					■					
MATERIALE - MATERIAL - MATERIALIEN - MATÉRIAUX								C4010	T115	T120	T5610	F2425	F2435	T1415	T1425	T3220	F4425	T1435	T540	D3010						
P	ACCIAIO - STEEL - STAHL - ACIER							●				●	○	○	●	●	○	●		●	●					
M	ACCIAIO INOX - STAINLESS STEEL - ROSTFREIER STAHL - ACIER INOXYDABLE							●		○		●	●		○		●		○	●						
K	GHISA - CAST IRON - GRAUGUSS - FONTE GRISE							○		○	●	●		○	○	●										
N	LEGHE DI ALLUMINIO - ALUMINIUM ALLOYS - ALUMINIUM-LEGIERUNGEN - ALLIAGES D'ALUMINIUM								●	○											○	●				
S	LEGHE RESISTENTI AL CALORE - HEAT RESISTANT ALLOYS - WÄRMEBESTÄNDIGE LEGIERUNGEN - ALLIAGES RÉSISTANTES À LA CHALEUR								○	○											○					
H	MATERIALI DURI E TEMPRATI - HARD AND HARDENED MATERIAL - HARTE UND GEHÄRTETE MATERIALIEN - MATERIAUX DURS ET TREMPÉS																									

XCGT XCNT									HT	HW	HC					DP	
	ART.	COD.	l	d	b°	s	d1	r	CERMET	NON RIVESTITI CEMENTED CARBIDE GRADES	T2330	F7035	T516	F5120 $\leq m/z$	RIVESTITI COATED GRADES BESCHICHTET RECOUVERTS	PCD	
 .N57P	XCGT 040102FR .N57P		4	4,5	88	1,80	2,10	0,2		■							
	XCGT 040104FR .N57P		4	4,5	88	1,80	2,10	0,4		■							
	XCGT 050202FN .N57P		5	5,8	88	2,1	2,25	0,2		■							
	XCGT 050204FN .N57P		5	5,8	88	2,1	2,25	0,4		■							
	XCGT 060202FN .N57P		6	6,5	88	2,38	2,5	0,2		■							
	XCGT 060204FN .N57P		6	6,5	88	2,38	2,5	0,4		■							
	XCGT 070304FN .N57P		7	7,6	88	3,18	2,8	0,4		■							
	XCGT 080304FN .N57P		8	8,5	88	3,18	3,4	0,4		■							
	XCGT 09T304FN .N57P		9	9,6	88	3,97	3,4	0,4		■							
	XCGT 10T304FN .N57P		10	10,6	88	3,97	4,4	0,4		■							
	XCGT 10T308FN .N57P		10	10,6	88	3,97	4,4	0,8		■							
	XCGT 130404FN .N57P		13	13,5	88	4,76	5,3	0,4		■							
	XCGT 130408FN .N57P		13	13,5	88	4,76	5,3	0,8		■							
	XCGT 170508FN .N57P		17	17,5	88	5,56	5,3	0,8		■							
 .N53	XCGT 040102ER .N53		4	4,5	88	1,80	2,10	0,2			■						
	XCGT 040104ER .N53		4	4,5	88	1,80	2,10	0,4			■						
	XCGT 050202EN .N53		5	5,8	88	2,1	2,25	0,2			■						
	XCGT 050204EN .N53		5	5,8	88	2,1	2,25	0,4			■						
	XCGT 060202EN .N53		6	6,5	88	2,38	2,5	0,2			■						
	XCGT 060204EN .N53		6	6,5	88	2,38	2,5	0,4			■						
	XCGT 070304EN .N53		7	7,6	88	3,18	2,8	0,4			■						
	XCGT 080304EN .N53		8	8,5	88	3,18	3,4	0,4			■						
	XCGT 09T304EN .N53		9	9,6	88	3,97	3,4	0,4			■						
	XCGT 10T304EN .N53		10	10,6	88	3,97	4,4	0,4			■						
	XCGT 10T308EN .N53		10	10,6	88	3,97	4,4	0,8			■						
	XCGT 130404EN .N53		13	13,5	88	4,76	5,3	0,4			■						
	XCGT 130408EN .N53		13	13,5	88	4,76	5,3	0,8			■						
	XCGT 170508EN .N53		17	17,5	88	5,56	5,3	0,8			■						
 .N54 .Z54	XCNT 040102ER .N54		4	4,5	88	1,80	2,10	0,2				■	■				
	XCNT 040104ER .N54		4	4,5	88	1,80	2,10	0,4				■	■				
	XCNT 040104EL .Z54		4	4,5	88	1,80	2,10	0,4			■						
	XCNT 050202EN .N54		5	5,8	88	2,1	2,25	0,2				■	■				
	XCNT 050204EN .N54		5	5,8	88	2,1	2,25	0,4				■	■				
	XCNT 060202EN .N54		6	6,5	88	2,38	2,5	0,2				■	■				
	XCNT 060204EN .N54		6	6,5	88	2,38	2,5	0,4				■	■				
	XCNT 070304EN .N54		7	7,6	88	3,18	2,8	0,4				■	■				
	XCNT 080304EN .N54		8	8,5	88	3,18	3,4	0,4				■	■				
	XCNT 09T304EN .N54		9	9,6	88	3,97	3,4	0,4				■	■				
	XCNT 10T304EN .N54		10	10,6	88	3,97	4,4	0,4				■	■				
	XCNT 10T308EN .N54		10	10,6	88	3,97	4,4	0,8				■	■				
	XCNT 130404EN .N54		12,5	13,5	88	4,76	5,3	0,4				■	■				
	XCNT 130408EN .N54		12,5	13,5	88	4,76	5,3	0,8				■	■				
XCNT 170508EN .N54		17	17,5	88	5,56	5,3	0,8				■	■					
MATERIALE - MATERIAL - MATERIALIEN - MATÉRIAUX											N3610		T2330	F7035	T516	F5120 $\leq m/z$	
P	ACCIAIO - STEEL - STAHL - ACIER													●	●		
M	ACCIAIO INOX - STAINLESS STEEL - ROSTFREIER STAHL - ACIER INOXYDABLE												●	●	○		
K	GHISA - CAST IRON - GRAUGUSS - FONTE GRISE												○	●	●		
N	LEGHE DI ALLUMINIO - ALUMINIUM ALLOYS - ALUMINIUM-LEGIERUNGEN - ALLIAGES D'ALUMINIUM									●			○				
S	LEGHE RESISTENTI AL CALORE - HEAT RESISTANT ALLOYS - WÄRMEBESTÄNDIGE LEGIERUNGEN - ALLIAGES RÉSISTANTES À LA CHALEUR												○				
H	MATERIALI DURI E TEMPRATI - HARD AND HARDENED MATERIAL - HARTE UND GEHÄRTETE MATERIALIEN - MATERIAUX DURS ET TREMPÉS																

XCHX..									HT	HW	HC							DP			
									CERMET	NON RIVESTITI CEMENTED CARBIDE GRADES	RIVESTITI COATED GRADES BESCHICHTET RECOUVERTS							PCD			
ART.	COD.	l	d	b°	s	d1	r			N3015				F2430					T1225		
 .F44	XCHX 040102 .F44	4,0	6,35	88	1,59	2,25	0,2							■					■		
	XCHX 040104 .F44	4,0	6,35	88	1,59	2,25	0,4							■					■		
	XCHX 05T102 .F44	5,0	7,938	88	1,98	2,8	0,2							■					■		
	XCHX 05T104 .F44	5,0	7,938	88	1,98	2,8	0,4							■					■		
	XCHX 060202 .F44	5,5	8,73	88	2,38	2,8	0,2							■					■		
	XCHX 060204 .F44	5,5	8,73	88	2,38	2,8	0,4							■					■		
	XCHX 070304 .F44	7,5	12,0	88	3,18	3,4	0,4							■					■		
	XCHX 070308 .F44	7,5	12,0	88	3,18	3,4	0,8							■					■		
	XCHX 090304 .F44	9,0	14,29	88	3,18	4,4	0,4							■					■		
	XCHX 090308 .F44	9,0	14,29	88	3,18	4,4	0,8							■					■		
	XCHX 10T304 .F44	10,0	15,875	88	3,97	5,9	0,4							■					■		
	XCHX 10T308 .F44	10,0	15,875	88	3,97	5,9	0,8							■					■		
	XCHX 130508 .F44	13,0	21,0	88	5,56	7,0	0,8							■					■		
 .F47P	XCHX 040102 .F47P	4,0	6,35	88	1,59	2,25	0,2			■											
	XCHX 040104 .F47P	4,0	6,35	88	1,59	2,25	0,4			■											
	XCHX 05T102 .F47P	5,0	7,938	88	1,98	2,8	0,2			■											
	XCHX 05T104 .F47P	5,0	7,938	88	1,98	2,8	0,4			■											
	XCHX 060202 .F47P	5,5	8,73	88	2,38	2,8	0,2			■											
	XCHX 060204 .F47P	5,5	8,73	88	2,38	2,8	0,4			■											
	XCHX 070304 .F47P	7,5	12,0	88	3,18	3,4	0,4			■											
	XCHX 070308 .F47P	7,5	12,0	88	3,18	3,4	0,8			■											
	XCHX 090304 .F47P	9,0	14,29	88	3,18	4,4	0,4			■											
	XCHX 090308 .F47P	9,0	14,29	88	3,18	4,4	0,8			■											
	XCHX 10T304 .F47P	10,0	15,875	88	3,97	5,9	0,4			■											
	XCHX 10T308 .F47P	10,0	15,875	88	3,97	5,9	0,8			■											
	XCHX 130508 .F47P	13,0	21,0	88	5,56	7,0	0,8			■											
MATERIALE - MATERIAL - MATERIALIEN - MATÉRIAUX										N3015				F2430					T1225		
P	ACCIAIO - STEEL - STAHL - ACIER																			●	
M	ACCIAIO INOX - STAINLESS STEEL - ROSTFREIER STAHL - ACIER INOXYDABLE													●					○		
K	GHISA - CAST IRON - GRAUGUSS - FONTE GRISE																				
N	LEGHE DI ALLUMINIO - ALUMINIUM ALLOYS - ALUMINIUM-LEGIERUNGEN - ALLIAGES D'ALUMINIUM										●										
S	LEGHE RESISTENTI AL CALORE - HEAT RESISTANT ALLOYS - WÄRMEBESTÄNDIGE LEGIERUNGEN - ALLIAGES RÉSISTANTES À LA CHALEUR													○							
H	MATERIALI DURI E TEMPRATI - HARD AND HARDENED MATERIAL - HARTE UND GEHÄRTETE MATERIALIEN - MATERIAUX DURS ET TREMPÉS																				

SCelta VELOCE QUICK PICK

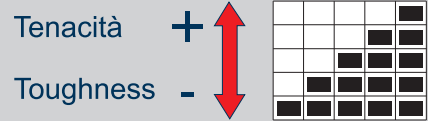

- METODO PER LA SCELTA VELOCE DEL GRADO DI METALLO DURO PIÙ IDONEO. CONTARE IL NUMERO DI RETTANGOLI COLORATI
- METHOD FOR A QUICK CHOICE OF THE MOST SUITABLE SOLID CARBIDE GRADE. COUNT THE NUMBER OF COLORED RECTANGLES
- METHODE ZUR RASCHEN AUSWAHL DER GEEIGNETSTEN HARTMETALLSORTE. DIE ANZAHL DER BUNTEN RECHTECKE ZÄHLEN
- METHODE POUR CHOISIR RAPIDEMENT LE DEGRÉ LE PLUS APPROPRIÉ DU METAL DUR. COMPTEZ LES RECTANGLES EN COULEURS
- METODO PARA LA ELECCION RAPIDA DE EL GRADO MAS ADECUADO DE METAL DURO. CONTAR LOS NUMEROS DE RECTANGULOS COLORADOS

- GRADO MOLTO RESISTENTE ALL'USURA, SOLO PER FINITURA, LAVORAZIONI AD ALTE VELOCITÀ DI TAGLIO E CONDIZIONI MOLTO RIGIDE E STABILI
- GRADE WITH HIGH RESISTANCE TO WEAR; ONLY FOR FINISHING, MACHINING AT HIGH CUTTING SPEEDS, AND VERY RIGID AND STABLE CONDITIONS
- GRADO CON ALTA RESISTENZA ALL'USURA, DISCRETA TENACITÀ PER LAVORAZIONI A VELOCITÀ MEDIO ALTE ED AVANZAMENTI MEDI, IN CONDIZIONI NORMALI
- GRADE WITH HIGH RESISTANCE TO WEAR, GOOD TOUGHNESS, FOR MEDIUM-HIGH MACHINING AND MEDIUM FEED UNDER NORMAL CONDITIONS
- GRADO CON BUONA RESISTENZA ALL'USURA UNITA A BUONA TENACITÀ, PER LAVORAZIONI GENERICHE IN CONDIZIONI NORMALI
- GRADE WITH GOOD RESISTANCE TO WEAR; COMBINED WITH A GOOD DEGREE OF TOUGHNESS, FOR GENERAL MACHINING UNDER NORMAL CONDITIONS
- GRADO CON OTTIMA TENACITÀ PER LAVORAZIONI MEDIO PESANTI O IN CONDIZIONI POCO STABILI
- GRADE WITH EXCELLENTE TOUGHNESS, FOR MEDIUM HEAVY MACHINING OR MACHINING UNDER CONDITIONS OF LOW STABILITY
- GRADO CON ECCEZIONALE TENACITÀ PER LAVORAZIONI PESANTI CON BASSE VELOCITÀ DI TAGLIO, ALTI AVANZAMENTI O IN CONDIZIONI SFAVOREVOLI
- GRADE WITH EXCELLENTE TOUGHNESS, FOR HEAVY MACHINING WITH LOW CUTTING SPEEDS, HIGH FEED, OR UNDER UNFAVORABLE CONDITIONS

GUIDA FACILE EASY GUIDE

CCMT 060204 .G52 T1415

F	M	R	fn = 0,1-0,2 mm
○	●		P Vc = 180-400 m/min
○			M
○			K Vc = 140-430 m/min
			N
			S
			H

SAU QUALITY TOOLS ENGINEERING
CCMT 060204 .G52 - T1415
P05-25 / K20-30

- GUIDA ALL'USO DELL'INSERTO. PRESENTE ANCHE SU OGNI ETICHETTA
- GUIDE FOR THE USE OF THE INSERT. ALSO LISTED ON EACH LABEL
- LEITFADEN ZUR VERWENDUNG DER WENDEPLATTE, AUCH AUF JEDEM AUFKLEBER VORHANDEN
- INSTRUCTIONS POUR L'UTILISATION DE LA PLAQUETTE. SE TROUVANT EGALEMENT SUR CHAQUE ETIQUETTE
- GUIA POR EL UTILIZO DE LA PLAQUITA, PRESENTE TAMBIEN EN CADA ETIQUETA

GR. VDI 3323 MATERIALI MATERIALS Pag. 1199	6	P	= ACCIAIO BASSO LEGATO HB 180	= LOW STEEL ALLOY
	14.1	M	= ACCIAIO INOSSIDABILE AUSTENITICO HB 180	= AUSTENITIC STAINLESS STEEL HB 180
	16	K	= GHISA GRIGIA HB 260	= GRAY CAST IRON HB 260
	21	N	= LEGHE DI ALLUMINIO HB 60	= ALUMINUM ALLOYS HB 60
	33	S	= LEGHE RESISTENTI AL CALORE (INCONEL) HB 250	= HEAT RESISTANT ALLOYS (INCONEL) HB 250
	38	H	= ACCIAIO TEMPRATO HRC 55	= TEMPERED STEEL HRC 55

F	= FINITURA, LAVORAZIONI LEGGERE	= FINISHING, LIGHT MACHINING
M	= LAVORAZIONI MEDIE, IMPIEGO GENERICO	= MEDIUM MACHINING, GENERAL USE
R	= SGROSSATURA, LAVORAZIONI PESANTI	= ROUGHING, HEAVY MACHINING

fn (mm)	= AVANZAMENTO PER TORNITURA	= FEED FOR TURNING
fz (mm/z)	= AVANZAMENTO PER FRESATURA	= FEED FOR MILLING
Vc (m/min)	= VELOCITÀ DI TAGLIO	= CUTTING SPEED
●	= APPLICAZIONE CONSIGLIATA	= RECOMMENDED APPLICATION
○	= APPLICAZIONE POSSIBILE	= POSSIBLE APPLICATION

COME SCEGLIERE I PARAMETRI DI LAVORO
HOW TO CHOOSE CUTTING DATA
EINSTELLUNG DER SCHNITTDATEN
COMMENT CHOISIR LES PARAMETRES DE SERVICE

FASE 1 - PHASE 1

SCelta GR. VDI IN FUNZIONE DEL MATERIALE
 CHOICE OF VDI GR. DEPENDING ON MATERIAL
 WAHL VDI-SORTE JE NACH WERKSTOFF
 CHOIX GR. VDI EN FONCTION DU MATERIEL

Tabella comparativa dei materiali - Materials comparison table
 Material vergleichstabelle - Tableau comparatif des matériaux

UNI	WISTOFF	DIN	SAISI	BS	AFNOR	JIS	kt,1	mc	VDI 323 GR.
ACCIAIO NON LEGATO RICOTTO ANNEALED NOT-ALLOY STEEL									
C < 0,15% 125 HB									
CF 10 SPS 20	1.0722	10 SPS 20	11 L 08	203 M 07	10 PUF 2	SUM22	1330		0,22
CF 9 SMO 28	1.0715	9 SMO 28	1213	203 M 07	S 200	SUM22	1330		0,22
CF 8 SMO 36	1.0706	8 SMO 36	1215	203 M 07	S 200	SUM22	1330		0,22
CF 9 SMO 28	1.0718	9 SMO 28	12 L 13	1015	S 200 P8	SUM22	1330		0,22
CF 9 SMO 36	1.0737	9 SMO 36	12 L 14	1015	S 200 P8	SUM22	1330		0,22
C15 C16	1.0401	C 15	1015	080 M 15	AF 37 C 12, XC 18	SUM22	1330		0,22
C20 C21	1.0402	C 20	1020	080 A 20	AF 43 C 20	SUM22	1330		0,22
C15 C16	1.1141	Ck 15	1015	080 M 15	XC 15, XC 18	SUM22	1330		0,22
ACCIAIO NON LEGATO RICOTTO ANNEALED NOT-ALLOY STEEL									
C 0,15-0,55% 180 HB									
C 35	1.0455	C 35	1035	150 M 38	20 M 5	SUM22	1330		0,22
C 45	1.0459	C 45	1045	150 M 38	20 M 5	SUM22	1330		0,22
C 36	1.0458	C 36	1035	150 M 38	20 M 5	SUM22	1330		0,22
C 53	1.0457	C 53	1045	150 M 38	20 M 5	SUM22	1330		0,22
ACCIAIO NON LEGATO RICOTTO ANNEALED NOT-ALLOY STEEL									
C 0,15-0,55% 250 HB									
C 38 KU	1.1545	C 38 KU	W 110	150 M 38	20 M 5	SK3	1600	0,24	
C 55	1.0535	C 55	1055	150 M 38	20 M 5	SK2	1600	0,24	
C 60	1.0501	C 60	1060	150 M 38	20 M 5	SK2	1600	0,24	
C 60	1.1274	Ck 60	1060	150 M 38	20 M 5	SUM4	1600	0,24	
C 60	1.1203	Ck 60	1060	150 M 38	20 M 5	SK2	1600	0,24	
C 60	1.1274	Ck 60	1060	150 M 38	20 M 5	SK2	1600	0,24	
C 60	1.5710	38 NiCr 6	3135	150 M 38	20 M 5	SK2	1600	0,24	
C 60	1.5120	38 NiCr 4	3135	150 M 38	20 M 5	SK2	1600	0,24	
ACCIAIO NON LEGATO RICOTTO ANNEALED NOT-ALLOY STEEL									
C > 0,55% 300 HB									
C 38 KU	1.1545	C 105 W1	W 110	150 M 38	20 M 5	SK3	1700	0,24	
C 60	1.1683	C 125 W	W 112	150 M 38	20 M 5	SK2	1700	0,24	
C 60	1.0505	C 60	1060	150 M 38	20 M 5	SK2	1700	0,24	
C 60	1.0501	C 60	1060	150 M 38	20 M 5	SK2	1700	0,24	
C 60	1.1274	Ck 60	1060	150 M 38	20 M 5	SUM4	1700	0,24	
C 60	1.1203	Ck 60	1060	150 M 38	20 M 5	SK2	1700	0,24	
C 60	1.1274	Ck 60	1060	150 M 38	20 M 5	SK2	1700	0,24	
C 60	1.5710	38 NiCr 6	3135	150 M 38	20 M 5	SK2	1700	0,24	
C 60	1.5120	38 NiCr 4	3135	150 M 38	20 M 5	SK2	1700	0,24	
ACCIAIO DEBOLMENTE LEGATO RICOTTO ANNEALED LOW ALLOY STEEL									
180 HB									
107 WC1 5	1.2419	100C 6	L 3	BL 3	105 WC 13	SK32-2K53	1700	0,24	
14 CrAl 4 5	1.7380	12 CrAl 9 10	A 182-F22	1501-822 G2-11	10 CD 9 10		1700	0,24	
14 Ni 6	1.7715	14 NiCr 9 10	A 182-F11	1501-822 G2-27	15 CD 3 5		1700	0,24	
16 NiCr 11	1.5732	14 NiCr 10	3415	832 M 13	14 NC 11	SK415H	1700	0,24	
16 NiCr 11	1.5732	14 NiCr 14	3110/3014	832 M 13	12 CD 15	SK415H	1700	0,24	
16 NiCr 11	1.6557	14 NiCrMo 34	3015	832 M 13	12 CD 3	SK415H	1700	0,24	
16 NiCr 11	1.7015	15 Cr 3	3015	832 M 13	12 CD 3	SK415H	1700	0,24	

FASE 2 - PHASE 2

SCelta INSERTO IN FUNZIONE DEL MATERIALE
 CHOICE OF INSERT DEPENDING ON MATERIAL
 WAHL DER WENDEPLATTE JE NACH WERKSTOFF
 CHOIX PLAQUETTE EN FONCTION DU MATERIEL

Lavorazione fori - Machining bores - Bearbeitung von Bohrungen
 Usinage trous - Trabajo de los agujeros

CCMT	CCMT	CCMT	CCMT	CCMT	CCMT	CCMT	CCMT	CCMT	CCMT
CCMT 060204	CCMT 060208	CCMT 09T304	CCMT 09T308	CCMT 09T304	CCMT 09T308	CCMT 09T304	CCMT 09T308	CCMT 09T304	CCMT 09T308
6.5	6.35	2.38	2.8	9.4	6.5	6.35	2.38	2.8	9.4
9.7	9.52	3.97	4.4	0.4	9.7	9.52	3.97	4.4	0.8
6.5	6.35	2.38	2.8	0.2	6.5	6.35	2.38	2.8	0.4
9.7	9.52	3.97	4.4	0.4	9.7	9.52	3.97	4.4	0.8
6.5	6.35	2.38	2.8	0.0	6.5	6.35	2.38	2.8	0.1
9.7	9.52	3.97	4.4	0.1	9.7	9.52	3.97	4.4	0.2
6.5	6.35	2.38	2.8	0.1	6.5	6.35	2.38	2.8	0.2
9.7	9.52	3.97	4.4	0.2	9.7	9.52	3.97	4.4	0.4
6.5	6.35	2.38	2.8	0.1	6.5	6.35	2.38	2.8	0.2
9.7	9.52	3.97	4.4	0.2	9.7	9.52	3.97	4.4	0.4
6.5	6.35	2.38	2.8	0.1	6.5	6.35	2.38	2.8	0.2
9.7	9.52	3.97	4.4	0.2	9.7	9.52	3.97	4.4	0.4
6.5	6.35	2.38	2.8	0.1	6.5	6.35	2.38	2.8	0.2
9.7	9.52	3.97	4.4	0.2	9.7	9.52	3.97	4.4	0.4
6.5	6.35	2.38	2.8	0.1	6.5	6.35	2.38	2.8	0.2
9.7	9.52	3.97	4.4	0.2	9.7	9.52	3.97	4.4	0.4

FASE 3 - PHASE 3

SCelta dell'Avanzamento
 CHOICE OF FEED
 EINSTELLUNG DES VORSCHUBS
 CHOIX DE L'AVANCEMENT

SAU technical manual page 661. The page contains several charts for selecting feed rates (v_f) in mm/min based on material hardness (HRC) and tool grades. Three magnifying glasses are overlaid on the page:

- The first magnifying glass highlights the material grade **G52** in the first chart.
- The second magnifying glass highlights the material grade **G57P** in the second chart.
- The third magnifying glass highlights the tool grade **T1415** in the third chart.

FASE 4 - PHASE 4

SCelta di VC in funzione del GR. VDI
 CHOICE OF VC DEPENDING ON VDI GR.
 WAHL VC JE NACH WERKSTOFF
 CHOIX DE VC EN FONCTION DU GR. VDI

SAU technical manual page 659. The page shows a table for selecting cutting speed (V_C) in m/min based on material hardness (HRC) and tool grades. A magnifying glass highlights the tool grade **T1415** in the table.

Material	VDI 3323 GR	HB HRC	T1415	T1435	T5320	T1225	T2330	T540	D3010	
P	1	125	220-400	170-240	200-300	170-190	200-350	170-250	180-230	
	2	180	220-400	170-240	180-280	170-190	170-330	150-200	170-190	
	3	250	220-400	170-240	170-190	120-300	100-170	100-170	130-190	
	4	220	220-400	170-240	170-190	100-250	80-140	100-250	100-160	
	5	300	220-400	170-240	170-190	100-250	100-160	100-160	100-160	
M	10	200	180-320	130-210	120-200	70-200	100-160	100-160	70-130	
	11	350	180-320	130-210	140-180	100-200	80-170	100-160	80-150	
	12	200	200-320	130-220	130-180	140-180	100-230	120-180	140-180	
	13	330	200-320	130-220	140	140-200	100-230	80-140	110-180	
	14.1	180		100-210	100-190	100-200	100-130	100-180	110-180	
	14.2	230-280	70-100	70-100	80-150	80-150	80-130	80-140	80-150	
	K	15	180	140-370	130-210	130-210	130-210	130-210	130-210	130-210
		16	280	140-370	130-210	130-210	130-210	130-210	130-210	130-210
		17	160	190-430	120-240	120-240	120-240	120-240	120-240	120-240
		18	250	190-430	120-240	120-240	120-240	120-240	120-240	120-240
19		130	180-520	150-250	150-250	150-250	150-250	150-250	150-250	
20		230	180-520	150-250	150-250	150-250	150-250	150-250	150-250	
N		21	60							300-650
		22	100							300-650
	23	75							200-650	
	24	90							200-650	
	25	130							180-500	
	26	110							180-350	
	27	90							180-350	
	28	100							200-650	
	29								300-650	
	30								300-650	
S	31	200		20-40	20-40				20-40	
	32	280		20-40	15-35				15-35	
	33	250		20-40	10-30				5-25	
	34	350		10-30	5-15				4-15	
	35	320		10-30	5-15				4-15	
	36	400		10-30	80-130				80-130	
	37	1050		20-60	20-40				15-35	
H	38	55Hrc								
	39	60Hrc								
	40	400								
	41	55Hrc								

DIN ISO 513	P ACCIAI STEELS STAHL ACIERS					M ACCIAI INOSSIDABILI STAINLESS STEELS ROSTFREIER STAHL ACIER INOXYDABLE				K GHISE CAST IRON GRAUGUSS FONTE GRISE					N NON FERROSI NONFERROUS NICHTEISENMA PAS FERREUX				S MAT.DIFFICILI DIFFICULT MATERIAL SCHWIERIGE MATERIILIEN MAT.DIFICILES					H MATERIALI DURI HARD MATERIALS HARTE MATERIILIEN MATERIAUX DURS			
	01	10	20	30	40	50	10	20	30	40	01	10	20	30	40	01	10	20	30	01	10	20	30	40	01	10	20
HT	C4010 DT63					C4010 DT63				C4010 DT63																	
HW						T120				T115 T120					T115 N3610 N3015				T115								
HC	T5610 T1215 T1415 T3220 F5120 T1225 T1425 F2425 F4425 T1126 F2326 T531 T1435 F2435 F7035 T540					F2120 T1225 T1425 F2425 F4425 T1126 F2326 F2430 T2330 T531 T1435 F2435 F7035 T540				T5610 T3112 T1215 T1415 T516 F2120 T3121 T3220 F5120 T1425 T1126					T3310 NEW				NEW								
DP															D3010												
TENACITÀ - TOUGHNESS - ZÄHIGKEIT - TÉNACITÉ																											
RESISTENZA ALL'USURA - RESISTANCE TO WEAR - VERSCHLEISSFESTIGKEIT - RÉSISTANCE À L'USURE																											
AVANZAMENTO - FEED - VORSCHUB - AVANCE																											
VELOCITÀ - SPEED - GESCHWINDIGKEIT - VITESSE																											
HT	CERMET					HW				HC					DP												
					METALLO DURO NON RICOPERTO UNCOATED CARBIDE UNBESCHICHTETES HARTMETALL MÉTAL DUR PAS RECOUVERT				METALLO DURO RICOPERTO COATED CARBIDE BESCHICHTETES HARTMETALL MÉTAL DUR RECOUVERT					DIAMANTE POLICRISTALLINO (PCD) POLYCRYSTALLINE DIAMOND (PCD) POLYKRISTALLINER DIAMANT (PCD) DIAMANT POLYCRISTALLIN (PCD)													

SAU	DIN ISO 513	MATERIALE - MATERIAL MATERIALIEN - MATÉRIAUX PAG. 1199						QUICK PICK PAG. 704	 Tenacità + Toughness -		 INDICAZIONI - USO
		P	M	K	N	S	H				
		ACCIAI STEELS STAHL ACIER	ACCIAI INOX STAINLESS STEELS ROSTFREIER STAHL ACIER INOXYDABLE	GHISA CAST IRON GRAUGUSS FONTE GRISE	MAT. NON FERROSI NON FERROUS MAT. NICH-EISENMATERIALIEN MAT. FERREUX	MAT. DIFFICILI DIFFICULT MATERIAL SCHWERGE MATERIALIEN MAT. DIFICILES	MATERIALI DURI HARD MATERIALS HARTE MATERIALIEN MATÉRIAUX DURS				
C4010	HT	P10-20 M05-15 K05-15	●	●	○				○ ●	- QUALITÀ UNIVERSALE - ALTA RESISTENZA AL CALORE E ALL'USURA, BUONA TENACITÀ - INDICATO PER LE ALTE VELOCITÀ DI TAGLIO	
DT63	HT	P05-25 M05-25 K05-25	●	●	●				○ ●	- QUALITÀ MICROGRANO MOLTO RESISTENTE ALLA ROTTURA ED ALL'USURA - INDICATO PER MEDIO-ALTE VELOCITÀ DI TAGLIO IN FINITURA.	
T115	HW	K10-25 N10-20 S10-20			○	●	○		○ ●	- QUALITÀ MICROGRANO CON BUONA RESISTENZA ALL'USURA ELEVATA STABILITÀ DEL FILO TAGLIANTE, BASSA TENDENZA ALL'INCOLLAMENTO - INDICATO PER MEDIO-BASSE VELOCITÀ DI TAGLIO SU GHISA GRIGIA E ALTE PER MATERIALI NON FERROSI.	
N3610	HW	N10-20				●			● ●	- GRADO PER LA LAVORAZIONE DELLE LEGHE DI ALLUMINIO	
N3015	HW	N05-15				●			●	- QUALITÀ PER LAVORAZIONI DI MATERIALI NON FERROSI COME ALLUMINIO E RAME	
T120	HW	M10-20 K10-25		○	●	●			○ ●	- QUALITÀ MICROGRANO CON BUONA TENACITÀ - INDICATO PER MEDIO-BASSE VELOCITÀ DI TAGLIO E ALTI AVANZAMENTI. PER ASPORTAZIONI MEDIE IN SGROSSATURA	
T3310 NEW	HC CVD	N05-20	○	○	○	●			○ ●	- QUALITÀ MICROGRANO CON ALTA RESISTENZA ALL'USURA - INDICATO PER MEDIE VELOCITÀ DI TAGLIO IL SUO RIVESTIMENTO PERMETTE DI GARANTIRE OTTIME FINITURE SU MATERIALI ISO M-S -OTTIMA APPLICAZIONE SU FINITURE DI TUTTI GLI ALTRI MATERIALI	
T5610	HC CVD	P05-20 K05-20	●		●				●	- ALTA TENACITÀ, BUONA RESISTENZA ALL'USURA E ALLO SHOCK TERMICO - INDICATO PER MEDIO-ALTE VELOCITÀ DI TAGLIO NELLA LAVORAZIONE DELL'ACCIAIO E MEDIE PER LAVORAZIONI PROBLEMATICHE DI GHISA	
F2120	HC PVD	M15-25 K15-25		●	○	○	○		● ○	- QUALITÀ SPECIFICA PER LA LAVORAZIONE DEGLI ACCIAI INOX, PARTICOLARMENTE ADATTO ALLE LAVORAZIONI DI SUPER FINITURA - PUÒ ESSERE IMPIEGATO NELLE LAVORAZIONI DI GHISA, ALLUMINIO E LEGHE RESISTENTI AL CALORE	
F2425	HC PVD	P30-40 M15-35	○	●					○ ●	- SUBSTRATO DI CARBURO APPPOSITAMENTE SVI- LUPPATO, RIVESTIMENTO IN PVD INNOVATIVO. - QUALITÀ CON UN'ECCELLENTI ROBUSTEZZA SENZA PREGIUDICARE LA DUREZZA A CALDO E LA RESISTENZA ALL'USURA SIA A BASSE CHE AD ALTE VELOCITÀ DI TAGLIO	

● APPLICAZIONE CONSIGLIATA
RECOMMENDED APPLICATION
EMPFOHLENER EINSATZ
APPLICATION CONSEILLÉE

○ APPLICAZIONE POSSIBILE
POSSIBLE APPLICATION
MÖGLICHE ANWENDUNG
APPLICATION POSSIBLE

● APPLICAZIONE CONSIGLIATA
RECOMMENDED APPLICATION
EMPFOHLENER EINSATZ
APPLICATION CONSEILLÉE

○ APPLICAZIONE POSSIBILE
POSSIBLE APPLICATION
MÖGLICHE ANWENDUNG
APPLICATION POSSIBLE

 INDICATIONS - USE	 GEBRAUCHSANWEISUNGEN	 INDICATION - USAGE
<ul style="list-style-type: none"> - UNIVERSAL GRADE - HIGH HEAT AND WEAR RESISTANCE, GOOD TOUGHNESS - SUITABLE FOR HIGH CUTTING SPEEDS 	<ul style="list-style-type: none"> - UNIVERSALSORTE - HOHE HITZE- UND VERSCHLEISSBESTÄNDIGKEIT, GUTE ZÄHIGKEIT - FÜR HOHE SCHNITTGESCHWINDIGKEITEN GEEIGNET 	<ul style="list-style-type: none"> - QUALITE UNIVERSELLE - HAUTE RESISTANCE A LA CHALEUR ET A L'USURE, BONNE TENACITE - INDIQUE POUR LES HAUTES VITESSES DE COUPE
<ul style="list-style-type: none"> - MICROGRAIN GRADE WITH VERY HIGH ULTIMATE STRENGTH AND RESISTANCE TO WEAR - SUITABLE FOR MEDIUM-HIGH CUTTING SPEEDS FOR FINISHING 	<ul style="list-style-type: none"> - MIKROKORNSORTE MIT SEHR HOHER BRUCH- UND VERSCHLEISSFESTIGKEIT - FÜR HOHE SCHNITTGESCHWINDIGKEITEN BEIM SCHLICHTEN GEEIGNET 	<ul style="list-style-type: none"> - QUALITÉ DE MICROGRAIN TRÈS RÉSIDANT À LA RUPTURE ET À L'USURE - INDIQUÉE POUR HAUTE VITESSE DE COUPE EN FINISSAGE
<ul style="list-style-type: none"> - MICROGRAIN GRADE WITH GOOD RESISTANCE TO WEAR, HIGH STABILITY OF THE CUTTING EDGE, LOW TENDENCY TO STICKING - SUITABLE FOR MEDIUM CUTTING SPEEDS ON GRAY IRON AND HIGH CUTTING SPEEDS AND NONFERROUS MATERIALS. 	<ul style="list-style-type: none"> - MIKROKORNSORTE MIT HOHER VERSCHLEISSFESTIGKEIT, STABILITÄT DER SCHNEIDE, NIEDRIGER NEIGUNG ZUR VERKLEBUNG - FÜR MITTEL-NIEDRIGE SCHNITTGESCHWINDIGKEITEN BEI GRAUGUSS UND NE-MATERIALIEN 	<ul style="list-style-type: none"> - QUALITE MICRO-GRAIN AVEC BONNE RESISTANCE A L'USURE, STABILITE ELEVEE DU TRANCHANT, BASSE TENDANCE AU ENCOLLAGE - INDIQUÉE POUR MOYENNE-FAIBLE VITESSE DE COUPE SUR FONTE GRISE ET MATERIAL NON FERROUX
<ul style="list-style-type: none"> - GRADE FOR THE MACHINING OF ALUMINIUM 	<ul style="list-style-type: none"> - SORTE FÜR DIE BEARBEITUNG VON ALUMINIUM 	<ul style="list-style-type: none"> - NUANCE POUR L'USINAGE DE L'ALUMINIUM
<ul style="list-style-type: none"> - DEGREE FOR NON-FERROUS MATERIALS LIKE ALUMINIUM AND COPPER 	<ul style="list-style-type: none"> - SORTE FÜR NICHT-EISENMATERIALIEN WIE ALUMINIUM UND KUPFER 	<ul style="list-style-type: none"> - QUALITE POUR DES USINAGES DE MATERIAUX NON FERREUX TELS QUE L'ALUMINIUM ET LE CUIVRE
<ul style="list-style-type: none"> - MICROGRAIN GRADE WITH GOOD TOUGHNESS - SUITABLE FOR MEDIUM CUTTING SPEEDS AND HIGH FEED FOR ROUGHING WITH MEDIUM REMOVAL OF MATERIAL 	<ul style="list-style-type: none"> - MIKROKORN SORTE MIT GUTER ZÄHIGKEIT - FÜR MITTEL-NIEDRIGE SCHNITTGESCHWINDIGKEITEN GROSSE VORSCHÜBE FÜR MITTLERE ZERSPANNUNG BEIM SCHRUPPEN GEEIGNET 	<ul style="list-style-type: none"> - QUALITÉ DE MICROGRAIN AVEC BONNE TENACITE - INDIQUÉE POUR MOYENNE-FAIBLE VITESSE DE COUPE ET HAUTE DÉPLACEMENT POUR MOYEN EMPORTATION EN ÉBAUCHAGE
<ul style="list-style-type: none"> - MICROGRAIN GRADE WITH HIGH RESISTANCE TO WEAR - SUITABLE FOR MEDIUM CUTTING SPEEDS. ITS COATING ALLOWS FOR EXCELLENT FINISHES ON ISO M-S MATERIALS - EXCELLENT FOR FINISHING APPLICATIONS ON ALL OTHER MATERIALS 	<ul style="list-style-type: none"> - MIKROKORN-SORTE MIT HOHER VERSCHLEISSFESTIGKEIT - GEEIGNET FÜR MITTLERE SCHNITTGESCHWINDIGKEITEN. HERRVORRAGENDE OBERFLÄCHENGÜTE AUF ISO - M-S-MATERIALIEN DANK DER BESONDEREN BESCHICHTUNG - HERRVORRAGEND ZUM SCHLICHTEN AUF ALLEN ANDEREN MATERIALIEN 	<ul style="list-style-type: none"> - QUALITÉ MICROGRAIN AVEC HAUTE RÉSIDANCE À L'USURE - INDIQUÉ POUR DES VITESSES DE DÉCOUPE MOYENNES, SON REVÊTEMENT PERMET DE GARANTIR DES FINITIONS PARFAITES SUR DES MATÉRIAUX ISO M-S - APPLICATION PARFAITE SUR LES FINITIONS DE TOUS LES AUTRES MATÉRIAUX
<ul style="list-style-type: none"> - HIGH TOUGHNESS, GOOD RESISTANCE TO WEAR AND TO THERMAL SHOCK - SUITABLE FOR MEDIUM-HIGH CUTTING SPEEDS ON STEEL AND MEDIUM CUTTING SPEED FOR DIFFICULT IRON OPERATIONS 	<ul style="list-style-type: none"> - HOHE ZÄHIGKEIT, GUTE VERSCHLEISSFESTIGKEIT UND TEMPERATURWECHSELBESTÄNDIGKEIT - GEEIGNET FÜR MITTEL-HOHE SCHNITTGESCHWINDIGKEITEN BEI STAHL UND FÜR MITTLERE SCHNITTGESCHWINDIGKEITEN BEI GÜSEISEN 	<ul style="list-style-type: none"> - HAUTE TENACITÉ, BONNE RÉSIDANCE À L'USURE ET AU SHOCK THERMIQUE - INDIQUÉE POUR DES HAUTE-MOYENNE VITESSE DE COUPE DANS LES USINAGES DE L'ACIER ET MOYENNE POUR LES USINAGES PROBLÉMATIQUES DE LA FONTE
<ul style="list-style-type: none"> - SPECIFIC GRADE FOR INOX STEEL, PARTICULARLY SUITABLE FOR SUPER-FINISHING - IT CAN BE USED FOR CAST IRON, ALUMINIUM AND HEAT-RESISTANT ALLOYS 	<ul style="list-style-type: none"> - SPEZIALSORTE FÜR INOX-STAHL, BESONDERS ZUM FEIN-SCHLICHTEN GEEIGNET - EINSETZBAR FÜR GUSS, ALUMINIUM UND HITZEBESTÄNDIGE LEGIERUNGEN 	<ul style="list-style-type: none"> - QUALITE SPECIFIQUE POUR L'USINAGE DES ACIERS INOX, SPECIALEMENT PREVUE POUR LES USINAGES DE SUPER FINITION - PEUT ETRE EMPLOYEE DANS LES USINAGES DE FONTE, ALUMINIUM ET ALLIAGES RESISTANTS A LA CHALEUR
<ul style="list-style-type: none"> - SPECIALLY DEVELOPED CARBIDE SUBSTRATE, INNOVATIVE PVD COATING - GRADE WITH EXCELLENT TOUGHNESS WHICH DOES NOT AFFECT RED HARDNESS AND WEAR RESISTANCE, AT BOTH LOW AND HIGH CUTTING SPEEDS 	<ul style="list-style-type: none"> - SPEZIELL ENTWICKELTES KARBIDSUBSTRAT, INNOVATIVE PVD-BESCHICHTUNG. - SORTE MIT HERRVORRAGENDER ROBUSTHEIT BEI UNVERÄNDERTER WARMHÄRTE UND VERSCHLEISSBESTÄNDIGKEIT SOWOHL MIT NIEDRIGEN ALS AUCH MIT HOHEN SCHNITTGESCHWINDIGKEITEN 	<ul style="list-style-type: none"> - SUBSTRAT DE CARBURE SPÉCIALEMENT DÉVELOPPÉ, REVÊTEMENT EN PVD INNOVANT. - QUALITÉ AVEC UNE ROBUSTESSE EXCELLENTE SANS PORTER PRÉJUDICE À LA DURETÉ À CHAUD ET À LA RÉSIDANCE À L'USURE À BASSES VITESSES COMME À HAUTES VITESSES DE COUPE

HT CERMET

HW

METALLO DURO NON RICOPERTO
UNCOATED CARBIDE
UNBESCHICHTETES HARTMETALL
MÉTAL DUR PAS RECOUVERT

HC

METALLO DURO RICOPERTO
COATED CARBIDE
BESCHICHTETES HARTMETALL
MÉTAL DUR RECOUVERT

DP

DIAMANTE POLICRISTALLINO (PCD)
POLYCRYSTALLINE DIAMOND (PCD)
POLYKRISTALLINER DIAMANT (PCD)
DIAMANT POLYCRISTALLIN (PCD)

SAU	DIN ISO 513	MATERIALE - MATERIAL MATERIALIEN - MATÉRIAUX PAG. 1199						QUICK PICK PAG. 704	 INDICAZIONI - USO
		P	M	K	N	S	H		
		ACCIAI STEELS STAHL ACIER	ACCIAI INOX STAINLESS STEELS ROSTFREIER STAHL ACIER INOXYDABLE	GHISA CAST IRON GRAUGUSS FONTE GRISE	MATTONI FERROSI NON FERROUS MAT. NICHT-EISENMATERIALIEN MAT. FERREUX	MAT. DIFFICILI DIFFICULT MATERIAL SCHWERIGE MATERIALIEN MAT. DIFCILES	MATERIALI DURI HARD MATERIALS HARTE MATERIALIEN MATÉRIAUX DURS		
T1126	HC	P15-35	●	●	●			 Tenacità + Toughness -	 - SUBSTRATO MIGLIORATO CON BUONA RESISTENZA ALL'USURA E ALL'ABRASIONE - ADATTO PERE LAVORAZIONI SENZA L'AUSILIO DEL LUBROREFRIGERANTE.
	CVD	M10-25 K25-35							
F2326 NEW	HC	P15-30	○	●			 - QUALITA' MICR OGRANO CON ALTA RESISTENZA ALL' USURA E BUONA TENACITA' - OTTIMA APPLICAZIONE PER LAVORI DI FINITURA SU ISO M-S	 - GRADO PER LA LAVORAZIONE DELL'ACCIAIO INOX	
	PVD	M15-30							
T2330	HC	M30-40		●			 - SUBSTRATO DI CARBURO APPOSITAMENTE SVILUPPATO - RIVESTIMENTO IN PVD INNOVATIVO. FORNISCE UN'ECCELLENTI ROBUSTEZZA E OTTIMA TENACITÀ SENZA PREGIUDICARE LA DUREZZA A CALDO SIA A BASSE CHE AD ALTE VELOCITÀ DI TAGLIO	 - INSERTO MOLTO TENACE IDEALE PER LAVORAZIONI SU ACCIAI E INOX. - PUO' LAVORARE UN'AMPIA GAMMA DI MATERIALI	
	CVD								
F2435	HC	P35-45	○	●			 - ALTA RESISTENZA ALL'USURA, ADATTO PER LAVORAZIONI DI SPIANATURA IN CONDIZIONI STABILI	 - GRADO INSERTO IDEALE PER LA PRODUZIONE AD ALTO VOLUME - BUONA RESISTENZA AL CALORE CHE LO RENDE PERFETTAMENTE ADATTO PER LA LAVORAZIONE A SECCO ANCHE AD ALTE VELOCITÀ DI TAGLIO	
	PVD	M25-45							
F7035	HC	P30-45	●	●	○	○	 - ALTA RESISTENZA ALL' USURA E BUONA TENACITÀ - INDICATO PER MEDIO-ALTE VELOCITÀ DI TAGLIO IN FINITURA E SGROSSATURA PREVALENTEMENTE SU GHISA GRIGIA	 - GRADO DA TORNITURA PER LA LAVORAZIONE DELLA GHISA GRIGIA E SFEROIDALE	
	PVD	M30-40							
T3112 NEW	HC	K05-20			●		 - INSERTO CON MEDIA TENACITÀ - INDICATO PER MEDIE ALTE VELOCITÀ DI TAGLIO - ADATTO PER LA LAVORAZIONE DEGLI ACCIAI LEGATI E DEBOLMENTE LEGATI	 - ALTA RESISTENZA ALL' USURA E BUONA TENACITÀ - INDICATO PER MEDIO-ALTE VELOCITÀ DI TAGLIO IN FINITURA E SGROSSATURA PREVALENTEMENTE SU GHISA GRIGIA	
	CVD								
T1415	HC	P05-25	●		○		 - ALTA RESISTENZA ALL' USURA E BUONA TENACITÀ - INDICATO PER MEDIO-ALTE VELOCITÀ DI TAGLIO IN FINITURA E SGROSSATURA PREVALENTEMENTE SU GHISA GRIGIA	 - GRADO DA TORNITURA PER LA LAVORAZIONE DELLA GHISA GRIGIA E SFEROIDALE	
	CVD	K10-35							
T516	HC	K05-25			●		 - INSERTO CON MEDIA TENACITÀ - INDICATO PER MEDIE ALTE VELOCITÀ DI TAGLIO - ADATTO PER LA LAVORAZIONE DEGLI ACCIAI LEGATI E DEBOLMENTE LEGATI	 - ALTA RESISTENZA ALL' USURA E BUONA TENACITÀ - INDICATO PER MEDIO-ALTE VELOCITÀ DI TAGLIO IN FINITURA E SGROSSATURA PREVALENTEMENTE SU GHISA GRIGIA	
	PVD								
T3220	HC	P01-20	○		●		 - INSERTO CON MEDIA TENACITÀ - INDICATO PER MEDIE ALTE VELOCITÀ DI TAGLIO - ADATTO PER LA LAVORAZIONE DEGLI ACCIAI LEGATI E DEBOLMENTE LEGATI	 - ALTA RESISTENZA ALL' USURA E BUONA TENACITÀ - INDICATO PER MEDIO-ALTE VELOCITÀ DI TAGLIO IN FINITURA E SGROSSATURA PREVALENTEMENTE SU GHISA GRIGIA	
	CVD	K10-30							
F5120 NEW	HC	P10-30	●	○	●		 - INSERTO CON MEDIA TENACITÀ - INDICATO PER MEDIE ALTE VELOCITÀ DI TAGLIO - ADATTO PER LA LAVORAZIONE DEGLI ACCIAI LEGATI E DEBOLMENTE LEGATI	 - ALTA RESISTENZA ALL' USURA E BUONA TENACITÀ - INDICATO PER MEDIO-ALTE VELOCITÀ DI TAGLIO IN FINITURA E SGROSSATURA PREVALENTEMENTE SU GHISA GRIGIA	
	PVD	M01-10 K10-30							

● APPLICAZIONE CONSIGLIATA
RECOMMENDED APPLICATION
EMPFOHLENER EINSATZ
APPLICATION CONSEILLÉE

○ APPLICAZIONE POSSIBILE
POSSIBLE APPLICATION
MÖGLICHE ANWENDUNG
APPLICATION POSSIBLE

● APPLICAZIONE CONSIGLIATA
RECOMMENDED APPLICATION
EMPFOHLENER EINSATZ
APPLICATION CONSEILLÉE

○ APPLICAZIONE POSSIBILE
POSSIBLE APPLICATION
MÖGLICHE ANWENDUNG
APPLICATION POSSIBLE

 INDICATIONS - USE	 GEBRAUCHSANWEISUNGEN	 INDICATION - USAGE
<ul style="list-style-type: none"> - IMPROVED SUBSTRATE WITH GOOD RESISTANCE TO WEAR AND ABRASION - SUITABLE FOR MACHINING WITHOUT COOLING LUBRICANT 	<ul style="list-style-type: none"> - VERBESSERTES SUBSTRAT MIT GUTER VERSCHLEIßBESTÄNDIGKEIT UND ABRIEBFESTIGKEIT - ZUR BEARBEITUNG OHNE KÜHLSCHMIERSTOFF GEEIGNET 	<ul style="list-style-type: none"> - SUBSTRAT AMÉLIORÉ AVEC BONNE RÉSISTANCE À L'USURE ET À L'ABRASION - SPÉCIALEMENT PRÉVU POUR LES USINAGES SANS LUBRIFIANT-RÉFRIGÉRANT.
<ul style="list-style-type: none"> - MICROGRAIN GRADE WITH HIGH RESISTANCE TO WEAR AND GOOD TOUGHNESS - EXCELLENT FOR FINISHING APPLICATIONS ON ISO M-S MATERIALS 	<ul style="list-style-type: none"> - MIKROKORN-SORTE MIT HOHER VERSCHLEIßFESTIGKEIT UND GÜTER ZÄHIGKEIT - HERVORRAGEND ZUM SCHLICHTEN AUF ISO-M-S-MATERIALIEN 	<ul style="list-style-type: none"> - QUALITÉ MICROGRAIN AVEC HAUTE RÉSISTANCE À L'USURE ET BONNE DURETÉ - APPLICATION PARFAITE POUR TRAVAUX DE FINITION SUR ISO M-S
<ul style="list-style-type: none"> - GRADE FOR THE MACHINING OF STAINLESS STEEL 	<ul style="list-style-type: none"> - SORTE FÜR DIE BEARBEITUNG VON INOX-STAHL 	<ul style="list-style-type: none"> - NUANCE POUR L'USINAGE DE L'ACIER INOXYDABLE
<ul style="list-style-type: none"> - SPECIALLY DEVELOPED CARBIDE SUBSTRATE - INNOVATIVE PVD COATING PROVIDING EXCELLENT STRENGTH AND VERY GOOD TOUGHNESS WITHOUT AFFECTING RED HARDNESS AT BOTH LOW AND HIGH CUTTING SPEED 	<ul style="list-style-type: none"> - SPEZIELL ENTWICKELTES KARBID-SUBSTRAT - INNOVATIVE PVD-BESCHICHTUNG FÜR EXCELLENTE ROBUSTHEIT UND OPTIMALE ZÄHIGKEIT OHNE BEEINTRÄCHTIGUNG DER WARMHÄRTE BEI SOWOHL HOHEN ALS AUCH NIEDRIGEN SCHNITTGESCHWINDIGKEITEN 	<ul style="list-style-type: none"> - SUBSTRAT DE CARBURE SPÉCIALEMENT DÉVELOPPÉ - REVÊTEMENT EN PVD INNOVANT, FOURNIT UNE ROBUSTESSE ET TENACITÉ EXCELLENTE, SANS POUR AUTANT PORTER PRÉJUDICE À LA DURETÉ À CHAUD À DE BASSES COMME À DE HAUTES VITESSES DE COUPE.
<ul style="list-style-type: none"> - VERY TOUGH INSERT, IDEAL FOR STEEL AND INOX - SUITABLE FOR A WIDE RANGE OF MATERIALS 	<ul style="list-style-type: none"> - SEHR ZÄHE PLATTE, IDEAL FÜR STAHL- UND INOX-BEARBEITUNGEN - EINSETZBAR FÜR DIE BEARBEITUNG VON ZAHLREICHEN MATERIALIEN 	<ul style="list-style-type: none"> - PLAQUETTE TRÈS TENACE IDÉALE POUR USINAGES SUR ACIERS ET INOX - EST EN ÉTAT D'USINER UNE AMPLE GAMME DE MATÉRIAUX
<ul style="list-style-type: none"> - HIGH RESISTANCE TO WEAR, SUITABLE FOR FACING UNDER STABLE CONDITIONS 	<ul style="list-style-type: none"> - HOHE VERSCHLEISSFESTIGKEIT, ZUR PLANBEARBEITUNG UNTER STABILÉN BEDINGUNGEN GEEIGNET 	<ul style="list-style-type: none"> - HAUTE RÉSISTANCE À L'USURE, INDIQUÉ POUR LES OPÉRATIONS DE SURFAÇAGE DANS DES CONDITIONS STABLES.
<ul style="list-style-type: none"> - IDEAL GRADE FOR HIGH VOLUME MACHINING - GOOD HEAT RESISTANCE AND THEREFORE PERFECTLY SUITABLE FOR DRY MACHINING, EVEN AT HIGH CUTTING SPEEDS 	<ul style="list-style-type: none"> - IDEALE SORTE FÜR HOCHVOLUMENFERTIGUNG - GUTE HITZEBESTÄNDIGKEIT UND DAHER PERFEKT FÜR DIE TROCKENBEARBEITUNG, AUCH MIT HOHEN SCHNITTGESCHWINDIGKEITEN 	<ul style="list-style-type: none"> - DEGRÉ PLAQUETTE IDÉAL POUR LA PRODUCTION À HAUT VOLUME - BONNE RÉSISTANCE À LA CHALEUR, QUI LE REND PARFAITEMENT INDIQUÉ POUR L'USINAGE À SEC MÊME À DE HAUTES VITESSES DE COUPE
<ul style="list-style-type: none"> - HIGH RESISTANCE TO WEAR, GOOD TOUGHNESS - SUITABLE FOR MEDIUM – HIGH CUTTING SPEEDS FOR FINISHING AND ROUGHING MAINLY ON GRAY IRON 	<ul style="list-style-type: none"> - HOHE VERSCHLEISSFESTIGKEIT UND GUTE ZÄHIGKEIT - FÜR MITTEL-HOHE SCHNITTGESCHWINDIGKEITEN ZUM SCHLICHTEN UND SCHRUPPEN, ÜBERWIEGEND AUF GRAUGUSS, GEEIGNET. 	<ul style="list-style-type: none"> - HAUTE RESISTANCE A L'USURE ET BONNE TENACITÉ - INDIQUE POUR LES VITESSES HAUTES-MOYENNES DE COUPE DANS LA FINITION ET LE DEGROSSISSAGE PRINCIPALEMENT SUR FONTE GRISE
<ul style="list-style-type: none"> - TURNING GRADE FOR GREY CAST IRON AND NODULAR CAST IRON 	<ul style="list-style-type: none"> - DREHSORTE FÜR DIE BEARBEITUNG VON GUSS UND SPHÄROGUSS 	<ul style="list-style-type: none"> - DEGRÉ DE TOURNAGE POUR L'USINAGE DE LA FONTE GRISE ET SPHEROÏDALE
<ul style="list-style-type: none"> - MEDIUM TOUGH INSERT - IDEAL FOR MEDIUM TO HIGH CUTTING SPEEDS - SUITABLE FOR MACHINING ALLOYED AND WEAKLY ALLOYED STEELS 	<ul style="list-style-type: none"> - WENDEPLATTE MIT MITTLERER ZÄHIGKEIT - GEEIGNET FÜR MITTLERE/HOHE SCHNITTGESCHWINDIGKEITEN - GEEIGNET FÜR BEARBEITUNGEN VON LEGIERTEM UND SCHWACH LEGIERTEM STAHL 	<ul style="list-style-type: none"> - PLAQUETTE AVEC TÉNACITÉ MOYENNE - PRÉVUE POUR DES VITESSES DE COUPE HAUTES ET MOYENNES - PRÉVUE POUR L'USINAGE DES ACIERS ALLIÉS ET FAIBLEMENT ALLIÉS



SAU	DIN ISO 513	MATERIALE - MATERIAL MATERIALIEN - MATÉRIAUX						PAG. 1199	QUICK PICK PAG. 704	 INDICAZIONI - USO	
		P	M	K	N	S	H				
		ACCIAI STEELS STAHL ACIER	ACCIAI INOX STAINLESS STEELS ROSTFREIER STAHL ACIER INOXYDABLE	GHISA CAST IRON GRAUGUSS	MATTONI FERROSI NON FERROSI MAT. NICHELSEN/MATERIALIEN MAT. FERREUX	MAT. DIFFICILI DIFFICULT MATERIAL SCHWIERIGE MATERIALIEN MAT. DIFICILES	MATERIALI DURI HARTE MATERIALIEN MATÉRIAUX DURS				
T3121 NEW	HC CVD	K10-25			●				 Tenacità + Toughness -		- GRADO SPECIFICO PER LAVORAZIONE DI GHISA. PER LAVORAZIONI IN GENERE ANCHE PER TAGLIO INTERROTTO, IDEALE PER GHISE GRIGIE E SFEROIDALI
T1425	HC CVD	P15-35 M10-25 K25-35	●	○	○						- VASTA GAMMA DI IMPIEGHI, IDEALE PER TUTTE LE LEGHE DI ACCIAIO E GHISA, BUONE PRESTAZIONI ANCHE SU INOX
F4425	HC PVD	P30-40 M15-35	●	●							- ELEVATA TENACITA', ALTA RESISTENZA ALLA DEFORMAZIONE E ALLA SCHEGGIATURA - INDICATO PER BASSE VELOCITA' DI TAGLIO
F2430	HC PVD	M20-40		●			○				- GRADO MOLTO TENACE, IDEALE PER LA LAVORAZIONE DI ACCIAIO INOSSIDABILE A MEDIO BASSE VELOCITA' DI TAGLIO. - OTTIMA RESISTENZA ALL'USURA SIA CON LAVORAZIONI A SECCO CHE IN UMIDO.
T531	HC CVD	P15-30 M20-40	○	●			●				- QUALITA' MICROGRANO TENACE CON BUONA RESISTENZA AGLI URTI ED AGLI SHOCK TERMICI - INDICATO PER MEDIE E MEDIO-BASSE VELOCITA' DI TAGLIO
T1435	HC CVD	P25-45 M20-30	●	○							- GRADO INSERTO TENACE PER LAVORAZIONI DIFFICILI CON CONDIZIONI INSTABILI E A TAGLIO INTERROTTO
T1215 NEW	HC CVD	P10-25 K10-25	●		○						- QUALITÀ PER MASSIMA VELOCITÀ DI TAGLIO CON TORNITURA DA LEGGERA A MEDIA, GRAZIE ALLO SPECIALE RIVESTIMENTO QUESTO TIPO È ESTREMAMENTE RESISTENTE ALL'USURA
T1225	HC CVD	P15-35 M15-35	●	○							- QUESTA VARIETÀ MULTI-GAMMA È CARATTERIZZATA DA ELEVATA RESISTENZA ALL'USURA ED ECCELLENTI PROPRIETÀ DI TENACITÀ A UNA VASTA GAMMA DI APPLICAZIONI.
T540	HC CVD	P20-43 M25-40	●	○			○				- OTTIMA TENACITÀ, RESISTENZA ALL'USURA E ALLA SCHEGGIATURA - INDICATO PER MEDIO-BASSE VELOCITÀ DI TAGLIO
D3010	DP	N01-10				●					- GRADO INDICATO PER LA TORNITURA DI MATERIALI NON FERROSI, ES. LEGHE DI ALLUMINIO, MEGLIO SE AD ALTO TENORE DI SILICIO, RAME, BRONZO TERMOPLASTICI RINFORZATI E COMPOSITI. - OTTIMA FINITURA E VITA UTENSILE.

● APPLICAZIONE CONSIGLIATA
RECOMMENDED APPLICATION
EMPFOHLENER EINSATZ
APPLICATION CONSEILLÉE

○ APPLICAZIONE POSSIBILE
POSSIBLE APPLICATION
MÖGLICHE ANWENDUNG
APPLICATION POSSIBLE

● APPLICAZIONE CONSIGLIATA
RECOMMENDED APPLICATION
EMPFOHLENER EINSATZ
APPLICATION CONSEILLÉE

○ APPLICAZIONE POSSIBILE
POSSIBLE APPLICATION
MÖGLICHE ANWENDUNG
APPLICATION POSSIBLE

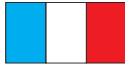
 INDICATIONS - USE	 GEBRAUCHSANWEISUNGEN	 INDICATION - USAGE
<ul style="list-style-type: none"> - CAST IRON-SPECIFIC INSERT GRADE FOR GENERAL PURPOSE, ALSO FOR INTERRUPTED CUTTING. BEST SUITED FOR GREY AND NODULAR CAST IRON 	<ul style="list-style-type: none"> - SPEZIFISCHE SORTE FÜR GUSSEISEN ALLGEMEIN EINSETZBAR, AUCH FÜR UNTERBROCHENEN SCHNITT, IDEAL FÜR GRAU- UND SPHÄROGUSS 	<ul style="list-style-type: none"> - DEGRÉ SPÉCIFIQUE POUR L'USINAGE DE LA FONTE. POUR LES EXÉCUTIONS EN GÉNÉRAL MÊME EN CAS DE DÉCOUPAGE INTERROMPU, PARFAIT POUR LES FONTES GRISSES ET SPHÉROÏDALES
<ul style="list-style-type: none"> - WIDE RANGE OF APPLICATIONS, IDEAL FOR ALL STEEL AND CAST IRON ALLOYS, GOOD PERFORMANCE ALSO ON INOX 	<ul style="list-style-type: none"> - HOHE VIELSEITIGKEIT, IDEAL FÜR ALLE STAHL- UND GUSLEGIERUNGEN, GUTE LEISTUNG AUCH MIT INOXSTAHL 	<ul style="list-style-type: none"> - VASTE GAMME D'EMPLOIS, IDÉAL POUR TOUS LES ALLIAGES EN ACIER ET FONTE, BONNES PERFORMANCES MÊME SUR INOX
<ul style="list-style-type: none"> - HIGH TOUGHNESS, STRAIN STRENGTH AND RESISTANCE TO CHIPPING - SUITABLE FOR LOW CUTTING SPEEDS 	<ul style="list-style-type: none"> - HOHE ZÄHIGKEIT, UMFORMFESTIGKEIT UND ABSPLITTERWIDERSTAND - FÜR GERINGE SCHNITTGESCHWINDIGKEITEN GEEIGNET 	<ul style="list-style-type: none"> - TENACITÉ ÉLEVÉE, HAUTE RÉSISTANCE À LA DÉFORMATION ET À L'ÉBRÈCHEMENT - INDIQUÉE POUR FAIBLE VITESSE DE COUPE POUR OPÉRATIONS DURS ET DIFFICILES
<ul style="list-style-type: none"> - REMARKABLY TOUGH, IDEAL FOR MACHINING STAINLESS STEEL AT MEDIUM-SLOW CUTTING SPEEDS - EXCELLENT WEAR RESISTANCE WITH BOTH DRY AND WET MACHINING WORK 	<ul style="list-style-type: none"> - SEHR ZÄHE SORTE, IDEAL FÜR EDELSTAHLBEARBEITUNGEN MIT MITTLERER/ NIEDRIGER SCHNITTGESCHWINDIGKEIT. - AUSGEZEICHNETE VERSCHLEISSFESTIGKEIT BEI TROCKEN- UND NASSBEARBEITUNGEN. 	<ul style="list-style-type: none"> - DEGRÉ TRÈS TENACE, IDÉAL POUR L'USINAGE DE L'ACIER INOXYDABLE À DES VITESSES BASSES ET MOYENNES DE COUPE. - RÉSISTANCE PARFAITE À L'USURE AVEC DES USINAGES À SEC COMME À L'EAU.
<ul style="list-style-type: none"> - TOUGH MICROGRAIN GRADE WITH HIGH RESISTANCE TO SHOCK AND THERMAL SHOCK. - SUITABLE FOR MEDIUM AND MEDIUM-LOW CUTTING SPEEDS 	<ul style="list-style-type: none"> - MIKROKORNSORTE MIT HOHER STOSSFESTIGKEIT UND TEMPERATURWECHSELBESTÄNDIGKEIT - FÜR MITTLERE UND MITTEL-NIEDRIGE SCHNITTGESCHWINDIGKEITEN GEEIGNET 	<ul style="list-style-type: none"> - QUALITÉ DE MICROGRAIN TENACE AVEC BONNE RÉSISTANCE AU COUPS ET AU SHOCKS THERMIQUES. - INDIQUÉE POUR MOYENNE ET MOYENNE-FAIBLE VITESSE DE COUPE
<ul style="list-style-type: none"> - TOUGH DEGREE FOR DIFFICULT MACHINING UNDER UNSTABLE CONDITIONS AND WITH INTERRUPTED CUT 	<ul style="list-style-type: none"> - ZÄHE SORTE FÜR SCHWERE BEARBEITUNGEN UNTER UNSTABILEN BEDINGUNGEN UND MIT UNTERBROCHENEM SCHNITT 	<ul style="list-style-type: none"> - DEGRÉ PLAQUETTE TENACE POUR USINAGES DIFFICILES DANS DES CONDITIONS INSTABLES ET À COUPE INTERROMPUE
<ul style="list-style-type: none"> - GRADE FOR MAXIMUM CUTTING SPEED IN LIGHT TO MEDIUM TURNING OPERATIONS. THANKS TO ITS SPECIAL COATING, IT IS EXTREMELY RESISTANT TO WEAR 	<ul style="list-style-type: none"> - SORTE FÜR MAXIMALE SCHNITTGESCHWINDIGKEIT BEI LEICHTEN BIS MITTLEREN DREHANWENDUNGEN. ÄUSSERST VERSCHLEISSFEST DANK SEINER SPEZIELLEN BESCHICHTUNG. 	<ul style="list-style-type: none"> - QUALITÉ POUR UNE VITESSE DE DÉCOUPE MAXIMUM AVEC TOURNAGE DE LÉGER À MOYEN, GRÂCE AU REVÊTEMENT SPÉCIAL CE TYPE EST EXTRÊMEMENT RÉSISTANT À L'USURE.
<ul style="list-style-type: none"> - THIS MULTI-RANGE GRADE FEATURES HIGH RESISTANCE TO WEAR AND OUTSTANDING TOUGHNESS FOR A BROAD SPECTRUM OF APPLICATIONS 	<ul style="list-style-type: none"> - DIESE MEHRBEREICHSSORTE ZEICHNET SICH DURCH HOHE VERSCHLEISSFESTIGKEIT UND HERVORRAGENDE ZÄHIGKEITSEIGENSCHAFTEN FÜR EINE VIELZAHL VON ANWENDUNGEN AUS 	<ul style="list-style-type: none"> - CETTE VARIÉTÉ MULTI-GAMME SE CARACTÉRISE PAR UNE RÉSISTANCE ÉLEVÉE À L'USURE ET DES PROPRIÉTÉS DE DURETÉ EXCELLENTES S'ÉTENDANT À UNE VASTE GAMME D'APPLICATIONS.
<ul style="list-style-type: none"> - HIGH TOUGHNESS, RESISTANCE TO WEAR AND CHIPPING - SUITABLE FOR MEDIUM-LOW CUTTING SPEEDS 	<ul style="list-style-type: none"> - SEHR GUTER VERSCHLEISS, UND AUSBRUCHFESTIGKEIT - FÜR MITTEL-NIEDRIGE SCHNITTGESCHWINDIGKEITEN 	<ul style="list-style-type: none"> - HAUTE TENACITÉ, RÉSISTANCE À L'USURE ET À L'ÉBRÈCHEMENT - INDIQUÉE POUR MOYENNE-FAIBLE VITESSE DE COUPE
<ul style="list-style-type: none"> - TURNING GRADE FOR NON-FERROUS MATERIALS, SUCH AS ALUMINUM ALLOYS, PREFERABLY WITH HIGH SILICON, COPPER, BRONZE CONTENT, REINFORCED THERMOPLASTIC MATERIALS AND COMPOUNDS - EXCELLENT FINISHING AND TOOL LIFE 	<ul style="list-style-type: none"> - SORTE ZUM DREHEN FÜR NICHT-EISENMATERIALIEN, Z.B. ALUMINIUM-LEGIERUNGEN, VORZUGSWEISE MIT HOHEM SILIZIUM-, KUPFER- UND BRONZEHALT, VERSTÄRKTE THERMOPLASTE UND VERBUNDMATERIALIEN. - HERVORRAGENDE OBERFLÄCHENGÜTE UND WERKZEUGSTANDZEIT 	<ul style="list-style-type: none"> - DEGRÉ INDIQUÉ POUR LE TOURNAGE DE MATÉRIAUX NON FERREUX, TELS QUE ALLIAGES D'ALUMINIUM, AUTANT QUE POSSIBLE À TENEUR ÉLEVÉE DE SILICIUM, CUIVRE, BRONZE, THERMOPLASTIQUES RENFORCÉS ET COMPOSITES. - FINITION ET VIE DE L'OUTIL EXCELLENTES.

HT CERMET

HW

METALLO DURO NON RICOPERTO
UNCOATED CARBIDE
UNBESCHICHTETES HARTMETALL
MÉTAL DUR PAS RECOUVERT

HC

METALLO DURO RICOPERTO
COATED CARBIDE
BESCHICHTETES HARTMETALL
MÉTAL DUR RECOUVERT

DP

DIAMANTE POLICRISTALLINO (PCD)
POLYCRYSTALLINE DIAMOND (PCD)
POLYKRISTALLINER DIAMANT (PCD)
DIAMANT POLYCRISTALLIN (PCD)

MATERIALE MATERIAL MATERIALIEN MATERIAUX PAG 1199	VDI 3323 GR.	HB HRC Rm	C4010	DT63	T115	N3610	N3015	T120	T3310 NEW	F2120	F2425	T1126	F2326 NEW	T2330
P ACCIAI STEELS STAHL ACIER	1	125	230-270	310-400							130-250	170-240	130-200	
	2	180	230-270	260-350							130-250	170-240	130-200	
	3	250	230-270	220-300							130-250	170-240	130-200	
	4	220	230-270	220-330							130-250	170-240	130-200	
	5	300	230-270	180-280							130-250	170-240	130-200	
	6	180	230-270	250-350							130-250	170-240		
	7-8	250-300	180-230	200-350							60-180	100-190		
	9	350	180-230	150-220							60-180	130-210		
	10	200	160-200	200-350							80-200	130-210		
	11	350	160-200	150-220							80-200	130-220		
	12	200	230-270	180-300					80-150			120-250	130-220	
	13	330	170-240	150-250					40-70			120-250	130-220	
	M ACCIAI INOX STAINLESS STEELS ROSTFREIER STAHL ACIER INOXYDABLE	14.1	180	170-240	150-280				50-100		120-200	100-250	100-210	130-200
14.2		230-260	130-160	100-150				50-90		60-160	40-160	70-100	100-180	80-140
K GHISA CAST IRON GRAUGUSS FONTE GRISE	15	180	200-300	200-300	120-160			100-150		120-160		130-210		
	16	260	200-300	150-260	120-160			70-120		120-160		130-210		
	17	160	220-300	180-300	130-170			100-140		120-160		120-240		
	18	250	220-300	150-240	90-130			80-120		120-160		120-240		
	19	130	250-350	170-280	140-200			120-180		140-220		150-250		
	20	230	250-350	150-220	120-160			70-120		120-160		150-250		
N MAT. NON FERROSI NON FERROUS MAT. NICHT-EISENMATERIALIEN MAT. FERREUX	21	60			100-950	100-950	400-950	300-1000	450-950	100-400				
	22	100			100-950	100-950	160-950	300-800	450-950	100-400				
	23	75			100-950	100-950	320-950	200-500	450-950	100-400				
	24	90			100-950	100-950	240-950	200-400	450-950	100-400				
	25	130			100-800	100-800	160-800	200-300	450-950	100-400				
	26	110			100-600	100-600	200-520	200-450	250-950	100-400				
	27	90			100-600	100-600	200-800	200-400	250-950	100-400				
	28	100			100-400	100-400	120-320	250-350	250-950	100-400				
	29				60-180	60-180		300-500	250-950	100-600				
	30				100-250	100-250		100-300	250-950	100-600				
S MAT. DIFFICILI DIFFICULT MATERIAL SCHWERIGE MATERIALIEN MAT. DIFFICILES	31	200			30-45					20-50				
	32	280			20-35					20-50				
	33	250			20-35					15-40				
	34	350			18-30					20-35				
	35	320			15-25					20-35				
	36	Rm400			60-120					80-140				
	37	Rm1050			30-80					80-140				
H MATERIALI DURI HARD MATERIALS HARTE MATERIALIEN MATERIAUX DURS	38	55HRC												
	39	60HRC												
	40	400												
	41	55HRC												

MATERIALE MATERIAL MATERIALIEN MATÉRIAUX PAG 1199	VDI 3323 GR.	HB HRC Rm	F2435	F7035	T3112 NEW	T1415	T516	T3220	F5120 NEW	T3121 NEW	T1425	F2430	T531	T1435
P ACCIAI STEELS STAHL ACIER	1	125	170-190	180-300		220-400		200-340	200-350		170-240		200-300	170-190
	2	180	170-190	140-250		220-400		200-340	170-330		170-240		180-280	170-190
	3	250	170-190	140-250		220-400		200-340	120-300		170-240			170-190
	4	220	170-190	140-250		220-400		200-340	100-250		170-240			170-190
	5	300	170-190	140-250		220-400		200-340	100-280		170-240			170-190
	6	180	90-150	160-280		220-400		200-340	120-250		170-240			170-190
	7-8	250-300	90-150	130-220		200-320		150-290	70-200		100-190			90-150
	9	350	90-150	100-260		200-320		150-290	100-250		130-210			120-200
	10	200	120-200	110-200		180-320		160-290	70-200		130-210			120-200
	11	350	120-200	100-160		180-320		160-290	100-250		130-220			140-180
	12	200	140-180	120-250		200-320		160-290	100-230		130-220		130-180	140-180
	13	330	140-180	80-190		200-320		160-290	100-230		130-220		100-140	140-200
	M ACCIAI INOX STAINLESS STEELS ROSTFREIER STAHL ACIER INOXYDABLE	14.1	180	110-200	100-180					100-200		100-210	100-220	100-160
14.2		230-260	55-150	80-140					80-150		70-100	80-200	80-120	50-150
K GHISA CAST IRON GRAUGUSS FONTE GRISE	15	180		120-200	210-500	140-370	180-300	150-400	120-300	200-400	130-210			
	16	260		100-180	140-270	140-370	140-270	150-400	120-300	140-270	130-210			
	17	160		120-200	150-300	190-430	130-220	200-450	120-280	120-300	120-240			
	18	250		100-180	110-200	190-430	100-200	200-450	120-280	100-200	120-240			
	19	130		80-160	200-330	180-520	150-280	200-550	120-280	180-320	150-250			
	20	230		70-150	100-240	180-520	120-220	200-550	100-260	100-240	150-250			
N MAT NON FERROSI NON FERROUS MAT. NICHT EISEN MATERIALIEN MAT. FERREUX	21	60		150-500										
	22	100		150-450										
	23	75		150-350										
	24	90		150-300										
	25	130		150-250										
	26	110		150-350										
	27	90		150-350										
	28	100		200-400										
	29			50-150										
	30			80-200										
S MAT DIFFICILI DIFFICULT MATERIAL SCHWERIGE MATERIALIEN MAT. DIFCILES	31	200		20-80								20-40	20-40	
	32	280		20-80								20-40	15-35	
	33	250		20-80								20-40	10-30	
	34	350		20-80								10-30	5-18	
	35	320		20-80								10-30	5-18	
	36	Rm400		40-100								10-30	80-130	
	37	Rm1050		40-100								20-50	20-40	
H MATERIALI DURI HARD MATERIALS HARTE MATERIALIEN MATÉRIAUX DURS	38	55HRC												
	39	60HRC												
	40	400												
	41	55HRC												

MATERIALE MATERIAL MATERIALIEN MATERIAUX PAG 1199	VDI 3323 GR.	HB HRC Rm	T1215 NEW	T1225	T540	D3010								
P ACCIAI STEELS STAHL ACIER	1	125	140-360	170-250	180-230									
	2	180	140-360	150-200	170-190									
	3	250	140-360	100-170	130-150									
	4	220	140-360	80-140										
	5	300	130-260	100-160										
	6	180	130-260	140-200	150-190									
	7-8	250-300	130-260	100-160	90-150									
	9	350	130-260	100-150	70-130									
	10	200	110-210	80-140	120-200									
	11	350	110-210	80-170	50-100									
	12	200	110-210	120-180	140-180									
	13	330	110-210	80-140	110-160									
	M ACCIAI INOX STAINLESS STEELS ROSTFREIER STAHL ACIER INOXYDABLE	14.1	180		100-130	110-190								
14.2		230-260		80-130	80-150									
K GHISA CAST IRON GRAUGUSS FONTE GRISE	15	180	110-360											
	16	260	110-360											
	17	160	110-360											
	18	250	110-360											
	19	130	110-210											
	20	230	110-210											
N MAT. NON FERROSI NON FERROUS MAT. NICHT-EISENMATERIALIEN MAT. FERREUX	21	60				300-950								
	22	100				300-950								
	23	75				200-950								
	24	90				200-950								
	25	130				180-500								
	26	110				180-350								
	27	90				180-350								
	28	100				200-950								
	29					300-950								
	30					300-950								
S MAT. DIFFICILI DIFFICULT MATERIAL SCHWIERIGE MATERIALIEN MAT. DIFFICILES	31	200			20-40									
	32	280			15-35									
	33	250			8-25									
	34	350			4-15									
	35	320			4-15									
	36	Rm400			80-130									
	37	Rm1050			15-35									
H MATERIALI DURI HARD MATERIALS HARTE MATERIALIEN MATERIAUX DURS	38	55HRC												
	39	60HRC												
	40	400												
	41	55HRC												

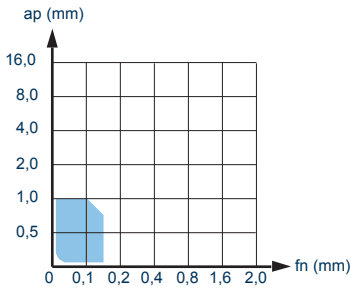











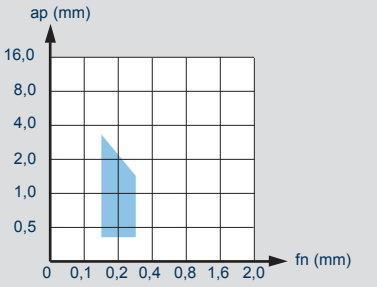

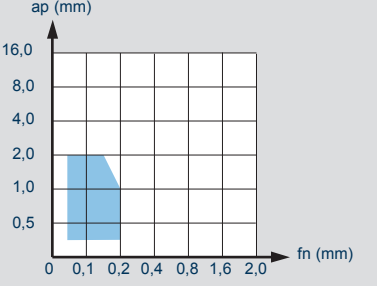
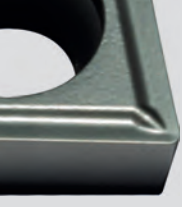
				○	○	⊗
F	M	R	P	DT61T		
●			M	DT61T		
●			K	T120		
●			N	T120		
			S			
			H			

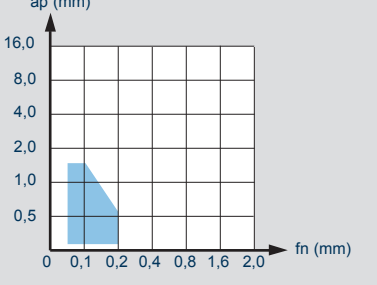
GRADI CONSIGLIATI
 RECOMMENDED GRADES
 EMPFOHLENE SORTEN
 DEGRÉS CONSEILLÉS

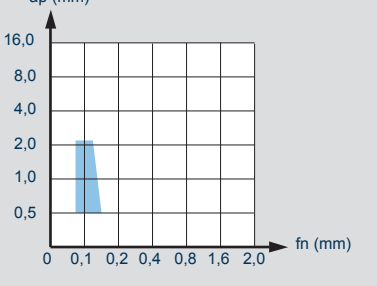
F =	FINITURA, LAV. LEGGERE	FINISHING, LIGHT MACHINING	SCHLICHTEN, LEICHTE BEARBEITUNG	FINISSAGE USINAGES LÉGERES
M =	GENERIC, LAV. MEDIE	GENERIC MEDIUM MACHINING	ALLGEMEIN, MITTELSCHWERE BEARBEITUNG	GENERAL USINAGES MOYENS
R =	SGROSSATURA, LAV. PESANTI	ROUGHING, HEAVY MACHINING	SCHRUPPEN, SCHWERE BEARBEITUNG	DEGROSSISAGES, USINAGES LOURDS
P, M, K, N, S, H =	MATERIALI ISO PAG 1199	ISO MATERIALS PAGE 1199	ISO-MATERIEALIEN, SEITE 1199	MATERIAUX ISO PAG 1199
○ =	TAGLIO CONTINUO	CONTINUOUS CUT	KONTINUIERLICHER SCHNITT	TRONÇONNAGE CONTINU
○ =	TAGLIO DISCONTINUO	DISCONTINUOUS CUT	DISKONTINUIERLICHER SCHNITT	TRONÇONNAGE DISCONTINU
⊗ =	TAGLIO INTERROTTO	INTERRUPTED CUT	UNTERBROCHENER SCHNITT	TRONÇONNAGE INTERROMPU
● =	APPLICAZIONE CONSIGLIATA	RECOMMENDED APPLICATION	EMPFOHLENER EINSATZ	APPLICATION CONSEILLÉE
○ =	APPLICAZIONE POSSIBILE	POSSIBLE APPLICATION	MOGLICHE ANWENDUNG	APPLICATION POSSIBLE
ap (mm) =	PROFONDITÀ DI PASSATA	DEPTH OF CUT	GANGTIEFE	PROFONDEUR DE PASSE
fn (mm) =	AVANZAMENTO AL GIRO	FEED/REVOLUTION	VORSCHUB PRO UMDREHUNG	DÉPLACEMENT AU TOUR

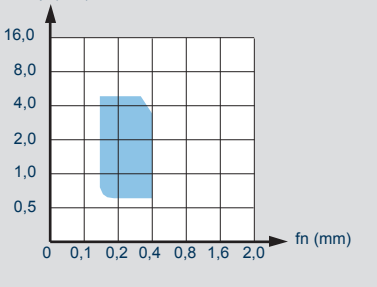
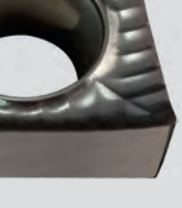
<p>.G13</p>									
					<p>.B22</p>				

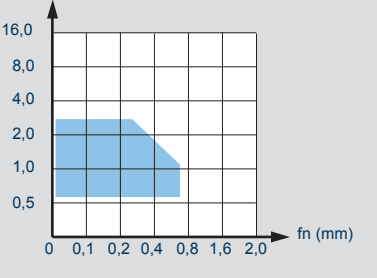
 <p>.G32W</p>			<table border="1"> <thead> <tr> <th>F</th> <th>M</th> <th>R</th> <th></th> <th></th> <th></th> </tr> </thead> <tbody> <tr> <td>●</td> <td></td> <td></td> <td>P</td> <td>T1425</td> <td></td> </tr> <tr> <td>○</td> <td></td> <td></td> <td>M</td> <td>T1425</td> <td></td> </tr> <tr> <td>○</td> <td></td> <td></td> <td>K</td> <td>T1425</td> <td></td> </tr> <tr> <td></td> <td></td> <td></td> <td>N</td> <td></td> <td></td> </tr> <tr> <td></td> <td></td> <td></td> <td>S</td> <td></td> <td></td> </tr> <tr> <td></td> <td></td> <td></td> <td>H</td> <td></td> <td></td> </tr> </tbody> </table>	F	M	R				●			P	T1425		○			M	T1425		○			K	T1425					N						S						H		
F	M	R																																											
●			P	T1425																																									
○			M	T1425																																									
○			K	T1425																																									
			N																																										
			S																																										
			H																																										
 <p>.F33 NEW</p>			<table border="1"> <thead> <tr> <th>F</th> <th>M</th> <th>R</th> <th></th> <th></th> <th></th> </tr> </thead> <tbody> <tr> <td>○</td> <td></td> <td></td> <td>P</td> <td>F2326</td> <td></td> </tr> <tr> <td>●</td> <td></td> <td></td> <td>M</td> <td>F2326</td> <td></td> </tr> <tr> <td></td> <td></td> <td></td> <td>K</td> <td></td> <td></td> </tr> <tr> <td></td> <td></td> <td></td> <td>N</td> <td></td> <td></td> </tr> <tr> <td></td> <td></td> <td></td> <td>S</td> <td></td> <td></td> </tr> <tr> <td></td> <td></td> <td></td> <td>H</td> <td></td> <td></td> </tr> </tbody> </table>	F	M	R				○			P	F2326		●			M	F2326					K						N						S						H		
F	M	R																																											
○			P	F2326																																									
●			M	F2326																																									
			K																																										
			N																																										
			S																																										
			H																																										
 <p>.G39</p>			<table border="1"> <thead> <tr> <th>F</th> <th>M</th> <th>R</th> <th></th> <th></th> <th></th> </tr> </thead> <tbody> <tr> <td>●</td> <td></td> <td></td> <td>P</td> <td>C4010</td> <td></td> </tr> <tr> <td></td> <td></td> <td></td> <td>M</td> <td>C4010</td> <td></td> </tr> <tr> <td></td> <td></td> <td></td> <td>K</td> <td>C4010</td> <td></td> </tr> <tr> <td></td> <td></td> <td></td> <td>N</td> <td></td> <td></td> </tr> <tr> <td></td> <td></td> <td></td> <td>S</td> <td></td> <td></td> </tr> <tr> <td></td> <td></td> <td></td> <td>H</td> <td></td> <td></td> </tr> </tbody> </table>	F	M	R				●			P	C4010					M	C4010					K	C4010					N						S						H		
F	M	R																																											
●			P	C4010																																									
			M	C4010																																									
			K	C4010																																									
			N																																										
			S																																										
			H																																										
 <p>.G42</p>			<table border="1"> <thead> <tr> <th>F</th> <th>M</th> <th>R</th> <th></th> <th></th> <th></th> </tr> </thead> <tbody> <tr> <td>●</td> <td></td> <td></td> <td>P</td> <td>T1415-T1425-F2425</td> <td>T1415-T1425-F2425</td> </tr> <tr> <td>●</td> <td></td> <td></td> <td>M</td> <td>T1425-F2425</td> <td>T1425-F2425</td> </tr> <tr> <td>○</td> <td></td> <td></td> <td>K</td> <td>T1415-T1425</td> <td>T1415-T1425</td> </tr> <tr> <td></td> <td></td> <td></td> <td>N</td> <td></td> <td></td> </tr> <tr> <td></td> <td></td> <td></td> <td>S</td> <td></td> <td></td> </tr> <tr> <td></td> <td></td> <td></td> <td>H</td> <td></td> <td></td> </tr> </tbody> </table>	F	M	R				●			P	T1415-T1425-F2425	T1415-T1425-F2425	●			M	T1425-F2425	T1425-F2425	○			K	T1415-T1425	T1415-T1425				N						S						H		
F	M	R																																											
●			P	T1415-T1425-F2425	T1415-T1425-F2425																																								
●			M	T1425-F2425	T1425-F2425																																								
○			K	T1415-T1425	T1415-T1425																																								
			N																																										
			S																																										
			H																																										
 <p>.S42</p>			<table border="1"> <thead> <tr> <th>F</th> <th>M</th> <th>R</th> <th></th> <th></th> <th></th> </tr> </thead> <tbody> <tr> <td>●</td> <td>●</td> <td></td> <td>P</td> <td>T540</td> <td>T540</td> </tr> <tr> <td>●</td> <td>●</td> <td></td> <td>M</td> <td>T540</td> <td>T540</td> </tr> <tr> <td>●</td> <td>●</td> <td></td> <td>K</td> <td>T120</td> <td>T120</td> </tr> <tr> <td>●</td> <td>●</td> <td></td> <td>N</td> <td>T120</td> <td>T120</td> </tr> <tr> <td></td> <td></td> <td></td> <td>S</td> <td></td> <td></td> </tr> <tr> <td></td> <td></td> <td></td> <td>H</td> <td></td> <td></td> </tr> </tbody> </table>	F	M	R				●	●		P	T540	T540	●	●		M	T540	T540	●	●		K	T120	T120	●	●		N	T120	T120				S						H		
F	M	R																																											
●	●		P	T540	T540																																								
●	●		M	T540	T540																																								
●	●		K	T120	T120																																								
●	●		N	T120	T120																																								
			S																																										
			H																																										
 <p>.F47 NEW</p>			<table border="1"> <thead> <tr> <th>F</th> <th>M</th> <th>R</th> <th></th> <th></th> <th></th> </tr> </thead> <tbody> <tr> <td>○</td> <td></td> <td></td> <td>P</td> <td></td> <td></td> </tr> <tr> <td></td> <td></td> <td></td> <td>M</td> <td>T3310</td> <td></td> </tr> <tr> <td></td> <td></td> <td></td> <td>K</td> <td></td> <td></td> </tr> <tr> <td></td> <td></td> <td></td> <td>N</td> <td></td> <td></td> </tr> <tr> <td>●</td> <td>●</td> <td></td> <td>S</td> <td>T3310</td> <td>T3310</td> </tr> <tr> <td></td> <td></td> <td></td> <td>H</td> <td></td> <td></td> </tr> </tbody> </table>	F	M	R				○			P						M	T3310					K						N			●	●		S	T3310	T3310				H		
F	M	R																																											
○			P																																										
			M	T3310																																									
			K																																										
			N																																										
●	●		S	T3310	T3310																																								
			H																																										



.F44

TORNITURA 1,5XD
TURNING 1,5XD

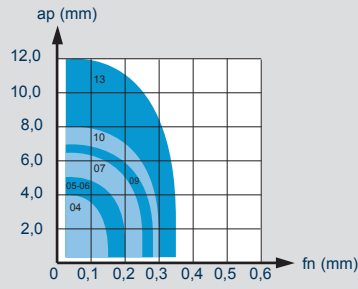

TORNITURA 2,25XD
TURNING 2,25XD

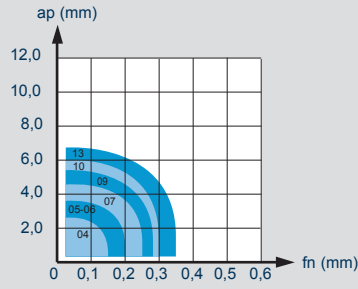

FORATURA
DRILLING

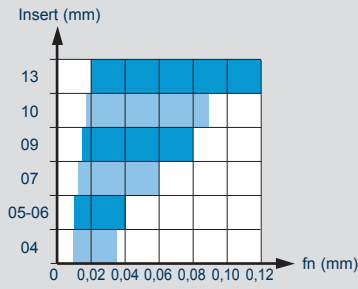

			○	○	⊗	
F	M	R	P	T1225	T1225	T1225
●	●		M	T1225-F2430	T1225-F2430	T1225-F2430
●	●		K			
			N			
○	○		S	F2430	F2430	
			H			



.F47P

TORNITURA 1,5XD
TURNING 1,5XD

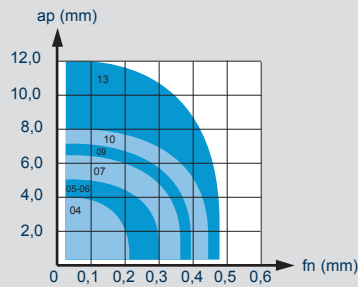

TORNITURA 2,25XD
TURNING 2,25XD

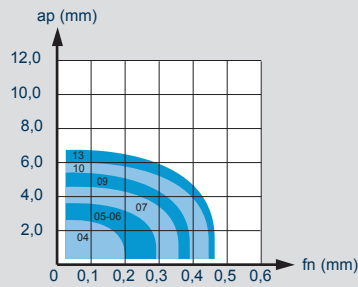

FORATURA
DRILLING

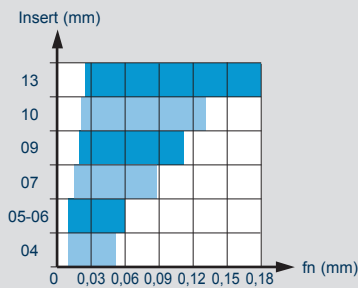

			○	○	⊗	
F	M	R	P			
			M			
●	●		K			
			N	N3015	N3015	
			S			
			H			

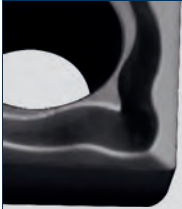

**.N53
.N54
.Z54**

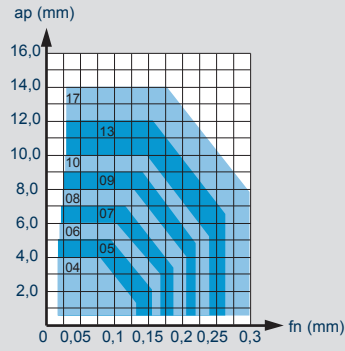

			○	○	⊗	
F	M	R	P	F5120-F7035	F5120-F7035	F5120-F7035
●	●	○	M	F5120-T2330-F7035	F5120-T2330-F7035	F5120-T2330-F7035
●	●	○	K	F5120-T516-7035	F5120-T516-7035	F5120-T516-7035
○	○	○	N	F7035	F7035	F7035
○	○	○	S	F7035	F7035	F7035
			H			



.N57P

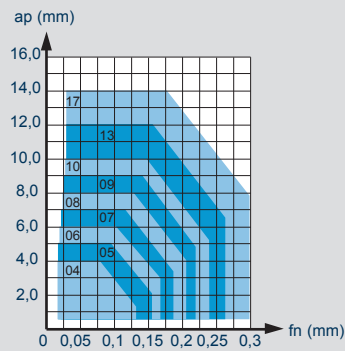

			○	○	⊗	
F	M	R	P			
			M			
			K			
●	●	○	N	N3610	N3610	N3610
			S			
			H			

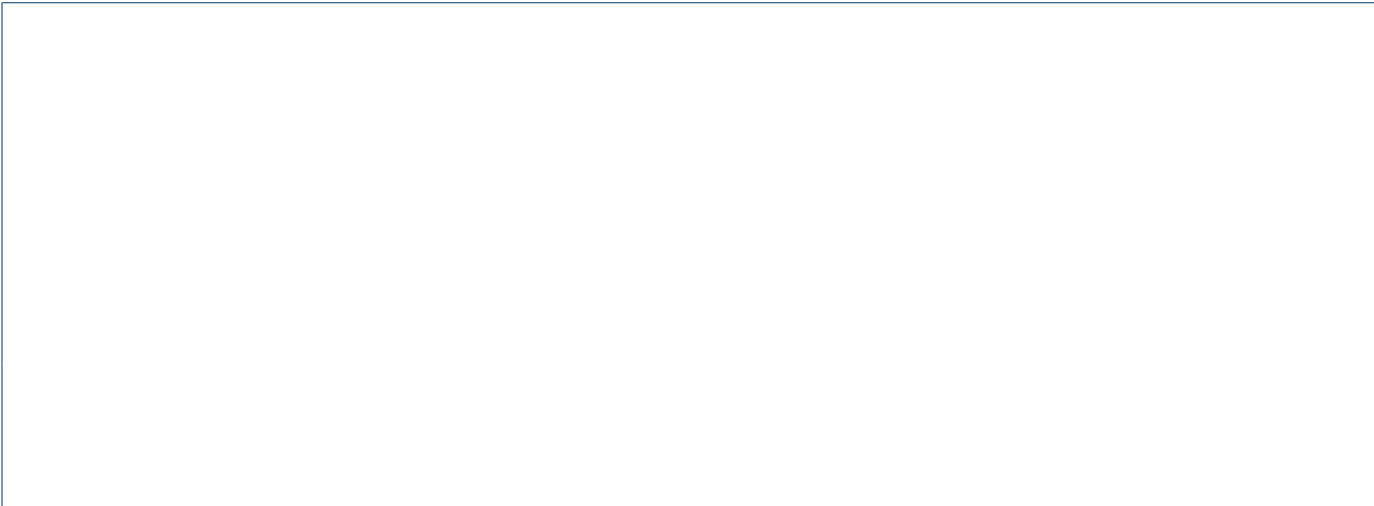

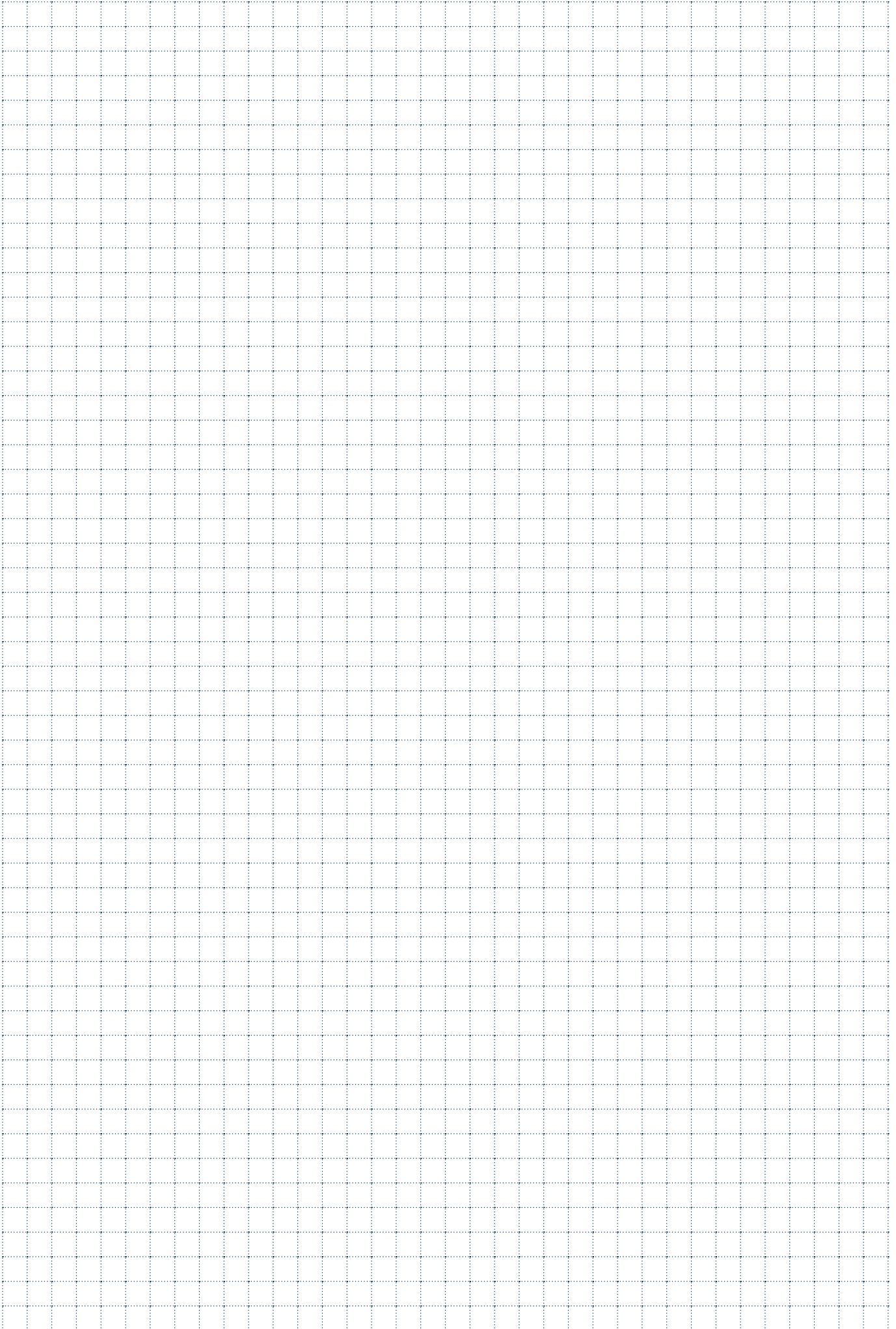











FILETTATURA

THREADING / GEWINDEDREHEN / FILETAGE / ROSCADO









	MASCHIATURA	
	TAPPING	
	SCHNEIDSCHRAUBE	
	TAPEMENT	
	ATERRAJADURA	







Pag. 729

	FRESE A FILETTARE	
	THREADING MILLS	
	GEWINDEFÄSER	
	FRAISES A FILETER	
	FRESAS PARA ROSCAR	



Pag. 811

	UTENSILI PER FILETTATURA	
	TOOLS FOR THREADING	
	WERKZEUGE ZUM GEWINDEDREHEN	
	OUTILS POUR FILETAGE	
	HERRAMIENTAS PARA ROSCADO	



























Pag. 829





	UTENSILI ISO 26623-1 PER FILETTATURA ESTERNA ED INTERNA	
	ISO 26623-1 EXTERNAL AND INTERNAL THREADING TOOLS	
	ISO 26623-1 AUSSEN- UND INNENGEWINDE-DREHWERKZEUGE	
	OUTILS ISO 26623-1 POUR FILETAGE EXTERNE ET INTERNE	
	HERRAMIENTAS ISO 26623-1 PARA ROSCADO EXTERIOR E INTERIOR	

Pag. 837

	INSERTI PER FILETTATURA	
	THREADING INSERTS	
	WENDEPLATTEN ZUM GEWINDESCHNEIDEN	
	PLAQUÉTTES DE FILETAGE	
	PLAQUITAS DE ROSCADO	

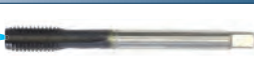
Pag. 841

			ART.	DIMENSIONE FILETTO THREAD SIZE	LUNGHEZZA FILETTO THREAD LENGTH	ANGOLO ELICA ANGLE FLUTES	MATERIALE MATERIAL	Materiali - Materials Pag. 1199						Pag.	
								P	M	K	N	S	H		
	VP		MSA107..VP M..	2-52	3xD	0°	HSSE	●				○			734
	VP		MSA407..VP M..	2-52	2,5xD	40°	HSSE	●				○			735
	TIN		MSA107..TN M..	3-30	3xD	0°	HSSE	●							736
	TIN		MSA407..TN M..	3-30	2,5xD	40°	HSSE	●							737
	TT		MSU02007..STN M..	3-24	3xD	0°	PM3	●	●	●	●	●			738
	TT		MSU15007..STN M..	3-30	3xD	45°	PM3	●	●	●	●	○			739
	TT		MSU15007..STNW M..	6-30	3,5xD	45°	PM3	●	●	●	●	○			740
	TIN		MSA20XLTC.. M..	4-16	3xD	0°	HSSE	●				○	○		741
	TICN		MSA40XLTC.. M..	4-16	2,5xD	40°	HSSE	●				○	○		742
	TIALN + C		MSR207..TL M..	3-16	3xD	0°	PM3		●			○			743
	TIALN + C		MSR307..TB M..	3-16	1,5xD	15°	PM3		●			○			744
	TIALN + C		MSR407..TL M..	3-16	2,5xD	40°	PM3	○	●			○			745
	TIALN + C		MSI207..TB M..	3-24	3xD	0°	HSSV3	●		●					746
	TIALN + C		MSI407..TB M..	3-16	3,5xD	48°	HSSV3	●		●					747
	SNS		MSG107..SNS M..	3-24	3xD	0°	HSSE				●	○			748
	TIALN		MSG01007..TL M..	4-24	3xD	0°	PM3				●	○			749
	TIALN		MSG01007..TLW M..	6-24	3,5xD	0°	PM3				●	○			750
	TIALN		MSG18007..TL M..	6-24	3xD	0°	PM3				●	○			751
	TIALN		MSG18007..TLW M..	6-24	3,5xD	0°	PM3				●	○			752
	VX		MSN107..VP M..	3-16	3xD	0°	HSSE						●		753
	VX		MSN407..VP M..	3-16	3xD	45°	HSSE						●		754
	TICN		MST807..TC M..	3-16	3xD	15°	PM3							●	755
	TICN		MST307..TC M..	3-16	1,5xD	15°	PM3							●	756
	TIN		MSA507..TN M..	3-12	3xD	-	PM3	●	○	●		●	●		757

		ART.	DIMENSIONE FILETTO THREAD SIZE	LUNGHEZZA FILETTO THREAD LENGTH	ANGOLO ELICA ANGLE FLUTES	MATERIALE MATERIAL	Materiali - Materials Pag. 1199						Pag.
							P	M	K	N	S	H	
FILETTATURA (M) - THREAD (M)													
	TIN	 MSK06007..TG M..	3-16	3xD	-	PM8	○	●	●	○	●	758	
FILETTATURA (M) / GAMBO h6 - THREAD (M) / h6 SHANK													
		 MSG0100NITBW-h6 M..	6-20	3,5xD	0°	PM3	●		●			760	
FILETTATURA (MF) - THREAD (MF)													
	VP	 MSA217..VP MF..	4-24	3xD	0°	HSEE	●			○		762	
	VP	 MSA417..VP MF..	4-24	2,5xD	40°	HSEE	●			○		763	
	TT	 MSU020174STN MF..	8-24	3xD	0°	PM3	●	●	●	●		764	
	TT	 MSU150174STN MF..	8-24	3xD	45°	PM3	●	●	●	○		765	
	TT	 MSU150174STNW MF..	8-24	3,5xD	45°	PM3	●	●	●	○		766	
	TIALN C	 MSI2174TB MF..	8-24	3xD	0°	HSSV3	●		●			767	
	TIALN C	 MSI4174TB MF..	8-24	3xD	48°	HSSV3	○		●			768	
	SNS	 MSG117..SNS MF..	8-30	3xD	0°	HSSV3			●	○		769	
	TIALN	 MSG010174TL MF..	8-24	3xD	0°	PM3			●	○		770	
	TIALN	 MSG010174TLW MF..	8-24	3,5xD	0°	PM3			●	○		771	
FILETTATURA (UNC) - THREAD (UNC)													
	VP	 MSA2376VP UNC..	1/4-1"	3xD	0°	HSSV3	●			○		774	
	VP	 MSA4376VP UNC..	1/4-1"	2,5xD	40°	HSSV3	●			○		775	
	TT	 MSU02037..STN UNC..	4-1"	3xD	0°	PM3	●	●	●	●		776	
	TT	 MSU15037..STN UNC..	4-1"	3xD	45°	PM3	●	●	●	○		777	
	TT	 MSU15037..STNW UNC..	1/4-1"	3,5xD	45°	PM3	●	●	●	○		778	
	TIALN C	 MSI02037..TB UNC..	1/4-5/8	3xD	0°	HSSV3	●		●			779	
	TIALN C	 MSI16037..TB UNC..	1/4-5/8	3,5xD	48°	HSSV3	●		●			780	
	SNS	 MSG1376SNS UNC..	5/16-1"	3xD	0°	HSSE			●	○		781	

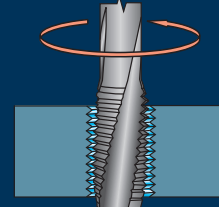
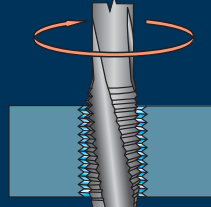
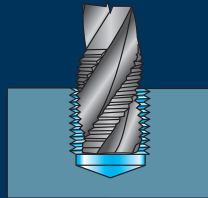
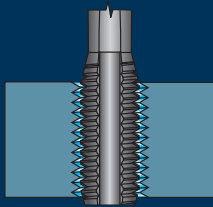

				ART.	DIMENSIONE FILETTO THREAD SIZE	LUNGHEZZA FILETTO THREAD LENGTH	ANGOLO ELICA ANGLE FLUTES	MATERIALE MATERIALE	Materiali - Materials Pag. 1199						Pag.
									P	M	K	N	S	H	
FILETTATURA (UNF) - THREAD (UNF)															
	VP		MSA2474VP UNF..	1/4-1"	3xD	0°	HSSE	●				○		784	
	VP		MSA4474VP UNF..	1/4-1"	2,5xD	40°	HSSE	●				○		785	
	TT		MSU02047..STN UNF..	4-1"	3xD	0°	PM3	●	●	●	●	●		786	
	TT		MSU15047..STN UNF..	4-1"	3xD	45°	PM3	●	●	●	●	○		787	
	TT		MSU15047..STNW UNF..	1/4-1"	3,5xD	45°	PM3	●	●	●	●	○		788	
	TIALN + C		MSI02047..TB UNF..	1/4-5/8	3xD	0°	HSSV3	●		●				789	
	TIALN + C		MSI16047..TB UNF..	1/4-5/8	3,5xD	48°	HSSV3	●		●				790	
	SNS		MSG1474SNS UNF..	1/4-1"	3xD	0°	HSSE				●	○		791	
FILETTATURA (GAS) - THREAD (GAS)															
	VP		MSA2256VP G..	1/8-1"	3xD	0°	HSSE	●				○		794	
	VP		MSA4256VP G..	1/8-1"	2,5xD	40°	HSSE	●				○		795	
	TT		MSU020256STN G..	1/8-3/4	3xD	0°	PM3	●	●	●	●	●		796	
	TT		MSU150256STN G..	1/8-1"	3xD	45°	PM3	●	●	●	●	○		797	
	TT		MSU150256STNW G..	1/8-1"	3,5xD	45°	PM3	●	●	●	●	○		798	
	TIALN + C		MSI020256TB G..	1/8-3/4	3xD	0°	HSSV3	●		●				799	
	TIALN + C		MSI160256TB G..	1/8-1"	3,5xD	48°	HSSV3	●		●				800	
	SNS		MSG1256SNS G..	1/8-1"	3xD	0°	HSSE				●	○		801	
	TIN		MSK180256TG G..	1/8-1"	3xD	-	PM8	○	●	●		○	●	802	
FILETTATURA (NPT/NPTF) - THREAD (NPT/NPTF)															
	-		MSA15LNBR NPT..	1/8-1"	-	0°	HSSE	●						804	
	-		MSA16LNBR NPTF..	1/8-1"	-	0°	HSSE	●						805	
FILETTATURA (EG M) - THREAD (EG M)															
	TT		MSA40EGSTN M..	3-16	2,5xD	40°	HSSE	●				●		808	
DISTRUGGI MASCHI - TAP DESTROYING TOOL															
	TIN		SKR01M..	3,3-17,5	-	0°	-	-	-	-	-	-	-	810	

SIMBOLOGIA - SYMBOL - SYMBOLE - SYMBOLES

RIVESTIMENTI - COATED - BESCHICHTUNG - RECOUVREMENT

RIVESTIM. COATED SNS	TiCN: Indicata per la filettatura di materiali abrasivi (Ghisa Grigia) e su bronzo a truciolo corto. Autolubrificante. tenacità alta con coefficiente d'attrito molto basso (0,1) TiCN: Suitable for thread cutting of abrasive materials. (Grey cast iron) and on bronze at short shaving. Self lubricating. High toughness with very low coefficient of friction (0,1)	RIVESTIM. COATED VP	Vaporizzazione: Lo strato di Ossido di Ferro è molto tenace e favorisce, con la sua porosità, la lubrificazione tratteneo l'olio da taglio. Si evita così il grippaggio, a bassa/media velocità. Steam tempering: The layer of Iron Oxide is very tough and its porosity improves lubrication, holding the cutting oil. This avoids seizures at low to medium speeds.
RIVESTIM. COATED TiCN	TiCN: Durezza: 3000HV; t°max:450°C; Coeff. Attrito: 0,3 Maggiore resistenza all'usura rispetto al TiN, indicato per lavorazioni con elevato sviluppo di calore. Adatto alla lavorazione di ghisa a medio-alte velocità. TiCN: Hardness: 300HV; max t°:450 °C; friction coefficient: 0,3. Better resistance to usin comparison to TiN, suitable for working with higher heat development. Suitable for working with cast iron at medium to high speeds.	RIVESTIM. COATED VX	Vaporizzazione Super: Evoluzione della classica vaporizzazione. Trova applicazione su alluminio a basso contenuto di silicio, acciai dolci e materiali teneri. Super vaporization: Evolution of traditional vaporization. Suitable for low-silicon aluminium, mild steel and soft materials.
RIVESTIM. COATED TiAlN+C	TiAlN + Carbon: Rivestimento adatto allo scorrimento del truciolo, resistente all'usura e all'ossidazione, adatto per la lavorazione di acciaio inox e alluminio con alto contenuto di silicio, consigliato per maschiatura di fori ciechi profondi. TiAlN + Carbon: Coating ideal for the chip to slide over, wear and oxidation resistant, suitable for machining stainless steel and aluminium with a high silicon content, recommended for tapping deep blind holes.	RIVESTIM. COATED TiN	TiN: Durezza: 2500HV; t°max:500°C; Coeff. Attrito: 0,4 Quindi alta resistenza all'usura con velocità di taglio sensibilmente più alte e miglior produzione e risultati. TiN: Hardness: 2500HV; max t°:500 °C; friction coefficient: 0,4. Therefore high resistance to use at slightly higher cutting speeds and better production and results.
RIVESTIM. COATED TiAlN	TiAlN: Rivestimento resistente all'usura e all'ossidazione, adatto per lavorazioni di materiali abrasivi (ghisa), lavorazioni a secco e per alte velocità di taglio. TiAlN: Wear and oxidation resistant coating suitable for machining abrasive materials (cast iron), dry machining and for high cutting speeds.	RIVESTIM. COATED Tt	TiN + TiAlN: Nuovo rivestimento resistente all'usura (favorisce lo scorrimento del truciolo), adatto per lavorazioni di acciai basso legati, consigliato per maschiatura compensata. TiN + TiAlN: New wear resistant coating (makes it easier for the chip to slide over), suitable for machining low-alloy steels, recommended for offset tapping

IMBOCCO - CHAMFER - ANSCHNITT - ENTREE

2-3 FILL	2,5 - 3 Filetti d'imbocco. 2,5 - 3 Lead-in threads	4-5 FILL	4 - 5 Filetti d'imbocco. 4 - 5 Lead-in threads
1,5-2 FILL	1,5 - 2 Filetti d'imbocco. (Imbocco corto) 1,5 - 2 Lead-in threads (Short Lead-in)		

ADDUZIONE REFRIGERANTE - COOLING ADDUCTION KÜHLMITTELZUFUHR - AMENEE REFRIGERANT

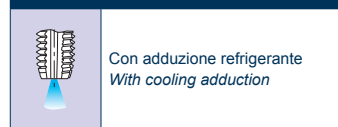

Con adduzione refrigerante
With cooling adduction

CLASSE - CLASS - KLASSE - CLASSE

HSSE	Acciaio HSSE con 5% di Cobalto impiegato per materiali da lavorare con R ≤ 800 N/mm ² HSSE steel with 5% of Cobalt used for materials to work with R ≤ 800 N/mm²	HSSV3	Acciaio HSSV3 con alta percentuale di vanadio impiegato per materiali da lavorare con R<1000 N/mm ² HSSV3 steel with high percentage of vanadium used for materials to be machined with R<1000 N/mm²
PM3	Acciaio PM sinterizzato ad alto contenuto di Vanadio e Cobalto impiegato per materiali da lavorare con R>1200 N/mm ² Sintered PM steel of a high Vanadium and cobalt content used for materials to work with R>1200 N/mm²	PM8	Acciaio PM sinterizzato ad alto contenuto di Vanadio e Cobalto impiegato per materiali da lavorare con R>1000 N/mm ² Sintered PM steel of a high Vanadium and cobalt content used for materials to work with R>1000 N/mm²

TOLLERANZE - TOLERANCE - TOLERANZEN - TOLÉRANCE

TOLL 6HX	Tolleranza 6HX 6HX Tolerance	TOLL 2BX	Tolleranza 2BX 2BX Tolerance
TOLL ISO2 6H	Tolleranza ISO2 6H ISO2 6H Tolerance	TOLL ISO 228	Tolleranza ISO228 ISO228 Tolerance
TOLL 6H mod	Tolleranza 6H mod 6H mod Tolerance	TOLL ISO 228"X"	Tolleranza ISO 228"X" ISO 228"X" Tolerance
TOLL 2B	Tolleranza 2B 2B Tolerance		

TIPO DI FORI DA LAVORARE - TYPE OF HOLES TO BE MACHINED ZU BEARBEITENDE BOHRUNGSTYPEN - TYPE DE TROUS A USINER

	Foro Cieco/Passante Dead/Through hole		Foro Passante Through hole
	Foro Cieco Dead hole		Foro Passante/Cieco profondo Through/Deep dead hole
	Foro Cieco profondo Deep dead hole		

ANGOLO ELICA - FLUTES DEGREES - SPIRALWINKEL - ANGLE HELICE

	15°		15° - elica sinistra 15° - left helice
	40°		45°
	48°		0°
	0° - Imbocco corretto 0° - Correct lead-in		0° - GAS Conico (NPT/NPTF) 0° - GAS Tapered (NPT/NPTF)

CONICITÀ - TAPER KONUS - CONICITÉ

	Conicità Taper
1:16	

APPLICAZIONE CONSIGLIATA - RECOMMENDED APPLICATION EMPFOHLENE ANWENDUNG - APPLICATION CONSEILLEE

	Maschiatura rigida sincronizzata Synchronized rigid tapping		Calettamento Termico Shrinking Fit		Esecuzione a rullare Execution to be rolled
--	--	--	---------------------------------------	--	--



FILETTATURA METRICA ISO PASSO GROSSO (M)

ISO METRIC COARSE SCREW THREAD (M)
GEWINDESCHNEIDEN - METRISCHE ISO GROBGEWINDE (M)
FILETAGE METRIQUE ISO PAS GROS (M)
ROSCA MÉTRICA ISO DE PASO GRUESO (M)

**MSA1071VP M..
 MSA1076VP M..**

M 2 - 52

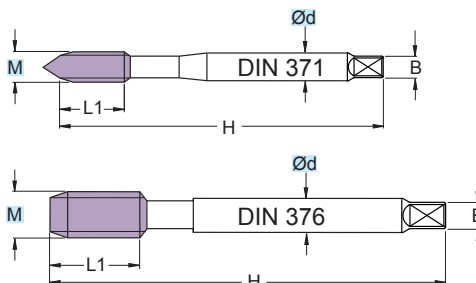
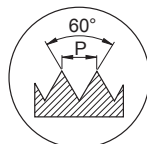

RIVESTIM.
 COATED
VP

HSSE

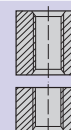

**4-5
 FILL**

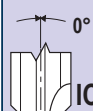

**TOLL
 ISO2
 6H**

DIN 371		(mm)						Preforo Prebore
ART.	M	P	Ød	L1	H	B		
MSA1071VP M2	2	0,4	2,8	9	45	2,1	1,6	
MSA1071VP M3	3	0,5	3,5	10	56	2,7	2,5	
MSA1071VP M4	4	0,7	4,5	13	63	3,4	3,3	
MSA1071VP M5	5	0,8	6	13	70	4,9	4,2	
MSA1071VP M6	6	1	6	16	80	4,9	5	
MSA1071VP M8	8	1,25	8	18	90	6,2	6,8	
MSA1071VP M10	10	1,5	10	20	100	8	8,5	

DIN 376		(mm)						Preforo Prebore
ART.	M	P	Ød	L1	H	B		
MSA1076VP M12	12	1,75	9	25	110	7	10,3	
MSA1076VP M14	14	2	11	28	110	9	12	
MSA1076VP M16	16	2	12	28	110	9	14	
MSA1076VP M18	18	2,5	14	33	125	11	15,5	
MSA1076VP M20	20	2,5	16	33	140	12	17,5	
MSA1076VP M22	22	2,5	18	33	140	14,5	19,5	
MSA1076VP M24	24	3	18	39	160	14,5	21	
MSA1076VP M27	27	3	20	39	160	16	24	
MSA1076VP M30	30	3,5	22	46	180	18	26,5	
MSA1076VP M33	33	3,5	25	46	180	20	29,5	
MSA1076VP M36	36	4	28	50	200	22	32	
MSA1076VP M39	39	4	32	50	200	24	35	
MSA1076VP M42	42	4,5	32	55	200	24	37,5	
MSA1076VP M45	45	4,5	36	60	220	29	40,5	
MSA1076VP M48	48	5	36	65	250	29	43	
MSA1076VP M52	52	5	40	65	250	32	47	

PARAMETRI - PARAMETERS

MATERIALI - MATERIALS Pag. 1199			Vc m/min
P	ACCIAIO - STEEL	●	10-15
	ACCIAIO AD ALTA RESISTENZA - HIGH-RESISTANCE STEEL		
M	ACCIAIO INOX - STAINLESS STEEL		
K	GHISA - CAST IRON		
N	ALLUMINIO E SUE LEGHE - ALUMINIUM	○	10-20
S	LEGHE RESIST. CALORE - HIG. TEMP. ALLOY		
H	MAT. DURI E TEMPRATI - HARD AND HARDENED MATERIAL		

Vc = m/min VELOCITÀ DI TAGLIO - CUTTING SPEED

MSA4071VP M..
MSA4076VP M..

M 2 - 52

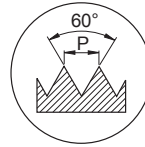

RIVESTIM.
 COATED
VP **HSSE**

2-3 FILL

TOLL ISO2 6H

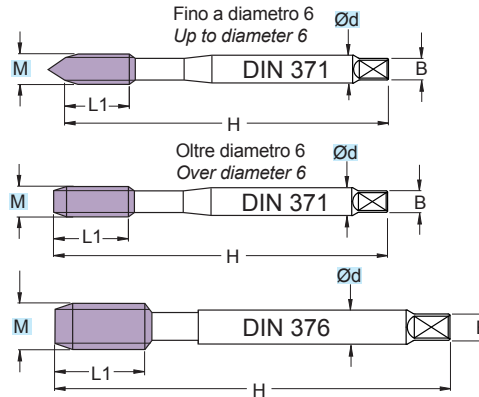

DIN 371		(mm)						Preforo Prebore
ART.	M	P	Ød	L1	H	B		
MSA4071VP M2	2	0,4	2,8	9	45	2,1	1,6	
MSA4071VP M3	3	0,5	3,5	5	56	2,7	2,5	
MSA4071VP M4	4	0,7	4,5	7	63	3,4	3,3	
MSA4071VP M5	5	0,8	6	8	70	4,9	4,2	
MSA4071VP M6	6	1	6	10	80	4,9	5	
MSA4071VP M8	8	1,25	8	13	90	6,2	6,8	
MSA4071VP M10	10	1,5	10	15	100	8	8,5	

DIN 376		(mm)						Preforo Prebore
ART.	M	P	Ød	L1	H	B		
MSA4076VP M12	12	1,75	9	18	110	7	10,3	
MSA4076VP M14	14	2	11	20	110	9	12	
MSA4076VP M16	16	2	12	20	110	9	14	
MSA4076VP M18	18	2,5	14	25	125	11	15,5	
MSA4076VP M20	20	2,5	16	25	140	12	17,5	
MSA4076VP M22	22	2,5	18	25	140	14,5	19,5	
MSA4076VP M24	24	3	18	30	160	14,5	21	
MSA4076VP M27	27	3	20	30	160	16	24	
MSA4076VP M30	30	3,5	22	35	180	18	26,5	
MSA4076VP M33	33	3,5	25	35	180	20	29,5	
MSA4076VP M36	36	4	28	40	200	22	32	
MSA4076VP M39	39	4	32	40	200	24	35	
MSA4076VP M42	42	4,5	32	40	200	24	37,5	
MSA4076VP M45	45	4,5	36	50	220	29	40,5	
MSA4076VP M48	48	5	36	50	250	29	43	
MSA4076VP M52	52	5	40	50	250	32	47	

PARAMETRI - PARAMETERS

MATERIALI - MATERIALS Pag. 1199			Vc m/min
P	ACCIAIO - STEEL	●	10-15
	ACCIAIO AD ALTA RESISTENZA - HIGH-RESISTANCE STEEL		
M	ACCIAIO INOX - STAINLESS STEEL		
K	GHISA - CAST IRON		
N	ALLUMINIO E SUE LEGHE - ALUMINIUM	○	10-20
S	LEGHE RESIST. CALORE - HIG. TEMP. ALLOY		
H	MAT. DURI E TEMPRATI - HARD AND HARDENED MATERIAL		

PAG. 1172

Vc = m/min VELOCITÀ DI TAGLIO - CUTTING SPEED

MSA1071TN M..
MSA1076TN M..

M 3 - 30

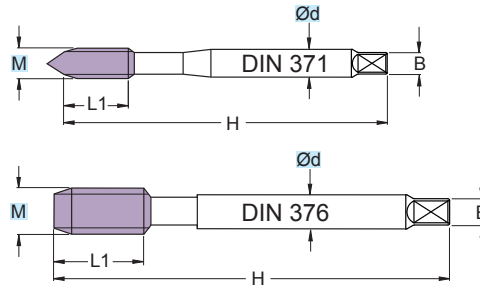
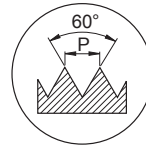

RIVESTIM.
 COATED
TIN

HSSE

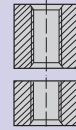

**4-5
 FILL**

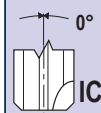

**TOLL
 ISO2
 6H**

DIN 371		(mm)						Preforo Prebore
ART.	M	P	Ød	L1	H	B		
MSA1071TN M3	3	0,5	3,5	10	56	2,7	2,5	
MSA1071TN M4	4	0,7	4,5	13	63	3,4	3,3	
MSA1071TN M5	5	0,8	6	13	70	4,9	4,2	
MSA1071TN M6	6	1	6	16	80	4,9	5	
MSA1071TN M8	8	1,25	8	18	90	6,2	6,8	
MSA1071TN M10	10	1,5	10	20	100	8	8,5	

DIN 376		(mm)						Preforo Prebore
ART.	M	P	Ød	L1	H	B		
MSA1076TN M12	12	1,75	9	25	110	7	10,3	
MSA1076TN M14	14	2	11	28	110	9	12	
MSA1076TN M16	16	2	12	28	110	9	14	
MSA1076TN M18	18	2,5	14	33	125	11	15,5	
MSA1076TN M20	20	2,5	16	33	140	12	17,5	
MSA1076TN M22	22	2,5	18	33	140	14,5	19,5	
MSA1076TN M24	24	3	18	39	160	14,5	21	
MSA1076TN M27	27	3	20	39	160	16	24	
MSA1076TN M30	30	3,5	22	46	180	18	26,5	

PARAMETRI - PARAMETERS

MATERIALI - MATERIALS Pag. 1199			Vc m/min
P	ACCIAIO - STEEL	●	20-30
	ACCIAIO AD ALTA RESISTENZA - HIGH-RESISTANCE STEEL		
M	ACCIAIO INOX - STAINLESS STEEL		
K	GHISA - CAST IRON		
N	ALLUMINIO E SUE LEGHE - ALUMINIUM		
S	LEGHE RESIST. CALORE - HIG. TEMP. ALLOY		
H	MAT. DURI E TEMPRATI - HARD AND HARDENED MATERIAL		

MSA4071TN M..
MSA4076TN M..

M 3 - 30

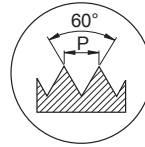

RIVESTIM. COATED
TIN **HSSE**

2-3 FILL

TOLL ISO2 6H

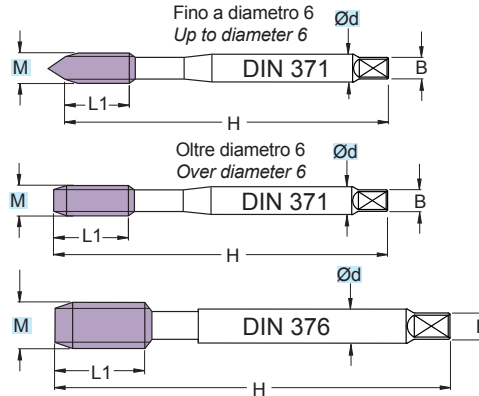

DIN 371		(mm)						
ART.	M	P	Ød	L1	H	B	Preforo Prebore	
MSA4071TN M3	3	0,5	3,5	5	56	2,7	2,5	
MSA4071TN M4	4	0,7	4,5	7	63	3,4	3,3	
MSA4071TN M5	5	0,8	6	8	70	4,9	4,2	
MSA4071TN M6	6	1	6	10	80	4,9	5	
MSA4071TN M8	8	1,25	8	13	90	6,2	6,8	
MSA4071TN M10	10	1,5	10	15	100	8	8,5	

DIN 376		(mm)						
ART.	M	P	Ød	L1	H	B	Preforo Prebore	
MSA4076TN M12	12	1,75	9	18	110	7	10,3	
MSA4076TN M14	14	2	11	20	110	9	12	
MSA4076TN M16	16	2	12	20	110	9	14	
MSA4076TN M18	18	2,5	14	25	125	11	15,5	
MSA4076TN M20	20	2,5	16	25	140	12	17,5	
MSA4076TN M22	22	2,5	18	25	140	14,5	19,5	
MSA4076TN M24	24	3	18	30	160	14,5	21	
MSA4076TN M27	27	3	20	30	160	16	24	
MSA4076TN M30	30	3,5	22	35	180	18	26,5	

PARAMETRI - PARAMETERS

MATERIALI - MATERIALS Pag. 1199			Vc m/min
P	ACCIAIO - STEEL	●	20-30
	ACCIAIO AD ALTA RESISTENZA - HIGH-RESISTANCE STEEL		
M	ACCIAIO INOX - STAINLESS STEEL		
K	GHISA - CAST IRON		
N	ALLUMINIO E SUE LEGHE - ALUMINIUM		
S	LEGHE RESIST. CALORE - HIG. TEMP. ALLOY		
H	MAT. DURI E TEMPRATI - HARD AND HARDENED MATERIAL		

PAG. 1172

Vc = m/min VELOCITÀ DI TAGLIO - CUTTING SPEED

MSU020071STN M..
MSU020076STN M..

M 3 - 24

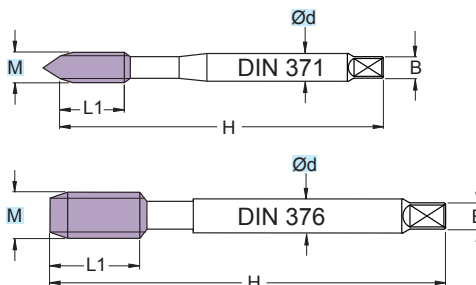
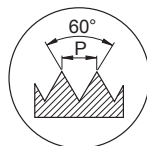

RIVESTIM. COATED TT	PM3
	4-5 FILL
	TOLL 6HX

DIN 371		(mm)						Preforo Prebore
ART.	M	P	Ød	L1	H	B		
MSU020071STN M3	3	0,5	3,5	10	56	2,7	2,5	
MSU020071STN M4	4	0,7	4,5	13	63	3,4	3,3	
MSU020071STN M5	5	0,8	6	13	70	4,9	4,2	
MSU020071STN M6	6	1	6	16	80	4,9	5	
MSU020071STN M8	8	1,25	8	18	90	6,2	6,8	
MSU020071STN M10	10	1,5	10	20	100	8	8,5	

DIN 376		(mm)						Preforo Prebore
ART.	M	P	Ød	L1	H	B		
MSU020076STN M12	12	1,75	9	25	110	7	10,3	
MSU020076STN M14	14	2	11	28	110	9	12	
MSU020076STN M16	16	2	12	28	110	9	14	
MSU020076STN M18	18	2,5	14	33	125	11	15,5	
MSU020076STN M20	20	2,5	16	33	140	12	17,5	
MSU020076STN M22	22	2,5	18	33	140	14,5	19,5	
MSU020076STN M24	24	3	18	39	160	14,5	21	

PARAMETRI - PARAMETERS

MATERIALI - MATERIALS Pag. 1199			Vc m/min
P	ACCIAIO - STEEL	●	15-30
	ACCIAIO AD ALTA RESISTENZA - HIGH-RESISTANCE STEEL	●	5-12
M	ACCIAIO INOX - STAINLESS STEEL	●	6-15
K	GHISA - CAST IRON	●	10-20
N	ALLUMINIO E SUE LEGHE - ALUMINIUM	●	20-30
S	LEGHE RESIST. CALORE - HIG. TEMP. ALLOY		
H	MAT. DURI E TEMPRATI - HARD AND HARDENED MATERIAL		

MSU150071STN M..
MSU150076STN M..

M 3 - 30

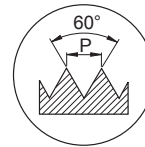

RIVESTIM. COATED TT	PM3
	2-3 FILL
	TOLL 6HX
	SINCRO

○ = RASTREMAZIONE - TAPER

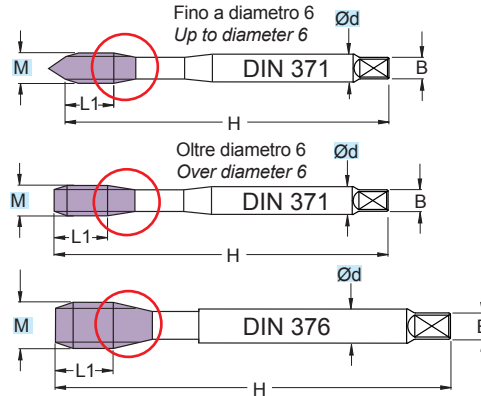

DIN 371		(mm)						Preforo Prebore
ART.	M	P	Ød	L1	H	B		
MSU150071STN M3	3	0,5	3,5	5	56	2,7	2,5	
MSU150071STN M4	4	0,7	4,5	7	63	3,4	3,3	
MSU150071STN M5	5	0,8	6	8	70	4,9	4,2	
MSU150071STN M6	6	1	6	10	80	4,9	5	
MSU150071STN M8	8	1,25	8	13	90	6,2	6,8	
MSU150071STN M10	10	1,5	10	15	100	8	8,5	

DIN 376		(mm)						Preforo Prebore
ART.	M	P	Ød	L1	H	B		
MSU150076STN M12	12	1,75	9	18	110	7	10,3	
MSU150076STN M14	14	2	11	20	110	9	12	
MSU150076STN M16	16	2	12	20	110	9	14	
MSU150076STN M18	18	2,5	14	25	125	11	15,5	
MSU150076STN M20	20	2,5	16	25	140	12	17,5	
MSU150076STN M22	22	2,5	18	25	140	14,5	19,5	
MSU150076STN M24	24	3	18	30	160	14,5	21	
MSU150076STN M27	27	3	20	30	160	16	24	
MSU150076STN M30	30	3,5	22	35	180	18	26,5	

- PER MAGGIORI PRESTAZIONI SI CONSIGLIA MASCHIATURA SINCRONIZZATA
- FOR HIGHER PERFORMANCE WE RECOMMEND SYNCHRONIZED TAPPING
- FÜR HÖHERE LEISTUNGEN EMPFIEHLT SICH SYNCHRONISIERTES GEWINDESCHNEIDEN
- POUR PLUS DE PERFORMANCES IL EST CONSEILLE UN TARAUDAGE SYNCHRONISE

PARAMETRI - PARAMETERS

MATERIALI - MATERIALS Pag. 1199			Vc m/min
P	ACCIAIO - STEEL	●	15-30
	ACCIAIO AD ALTA RESISTENZA - HIGH-RESISTANCE STEEL	●	5-12
M	ACCIAIO INOX - STAINLESS STEEL	●	6-15
K	GHISA - CAST IRON	●	10-20
N	ALLUMINIO E SUE LEGHE - ALUMINIUM	○	20-30
S	LEGHE RESIST. CALORE - HIG. TEMP. ALLOY		
H	MAT. DURI E TEMPRATI - HARD AND HARDENED MATERIAL		



Vc = m/min VELOCITÀ DI TAGLIO - CUTTING SPEED

MSU150071STNW M..
MSU150076STNW M..

M 6 - 30

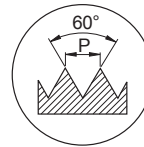

RIVESTIM. COATED TT	PM3
	2-3 FILL
	TOLL 6HX
	SINCRO

○ = RASTREMAZIONE - TAPER

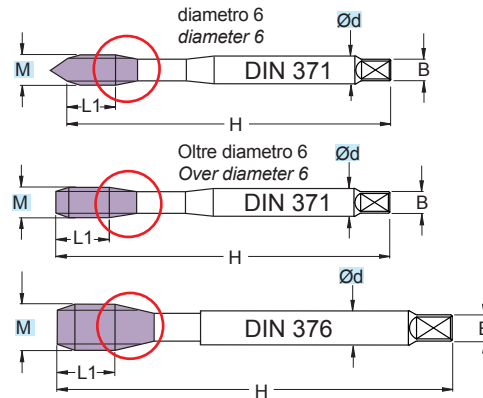

DIN 371		(mm)						Preforo Prebore
ART.	M	P	Ød	L1	H	B		
MSU150071STNW M6	6	1	6	10	80	4,9	5	
MSU150071STNW M8	8	1,25	8	13	90	6,2	6,8	
MSU150071STNW M10	10	1,5	10	15	100	8	8,5	

DIN 376		(mm)						Preforo Prebore
ART.	M	P	Ød	L1	H	B		
MSU150076STNW M12	12	1,75	9	18	110	7	10,3	
MSU150076STNW M14	14	2	11	20	110	9	12	
MSU150076STNW M16	16	2	12	20	110	9	14	
MSU150076STNW M18	18	2,5	14	25	125	11	15,5	
MSU150076STNW M20	20	2,5	16	25	140	12	17,5	
MSU150076STNW M22	22	2,5	18	25	140	14,5	19,5	
MSU150076STNW M24	24	3	18	30	160	14,5	21	
MSU150076STNW M27	27	3	20	30	160	16	24	
MSU150076STNW M30	30	3,5	22	35	180	18	26,5	

- PER MAGGIORI PRESTAZIONI SI CONSIGLIA MASCHIATURA SINCRONIZZATA
- FOR HIGHER PERFORMANCE WE RECOMMEND SYNCHRONIZED TAPPING
- FÜR HÖHERE LEISTUNGEN EMPFIEHLT SICH SYNCHRONISIERTES GEWINDESCHNEIDEN
- POUR PLUS DE PERFORMANCES IL EST CONSEILLE UN TARAUDAGE SYNCHRONISE

PARAMETRI - PARAMETERS

MATERIALI - MATERIALS Pag. 1199			Vc m/min
P	ACCIAIO - STEEL	●	15-30
	ACCIAIO AD ALTA RESISTENZA - HIGH-RESISTANCE STEEL	●	5-12
M	ACCIAIO INOX - STAINLESS STEEL	●	6-15
K	GHISA - CAST IRON	●	10-20
N	ALLUMINIO E SUE LEGHE - ALUMINIUM	○	20-30
S	LEGHE RESIST. CALORE - HIG. TEMP. ALLOY		
H	MAT. DURI E TEMPRATI - HARD AND HARDENED MATERIAL		

Vc = m/min VELOCITÀ DI TAGLIO - CUTTING SPEED

MSA20XLTC M..

M 4 - 16

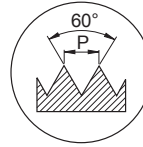

RIVESTIM. COATED
TICN **HSSE**

4-5 FILL

0°
TOLL ISO2 6H

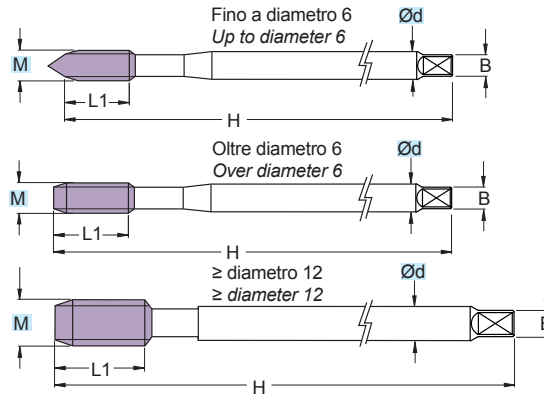

ART.	(mm)						
	M	P	Ød	L1	H	B	Preforo Prebore
MSA20XLTC M4	4	0,7	4,5	12	125	3,4	3,3
MSA20XLTC M5	5	0,8	6	14	140	4,9	4,2
MSA20XLTC M6	6	1	6	18	160	4,9	5
MSA20XLTC M8	8	1,25	8	20	180	6,2	6,8
MSA20XLTC M10	10	1,5	10	20	180	8	8,5

ART.	(mm)						
	M	P	Ød	L1	H	B	Preforo Prebore
MSA20XLTC M12	12	1,75	9	24	225	7	10,3
MSA20XLTC M14	14	2	11	26	225	9	12
MSA20XLTC M16	16	2	12	32	225	9	14

PARAMETRI - PARAMETERS

MATERIALI - MATERIALS Pag. 1199			Vc m/min
P	ACCIAIO - STEEL	●	20-30
	ACCIAIO AD ALTA RESISTENZA - HIGH-RESISTANCE STEEL		
M	ACCIAIO INOX - STAINLESS STEEL		
K	GHISA - CAST IRON	○	15-20
N	ALLUMINIO E SUE LEGHE - ALUMINIUM	○	25-30
S	LEGHE RESIST. CALORE - HIG. TEMP. ALLOY		
H	MAT. DURI E TEMPRATI - HARD AND HARDENED MATERIAL		

PAG. 1172

Vc = m/min VELOCITÀ DI TAGLIO - CUTTING SPEED

MSA40XLTC M..

M 4 - 16

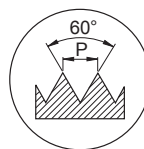

RIVESTIM.
 COATED
TICN

HSSE

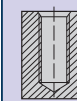

**2-3
 FILL**

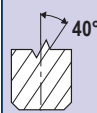

**TOLL
 ISO2
 6H**

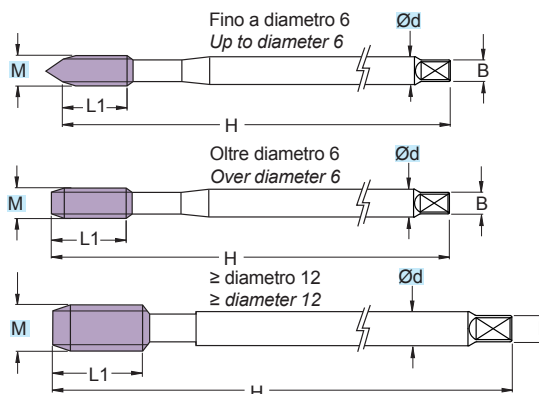

ART.	(mm)						Preforo Prebore
	M	P	Ød	L1	H	B	
MSA40XLTC M4	4	0,7	4,5	7	125	3,4	3,3
MSA40XLTC M5	5	0,8	6	8	140	4,9	4,2
MSA40XLTC M6	6	1	6	10	160	4,9	5
MSA40XLTC M8	8	1,25	8	13	180	6,2	6,8
MSA40XLTC M10	10	1,5	10	16	180	8	8,5

ART.	(mm)						Preforo Prebore
	M	P	Ød	L1	H	B	
MSA40XLTC M12	12	1,75	9	23	225	7	10,3
MSA40XLTC M14	14	2	11	23	225	9	12
MSA40XLTC M16	16	2	12	23	225	9	14

PARAMETRI - PARAMETERS

MATERIALI - MATERIALS Pag. 1199			Vc m/min
P	ACCIAIO - STEEL	●	20-30
	ACCIAIO AD ALTA RESISTENZA - HIGH-RESISTANCE STEEL		
M	ACCIAIO INOX - STAINLESS STEEL		
K	GHISA - CAST IRON	○	15-20
N	ALLUMINIO E SUE LEGHE - ALUMINIUM	○	25-30
S	LEGHE RESIST. CALORE - HIG. TEMP. ALLOY		
H	MAT. DURI E TEMPRATI - HARD AND HARDENED MATERIAL		

Vc = m/min VELOCITÀ DI TAGLIO - CUTTING SPEED

MSR2071TL M..
MSR2076TL M..

M 3 - 24

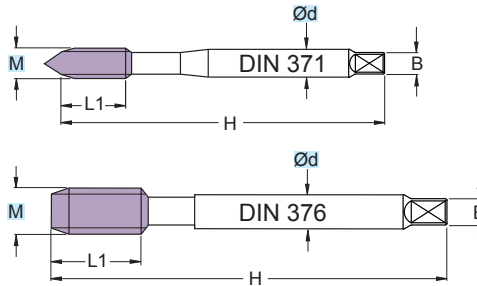
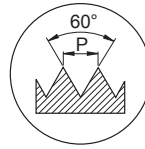

RIVESTIM.
 COATED
TIALN+C

PM3

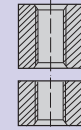

**4-5
 FILL**

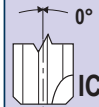

**TOLL
 6HX**

DIN 371		(mm)						
ART.	M	P	Ød	L1	H	B	Preforo Prebore	
MSR2071TL M3	3	0,5	3,5	10	56	2,7	2,5	
MSR2071TL M4	4	0,7	4,5	13	63	3,4	3,3	
MSR2071TL M5	5	0,8	6	13	70	4,9	4,2	
MSR2071TL M6	6	1	6	16	80	4,9	5	
MSR2071TL M8	8	1,25	8	18	90	6,2	6,8	
MSR2071TL M10	10	1,5	10	20	100	8	8,5	

DIN 376		(mm)						
ART.	M	P	Ød	L1	H	B	Preforo Prebore	
MSR2076TL M12	12	1,75	9	25	110	7	10,3	
MSR2076TL M14	14	2	11	28	110	9	12	
MSR2076TL M16	16	2	12	28	110	9	14	

PARAMETRI - PARAMETERS

MATERIALI - MATERIALS Pag. 1199			Vc m/min
P	ACCIAIO - STEEL		
	ACCIAIO AD ALTA RESISTENZA - HIGH-RESISTANCE STEEL	●	5-12
M	ACCIAIO INOX - STAINLESS STEEL		
K	GHISA - CAST IRON	○	15-20
N	ALLUMINIO E SUE LEGHE - ALUMINIUM		
S	LEGHE RESIST. CALORE - HIG. TEMP. ALLOY		
H	MAT. DURI E TEMPRATI - HARD AND HARDENED MATERIAL		

Rm 1200-1400 N/mm², 38-45 HRC

PAG. 1172

Vc = m/min VELOCITÀ DI TAGLIO - CUTTING SPEED

MSR3071TB.. M..
MSR3076TB.. M..

M 3 - 16

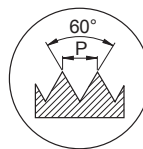

RIVESTIM.
 COATED
TIALN+C

PM3

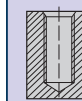

2-3 FILL

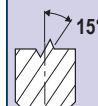

TOLL 6HX

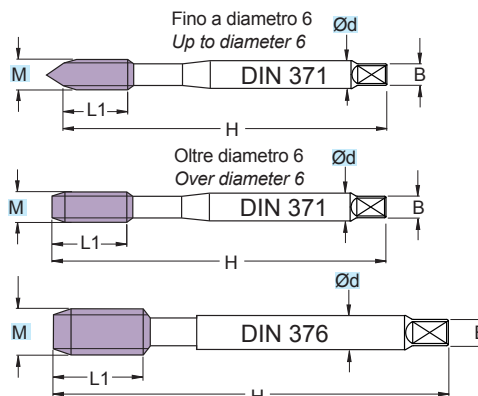

DIN 371		(mm)						Preforo Prebore
ART.	M	P	Ød	L1	H	B		
MSR3071TB M3	3	0,5	3,5	5	56	2,7	2,5	
MSR3071TB M4	4	0,7	4,5	7	63	3,4	3,3	
MSR3071TB M5	5	0,8	6	8	70	4,9	4,2	
MSR3071TB M6	6	1	6	10	80	4,9	5	
MSR3071TB M8	8	1,25	8	13	90	6,2	6,8	
MSR3071TB M10	10	1,5	10	15	100	8	8,5	

DIN 376		(mm)						Preforo Prebore
ART.	M	P	Ød	L1	H	B		
MSR3076TB M12	12	1,75	9	18	110	7	10,3	
MSR3076TB M14	14	2	11	20	110	9	12	
MSR3076TB M16	16	2	12	20	110	9	14	

PARAMETRI - PARAMETERS

MATERIALI - MATERIALS Pag. 1199			Vc m/min
P	ACCIAIO - STEEL		
	ACCIAIO AD ALTA RESISTENZA - HIGH-RESISTANCE STEEL	●	5-12
M	ACCIAIO INOX - STAINLESS STEEL		
K	GHISA - CAST IRON	○	15-20
N	ALLUMINIO E SUE LEGHE - ALUMINIUM		
S	LEGHE RESIST. CALORE - HIG. TEMP. ALLOY		
H	MAT. DURI E TEMPRATI - HARD AND HARDENED MATERIAL		

Rm ≤ 1400 N/mm², ≤ 45 HRC

PAG. 1172

Vc = m/min VELOCITÀ DI TAGLIO - CUTTING SPEED

MSR4071TL M..
MSR4076TL M..

M 3 - 16



○ = RASTREMAZIONE - TAPER

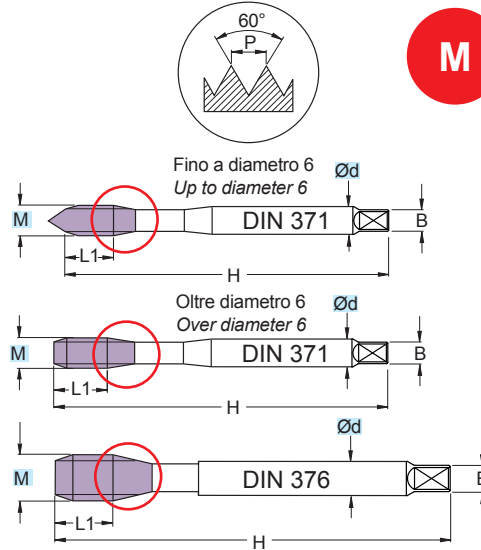

RIVESTIM. COATED TIALN+C	PM3
	2-3 FILL
	TOLL 6HX

DIN 371		(mm)						Preforo Prebore
ART.	M	P	Ød	L1	H	B		
MSR4071TL M3	3	0,5	3,5	5	56	2,7	2,5	
MSR4071TL M4	4	0,7	4,5	7	63	3,4	3,3	
MSR4071TL M5	5	0,8	6	8	70	4,9	4,2	
MSR4071TL M6	6	1	6	10	80	4,9	5	
MSR4071TL M8	8	1,25	8	13	90	6,2	6,8	
MSR4071TL M10	10	1,5	10	15	100	8	8,5	

DIN 376		(mm)						Preforo Prebore
ART.	M	P	Ød	L1	H	B		
MSR4076TL M12	12	1,75	9	18	110	7	10,3	
MSR4076TL M14	14	2	11	20	110	9	12	
MSR4076TL M16	16	2	12	20	110	9	14	

PARAMETRI - PARAMETERS

MATERIALI - MATERIALS Pag. 1199			Vc m/min
P	ACCIAIO - STEEL	○	15-20
	ACCIAIO AD ALTA RESISTENZA - HIGH-RESISTANCE STEEL	●	5-12
M	ACCIAIO INOX - STAINLESS STEEL		
K	GHISA - CAST IRON	○	15-20
N	ALLUMINIO E SUE LEGHE - ALUMINIUM		
S	LEGHE RESIST. CALORE - HIG. TEMP. ALLOY		
H	MAT. DURI E TEMPRATI - HARD AND HARDENED MATERIAL		

Rm ≤ 1200 N/mm², ≤ 38 HRC



Vc = m/min VELOCITÀ DI TAGLIO - CUTTING SPEED

MSI2071TB M..
MSI2076TB M..

M 3 - 24

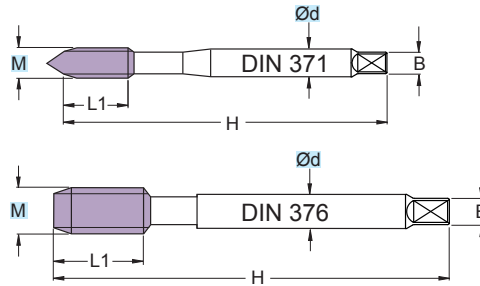
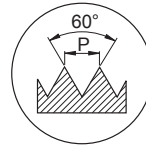

RIVESTIM. COATED TIALN+C	HSSV3
	4-5 FILL
	TOLL 6HX

DIN 371		(mm)						Preforo Prebore
ART.	M	P	Ød	L1	H	B		
MSI2071TB M3	3	0,5	3,5	10	56	2,7	2,5	
MSI2071TB M4	4	0,7	4,5	13	63	3,4	3,3	
MSI2071TB M5	5	0,8	6	13	70	4,9	4,2	
MSI2071TB M6	6	1	6	16	80	4,9	5	
MSI2071TB M8	8	1,25	8	18	90	6,2	6,8	
MSI2071TB M10	10	1,5	10	20	100	8	8,5	

DIN 376		(mm)						Preforo Prebore
ART.	M	P	Ød	L1	H	B		
MSI2076TB M12	12	1,75	9	25	110	7	10,3	
MSI2076TB M14	14	2	11	28	110	9	12	
MSI2076TB M16	16	2	12	28	110	9	14	
MSI2076TB M18	18	2,5	14	33	125	11	15,5	
MSI2076TB M20	20	2,5	16	33	140	12	17,5	
MSI2076TB M22	22	2,5	18	33	140	14,5	19,5	
MSI2076TB M24	24	3	18	39	160	14,5	21	

PARAMETRI - PARAMETERS

MATERIALI - MATERIALS Pag. 1199			Vc m/min
P	ACCIAIO - STEEL	●	15-35
	ACCIAIO AD ALTA RESISTENZA - HIGH-RESISTANCE STEEL		
M	ACCIAIO INOX - STAINLESS STEEL	●	6-15
K	GHISA - CAST IRON		
N	ALLUMINIO E SUE LEGHE - ALUMINIUM		
S	LEGHE RESIST. CALORE - HIG. TEMP. ALLOY		
H	MAT. DURI E TEMPRATI - HARD AND HARDENED MATERIAL		

**MSI4071TB M..
 MSI4076TB M..**

M 3 - 24

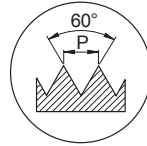

RIVESTIM.
 COATED
TIALN+C **HSSV3**

**2-3
 FILL**

**48°
 TOLL
 6HX**

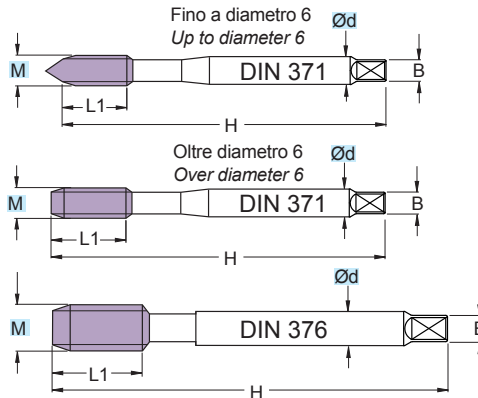

DIN 371		(mm)						
ART.	M	P	Ød	L1	H	B	Preforo Prebore	
MSI4071TB M3	3	0,5	3,5	5	56	2,7	2,5	
MSI4071TB M4	4	0,7	4,5	7	63	3,4	3,3	
MSI4071TB M5	5	0,8	6	8	70	4,9	4,2	
MSI4071TB M6	6	1	6	10	80	4,9	5	
MSI4071TB M8	8	1,25	8	13	90	6,2	6,8	
MSI4071TB M10	10	1,5	10	15	100	8	8,5	

DIN 376		(mm)						
ART.	M	P	Ød	L1	H	B	Preforo Prebore	
MSI4076TB M12	12	1,75	9	18	110	7	10,3	
MSI4076TB M14	14	2	11	20	110	9	12	
MSI4076TB M16	16	2	12	20	110	9	14	
MSI4076TB M18	18	2,5	14	25	125	11	15,5	
MSI4076TB M20	20	2,5	16	25	140	12	17,5	
MSI4076TB M22	22	2,5	18	25	140	14,5	19,5	
MSI4076TB M24	24	3	18	30	160	14,5	21	

PARAMETRI - PARAMETERS

MATERIALI - MATERIALS Pag. 1199			Vc m/min
P	ACCIAIO - STEEL	●	15-35
	ACCIAIO AD ALTA RESISTENZA - HIGH-RESISTANCE STEEL		
M	ACCIAIO INOX - STAINLESS STEEL	●	8-15
K	GHISA - CAST IRON		
N	ALLUMINIO E SUE LEGHE - ALUMINIUM		
S	LEGHE RESIST. CALORE - HIG. TEMP. ALLOY		
H	MAT. DURI E TEMPRATI - HARD AND HARDENED MATERIAL		

PAG. 1172

Vc = m/min VELOCITÀ DI TAGLIO - CUTTING SPEED

**MSG1071SNS M..
 MSG1076SNS M..**

M 3 - 24

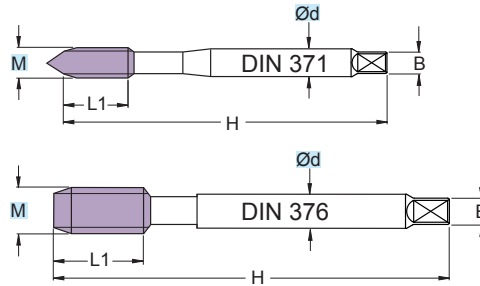
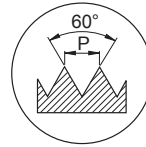

RIVESTIM.
 COATED
SNS

HSSE

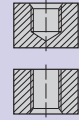

**2-3
 FILL**

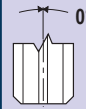

**TOLL
 6HX**

DIN 371		(mm)						Preforo Prebore
ART.	M	P	Ød	L1	H	B		
MSG1071SNS M3	3	0,5	3,5	10	56	2,7	2,5	
MSG1071SNS M4	4	0,7	4,5	13	63	3,4	3,3	
MSG1071SNS M5	5	0,8	6	13	70	4,9	4,2	
MSG1071SNS M6	6	1	6	16	80	4,9	5,0	
MSG1071SNS M8	8	1,25	8	18	90	6,2	6,8	
MSG1071SNS M10	10	1,5	10	20	100	8	8,5	

DIN 376		(mm)						Preforo Prebore
ART.	M	P	Ød	L1	H	B		
MSG1076SNS M12	12	1,75	9	25	110	7	10,3	
MSG1076SNS M14	14	2	11	28	110	9	12,0	
MSG1076SNS M16	16	2	12	28	110	9	14,0	
MSG1076SNS M18	18	2,5	14	33	125	11	15,5	
MSG1076SNS M20	20	2,5	16	33	140	12	17,5	
MSG1076SNS M22	22	2,5	18	33	140	14,5	19,5	
MSG1076SNS M24	24	3	18	39	160	14,5	21	

PARAMETRI - PARAMETERS

MATERIALI - MATERIALS Pag. 1199		Vc m/min
P	ACCIAIO - STEEL	
	ACCIAIO AD ALTA RESISTENZA - HIGH-RESISTANCE STEEL	
M	ACCIAIO INOX - STAINLESS STEEL	
K	GHISA - CAST IRON	● 15-30
N	ALLUMINIO E SUE LEGHE - ALUMINIUM	○ 25-30
S	LEGHE RESIST. CALORE - HIG. TEMP. ALLOY	
H	MAT. DURI E TEMPRATI - HARD AND HARDENED MATERIAL	

Vc = m/min VELOCITÀ DI TAGLIO - CUTTING SPEED

MSG010071TL M..
MSG010076TL M..

M 4 - 24

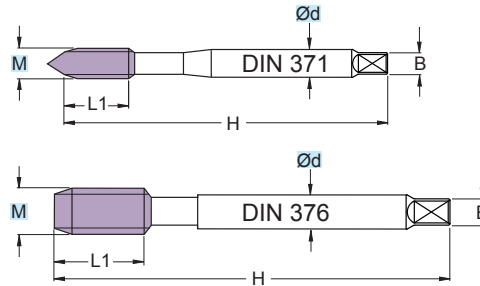
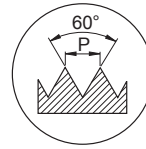

RIVESTIM. COATED TIALN	PM3
	2-3 FILL
	TOLL 6HX

DIN 371		(mm)						
ART.	M	P	Ød	L1	H	B	Preforo Prebore	
MSG010071TL M4	4	0,7	4,5	13	63	3,4	3,3	
MSG010071TL M5	5	0,8	6	13	70	4,9	4,2	
MSG010071TL M6	6	1	6	16	80	4,9	5	
MSG010071TL M8	8	1,25	8	18	90	6,2	6,8	
MSG010071TL M10	10	1,5	10	20	100	8	8,5	

DIN 376		(mm)						
ART.	M	P	Ød	L1	H	B	Preforo Prebore	
MSG010076TL M12	12	1,75	9	25	110	7	10,3	
MSG010076TL M14	14	2	11	28	110	9	12	
MSG010076TL M16	16	2	12	28	110	9	14	
MSG010076TL M18	18	2,5	14	33	125	11	15,5	
MSG010076TL M20	20	2,5	16	33	140	12	17,5	
MSG010076TL M22	22	2,5	18	33	140	14,5	19,5	
MSG010076TL M24	24	3	18	39	160	14,5	21	

PARAMETRI - PARAMETERS

MATERIALI - MATERIALS Pag. 1199			Vc m/min
P	ACCIAIO - STEEL		
	ACCIAIO AD ALTA RESISTENZA - HIGH-RESISTANCE STEEL		
M	ACCIAIO INOX - STAINLESS STEEL		
K	GHISA - CAST IRON	●	20-30
N	ALLUMINIO E SUE LEGHE - ALUMINIUM	○	25-30
S	LEGHE RESIST. CALORE - HIG. TEMP. ALLOY		
H	MAT. DURI E TEMPRATI - HARD AND HARDENED MATERIAL		



Vc = m/min VELOCITÀ DI TAGLIO - CUTTING SPEED

MSG010071TLW M..
MSG010076TLW M..

M 6 - 24

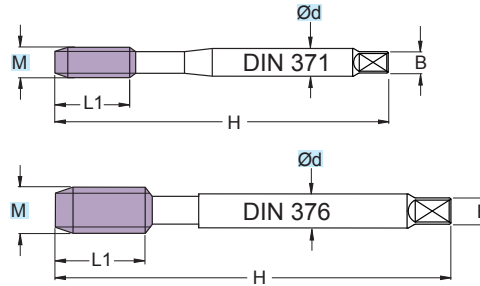
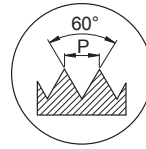

RIVESTIM. COATED TIALN	PM3
	2-3 FILL
	TOLL 6HX

DIN 371		(mm)						Preforo Prebore
ART.	M	P	Ød	L1	H	B		
MSG010071TLW M6	6	1	6	16	80	4,9	5	
MSG010071TLW M8	8	1,25	8	18	90	6,2	6,8	
MSG010071TLW M10	10	1,5	10	20	100	8	8,5	

DIN 376		(mm)						Preforo Prebore
ART.	M	P	Ød	L1	H	B		
MSG010076TLW M12	12	1,75	9	25	110	7	10,3	
MSG010076TLW M14	14	2	11	28	110	9	12	
MSG010076TLW M16	16	2	12	28	110	9	14	
MSG010076TLW M18	18	2,5	14	33	125	11	15,5	
MSG010076TLW M20	20	2,5	16	33	140	12	17,5	
MSG010076TLW M22	22	2,5	18	33	140	14,5	19,5	
MSG010076TLW M24	24	3	18	39	160	14,5	21	

PARAMETRI - PARAMETERS

MATERIALI - MATERIALS Pag. 1199		Vc m/min
P	ACCIAIO - STEEL	
	ACCIAIO AD ALTA RESISTENZA - HIGH-RESISTANCE STEEL	
M	ACCIAIO INOX - STAINLESS STEEL	
K	GHISA - CAST IRON	● 20-30
N	ALLUMINIO E SUE LEGHE - ALUMINIUM	○ 25-30
S	LEGHE RESIST. CALORE - HIG. TEMP. ALLOY	
H	MAT. DURI E TEMPRATI - HARD AND HARDENED MATERIAL	

Vc = m/min VELOCITÀ DI TAGLIO - CUTTING SPEED

MSG180071TL M..
MSG180076TL M..

M 6 - 24

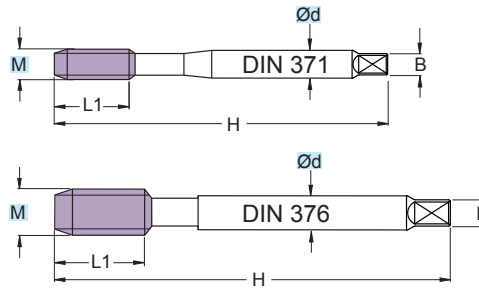
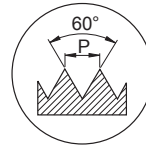

RIVESTIM. COATED TIALN	PM3
 1,5-2 FILL	
 TOLL 6HX	

DIN 371		(mm)						
ART.	M	P	Ød	L1	H	B	Preforo Prebore	
MSG180071TL M6	6	1	6	16	80	4,9	5	
MSG180071TL M8	8	1,25	8	18	90	6,2	6,8	
MSG180071TL M10	10	1,5	10	20	100	8	8,5	

DIN 376		(mm)						
ART.	M	P	Ød	L1	H	B	Preforo Prebore	
MSG180076TL M12	12	1,75	9	25	110	7	10,3	
MSG180076TL M14	14	2	11	28	110	9	12	
MSG180076TL M16	16	2	12	28	110	9	14	
MSG180076TL M18	18	2,5	14	33	125	11	15,5	
MSG180076TL M20	20	2,5	16	33	140	12	17,5	
MSG180076TL M22	22	2,5	18	33	140	14,5	19,5	
MSG180076TL M24	24	3	18	39	160	14,5	21	

PARAMETRI - PARAMETERS

MATERIALI - MATERIALS Pag. 1199		Vc m/min
P	ACCIAIO - STEEL	
	ACCIAIO AD ALTA RESISTENZA - HIGH-RESISTANCE STEEL	
M	ACCIAIO INOX - STAINLESS STEEL	
K	GHISA - CAST IRON	● 20-30
N	ALLUMINIO E SUE LEGHE - ALUMINIUM	○ 25-30
S	LEGHE RESIST. CALORE - HIG. TEMP. ALLOY	
H	MAT. DURI E TEMPRATI - HARD AND HARDENED MATERIAL	



Vc = m/min VELOCITÀ DI TAGLIO - CUTTING SPEED

MSG180071TLW M..
MSG180076TLW M..

M 6 - 24

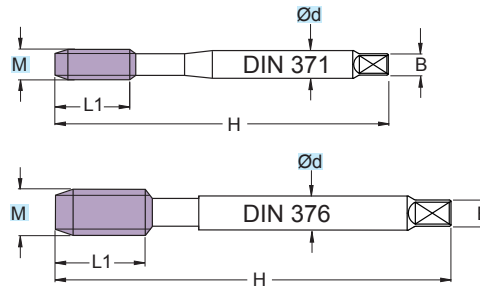
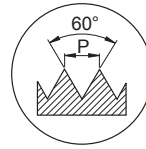

RIVESTIM. COATED TIALN	PM3
	1,5-2 FILL
	TOLL 6HX

DIN 371		(mm)						Preforo Prebore
ART.	M	P	Ød	L1	H	B		
MSG180071TLW M6	6	1	6	16	80	4,9	5	
MSG180071TLW M8	8	1,25	8	18	90	6,2	6,8	
MSG180071TLW M10	10	1,5	10	20	100	8	8,5	

DIN 376		(mm)						Preforo Prebore
ART.	M	P	Ød	L1	H	B		
MSG180076TLW M12	12	1,75	9	25	110	7	10,3	
MSG180076TLW M14	14	2	11	28	110	9	12	
MSG180076TLW M16	16	2	12	28	110	9	14	
MSG180076TLW M18	18	2,5	14	33	125	11	15,5	
MSG180076TLW M20	20	2,5	16	33	140	12	17,5	
MSG180076TLW M22	22	2,5	18	33	140	14,5	19,5	
MSG180076TLW M24	24	3	18	39	160	14,5	21	

PARAMETRI - PARAMETERS

MATERIALI - MATERIALS Pag. 1199		Vc m/min
P	ACCIAIO - STEEL	
	ACCIAIO AD ALTA RESISTENZA - HIGH-RESISTANCE STEEL	
M	ACCIAIO INOX - STAINLESS STEEL	
K	GHISA - CAST IRON	● 15-25
N	ALLUMINIO E SUE LEGHE - ALUMINIUM	○ 25-30
S	LEGHE RESIST. CALORE - HIG. TEMP. ALLOY	
H	MAT. DURI E TEMPRATI - HARD AND HARDENED MATERIAL	

Vc = m/min VELOCITÀ DI TAGLIO - CUTTING SPEED

MSN1071VP.. M..
MSN1076VP.. M..

M 3 - 16

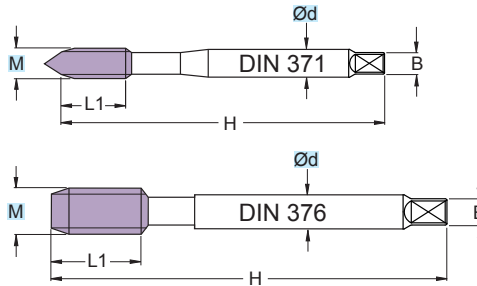
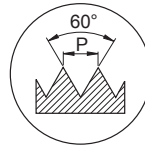

RIVESTIM. COATED VX	HSSE
	4-5 FILL
	TOLL ISO2 6H

DIN 371		(mm)						
ART.	M	P	Ød	L1	H	B	Preforo Prebore	Z
MSN1071VP M3	3	0,5	3,5	10	56	2,7	2,5	2
MSN1071VP M4	4	0,7	4,5	13	63	3,4	3,3	2
MSN1071VP M5	5	0,8	6	13	70	4,9	4,2	2
MSN1071VP M6	6	1	6	16	80	4,9	5	2
MSN1071VP M8	8	1,25	8	18	90	6,2	6,8	2
MSN1071VP M10	10	1,5	10	20	100	8	8,5	2

DIN 376		(mm)						
ART.	M	P	Ød	L1	H	B	Preforo Prebore	Z
MSN1076VP M12	12	1,75	9	25	110	7	10,3	3
MSN1076VP M14	14	2	11	28	110	9	12	3
MSN1076VP M16	16	2	12	28	110	9	14	3

PARAMETRI - PARAMETERS

MATERIALI - MATERIALS Pag. 1199		Vc m/min
P	ACCIAIO - STEEL	
	ACCIAIO AD ALTA RESISTENZA - HIGH-RESISTANCE STEEL	
M	ACCIAIO INOX - STAINLESS STEEL	
K	GHISA - CAST IRON	
N	ALLUMINIO E SUE LEGHE - ALUMINIUM	● 10-20
S	LEGHE RESIST. CALORE - HIG. TEMP. ALLOY	
H	MAT. DURI E TEMPRATI - HARD AND HARDENED MATERIAL	



Vc = m/min VELOCITÀ DI TAGLIO - CUTTING SPEED

MSN4071VP.. M..
MSN4076VP.. M..

M 3 - 16

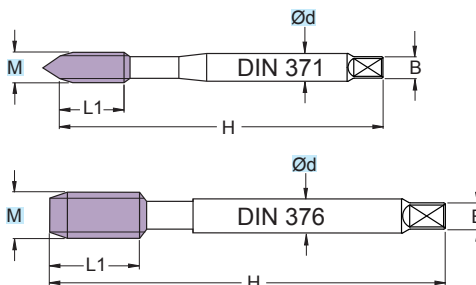
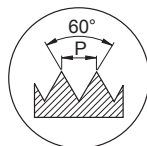

RIVESTIM. COATED VX	HSSE
	2-3 FILL
	TOLL ISO2 6H

DIN 371 (mm)								
ART.	M	P	Ød	L1	H	B	Preforo Prebore	Z
MSN4071VP M3	3	0,5	3,5	10	56	2,7	2,5	2
MSN4071VP M4	4	0,7	4,5	13	63	3,4	3,3	2
MSN4071VP M5	5	0,8	6	13	70	4,9	4,2	2
MSN4071VP M6	6	1	6	16	80	4,9	5	2
MSN4071VP M8	8	1,25	8	18	90	6,2	6,8	2
MSN4071VP M10	10	1,5	10	20	100	8	8,5	2

DIN 376 (mm)								
ART.	M	P	Ød	L1	H	B	Preforo Prebore	Z
MSN4076VP M12	12	1,75	9	25	110	7	10,3	3
MSN4076VP M14	14	2	11	28	110	9	12	3
MSN4076VP M16	16	2	12	28	110	9	14	3

PARAMETRI - PARAMETERS

MATERIALI - MATERIALS Pag. 1199		Vc m/min
P	ACCIAIO - STEEL	
	ACCIAIO AD ALTA RESISTENZA - HIGH-RESISTANCE STEEL	
M	ACCIAIO INOX - STAINLESS STEEL	
K	GHISA - CAST IRON	
N	ALLUMINIO E SUE LEGHE - ALUMINIUM	● 10-20
S	LEGHE RESIST. CALORE - HIG. TEMP. ALLOY	
H	MAT. DURI E TEMPRATI - HARD AND HARDENED MATERIAL	

Vc = m/min VELOCITÀ DI TAGLIO - CUTTING SPEED

MST8071TC.. M..
MST8076TC.. M..

M 3 - 16

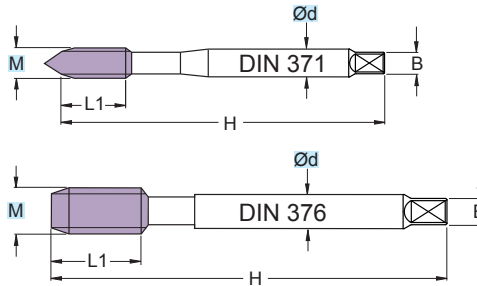
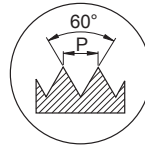

RIVESTIM. COATED TICN	PM3
	4-5 FILL
	TOLL 6HX

DIN 371		(mm)						Preforo Prebore
ART.	M	P	Ød	L1	H	B		
MST8071TC M3	3	0,5	3,5	10	56	2,7	2,5	
MST8071TC M4	4	0,7	4,5	13	63	3,4	3,3	
MST8071TC M5	5	0,8	6	13	70	4,9	4,2	
MST8071TC M6	6	1	6	16	80	4,9	5	
MST8071TC M8	8	1,25	8	18	90	6,2	6,8	
MST8071TC M10	10	1,5	10	20	100	8	8,5	

DIN 376		(mm)						Preforo Prebore
ART.	M	P	Ød	L1	H	B		
MST8076TC M12	12	1,75	9	25	110	7	10,3	
MST8076TC M16	16	2	12	28	110	9	14	

PARAMETRI - PARAMETERS

MATERIALI - MATERIALS Pag. 1199			Vc m/min
P	ACCIAIO - STEEL		
	ACCIAIO AD ALTA RESISTENZA - HIGH-RESISTANCE STEEL		
M	ACCIAIO INOX - STAINLESS STEEL (DUPLEX)	○	6-8
K	GHISA - CAST IRON		
N	ALLUMINIO E SUE LEGHE - ALUMINIUM		
S	LEGHE RESIST. CALORE - HIG. TEMP. ALLOY	●	5-10
H	MAT. DURI E TEMPRATI - HARD AND HARDENED MATERIAL		



Vc = m/min VELOCITÀ DI TAGLIO - CUTTING SPEED

MST3071TC M..
MST3076TC M..

M 3 - 16

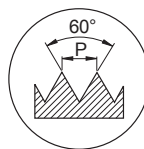

RIVESTIM.
 COATED
TICN

PM3



**2-3
 FILL**

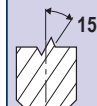

**TOLL
 6HX**

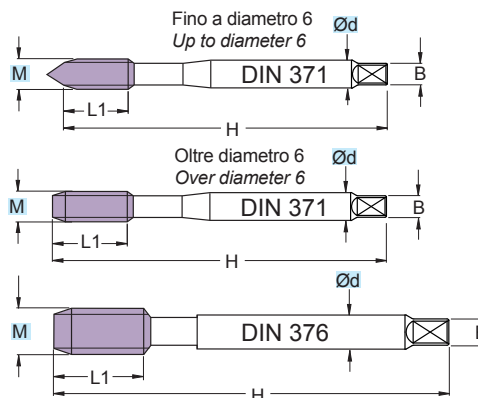

DIN 371		(mm)						Preforo Prebore
ART.	M	P	Ød	L1	H	B		
MST3071TC M3	3	0,5	3,5	5	56	2,7	2,5	
MST3071TC M4	4	0,7	4,5	7	63	3,4	3,3	
MST3071TC M5	5	0,8	6	8	70	4,9	4,2	
MST3071TC M6	6	1	6	10	80	4,9	5	
MST3071TC M8	8	1,25	8	13	90	6,2	6,8	
MST3071TC M10	10	1,5	10	15	100	8	8,5	

DIN 376		(mm)						Preforo Prebore
ART.	M	P	Ød	L1	H	B		
MST3076TC M12	12	1,75	9	18	110	7	10,3	
MST3076TC M16	16	2	12	20	110	9	14	

PARAMETRI - PARAMETERS

MATERIALI - MATERIALS Pag. 1199			Vc m/min
P	ACCIAIO - STEEL		
	ACCIAIO AD ALTA RESISTENZA - HIGH-RESISTANCE STEEL		
M	ACCIAIO INOX - STAINLESS STEEL (DUPLEX)	○	6-8
K	GHISA - CAST IRON		
N	ALLUMINIO E SUE LEGHE - ALUMINIUM		
S	LEGHE RESIST. CALORE - HIG. TEMP. ALLOY	●	5-10
H	MAT. DURI E TEMPRATI - HARD AND HARDENED MATERIAL		

**MSA5071TN M..
 MSA5076TN M..**

Senza canaline di lubrificazione
 Without lubrication channels



RIVESTIM. COATED TIN	PM3
	2-3 FILL
	TOLL 6HX

M 3 - 12

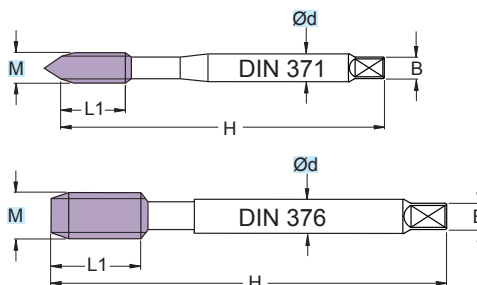
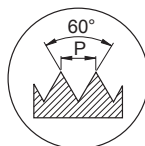

DIN 371		(mm)						Preforo Prebore
ART.	M	P	Ød	L1	H	B		
MSA5071TN M3	3	0,5	3,5	10	56	2,7	2,8	
MSA5071TN M4	4	0,7	4,5	13	63	3,4	3,7	
MSA5071TN M5	5	0,8	6	13	70	4,9	4,65	
MSA5071TN M6	6	1	6	16	80	4,9	5,55	
MSA5071TN M8	8	1,25	8	18	90	6,2	7,40	
MSA5071TN M10	10	1,5	10	20	100	8	9,30	

DIN 376		(mm)						Preforo Prebore
ART.	M	P	Ød	L1	H	B		
MSA5076TN M12	12	1,75	9	25	110	7	11,2	

PARAMETRI - PARAMETERS

MATERIALI - MATERIALS Pag. 1199			Vc m/min
P	ACCIAIO - STEEL	●	25-40
	ACCIAIO AD ALTA RESISTENZA - HIGH-RESISTANCE STEEL	○	15-20
M	ACCIAIO INOX - STAINLESS STEEL	●	6-20
K	GHISA - CAST IRON		
N	ALLUMINIO E SUE LEGHE - ALUMINIUM	●	35-45
S	LEGHE RESIST. CALORE - HIG. TEMP. ALLOY	●	15-20
H	MAT. DURI E TEMPRATI - HARD AND HARDENED MATERIAL		



Vc = m/min VELOCITÀ DI TAGLIO - CUTTING SPEED

MSK060071TG M..
MSK060076TG M..

Con canaline di lubrificazione
With lubrication channels

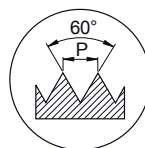

RIVESTIM.
 COATED
TIN

PM8

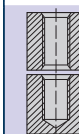

**2-3
 FILL**



**TOLL
 6HX**

M 3 - 16

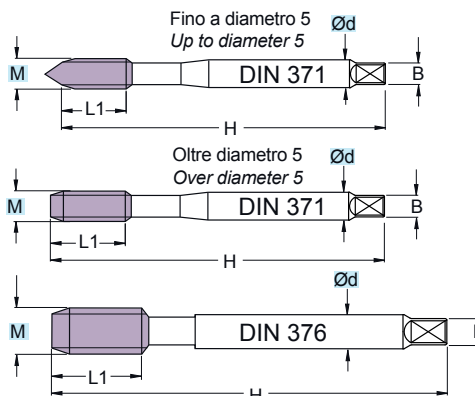

DIN 371		(mm)						Preforo Prebore
ART.	M	P	Ød	L1	H	B		
MSK060071TG M3	3	0,5	3,5	5	56	2,7	2,8	
MSK060071TG M4	4	0,7	4,5	7	63	3,4	3,7	
MSK060071TG M5	5	0,8	6	8	70	4,9	4,65	
MSK060071TG M6	6	1	6	10	80	4,9	5,55	
MSK060071TG M8	8	1,25	8	13	90	6,2	7,40	
MSK060071TG M10	10	1,5	10	15	100	8	9,30	

DIN 376		(mm)						Preforo Prebore
ART.	M	P	Ød	L1	H	B		
MSK060076TG M12	12	1,75	9	18	110	7	11,2	
MSK060076TG M14	14	2	11	20	110	9	13,1	
MSK060076TG M16	16	2	12	20	110	9	15,1	

PARAMETRI - PARAMETERS

MATERIALI - MATERIALS Pag. 1199			Vc m/min
P	ACCIAIO - STEEL	○	25-40
	ACCIAIO AD ALTA RESISTENZA - HIGH-RESISTANCE STEEL	●	10-15
M	ACCIAIO INOX - STAINLESS STEEL	●	6-15
K	GHISA - CAST IRON		
N	ALLUMINIO E SUE LEGHE - ALUMINIUM	○	35-45
S	LEGHE RESIST. CALORE - HIG. TEMP. ALLOY	●	15-20
H	MAT. DURI E TEMPRATI - HARD AND HARDENED MATERIAL		

Vc = m/min VELOCITÀ DI TAGLIO - CUTTING SPEED

MASCHI PER CALETTAMENTO TERMICO CON GAMBO h6

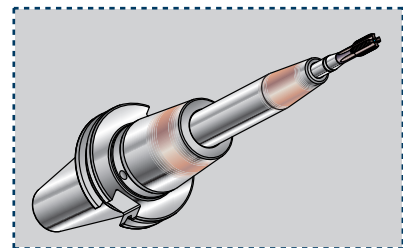

TAPS FOR SHRINKING ON WITH h6 SHANK
GEWINDESCHNEIDER FÜR SCHRUMPFUTTER, MIT SCHAFT h6
TARAUDS POUR CALAGE THERMIQUE AVEC TIGE h6
MACHOS PARA EMPALME TÉRMICO CON VÁSTAGO h6

MSG0100NITBW-h6..

M 6 - 20

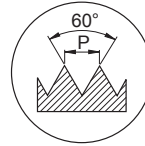

RIVESTIM. COATED TIALN+C	PM3
	2-3 FILL
	TOLL 6HX

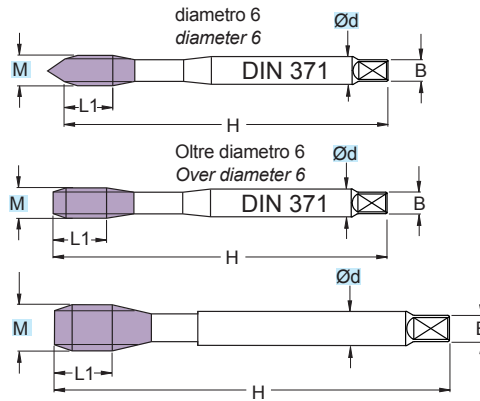

ART.	DIN 371 (mm)							Preforo Prebore
	M	P	h6 Ød	L1	H	B		
MSG0100NITBW-h6 M6	6	1	6	10	80	4,9	5,0	
MSG0100NITBW-h6 M8	8	1,25	8	13	90	6,2	6,8	
MSG0100NITBW-h6 M10	10	1,5	10	15	100	8	8,5	

ART.	(mm)							Preforo Prebore
	M	P	h6 Ød	L1	H	B		
MSG0100NITBW-h6 M12 G10	12	1,75	10	18	110	8	10,3	
MSG0100NITBW-h6 M14	14	2	12	20	110	9	12,0	
MSG0100NITBW-h6 M16 G12	16	2	12	20	110	9	14,0	
MSG0100NITBW-h6 M18 G14	18	2,5	14	25	125	11	15,5	
MSG0100NITBW-h6 M20 G16	20	2,5	16	25	140	12	17,5	

PARAMETRI - PARAMETERS

MATERIALI - MATERIALS Pag. 1199		VDI 3323 GR.	HB Rm ¹⁾ HRC ²⁾	Vc m/min
P	ACCIAIO NON LEGATO - NOT ALLOY STEEL	1-5	125-300	
	ACCIAIO POCO LEGATO - LOW ALLOY STEEL	6-9	180-350	
	ACCIAIO ALTO LEGATO - ALLOY STEEL	10-11	200-325	
	INOX MARTENS. - STAINLESS STEEL MART	12-13	200-240	● 20-25
M	INOX AUST. DUPLEX - STAINLESS STEEL AUST	14.1-14.2	180-230	
K	GHISA GRIGIA - GREY CAST IRON	15-16	180-260	● 20-25
	GHISA SFEROIDALE - SPHEROIDAL GRAPHITE	17-18	160-250	● 20-25
	GHISA MALLEABILE - MALLEABLE CAST IRON	19-20	130-230	● 25-30
N	ALLUMINIO E SUE LEGHE - ALUMINIUM	21-25	60-130	
	RAME E SUE LEGHE - COPPER	26-28	90-110	
	NON METALLICI - PLASTICS	29-30	/	
S	LEGHE RESIST. CALORE - HIG. TEMP. ALLOY	31-35	200-320	
	TITANIO E SUE LEGHE - TITANIUM	36-37	400-1050 ¹⁾	
H	ACCIAIO TEMPRATO - HARDENED STEEL	38-41	45-60 ¹⁾	

Vc = m/min VELOCITÀ DI TAGLIO - CUTTING SPEED



FILETTATURA METRICA ISO PASSO FINE (MF)

ISO METRIC FINE SCREW THREAD (MF)
GEWINDESCHNEIDEN - METRISCHE ISO FEINGEWINDE (MF)
FILETAGE METRIQUE ISO PAS FIN (MF)
ROSCA MÉTRICA ISO DE PASO FINO (MF)

MSA2171VP MF..
MSA2174VP MF..

MF 4 - 24

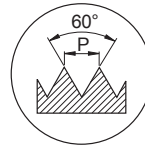

RIVESTIM.
 COATED
VP

HSSE

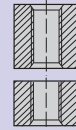

**4-5
 FILL**

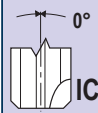

**TOLL
 ISO2
 6H**

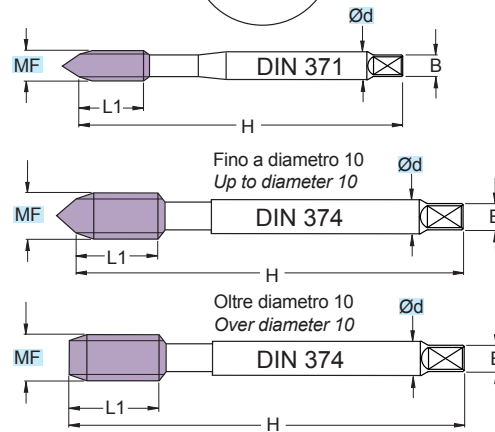

DIN 371		(mm)						Preforo Prebore
ART.	MF	P	Ød	L1	H	B		
MSA2171VP MF4x0,5	4	0,5	4,5	13	63	3,4	3,5	
MSA2171VP MF5x0,5	5	0,5	6	13	70	4,9	4,5	
MSA2171VP MF6x0,75	6	0,75	6	16	80	4,9	5,25	
MSA2171VP MF8x1	8	1	8	18	90	6,2	7	
MSA2171VP MF10x1	10	1	10	15	90	8	9	
MSA2171VP MF10x1,25	10	1,25	10	20	100	8	8,75	

DIN 374		(mm)						Preforo Prebore
ART.	MF	P	Ød	L1	H	B		
MSA2174VP MF6x0,75	6	0,75	4,5	16	80	3,4	5,25	
MSA2174VP MF8x1	8	1	6	18	90	4,9	7	
MSA2174VP MF10x1	10	1	7	15	90	5,5	9	
MSA2174VP MF10x1,25	10	1,25	7	20	100	5,5	8,75	
MSA2174VP MF12x1	12	1	9	22	100	7	11	
MSA2174VP MF12x1,25	12	1,25	9	22	100	7	10,75	
MSA2174VP MF12x1,5	12	1,5	9	22	100	7	10,5	
MSA2174VP MF14x1	14	1	11	22	100	9	13	
MSA2174VP MF14x1,25	14	1,25	11	22	100	9	12,75	
MSA2174VP MF14x1,5	14	1,5	11	22	100	9	12,5	
MSA2174VP MF16x1	16	1	12	22	100	9	15	
MSA2174VP MF16x1,5	16	1,5	12	22	100	9	14,5	
MSA2174VP MF18x1	18	1	14	25	110	11	17	
MSA2174VP MF18x1,5	18	1,5	14	25	110	11	16,5	
MSA2174VP MF20x1	20	1	16	25	125	12	19	
MSA2174VP MF20x1,5	20	1,5	16	25	125	12	18,5	
MSA2174VP MF22x1	22	1	18	25	125	14,5	21	
MSA2174VP MF22x1,5	22	1,5	18	25	125	14,5	20,5	
MSA2174VP MF24x1	24	1	18	25	140	14,5	23	
MSA2174VP MF24x1,5	24	1,5	18	25	140	14,5	22,5	
MSA2174VP MF24x2	24	2	18	25	140	14,5	22	

PARAMETRI - PARAMETERS

MATERIALI - MATERIALS Pag. 1199			Vc m/min
P	ACCIAIO - STEEL	●	10-15
	ACCIAIO AD ALTA RESISTENZA - HIGH-RESISTANCE STEEL		
M	ACCIAIO INOX - STAINLESS STEEL		
K	GHISA - CAST IRON		
N	ALLUMINIO E SUE LEGHE - ALUMINIUM	○	10-20
S	LEGHE RESIST. CALORE - HIG. TEMP. ALLOY		
H	MAT. DURI E TEMPRATI - HARD AND HARDENED MATERIAL		

MSA4171VP MF..
MSA4174VP MF..

MF 4 - 24

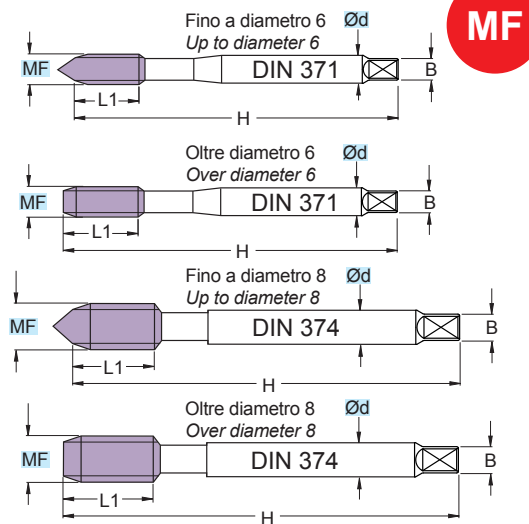
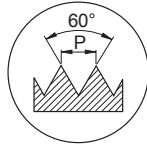

RIVESTIM. COATED VP	HSSE
	2-3 FILL
	TOLL ISO2 6H

DIN 371		(mm)						Preforo Prebore
ART.	MF	P	Ød	L1	H	B		
MSA4171VP MF4x0,5	4	0,5	4,5	7	63	3,4	3,5	
MSA4171VP MF5x0,5	5	0,5	6	8	70	4,9	4,5	
MSA4171VP MF6x0,75	6	0,75	6	10	80	4,9	5,25	
MSA4171VP MF8x1	8	1	8	13	90	6,2	7	
MSA4171VP MF10x1	10	1	10	15	90	8	9	
MSA4171VP MF10x1,25	10	1,25	10	15	100	8	8,75	

DIN 374		(mm)						Preforo Prebore
ART.	MF	P	Ød	L1	H	B		
MSA4174VP MF8x1	8	1	6	13	90	4,9	7	
MSA4174VP MF10x1	10	1	7	15	90	5,5	9	
MSA4174VP MF10x1,25	10	1,25	7	15	100	5,5	8,75	
MSA4174VP MF12x1	12	1	9	13	100	7	11	
MSA4174VP MF12x1,25	12	1,25	9	13	100	7	10,75	
MSA4174VP MF12x1,5	12	1,5	9	13	100	7	10,5	
MSA4174VP MF14x1	14	1	11	15	100	9	13	
MSA4174VP MF14x1,25	14	1,25	11	15	100	9	12,75	
MSA4174VP MF14x1,5	14	1,5	11	15	100	9	12,5	
MSA4174VP MF16x1	16	1	12	15	100	9	15	
MSA4174VP MF16x1,5	16	1,5	12	15	100	9	14,5	
MSA4174VP MF18x1	18	1	14	17	110	11	17	
MSA4174VP MF18x1,5	18	1,5	14	17	110	11	16,5	
MSA4174VP MF20x1	20	1	16	17	125	12	19	
MSA4174VP MF20x1,5	20	1,5	16	17	125	12	18,5	
MSA4174VP MF22x1	22	1	18	25	125	14,5	21	
MSA4174VP MF22x1,5	22	1,5	18	25	125	14,5	20,5	
MSA4174VP MF24x2	24	2	18	25	140	14,5	22	

PARAMETRI - PARAMETERS

MATERIALI - MATERIALS Pag. 1199			Vc m/min
P	ACCIAIO - STEEL	●	10-15
	ACCIAIO AD ALTA RESISTENZA - HIGH-RESISTANCE STEEL		
M	ACCIAIO INOX - STAINLESS STEEL		
K	GHISA - CAST IRON		
N	ALLUMINIO E SUE LEGHE - ALUMINIUM	○	10-20
S	LEGHE RESIST. CALORE - HIG. TEMP. ALLOY		
H	MAT. DURI E TEMPRATI - HARD AND HARDENED MATERIAL		

MSU020174STN MF..

MF 8 - 24

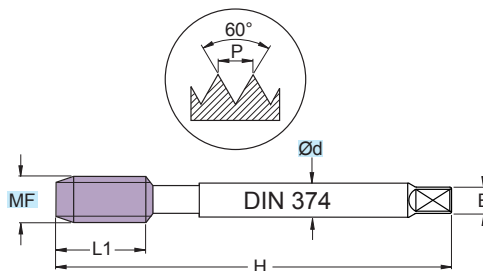

RIVESTIM. COATED TT	PM3
	4-5 FILL
	TOLL 6HX

DIN 374		(mm)						Preforo Prebore
ART.	MF	P	Ød	L1	H	B		
MSU020174STN MF8X1	8	1	6	18	90	4,9	7	
MSU020174STN MF10X1	10	1	7	15	90	5,5	9	
MSU020174STN MF10X1,25	10	1,25	7	20	100	5,5	8,75	
MSU020174STN MF12X1,25	12	1,25	9	22	100	7	10,75	
MSU020174STN MF12X1,5	12	1,5	9	22	100	7	10,5	
MSU020174STN MF14X1,5	14	1,5	11	22	100	9	12,5	
MSU020174STN MF16X1,5	16	1,5	12	22	100	9	14,5	
MSU020174STN MF18X1,5	18	1,5	14	25	110	11	16,5	
MSU020174STN MF20X1,5	20	1,5	16	25	125	12	18,5	
MSU020174STN MF22X1,5	22	1,5	18	25	125	14,5	20,5	
MSU020174STN MF24X1,5	24	1,5	18	25	140	14,5	22,5	

PARAMETRI - PARAMETERS

MATERIALI - MATERIALS Pag. 1199			Vc m/min
P	ACCIAIO - STEEL	●	15-30
	ACCIAIO AD ALTA RESISTENZA - HIGH-RESISTANCE STEEL	●	5-12
M	ACCIAIO INOX - STAINLESS STEEL	●	6-15
K	GHISA - CAST IRON	●	10-20
N	ALLUMINIO E SUE LEGHE - ALUMINIUM	●	20-30
S	LEGHE RESIST. CALORE - HIG. TEMP. ALLOY		
H	MAT. DURI E TEMPRATI - HARD AND HARDENED MATERIAL		



Vc = m/min VELOCITÀ DI TAGLIO - CUTTING SPEED

MSU150174STN MF..

MF 8 - 24

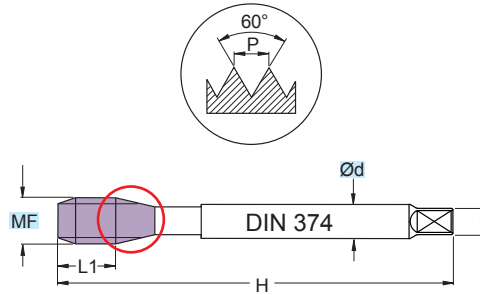

○ = RASTREMAZIONE - TAPER

MF

RIVESTIM. COATED TT	PM3
	2-3 FILL
	TOLL 6HX
	SINCRO

ART.	DIN 374 (mm)		Ød	L1	H	B	Preforo Prebore
	MF	P					
MSU150174STN MF8X1	8	1	6	13	90	4,9	7
MSU150174STN MF10X1	10	1	7	15	90	5,5	9
MSU150174STN MF10X1,25	10	1,25	7	15	100	5,5	8,75
MSU150174STN MF12X1	12	1	9	13	100	7	11
MSU150174STN MF12X1,25	12	1,25	9	13	100	7	10,75
MSU150174STN MF12X1,5	12	1,5	9	13	100	7	10,5
MSU150174STN MF14X1,5	14	1,5	11	15	100	9	12,5
MSU150174STN MF16X1,5	16	1,5	12	15	100	9	14,5
MSU150174STN MF18X1,5	18	1,5	14	17	110	11	16,5
MSU150174STN MF20X1,5	20	1,5	16	17	125	12	18,5
MSU150174STN MF22X1,5	22	1,5	18	18	125	14,5	20,5
MSU150174STN MF24X1,5	24	1,5	18	20	140	14,5	22,5

- PER MAGGIORI PRESTAZIONI SI CONSIGLIA MASCHIATURA SINCRONIZZATA
- FOR HIGHER PERFORMANCE WE RECOMMEND SYNCHRONIZED TAPPING
- FÜR HÖHERE LEISTUNGEN EMPFIEHLT SICH SYNCHRONISIERTES GEWINDESCHNEIDEN
- POUR PLUS DE PERFORMANCES IL EST CONSEILLE UN TARAUDAGE SYNCHRONISE

PARAMETRI - PARAMETERS

MATERIALI - MATERIALS Pag. 1199			Vc m/min
P	ACCIAIO - STEEL	●	15-30
	ACCIAIO AD ALTA RESISTENZA - HIGH-RESISTANCE STEEL	●	5-12
M	ACCIAIO INOX - STAINLESS STEEL	●	6-15
K	GHISA - CAST IRON	●	10-20
N	ALLUMINIO E SUE LEGHE - ALUMINIUM	○	20-30
S	LEGHE RESIST. CALORE - HIG. TEMP. ALLOY		
H	MAT. DURI E TEMPRATI - HARD AND HARDENED MATERIAL		

PAG. 1172

Vc = m/min VELOCITÀ DI TAGLIO - CUTTING SPEED

MSU150174STNW MF..

MF 8 - 24



RIVESTIM. COATED TT	PM3
	2-3 FILL
	TOLL 6HX
	SINCRO

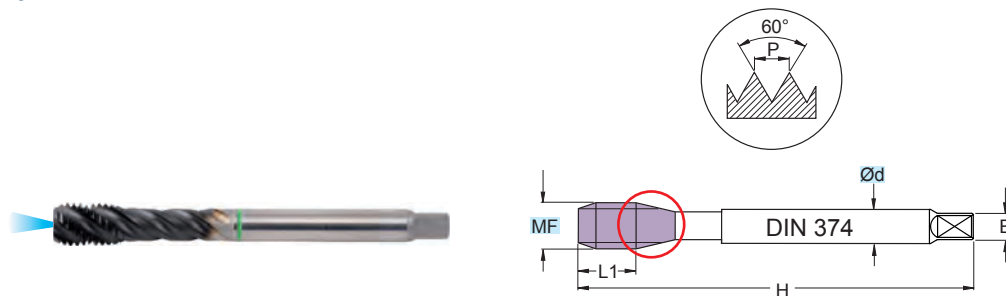

○ = RASTREMAZIONE - TAPER

ART.	DIN 374 (mm)						
	MF	P	Ød	L1	H	B	Preforo Prebore
MSU150174STNW MF8X1	8	1	6	13	90	4,9	7
MSU150174STNW MF10X1	10	1	7	15	90	5,5	9
MSU150174STNW MF10X1,25	10	1,25	7	15	100	5,5	8,75
MSU150174STNW MF12X1	12	1	9	13	100	7	11
MSU150174STNW MF12X1,25	12	1,25	9	13	100	7	10,75
MSU150174STNW MF12X1,5	12	1,5	9	13	100	7	10,5
MSU150174STNW MF14X1,5	14	1,5	11	15	100	9	12,5
MSU150174STNW MF16X1,5	16	1,5	12	15	100	9	14,5
MSU150174STNW MF18X1,5	18	1,5	14	17	110	11	16,5
MSU150174STNW MF20X1,5	20	1,5	16	17	125	12	18,5
MSU150174STNW MF22X1,5	22	1,5	18	18	125	14,5	20,5
MSU150174STNW MF24X1,5	24	1,5	18	20	140	14,5	22,5

- PER MAGGIORI PRESTAZIONI SI CONSIGLIA MASCHIATURA SINCRONIZZATA
- FOR HIGHER PERFORMANCE WE RECOMMEND SYNCHRONIZED TAPPING
- FÜR HÖHERE LEISTUNGEN EMPFIEHLT SICH SYNCHRONISIERTES GEWINDESCHNEIDEN
- POUR PLUS DE PERFORMANCES IL EST CONSEILLE UN TARAUDAGE SYNCHRONISE

PARAMETRI - PARAMETERS

MATERIALI - MATERIALS Pag. 1199			Vc m/min
P	ACCIAIO - STEEL	●	15-30
	ACCIAIO AD ALTA RESISTENZA - HIGH-RESISTANCE STEEL	●	5-12
M	ACCIAIO INOX - STAINLESS STEEL	●	6-15
K	GHISA - CAST IRON	●	10-20
N	ALLUMINIO E SUE LEGHE - ALUMINIUM	○	20-30
S	LEGHE RESIST. CALORE - HIG. TEMP. ALLOY		
H	MAT. DURI E TEMPRATI - HARD AND HARDENED MATERIAL		

Vc = m/min VELOCITÀ DI TAGLIO - CUTTING SPEED

MSI2174TB MF..



RIVESTIM. COATED
TIALN+C
HSSV3

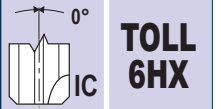
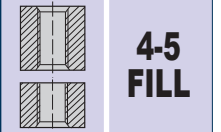

MF 8 - 24

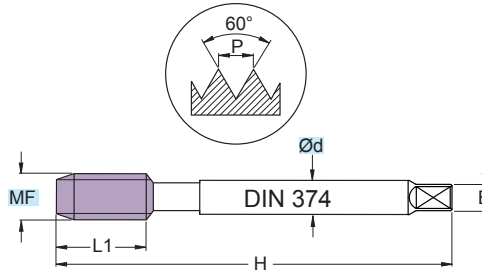

DIN 374		(mm)						
ART.	MF	P	Ød	L1	H	B	Preforo Prebore	
MSI2174TB MF8X1	8	1	6	18	90	4,9	7	
MSI2174TB MF10X1	10	1	7	15	90	5,5	9	
MSI2174TB MF10X1,25	10	1,25	7	20	100	5,5	8,75	
MSI2174TB MF12X1,25	12	1,25	9	22	100	7	10,75	
MSI2174TB MF12X1,5	12	1,5	9	22	100	7	10,5	
MSI2174TB MF14X1,5	14	1,5	11	22	100	9	12,5	
MSI2174TB MF16X1,5	16	1,5	12	22	100	9	14,5	
MSI2174TB MF18X1,5	18	1,5	14	25	110	11	16,5	
MSI2174TB MF20X1,5	20	1,5	16	25	125	12	18,5	
MSI2174TB MF22X1,5	22	1,5	18	25	125	14,5	20,5	
MSI2174TB MF24X1,5	24	1,5	18	25	140	14,5	22,5	

PARAMETRI - PARAMETERS

MATERIALI - MATERIALS Pag. 1199			Vc m/min
P	ACCIAIO - STEEL	●	25-40
	ACCIAIO AD ALTA RESISTENZA - HIGH-RESISTANCE STEEL		
M	ACCIAIO INOX - STAINLESS STEEL	●	6-15
K	GHISA - CAST IRON		
N	ALLUMINIO E SUE LEGHE - ALUMINIUM		
S	LEGHE RESIST. CALORE - HIG. TEMP. ALLOY		
H	MAT. DURI E TEMPRATI - HARD AND HARDENED MATERIAL		



Vc = m/min VELOCITÀ DI TAGLIO - CUTTING SPEED

MSI4174TB MF..

MF 8 - 24

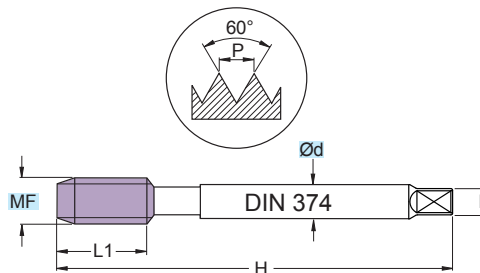

RIVESTIM.
COATED
TIALN+C

HSSV3

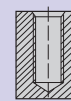

**2-3
FILL**

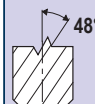

**TOLL
6HX**

DIN 374 (mm)

ART.	MF	P	Ød	L1	H	B	Preforo Prebore
MSI4174TB MF8X1	8	1	6	13	90	4,9	7
MSI4174TB MF10X1	10	1	7	15	90	5,5	9
MSI4174TB MF10X1,25	10	1,25	7	15	100	5,5	8,75
MSI4174TB MF12X1	12	1	9	13	100	7	11
MSI4174TB MF12X1,25	12	1,25	9	13	100	7	10,75
MSI4174TB MF12X1,5	12	1,5	9	13	100	7	10,5
MSI4174TB MF14X1,5	14	1,5	11	15	100	9	12,5
MSI4174TB MF16X1,5	16	1,5	12	15	100	9	14,5
MSI4174TB MF18X1,5	18	1,5	14	17	110	11	16,5
MSI4174TB MF20X1,5	20	1,5	16	17	125	12	18,5
MSI4174TB MF22X1,5	22	1,5	18	18	125	14,5	20,5
MSI4174TB MF24X1,5	24	1,5	18	20	140	14,5	22,5

PARAMETRI - PARAMETERS

MATERIALI - MATERIALS Pag. 1199			Vc m/min
P	ACCIAIO - STEEL	●	25-40
	ACCIAIO AD ALTA RESISTENZA - HIGH-RESISTANCE STEEL		
M	ACCIAIO INOX - STAINLESS STEEL	●	8-15
K	GHISA - CAST IRON		
N	ALLUMINIO E SUE LEGHE - ALUMINIUM		
S	LEGHE RESIST. CALORE - HIG. TEMP. ALLOY		
H	MAT. DURI E TEMPRATI - HARD AND HARDENED MATERIAL		

MSG1171SNS MF..
MSG1174SNS MF..

MF 8 - 30

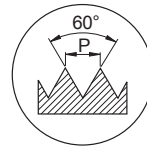

RIVESTIM.
 COATED
SNS

HSSE

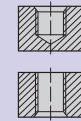

**2-3
 FILL**

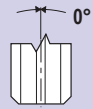

**TOLL
 6HX**

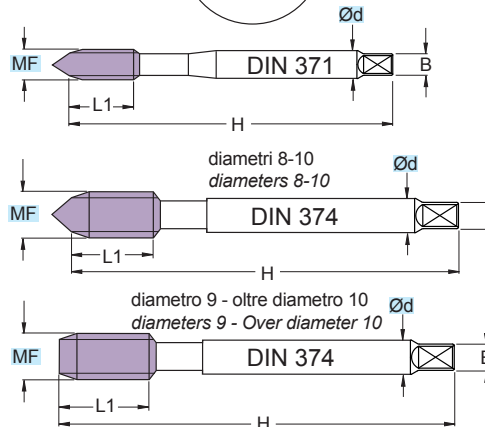

DIN 371		(mm)						Preforo Prebore
ART.	MF	P	Ød	L1	H	B		
MSG1171SNS MF8X1	8	1	8	18	90	6,2	7	
MSG1171SNS MF10X1	10	1	10	15	90	8	9	
MSG1171SNS MF10X1,25	10	1,25	10	20	100	8	8,75	

DIN 374		(mm)						Preforo Prebore
ART.	MF	P	Ød	L1	H	B		
MSG1174SNS MF8x1	8	1	6	18	90	4,9	7	
MSG1174SNS MF9x1	9	1	7	18	90	5,5	9	
MSG1174SNS MF10x1	10	1	7	15	90	5,5	9	
MSG1174SNS MF10x1,25	10	1,25	7	20	100	5,5	8,75	
MSG1174SNS MF12x1	12	1	9	22	100	7	11	
MSG1174SNS MF12x1,25	12	1,25	9	22	100	7	10,75	
MSG1174SNS MF12x1,5	12	1,5	9	22	100	7	10,5	
MSG1174SNS MF14x1	14	1	11	22	100	9	13	
MSG1174SNS MF14x1,25	14	1,25	11	22	100	9	12,75	
MSG1174SNS MF14x1,5	14	1,5	11	22	100	9	12,5	
MSG1174SNS MF16x1,5	16	1,5	12	22	100	9	14,5	
MSG1174SNS MF18x1,5	18	1,5	14	25	110	11	16,5	
MSG1174SNS MF20x1,5	20	1,5	16	25	125	12	18,5	
MSG1174SNS MF22x1,5	22	1,5	18	25	125	14,5	20,5	
MSG1174SNS MF24x1,5	24	1,5	18	25	140	14,5	22,5	
MSG1174SNS MF27x1,5	27	1,5	20	25	140	16	25,5	
MSG1174SNS MF27x2	27	2	20	25	140	16	25	
MSG1174SNS MF30x1,5	30	1,5	22	28	150	18	28,5	
MSG1174SNS MF30x2	30	2	22	28	150	18	28	

PARAMETRI - PARAMETERS

MATERIALI - MATERIALS Pag. 1199		Vc m/min
P	ACCIAIO - STEEL	
	ACCIAIO AD ALTA RESISTENZA - HIGH-RESISTANCE STEEL	
M	ACCIAIO INOX - STAINLESS STEEL	
K	GHISA - CAST IRON	● 15-30
N	ALLUMINIO E SUE LEGHE - ALUMINIUM	○ 25-30
S	LEGHE RESIST. CALORE - HIG. TEMP. ALLOY	
H	MAT. DURI E TEMPRATI - HARD AND HARDENED MATERIAL	



Vc = m/min VELOCITÀ DI TAGLIO - CUTTING SPEED

MSG010174TL MF..

MF 8 - 24

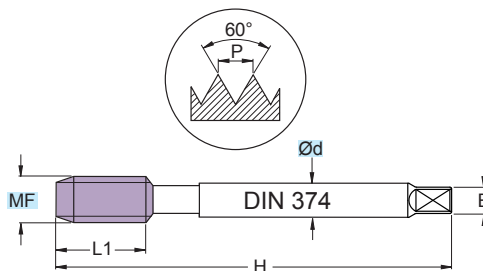

RIVESTIM. COATED TIALN	PM3
	2-3 FILL
	TOLL 6HX

DIN 374 (mm)

ART.	MF	P	Ød	L1	H	B	Preforo Prebore
MSG010174TL MF 8x1	8	1	6	18	90	4,9	7
MSG010174TL MF 10x1	10	1	7	15	90	5,5	9
MSG010174TL MF 10x1,25	10	1,25	7	20	100	5,5	8,75
MSG010174TL MF 12x1,25	12	1,25	9	22	100	7	10,75
MSG010174TL MF 12x1,5	12	1,5	9	22	100	7	10,5
MSG010174TL MF 14x1,5	14	1,5	11	22	100	9	12,5
MSG010174TL MF 16x1,5	16	1,5	12	22	100	9	14,5
MSG010174TL MF 18x1,5	18	1,5	14	25	110	11	16,5
MSG010174TL MF 20x1,5	20	1,5	16	25	125	12	18,5
MSG010174TL MF 22x1,5	22	1,5	18	25	125	14,5	20,5
MSG010174TL MF 24x1,5	24	1,5	18	25	140	14,5	22,5

PARAMETRI - PARAMETERS

MATERIALI - MATERIALS Pag. 1199		Vc m/min
P	ACCIAIO - STEEL	
	ACCIAIO AD ALTA RESISTENZA - HIGH-RESISTANCE STEEL	
M	ACCIAIO INOX - STAINLESS STEEL	
K	GHISA - CAST IRON	● 20-30
N	ALLUMINIO E SUE LEGHE - ALUMINIUM	○ 25-30
S	LEGHE RESIST. CALORE - HIG. TEMP. ALLOY	
H	MAT. DURI E TEMPRATI - HARD AND HARDENED MATERIAL	

Vc = m/min VELOCITÀ DI TAGLIO - CUTTING SPEED

MSG010174TLW MF..

MF 8 - 24



RIVESTIM. COATED TIALN	PM3
	2-3 FILL
	TOLL 6HX

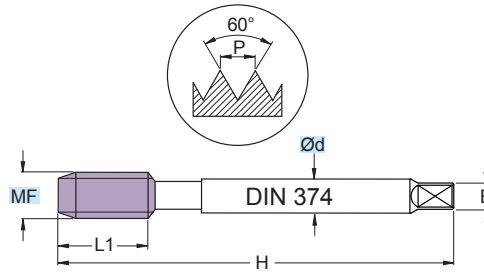

ART.	DIN 374 (mm)						
	MF	P	Ød	L1	H	B	Preforo Prebore
MSG010174TLW MF 8x1	8	1	6	18	90	4,9	7
MSG010174TLW MF 10x1	10	1	7	15	90	5,5	9
MSG010174TLW MF 10x1,25	10	1,25	7	20	100	5,5	8,75
MSG010174TLW MF 12x1,25	12	1,25	9	22	100	7	10,75
MSG010174TLW MF 12x1,5	12	1,5	9	22	100	7	10,5
MSG010174TLW MF 14x1,5	14	1,5	11	22	100	9	12,5
MSG010174TLW MF 16x1,5	16	1,5	12	22	100	9	14,5
MSG010174TLW MF 18x1,5	18	1,5	14	25	110	11	16,5
MSG010174TLW MF 20x1,5	20	1,5	16	25	125	12	18,5
MSG010174TLW MF 22x1,5	22	1,5	18	25	125	14,5	20,5
MSG010174TLW MF 24x1,5	24	1,5	18	25	140	14,5	22,5

PARAMETRI - PARAMETERS

MATERIALI - MATERIALS Pag. 1199		Vc m/min
P	ACCIAIO - STEEL	
	ACCIAIO AD ALTA RESISTENZA - HIGH-RESISTANCE STEEL	
M	ACCIAIO INOX - STAINLESS STEEL	
K	GHISA - CAST IRON	● 20-30
N	ALLUMINIO E SUE LEGHE - ALUMINIUM	○ 25-30
S	LEGHE RESIST. CALORE - HIG. TEMP. ALLOY	
H	MAT. DURI E TEMPRATI - HARD AND HARDENED MATERIAL	



Vc = m/min VELOCITÀ DI TAGLIO - CUTTING SPEED

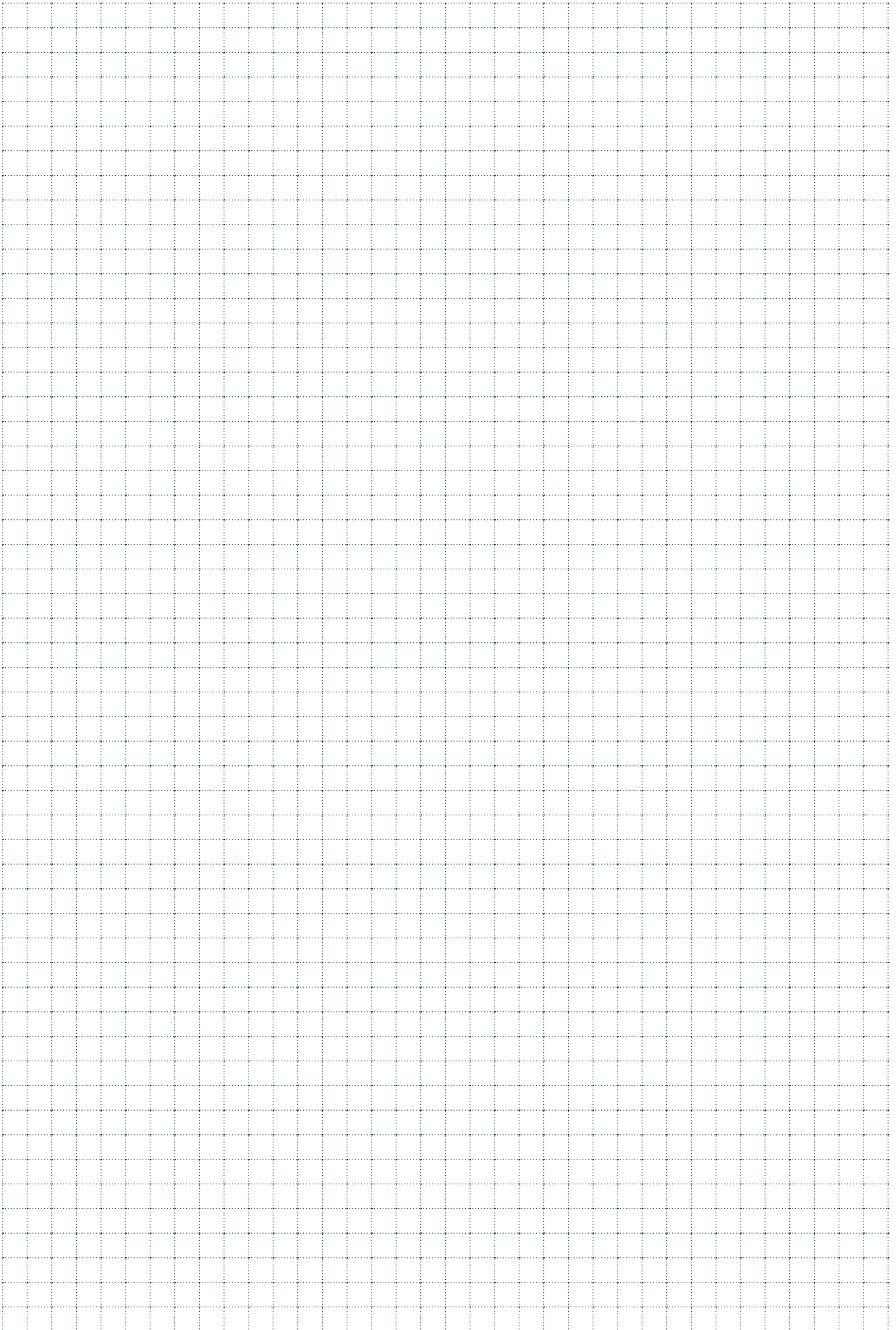



FILETTATURA AMERICANA (UNC)

US STANDARD SCREW THREAD (UNC)
GEWINDESCHNEIDEN - (UNC) GEWINDE
FILETAGE AMERICAIN (UNC)
ROSCA AMERICANA UNIFICADA DE PASO NORMAL (UNC)

MSA2376VP UNC..

UNC 1/4 - 1"

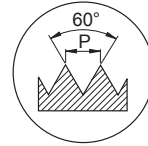

UNC

RIVESTIM. COATED VP	HSSE
	4-5 FILL
	TOLL 2B

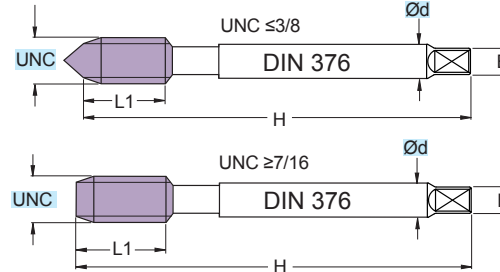

DIN 376		(mm)						
ART.	UNC(")	P/tpi	$\varnothing d$	L1	H	B	Preforo Prebore	
MSA2376VP UNC1/4-20	1/4	20	4,5	16	80	3,4	5,1	
MSA2376VP UNC5/16-18	5/16	18	6	18	90	4,9	6,6	
MSA2376VP UNC3/8-16	3/8	16	7	20	100	5,5	8,0	
MSA2376VP UNC7/16-14	7/16	14	8	20	100	6,2	9,4	
MSA2376VP UNC1/2-13	1/2	13	9	25	110	7	10,8	
MSA2376VP UNC9/16-12	9/16	12	11	28	110	9	12,2	
MSA2376VP UNC5/8-11	5/8	11	12	28	110	9	13,5	
MSA2376VP UNC3/4-10	3/4	10	14	32	125	11	16,5	
MSA2376VP UNC7/8-9	7/8	9	18	32	140	14,5	19,5	
MSA2376VP UNC1-8	1"	8	18	36	160	14,5	22,25	

P/tpi = FILETTI PER POLLICE
 P/tpi = THREADS FOR INCH-SIZES
 P/tpi = GEWINDE FÜR ZOLLABMESSUNGEN
 P/tpi = FILETS POUR POUCES

PARAMETRI - PARAMETERS

MATERIALI - MATERIALS Pag. 1199			Vc m/min
P	ACCIAIO - STEEL	●	10-15
	ACCIAIO AD ALTA RESISTENZA - HIGH-RESISTANCE STEEL		
M	ACCIAIO INOX - STAINLESS STEEL		
K	GHISA - CAST IRON		
N	ALLUMINIO E SUE LEGHE - ALUMINIUM	○	10-20
S	LEGHE RESIST. CALORE - HIG. TEMP. ALLOY		
H	MAT. DURI E TEMPRATI - HARD AND HARDENED MATERIAL		

PAG. 1172

Vc = m/min VELOCITÀ DI TAGLIO - CUTTING SPEED

MSA4376VP UNC..

UNC 1/4 - 1"

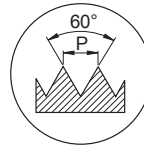

UNC

RIVESTIM.
 COATED
VP

HSSE

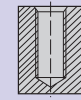

**2-3
 FILL**

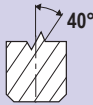

**TOLL
 2B**

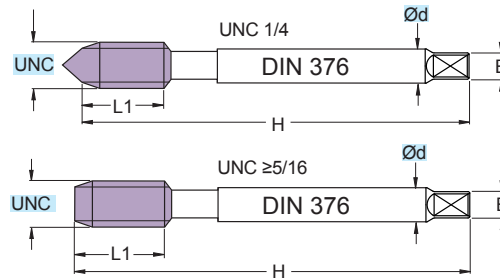

DIN 376		(mm)						
ART.	UNC(°)	P/tpi	Ød	L1	H	B	Preforo Prebore	
MSA4376VP UNC1/4-20	1/4	20	4,5	10	80	3,4	5,1	
MSA4376VP UNC5/16-18	5/16	18	6	13	90	4,9	6,6	
MSA4376VP UNC3/8-16	3/8	16	7	15	100	5,5	8,0	
MSA4376VP UNC7/16-14	7/16	14	8	15	100	6,2	9,4	
MSA4376VP UNC1/2-13	1/2	13	9	18	110	7	10,8	
MSA4376VP UNC9/16-12	9/16	12	11	20	110	9	12,2	
MSA4376VP UNC5/8-11	5/8	11	12	20	110	9	13,5	
MSA4376VP UNC3/4-10	3/4	10	14	25	125	11	16,5	
MSA4376VP UNC7/8-9	7/8	9	18	25	140	14,5	19,5	
MSA4376VP UNC1-8	1"	8	18	30	160	14,5	22,25	

P/tpi = FILETTI PER POLLICE
 P/tpi = THREADS FOR INCH-SIZES
 P/tpi = GEWINDE FÜR ZOLLMESSUNGEN
 P/tpi = FILETS POUR POUÇES

PARAMETRI - PARAMETERS

MATERIALI - MATERIALS Pag. 1199			Vc m/min
P	ACCIAIO - STEEL	●	10-15
	ACCIAIO AD ALTA RESISTENZA - HIGH-RESISTANCE STEEL		
M	ACCIAIO INOX - STAINLESS STEEL		
K	GHISA - CAST IRON		
N	ALLUMINIO E SUE LEGHE - ALUMINIUM	○	10-20
S	LEGHE RESIST. CALORE - HIG. TEMP. ALLOY		
H	MAT. DURI E TEMPRATI - HARD AND HARDENED MATERIAL		

PAG. 1172

Vc = m/min VELOCITÀ DI TAGLIO - CUTTING SPEED

MSU020371STN UNC..
MSU020376STN UNC..

UNC 4 - 1"

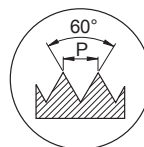

RIVESTIM.
 COATED
TT

PM3

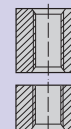

**4-5
 FILL**

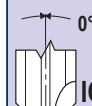

**TOLL
 2BX**

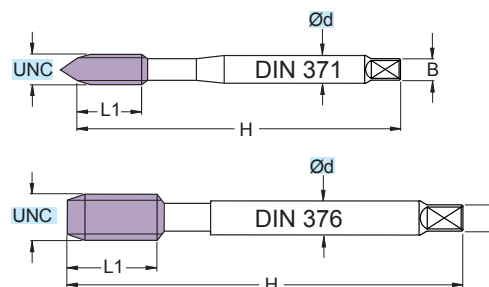

DIN 371		(mm)						Preforo Prebore
ART.	UNC(")	P/tpi	Ød	L1	H	B		
MSU020371STN UNC 4-40	4	40	3,5	10	56	2,7	2,35	
MSU020371STN UNC 5-40	5	40	3,5	10	56	2,7	2,65	
MSU020371STN UNC 6-32	6	32	4	11	56	3	2,85	
MSU020371STN UNC 8-32	8	32	4,5	13	63	3,4	3,5	
MSU020371STN UNC 10-24	10	24	6	13	70	4,9	3,9	
MSU020371STN UNC 1/4-20	1/4	20	7	16	80	5,5	5,1	
MSU020371STN UNC 5/16-18	5/16	18	8	18	90	6,2	6,6	
MSU020371STN UNC 3/8-16	3/8	16	10	20	100	8	8,0	

- P/tpi = FILETTI PER POLLICE
- P/tpi = THREADS FOR INCH-SIZES
- P/tpi = GEWINDE FÜR ZOLLABMESSUNGEN
- P/tpi = FILETS POUR POUCES

DIN 376		(mm)						Preforo Prebore
ART.	UNC(")	P/tpi	Ød	L1	H	B		
MSU020376STN UNC 7/16-14	7/16	14	8	20	100	6,2	9,4	
MSU020376STN UNC 1/2-13	1/2	13	9	25	110	7	10,8	
MSU020376STN UNC 9/16-12	9/16	12	11	28	110	9	12,2	
MSU020376STN UNC 5/8-11	5/8	11	12	28	110	9	13,5	
MSU020376STN UNC 3/4-10	3/4	10	14	32	125	11	16,5	
MSU020376STN UNC 7/8-9	7/8	9	18	32	140	14,5	19,5	
MSU020376STN UNC 1"-8	1"	8	18	36	160	14,5	22,25	

- P/tpi = FILETTI PER POLLICE
- P/tpi = THREADS FOR INCH-SIZES
- P/tpi = GEWINDE FÜR ZOLLABMESSUNGEN
- P/tpi = FILETS POUR POUCES

PARAMETRI - PARAMETERS

MATERIALI - MATERIALS Pag. 1199			Vc m/min
P	ACCIAIO - STEEL	●	15-30
	ACCIAIO AD ALTA RESISTENZA - HIGH-RESISTANCE STEEL	●	5-12
M	ACCIAIO INOX - STAINLESS STEEL	●	6-15
K	GHISA - CAST IRON	●	10-20
N	ALLUMINIO E SUE LEGHE - ALUMINIUM	●	20-30
S	LEGHE RESIST. CALORE - HIG. TEMP. ALLOY		
H	MAT. DURI E TEMPRATI - HARD AND HARDENED MATERIAL		

Vc = m/min VELOCITÀ DI TAGLIO - CUTTING SPEED

MSU150371STN UNC..
MSU150376STN UNC..

UNC 4 - 1"

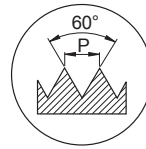

RIVESTIM.
 COATED
TT

PM3

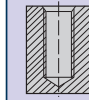

**2-3
 FILL**

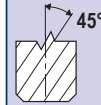

**TOLL
 2BX**

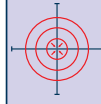

SINCRO

○ = RASTREMAZIONE - TAPER

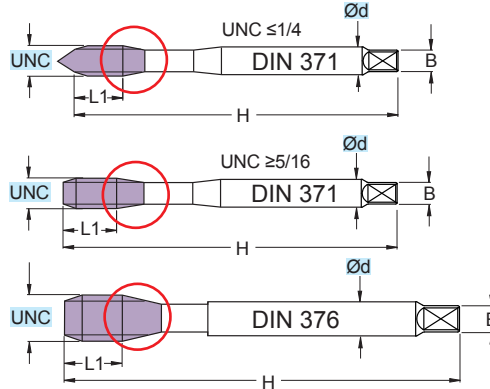

DIN 371		(mm)						
ART.	UNC(")	P/tpi	Ød	L1	H	B	Preforo Prebore	
MSU150371STN UNC 4-40	4	40	3,5	5	56	2,7	2,35	
MSU150371STN UNC 5-40	5	40	3,5	5	56	2,7	2,65	
MSU150371STN UNC 6-32	6	32	4	7	56	3	2,85	
MSU150371STN UNC 8-32	8	32	4,5	7	63	3,4	3,5	
MSU150371STN UNC 10-24	10	24	6	8	70	4,9	3,9	
MSU150371STN UNC 1/4-20	1/4	20	7	10	80	5,5	5,1	
MSU150371STN UNC 5/16-18	5/16	18	8	13	90	6,2	6,6	
MSU150371STN UNC 3/8-16	3/8	16	10	15	100	8	8,0	

- P/tpi = FILETTI PER POLLICE
- P/tpi = THREADS FOR INCH-SIZES
- P/tpi = GEWINDE FÜR ZOLLABMESSUNGEN
- P/tpi = FILETS POUR POUÇES

DIN 376		(mm)						
ART.	UNC(")	P/tpi	Ød	L1	H	B	Preforo Prebore	
MSU150376STN UNC 7/16-14	7/16	14	8	15	100	6,2	9,4	
MSU150376STN UNC 1/2-13	1/2	13	9	18	110	7	10,8	
MSU150376STN UNC 9/16-12	9/16	12	11	20	110	9	12,2	
MSU150376STN UNC 5/8-11	5/8	11	12	20	110	9	13,5	
MSU150376STN UNC 3/4-10	3/4	10	14	25	125	11	16,5	
MSU150376STN UNC 7/8-9	7/8	9	18	25	140	14,5	19,5	
MSU150376STN UNC 1"-8	1"	8	18	30	160	14,5	22,25	

- P/tpi = FILETTI PER POLLICE
- P/tpi = THREADS FOR INCH-SIZES
- P/tpi = GEWINDE FÜR ZOLLABMESSUNGEN
- P/tpi = FILETS POUR POUÇES

- PER MAGGIORI PRESTAZIONI SI CONSIGLIA MASCHIATURA SINCRONIZZATA
- FOR HIGHER PERFORMANCE WE RECOMMEND SYNCHRONIZED TAPPING
- FÜR HÖHERE LEISTUNGEN EMPFIEHLT SICH SYNCHRONISIERTES GEWINDESCHNEIDEN
- POUR PLUS DE PERFORMANCES IL EST CONSEILLE UN TARAUDAGE SYNCHRONISE

PARAMETRI - PARAMETERS

MATERIALI - MATERIALS Pag. 1199			Vc m/min
P	ACCIAIO - STEEL	●	15-30
	ACCIAIO AD ALTA RESISTENZA - HIGH-RESISTANCE STEEL	●	5-12
M	ACCIAIO INOX - STAINLESS STEEL	●	6-15
K	GHISA - CAST IRON	●	10-20
N	ALLUMINIO E SUE LEGHE - ALUMINIUM	○	20-30
S	LEGHE RESIST. CALORE - HIG. TEMP. ALLOY		
H	MAT. DURI E TEMPRATI - HARD AND HARDENED MATERIAL		

MSU150371STNW UNC..
MSU150376STNW UNC..

UNC 1/4 - 1"

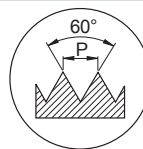

RIVESTIM.
 COATED
TT

PM3



2-3 FILL

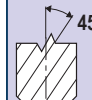

TOLL 2BX

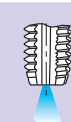

SINCRO

○ = RAS TREMAZIONE - TAPER

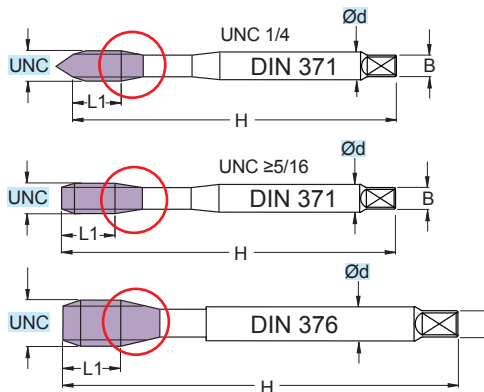

DIN 371		(mm)						Preforo Prebore
ART.	UNC(")	P/tpi	Ød	L1	H	B		
MSU150371STNW UNC 1/4-20	1/4	20	7	10	80	5,5	5,1	
MSU150371STNW UNC 5/16-18	5/16	18	8	13	90	6,2	6,6	
MSU150371STNW UNC 3/8-16	3/8	16	10	15	100	8	8,0	

P/tpi = FILETTI PER POLLICE
 P/tpi = THREADS FOR INCH-SIZES
 P/tpi = GEWINDE FÜR ZOLLABMESSUNGEN
 P/tpi = FILETS POUR POUCES

DIN 376		(mm)						Preforo Prebore
ART.	UNC(")	P/tpi	Ød	L1	H	B		
MSU150376STNW UNC 7/16-14	7/16	14	8	15	100	6,2	9,4	
MSU150376STNW UNC 1/2-13	1/2	13	9	18	110	7	10,8	
MSU150376STNW UNC 9/16-12	9/16	12	11	20	110	9	12,2	
MSU150376STNW UNC 5/8-11	5/8	11	12	20	110	9	13,5	
MSU150376STNW UNC 3/4-10	3/4	10	14	25	125	11	16,5	
MSU150376STNW UNC 7/8-9	7/8	9	18	25	140	14,5	19,5	
MSU150376STNW UNC 1"-8	1"	8	18	30	160	14,5	22,25	

P/tpi = FILETTI PER POLLICE
 P/tpi = THREADS FOR INCH-SIZES
 P/tpi = GEWINDE FÜR ZOLLABMESSUNGEN
 P/tpi = FILETS POUR POUCES

- PER MAGGIORI PRESTAZIONI SI CONSIGLIA MASCHIATURA SINCRONIZZATA
- FOR HIGHER PERFORMANCE WE RECOMMEND SYNCHRONIZED TAPPING
- FÜR HÖHERE LEISTUNGEN EMPFIEHLT SICH SYNCHRONISIERTES GEWINDESCHNEIDEN
- POUR PLUS DE PERFORMANCES IL EST CONSEILLE UN TARAUDAGE SYNCHRONISE

PARAMETRI - PARAMETERS

MATERIALI - MATERIALS Pag. 1199			Vc m/min
P	ACCIAIO - STEEL	●	15-30
	ACCIAIO AD ALTA RESISTENZA - HIGH-RESISTANCE STEEL	●	5-12
M	ACCIAIO INOX - STAINLESS STEEL	●	6-15
K	GHISA - CAST IRON	●	10-20
N	ALLUMINIO E SUE LEGHE - ALUMINIUM	○	20-30
S	LEGHE RESIST. CALORE - HIG. TEMP. ALLOY		
H	MAT. DURI E TEMPRATI - HARD AND HARDENED MATERIAL		

Vc = m/min VELOCITÀ DI TAGLIO - CUTTING SPEED

MSI020371TB UNC..
MSI020376TB UNC..

UNC 1/4 - 5/8

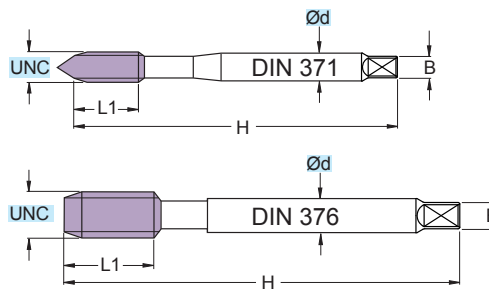
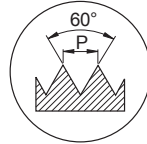

UNC

RIVESTIM.
 COATED
TIALN+C

HSSV3

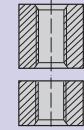

**4-5
 FILL**

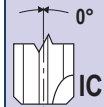

**TOLL
 2BX**

DIN 371		(mm)					
ART.	UNC(*)	P/tpi	Ød	L1	H	B	Preforo Prebore
MSI020371TB UNC 1/4-20	1/4	20	7	16	80	5,5	5,1
MSI020371TB UNC 5/16-18	5/16	18	8	18	90	6,2	6,6
MSI020371TB UNC 3/8-16	3/8	16	10	20	100	8	8,0

↑

P/tpi = FILETTI PER POLLICE
 P/tpi = THREADS FOR INCH-SIZES
 P/tpi = GEWINDE FÜR ZOLLABMESSUNGEN
 P/tpi = FILETS POUR POUCES

DIN 376		(mm)					
ART.	UNC(*)	P/tpi	Ød	L1	H	B	Preforo Prebore
MSI020376TB UNC 7/16-14	7/16	14	8	20	100	6,2	9,4
MSI020376TB UNC 1/2-13	1/2	13	9	25	110	7	10,8
MSI020376TB UNC 9/16-12	9/16	12	11	28	110	9	12,2
MSI020376TB UNC 5/8-11	5/8	11	12	28	110	9	13,5

↑

P/tpi = FILETTI PER POLLICE
 P/tpi = THREADS FOR INCH-SIZES
 P/tpi = GEWINDE FÜR ZOLLABMESSUNGEN
 P/tpi = FILETS POUR POUCES

PARAMETRI - PARAMETERS

MATERIALI - MATERIALS Pag. 1199			Vc m/min
P	ACCIAIO - STEEL	●	15-35
	ACCIAIO AD ALTA RESISTENZA - HIGH-RESISTANCE STEEL		
M	ACCIAIO INOX - STAINLESS STEEL	●	6-15
K	GHISA - CAST IRON		
N	ALLUMINIO E SUE LEGHE - ALUMINIUM		
S	LEGHE RESIST. CALORE - HIG. TEMP. ALLOY		
H	MAT. DURI E TEMPRATI - HARD AND HARDENED MATERIAL		

PAG. 1172

Vc = m/min VELOCITÀ DI TAGLIO - CUTTING SPEED

MSI160371TB UNC..
MSI160376TB UNC..

UNC 1/4 - 5/8

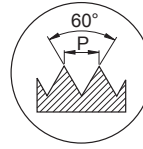

RIVESTIM. COATED
TIALN+C
HSSV3

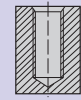

2-3 FILL

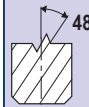

TOLL 2BX

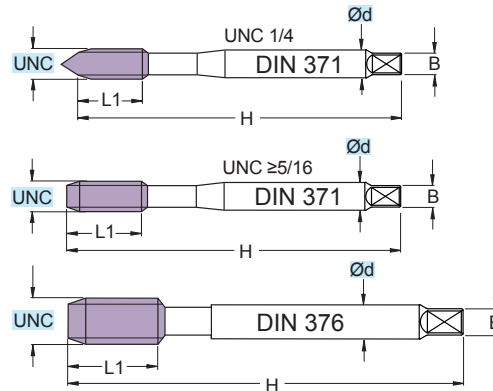

DIN 371		(mm)						Preforo Prebore
ART.	UNC(°)	P/tpi	Ød	L1	H	B		
MSI160371TB UNC 1/4-20	1/4	20	7	10	80	5,5	5,1	
MSI160371TB UNC 5/16-18	5/16	18	8	13	90	6,2	6,6	
MSI160371TB UNC 3/8-16	3/8	16	10	15	100	8	8,0	



P/tpi = FILETTI PER POLLICE
 P/tpi = THREADS FOR INCH-SIZES
 P/tpi = GEWINDE FÜR ZOLLABMESSUNGEN
 P/tpi = FILETS POUR POUCES

DIN 376		(mm)						Preforo Prebore
ART.	UNC(°)	P/tpi	Ød	L1	H	B		
MSI160376TB UNC 7/16-14	7/16	14	8	15	100	6,2	9,4	
MSI160376TB UNC 1/2-13	1/2	13	9	18	110	7	10,8	
MSI160376TB UNC 9/16-12	9/16	12	11	20	110	9	12,2	
MSI160376TB UNC 5/8-11	5/8	11	12	20	110	9	13,5	



P/tpi = FILETTI PER POLLICE
 P/tpi = THREADS FOR INCH-SIZES
 P/tpi = GEWINDE FÜR ZOLLABMESSUNGEN
 P/tpi = FILETS POUR POUCES

PARAMETRI - PARAMETERS

MATERIALI - MATERIALS Pag. 1199			Vc m/min
P	ACCIAIO - STEEL	●	15-35
	ACCIAIO AD ALTA RESISTENZA - HIGH-RESISTANCE STEEL		
M	ACCIAIO INOX - STAINLESS STEEL	●	8-15
K	GHISA - CAST IRON		
N	ALLUMINIO E SUE LEGHE - ALUMINIUM		
S	LEGHE RESIST. CALORE - HIG. TEMP. ALLOY		
H	MAT. DURI E TEMPRATI - HARD AND HARDENED MATERIAL		

Vc = m/min VELOCITÀ DI TAGLIO - CUTTING SPEED

MSG1376SNS UNC..

UNC 5/16 - 1"

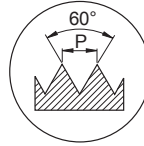

RIVESTIM.
 COATED
SNS

HSSE



**2-3
 FILL**

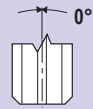

**TOLL
 2BX**

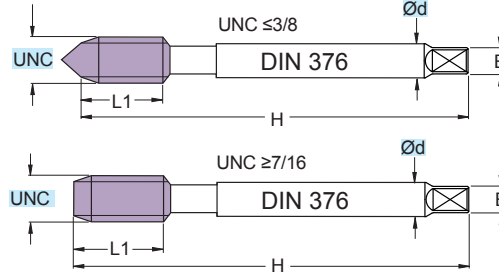

DIN 376		(mm)						
ART.	UNC(°)	P/tpi	Ød	L1	H	B	Preforo Prebore	
MSG1376SNS UNC5/16-18	5/16	18	6	18	90	4,9	6,6	
MSG1376SNS UNC3/8-16	3/8	16	7	20	100	5,5	8,0	
MSG1376SNS UNC7/16-14	7/16	14	8	20	100	6,2	9,4	
MSG1376SNS UNC1/2-13	1/2	13	9	25	110	7	10,8	
MSG1376SNS UNC9/16-12	9/16	12	11	28	110	9	12,2	
MSG1376SNS UNC5/8-11	5/8	11	12	28	110	9	13,5	
MSG1376SNS UNC3/4-10	3/4	10	14	32	125	11	16,5	
MSG1376SNS UNC7/8-9	7/8	9	18	32	140	14,5	19,5	
MSG1376SNS UNC1-8	1"	8	18	36	160	14,5	22,25	

↑

P/tpi = FILETTI PER POLLICE
 P/tpi = THREADS FOR INCH-SIZES
 P/tpi = GEWINDE FÜR ZOLLABMESSUNGEN
 P/tpi = FILETS POUR POUÇES

PARAMETRI - PARAMETERS

MATERIALI - MATERIALS Pag. 1199		Vc m/min
P	ACCIAIO - STEEL	
	ACCIAIO AD ALTA RESISTENZA - HIGH-RESISTANCE STEEL	
M	ACCIAIO INOX - STAINLESS STEEL	
K	GHISA - CAST IRON	● 15-30
N	ALLUMINIO E SUE LEGHE - ALUMINIUM	○ 25-30
S	LEGHE RESIST. CALORE - HIG. TEMP. ALLOY	
H	MAT. DURI E TEMPRATI - HARD AND HARDENED MATERIAL	

PAG. 1172

Vc = m/min VELOCITÀ DI TAGLIO - CUTTING SPEED

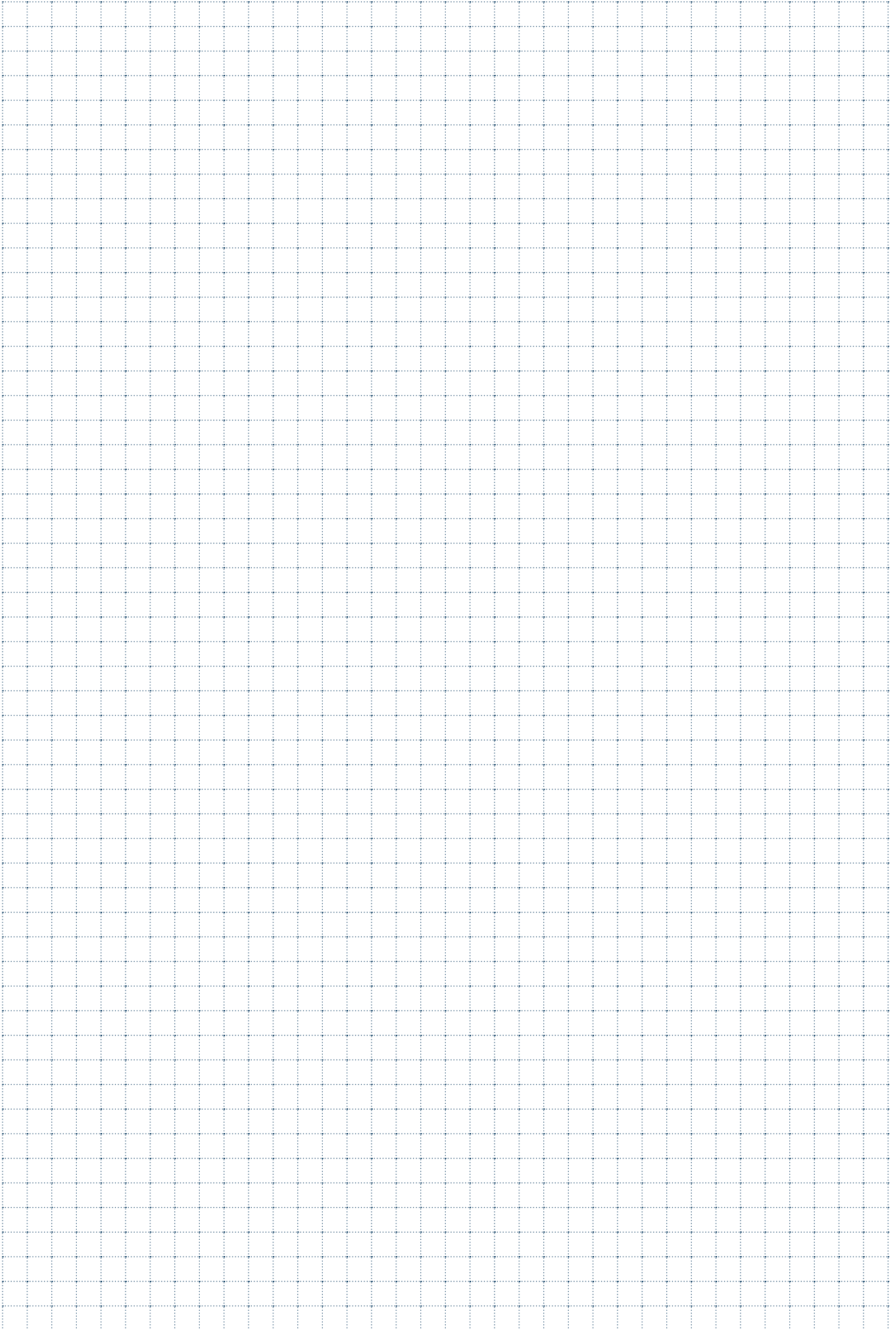



FILETTATURA AMERICANA (UNF)

US STANDARD SCREW THREAD (UNF)
GEWINDESCHNEIDEN - (UNF) GEWINDE
FILETAGE AMERICAIN (UNF)
ROSCA AMERICANA UNIFICADA DE PASO FINO (UNF)

MSA2474VP UNF..

UNF 1/4 - 1"

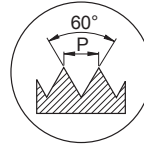

RIVESTIM. COATED VP	HSSE
	4-5 FILL
	TOLL 2B

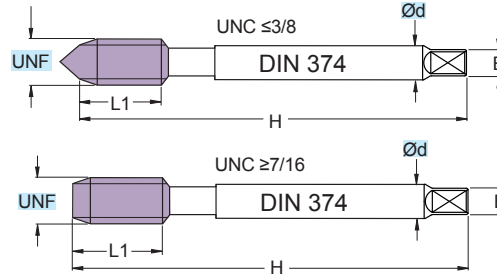

DIN 374		(mm)						
ART.	UNF(°)	P/tpi	Ød	L1	H	B	Preforo Prebore	
MSA2474VP UNF1/4-28	1/4	28	4,5	16	80	3,4	5,5	
MSA2474VP UNF5/16-24	5/16	24	6	18	90	4,9	6,9	
MSA2474VP UNF3/8-24	3/8	24	7	15	90	5,5	8,5	
MSA2474VP UNF7/16-20	7/16	20	8	20	100	6,2	9,9	
MSA2474VP UNF1/2-20	1/2	20	9	20	100	7	11,5	
MSA2474VP UNF9/16-18	9/16	18	11	22	100	9	12,9	
MSA2474VP UNF5/8-18	5/8	18	12	22	100	9	14,5	
MSA2474VP UNF3/4-16	3/4	16	14	25	110	11	17,5	
MSA2474VP UNF7/8-14	7/8	14	18	25	125	14,5	20,4	
MSA2474VP UNF1-12	1"	12	18	28	140	14,5	23,25	

P/tpi = FILETTI PER POLLICE
 P/tpi = THREADS FOR INCH-SIZES
 P/tpi = GEWINDE FÜR ZOLLABMESSUNGEN
 P/tpi = FILETS POUR POUCES

PARAMETRI - PARAMETERS

MATERIALI - MATERIALS Pag. 1199			Vc m/min
P	ACCIAIO - STEEL	●	10-15
	ACCIAIO AD ALTA RESISTENZA - HIGH-RESISTANCE STEEL		
M	ACCIAIO INOX - STAINLESS STEEL		
K	GHISA - CAST IRON		
N	ALLUMINIO E SUE LEGHE - ALUMINIUM	○	10-20
S	LEGHE RESIST. CALORE - HIG. TEMP. ALLOY		
H	MAT. DURI E TEMPRATI - HARD AND HARDENED MATERIAL		

Vc = m/min VELOCITÀ DI TAGLIO - CUTTING SPEED

MSA4474VP UNF..

UNF 1/4 - 1"

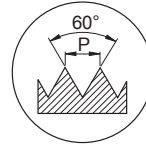

UNF

RIVESTIM. COATED
VP **HSSE**

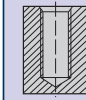

2-3 FILL

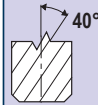

TOLL 2B

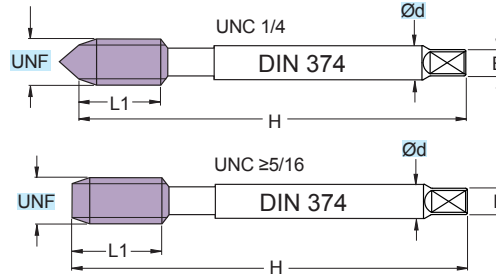

DIN 374		(mm)						
ART.	UNF(°)	P/tpi	Ød	L1	H	B	Preforo Prebore	
MSA4474VP UNF1/4-28	1/4	28	4,5	10	80	3,4	5,5	
MSA4474VP UNF5/16-24	5/16	24	6	13	90	4,9	6,9	
MSA4474VP UNF3/8-24	3/8	24	7	15	90	5,5	8,5	
MSA4474VP UNF7/16-20	7/16	20	8	15	100	6,2	9,9	
MSA4474VP UNF1/2-20	1/2	20	9	13	100	7	11,5	
MSA4474VP UNF9/16-18	9/16	18	11	15	100	9	12,9	
MSA4474VP UNF5/8-18	5/8	18	12	15	100	9	14,5	
MSA4474VP UNF3/4-16	3/4	16	14	17	110	11	17,5	
MSA4474VP UNF7/8-14	7/8	14	18	18	125	14,5	20,4	
MSA4474VP UNF1-12	1"	12	18	22	140	14,5	23,25	

P/tpi = FILETTI PER POLLICE
 P/tpi = THREADS FOR INCH-SIZES
 P/tpi = GEWINDE FÜR ZOLLABMESSUNGEN
 P/tpi = FILETS POUR POUÇES

PARAMETRI - PARAMETERS

MATERIALI - MATERIALS Pag. 1199			Vc m/min
P	ACCIAIO - STEEL	●	10-15
	ACCIAIO AD ALTA RESISTENZA - HIGH-RESISTANCE STEEL		
M	ACCIAIO INOX - STAINLESS STEEL		
K	GHISA - CAST IRON		
N	ALLUMINIO E SUE LEGHE - ALUMINIUM	○	10-20
S	LEGHE RESIST. CALORE - HIG. TEMP. ALLOY		
H	MAT. DURI E TEMPRATI - HARD AND HARDENED MATERIAL		

PAG. 1172

Vc = m/min VELOCITÀ DI TAGLIO - CUTTING SPEED

MSU020471STN UNF..
MSU020474STN UNF..

UNF 4 - 1"

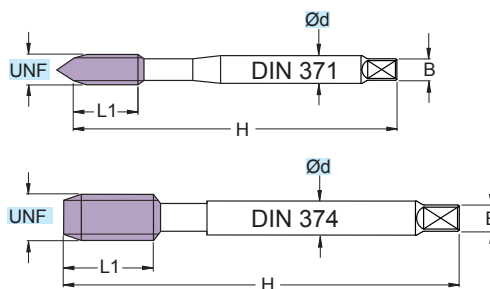
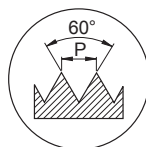

RIVESTIM. COATED TT	PM3
	4-5 FILL
	TOLL 2BX

DIN 371		(mm)					
ART.	UNF(°)	P/tpi	Ød	L1	H	B	Preforo Prebore

MSU020471STN UNF 4-48	4	48	3,5	10	56	2,7	2,4
MSU020471STN UNF 6-40	6	40	4	11	56	3	2,95
MSU020471STN UNF 8-36	8	36	4,5	13	63	3,4	3,5
MSU020471STN UNF 10-32	10	32	6	13	70	4,9	4,1
MSU020471STN UNF 1/4-28	1/4	28	7	16	80	5,5	5,5

P/tpi = FILETTI PER POLLICE
 P/tpi = THREADS FOR INCH-SIZES
 P/tpi = GEWINDE FÜR ZOLLABMESSUNGEN
 P/tpi = FILETS POUR POUCES

DIN 374		(mm)					
ART.	UNF(°)	P/tpi	Ød	L1	H	B	Preforo Prebore

MSU020474STN UNF 5/16-24	5/16	24	6	18	90	4,9	6,9
MSU020474STN UNF 3/8-24	3/8	24	7	15	90	5,5	8,5
MSU020474STN UNF 7/16-20	7/16	20	8	20	100	6,2	9,9
MSU020474STN UNF 1/2-20	1/2	20	9	20	100	7	11,5
MSU020474STN UNF 9/16-18	9/16	18	11	22	100	9	12,9
MSU020474STN UNF 5/8-18	5/8	18	12	22	100	9	14,5
MSU020474STN UNF 3/4-16	3/4	16	14	25	110	11	17,5
MSU020474STN UNF 7/8-14	7/8	14	18	25	125	14,5	20,4
MSU020474STN UNF 1"-12	1"	12	18	28	140	14,5	23,25

P/tpi = FILETTI PER POLLICE
 P/tpi = THREADS FOR INCH-SIZES
 P/tpi = GEWINDE FÜR ZOLLABMESSUNGEN
 P/tpi = FILETS POUR POUCES

PARAMETRI - PARAMETERS

MATERIALI - MATERIALS Pag. 1199			Vc m/min
P	ACCIAIO - STEEL	●	15-30
	ACCIAIO AD ALTA RESISTENZA - HIGH-RESISTANCE STEEL	●	5-12
M	ACCIAIO INOX - STAINLESS STEEL	●	6-15
K	GHISA - CAST IRON	●	10-20
N	ALLUMINIO E SUE LEGHE - ALUMINIUM	●	20-30
S	LEGHE RESIST. CALORE - HIG. TEMP. ALLOY		
H	MAT. DURI E TEMPRATI - HARD AND HARDENED MATERIAL		

MSU150471STN UNF..
MSU150474STN UNF..

UNF 4 - 1"

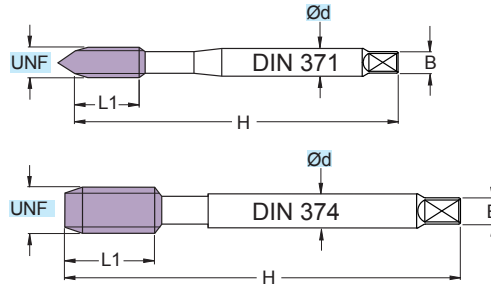
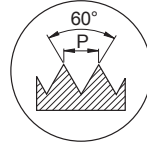

RIVESTIM. COATED
TT
PM3

2-3 FILL

45°
TOLL 2BX

SINCRO

DIN 371		(mm)						Preforo
ART.	UNF(°)	P/tpi	Ød	L1	H	B	Prebore	
MSU150471STN UNF 4-48	4	48	3,5	5	56	2,7	2,4	
MSU150471STN UNF 6-40	6	40	4	7	56	3	2,95	
MSU150471STN UNF 8-36	8	36	4,5	7	63	3,4	3,5	
MSU150471STN UNF 10-32	10	32	6	8	70	4,9	4,1	
MSU150471STN UNF 1/4-28	1/4	28	7	10	80	5,5	5,5	

P/tpi = FILETTI PER POLLICE
 P/tpi = THREADS FOR INCH-SIZES
 P/tpi = GEWINDE FÜR ZOLLABMESSUNGEN
 P/tpi = FILETS POUR POUCES

DIN 374		(mm)						Preforo
ART.	UNF(°)	P/tpi	Ød	L1	H	B	Prebore	
MSU150474STN UNF 5/16-24	5/16	24	6	13	90	4,9	6,9	
MSU150474STN UNF 3/8-24	3/8	24	7	15	90	5,5	8,5	
MSU150474STN UNF 7/16-20	7/16	20	8	15	100	6,2	9,9	
MSU150474STN UNF 1/2-20	1/2	20	9	13	100	7	11,5	
MSU150474STN UNF 9/16-18	9/16	18	11	15	100	9	12,9	
MSU150474STN UNF 5/8-18	5/8	18	12	15	100	9	14,5	
MSU150474STN UNF 3/4-16	3/4	16	14	17	110	11	17,5	
MSU150474STN UNF 7/8-14	7/8	14	18	18	125	14,5	20,4	
MSU150474STN UNF 1"-12	1"	12	18	22	140	14,5	23,25	

P/tpi = FILETTI PER POLLICE
 P/tpi = THREADS FOR INCH-SIZES
 P/tpi = GEWINDE FÜR ZOLLABMESSUNGEN
 P/tpi = FILETS POUR POUCES

- PER MAGGIORI PRESTAZIONI SI CONSIGLIA MASCHIATURA SINCRONIZZATA
- FOR HIGHER PERFORMANCE WE RECOMMEND SYNCHRONIZED TAPPING
- FÜR HÖHERE LEISTUNGEN EMPFIEHLT SICH SYNCHRONISIERTES GEWINDESCHNEIDEN
- POUR PLUS DE PERFORMANCES IL EST CONSEILLE UN TARAUDAGE SYNCHRONISE

PARAMETRI - PARAMETERS

MATERIALI - MATERIALS Pag. 1199			Vc m/min
P	ACCIAIO - STEEL	●	15-30
	ACCIAIO AD ALTA RESISTENZA - HIGH-RESISTANCE STEEL	●	5-12
M	ACCIAIO INOX - STAINLESS STEEL	●	6-15
K	GHISA - CAST IRON	●	10-20
N	ALLUMINIO E SUE LEGHE - ALUMINIUM	○	20-30
S	LEGHE RESIST. CALORE - HIG. TEMP. ALLOY		
H	MAT. DURI E TEMPRATI - HARD AND HARDENED MATERIAL		

Vc = m/min VELOCITÀ DI TAGLIO - CUTTING SPEED

MSU150471STNW UNF..
MSU150474STNW UNF..

UNF 1/4 - 1"

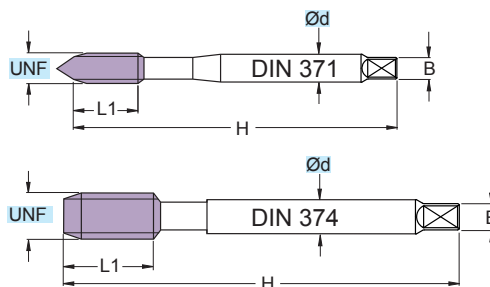
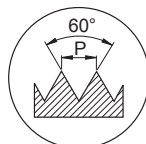

RIVESTIM.
COATED
TT

PM3



**2-3
FILL**

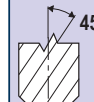

**TOLL
2BX**

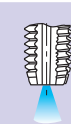

SINCRO

DIN 371		(mm)						Preforo Prebore
ART.	UNF(") P/tpi	Ød	L1	H	B			
MSU150471STNW UNF 1/4-28	1/4 28	7	10	80	5,5		5,5	

P/tpi = FILETTI PER POLLICE
 P/tpi = THREADS FOR INCH-SIZES
 P/tpi = GEWINDE FÜR ZOLLABMESSUNGEN
 P/tpi = FILETS POUR POUCES

DIN 374		(mm)						Preforo Prebore
ART.	UNF(") P/tpi	Ød	L1	H	B			
MSU150474STNW UNF 5/16-24	5/16 24	6	13	90	4,9		6,9	
MSU150474STNW UNF 3/8-24	3/8 24	7	15	90	5,5		8,5	
MSU150474STNW UNF 7/16-20	7/16 20	8	15	100	6,2		9,9	
MSU150474STNW UNF 1/2-20	1/2 20	9	13	100	7		11,5	
MSU150474STNW UNF 9/16-18	9/16 18	11	15	100	9		12,9	
MSU150474STNW UNF 5/8-18	5/8 18	12	15	100	9		14,5	
MSU150474STNW UNF 3/4-16	3/4 16	14	17	110	11		17,5	
MSU150474STNW UNF 7/8-14	7/8 14	18	18	125	14,5		20,4	
MSU150474STNW UNF 1"-12	1" 12	18	22	140	14,5		23,25	

P/tpi = FILETTI PER POLLICE
 P/tpi = THREADS FOR INCH-SIZES
 P/tpi = GEWINDE FÜR ZOLLABMESSUNGEN
 P/tpi = FILETS POUR POUCES

- PER MAGGIORI PRESTAZIONI SI CONSIGLIA MASCHIATURA SINCRONIZZATA
- FOR HIGHER PERFORMANCE WE RECOMMEND SYNCHRONIZED TAPPING
- FÜR HÖHERE LEISTUNGEN EMPFIEHLT SICH SYNCHRONISIERTES GEWINDESCHNEIDEN
- POUR PLUS DE PERFORMANCES IL EST CONSEILLE UN TARAUDAGE SYNCHRONISE

PARAMETRI - PARAMETERS

MATERIALI - MATERIALS Pag. 1199			Vc m/min
P	ACCIAIO - STEEL	●	15-30
	ACCIAIO AD ALTA RESISTENZA - HIGH-RESISTANCE STEEL	●	5-12
M	ACCIAIO INOX - STAINLESS STEEL	●	6-15
K	GHISA - CAST IRON	●	10-20
N	ALLUMINIO E SUE LEGHE - ALUMINIUM	○	20-30
S	LEGHE RESIST. CALORE - HIG. TEMP. ALLOY		
H	MAT. DURI E TEMPRATI - HARD AND HARDENED MATERIAL		

Vc = m/min VELOCITÀ DI TAGLIO - CUTTING SPEED

MSI020471TB UNF..
MSI020474TB UNF..

UNF 1/4 - 5/8

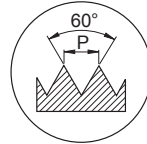

RIVESTIM. COATED TIALN+C	HSSV3
	4-5 FILL
	TOLL 2BX

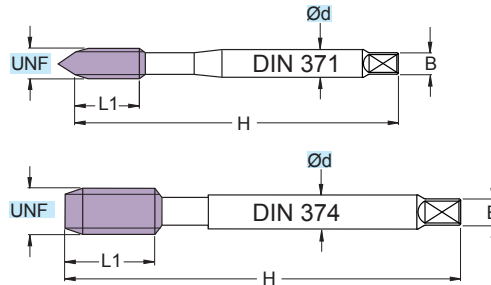

DIN 371		(mm)						
ART.	UNF(*)	P/tpi	Ød	L1	H	B	Preforo Prebore	
MSI020471TB UNF 1/4-28	1/4	28	7	16	80	5,5	5,5	

DIN 374		(mm)						
ART.	UNF(*)	P/tpi	Ød	L1	H	B	Preforo Prebore	
MSI020474TB UNF 5/16-24	5/16	24	6	18	90	4,9	6,9	
MSI020474TB UNF 3/8-24	3/8	24	7	15	90	5,5	8,5	
MSI020474TB UNF 7/16-20	7/16	20	8	20	100	6,2	9,9	
MSI020474TB UNF 1/2-20	1/2	20	9	20	100	7	11,5	
MSI020474TB UNF 9/16-18	9/16	18	11	22	100	9	12,9	
MSI020474TB UNF 5/8-18	5/8	18	12	22	100	9	14,5	



P/tpi = FILETTI PER POLLICE
 P/tpi = THREADS FOR INCH-SIZES
 P/tpi = GEWINDE FÜR ZOLLABMESSUNGEN
 P/tpi = FILETS POUR POUCES

PARAMETRI - PARAMETERS

MATERIALI - MATERIALS Pag. 1199			Vc m/min
P	ACCIAIO - STEEL	●	15-35
	ACCIAIO AD ALTA RESISTENZA - HIGH-RESISTANCE STEEL		
M	ACCIAIO INOX - STAINLESS STEEL	●	6-15
K	GHISA - CAST IRON		
N	ALLUMINIO E SUE LEGHE - ALUMINIUM		
S	LEGHE RESIST. CALORE - HIG. TEMP. ALLOY		
H	MAT. DURI E TEMPRATI - HARD AND HARDENED MATERIAL		



Vc = m/min VELOCITÀ DI TAGLIO - CUTTING SPEED

MSI160471TB UNF..
MSI160474TB UNF..

UNF 1/4 - 5/8

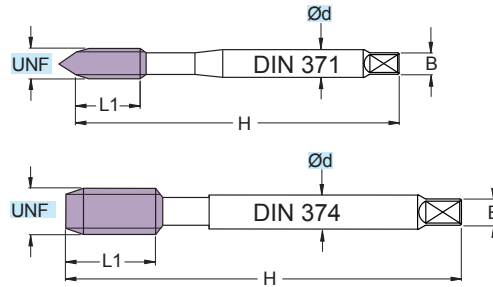
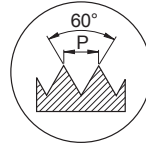

RIVESTIM. COATED TIALN+C	HSSV3
	2-3 FILL
	TOLL 2BX

DIN 371		(mm)					
ART.	UNF(°)	P/tpi	Ød	L1	H	B	Preforo Prebore
MSI160471TB UNF 1/4-28	1/4	28	7	10	80	5,5	5,5

DIN 374		(mm)					
ART.	UNF(°)	P/tpi	Ød	L1	H	B	Preforo Prebore
MSI160474TB UNF 5/16-24	5/16	24	6	13	90	4,9	6,9
MSI160474TB UNF 3/8-24	3/8	24	7	15	90	5,5	8,5
MSI160474TB UNF 7/16-20	7/16	20	8	15	100	6,2	9,9
MSI160474TB UNF 1/2-20	1/2	20	9	13	100	7	11,5
MSI160474TB UNF 9/16-18	9/16	18	11	15	100	9	12,9
MSI160474TB UNF 5/8-18	5/8	18	12	15	100	9	14,5

P/tpi = FILETTI PER POLLICE
 P/tpi = THREADS FOR INCH-SIZES
 P/tpi = GEWINDE FÜR ZOLLABMESSUNGEN
 P/tpi = FILETS POUR POUCES

PARAMETRI - PARAMETERS

MATERIALI - MATERIALS Pag. 1199			Vc m/min
P	ACCIAIO - STEEL	●	15-35
	ACCIAIO AD ALTA RESISTENZA - HIGH-RESISTANCE STEEL		
M	ACCIAIO INOX - STAINLESS STEEL	●	8-15
K	GHISA - CAST IRON		
N	ALLUMINIO E SUE LEGHE - ALUMINIUM		
S	LEGHE RESIST. CALORE - HIG. TEMP. ALLOY		
H	MAT. DURI E TEMPRATI - HARD AND HARDENED MATERIAL		

Vc = m/min VELOCITÀ DI TAGLIO - CUTTING SPEED

MSG1474SNS UNF..

UNF 1/4 - 1"

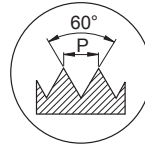

RIVESTIM.
 COATED
SNS

HSSE

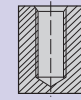

**2-3
 FILL**

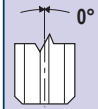

**TOLL
 2BX**

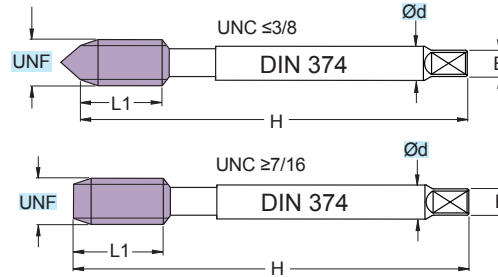

DIN 374 (mm)

ART.	UNF(°)	P/tpi	Ød	L1	H	B	Preforo Prebore
MSG1474SNS UNF1/4-28	1/4	28	4,5	16	80	3,4	5,5
MSG1474SNS UNF5/16-24	5/16	24	6	18	90	4,9	6,9
MSG1474SNS UNF3/8-24	3/8	24	7	15	90	5,5	8,5
MSG1474SNS UNF7/16-20	7/16	20	8	20	100	6,2	9,9
MSG1474SNS UNF1/2-20	1/2	20	9	20	100	7	11,5
MSG1474SNS UNF9/16-18	9/16	18	11	22	100	9	12,9
MSG1474SNS UNF5/8-18	5/8	18	12	22	100	9	14,5
MSG1474SNS UNF3/4-16	3/4	16	14	25	110	11	17,5
MSG1474SNS UNF7/8-14	7/8	14	18	25	125	14,5	20,4
MSG1474SNS UNF1-12	1"	12	18	28	140	14,5	23,25

P/tpi = FILETTI PER POLLICE
 P/tpi = THREADS FOR INCH-SIZES
 P/tpi = GEWINDE FÜR ZOLLABMESSUNGEN
 P/tpi = FILETS POUR POUCES

PARAMETRI - PARAMETERS

MATERIALI - MATERIALS Pag. 1199		Vc m/min
P	ACCIAIO - STEEL	
	ACCIAIO AD ALTA RESISTENZA - HIGH-RESISTANCE STEEL	
M	ACCIAIO INOX - STAINLESS STEEL	
K	GHISA - CAST IRON	● 15-30
N	ALLUMINIO E SUE LEGHE - ALUMINIUM	○ 25-30
S	LEGHE RESIST. CALORE - HIG. TEMP. ALLOY	
H	MAT. DURI E TEMPRATI - HARD AND HARDENED MATERIAL	

PAG. 1172

Vc = m/min VELOCITÀ DI TAGLIO - CUTTING SPEED

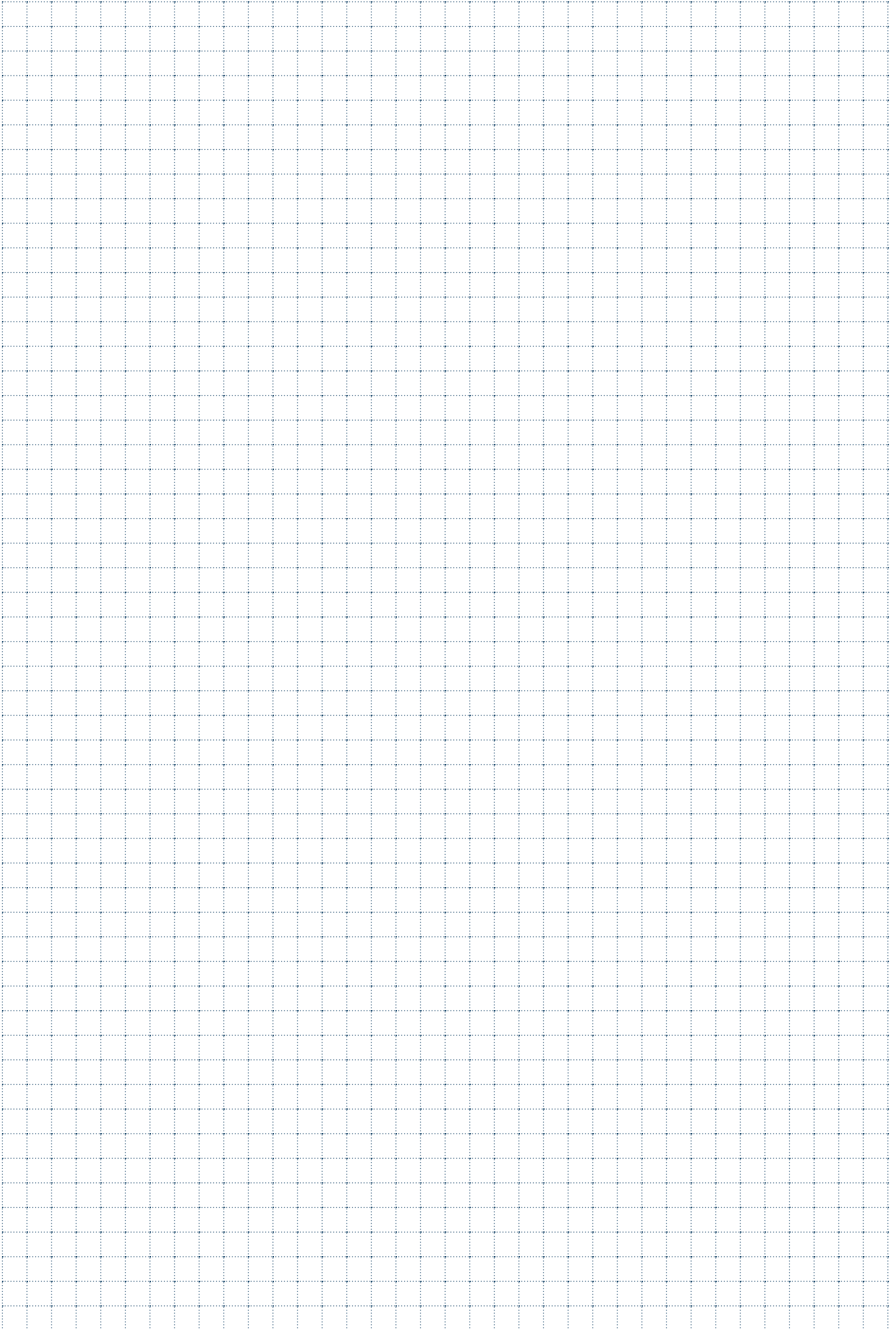



FILETTATURA GAS CILINDRICA

CYLINDRICAL SCREW THREAD (GAS)
GEWINDESCHNEIDEN - (GAS) GEWINDE
FILETAGE (GAS) CYLINDRIQUE
MACHOS DE MAQUINA - ROSCA (GAS)

MSA2256VP G..



RIVESTIM.
COATED
VP

HSSE

G 1/8 - 1"

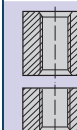
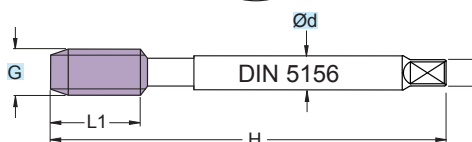
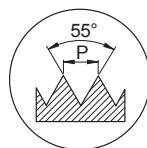

4-5 FILL

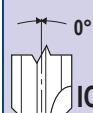

TOLL ISO 228

DIN 5156		(mm)						
ART.	G(")	P/tpi	Ød	L1	H	B	Preforo Prebore	
MSA2256VP G1/8-28	1/8	28	7	15	90	5,5	8,8	
MSA2256VP G1/4-19	1/4	19	11	22	100	9	11,8	
MSA2256VP G3/8-19	3/8	19	12	22	100	9	15,25	
MSA2256VP G1/2-14	1/2	14	16	25	125	12	19	
MSA2256VP G3/4-14	3/4	14	20	25	140	16	24,5	
MSA2256VP G1-11	1"	11	25	30	160	20	30,75	



- P/tpi = FILETTI PER POLLICE
- P/tpi = THREADS FOR INCH-SIZES
- P/tpi = GEWINDE FÜR ZOLLABMESSUNGEN
- P/tpi = FILETS POUR POUCES

PARAMETRI - PARAMETERS

MATERIALI - MATERIALS Pag. 1199			Vc m/min
P	ACCIAIO - STEEL	●	10-15
	ACCIAIO AD ALTA RESISTENZA - HIGH-RESISTANCE STEEL		
M	ACCIAIO INOX - STAINLESS STEEL		
K	GHISA - CAST IRON		
N	ALLUMINIO E SUE LEGHE - ALUMINIUM	○	10-20
S	LEGHE RESIST. CALORE - HIG. TEMP. ALLOY		
H	MAT. DURI E TEMPRATI - HARD AND HARDENED MATERIAL		

MSA4256VP G..



RIVESTIM.
 COATED
VP

HSSE

G 1/8 - 1"

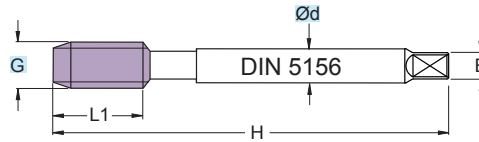
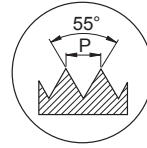

**2-3
 FILL**

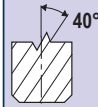

**TOLL
 ISO
 228**

DIN 5156		(mm)						
ART.	G(°)	P/tpi	Ød	L1	H	B	Preforo Prebore	
MSA4256VP G1/8-28	1/8	28	7	15	90	5,5	8,8	
MSA4256VP G1/4-19	1/4	19	11	15	100	9	11,8	
MSA4256VP G3/8-19	3/8	19	12	15	100	9	15,25	
MSA4256VP G1/2-14	1/2	14	16	18	125	12	19	
MSA4256VP G3/4-14	3/4	14	20	20	140	16	24,5	
MSA4256VP G1-11	1"	11	25	24	160	20	30,75	



- P/tpi = FILETTI PER POLLICE
- P/tpi = THREADS FOR INCH-SIZES
- P/tpi = GEWINDE FÜR ZOLLABMESSUNGEN
- P/tpi = FILETS POUR POUÇES

PARAMETRI - PARAMETERS

MATERIALI - MATERIALS Pag. 1199			Vc m/min
P	ACCIAIO - STEEL	●	10-15
	ACCIAIO AD ALTA RESISTENZA - HIGH-RESISTANCE STEEL		
M	ACCIAIO INOX - STAINLESS STEEL		
K	GHISA - CAST IRON		
N	ALLUMINIO E SUE LEGHE - ALUMINIUM	○	10-20
S	LEGHE RESIST. CALORE - HIG. TEMP. ALLOY		
H	MAT. DURI E TEMPRATI - HARD AND HARDENED MATERIAL		



Vc = m/min VELOCITÀ DI TAGLIO - CUTTING SPEED

MSU020256STN G..

G 1/8 - 3/4



RIVESTIM.
 COATED
TT

PM3

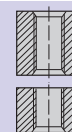

**4-5
 FILL**

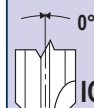

**TOLL
 ISO
 228"X"**

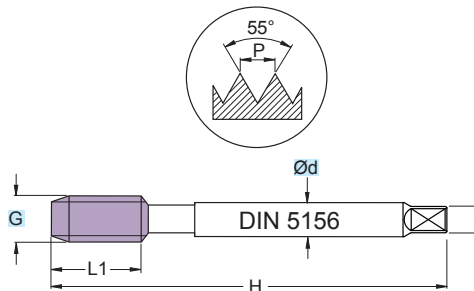

DIN 5156		(mm)						Preforo Prebore
ART.	G(*)	P/tpi	Ød	L1	H	B		
MSU020256STN G1/8-28	1/8	28	7	15	90	5,5	8,8	
MSU020256STN G1/4-19	1/4	19	11	22	100	9	11,8	
MSU020256STN G3/8-19	3/8	19	12	22	100	9	15,25	
MSU020256STN G1/2-14	1/2	14	16	25	125	12	19	
MSU020256STN G3/4-14	3/4	14	20	25	140	16	24,5	

P/tpi = FILETTI PER POLLICE
 P/tpi = THREADS FOR INCH-SIZES
 P/tpi = GEWINDE FÜR ZOLLABMESSUNGEN
 P/tpi = FILETS POUR POUCES

PARAMETRI - PARAMETERS

MATERIALI - MATERIALS Pag. 1199			Vc m/min
P	ACCIAIO - STEEL	●	15-30
	ACCIAIO AD ALTA RESISTENZA - HIGH-RESISTANCE STEEL	●	5-12
M	ACCIAIO INOX - STAINLESS STEEL	●	6-15
K	GHISA - CAST IRON	●	10-20
N	ALLUMINIO E SUE LEGHE - ALUMINIUM	●	20-30
S	LEGHE RESIST. CALORE - HIG. TEMP. ALLOY		
H	MAT. DURI E TEMPRATI - HARD AND HARDENED MATERIAL		



Vc = m/min VELOCITÀ DI TAGLIO - CUTTING SPEED

MSU150256STN G..

G 1/8 - 1"

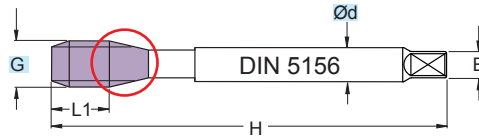
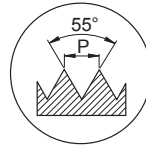

○ = RASTREMAZIONE - TAPER



RIVESTIM.
COATED
TT

PM3

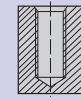

**2-3
FILL**

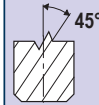

**TOLL
ISO
228"X"**

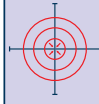

SINCRO

DIN 5156		(mm)						
ART.	G(")	P/tpi	Ød	L1	H	B	Preforo Prebore	
MSU150256STN G1/8-28	1/8	28	7	15	90	5,5	8,8	
MSU150256STN G1/4-19	1/4	19	11	15	100	9	11,8	
MSU150256STN G3/8-19	3/8	19	12	15	100	9	15,25	
MSU150256STN G1/2-14	1/2	14	16	18	125	12	19	
MSU150256STN G3/4-14	3/4	14	20	20	140	16	24,5	
MSU150256STN G1"-11	1"	11	25	24	160	20	30,75	

	P/tpi = FILETTI PER POLLICE
	P/tpi = THREADS FOR INCH-SIZES
	P/tpi = GEWINDE FÜR ZOLLABMESSUNGEN
	P/tpi = FILETS POUR POUÇES

- PER MAGGIORI PRESTAZIONI SI CONSIGLIA MASCHIATURA SINCRONIZZATA
- FOR HIGHER PERFORMANCE WE RECOMMEND SYNCHRONIZED TAPPING
- FÜR HÖHERE LEISTUNGEN EMPFIEHLT SICH SYNCHRONISIERTES GEWINDESCHNEIDEN
- POUR PLUS DE PERFORMANCES IL EST CONSEILLE UN TARAUDAGE SYNCHRONISE

PARAMETRI - PARAMETERS

MATERIALI - MATERIALS Pag. 1199			Vc m/min
P	ACCIAIO - STEEL	●	15-30
	ACCIAIO AD ALTA RESISTENZA - HIGH-RESISTANCE STEEL	●	5-12
M	ACCIAIO INOX - STAINLESS STEEL	●	6-15
K	GHISA - CAST IRON	●	10-20
N	ALLUMINIO E SUE LEGHE - ALUMINIUM	○	20-30
S	LEGHE RESIST. CALORE - HIG. TEMP. ALLOY		
H	MAT. DURI E TEMPRATI - HARD AND HARDENED MATERIAL		



Vc = m/min VELOCITÀ DI TAGLIO - CUTTING SPEED

MSU150256STNW G..

G 1/8 - 1"



RIVESTIM.
COATED
TT

PM3

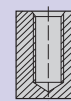

**2-3
FILL**

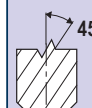

**TOLL
ISO
228"X"**

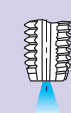

SINCRO

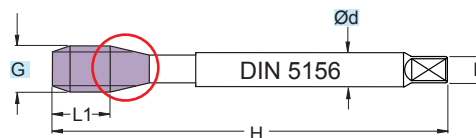
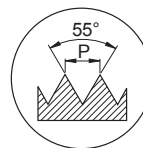

○ = RASTREMAZIONE - TAPER

DIN 5156		(mm)						Preforo Prebore
ART.	G(")	P/tpi	Ød	L1	H	B		
MSU150256STNW G1/8-28	1/8	28	7	15	90	5,5	8,8	
MSU150256STNW G1/4-19	1/4	19	11	15	100	9	11,8	
MSU150256STNW G3/8-19	3/8	19	12	15	100	9	15,25	
MSU150256STNW G1/2-14	1/2	14	16	18	125	12	19	
MSU150256STNW G3/4-14	3/4	14	20	20	140	16	24,5	
MSU150256STNW G1"-11	1"	11	25	24	160	20	30,75	

- P/tpi = FILETTI PER POLLICE
- P/tpi = THREADS FOR INCH-SIZES
- P/tpi = GEWINDE FÜR ZOLLABMESSUNGEN
- P/tpi = FILETS POUR POUCES

- PER MAGGIORI PRESTAZIONI SI CONSIGLIA MASCHIATURA SINCRONIZZATA
- FOR HIGHER PERFORMANCE WE RECOMMEND SYNCHRONIZED TAPPING
- FÜR HÖHERE LEISTUNGEN EMPFIEHLT SICH SYNCHRONISIERTES GEWINDESCHNEIDEN
- POUR PLUS DE PERFORMANCES IL EST CONSEILLE UN TARAUDAGE SYNCHRONISE

PARAMETRI - PARAMETERS

MATERIALI - MATERIALS Pag. 1199			Vc m/min
P	ACCIAIO - STEEL	●	15-30
	ACCIAIO AD ALTA RESISTENZA - HIGH-RESISTANCE STEEL	●	5-12
M	ACCIAIO INOX - STAINLESS STEEL	●	6-15
K	GHISA - CAST IRON	●	10-20
N	ALLUMINIO E SUE LEGHE - ALUMINIUM	○	20-30
S	LEGHE RESIST. CALORE - HIG. TEMP. ALLOY		
H	MAT. DURI E TEMPRATI - HARD AND HARDENED MATERIAL		

Vc = m/min VELOCITÀ DI TAGLIO - CUTTING SPEED

MSI020256TB G..



RIVESTIM.
COATED
TIALN+C

HSSV3

G 1/8 - 3/4

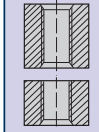
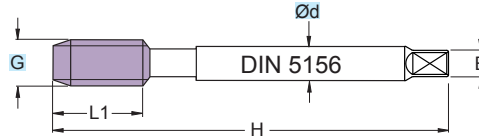
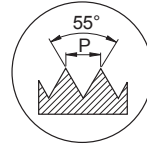

**4-5
FILL**

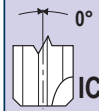

**TOLL
ISO
228"X"**

DIN 5156		(mm)						Preforo Prebore
ART.	G(°)	P/tpi	Ød	L1	H	B		
MSI020256TB G 1/8-28	1/8	28	7	15	90	5,5	8,8	
MSI020256TB G 1/4-19	1/4	19	11	22	100	9	11,8	
MSI020256TB G 3/8-19	3/8	19	12	22	100	9	15,25	
MSI020256TB G 1/2-14	1/2	14	16	25	125	12	19	
MSI020256TB G 3/4-14	3/4	14	20	25	140	16	24,5	



P/tpi = FILETTI PER POLLICE
 P/tpi = THREADS FOR INCH-SIZES
 P/tpi = GEWINDE FÜR ZOLLABMESSUNGEN
 P/tpi = FILETS POUR POUCES

PARAMETRI - PARAMETERS

MATERIALI - MATERIALS Pag. 1199			Vc m/min
P	ACCIAIO - STEEL	●	15-35
	ACCIAIO AD ALTA RESISTENZA - HIGH-RESISTANCE STEEL		
M	ACCIAIO INOX - STAINLESS STEEL	●	6-15
K	GHISA - CAST IRON		
N	ALLUMINIO E SUE LEGHE - ALUMINIUM		
S	LEGHE RESIST. CALORE - HIG. TEMP. ALLOY		
H	MAT. DURI E TEMPRATI - HARD AND HARDENED MATERIAL		



Vc = m/min VELOCITÀ DI TAGLIO - CUTTING SPEED

MSI160256TB G..

G 1/8 - 1"



RIVESTIM. COATED TIALN+C	HSSV3
	2-3 FILL
	TOLL ISO 228"X"

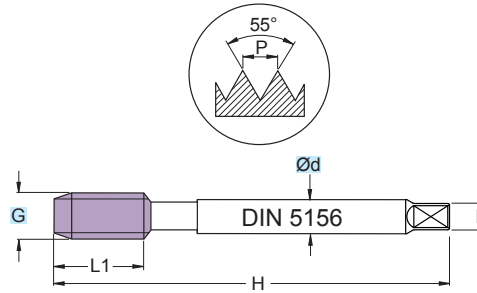

DIN 5156		(mm)						Preforo Prebore
ART.	G(")	P/tpi	Ød	L1	H	B		
MSI160256TB G 1/8-28	1/8	28	7	15	90	5,5	8,8	
MSI160256TB G 1/4-19	1/4	19	11	15	100	9	11,8	
MSI160256TB G 3/8-19	3/8	19	12	15	100	9	15,25	
MSI160256TB G 1/2-14	1/2	14	16	18	125	12	19	
MSI160256TB G 3/4-14	3/4	14	20	20	140	16	24,5	
MSI160256TB G 1-11	1"	11	25	24	160	20	30,75	



- P/tpi = FILETTI PER POLLICE
- P/tpi = THREADS FOR INCH-SIZES
- P/tpi = GEWINDE FÜR ZOLLABMESSUNGEN
- P/tpi = FILETS POUR POUÇES

PARAMETRI - PARAMETERS

MATERIALI - MATERIALS Pag. 1199			Vc m/min
P	ACCIAIO - STEEL	●	15-35
	ACCIAIO AD ALTA RESISTENZA - HIGH-RESISTANCE STEEL		
M	ACCIAIO INOX - STAINLESS STEEL	●	8-15
K	GHISA - CAST IRON		
N	ALLUMINIO E SUE LEGHE - ALUMINIUM		
S	LEGHE RESIST. CALORE - HIG. TEMP. ALLOY		
H	MAT. DURI E TEMPRATI - HARD AND HARDENED MATERIAL		

Vc = m/min VELOCITÀ DI TAGLIO - CUTTING SPEED

MSG1256SNS G..



RIVESTIM.
 COATED
SNS

HSSE

G 1/8 - 1"

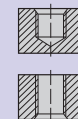
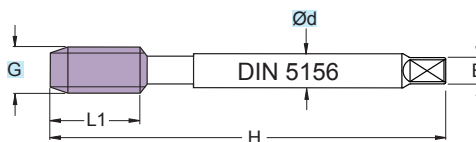
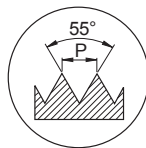

**2-3
 FILL**

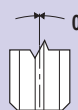

**TOLL
 ISO
 228"X"**

DIN 5156		(mm)						Preforo Prebore
ART.	G(")	P/tpi	Ød	L1	H	B		
MSG1256SNS G1/8-28	1/8	28	7	15	90	5,5	8,8	
MSG1256SNS G1/4-19	1/4	19	11	22	100	9	11,8	
MSG1256SNS G3/8-19	3/8	19	12	22	100	9	15,25	
MSG1256SNS G1/2-14	1/2	14	16	25	125	12	19	
MSG1256SNS G3/4-14	3/4	14	20	25	140	16	24,5	
MSG1256SNS G1-11	1"	11	25	30	160	20	30,75	



- P/tpi = FILETTI PER POLLICE
- P/tpi = THREADS FOR INCH-SIZES
- P/tpi = GEWINDE FÜR ZOLLABMESSUNGEN
- P/tpi = FILETS POUR POUCES

PARAMETRI - PARAMETERS

MATERIALI - MATERIALS		Pag. 1199	Vc m/min
P	ACCIAIO - STEEL		
	ACCIAIO AD ALTA RESISTENZA - HIGH-RESISTANCE STEEL		
M	ACCIAIO INOX - STAINLESS STEEL		
K	GHISA - CAST IRON	●	15-30
N	ALLUMINIO E SUE LEGHE - ALUMINIUM	○	25-30
S	LEGHE RESIST. CALORE - HIG. TEMP. ALLOY		
H	MAT. DURI E TEMPRATI - HARD AND HARDENED MATERIAL		



Vc = m/min VELOCITÀ DI TAGLIO - CUTTING SPEED

MSK180256TG G..

Con canaline di lubrificazione
 With lubrication channels



RIVESTIM.
 COATED
TIN

PM8

G 1/8 - 1"

NEW

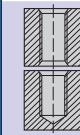
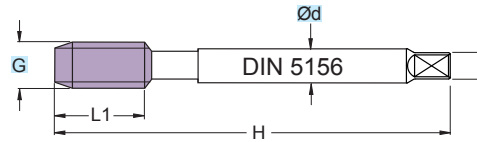
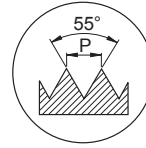

**2-3
 FILL**



**TOLL
 ISO
 228"X"**

DIN 5156		(mm)						Preforo Prebore
ART.	G(")	P/tpi	Ød	L1	H	B		
MSK180256TG G1/8-28	1/8	28	7	10	90	5,5	9,25	
MSK180256TG G1/4-19	1/4	19	11	13	100	9	12,5	
MSK180256TG G3/8-19	3/8	19	12	13	100	9	16	
MSK180256TG G1/2-14	1/2	14	16	18	125	12	20	
MSK180256TG G3/4-14	3/4	14	20	18	140	16	25,5	
MSK180256TG G1-11	1"	11	25	23	160	20	32	



- P/tpi = FILETTI PER POLLICE
- P/tpi = THREADS FOR INCH-SIZES
- P/tpi = GEWINDE FÜR ZOLLABMESSUNGEN
- P/tpi = FILETS POUR POUCES

PARAMETRI - PARAMETERS

MATERIALI - MATERIALS Pag. 1199			Vc m/min
P	ACCIAIO - STEEL	○	25-40
	ACCIAIO AD ALTA RESISTENZA - HIGH-RESISTANCE STEEL	●	10-15
M	ACCIAIO INOX - STAINLESS STEEL	●	6-15
K	GHISA - CAST IRON		
N	ALLUMINIO E SUE LEGHE - ALUMINIUM	○	35-45
S	LEGHE RESIST. CALORE - HIG. TEMP. ALLOY	●	15-20
H	MAT. DURI E TEMPRATI - HARD AND HARDENED MATERIAL		

Vc = m/min VELOCITÀ DI TAGLIO - CUTTING SPEED



FILETTATURA NPT CONICA 1:16 AMERICANA

AMERICAN TAPERED PIPE THREAD (NPT), TAPER 1:16
AMERIKANISCHES KONISCHES (NPT)-GEWINDE 1:16
FILETAGE (NPT) CONIQUE 1:16 AMERICAIN
ROSCA (NPT) CÓNICA 1:16 AMERICANA

MSA15LNBR..

NPT 1/8 - 1"

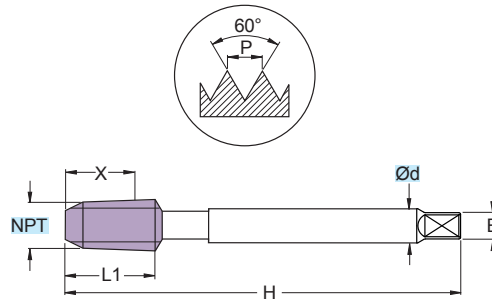

	HSSE
	2-3 FILL
	0° 1:16

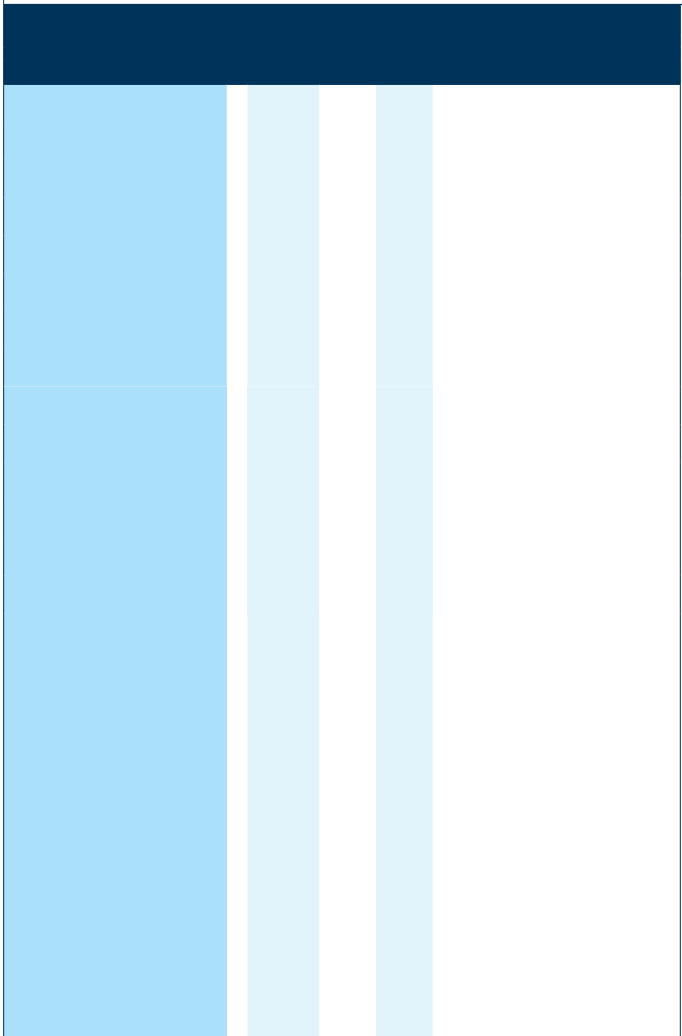

ART.	(mm)							
	NPT(°)	P/tpi	Ød	L1	H	B	X	Preforo Prebore
MSA15LNBR NPT1/8-27	1/8	27	7	13	90	5,5	9,3	*8,5
MSA15LNBR NPT1/4-18	1/4	18	11	20	100	9	13,5	*11
MSA15LNBR NPT3/8-18	3/8	18	12	20	110	9	13,9	*14,5
MSA15LNBR NPT1/2-14	1/2	14	16	26	125	12	18,1	*17,9
MSA15LNBR NPT3/4-14	3/4	14	20	26	140	16	18,6	*23,2
MSA15LNBR NPT1"-11,5	1"	11,5	25	32	160	20	22,3	*29

P/tpi = FILETTI PER POLLICE
 P/tpi = THREADS FOR INCH-SIZES
 P/tpi = GEWINDE FÜR ZOLLABMESSUNGEN
 P/tpi = FILETS POUR POUCES

SI CONSIGLIA DI PREPARARE IL FORO CON ALESATORE CONICO
 PREPARATION OF THE BORE WITH STRAIGHT REAMER RECOMMENDED
 VORBEREITUNG DER BOHRUNG MIT KEGEL-REIBHALE EMPFOHLEN
 IL EST CONSEILLÉ DE PRÉPARER LE TROU À L'AIDE D'UN ALÉSOIR CONIQUE

* DIAMETRI DI FORATURA CILINDRICI
 * CILYNDRIC HOLE
 * ZYLINDRISCHE BOHRUNGSDURCHMESSER
 * DIAMETRES DE PERCEGE CYLINDRIQUES

PARAMETRI - PARAMETERS

MATERIALI - MATERIALS Pag. 1199			Vc m/min
P	ACCIAIO - STEEL	●	3-7
	ACCIAIO AD ALTA RESISTENZA - HIGH-RESISTANCE STEEL		
M	ACCIAIO INOX - STAINLESS STEEL		
K	GHISA - CAST IRON		
N	ALLUMINIO E SUE LEGHE - ALUMINIUM		
S	LEGHE RESIST. CALORE - HIG. TEMP. ALLOY		
H	MAT. DURI E TEMPRATI - HARD AND HARDENED MATERIAL		

Vc = m/min VELOCITÀ DI TAGLIO - CUTTING SPEED

MSA16LNBR..



NPTF 1/8 - 1"

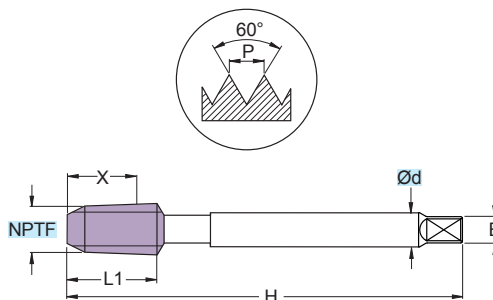

	HSSE
	2-3 FILL
	1:16

ART.	(mm)							Preforo Prebore
	NPTF(°)	P/tpi	Ød	L1	H	B	X	
MSA16LNBR NPTF1/8-27	1/8	27	7	13	90	5,5	9,3	*8,5
MSA16LNBR NPTF1/4-18	1/4	18	11	20	100	9	13,5	*11
MSA16LNBR NPTF3/8-18	3/8	18	12	20	110	9	13,9	*14,5
MSA16LNBR NPTF1/2-14	1/2	14	16	26	125	12	18,1	*17,9
MSA16LNBR NPTF3/4-14	3/4	14	20	26	140	16	18,6	*23,2
MSA16LNBR NPTF1"-11,5	1"	11,5	25	32	160	20	22,3	*29

P/tpi = FILETTI PER POLLICE
 P/tpi = THREADS FOR INCH-SIZES
 P/tpi = GEWINDE FÜR ZOLLABMESSUNGEN
 P/tpi = FILETS POUR POUCES

SI CONSIGLIA DI PREPARARE IL FORO CON ALESATORE CONICO
 PREPARATION OF THE BORE WITH STRAIGHT REAMER RECOMMENDED
 VORBEREITUNG DER BOHRUNG MIT KEGEL-REIBHALE EMPFOHLEN
 IL EST CONSEILLÉ DE PRÉPARER LE TROU À L'AIDE D'UN ALÉSOIR CONIQUE

* DIAMETRI DI FORATURA CILINDRICI
 * CILYNDRIC HOLE
 * ZYLINDRISCHE BOHRUNGSDURCHMESSER
 * DIAMETRES DE PERCAGE CYLINDRIQUES

PARAMETRI - PARAMETERS

MATERIALI - MATERIALS Pag. 1199			Vc m/min
P	ACCIAIO - STEEL	●	3-7
	ACCIAIO AD ALTA RESISTENZA - HIGH-RESISTANCE STEEL		
M	ACCIAIO INOX - STAINLESS STEEL		
K	GHISA - CAST IRON		
N	ALLUMINIO E SUE LEGHE - ALUMINIUM		
S	LEGHE RESIST. CALORE - HIG. TEMP. ALLOY		
H	MAT. DURI E TEMPRATI - HARD AND HARDENED MATERIAL		

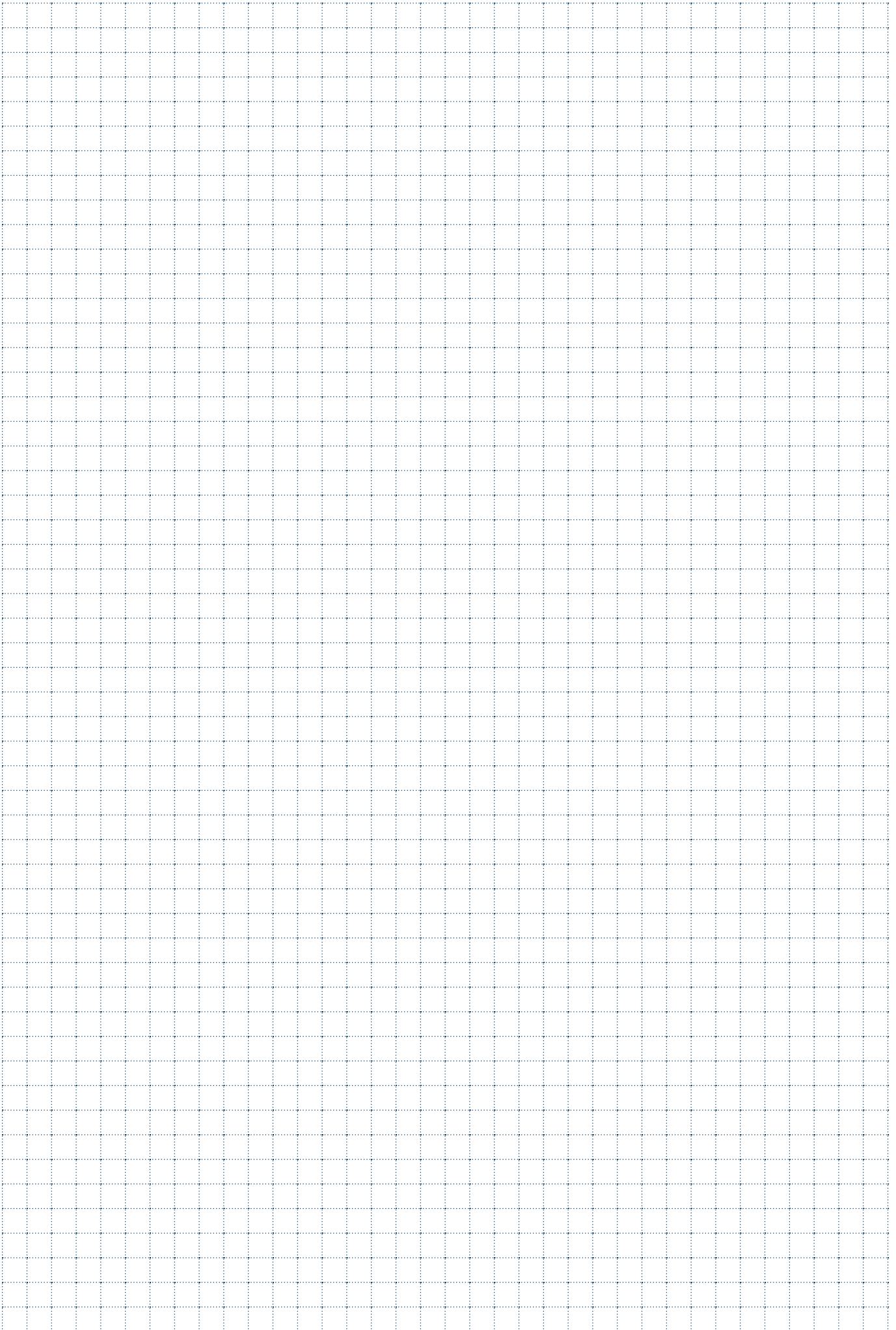



FILETTATURA EG M DIN 8140 - 2 PER FILETTI RIPORTATI

EG M DIN 8140-2 THREAD FOR WIRE THREAD INSERTS
EG M DIN 8140-2 GEWINDE FÜR GEWINDEEINSÄTZE
FILETAGE EG M DIN 8140-2 POUR FILETS REPORTÉS
ROSCA EG M DIN 8140-2 PARA INSERCIONES ROSCADAS

MSA40EGSTN M..

EGM 3 - 16

NEW

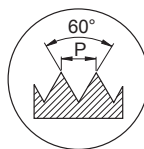

RIVESTIM.
 COATED
TT

HSSE

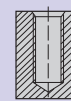

**2-3
 FILL**

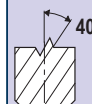

**TOLL
 6H mod**

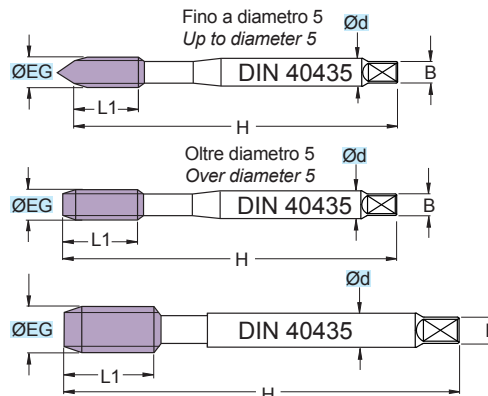

DIN 40435		(mm)							Preforo Prebore
ART.	EGM	P	ØEG	Ød	L1	H	B		
MSA40EGSTN M 3	3	0,5	3,65	4,5	7	63	3,4	3,15	
MSA40EGSTN M 4	4	0,7	4,91	6	8	70	4,9	4,20	
MSA40EGSTN M 5	5	0,8	6,04	6	10	80	4,9	5,25	
MSA40EGSTN M 6	6	1	7,3	8	13	90	6,2	6,30	
MSA40EGSTN M 8	8	1,25	9,624	10	15	100	8,0	8,40	

DIN 40435		(mm)							Preforo Prebore
ART.	EGM	P	ØEG	Ød	L1	H	B		
MSA40EGSTN M 10	10	1,5	11,948	9	13	100	7	10,5	
MSA40EGSTN M 12	12	1,75	14,274	11	20	110	9	12,5	
MSA40EGSTN M 14	14	2	16,598	12	20	110	9	14,5	
MSA40EGSTN M 16	16	2	18,598	14	25	125	11	16,5	

PARAMETRI - PARAMETERS

MATERIALI - MATERIALS Pag. 1199			Vc m/min
P	ACCIAIO - STEEL	●	10-30
	ACCIAIO AD ALTA RESISTENZA - HIGH-RESISTANCE STEEL		
M	ACCIAIO INOX - STAINLESS STEEL	●	10-15
K	GHISA - CAST IRON	●	10-20
N	ALLUMINIO E SUE LEGHE - ALUMINIUM	●	10-30
S	LEGHE RESIST. CALORE - HIG. TEMP. ALLOY		
H	MAT. DURI E TEMPRATI - HARD AND HARDENED MATERIAL		



DISTRUGGI MASCHI

TAP DESTROYING TOOL
WERKZEUGE ZUM ENTFERNEN VON ABGEBROCHENEN GEWINDEBOHRERN
DESTRUCTEUR DE MALES
EXTRACTOR DE TACOS

SKR

$\varnothing D = 3,3 - 17,5$

GENERICO / ALL PURPOSE

$V_c = 120 \div 150$ m/min

$f_n = 0,03 \div 0,05$ mm/giro - mm/rev.

RIVESTIM.
COATED
TIN

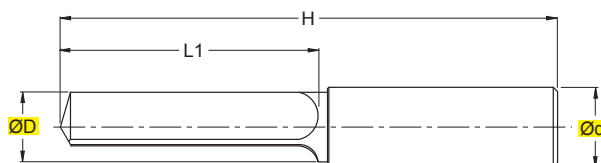
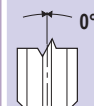

TOLLERANZE	D	d
TOLERANCE RANGE	h11	h6

(mm)						
ART.	$\varnothing D$	$\varnothing d$	H	L1	Z	Filetto Thread
SKR01M04	3,3	6	50	15	3	M4
SKR01M05	4,2	6	50	15	3	M5
SKR01M06	5,0	6	50	15	3	M6
SKR01M08	6,8	8	60	20	3	M8
SKR01M10	8,5	10	70	25	3	M10
SKR01M12	10,2	12	75	30	3	M12
SKR01M14	12,0	12	75	30	3	M14
SKR01M16	14,0	14	100	40	3	M16
SKR01M18	15,5	16	100	40	3	M18
SKR01M20	17,5	18	100	50	3	M20

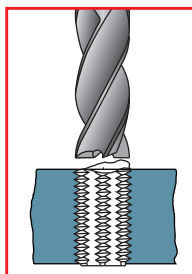
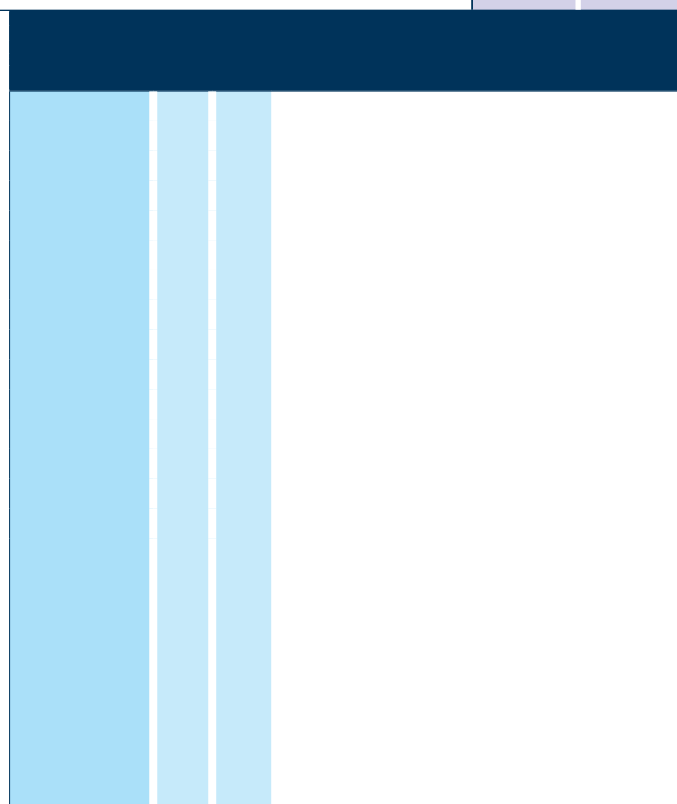

Fase 1. Con una fresa M.D.I. cercare di pareggiare il piano di rottura del maschio.

Step 1. With an HM mill try to level off the tap breakage plane.

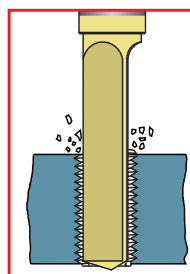

Fase 2. Cominciare la perforazione con il SKR. La refrigerazione può anche essere ad acqua.

Step 2. Begin the hole with the SKR. Water cooling can also be used.

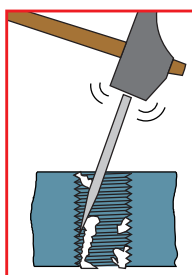

Fase 3. È importante eliminare le scaglie di acciaio rimanenti sulle pareti del filetto. Utilizzare un qualsiasi utensile appuntito.

Step 3. It is important to remove the steel flakes left on the sides of the thread. Use any pointed tool.

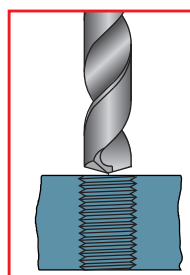

Fase 4. Si consiglia di ripassare il foro con una punta M.D.I. del diametro di pre-foro.

Step 4. The hole should be re-machined with a HM bit with a diameter corresponding to the pre-hole.

External Internal	Tipo Filetto Thread Type		ART.	ANGOLO ELICA ANGLE FLUTES	ØD	Z	MATERIALE MATERIAL	Materiali - Materials Pag. 1199						Pag.	
								P	M	K	N	S	H		G
MICROFRESE A FILETTARE - MICRO-THREADING MILLS															
Interna Internal	M	TIALN	FMMSR2...N	10°	0,9-15	3/5	MG	●	○	●	○	○	○	○	814
Interna Internal	M	TIALN	FMMSR3...N	10°	1,05-5,95	3	MG	●	○	●	○	○	○	○	815
Interna Internal	UNC UNF	TIALN	FMUSR2...N	10°	1,45-14,40	3/4	MG	●	○	●	○	○	○	○	816
Interna Internal	UNC UNF	TIALN	FMUSR3...N	10°	1,45-6	3	MG	●	○	●	○	○	○	○	817
FRESE A FILETTARE - THREADING MILLS															
Interna Internal	M MF	TIALN	FMSR ... N	10°	3,1-20	3/5	MG	●	○	●	○	○	○	○	820
Interna Internal	M MF	TIALN	FMSR ... F	10°	4-4,5	3	MG	●	○	●	○	○	○	○	821
Interna Internal	M MF	EMZ TIALN	FTMSR ... FT	10°	6-20	3/5	MG	●	○	●	○	○	○	○	821
Interna Esterna Internal External	GAS BSP	TIALN	FGSR ... N	10°	8-20	3/5	MG	●	○	●	○	○	○	○	822
Interna Esterna Internal External	GAS BSP	EMZ TIALN	FTGAR ... FT	10°	8-20	3/5	MG	●	○	●	○	○	○	○	823
Interna Internal	UNC UNF	TIALN	FUSR ... N	10°	4,5-20	3/5	MG	●	○	●	○	○	○	○	824
Interna Internal	UNC UNF	EMZ TIALN	FUAR ... F	10°	4,5	3	MG	●	○	●	○	○	○	○	825
Interna Internal	UNC UNF	EMZ TIALN	FTUAR ... FT	10°	5,5-20	3/5	MG	●	○	●	○	○	○	○	825
Interna Esterna Internal External	NPT	TIALN	FTSR ... N	10°	5,9-19,6	3/5	MG	●	○	●	○	○	○	○	826
Interna Esterna Internal External	NPT	TIALN	FTAN ... F	10°	5,9-19,6	3/5	MG			●				827	

SIMBOLOGIA - SYMBOL - SYMBOLE - SYMBOLES

RIVESTIMENTI - COATED - BESCHICHTUNG - RECOUVREMENT

<p>RIVESTIM. COATED</p> <p>TIALN</p>	<p>TiAIN: Elevata durezza e resistenza al calore, basso coefficiente di attrito, si può usare con refrigerante oppure a secco con aria.</p> <p>TiAIN: High degree of hardness and heat resistance, low friction coefficient; it can be used with coolant or with air and no coolant</p>		
---	---	--	--

ANGOLO ELICA - FLUTES DEGREES - SPIRALWINKEL - ANGLE HELICE

	<p>■ 10°</p>				
---	--------------	--	--	--	--

LUNGHEZZA FRESA - MILLS LENGHT - FRAESERLÄNGE - LONGUEUR FRAISES

<p>2xD</p>	<ul style="list-style-type: none"> - 2 volte il diametro - Two times the diameter - Zweimal den Durchmesser - 2 fois le diamètre 	<p>3xD</p>	<ul style="list-style-type: none"> - 3 volte il diametro - Three times the diameter - Dreimal den Durchmesser - 3 fois le diamètre 				
-------------------	--	-------------------	--	--	--	--	--

SIMBOLI GENERALI - GENERAL SYMBOLS - ALLGEMEINE SYMBOLE - SYMBOLES GÉNÉRAUX

<p>MG</p>	<ul style="list-style-type: none"> - Micrograno 0,7 µm (K 20) - Micrograin 0,7 µm (K 20) - Feinstkorn 0,7 µm (K 20) - Microgrenu 0,7 µm (K 20) 		
------------------	--	--	--



MICROFRESE A FILETTARE

MICRO-THREADING MILLS / MIKROGEWINDEFÄSER / MICRO-FRAISES A FILETER /
MICROFRESAS PARA ROSCAR

FMMSR2 ... N

GENERIC / ALL PURPOSE

TOLLERANZE
 TOLLERANCE RANGE

D	d
e8	h6

RIVESTIM.
 COATED

2xD



MG

$\varnothing D = 0,90 - 15,00$

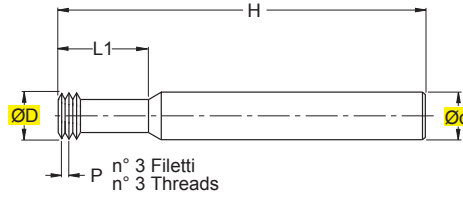

> PER FILETTATURE ISO 60°
 > ATTACCO DIN 6535 HA
 > RIVESTIMENTO TIALN

> FOR ISO 60° THREAD
 > SHANK DIN 6535 HA
 > TIALN COATED

ART.	(mm)		H ^{±1}	L1	Z	P/mm	Preforo d. Prebore	Filetto eseguibile Thread type
	ØD	Ød						
FMMSR2 0090.025 N	0,90	3	39	3,0	3	0,25	0,95	M1,2
FMMSR2 0155.040 N	1,55	3	39	4,5	3	0,40	1,60	M2
FMMSR2 0165.045 N	1,65	6	54	5,0	3	0,45	1,75	M2,2
FMMSR2 0195.045 N	1,95	6	54	5,5	3	0,45	2,05	M2,5
FMMSR2 0235.050 N	2,35	6	54	6,5	3	0,50	2,50	M3
FMMSR2 0275.060 N	2,75	6	54	7,5	3	0,60	2,90	M3,5
FMMSR2 0310.070 N	3,10	6	54	9,0	3	0,70	3,30	M4
FMMSR2 0340.075 N	3,40	6	54	10,5	3	0,75	3,70	M4,5
FMMSR2 0380.080 N	3,80	6	54	12,5	3	0,80	4,20	M5
FMMSR2 0465.100 N	4,65	6	54	14,0	3	1,00	5,00	M6
FMMSR2 0595.125 N	5,95	6	54	18,0	3	1,25	6,80	M8
FMMSR2 0780.150 N	7,80	8	64	23,0	3	1,50	8,50	M10
FMMSR2 0900.175 N	9,00	10	73	26,0	3	1,75	10,20	M12
FMMSR2 1180.200 N	11,80	12	80	35,0	4	2,00	14,00	M16
FMMSR2 1500.250 N	15,00	16	100	43,0	5	2,50	17,50	M20

PARAMETRI DI TAGLIO A PAG. 1174
 CUTTING DATA ON PAGE 1174
 SCHNITTPARAMETER AUF SEITE 1174
 PARAMETRES DE COUPE PAGE 1174

FMMSR3 ... N

GENERICO / ALL PURPOSE

TOLLERANZE
 TOLERANCE RANGE

D	d
e8	h6

RIVESTIM.
 COATED
TIALN

3xD



MG

ØD = 1,05 - 5,95

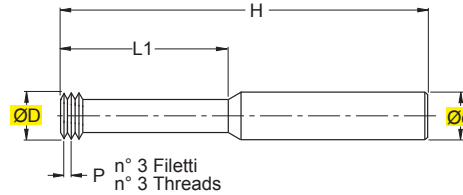

> PER FILETTATURE ISO 60°
 > ATTACCO DIN 6535 HA
 > RIVESTIMENTO TIALN

> FOR ISO 60° THREAD
 > SHANK DIN 6535 HA
 > TIALN COATED

ART.	(mm)		H ^{±1}	L1	Z	P/mm	Preforo d. Prebore	Filetto eseguibile Thread type
	ØD	Ød						
FMMSR3 0105.030 N	1,05	3	39	4,0	3	0,30	1,10	M1,4
FMMSR3 0120.035 N	1,20	3	39	5,0	3	0,35	1,25	M1,6
FMMSR3 0155.040 N	1,55	3	39	6,0	3	0,40	1,60	M2
FMMSR3 0195.045 N	1,95	6	54	7,5	3	0,45	2,05	M2,5
FMMSR3 0235.050 N	2,35	6	54	9,5	3	0,50	2,50	M3
FMMSR3 0310.070 N	3,10	6	54	12,5	3	0,70	3,30	M4
FMMSR3 0340.075 N	3,40	6	54	14,0	3	0,75	3,70	M4,5
FMMSR3 0380.080 N	3,80	6	54	16,0	3	0,80	4,20	M5
FMMSR3 0465.100 N	4,65	6	54	20,0	3	1,00	5,00	M6
FMMSR3 0595.125 N	5,95	6	54	24,0	3	1,25	6,80	M8

PARAMETRI DI TAGLIO A PAG. 1174
 CUTTING DATA ON PAGE 1174
 SCHNITTPARAMETER AUF SEITE 1174
 PARAMETRES DE COUPE PAGE 1174

FMUSR2 ... N

GENERICO / ALL PURPOSE

TOLLERANZE
 TOLLERANCE RANGE

D	d
e8	h6

RIVESTIM.
 COATED

2xD



MG

ØD = 1,45 - 14,40

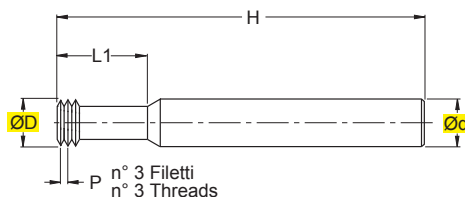

> PER FILETTATURE UN 60° (UNC-UNF)
 > ATTACCO DIN 6535 HA
 > RIVESTIMENTO TIALN

> UN 60° (UNC-UNF) THREAD
 > SHANK DIN 6535 HA
 > TIALN COATED

ART.	(mm)		H±1	L1	Z	P/tpi	Preforo d. Prebore	Filetto eseguibile Thread type
FMUSR2 0145.072 N	1,45	6	54	3,7	3	72	1,60	N°.1 UNF
FMUSR2 0140.064 N	1,40	6	54	3,8	3	64	1,50-1,90	N°.1 UNC-N°.2 UNF
FMUSR2 0165.056 N	1,65	6	54	4,4	3	56	1,80-2,10	N°.2 UNC-N°.3 UNF
FMUSR2 0190.048 N	1,90	6	54	5,2	3	48	2,10-2,40	N°.3 UNC-N°.4 UNF
FMUSR2 0210.040 N	2,10	6	54	6,3	3	40	2,30	N°.4 UNC
FMUSR2 0245.040 N	2,45	6	54	7,0	3	40	2,60-3,00	N°.5 UNC-N°.6 UNF
FMUSR2 0330.036 N	3,30	6	54	9,0	3	36	3,50	N°.8 UNF
FMUSR2 0255.032 N	2,55	6	54	7,1	3	32	2,85	N°.6 UNC
FMUSR2 0320.032 N	3,20	6	54	9,5	3	32	3,50	N°.8 UNC
FMUSR2 0370.032 N	3,70	6	54	10,5	3	32	4,10	N°.10 UNF
FMUSR2 0420.028 N	4,20	6	54	11,0	3	28	4,70	N°.12 UNF
FMUSR2 0500.028 N	5,00	6	54	14,5	3	28	5,50	1/4" UNF
FMUSR2 0350.024 N	3,50	6	54	10,6	3	24	3,90-4,50	N°.10 UNC-N°.12 UNC
FMUSR2 0660.024 N	6,60	8	64	17,0	3	24	6,90-8,50	5/16" UNF-3/8" UNF
FMUSR2 0475.020 N	4,75	6	54	14,0	3	20	5,20	1/4" UNC
FMUSR2 0800.020 N	8,00	8	64	25,0	3	20	9,90	7/16" UNF
FMUSR2 0600.018 N	6,00	6	54	17,0	3	18	6,60	5/16" UNC
FMUSR2 1200.018 N	12,00	12	80	35,0	4	18	14,50	5/8" UNF
FMUSR2 0670.016 N	6,70	8	64	22,0	3	16	8,00	3/8" UNC
FMUSR2 0770.014 N	7,70	8	64	25,0	3	14	9,40	7/16" UNC
FMUSR2 0920.013 N	9,20	10	73	27,5	4	13	10,75	1/2" UNC
FMUSR2 1050.012 N	10,50	12	80	31,5	4	12	12,25	9/16" UNC
FMUSR2 1140.011 N	11,40	12	80	34,5	4	11	13,50	5/8" UNC
FMUSR2 1440.010 N	14,40	16	100	41,5	4	10	16,50	3/4" UNC

↑

- 🇮🇹 P/tpi = FILETTI PER POLLICE
- 🇬🇧 P/tpi = THREADS FOR INCH-SIZES
- 🇩🇪 P/tpi = GEWINDE FÜR ZOLLABMESSUNGEN
- 🇫🇷 P/tpi = FILETS POUR POUÇES

- 🇮🇹 PARAMETRI DI TAGLIO A PAG. 1174
- 🇬🇧 CUTTING DATA ON PAGE 1174
- 🇩🇪 SCHNITTPARAMETER AUF SEITE 1174
- 🇫🇷 PARAMETRES DE COUPE PAGE 1174

FMUSR3 ... N

GENERIC / ALL PURPOSE

TOLLERANZE TOLLERANCE RANGE	D	d
	e8	h6

RIVESTIM.
COATED
TIALN **3xD**

 **MG**

ØD = 1,45 - 6,00

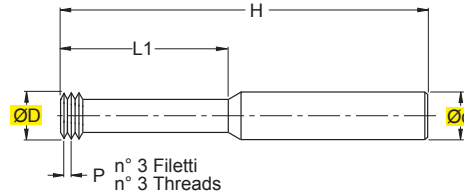







> PER FILETTATURE UN 60° (UNC-UNF)
 > ATTACCO DIN 6535 HA
 > RIVESTIMENTO TIALN

> UN 60° (UNC-UNF) THREAD
 > SHANK DIN 6535 HA
 > TIALN COATED

ART.	(mm)		H ^{±1}	L1	Z	P/tpi	Preforo d. Prebore	Filetto eseguibile Thread type
FMUSR3 0145.072 N	1,45	3	39	6,0	3	72	1,60	N°.1 UNF
FMUSR3 0165.056 N	1,65	6	54	6,6	3	56	1,80-2,10	N°.2 UNC-N°.3 UNF
FMUSR3 0210.040 N	2,10	6	54	8,0	3	40	2,30	N°.4 UNC
FMUSR3 0245.040 N	2,45	6	54	9,6	3	40	2,60-3,00	N°.5 UNC-N°.6 UNF
FMUSR3 0255.032 N	2,55	6	54	10,5	3	32	2,85	N°.6 UNC
FMUSR3 0320.032 N	3,20	6	54	12,5	3	32	3,50	N°.8 UNC
FMUSR3 0370.032 N	3,70	6	54	15,0	3	32	4,10	N°.10 UNF
FMUSR3 0500.028 N	5,00	6	54	19,0	3	28	5,50	1/4" UNF
FMUSR3 0660.024 N	6,60	8	64	24,0	3	24	6,90-8,50	5/16" UNF-3/8" UNF
FMUSR3 0475.020 N	4,75	6	54	19,0	3	20	5,20	1/4" UNC
FMUSR3 0600.018 N	6,00	6	54	23,0	3	18	6,60	5/16" UNC



 P/tpi = FILETTI PER POLLICE
 P/tpi = THREADS FOR INCH-SIZES
 P/tpi = GEWINDE FÜR ZOLLABMESSUNGEN
 P/tpi = FILETS POUR POUCES

 PARAMETRI DI TAGLIO A PAG. 1174
 CUTTING DATA ON PAGE 1174
 SCHNITTPARAMETER AUF SEITE 1174
 PARAMETRES DE COUPE PAGE 1174

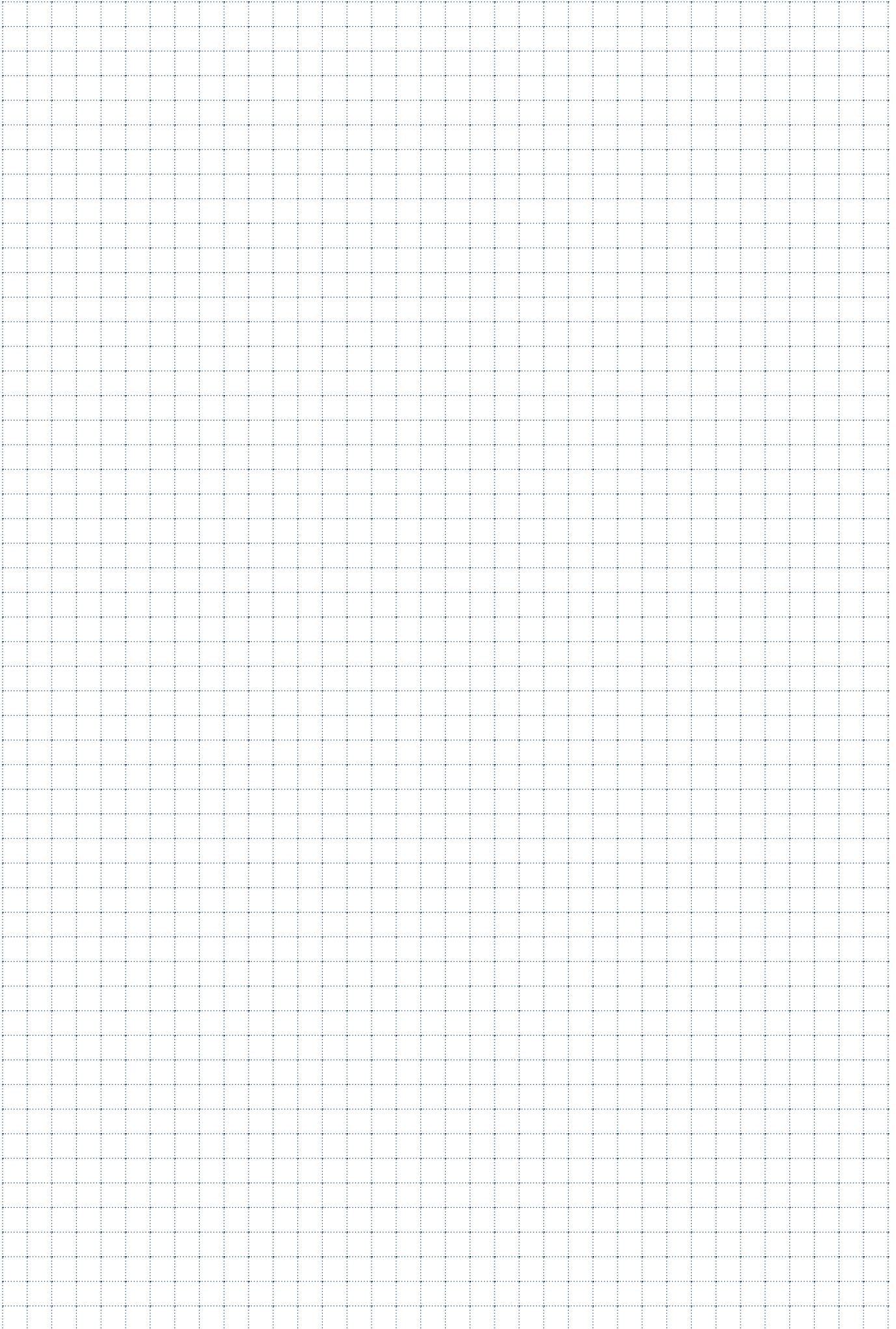



FRESE A FILETTARE

THREADING MILLS / GEWINDEFÄSER / FRAISES A FILETER /
FRESAS PARA ROSCAR

FMSR ... N

GENERIC / ALL PURPOSE

TOLLERANZE
 TOLERANCE RANGE

D	d
e8	h6

RIVESTIM.
 COATED
TIALN



MG

$\varnothing D = 3,10 - 20$

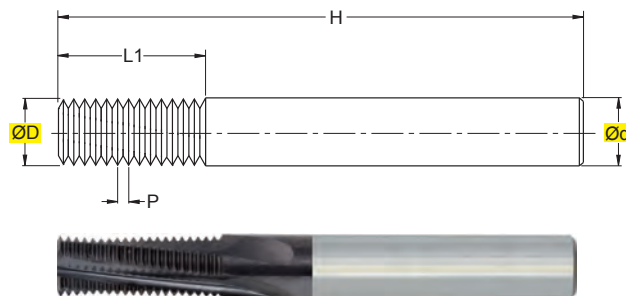

> PER FILETTATURE ISO 60°
 > ATTACCO DIN 6535 HA
 > RIVESTIMENTO TIALN

> FOR ISO 60° THREAD
 > SHANK DIN 6535 HA
 > TIALN COATED

ART.	(mm)		H ^{±1}	L1	Z	Filetti utili Thread useful	P/mm	Preforo d. Prebore	Filetto eseguibile Thread type
FMSR 031.070 N	3,1	6	55	8	3	11	0,70	3,3	M4
FMSR 040.080 N	4,0	6	55	12	3	15	0,80	4,2	M5
FMSR 045.075 N	4,5	6	55	12	3	16	0,75	8,3	MF9
FMSR 045.100 N	4,5	6	55	12	3	12	1,00	5-6	M6-M7
FMSR 060.075 N	6,0	6	55	15	3	20	0,75	7,2	MF8
FMSR 060.100 N	6,0	6	55	15	3	15	1,00	7	MF8
FMSR 060.125 N	6,0	6	55	15	3	12	1,25	6,8-7,8-8,8	M8-M9-MF10
FMSR 080.075 N	8,0	8	66	20	3	26	0,75	9,2-11,2	MF10-MF12
FMSR 080.100 N	8,0	8	66	20	3	20	1,00	9-11	MF10-MF12
FMSR 080.125 N	8,0	8	66	20	3	16	1,25	9	MF10
FMSR 080.150 N	8,0	8	66	20	3	13	1,50	8,5-9,5-10,5	M10-M11-MF12
FMSR 080.175 N	8,0	8	66	20	4	11	1,75	10,2	M12
FMSR 100.100 N	10,0	10	80	25	4	25	1,00	11	MF12
FMSR 100.125 N	10,0	10	80	25	4	20	1,25	12,8	MF14
FMSR 100.150 N	10,0	10	80	25	4	16	1,50	12,5	MF14
FMSR 100.200 N	10,0	10	80	25	4	12	2,00	12	M14
FMSR 120.100 N	12,0	12	82	30	4	30	1,00	13	MF14
FMSR 120.150 N	12,0	12	82	30	4	20	1,50	14,5	MF16
FMSR 120.200 N	12,0	12	82	30	4	15	2,00	14	M16
FMSR 140.100 N	14,0	14	100	35	4	35	1,00	15	MF16
FMSR 140.150 N	14,0	14	100	35	4	23	1,50	16,5	MF18
FMSR 140.200 N	14,0	14	100	35	4	17	2,00	16	MF18
FMSR 140.250 N	14,0	14	100	35	4	14	2,50	15,5	M18
FMSR 160.100 N	16,0	16	100	40	5	40	1,00	17-19	MF18-MF20
FMSR 160.150 N	16,0	16	100	40	5	26	1,50	18,5-20,5	MF20-MF22
FMSR 160.200 N	16,0	16	100	40	5	20	2,00	18-20	MF20-MF22
FMSR 160.250 N	16,0	16	100	40	5	16	2,50	17,5-19,5	M20-M22
FMSR 200.100 N	20,0	20	110	40	5	40	1,00	21>	MF22>
FMSR 200.150 N	20,0	20	110	40	5	26	1,50	22,5>	MF24>
FMSR 200.200 N	20,0	20	110	40	5	20	2,00	22>	MF24>
FMSR 200.300 N	20,0	20	110	40	5	13	3,00	21>	MF24>

- Per filettature interne usare un diametro fresa non superiore ai 2/3 del diametro del filetto, per i filetti a passo fine 3/4. Per filettature esterne il diametro fresa non deve essere superiore al diametro del filetto.

- For inner threading use a milling cutter diameter no greater than 2/3 of the diameter of the thread, for fine thread pitches use 3/4. For outer threading the milling cutter diameter must not be greater than the diameter of the thread.

PARAMETRI DI TAGLIO A PAG. 1175
 CUTTING DATA ON PAGE 1175
 SCHNITTPARAMETER AUF SEITE 1175
 PARAMETRES DE COUPE PAGE 1175

FMSR ... F
FTMSR ... FT

GENERICO / ALL PURPOSE

TOLLERANZE
 TOLERANCE RANGE

D	d
e8	h6

RIVESTIM.
 COATED
TIALN



ØD = 4 - 4,5

ØD = 6 - 20

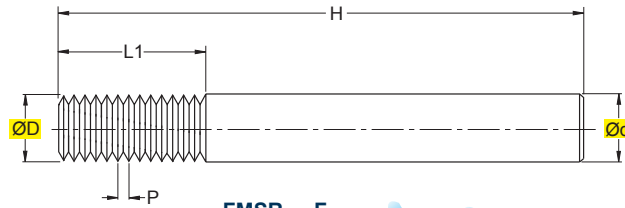

> PER FILETTATURE ISO 60°
 > ATTACCO DIN 6535 HA
 > RIVESTIMENTO TIALN

> FOR ISO 60° THREAD
 > SHANK DIN 6535 HA
 > TIALN COATED

MG

ART.	(mm)		H ^{±1}	L1	Z	Filetti utili Thread useful	P/mm	Preforo d. Prebore	Filetto eseguibile Thread type
FMSR 040.080 F	4,0	6	55	12	3	15	0,80	4,2	M5
FMSR 045.075 F	4,5	6	55	12	3	16	0,75	8,3	MF9
FMSR 045.100 F	4,5	6	55	12	3	12	1,00	5-6	M6-M7
FTMSR 060.075 FT New	6,0	6	55	15	3	20	0,75	7,2	MF8
FTMSR 060.100 FT New	6,0	6	55	15	3	15	1,00	7	MF8
FTMSR 060.125 FT New	6,0	6	55	15	3	12	1,25	6,8-7,8-8,8	M8-M9-MF10
FTMSR 080.075 FT New	8,0	8	66	20	3	26	0,75	9,2-11,2	MF10-MF12
FTMSR 080.100 FT New	8,0	8	66	20	3	20	1,00	9-11	MF10-MF12
FTMSR 080.125 FT New	8,0	8	66	20	3	16	1,25	9	MF10-MF12
FTMSR 080.150 FT New	8,0	8	66	20	3	13	1,50	8,5-9,5-10,5	M10-M11-MF12
FTMSR 080.175 FT New	8,0	8	66	20	3	11	1,75	10,2	M12
FTMSR 100.100 FT New	10,0	10	80	25	4	25	1,00	11	MF12
FTMSR 100.125 FT New	10,0	10	80	25	4	20	1,25	12,8	MF14
FTMSR 100.150 FT New	10,0	10	80	25	4	16	1,50	12,5	MF14
FTMSR 100.200 FT New	10,0	10	80	25	4	12	2,00	12	M14
FTMSR 120.100 FT New	12,0	12	82	30	4	30	1,00	13	MF14
FTMSR 120.150 FT New	12,0	12	82	30	4	20	1,50	14,5	MF16
FTMSR 120.200 FT New	12,0	12	82	30	4	15	2,00	14	M16
FTMSR 140.100 FT New	14,0	14	100	35	4	35	1,00	15	MF16
FTMSR 140.150 FT New	14,0	14	100	35	4	23	1,50	16,5	MF18
FTMSR 140.200 FT New	14,0	14	100	35	4	17	2,00	16	MF18
FTMSR 140.250 FT New	14,0	14	100	35	4	14	2,50	15,5	M18
FTMSR 160.100 FT New	16,0	16	100	40	5	40	1,00	17-19	MF18-MF20
FTMSR 160.150 FT New	16,0	16	100	40	5	26	1,50	18,5-20,5	MF20-MF22
FTMSR 160.200 FT New	16,0	16	100	40	5	20	2,00	18-20	MF20-MF22
FTMSR 160.250 FT New	16,0	16	100	40	5	16	2,50	17,5-19,5	M20-M22
FTMSR 200.100 FT New	20,0	20	110	40	5	40	1,00	21>	MF22>
FTMSR 200.150 FT New	20,0	20	110	40	5	26	1,50	22,5>	MF24>
FTMSR 200.200 FT New	20,0	20	110	40	5	20	2,00	22>	MF24>
FTMSR 200.300 FT New	20,0	20	110	40	5	13	3,00	21>	MF24>

PARAMETRI DI TAGLIO A PAG. 1175
 CUTTING DATA ON PAGE 1175
 SCHNITTPARAMETER AUF SEITE 1175
 PARAMETRES DE COUPE PAGE 1175

FGSR ... N

GENERICO / ALL PURPOSE

TOLLERANZE
 TOLERANCE RANGE

D	d
e8	h6

RIVESTIM.
 COATED
TIALN



MG

$\varnothing D = 8 - 20$

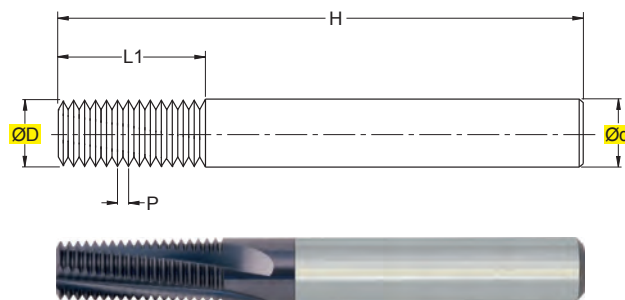

> PER FILETTATURE WHITWORTH 55° GAS
 > ATTACCO DIN 6535 HA
 > RIVESTIMENTO TIALN

> FOR WHITWORTH 55° GAS THREAD
 > SHANK DIN 6535 HA
 > TIALN COATED

ART.	(mm)		H ^{±1}	L1	Z	Filetti utili Thread useful	P/tpi	Preforo d. Prebore	Filetto eseguibile Thread type
FGSR 080.028 N	8	8	66	20	3	22	28	8,7	1/8"
FGSR 100.019 N	10	10	80	25	4	18	19	11,8	1/4"
FGSR 140.019 N	14	14	100	35	4	26	19	15,25	3/8"
FGSR 160.014 N	16	16	100	40	5	22	14	19	1/2"
FGSR 200.014 N	20	20	110	40	5	22	14	21-24,5-28,25	5/8"-3/4"-7/8"
FGSR 200.011 N	20	20	110	40	5	17	11	30,75	1">



P/tpi = FILETTI PER POLLICE
 P/tpi = THREADS FOR INCH-SIZES
 P/tpi = GEWINDE FÜR ZOLLABMESSUNGEN
 P/tpi = FILETS POUR POUCES

PARAMETRI DI TAGLIO A PAG. 1175
 CUTTING DATA ON PAGE 1175
 SCHNITTPARAMETER AUF SEITE 1175
 PARAMETRES DE COUPE PAGE 1175

- Per filettature interne usare un diametro fresa non superiore ai 2/3 del diametro del filetto, per i filetti a passo fine 3/4. Per filettature esterne il diametro fresa non deve essere superiore al diametro del filetto.

- For inner threading use a milling cutter diameter no greater than 2/3 of the diameter of the thread, for fine thread pitches use 3/4. For outer threading the milling cutter diameter must not be greater than the diameter of the thread.

FTGAR ... FT

GENERICO / ALL PURPOSE

TOLLERANZE
 TOLLERANCE RANGE

D	d
e8	h6

RIVESTIM.
 COATED
TIALN



MG

ØD = 8 - 20

NEW

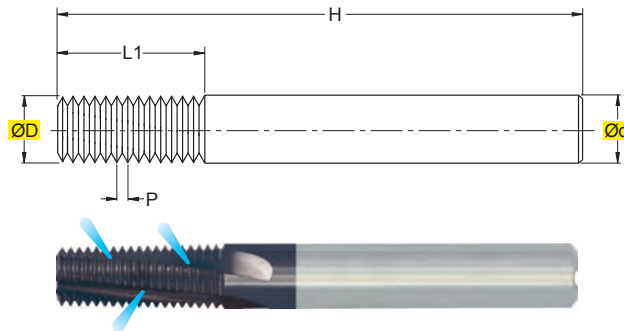

> PER FILETTATURE WHITWORTH 55° GAS
 > ATTACCO DIN 6535 HA
 > RIVESTIMENTO TIALN

> FOR WHITWORTH 55° GAS THREAD
 > SHANK DIN 6535 HA
 > TIALN COATED

ART.	(mm)		H ^{*1}	L1	Z	Filetti utili Thread usefull	P/tpi	Preforo d. Prebore	Filetto eseguibile Thread type
FTGAR 080.028 FT	8	8	66	20	3	22	28	8,7	1/8"
FTGAR 100.019 FT	10	10	80	25	4	18	19	11,8	1/4"
FTGAR 140.019 FT	14	14	100	35	4	26	19	15,25	3/8"
FTGAR 160.014 FT	16	16	100	40	5	22	14	19	1/2"
FTGAR 200.014 FT	20	20	110	40	5	22	14	21-24,5-28,25	5/8"-3/4"-7/8"
FTGAR 200.011 FT	20	20	110	40	5	17	11	30,75	1">



P/tpi = FILETTI PER POLLICE
 P/tpi = THREADS FOR INCH-SIZES
 P/tpi = GEWINDE FÜR ZOLLABMESSUNGEN
 P/tpi = FILETS POUR POUÇES

PARAMETRI DI TAGLIO A PAG. 1175
 CUTTING DATA ON PAGE 1175
 SCHNITTPARAMETER AUF SEITE 1175
 PARAMETRES DE COUPE PAGE 1175

FUSR ... N

GENERICO / ALL PURPOSE

TOLLERANZE
 TOLERANCE RANGE

D	d
e8	h6

RIVESTIM.
 COATED
TIALN



MG

$\varnothing D = 4,5 - 20$

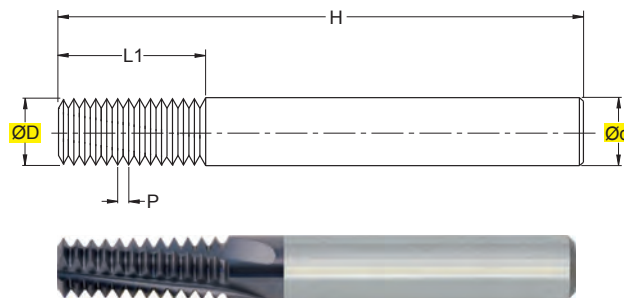

> PER FILETTATURE UN 60° (UNC-UNF)
 > ATTACCO DIN 6535 HA
 > RIVESTIMENTO TIALN

> UN 60° (UNC-UNF) THREAD
 > SHANK DIN 6535 HA
 > TIALN COATED

ART.	ØD	Ød	H ^{±1}	L1	Z	Filetti utili Thread useful	P/tpi	Preforo d. Prebore	Filetto eseguibile Thread type
FUSR 045.020 N	4,5	6	55	12	3	9	20	5,2	UNC 1/4"
FUSR 045.028 N	4,5	6	55	12	3	13	28	5,5	UNF 1/4"
FUSR 055.018 N	5,5	6	55	15	3	10	18	6,6	UNC 5/16"
FUSR 055.024 N	5,5	6	55	15	3	14	24	6,9	UNF 5/16"
FUSR 075.016 N	7,5	8	66	20	3	12	16	8,5	UNC 3/8"
FUSR 080.014 N	8,0	8	66	20	3	11	14	9,4	UNC 7/16"
FUSR 080.020 N	8,0	8	66	20	3	15	20	9,9	UNF 7/16"
FUSR 080.024 N	8,0	8	66	20	3	18	24	8,5	UNF 3/8"
FUSR 100.012 N	10,0	10	80	25	4	11	12	12,2	UNC 9/16"
FUSR 100.013 N	10,0	10	80	25	4	12	13	10,8	UNC 1/2"
FUSR 100.018 N	10,0	10	80	25	4	21	18	12,9-14,5	UNF 9/16"-5/8"
FUSR 100.020 N	10,0	10	80	25	4	19	20	11,5	UNF 1/2"
FUSR 120.018 N	12,0	12	82	30	4	21	18	12,9-14,5	UNF 9/16"-5/8"
FUSR 120.011 N	12,0	12	82	30	4	13	11	13,6	UNC 5/8"
FUSR 155.016 N	15,5	16	100	40	5	25	16	17,5	UNF 3/4"
FUSR 155.010 N	15,5	16	100	40	5	15	10	16,5	UNC 3/4"
FUSR 155.014 N	15,5	16	100	40	5	22	14	20,5	UNF 7/8"
FUSR 180.009 N	18,0	18	110	40	5	15	9	19,5	UNF 7/8"
FUSR 180.014 N	18,0	18	110	40	5	22	14	19,5	UNC 7/8"
FUSR 200.008 N	20,0	20	110	40	5	12	8	23,25	UNF 1"
FUSR 200.012 N	20,0	20	110	40	5	18	12	22,25	UNC 1"



P/tpi = FILETTI PER POLLICE
 P/tpi = THREADS FOR INCH-SIZES
 P/tpi = GEWINDE FÜR ZOLLABMESSUNGEN
 P/tpi = FILETS POUR POUÇES

PARAMETRI DI TAGLIO A PAG. 1175
 CUTTING DATA ON PAGE 1175
 SCHNITTPARAMETER AUF SEITE 1175
 PARAMETRES DE COUPE PAGE 1175

FUAR ... F
FTUAR ... FT

GENERICO / ALL PURPOSE

TOLLERANZE
 TOLERANCE RANGE

D	d
e8	h6

RIVESTIM.
 COATED
TIALN



ØD = 4,5

NEW

ØD = 5,5 - 20

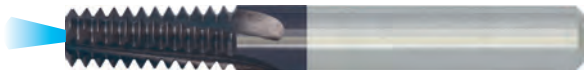
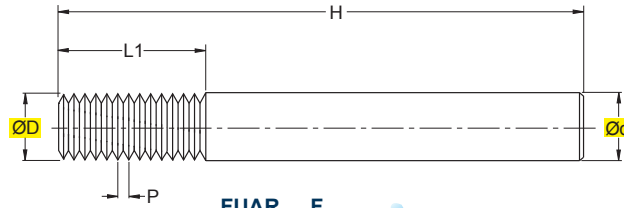

FUAR ... F

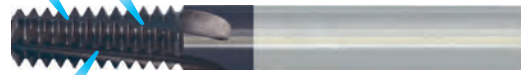

FTUAR ... FT

- > PER FILETTATURE UN 60° (UNC-UNF)
- > ATTACCO DIN 6535 HA
- > RIVESTIMENTO TIALN

- > UN 60° (UNC-UNF) THREAD
- > SHANK DIN 6535 HA
- > TIALN COATED

MG

ART.	(mm)		H ⁺¹	L1	Z	Filetti utili Thread usefuf	P/tpi	Preforo d. Prebore	Filetto eseguibile Thread type
FUAR 045.020 F	4,5	6	55	12	3	9	20	5,2	UNC 1/4"
FUAR 045.028 F	4,5	6	55	12	3	13	28	5,5	UNF 1/4"
FTUAR 055.018 FT	5,5	6	55	15	3	10	18	6,6	UNC 5/16"
FTUAR 055.024 FT	5,5	6	55	15	3	14	24	6,9	UNF 5/16"
FTUAR 075.016 FT	7,5	8	66	20	3	12	16	8,5	UNC 3/8"
FTUAR 080.014 FT	8,0	8	66	20	3	11	14	9,4	UNC 7/16"
FTUAR 080.020 FT	8,0	8	66	20	3	15	20	9,9	UNF 7/16"
FTUAR 080.024 FT	8,0	8	66	20	3	18	24	8,5	UNF 3/8"
FTUAR 100.012 FT	10,0	10	80	25	4	11	12	12,2	UNC 9/16"
FTUAR 100.013 FT	10,0	10	80	25	4	12	13	10,8	UNC 1/2"
FTUAR 100.018 FT	10,0	10	80	25	4	21	18	12,9-14,5	UNF 9/16"-5/8"
FTUAR 100.020 FT	10,0	10	80	25	4	19	20	11,5	UNF 1/2"
FTUAR 120.018 FT	12,0	12	82	30	4	21	18	12,9-14,5	UNF 9/16"-5/8"
FTUAR 120.011 FT	12,0	12	82	30	4	13	11	13,6	UNC 5/8"
FTUAR 155.016 FT	15,5	16	100	40	5	25	16	17,5	UNF 3/4"
FTUAR 155.010 FT	15,5	16	100	40	5	15	10	16,5	UNC 3/4"
FTUAR 155.014 FT	15,5	16	100	40	5	22	14	20,5	UNF 7/8"
FTUAR 180.009 FT	18,0	18	110	40	5	15	9	19,5	UNC 7/8"
FTUAR 180.014 FT	18,0	18	110	40	5	22	14	19,5	UNF 7/8"
FTUAR 200.008 FT	20,0	20	110	40	5	12	8	23,25	UNC 1"
FTUAR 200.012 FT	20,0	20	110	40	5	18	12	22,25	UNF 1"



P/tpi = FILETTI PER POLLICE
 P/tpi = THREADS FOR INCH-SIZES
 P/tpi = GEWINDE FÜR ZOLLABMESSUNGEN
 P/tpi = FILETS POUR POUÇES

PARAMETRI DI TAGLIO A PAG. 1175
 CUTTING DATA ON PAGE 1175
 SCHNITTPARAMETER AUF SEITE 1175
 PARAMETRES DE COUPE PAGE 1175

FTSR ... N

GENERICO / ALL PURPOSE

TOLLERANZE
 TOLLERANCE RANGE

D	d
	h6

RIVESTIM.
 COATED
TIALN



MG

$\varnothing D = 5,9 - 19,6$

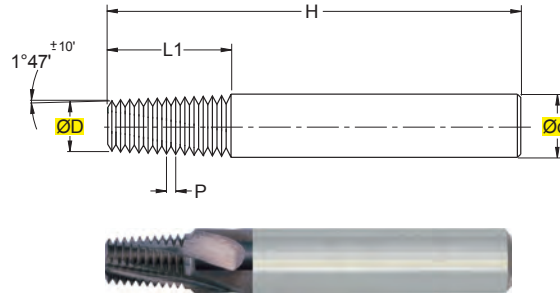

> PER FILETTATURE NPTCONICHE 60°
 > ATTACCO DIN 6535 HA
 > RIVESTIMENTO TIALN

> FOR 60° TAPERED NPT-NPTF THREAD
 > SHANK DIN 6535 HA
 > TIALN COATED

ART.	(mm)		H ^{±1}	L1	Z	Filetti utili Thread useful	P	Preforo d. Prebore	Filetto eseguibile Thread type
FTSR 059.27° N	5,90	8	55	9,88	3	10	27	6,3	1/16"
FTSR 076.27° N	7,65	8	55	9,88	3	10	27	8,5	1/8"
FTSR 101.18° N	10,15	12	75	14,82	4	10	18	11,1	1/4"
FTSR 111.18° N	11,15	12	75	14,82	4	10	18	14,5	3/8"
FTSR 142.14° N	14,25	16	80	19,05	4	10	14	18-23	1/2"-3/4"
FTSR 196.11° N	19,60	20	90	23,19	5	12	11 1/2	29-44-56	1"-1 1/2-2"

PARAMETRI DI TAGLIO A PAG. 1175
 CUTTING DATA ON PAGE 1175
 SCHNITTPARAMETER AUF SEITE 1175
 PARAMETRES DE COUPE PAGE 1175

FTAN ... F

ALLUMINIO / ALUMINIUM

TOLLERANZE
 TOLERANCE RANGE

D	d
	h6



ØD = 5,9 - 19,6

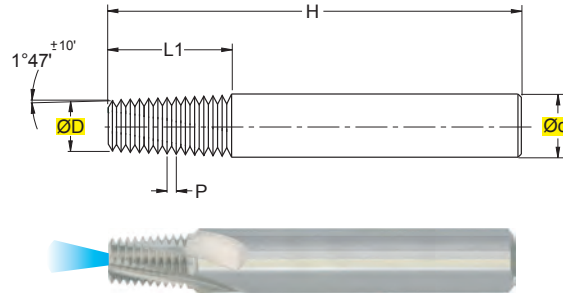

MG





> PER FILETTATURE NPT CONICHE 60°
 > ATTACCO DIN 6535 HA

> FOR 60° TAPERED NPT-NPTF THREAD
 > SHANK DIN 6535 HA

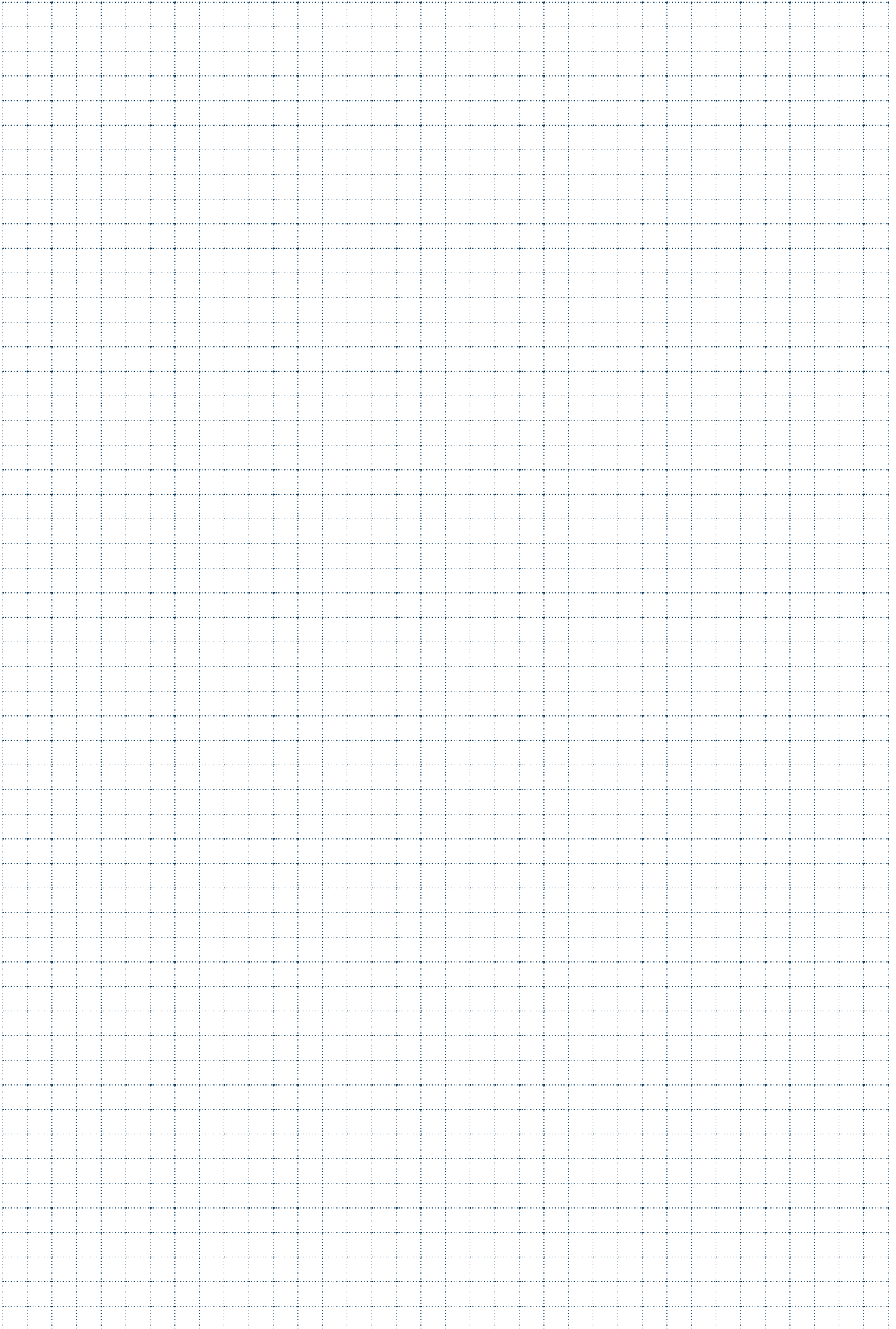
ART.	(mm)		H ⁺¹	L1	Z	Filetti utili Thread useful	P	Preforo d. Prebore	Filetto eseguibile Thread type
FTAN 059.27° F	5,90	8	55	9,88	3	10	27	6,3	1/16"
FTAN 076.27° F	7,65	8	55	9,88	3	10	27	8,5	1/8"
FTAN 101.18° F	10,15	12	75	14,82	4	10	18	11,1	1/4"
FTAN 111.18° F	11,15	12	75	14,82	4	10	18	14,5	3/8"
FTAN 142.14° F	14,25	16	80	19,05	4	10	14	18-23	1/2"-3/4"
FTAN 196.11° F	19,60	20	90	23,19	5	12	11 1/2	29-44-56	1"-1 3/4"-1 1/2"-2"

PARAMETRI DI TAGLIO A PAG. 1175
 CUTTING DATA ON PAGE 1175
 SCHNITTPARAMETER AUF SEITE 1175
 PARAMETRES DE COUPE PAGE 1175

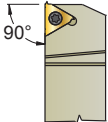

S 		S 			
SER/L Pag.830		ANR/L Pag.831			
					
	16ER/EL 22ER/EL		11IR/IL 16IR/IL 22IR/IL		
□ 16x16 - 32x32		∅Dmin 12			
SEDR/L Pag.830		SIR/L Pag.831			
NEW 			 		
	16ER/EL		06IR/IL 08IR/IL 08U IR/IL		
□ 20x20 - 25x25		∅Dmin 6			

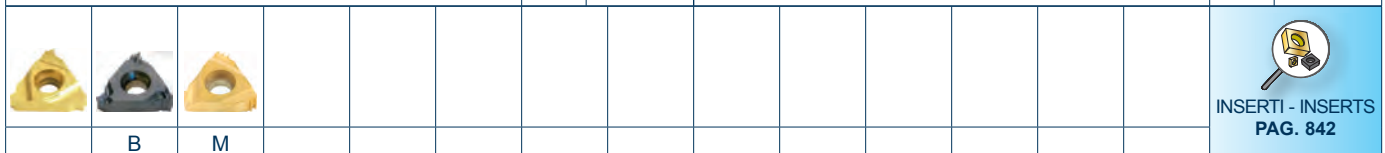
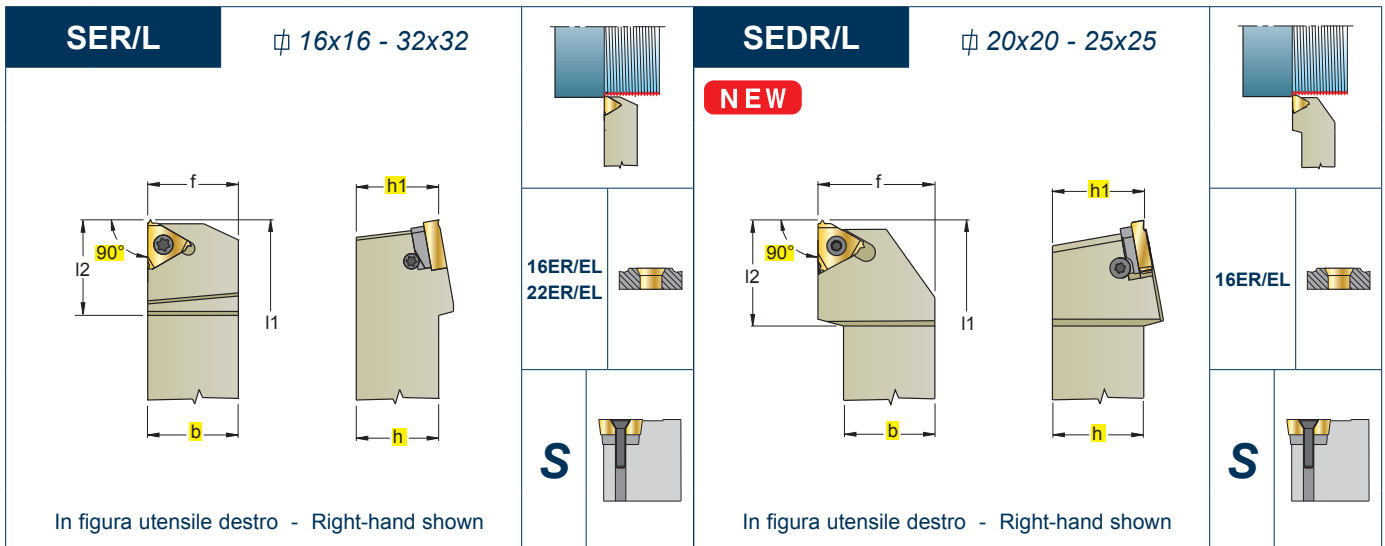

ART.		(mm)							Nm	16ER/EL	1	2	3	4	5
R	L	h=h1	b	f	l1	l2									
SER/L	1616 H 16	16	16	16	100	25	1,8+2,0	16ER/EL	U16ER/IR	VS16TP	S16TP	5510P			
SER/L	2020 K 16	20	20	20	125	27	1,8+2,0								
SER/L	2525 M 16	25	25	25	150	29	1,8+2,0								
SER/L	3225 P 16	32	25	25	170	29	1,8+2,0								
SER/L	2525 M 22	25	25	25	150	29	2,5+3,0	22ER/EL	U22ER/IR	VS22T	S22T	5520			
SER/L	3232 P 22	32	32	32	170	29	2,5+3,0								

PER UTENSILE R MONTARE INSERTO ..ER.. , PER UTENSILE L MONTARE INSERTO ..EL..
 FOR R TOOL FIT INSERT ..ER.. , FOR L TOOL FIT INSERT ..EL..
 FÜR DAS WERKZEUG R DIE WENDEPLATTE ..ER.. EINSETZEN; FÜR DAS WERKZEUG L DIE WENDEPLATTE ..EL..
 DANS LE CAS DE L'OUTIL R MONTER LA PLAQUETTE ..ER.. , DANS LE CAS DE L'OUTIL L MONTER LA PLAQUETTE ..EL..

SEDR/L	2020 K 16	20	20	25	125	27	1,8+2,0	16ER/EL	U16ER/IR	VS16TP	S16TP	5510P		
SEDR/L	2525 M 16	25	25	32	150	29	1,8+2,0							

PER UTENSILE R MONTARE INSERTO ..ER.. , PER UTENSILE L MONTARE INSERTO ..EL..
 FOR R TOOL FIT INSERT ..ER.. , FOR L TOOL FIT INSERT ..EL..
 FÜR DAS WERKZEUG R DIE WENDEPLATTE ..ER.. EINSETZEN; FÜR DAS WERKZEUG L DIE WENDEPLATTE ..EL..
 DANS LE CAS DE L'OUTIL R MONTER LA PLAQUETTE ..ER.. , DANS LE CAS DE L'OUTIL L MONTER LA PLAQUETTE ..EL..

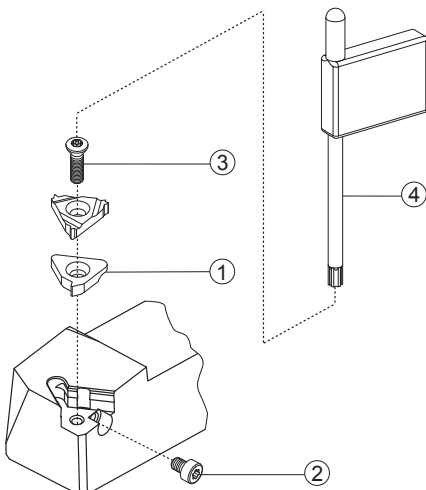

VELOCITÀ DI TAGLIO Vc
 Vc. CUTTING SPEED
 Vc. SCHNITTGESCHWINDIGKEIT
 Vc. VITESSE DE COUPE

DETTAGLIO RICAMBI
 SPARE PARTS DETAILS
 DETAILS ZU DEN ERSATZTEILEN
 DÉTAIL DE PIÈCES DE RECHANGE

DATI TECNICI E CONSIGLI
 TECHNICAL DATA AND SUGGESTIONS
 TECHNISCHE DATEN UND EMPFEHLUNGEN
 DONNÉES TECHNIQUES ET CONSEILS



PAG. 870



PAG. 1103



PAG. 1178

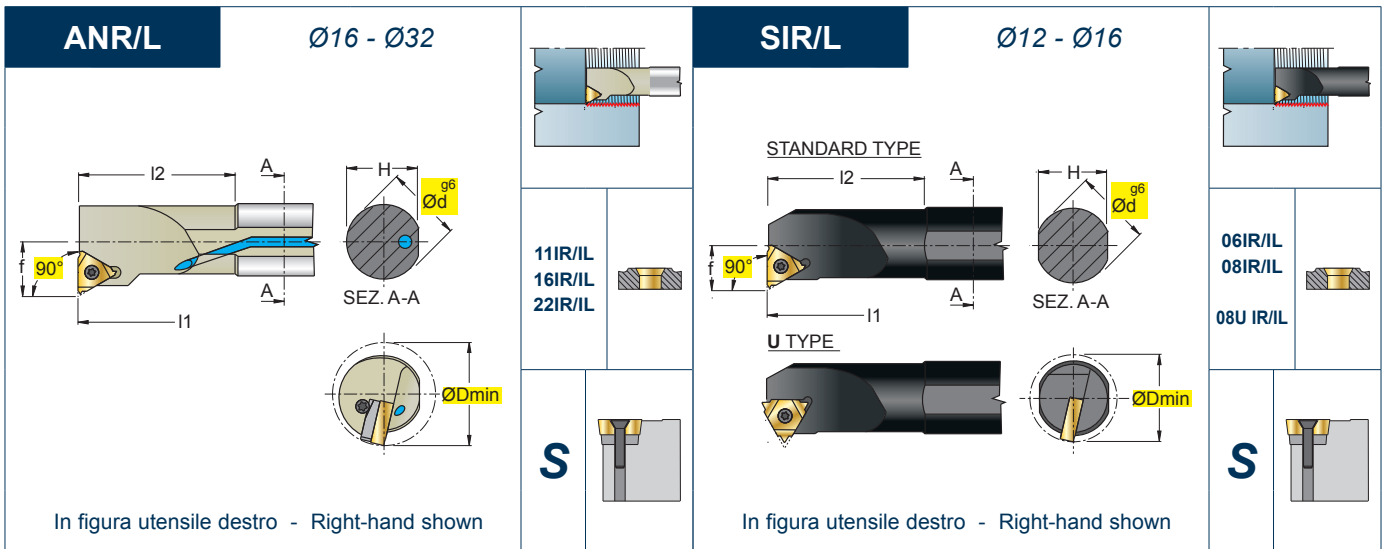

ART.		(mm)	ØDmin	Ød	f	H	l1	l2	Nm	Icon	Inserts			
											1	2	3	4
ANR/L	0010	K 11	12	16	6,6	15,25	125	24,65	1,0÷1,2	11IR/IL	-	-	12254P	5507P
ANR/L	0013	L 11	15	16	8,2	15,25	140	32,00	1,0÷1,2					
ANR/L	0016	M 16	19	16	10,6	15,25	150	40,00	3,0÷3,5	16IR/IL	-	-	123511P	5515P
ANR/L	0020	Q 16	24	20	14,0	19	180	50,00	1,8÷2,0	16IR/IL	U16IR/ER	VS16TP	S16TP	5510P
ANR/L	0025	R 16	29	25	16,3	24	200	55,00	1,8÷2,0					
ANR/L	0032	S 16	36	32	19,6	31	250	55,00	1,8÷2,0					
ANR/L	0020	Q 22	27	20	15,6	19	180	50,00	2,5÷3,0	22IR/IL	-	-	S22T	5620
ANR/L	0025	R 22	32	25	17,4	24	200	60,00	2,5÷3,0	22IR/IL	U22IR/ER	VS22T	S22T	5620
ANR/L	0032	S 22	39	32	21,5	31	250	60,00	2,5÷3,0					

PER UTENSILE R MONTARE INSERTO ..IR.. , PER UTENSILE L MONTARE INSERTO ..IL..
 FOR R TOOL FIT INSERT ..IR.. , FOR L TOOL FIT INSERT ..IL..
 FÜR DAS WERKZEUG R DIE WENDEPLATTE ..IR.. EINSETZEN; FÜR DAS WERKZEUG L DIE WENDEPLATTE ..IL..
 DANS LE CAS DE L'OUTIL R MONTER LA PLAQUETTE ..IR.. , DANS LE CAS DE L'OUTIL L MONTER LA PLAQUETTE ..IL..

SIR/L	0005	H06	6,0	12	4,3	11	100	12	0,5÷0,6	06IR/IL	-	-	122042	5606
SIR/L	0007	K08	7,8	16	5,3	14	125	18	0,5÷0,6	08IR/IL	-	-	12205	5606
SIR/L	0008	K08U	9,0	16	6,6	14	125	21	0,5÷0,6	08U IR/IL	-	-	12205	5606

PER UTENSILE R MONTARE INSERTO ..IR.. , PER UTENSILE L MONTARE INSERTO ..IL..
 FOR R TOOL FIT INSERT ..IR.. , FOR L TOOL FIT INSERT ..IL..
 FÜR DAS WERKZEUG R DIE WENDEPLATTE ..IR.. EINSETZEN; FÜR DAS WERKZEUG L DIE WENDEPLATTE ..IL..
 DANS LE CAS DE L'OUTIL R MONTER LA PLAQUETTE ..IR.. , DANS LE CAS DE L'OUTIL L MONTER LA PLAQUETTE ..IL..

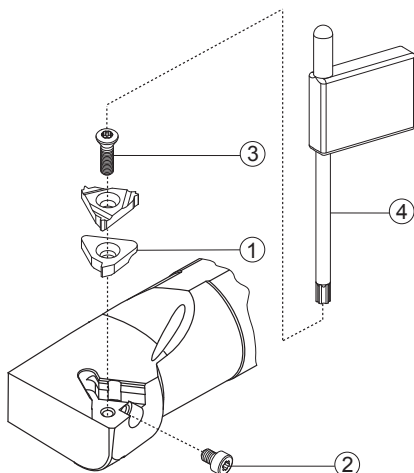

VELOCITÀ DI TAGLIO Vc
 Vc. CUTTING SPEED
 Vc. SCHNITTGESCHWINDIGKEIT
 Vc. VITESSE DE COUPE

DETTAGLIO RICAMBI
 SPARE PARTS DETAILS
 DETAILS ZU DEN ERSATZTEILEN
 DÉTAIL DE PIÈCES DE RECHANGE

DATI TECNICI E CONSIGLI
 TECHNICAL DATA AND SUGGESTIONS
 TECHNISCHE DATEN UND EMPFEHLUNGEN
 DONNÉES TECHNIQUES ET CONSEILS



PAG. 870



PAG. 1103



PAG. 1178

FILETTATURA DESTRA / UTENSILE ESTERNO DESTRO - RIGHT THREADING / EXTERNAL RIGHT TOOL

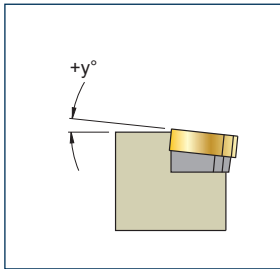
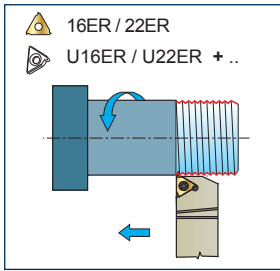

- cod. SER 1616 H16
- cod. SER 2020 K16
- cod. SER 2525 M16
- cod. SER 3225 P16
- cod. SER 2525 M22
- cod. SER 3232 P22
- cod. SEDR 2020 K16
- cod. SEDR 2525 M16

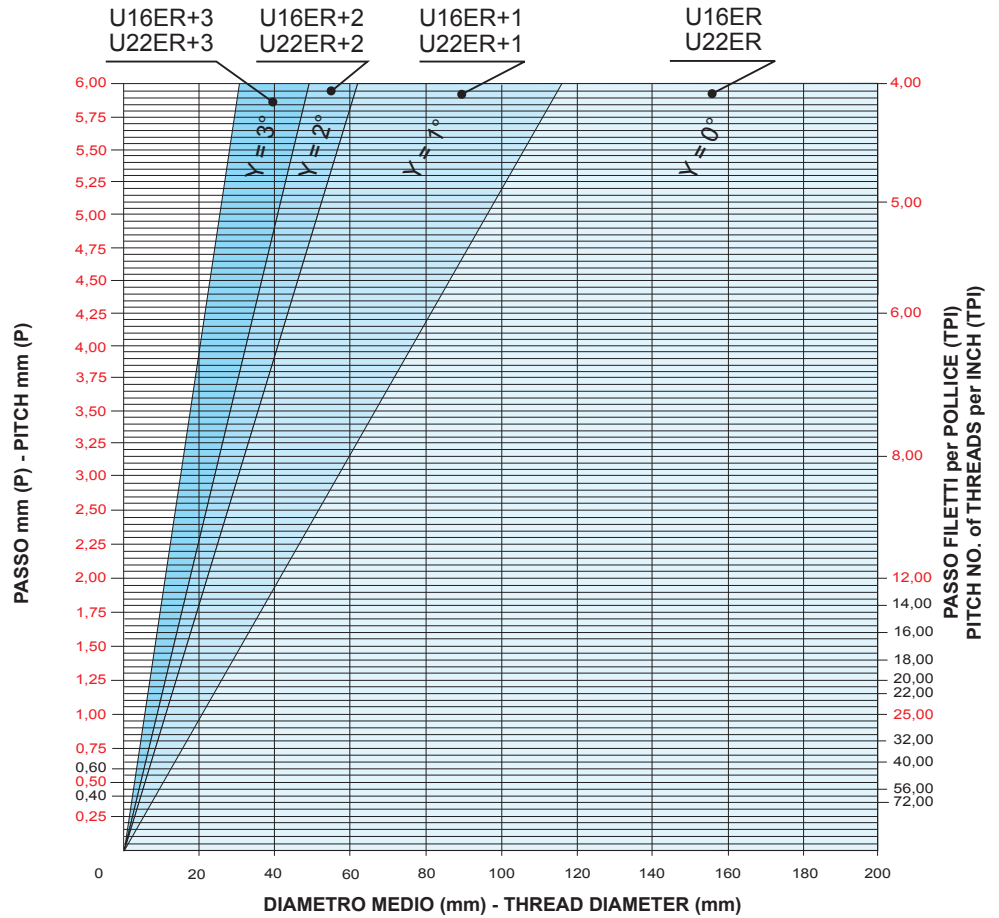

FILETTATURA SINISTRA / UTENSILE ESTERNO SINISTRO - LEFT THREADING / EXTERNAL LEFT TOOL

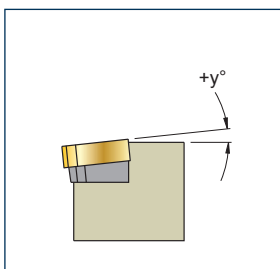
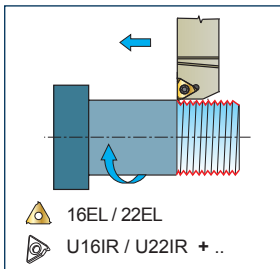

- cod. SEL 1616 H16
- cod. SEL 2020 K16
- cod. SEL 2525 M16
- cod. SEL 3225 P16
- cod. SEL 2525 M22
- cod. SEL 3232 P22
- cod. SEDL 2020 K16
- cod. SEDL 2525 M16

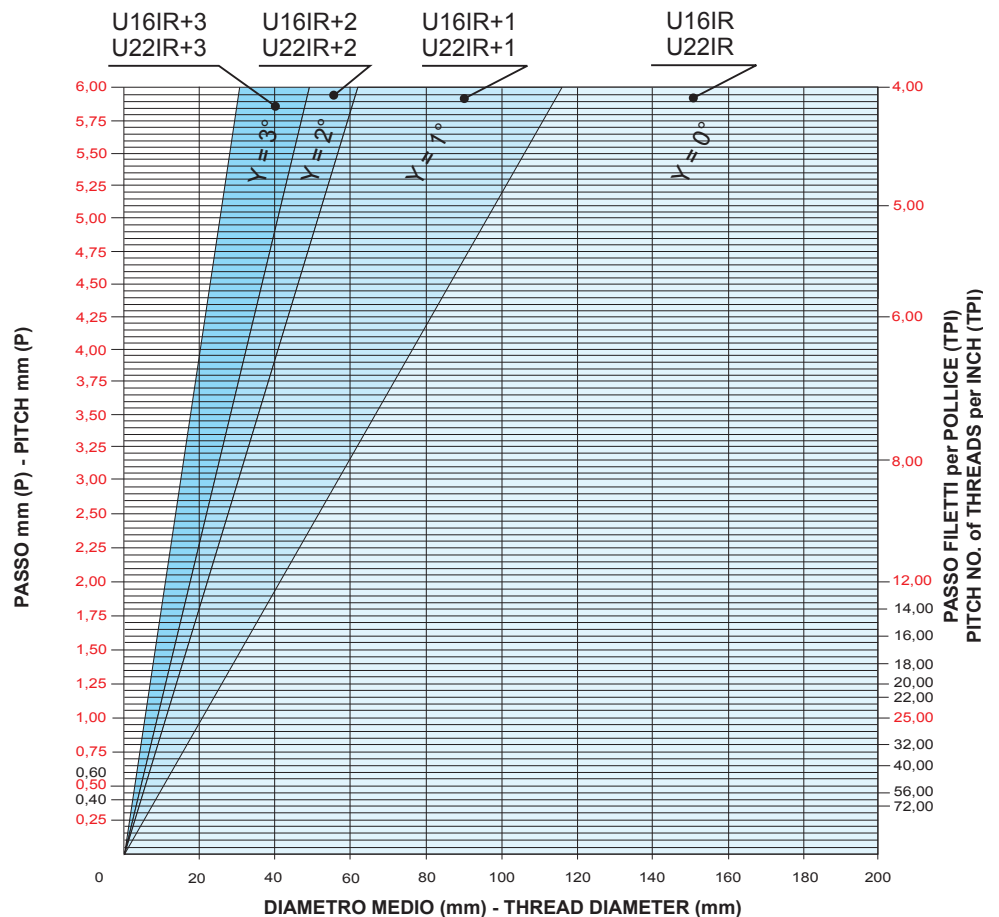

FILETTATURA DESTRA / UTENSILE ESTERNO SINISTRO - RIGHT THREADING / EXTERNAL LEFT TOOL

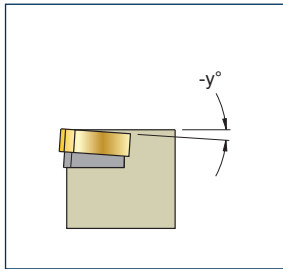
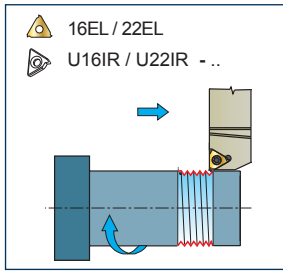

- cod. SEL 1616 H16
- cod. SEL 2020 K16
- cod. SEL 2525 M16
- cod. SEL 3225 P16
- cod. SEL 2525 M22
- cod. SEL 3232 P22
- cod. SEDL 2020 K16
- cod. SEDL 2525 M16

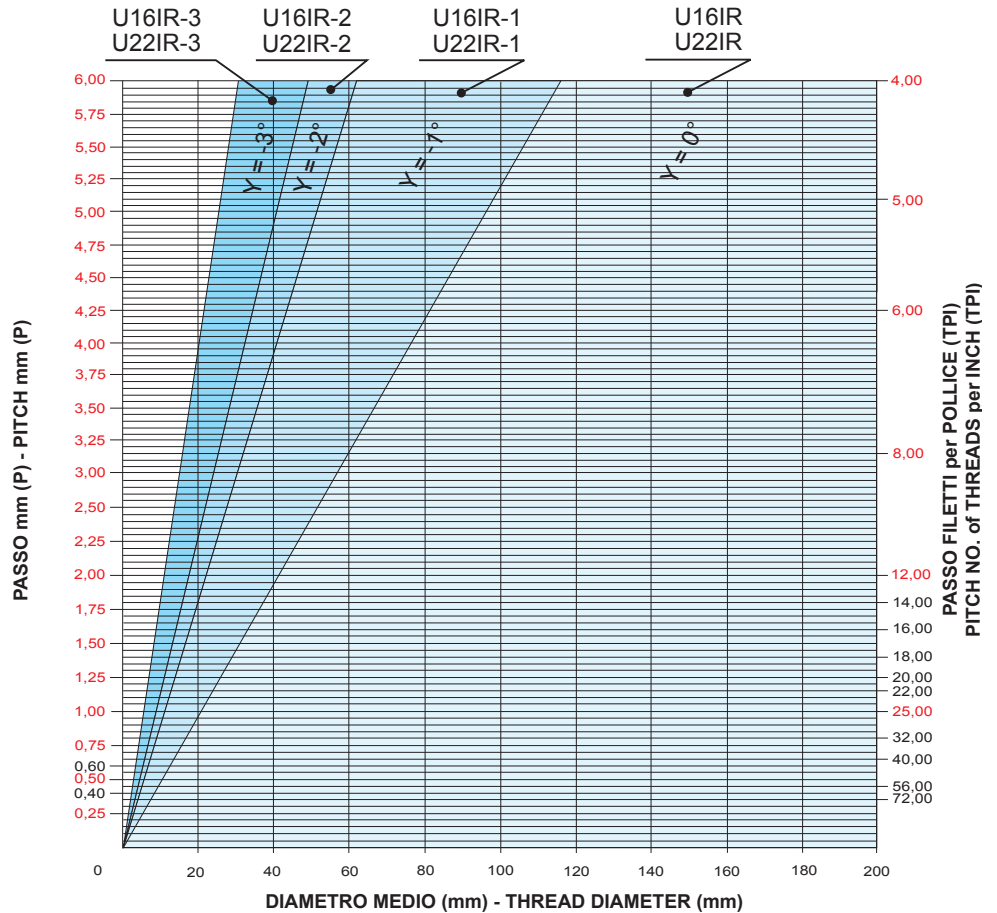

FILETTATURA SINISTRA / UTENSILE ESTERNO DESTRO - LEFT THREADING / EXTERNAL RIGHT TOOL

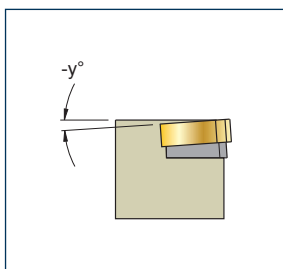
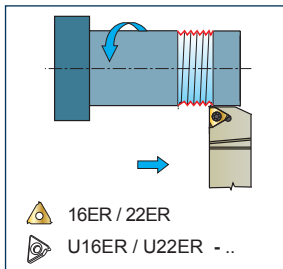

- cod. SER 1616 H16
- cod. SER 2020 K16
- cod. SER 2525 M16
- cod. SER 3225 P16
- cod. SER 2525 M22
- cod. SER 3232 P22
- cod. SEDR 2020 K16
- cod. SEDR 2525 M16

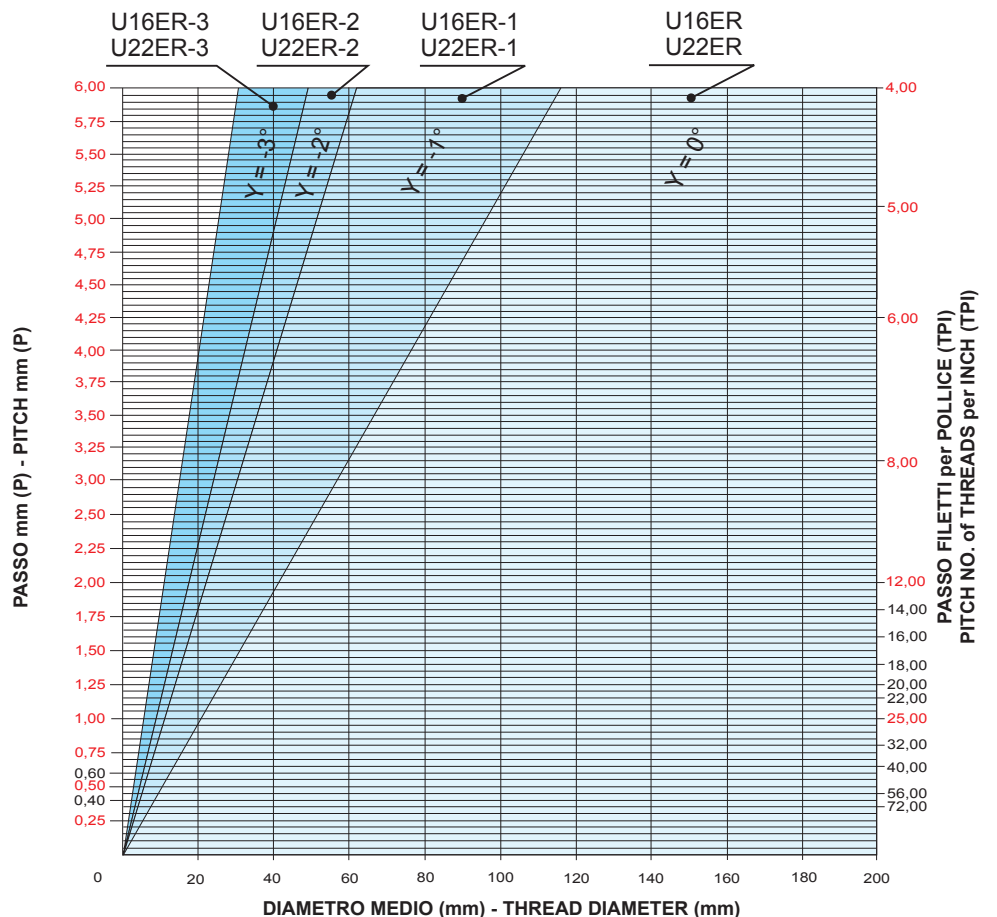

FILETTATURA DESTRA / UTENSILE INTERNO DESTRO - RIGHT THREADING / INTERNAL RIGHT TOOL

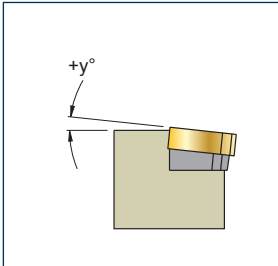
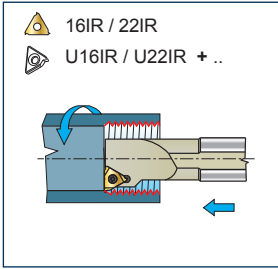

- cod. ANR 0016 M16
- cod. ANR 0020 Q16
- cod. ANR 0025 R16
- cod. ANR 0032 S16
- cod. ANR 0020 Q22
- cod. ANR 0025 R22
- cod. ANR 0032 S22

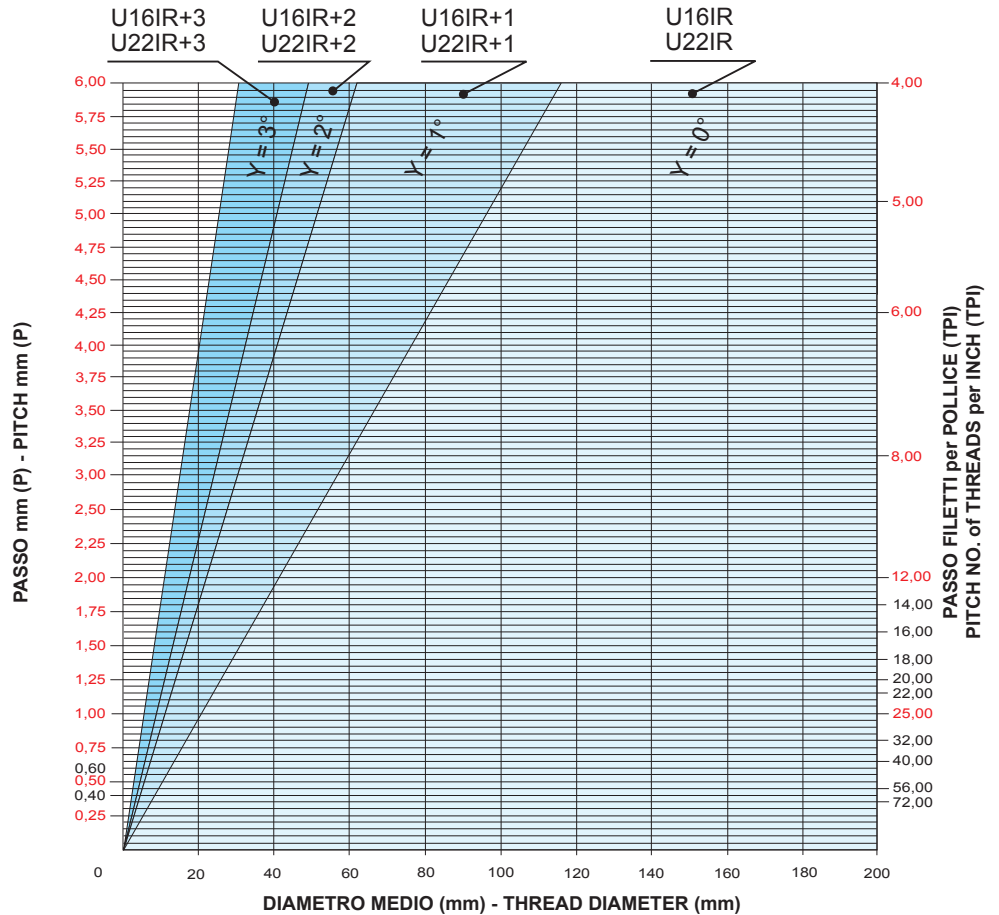

FILETTATURA SINISTRA / UTENSILE INTERNO SINISTRO - LEFT THREADING / INTERNAL LEFT TOOL

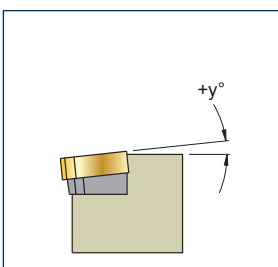
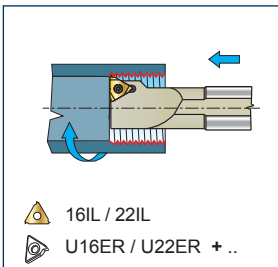

- cod. ANL 0016 M16
- cod. ANL 0020 Q16
- cod. ANL 0025 R16
- cod. ANL 0032 S16
- cod. ANL 0020 Q22
- cod. ANL 0025 R22
- cod. ANL 0032 S22

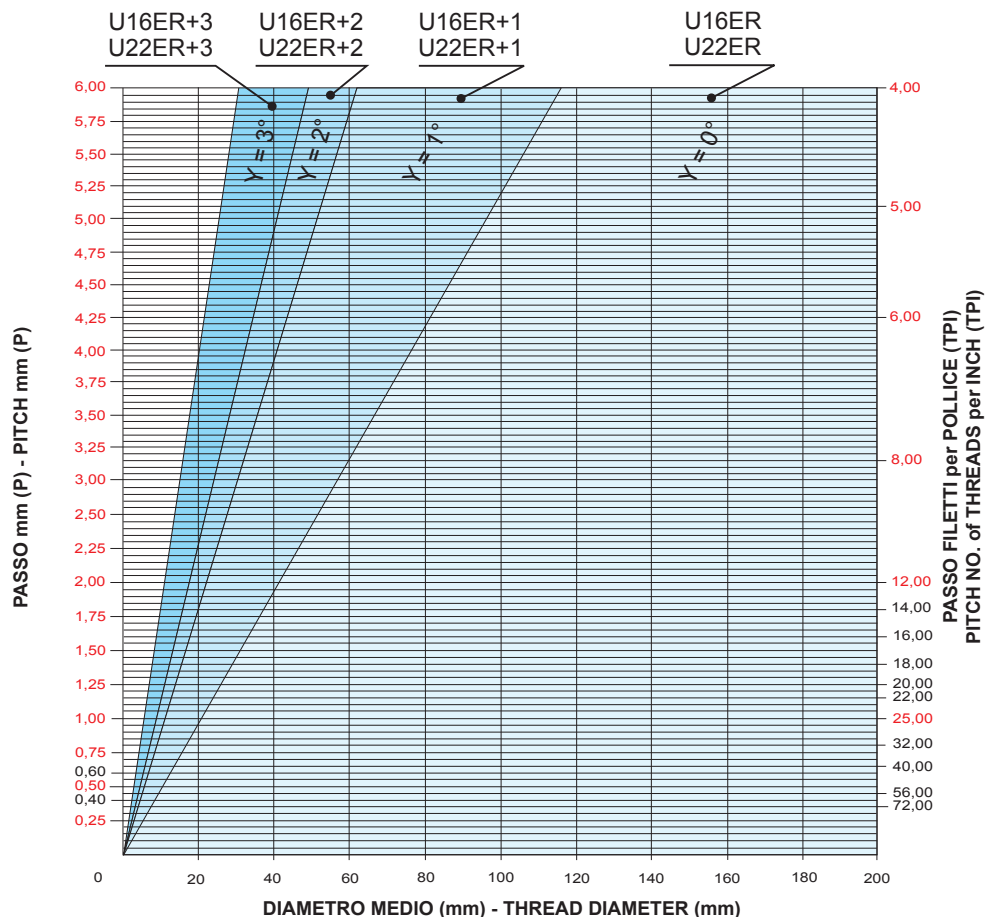

FILETTATURA DESTRA / UTENSILE INTERNO SINISTRO - RIGHT THREADING / INTERNAL LEFT TOOL

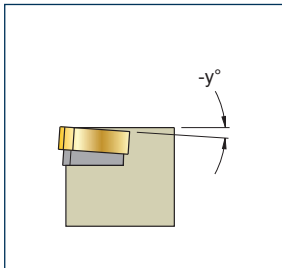
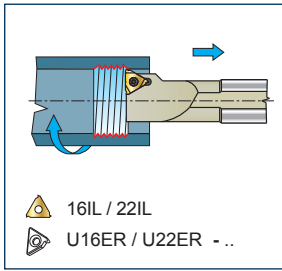

- cod. ANL 0016 M16
- cod. ANL 0020 Q16
- cod. ANL 0025 R16
- cod. ANL 0032 S16
- cod. ANL 0020 Q22
- cod. ANL 0025 R22
- cod. ANL 0032 S22

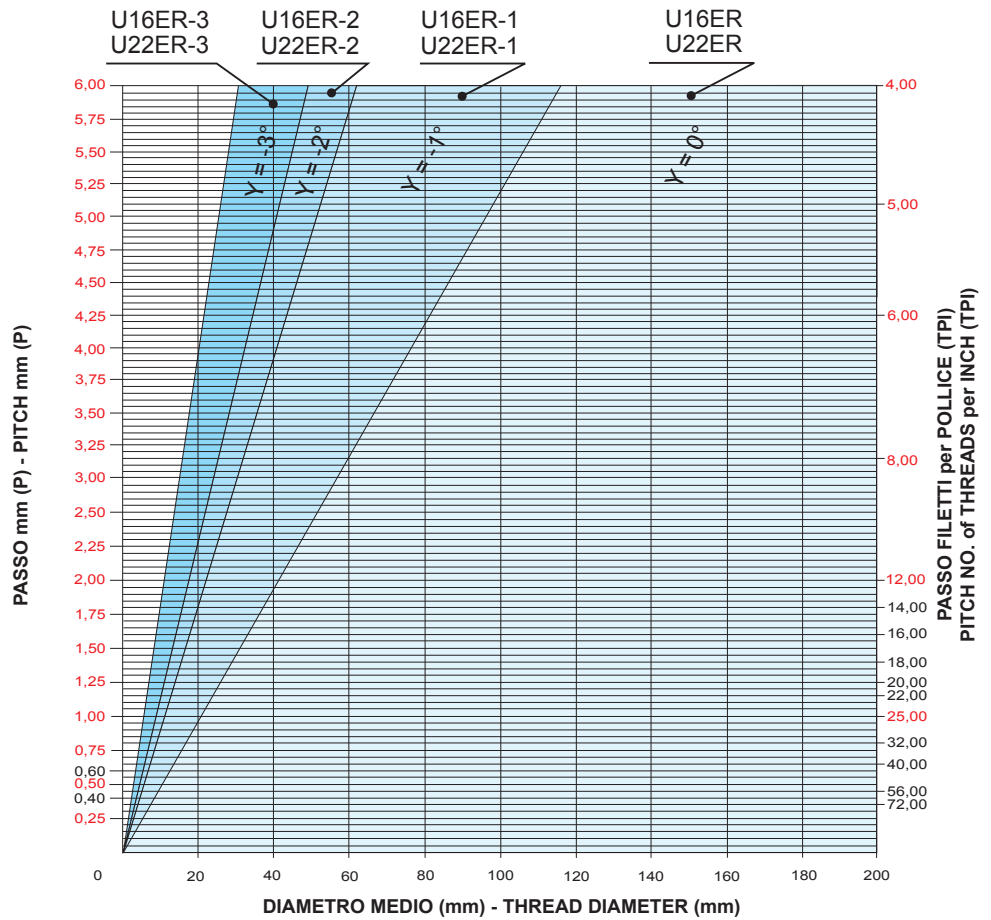

FILETTATURA SINISTRA / UTENSILE INTERNO DESTRO - LEFT THREADING / INTERNAL RIGHT TOOL

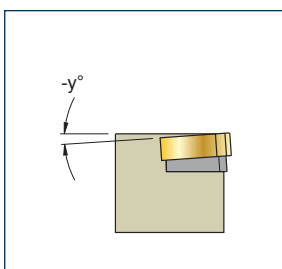
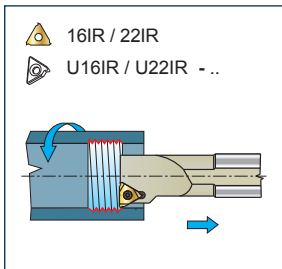

- cod. ANR 0016 M16
- cod. ANR 0020 Q16
- cod. ANR 0025 R16
- cod. ANR 0032 S16
- cod. ANR 0020 Q22
- cod. ANR 0025 R22
- cod. ANR 0032 S22

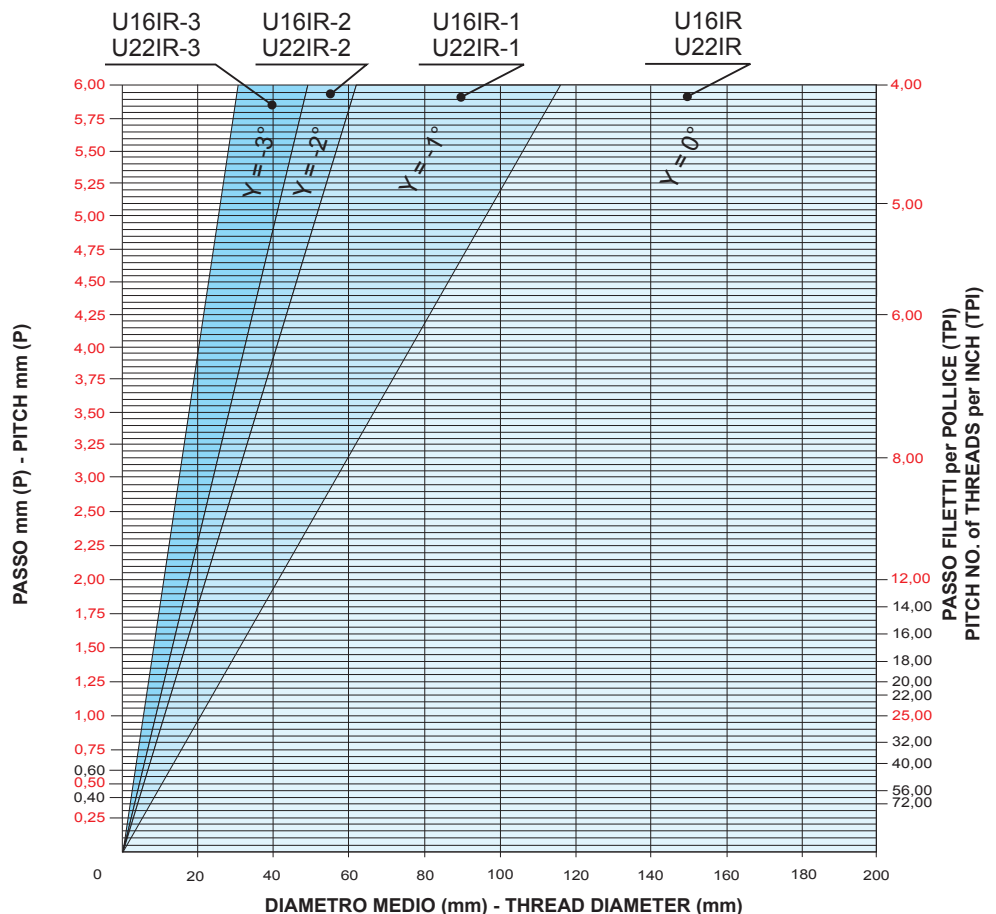

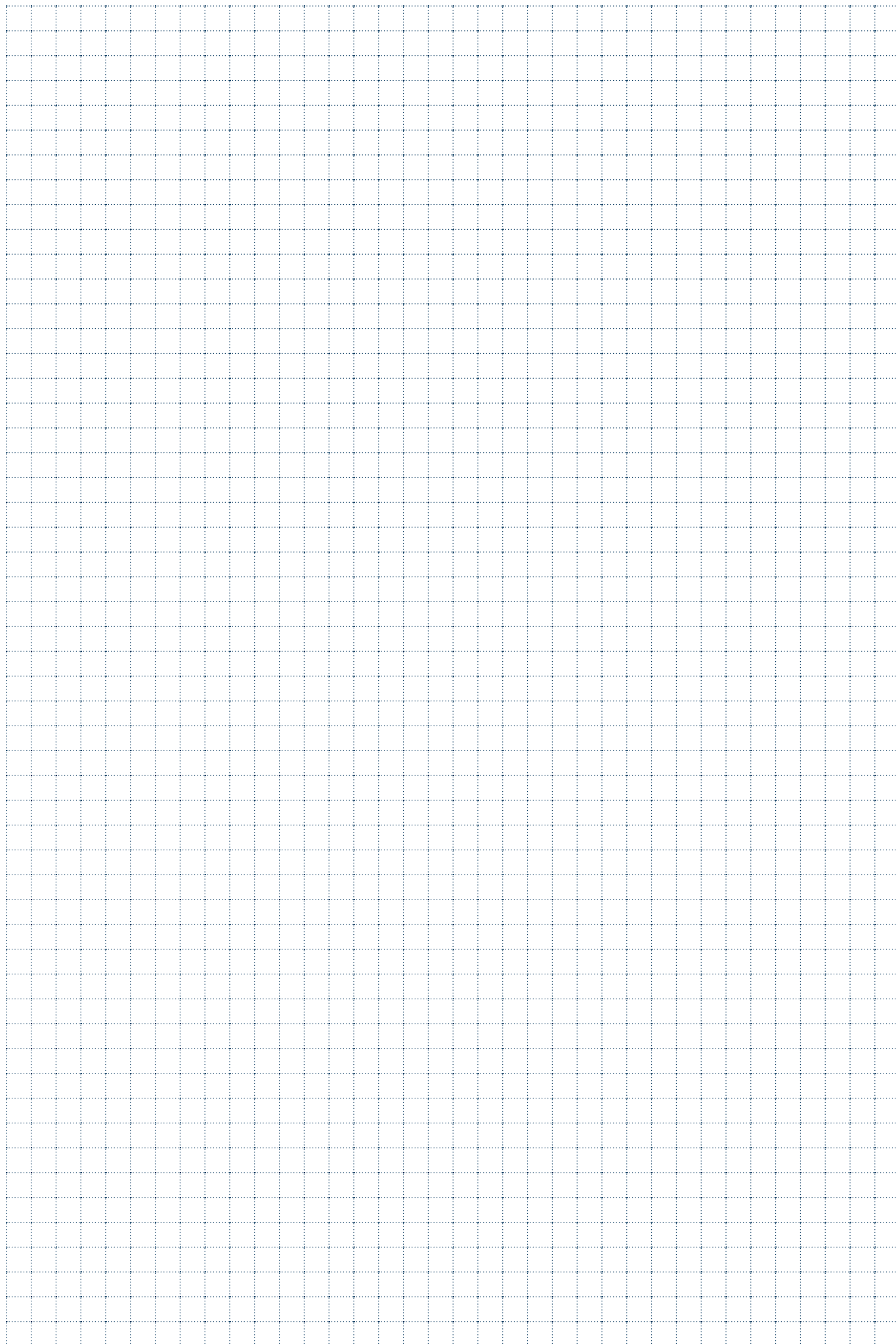

S 					
SC.. SER/L Pag.838					
					
	16ER/EL				
<i>PSC40 - PSC50 - PSC63</i>					
SC.. ANR/L Pag.839					
					
	16IR/IL				
<i>PSC40 - PSC50 - PSC63</i>					

SC.. SER/L

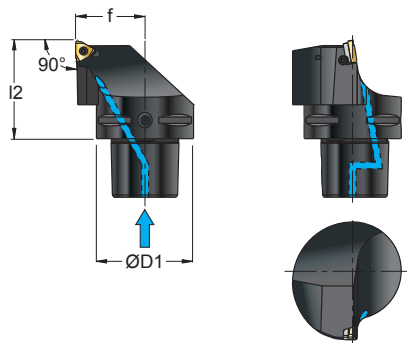

In figura utensile destro - Right-hand shown



B	M
---	---

ART.		(mm)												
		ØD1	f	l2	Nm		1	2	3	4				

SC40 SER/L 27050-16 PSC40 40 27 50 1,8+2,0 16ER/EL U16ER/IR VS16TP S16TP 5510P

SC50 SER/L 35060-16 PSC50 50 35 60 1,8+2,0

SC63 SER/L 45065-16 PSC63 63 45 65 1,8+2,0

INSERTI - INSERTS
 PAG. 842

PER UTENSILE R MONTARE INSERTO ..ER.. , PER UTENSILE L MONTARE INSERTO ..EL..
 FOR R TOOL FIT INSERT ..ER.. , FOR L TOOL FIT INSERT ..EL..
 FÜR DAS WERKZEUG R DIE WENDEPLATTE ..ER.. EINSETZEN; FÜR DAS WERKZEUG L DIE WENDEPLATTE ..EL..
 DANS LE CAS DE L'OUTIL R MONTER LA PLAQUETTE ..ER.. , DANS LE CAS DE L'OUTIL L MONTER LA PLAQUETTE ..EL..

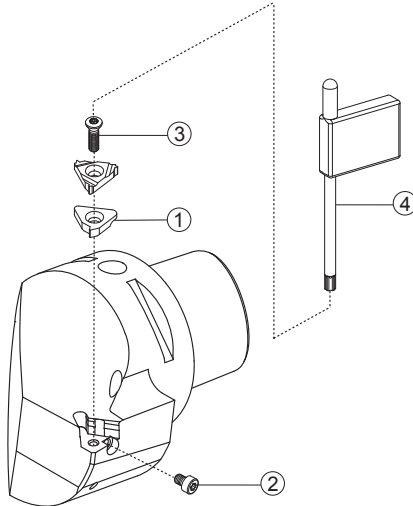

VELOCITÀ DI TAGLIO Vc
 Vc. CUTTING SPEED
 Vc. SCHNITTGESCHWINDIGKEIT
 Vc. VITESSE DE COUPE

DETTAGLIO RICAMBI
 SPARE PARTS DETAILS
 DETAILS ZU DEN ERSATZTEILEN
 DÉTAIL DE PIÈCES DE RECHANGE

DATI TECNICI E CONSIGLI
 TECHNICAL DATA AND SUGGESTIONS
 TECHNISCHE DATEN UND EMPFEHLUNGEN
 DONNÉES TECHNIQUES ET CONSEILS

PAG. 870

PAG. 1103

PAG. 1178

SC.. ANR/L

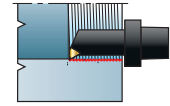
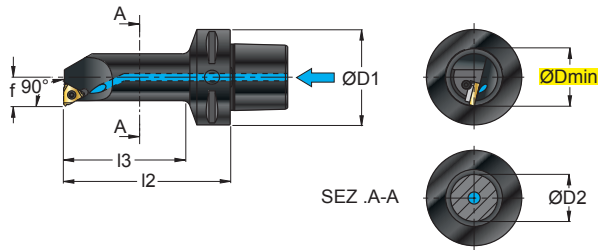

16IR/IL



S



In figura utensile destro - Right-hand shown

ART.		(mm)												INSERTI - INSERTS PAG. 842		
				ØDmin	ØD1	ØD2	f	l2	l3	Nm						
SC40 ANR/L 17090-16	PSC40	32	40	25	17	90	65	1,8±2,0	16IR/IL	U16IR/ER	VS16TP	S16TP	5510P			
SC50 ANR/L 17090-16	PSC50	32	50	25	17	90	65	1,8±2,0								
SC63 ANR/L 20110-16	PSC63	39	63	31	20	110	78	1,8±2,0								

PER UTENSILE R MONTARE INSERTO ..IR.. , PER UTENSILE L MONTARE INSERTO ..IL..
 FOR R TOOL FIT INSERT ..IR.. , FOR L TOOL FIT INSERT ..IL..
 FÜR DAS WERKZEUG R DIE WENDEPLATTE ..IR.. EINSETZEN; FÜR DAS WERKZEUG L DIE WENDEPLATTE ..IL..
 DANS LE CAS DE L'OUTIL R MONTER LA PLAQUETTE ..IR.. , DANS LE CAS DE L'OUTIL L MONTER LA PLAQUETTE ..IL..

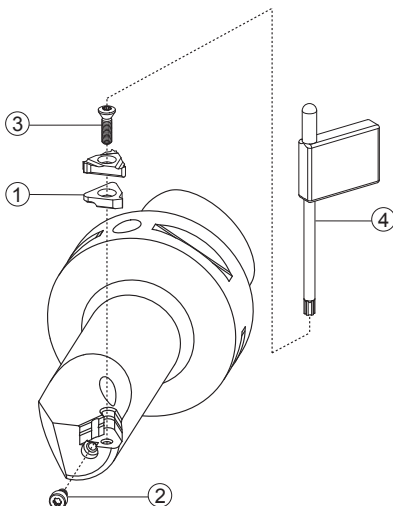

VELOCITÀ DI TAGLIO Vc
 Vc. CUTTING SPEED
 Vc. SCHNITTGESCHWINDIGKEIT
 Vc. VITESSE DE COUPE



PAG. 870

DETTAGLIO RICAMBI
 SPARE PARTS DETAILS
 DETAILS ZU DEN ERSATZTEILEN
 DÉTAIL DE PIÈCES DE RECHANGE





PAG. 1103

DATI TECNICI E CONSIGLI
 TECHNICAL DATA AND SUGGESTIONS
 TECHNISCHE DATEN UND EMPFEHLUNGEN
 DONNÉES TECHNIQUES ET CONSEILS



PAG. 1178

	CATALOGO DISPONIBILITÀ INSERTI	Pag. 842
	COME SCEGLIERE I PARAMETRI DI LAVORO	Pag. 867
	PANORAMICA QUALITÀ DI FILETTATURA	Pag. 869
	IMPIEGO DELLE QUALITÀ DI FILETTATURA	Pag. 869
	VELOCITÀ DI TAGLIO DELLE QUALITÀ DI FILETTATURA	Pag. 870
	PARAMETRI DI TAGLIO	Pag. 871

	INSERTS STOCK CATALOGUE	Pag. 842
	HOW TO CHOOSE CUTTING DATA	Pag. 867
	GENERAL VIEW OF THE THREADING GRADE	Pag. 869
	APPLICATION OF THE THREADING GRADE	Pag. 869
	CUTTING SPEED OF THREADING GRADES	Pag. 870
	CUTTING DATA	Pag. 871

	WENDEPLATTENBESTAND-KATALOG	Pag. 842
	EINSTELLUNG DER SCHNITTDATEN	Pag. 867
	GEWINDESCHNEIDEN-ÜBERSICHT	Pag. 869
	EINSATZ DER GEWINDESCHNEIDEN	Pag. 869
	SCHNITTGESCHWINDIGKEIT DER GEWINDEQUALITÄTEN	Pag. 870
	SCHNITTPARAMETER	Pag. 871

	CATALOGUE DE DISPONIBILITÉ PLAQUETTES	Pag. 842
	COMMENT CHOISIR LES PARAMETRES DE SERVICE	Pag. 867
	VUE D'ENSEMBLE QUALITÉ DE FILETAGE	Pag. 869
	UTILISATION DE LES QUALITÉES DE FILETAGE	Pag. 869
	VITESSE DE COUPE DE LA QUALITÉ DE PLAQUETTES DE FILETAGE	Pag. 870
	PARAMETRES DE COUPE	Pag. 871



INSERTI PER FILETTATURA

THREADING INSERTS / WENDEPLATTEN ZUM GEWINDESCHNEIDEN
PLAQUÉTTES DE FILETAGE / PLAQUITAS DE FILETADURA



						HW		HC								
...ER ... / ...ILEL ... / ...IRU ...		NON RIVESTITI CEMENTED CARBIDE GRADES		RIVESTITI COATED GRADES BESCHICHTET RECOUVERTS								
ART.		COD.		l	d	b	P(mm)	R	L	R	L	R	L	R	L	
								F7030	F7030	F1025	F1025	F7040	F7040	F7040	F7040	
PROFILO PARZIALE b = 60° PARTIAL - PROFILE b = 60°																
		11ER A60	11EL A60	11	6,35	60°	0,5+1,5									
		16ER A60	16EL A60	16,5	9,52	60°	0,5+1,5									
		16ER G60	16EL G60	16,5	9,52	60°	1,75+3,0									
		16ER AG60	16EL AG60	16,5	9,52	60°	0,5+3,0									
		22ER N60	22EL N60	22	12,7	60°	3,5+5,0									
		06IR A60	06IL A60	6,9	3,97	60°	0,5+1,25									
		08IR A60	08IL A60	8,2	4,76	60°	0,5+1,5									
		08U IR U60	08U IL U60	8,2U	4,76U	60°	1,75+2,0									
		11IR A60	11IL A60	11	6,35	60°	0,5+1,5									
		16IR A60	16IL A60	16,5	9,52	60°	0,5+1,5									
		16IR G60	16IL G60	16,5	9,52	60°	1,75+3,0									
		16IR AG60	16IL AG60	16,5	9,52	60°	0,5+3,0									
		22IR N60	22IL N60	22	12,7	60°	3,5+5,0									
MATERIALE - MATERIAL - MATERIALIEN - MATÉRIAUX								R	L	R	L	R	L	R	L	
								F7030	F7030	F1025	F1025	F7040	F7040	F7040	F7040	
P	ACCIAIO - STEEL - STAHL - ACIER								●				●	●		
M	ACCIAIO INOX - STAINLESS STEEL - ROSTFREIER STAHL - ACIER INOXYDABLE								●					○		
K	GHISA - CAST IRON - GRAUGUSS - FONTE GRISE								●					●		
N	LEGHE DI ALLUMINIO - ALUMINIUM ALLOYS - ALUMINIUM-LEGIERUNGEN - ALLIAGES D'ALUMINIUM								○					●		
S	LEGHE RESISTENTI AL CALORE - HEAT RESISTANT ALLOYS - WÄRMEBESTÄNDIGE LEGIERUNGEN - ALLIAGES RÉSIDANTES À LA CHALEUR								●					○		
H	MATERIALI DURI E TEMPRATI - HARD AND HARDENED MATERIAL - HARTE UND GEHÄRTETE MATERIALIEN - MATERIAUX DURS ET TREMPÉS								○					○		

			HW		HC														
..ER .. / ..ILEL .. / ..IRU ..	NON RIVESTITI CEMENTED CARBIDE GRADES		RIVESTITI COATED GRADES BESCHICHTET RECOUVERTS														
ART.	COD.	l	d	b	P(mm)														

PROFILO PARZIALE b = 55°
PARTIAL - PROFILE b = 55°

	11ER A55	11EL A55	11	6,35	55°	0,5+1,5													
	16ER A55	16EL A55	16,5	9,52	55°	0,5+1,5													
	16ER G55	16EL G55	16,5	9,52	55°	1,75+3,0													
	16ER AG55	16EL AG55	16,5	9,52	55°	0,5+3,0													
	22ER N55	22EL N55	22	12,7	55°	3,5+5,0													
	06IR A55	06IL A55	6,9	3,97	55°	0,5+1,25													
	08IR A55	08IL A55	8,2	4,76	55°	0,5+1,5													
	08U IR U55	08U IL U55	8,2U	4,76U	55°	1,75+2,0													
	11IR A55	11IL A55	11	6,35	55°	0,5+1,5													
	16IR A55	16IL A55	16,5	9,52	55°	0,5+1,5													
	16IR G55	16IL G55	16,5	9,52	55°	1,75+3,0													
	16IR AG55	16IL AG55	16,5	9,52	55°	0,5+3,0													
	22IR N55	22IL N55	22	12,7	55°	3,5+5,0													

MATERIALE - MATERIAL - MATERIALIEN - MATÉRIAUX																			
---	--	--	--	--	--	--	--	--	--	--	--	--	--	--	--	--	--	--	--

P	ACCIAIO - STEEL - STAHL - ACIER																		
M	ACCIAIO INOX - STAINLESS STEEL - ROSTFREIER STAHL - ACIER INOXYDABLE																		
K	GHISA - CAST IRON - GRAUGUSS - FONTE GRISE																		
N	LEGHE DI ALLUMINIO - ALUMINIUM ALLOYS - ALUMINIUM-LEGIERUNGEN - ALLIAGES D'ALUMINIUM																		
S	LEGHE RESISTENTI AL CALORE - HEAT RESISTANT ALLOYS - WÄRMEBESTÄNDIGE LEGIERUNGEN - ALLIAGES RÉSISSANTES À LA CHALEUR																		
H	MATERIALI DURI E TEMPRATI - HARD AND HARDENED MATERIAL - HARTE UND GEHÄRTETE MATERIALIEN - MATERIAUX DURS ET TREMPÉS																		

...ER BIR B ...		HW		HC															
				NON RIVESTITI CEMENTED CARBIDE GRADES		RIVESTITI COATED GRADES BESCHICHTET RECOUVERTS															
ART.	COD.	l	d	b	P(mm)	F7030															
PROFILO PARZIALE DI PRECISIONE RETTIFICATO CON ROMPIRUCIOLO SINTERIZZATO b = 55°																					
PARTIAL PRECISION GROUND PROFILE WITH SINTERED CHIP-BREAKER b = 55°																					
 ..ER ..	16ER B G55	16,5	9,52	55°	1,75+3,0																
	16ER B AG55	16,5	9,52	55°	0,5+3,0																
 ..IR ..	16IR B G55	16,5	9,52	55°	1,75+3,0																
	16IR B AG55	16,5	9,52	55°	0,5+3,0																
MATERIALE - MATERIAL - MATERIALIEN - MATÉRIAUX						F7030															
P	ACCIAIO - STEEL - STAHL - ACIER					●															
M	ACCIAIO INOX - STAINLESS STEEL - ROSTFREIER STAHL - ACIER INOXYDABLE					●															
K	GHISA - CAST IRON - GRAUGUSS - FONTE GRISE					●															
N	LEGHE DI ALLUMINIO - ALUMINIUM ALLOYS - ALUMINIUM-LEGIERUNGEN - ALLIAGES D'ALUMINIUM					○															
S	LEGHE RESISTENTI AL CALORE - HEAT RESISTANT ALLOYS - WÄRMEBESTÄNDIGE LEGIERUNGEN - ALLIAGES RÉSISTANTES À LA CHALEUR					●															
H	MATERIALI DURI E TEMPRATI - HARD AND HARDENED MATERIAL - HARTE UND GEHÄRTETE MATERIALIEN - MATERIAUX DURS ET TREMPÉS					○															

■ DISPONIBILI - IN STOCK - LIEFERBAR - DISPONIBLES / ■ NEW
 ● APPLICAZIONE CONSIGLIATA-RECOMMENDED APPLICATION-
 EMPFOHLENER EINSATZ - APPLICATION CONSEILLÉE

□ A RICHIESTA - ON REQUEST - AUF ANFRAGE - SUR DEMANDE / □ NEW
 ○ APPLICAZIONE POSSIBILE - POSSIBLE APPLICATION -
 MÖGLICHE ANWENDUNG - APPLICATION POSSIBLE

...ER ... ISO		...EL ... ISO		HW		HC							
				NON RIVESTITI CEMENTED CARBIDE GRADES		RIVESTITI COATED GRADES BESCHICHTET RECOUVERTS							
ART.	COD.			l	d	b	P(mm)	R	L	R	L	R	L
								F7030	F7030	F7415	F7415	F1025	F1025

PROFILO FINITO b = 60° (ISO)
FULL - PROFILE b = 60° (ISO)

	11ER 0,35 ISO	11EL 0,35 ISO	11	6,35	60°	0,35													
	11ER 0,40 ISO	11EL 0,40 ISO	11	6,35	60°	0,40													
	11ER 0,45 ISO	11EL 0,45 ISO	11	6,35	60°	0,45													
	11ER 0,50 ISO	11EL 0,50 ISO	11	6,35	60°	0,50													
	11ER 0,60 ISO	11EL 0,60 ISO	11	6,35	60°	0,60													
	11ER 0,70 ISO	11EL 0,70 ISO	11	6,35	60°	0,70													
	11ER 0,75 ISO	11EL 0,75 ISO	11	6,35	60°	0,75													
	11ER 0,80 ISO	11EL 0,80 ISO	11	6,35	60°	0,80													
	11ER 1,00 ISO	11EL 1,00 ISO	11	6,35	60°	1,00													
	11ER 1,25 ISO	11EL 1,25 ISO	11	6,35	60°	1,25													
	11ER 1,50 ISO	11EL 1,50 ISO	11	6,35	60°	1,50													
	11ER 1,75 ISO	11EL 1,75 ISO	11	6,35	60°	1,75													
	16ER 0,35 ISO	16EL 0,35 ISO	16,5	9,52	60°	0,35													
	16ER 0,40 ISO	16EL 0,40 ISO	16,5	9,52	60°	0,40													
	16ER 0,45 ISO	16EL 0,45 ISO	16,5	9,52	60°	0,45													
	16ER 0,50 ISO	16EL 0,50 ISO	16,5	9,52	60°	0,50													
	16ER 0,60 ISO	16EL 0,60 ISO	16,5	9,52	60°	0,60													
	16ER 0,70 ISO	16EL 0,70 ISO	16,5	9,52	60°	0,70													
	16ER 0,75 ISO	16EL 0,75 ISO	16,5	9,52	60°	0,75													
	16ER 0,80 ISO	16EL 0,80 ISO	16,5	9,52	60°	0,80													
	16ER 1,00 ISO	16EL 1,00 ISO	16,5	9,52	60°	1,00													
	16ER 1,25 ISO	16EL 1,25 ISO	16,5	9,52	60°	1,25													
	16ER 1,50 ISO	16EL 1,50 ISO	16,5	9,52	60°	1,50													
	16ER 1,75 ISO	16EL 1,75 ISO	16,5	9,52	60°	1,75													
	16ER 2,00 ISO	16EL 2,00 ISO	16,5	9,52	60°	2,00													
	16ER 2,50 ISO	16EL 2,50 ISO	16,5	9,52	60°	2,50													
	16ER 3,00 ISO	16EL 3,00 ISO	16,5	9,52	60°	3,00													
	16ER 3,50 ISO	16EL 3,50 ISO	16,5	9,52	60°	3,50													
	22ER 3,50 ISO	22EL 3,50 ISO	22	12,7	60°	3,50													
	22ER 4,00 ISO	22EL 4,00 ISO	22	12,7	60°	4,00													
	22ER 4,50 ISO	22EL 4,50 ISO	22	12,7	60°	4,50													
	22ER 5,00 ISO	22EL 5,00 ISO	22	12,7	60°	5,00													
	22ER 5,50 ISO	22EL 5,50 ISO	22	12,7	60°	5,50													
	22ER 6,00 ISO	22EL 6,00 ISO	22	12,7	60°	6,00													

MATERIALE - MATERIAL - MATERIALIEN - MATÉRIAUX																			
P	ACCIAIO - STEEL - STAHL - ACIER																		
M	ACCIAIO INOX - STAINLESS STEEL - ROSTFREIER STAHL - ACIER INOXYDABLE																		
K	GHISA - CAST IRON - GRAUGUSS - FONTE GRISE																		
N	LEGHE DI ALLUMINIO - ALUMINIUM ALLOYS - ALUMINIUM-LEGIERUNGEN - ALLIAGES D'ALUMINIUM																		
S	LEGHE RESISTENTI AL CALORE - HEAT RESISTANT ALLOYS - WÄRMEBESTÄNDIGE LEGIERUNGEN - ALLIAGES RÉISTANTES À LA CHALEUR																		
H	MATERIALI DURI E TEMPRATI - HARD AND HARDENED MATERIAL - HARTE UND GEHÄRTETE MATERIALIEN - MATERIAUX DURS ET TREMPÉS																		

■ DISPONIBILI - IN STOCK - LIEFERBAR - DISPONIBLES / ■ NEW
 ● APPLICAZIONE CONSIGLIATA-RECOMMENDED APPLICATION- EMPFOHLENER EINSATZ - APPLICATION CONSEILLÉE
 □ A RICHIESTA - ON REQUEST - AUF ANFRAGE - SUR DEMANDE / □ NEW
 ○ APPLICAZIONE POSSIBILE - POSSIBLE APPLICATION - MÖGLICHE ANWENDUNG - APPLICATION POSSIBLE

						HW		HC								
						NON RIVESTITI CEMENTED CARBIDE GRADES		RIVESTITI COATED GRADES BESCHICHTET RECOUVERTS								
...IR ... ISO		...IL ... ISO		...U ... ISO				R	L	R	L	R	L	R	L	
ART.		COD.		l	d	b	P(mm)	F7030	F7030	F7415	F7415	F1025	F1025	F7040	F7040	
PROFILO FINITO b = 60° (ISO) FULL - PROFILE b = 60° (ISO)																
 ..IR ..	06IR 0,50 ISO	06IL 0,50 ISO	6,9	3,97	60°	0,50										
	06IR 0,75 ISO	06IL 0,75 ISO	6,9	3,97	60°	0,75										
	06IR 1,00 ISO	06IL 1,00 ISO	6,9	3,97	60°	1,00										
 ..IL ..	06IR 1,25 ISO	06IL 1,25 ISO	6,9	3,97	60°	1,25										
	08IR 0,50 ISO	08IL 0,50 ISO	8,2	4,76	60°	0,50										
	08IR 0,75 ISO	08IL 0,75 ISO	8,2	4,76	60°	0,75										
	08IR 1,00 ISO	08IL 1,00 ISO	8,2	4,76	60°	1,00										
	08IR 1,25 ISO	08IL 1,50 ISO	8,2	4,76	60°	1,25										
	08IR 1,50 ISO	08IL 1,75 ISO	8,2	4,76	60°	1,50										
 ..U ..	08IR 1,75 ISO	08IL 1,25 ISO	8,2	4,76	60°	1,75										
	08U IR 2,00 ISO	08U IL 2,00 ISO	8,2U	4,76U	60°	2,00										
	11IR 0,35 ISO	11IL 0,35 ISO	11	6,35	60°	0,35										
	11IR 0,40 ISO	11IL 0,40 ISO	11	6,35	60°	0,40										
	11IR 0,45 ISO	11IL 0,45 ISO	11	6,35	60°	0,45										
	11IR 0,50 ISO	11IL 0,50 ISO	11	6,35	60°	0,50										
	11IR 0,60 ISO	11IL 0,60 ISO	11	6,35	60°	0,60										
	11IR 0,70 ISO	11IL 0,70 ISO	11	6,35	60°	0,70										
	11IR 0,75 ISO	11IL 0,75 ISO	11	6,35	60°	0,75										
	11IR 0,80 ISO	11IL 0,80 ISO	11	6,35	60°	0,80										
	11IR 1,00 ISO	11IL 1,00 ISO	11	6,35	60°	1,00										
	11IR 1,25 ISO	11IL 1,25 ISO	11	6,35	60°	1,25										
	11IR 1,50 ISO	11IL 1,50 ISO	11	6,35	60°	1,50										
	11IR 1,75 ISO	11IL 1,75 ISO	11	6,35	60°	1,75										
	11IR 2,00 ISO	11IL 2,00 ISO	11	6,35	60°	2,00										
	11IR 2,50 ISO	11IL 2,50 ISO	11	6,35	60°	2,50										
		16IR 0,35 ISO	16IL 0,35 ISO	16,5	9,52	60°	0,35									
		16IR 0,40 ISO	16IL 0,40 ISO	16,5	9,52	60°	0,40									
16IR 0,45 ISO		16IL 0,45 ISO	16,5	9,52	60°	0,45										
16IR 0,50 ISO		16IL 0,50 ISO	16,5	9,52	60°	0,50										
16IR 0,60 ISO		16IL 0,60 ISO	16,5	9,52	60°	0,60										
16IR 0,70 ISO		16IL 0,70 ISO	16,5	9,52	60°	0,70										
16IR 0,75 ISO		16IL 0,75 ISO	16,5	9,52	60°	0,75										
16IR 0,80 ISO		16IL 0,80 ISO	16,5	9,52	60°	0,80										
16IR 1,00 ISO		16IL 1,00 ISO	16,5	9,52	60°	1,00										
16IR 1,25 ISO		16IL 1,25 ISO	16,5	9,52	60°	1,25										
16IR 1,50 ISO		16IL 1,50 ISO	16,5	9,52	60°	1,50										
16IR 1,75 ISO		16IL 1,75 ISO	16,5	9,52	60°	1,75										
	16IR 2,00 ISO	16IL 2,00 ISO	16,5	9,52	60°	2,00										
	16IR 2,50 ISO	16IL 2,50 ISO	16,5	9,52	60°	2,50										
	16IR 3,00 ISO	16IL 3,00 ISO	16,5	9,52	60°	3,00										
	16IR 3,50 ISO	16IL 3,50 ISO	16,5	9,52	60°	3,50										
	22IR 3,50 ISO	22IL 3,50 ISO	22	12,7	60°	3,50										
	22IR 4,00 ISO	22IL 4,00 ISO	22	12,7	60°	4,00										
	22IR 4,50 ISO	22IL 4,50 ISO	22	12,7	60°	4,50										
	22IR 5,00 ISO	22IL 5,00 ISO	22	12,7	60°	5,00										
	22IR 5,50 ISO	22IL 5,50 ISO	22	12,7	60°	5,50										
	22IR 6,00 ISO	22IL 6,00 ISO	22	12,7	60°	6,00										
MATERIALE - MATERIAL - MATERIALIEN - MATÉRIAUX								F7030	F7030	F7415	F7415	F1025	F1025	F7040	F7040	
P	ACCIAIO - STEEL - STAHL - ACIER							●		○		●		●		
M	ACCIAIO INOX - STAINLESS STEEL - ROSTFREIER STAHL - ACIER INOXYDABLE							●		●				○		
K	GHISA - CAST IRON - GRAUGUSS - FONTE GRISE							●						●		
N	LEGHE DI ALLUMINIO - ALUMINIUM ALLOYS - ALUMINIUM-LEGIERUNGEN - ALLIAGES D'ALUMINIUM							○						●		
S	LEGHE RESISTENTI AL CALORE - HEAT RESISTANT ALLOYS - WÄRMEBESTÄNDIGE LEGIERUNGEN - ALLIAGES RÉSISSANTES À LA CHALEUR							●						○		
H	MATERIALI DURI E TEMPRATI - HARD AND HARDENED MATERIAL - HARTE UND GEHÄRTETE MATERIALIEN - MATERIAUX DURS ET TREMPÉS							○						○		

● DISPONIBILI - IN STOCK - LIEFERBAR - DISPONIBLES / ■ NEW
 ○ APPLICAZIONE CONSIGLIATA-RECOMMENDED APPLICATION-
 EMPFOHLENER EINSATZ - APPLICATION CONSEILLÉE

□ A RICHIESTA - ON REQUEST - AUF ANFRAGE - SUR DEMANDE / □ NEW
 ○ APPLICAZIONE POSSIBILE - POSSIBLE APPLICATION -
 MÖGLICHE ANWENDUNG - APPLICATION POSSIBLE

...ER B ... ISO		...IR B ... ISO		HW		HC											
				NON RIVESTITI CEMENTED CARBIDE GRADES		RIVESTITI COATED GRADES BESCHICHTET RECOUVERTS											
ART.	COD.			l	d	b	P(mm)	F7030									

PROFILO DI PRECISIONE RETTIFICATO CON ROMPIRUCIOLO SINTERIZZATO b = 60° (ISO)
PRECISION GROUND PROFILE WITH SINTERED CHIP-BREAKER b = 60° (ISO)

 ..ER ..	16ER B 0,80 ISO	16,5	9,52	60°	0,80																			
	16ER B 1,00 ISO	16,5	9,52	60°	1,00																			
	16ER B 1,25 ISO	16,5	9,52	60°	1,25																			
	16ER B 1,50 ISO	16,5	9,52	60°	1,50																			
	16ER B 1,75 ISO	16,5	9,52	60°	1,75																			
	16ER B 2,00 ISO	16,5	9,52	60°	2,00																			
	16ER B 2,50 ISO	16,5	9,52	60°	2,50																			
	16ER B 3,00 ISO	16,5	9,52	60°	3,00																			

SET 16ER B 1020 ISO F7030

Contenuto del kit / Content of the kit:

- n°2 16ER B 1,00 ISO F7030
- n°2 16ER B 1,25 ISO F7030
- n°2 16ER B 1,50 ISO F7030
- n°2 16ER B 1,75 ISO F7030
- n°2 16ER B 2,00 ISO F7030

NEW

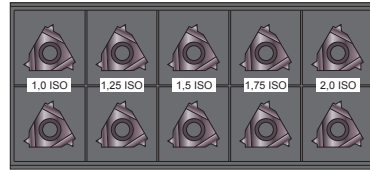

 ..IR ..	16IR B 1,00 ISO	16,5	9,52	60°	1,00																				
	16IR B 1,25 ISO	16,5	9,52	60°	1,25																				
	16IR B 1,50 ISO	16,5	9,52	60°	1,50																				
	16IR B 1,75 ISO	16,5	9,52	60°	1,75																				
	16IR B 2,00 ISO	16,5	9,52	60°	2,00																				
	16IR B 3,00 ISO	16,5	9,52	60°	3,00																				

SET 16IR B 1020 ISO F7030

Contenuto del kit / Content of the kit:

- n°2 16IR B 1,00 ISO F7030
- n°2 16IR B 1,25 ISO F7030
- n°2 16IR B 1,50 ISO F7030
- n°2 16IR B 1,75 ISO F7030
- n°2 16IR B 2,00 ISO F7030

NEW

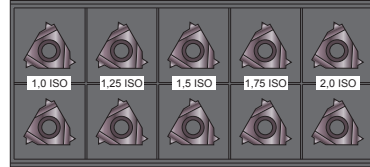

MATERIALE - MATERIAL - MATERIALIEN - MATÉRIAUX																								
--	--	--	--	--	--	--	--	--	--	--	--	--	--	--	--	--	--	--	--	--	--	--	--	--

P	ACCIAIO - STEEL - STAHL - ACIER																							
M	ACCIAIO INOX - STAINLESS STEEL - ROSTFREIER STAHL - ACIER INOXYDABLE																							
K	GHISA - CAST IRON - GRAUGUSS - FONTE GRISE																							
N	LEGHE DI ALLUMINIO - ALUMINIUM ALLOYS - ALUMINIUM-LEGIERUNGEN - ALLIAGES D'ALUMINIUM																							
S	LEGHE RESISTENTI AL CALORE - HEAT RESISTANT ALLOYS - WÄRMEBESTÄNDIGE LEGIERUNGEN - ALLIAGES RÉSISSANTES À LA CHALEUR																							
H	MATERIALI DURI E TEMPRATI - HARD AND HARDENED MATERIAL - HARTE UND GEHÄRTETE MATERIALIEN - MATERIAUX DURS ET TREMPÉS																							

...ER ... ISO ..M		... IR ... ISO ..M		HW							HC											
				NON RIVESTITI CEMENTED CARBIDE GRADES							RIVESTITI COATED GRADES BESCHICHTET RECOUVERTS											
ART.	COD.			l	d	b	Z	P (mm)	F7030							F1025						
PROFILO FINITO b = 60° (ISO) MULTIDENTE FULL - PROFILE b = 60° (ISO) MULTITOOTH																						
 ..ER ..	16ER 1,00 ISO 3M	16,5	9,52	60°	3	1,00											<input type="checkbox"/>					
	16ER 1,50 ISO 2M	16,5	9,52	60°	2	1,50											<input type="checkbox"/>					
	22ER 1,50 ISO 3M	22	12,7	60°	3	1,50											<input type="checkbox"/>					
	22ER 2,00 ISO 2M	22	12,7	60°	2	2,00											<input type="checkbox"/>					
	22ER 2,00 ISO 3M	22	12,7	60°	3	2,00											<input type="checkbox"/>					
	 ..IR ..	16IR 1,00 ISO 3M	16,5	9,52	60°	3	1,00											<input type="checkbox"/>				
16IR 1,50 ISO 2M		16,5	9,52	60°	2	1,50											<input type="checkbox"/>					
22IR 1,50 ISO 3M		22	12,7	60°	3	1,50											<input type="checkbox"/>					
22IR 2,00 ISO 2M		22	12,7	60°	2	2,00											<input type="checkbox"/>					
22IR 2,00 ISO 3M		22	12,7	60°	3	2,00											<input type="checkbox"/>					
MATERIALE - MATERIAL - MATERIALIEN - MATÉRIAUX								F7030							F1025							
P	ACCIAIO - STEEL - STAHL - ACIER																		<input checked="" type="checkbox"/>			
M	ACCIAIO INOX - STAINLESS STEEL - ROSTFREIER STAHL - ACIER INOXYDABLE																	<input checked="" type="checkbox"/>				
K	GHISA - CAST IRON - GRAUGUSS - FONTE GRISE																	<input checked="" type="checkbox"/>				
N	LEGHE DI ALLUMINIO - ALUMINIUM ALLOYS - ALUMINIUM-LEGIERUNGEN - ALLIAGES D'ALUMINIUM																	<input type="checkbox"/>				
S	LEGHE RESISTENTI AL CALORE - HEAT RESISTANT ALLOYS - WÄRMEBESTÄNDIGE LEGIERUNGEN - ALLIAGES RÉSISSANTES À LA CHALEUR																	<input checked="" type="checkbox"/>				
H	MATERIALI DURI E TEMPRATI - HARD AND HARDENED MATERIAL - HARTE UND GEHÄRTETE MATERIALIEN - MATERIAUX DURS ET TREMPÉS																	<input type="checkbox"/>				

■ DISPONIBILI - IN STOCK - LIEFERBAR - DISPONIBLES / ■ NEW
● APPLICAZIONE CONSIGLIATA-RECOMMENDED APPLICATION- EMPFOHLENER EINSATZ - APPLICATION CONSEILLÉE

□ A RICHIESTA - ON REQUEST - AUF ANFRAGE - SUR DEMANDE / □ NEW
○ APPLICAZIONE POSSIBILE - POSSIBLE APPLICATION - MÖGLICHE ANWENDUNG - APPLICATION POSSIBLE

...ER ... UN		...EL ... UN		HW		HC										
				NON RIVESTITI CEMENTED CARBIDE GRADES		RIVESTITI COATED GRADES BESCHICHTET RECOUVERTS										
ART.	COD.			l	d	b	P (Fill/μ)	R	L	R	L					
UNIFICATO b = 60° UN UNIFIED b = 60° UN																
	11ER 72 UN	11EL 72 UN	11	6,35	60°	72										
	11ER 64 UN	11EL 64 UN	11	6,35	60°	64										
	11ER 56 UN	11EL 56 UN	11	6,35	60°	56										
	11ER 48 UN	11EL 48 UN	11	6,35	60°	48										
	11ER 44 UN	11EL 44 UN	11	6,35	60°	44										
	11ER 40 UN	11EL 40 UN	11	6,35	60°	40										
	11ER 36 UN	11EL 36 UN	11	6,35	60°	36										
	11ER 32 UN	11EL 32 UN	11	6,35	60°	32										
	11ER 28 UN	11EL 28 UN	11	6,35	60°	28										
	11ER 27 UN	11EL 27 UN	11	6,35	60°	27										
	11ER 24 UN	11EL 24 UN	11	6,35	60°	24										
	11ER 20 UN	11EL 20 UN	11	6,35	60°	20										
	11ER 18 UN	11EL 18 UN	11	6,35	60°	18										
	11ER 16 UN	11EL 16 UN	11	6,35	60°	16										
	11ER 14 UN	11EL 14 UN	11	6,35	60°	14										
	16ER 72 UN	16EL 72 UN	16,5	9,52	60°	72										
	16ER 64 UN	16EL 64 UN	16,5	9,52	60°	64										
	16ER 56 UN	16EL 56 UN	16,5	9,52	60°	56										
	16ER 48 UN	16EL 48 UN	16,5	9,52	60°	48										
	16ER 44 UN	16EL 44 UN	16,5	9,52	60°	44										
	16ER 40 UN	16EL 40 UN	16,5	9,52	60°	40										
	16ER 36 UN	16EL 36 UN	16,5	9,52	60°	36										
	16ER 32 UN	16EL 32 UN	16,5	9,52	60°	32										
	16ER 28 UN	16EL 28 UN	16,5	9,52	60°	28										
	16ER 27 UN	16EL 27 UN	16,5	9,52	60°	27										
	16ER 24 UN	16EL 24 UN	16,5	9,52	60°	24										
	16ER 20 UN	16EL 20 UN	16,5	9,52	60°	20										
	16ER 18 UN	16EL 18 UN	16,5	9,52	60°	18										
	16ER 16 UN	16EL 16 UN	16,5	9,52	60°	16										
	16ER 14 UN	16EL 14 UN	16,5	9,52	60°	14										
	16ER 13 UN	16EL 13 UN	16,5	9,52	60°	13										
	16ER 12 UN	16EL 12 UN	16,5	9,52	60°	12										
	16ER 11,5 UN	16EL 11,5 UN	16,5	9,52	60°	11,5										
	16ER 11 UN	16EL 11 UN	16,5	9,52	60°	11										
	16ER 10 UN	16EL 10 UN	16,5	9,52	60°	10										
	16ER 9 UN	16EL 9 UN	16,5	9,52	60°	9										
	16ER 8 UN	16EL 8 UN	16,5	9,52	60°	8										
	22ER 7 UN	22EL 7 UN	22	12,7	60°	7										
	22ER 6 UN	22EL 6 UN	22	12,7	60°	6										
	22ER 5 UN	22EL 5 UN	22	12,7	60°	5										
MATERIALE - MATERIAL - MATERIALIEN - MATÉRIAUX																
P	ACCIAIO - STEEL - STAHL - ACIER															
M	ACCIAIO INOX - STAINLESS STEEL - ROSTFREIER STAHL - ACIER INOXYDABLE															
K	GHISA - CAST IRON - GRAUGUSS - FONTE GRISE															
N	LEGHE DI ALLUMINIO - ALUMINIUM ALLOYS - ALUMINIUM-LEGIERUNGEN - ALLIAGES D'ALUMINIUM															
S	LEGHE RESISTENTI AL CALORE - HEAT RESISTANT ALLOYS - WÄRMEBESTÄNDIGE LEGIERUNGEN - ALLIAGES RÉSISTANTES À LA CHALEUR															
H	MATERIALI DURI E TEMPRATI - HARD AND HARDENED MATERIAL - HARTE UND GEHÄRTETE MATERIALIEN - MATERIAUX DURS ET TREMPÉS															

						HW		HC					
						NON RIVESTITI CEMENTED CARBIDE GRADES		RIVESTITI COATED GRADES BESCHICHTET RECOUVERTS					
..IR .. UN		..IL .. UN		..U .. UN		R	L	R	L	R	L		
ART.	COD.		l	d	b	P (Fill")	F7030	F7030	F1025	F1025	F7040	F7040	
UNIFICATO b = 60° UN UNIFIED b = 60° UN													
..IR ..	06IR 32 UN	06IL 32 UN	6,9	3,97	60°	32							
	06IR 28 UN	06IL 28 UN	6,9	3,97	60°	28							
	06IR 24 UN	06IL 24 UN	6,9	3,97	60°	24							
	06IR 20 UN	06IL 20 UN	6,9	3,97	60°	20							
	06IR 18 UN	06IL 18 UN	6,9	3,97	60°	18							
..IL ..	08IR 32 UN	08IL 32 UN	8,2	4,76	60°	32							
	08IR 28 UN	08IL 28 UN	8,2	4,76	60°	28							
	08IR 24 UN	08IL 24 UN	8,2	4,76	60°	24							
	08IR 20 UN	08IL 20 UN	8,2	4,76	60°	20							
	08IR 18 UN	08IL 18 UN	8,2	4,76	60°	18							
	08IR 16 UN	08IL 16 UN	8,2	4,76	60°	16							
	08IR 14 UN	08IL 14 UN	8,2	4,76	60°	14							
..U ..	08U IR 13 UN	08U IL 13 UN	8,2U	4,76U	60°	13							
	08U IR 12 UN	08U IL 12 UN	8,2U	4,76U	60°	12							
	08U IR 11 UN	08U IL 11 UN	8,2U	4,76U	60°	11							
	11IR 72 UN	11IL 72 UN	11	6,35	60°	72							
	11IR 64 UN	11IL 64 UN	11	6,35	60°	64							
	11IR 56 UN	11IL 56 UN	11	6,35	60°	56							
	11IR 48 UN	11IL 48 UN	11	6,35	60°	48							
	11IR 44 UN	11IL 44 UN	11	6,35	60°	44							
	11IR 40 UN	11IL 40 UN	11	6,35	60°	40							
	11IR 36 UN	11IL 36 UN	11	6,35	60°	36							
	11IR 32 UN	11IL 32 UN	11	6,35	60°	32							
	11IR 28 UN	11IL 28 UN	11	6,35	60°	28							
	11IR 27 UN	11IL 27 UN	11	6,35	60°	27							
	11IR 24 UN	11IL 24 UN	11	6,35	60°	24							
	11IR 20 UN	11IL 20 UN	11	6,35	60°	20							
	11IR 18 UN	11IL 18 UN	11	6,35	60°	18							
	11IR 16 UN	11IL 16 UN	11	6,35	60°	16							
	11IR 14 UN	11IL 14 UN	11	6,35	60°	14							
	11IR 13 UN	11IL 13 UN	11	6,35	60°	13							
	11IR 12 UN	11IL 12 UN	11	6,35	60°	12							
	11IR 11 UN	11IL 11 UN	11	6,35	60°	11							
	16IR 72 UN	16IL 72 UN	16,5	9,52	60°	72							
	16IR 64 UN	16IL 64 UN	16,5	9,52	60°	64							
	16IR 56 UN	16IL 56 UN	16,5	9,52	60°	56							
	16IR 48 UN	16IL 48 UN	16,5	9,52	60°	48							
	16IR 44 UN	16IL 44 UN	16,5	9,52	60°	44							
	16IR 40 UN	16IL 40 UN	16,5	9,52	60°	40							
	16IR 36 UN	16IL 36 UN	16,5	9,52	60°	36							
	16IR 32 UN	16IL 32 UN	16,5	9,52	60°	32							
	16IR 28 UN	16IL 28 UN	16,5	9,52	60°	28							
	16IR 27 UN	16IL 27 UN	16,5	9,52	60°	27							
	16IR 24 UN	16IL 24 UN	16,5	9,52	60°	24							
	16IR 20 UN	16IL 20 UN	16,5	9,52	60°	20							
	16IR 18 UN	16IL 18 UN	16,5	9,52	60°	18							
	16IR 16 UN	16IL 16 UN	16,5	9,52	60°	16							
	16IR 14 UN	16IL 14 UN	16,5	9,52	60°	14							
	16IR 13 UN	16IL 13 UN	16,5	9,52	60°	13							
	16IR 12 UN	16IL 12 UN	16,5	9,52	60°	12							
	16IR 11,5 UN	16IL 11,5 UN	16,5	9,52	60°	11,5							
	16IR 11 UN	16IL 11 UN	16,5	9,52	60°	11							
	16IR 10 UN	16IL 10 UN	16,5	9,52	60°	10							
	16IR 9 UN	16IL 9 UN	16,5	9,52	60°	9							
	16IR 8 UN	16IL 8 UN	16,5	9,52	60°	8							
	22IR 7 UN	22IL 7 UN	22	12,7	60°	7							
	22IR 6 UN	22IL 6 UN	22	12,7	60°	6							
	22IR 5 UN	22IL 5 UN	22	12,7	60°	5							
MATERIALE - MATERIAL - MATERIALIEN - MATÉRIAUX							R	L	R	L	R	L	
P	ACCIAIO - STEEL - STAHL - ACIER												
M	ACCIAIO INOX - STAINLESS STEEL - ROSTFREIER STAHL - ACIER INOXYDABLE												
K	GHISA - CAST IRON - GRAUGUSS - FONTE GRISE												
N	LEGHE DI ALLUMINIO - ALUMINIUM ALLOYS - ALUMINIUM-LEGIERUNGEN - ALLIAGES D'ALUMINIUM												
S	LEGHE RESISTENTI AL CALORE - HEAT RESISTANT ALLOYS - WÄRMEBESTÄNDIGE LEGIERUNGEN - ALLIAGES RÉSISSANTES À LA CHALEUR												
H	MATERIALI DURI E TEMPRATI - HARD AND HARDENED MATERIAL - HARTE UND GEHÄRTETE MATERIALIEN - MATERIAUX DURS ET TREMPÉS												

...ER ... W		...EL ... W		HW				HC				
				NON RIVESTITI CEMENTED CARBIDE GRADES				RIVESTITI COATED GRADES BESCHICHTET RECOUVERTS				
				R		L		R		L		
ART.	COD.	l	d	b	P (Fill/°)	F7030	F7030	F7415	F7415	F1025	F1025	
PROFILO FINITO b = 55° (WITHWORTH) FULL - PROFILE b = 55° (WITHWORTH)												
	11ER 72 W	11EL 72 W	11	6,35	55°	72						
	11ER 60 W	11EL 60 W	11	6,35	55°	60						
	11ER 56 W	11EL 56 W	11	6,35	55°	56						
	11ER 48 W	11EL 48 W	11	6,35	55°	48						
	11ER 40 W	11EL 40 W	11	6,35	55°	40						
	11ER 36 W	11EL 36 W	11	6,35	55°	36						
	11ER 32 W	11EL 32 W	11	6,35	55°	32						
	11ER 28 W	11EL 28 W	11	6,35	55°	28						
	11ER 26 W	11EL 26 W	11	6,35	55°	26						
	11ER 24 W	11EL 24 W	11	6,35	55°	24						
	11ER 22 W	11EL 22 W	11	6,35	55°	22						
	11ER 20 W	11EL 20 W	11	6,35	55°	20						
	11ER 19 W	11EL 19 W	11	6,35	55°	19						
	11ER 18 W	11EL 18 W	11	6,35	55°	18						
	11ER 16 W	11EL 16 W	11	6,35	55°	16						
	11ER 14 W	11EL 14 W	11	6,35	55°	14						
	16ER 72 W	16EL 72 W	16,5	9,52	55°	72						
	16ER 60 W	16EL 60 W	16,5	9,52	55°	60						
	16ER 56 W	16EL 56 W	16,5	9,52	55°	56						
	16ER 48 W	16EL 48 W	16,5	9,52	55°	48						
16ER 40 W	16EL 40 W	16,5	9,52	55°	40							
16ER 36 W	16EL 36 W	16,5	9,52	55°	36							
16ER 32 W	16EL 32 W	16,5	9,52	55°	32							
16ER 28 W	16EL 28 W	16,5	9,52	55°	28							
16ER 26 W	16EL 26 W	16,5	9,52	55°	26							
16ER 24 W	16EL 24 W	16,5	9,52	55°	24							
16ER 22 W	16EL 22 W	16,5	9,52	55°	22							
16ER 20 W	16EL 20 W	16,5	9,52	55°	20							
16ER 19 W	16EL 19 W	16,5	9,52	55°	19							
16ER 18 W	16EL 18 W	16,5	9,52	55°	18							
16ER 16 W	16EL 16 W	16,5	9,52	55°	16							
16ER 14 W	16EL 14 W	16,5	9,52	55°	14							
16ER 12 W	16EL 12 W	16,5	9,52	55°	12							
16ER 11 W	16EL 11 W	16,5	9,52	55°	11							
16ER 10 W	16EL 10 W	16,5	9,52	55°	10							
16ER 9 W	16EL 9 W	16,5	9,52	55°	9							
16ER 8 W	16EL 8 W	16,5	9,52	55°	8							
22ER 7 W	22EL 7 W	22	12,7	55°	7							
22ER 6 W	22EL 6 W	22	12,7	55°	6							
22ER 5 W	22EL 5 W	22	12,7	55°	5							
MATERIALE - MATERIAL - MATERIALIEN - MATÉRIAUX												
P	ACCIAIO - STEEL - STAHL - ACIER											
M	ACCIAIO INOX - STAINLESS STEEL - ROSTFREIER STAHL - ACIER INOXYDABLE											
K	GHISA - CAST IRON - GRAUGUSS - FONTE GRISE											
N	LEGHE DI ALLUMINIO - ALUMINIUM ALLOYS - ALUMINIUM-LEGIERUNGEN - ALLIAGES D'ALUMINIUM											
S	LEGHE RESISTENTI AL CALORE - HEAT RESISTANT ALLOYS - WÄRMEBESTÄNDIGE LEGIERUNGEN - ALLIAGES RÉSISTANTES À LA CHALEUR											
H	MATERIALI DURI E TEMPRATI - HARD AND HARDENED MATERIAL - HARTE UND GEHÄRTETE MATERIALIEN - MATÉRIAUX DURS ET TREMPÉS											

● DISPONIBILI - IN STOCK - LIEFERBAR - DISPONIBLES / ■ NEW
● APPLICAZIONE CONSIGLIATA-RECOMMENDED APPLICATION-
EMPFOHLENER EINSATZ - APPLICATION CONSEILLÉE

□ A RICHIESTA - ON REQUEST - AUF ANFRAGE - SUR DEMANDE / □ NEW
□ APPLICAZIONE POSSIBILE - POSSIBLE APPLICATION -
MÖGLICHE ANWENDUNG - APPLICATION POSSIBLE

						HW		HC										
						NON RIVESTITI CEMENTED CARBIDE GRADES		RIVESTITI COATED GRADES BESCHICHTET RECOUVERTS										
...IR ... W		...IL ... W				...U ... W		R	L	R	L	R	L	R	L			
ART.		COD.				I	d	b	P (Fill ^m)	F7030	F7030	F7415	F7415	F1025	F1025	F7040	F7040	
PROFILO FINITO b = 55° (WITHWORTH) FULL - PROFILE b = 55° (WITHWORTH)																		
 ..IR..	06IR 26 W	06IL 26 W	6,9	3,97	55°	26												
	06IR 22 W	06IL 22 W	6,9	3,97	55°	22												
	06IR 20 W	06IL 20 W	6,9	3,97	55°	20												
	06IR 18 W	06IL 18 W	6,9	3,97	55°	18												
 ..IL..	08IR 28 W	08IL 28 W	8,2	4,76	55°	28												
	08IR 24 W	08IL 24 W	8,2	4,76	55°	24												
	08IR 20 W	08IL 20 W	8,2	4,76	55°	20												
	08IR 19 W	08IL 19 W	8,2	4,76	55°	19												
	08IR 18 W	08IL 18 W	8,2	4,76	55°	18												
 ..U..	08U IR 14 W	08U IL 14 W	8,2U	4,76U	55°	14												
	08U IR 12 W	08U IL 12 W	8,2U	4,76U	55°	12												
	08U IR 11 W	08U IL 11 W	8,2U	4,76U	55°	11												
	11IR 72 W	11IL 72 W	11	6,35	55°	72												
	11IR 60 W	11IL 60 W	11	6,35	55°	60												
	11IR 56 W	11IL 56 W	11	6,35	55°	56												
	11IR 48 W	11IL 48 W	11	6,35	55°	48												
	11IR 40 W	11IL 40 W	11	6,35	55°	40												
	11IR 36 W	11IL 36 W	11	6,35	55°	36												
	11IR 32 W	11IL 32 W	11	6,35	55°	32												
	11IR 28 W	11IL 28 W	11	6,35	55°	28												
	11IR 26 W	11IL 26 W	11	6,35	55°	26												
	11IR 24 W	11IL 24 W	11	6,35	55°	24												
	11IR 22 W	11IL 22 W	11	6,35	55°	22												
	11IR 20 W	11IL 20 W	11	6,35	55°	20												
	11IR 19 W	11IL 19 W	11	6,35	55°	19												
	11IR 18 W	11IL 18 W	11	6,35	55°	18												
	11IR 16 W	11IL 16 W	11	6,35	55°	16												
	11IR 14 W	11IL 14 W	11	6,35	55°	14												
	11IR 12 W	11IL 12 W	11	6,35	55°	12												
	11IR 11 W	11IL 11 W	11	6,35	55°	11												
	16IR 72 W	16IL 72 W	16,5	9,52	55°	72												
	16IR 60 W	16IL 60 W	16,5	9,52	55°	60												
	16IR 56 W	16IL 56 W	16,5	9,52	55°	56												
	16IR 48 W	16IL 48 W	16,5	9,52	55°	48												
	16IR 40 W	16IL 40 W	16,5	9,52	55°	40												
	16IR 36 W	16IL 36 W	16,5	9,52	55°	36												
	16IR 32 W	16IL 32 W	16,5	9,52	55°	32												
	16IR 28 W	16IL 28 W	16,5	9,52	55°	28												
	16IR 26 W	16IL 26 W	16,5	9,52	55°	26												
	16IR 24 W	16IL 24 W	16,5	9,52	55°	24												
	16IR 22 W	16IL 22 W	16,5	9,52	55°	22												
	16IR 20 W	16IL 20 W	16,5	9,52	55°	20												
	16IR 19 W	16IL 19 W	16,5	9,52	55°	19												
	16IR 18 W	16IL 18 W	16,5	9,52	55°	18												
	16IR 16 W	16IL 16 W	16,5	9,52	55°	16												
	16IR 14 W	16IL 14 W	16,5	9,52	55°	14												
	16IR 12 W	16IL 12 W	16,5	9,52	55°	12												
	16IR 11 W	16IL 11 W	16,5	9,52	55°	11												
	16IR 10 W	16IL 10 W	16,5	9,52	55°	10												
	16IR 9 W	16IL 9 W	16,5	9,52	55°	9												
	16IR 8 W	16IL 8 W	16,5	9,52	55°	8												
	22IR 7 W	22IL 7 W	22	12,7	55°	7												
	22IR 6 W	22IL 6 W	22	12,7	55°	6												
	22IR 5 W	22IL 5 W	22	12,7	55°	5												
MATERIALE - MATERIAL - MATERIALIEN - MATÉRIAUX																		
P	ACCIAIO - STEEL - STAHL - ACIER										F7030	F7030	F7415	F7415	F1025	F1025	F7040	F7040
M	ACCIAIO INOX - STAINLESS STEEL - ROSTFREIER STAHL - ACIER INOXYDABLE										●		○		●		○	
K	GHISA - CAST IRON - GRAUGUSS - FONTE GRISE										●						●	
N	LEGHE DI ALLUMINIO - ALUMINIUM ALLOYS - ALUMINIUM-LEGIERUNGEN - ALLIAGES D'ALUMINIUM										○						●	
S	LEGHE RESISTENTI AL CALORE - HEAT RESISTANT ALLOYS - WÄRMEBESTÄNDIGE LEGIERUNGEN - ALLIAGES RÉISTANTES À LA CHALEUR										●						○	
H	MATERIALI DURI E TEMPRATI - HARD AND HARDENED MATERIAL - HARTE UND GEHÄRTETE MATERIALIEN - MATERIAUX DURS ET TREMPÉS										○						○	

...ER B ... W		...IR B ... W		HW			HC															
					NON RIVESTITI CEMENTED CARBIDE GRADES			RIVESTITI COATED GRADES BESCHICHTET RECOUVERTS														
ART.	COD.			l	d	b	P (Fill/°)	F7030														
PROFILO DI PRECISIONE RETTIFICATO CON ROMPIRUCIOLO SINTERIZZATO b = 55° (WITHWORTH)													PRECISION GROUND PROFILE WITH SINTERED CHIP-BREAKER b = 55° (WITHWORTH)									
 ..ER ..	16ER B 19 W			16,5	9,52	55°	19	■														
	16ER B 16 W			16,5	9,52	55°	16	■														
	16ER B 14 W			16,5	9,52	55°	14	■														
	16ER B 11 W			16,5	9,52	55°	11	■														
	16ER B 10 W			16,5	9,52	55°	10	□														
 ..IR ..	16IR B 19 W			16,5	9,52	55°	19	■														
	16IR B 16 W			16,5	9,52	55°	16	■														
	16IR B 14 W			16,5	9,52	55°	14	■														
	16IR B 11 W			16,5	9,52	55°	11	■														
	16IR B 10 W			16,5	9,52	55°	10	□														
MATERIALE - MATERIAL - MATERIALIEN - MATÉRIAUX								F7030														
P	ACCIAIO - STEEL - STAHL - ACIER							●														
M	ACCIAIO INOX - STAINLESS STEEL - ROSTFREIER STAHL - ACIER INOXYDABLE							●														
K	GHISA - CAST IRON - GRAUGUSS - FONTE GRISE							●														
N	LEGHE DI ALLUMINIO - ALUMINIUM ALLOYS - ALUMINIUM-LEGIERUNGEN - ALLIAGES D'ALUMINIUM							○														
S	LEGHE RESISTENTI AL CALORE - HEAT RESISTANT ALLOYS - WÄRMEBESTÄNDIGE LEGIERUNGEN - ALLIAGES RÉISTANTES À LA CHALEUR							●														
H	MATERIALI DURI E TEMPRATI - HARD AND HARDENED MATERIAL - HARTE UND GEHÄRTETE MATERIALIEN - MATERIAUX DURS ET TREMPÉS							○														

■ DISPONIBILI - IN STOCK - LIEFERBAR - DISPONIBLES / ■ NEW
 ● APPLICAZIONE CONSIGLIATA-RECOMMENDED APPLICATION-
 EMPFOHLENER EINSATZ - APPLICATION CONSEILLÉE

□ A RICHIESTA - ON REQUEST - AUF ANFRAGE - SUR DEMANDE / □ NEW
 ○ APPLICAZIONE POSSIBILE - POSSIBLE APPLICATION -
 MÖGLICHE ANWENDUNG - APPLICATION POSSIBLE

...ER ... W ..M		...IR ... W ..M		HW				HC																						
				NON RIVESTITI CEMENTED CARBIDE GRADES				RIVESTITI COATED GRADES BESCHICHTET RECOUVERTS																						
ART.	COD.	l	d	b	Z	P (Fill/r)	F7030												F1025											
PROFILO FINITO b = 55° (WITHWORTH) MULTIDENTE FULL - PROFILE b = 55° (WITHWORTH) MULTITOOTH																														
 ..ER ..	16ER 14 W 2M	16,5	9,52	55°	2	14																								
	22ER 14 W 3M	22	12,7	55°	3	14																								
	22ER 11 W 2M	22	12,7	55°	2	11																								
 ..IR ..	16IR 14 W 2M	16,5	9,52	55°	2	14																								
	22IR 14 W 3M	22	12,7	55°	3	14																								
	22IR 11 W 2M	22	12,7	55°	2	11																								
MATERIALE - MATERIAL - MATERIALIEN - MATÉRIAUX							F7030												F1025											
P	ACCIAIO - STEEL - STAHL - ACIER						●												●											
M	ACCIAIO INOX - STAINLESS STEEL - ROSTFREIER STAHL - ACIER INOXYDABLE						●												●											
K	GHISA - CAST IRON - GRAUGUSS - FONTE GRISE						●												●											
N	LEGHE DI ALLUMINIO - ALUMINIUM ALLOYS - ALUMINIUM-LEGIERUNGEN - ALLIAGES D'ALUMINIUM						○												○											
S	LEGHE RESISTENTI AL CALORE - HEAT RESISTANT ALLOYS - WÄRMEBESTÄNDIGE LEGIERUNGEN - ALLIAGES RÉSISSANTES À LA CHALEUR						●												●											
H	MATERIALI DURI E TEMPRATI - HARD AND HARDENED MATERIAL - HARTE UND GEHÄRTETE MATERIALIEN - MATERIAUX DURS ET TREMPÉS						○												○											

...ER ... NPT ...IL ... NPT		...EL ... NPT ...IR ... NPT		HW				HC									
				NON RIVESTITI CEMENTED CARBIDE GRADES				RIVESTITI COATED GRADES BESCHICHTET RECOUVERTS									
ART.	COD.	l	d	b	P (Fill")	R		L		R		L		R		L	
						F7030	F7030	F7030	F7030	F1025	F1025	F7040	F7040	F1025	F1025	F7040	F7040
NPT b = 60°																	
	11ER 27 NPT	11EL 27 NPT	11	6,35	60°	27											
	11ER 18 NPT	11EL 18 NPT	11	6,35	60°	18											
	11ER 14 NPT	11EL 14 NPT	11	6,35	60°	14											
	16ER 27 NPT	16EL 27 NPT	16,5	9,52	60°	27											
	16ER 18 NPT	16EL 18 NPT	16,5	9,52	60°	18											
	16ER 14 NPT	16EL 14 NPT	16,5	9,52	60°	14											
	16ER 11.5 NPT	16EL 11.5 NPT	16,5	9,52	60°	11,5											
	16ER 8 NPT	16EL 8 NPT	16,5	9,52	60°	8											
	06IR 27 NPT	06IL 27 NPT	6,9	3,97	60°	27											
	08IR 27 NPT	08IL 27 NPT	8,2	4,76	60°	27											
	08IR 18 NPT	08IL 18 NPT	8,2	4,76	60°	18											
	11IR 27 NPT	11IL 27 NPT	11	6,35	60°	27											
	11IR 18 NPT	11IL 18 NPT	11	6,35	60°	18											
	11IR 14 NPT	11IL 14 NPT	11	6,35	60°	14											
	16IR 27 NPT	16IL 27 NPT	16,5	9,52	60°	27											
	16IR 18 NPT	16IL 18 NPT	16,5	9,52	60°	18											
	16IR 14 NPT	16IL 14 NPT	16,5	9,52	60°	14											
	16IR 11.5 NPT	16IL 11.5 NPT	16,5	9,52	60°	11,5											
	16IR 8 NPT	16IL 8 NPT	16,5	9,52	60°	8											
MATERIALE - MATERIAL - MATERIALIEN - MATÉRIAUX																	
P	ACCIAIO - STEEL - STAHL - ACIER																
M	ACCIAIO INOX - STAINLESS STEEL - ROSTFREIER STAHL - ACIER INOXYDABLE																
K	GHISA - CAST IRON - GRAUGUSS - FONTE GRISE																
N	LEGHE DI ALLUMINIO - ALUMINIUM ALLOYS - ALUMINIUM-LEGIERUNGEN - ALLIAGES D'ALUMINIUM																
S	LEGHE RESISTENTI AL CALORE - HEAT RESISTANT ALLOYS - WÄRMEBESTÄNDIGE LEGIERUNGEN - ALLIAGES RÉSISTANTES À LA CHALEUR																
H	MATERIALI DURI E TEMPRATI - HARD AND HARDENED MATERIAL - HARTE UND GEHÄRTETE MATERIALIEN - MATERIAUX DURS ET TREMPÉS																

■ DISPONIBILI - IN STOCK - LIEFERBAR - DISPONIBLES / ■ NEW
● APPLICAZIONE CONSIGLIATA-RECOMMENDED APPLICATION-
EMPFOHLENER EINSATZ - APPLICATION CONSEILLÉE

□ A RICHIESTA - ON REQUEST - AUF ANFRAGE - SUR DEMANDE / □ NEW
○ APPLICAZIONE POSSIBILE - POSSIBLE APPLICATION -
MÖGLICHE ANWENDUNG - APPLICATION POSSIBLE

...ER B ... NPT		...IR B ... NPT		HW		HC											
				NON RIVESTITI CEMENTED CARBIDE GRADES		RIVESTITI COATED GRADES BESCHICHTET RECOUVERTS											

ART.	COD.	l	d	b	P (Fill/μ)	F7030											
------	------	---	---	---	---------------	-------	--	--	--	--	--	--	--	--	--	--	--

PROFILO DI PRECISIONE RETTIFICATO CON ROMPIRUCIOLO SINTERIZZATO NPT b = 60°
PRECISION GROUND PROFILE WITH SINTERED CHIP-BREAKER NPT b = 60°

 ..ER ..	16ER B 18 NPT	16,5	9,52	60°	18																	
	16ER B 14 NPT	16,5	9,52	60°	14																	
	16ER B 11.5 NPT	16,5	9,52	60°	11,5																	
	16ER B 8 NPT	16,5	9,52	60°	8																	
	 ..IR ..	16IR B 18 NPT	16,5	9,52	60°	18																
		16IR B 14 NPT	16,5	9,52	60°	14																
		16IR B 11.5 NPT	16,5	9,52	60°	11,5																
16IR B 8 NPT		16,5	9,52	60°	8																	

MATERIALE - MATERIAL - MATERIALIEN - MATÉRIAUX						F7030													
--	--	--	--	--	--	-------	--	--	--	--	--	--	--	--	--	--	--	--	--

P	ACCIAIO - STEEL - STAHL - ACIER																				
M	ACCIAIO INOX - STAINLESS STEEL - ROSTFREIER STAHL - ACIER INOXYDABLE																				
K	GHISA - CAST IRON - GRAUGUSS - FONTE GRISE																				
N	LEGHE DI ALLUMINIO - ALUMINIUM ALLOYS - ALUMINIUM-LEGIERUNGEN - ALLIAGES D'ALUMINIUM																				
S	LEGHE RESISTENTI AL CALORE - HEAT RESISTANT ALLOYS - WÄRMEBESTÄNDIGE LEGIERUNGEN - ALLIAGES RÉSISSANTES À LA CHALEUR																				
H	MATERIALI DURI E TEMPRATI - HARD AND HARDENED MATERIAL - HARTE UND GEHÄRTETE MATERIALIEN - MATERIAUX DURS ET TREMPÉS																				

...ER ... NPT ...M		...IR ... NPT ...M		HW		HC		
				NON RIVESTITI CEMENTED CARBIDE GRADES		RIVESTITI COATED GRADES BESCHICHTET RECOUVERTS		
ART.	COD.	l	d	b	Z	P (Fill ^m)	F7030	F1025
NPT b = 60° MULTIDENTE NPT b = 60° MULTITOOTH								
 ..ER ..	22ER 11.5 NPT 2M	22	12,7	60°	2	11,5	<input type="checkbox"/>	<input type="checkbox"/>
 ..IR ..	22IR 11.5 NPT 2M	22	12,7	60°	2	11,5	<input type="checkbox"/>	<input type="checkbox"/>
MATERIALE - MATERIAL - MATERIALIEN - MATÉRIAUX							F7030	F1025
P	ACCIAIO - STEEL - STAHL - ACIER						●	●
M	ACCIAIO INOX - STAINLESS STEEL - ROSTFREIER STAHL - ACIER INOXYDABLE						●	
K	GHISA - CAST IRON - GRAUGUSS - FONTE GRISE						●	
N	LEGHE DI ALLUMINIO - ALUMINIUM ALLOYS - ALUMINIUM-LEGIERUNGEN - ALLIAGES D'ALUMINIUM						○	
S	LEGHE RESISTENTI AL CALORE - HEAT RESISTANT ALLOYS - WÄRMEBESTÄNDIGE LEGIERUNGEN - ALLIAGES RÉSISTANTES À LA CHALEUR						●	
H	MATERIALI DURI E TEMPRATI - HARD AND HARDENED MATERIAL - HARTE UND GEHÄRTETE MATERIALIEN - MATERIAUX DURS ET TREMPÉS						○	

...ER ... BSPT ...IL ... BSPT		...EL ... BSPT ...IR ... BSPT		HW		HC										
				NON RIVESTITI CEMENTED CARBIDE GRADES		RIVESTITI COATED GRADES BESCHICHTET RECOUVERTS										
ART.		COD.		l	d	b	P (Fill/μ)	R	L	R	L	R	L	R	L	
BSPT b = 55°																
 	16ER 28 BSPT	16EL 28 BSPT	16,5	9,52	55°	28										
	16ER 19 BSPT	16EL 19 BSPT	16,5	9,52	55°	19										
	16ER 14 BSPT	16EL 14 BSPT	16,5	9,52	55°	14										
	16ER 11 BSPT	16EL 11 BSPT	16,5	9,52	55°	11										
	06IR 28 BSPT	06IL 28 BSPT	6,9	3,97	55°	28										
	08IR 28 BSPT	08IL 28 BSPT	8,2	4,76	55°	28										
	08IR 19 BSPT	08IL 19 BSPT	8,2	4,76	55°	19										
	11IR 28 BSPT	11IL 28 BSPT	11	6,35	55°	28										
	11IR 19 BSPT	11IL 19 BSPT	11	6,35	55°	19										
	11IR 14 BSPT	11IL 14 BSPT	11	6,35	55°	14										
	11IR 11 BSPT	11IL 11 BSPT	11	6,35	55°	11										
	16IR 28 BSPT	16IL 28 BSPT	16,5	9,52	55°	28										
	16IR 19 BSPT	16IL 19 BSPT	16,5	9,52	55°	19										
	16IR 14 BSPT	16IL 14 BSPT	16,5	9,52	55°	14										
	16IR 11 BSPT	16IL 11 BSPT	16,5	9,52	55°	11										
	MATERIALE - MATERIAL - MATERIALIEN - MATÉRIAUX								R	L			R	L	R	L
P	ACCIAIO - STEEL - STAHL - ACIER															
M	ACCIAIO INOX - STAINLESS STEEL - ROSTFREIER STAHL - ACIER INOXYDABLE															
K	GHISA - CAST IRON - GRAUGUSS - FONTE GRISE															
N	LEGHE DI ALLUMINIO - ALUMINIUM ALLOYS - ALUMINIUM-LEGIERUNGEN - ALLIAGES D'ALUMINIUM															
S	LEGHE RESISTENTI AL CALORE - HEAT RESISTANT ALLOYS - WÄRMEBESTÄNDIGE LEGIERUNGEN - ALLIAGES RÉSISTANTES À LA CHALEUR															
H	MATERIALI DURI E TEMPRATI - HARD AND HARDENED MATERIAL - HARTE UND GEHÄRTETE MATERIALIEN - MATERIAUX DURS ET TREMPÉS															

...ER B ... BSPT		...IR B ... BSPT		HW		HC																
				NON RIVESTITI CEMENTED CARBIDE GRADES		RIVESTITI COATED GRADES BESCHICHTET RECOUVERTS																
ART.	COD.			l	d	b	P (FIII")	F7030														
PROFILO DI PRECISIONE RETTIFICATO CON ROMPIRUCIOLO SINTERIZZATO BSPT b = 55° PRECISION GROUND PROFILE WITH SINTERED CHIP-BREAKER BSPT b = 55°																						
 ..ER ..	16ER B 19 BSPT			16,5	9,52	55°	19															
	16ER B 14 BSPT			16,5	9,52	55°	14															
	16ER B 11 BSPT			16,5	9,52	55°	11															
 ..IR ..	16IR B 14 BSPT			16,5	9,52	55°	14															
	16IR B 11 BSPT			16,5	9,52	55°	11															
MATERIALE - MATERIAL - MATERIALIEN - MATÉRIAUX								F7030														
P	ACCIAIO - STEEL - STAHL - ACIER							●														
M	ACCIAIO INOX - STAINLESS STEEL - ROSTFREIER STAHL - ACIER INOXYDABLE							●														
K	GHISA - CAST IRON - GRAUGUSS - FONTE GRISE							●														
N	LEGHE DI ALLUMINIO - ALUMINIUM ALLOYS - ALUMINIUM-LEGIERUNGEN - ALLIAGES D'ALUMINIUM							○														
S	LEGHE RESISTENTI AL CALORE - HEAT RESISTANT ALLOYS - WÄRMEBESTÄNDIGE LEGIERUNGEN - ALLIAGES RÉSISSANTES À LA CHALEUR							●														
H	MATERIALI DURI E TEMPRATI - HARD AND HARDENED MATERIAL - HARTE UND GEHÄRTETE MATERIALIEN - MATERIAUX DURS ET TREMPÉS							○														

■ DISPONIBILI - IN STOCK - LIEFERBAR - DISPONIBLES / ■ NEW
 ● APPLICAZIONE CONSIGLIATA-RECOMMENDED APPLICATION-
 EMPFOHLENER EINSATZ - APPLICATION CONSEILLÉE

□ A RICHIESTA - ON REQUEST - AUF ANFRAGE - SUR DEMANDE / □ NEW
 ○ APPLICAZIONE POSSIBILE - POSSIBLE APPLICATION -
 MÖGLICHE ANWENDUNG - APPLICATION POSSIBLE

			HW NON RIVESTITI CEMENTED CARBIDE GRADES		HC RIVESTITI COATED GRADES BESCHICHTET RECOUVERTS						
...ER ... TR / ...IL ... TR	...EL ... TR / ...IR ... TR	...U ... TR	R	L	R	L	R	L			
ART.	COD.	l	d	b	P(mm)	F7030	F7030	F1025	F1025	F7040	F7040

TRAPEZOIDALE b = 30°
TRAPEZ b = 30°

<p>..ER..</p> <p>..EL..</p> <p>..IR..</p> <p>..IL..</p> <p>..U..</p>	16ER 1.5 TR	16EL 1,50 TR	16,5	9,52	30°	1,50																	
	16ER 2 TR	16EL 2 TR	16,5	9,52	30°	2,00																	
	16ER 3 TR	16EL 3 TR	16,5	9,52	30°	3,00																	
	16ER 4 TR	16EL 4 TR	16,5	9,52	30°	4,00																	
	22ER 4 TR	22EL 4 TR	22	12,7	30°	4,00																	
	22ER 5 TR	22EL 5 TR	22	12,7	30°	5,00																	
	22ER 6 TR	22EL 6 TR	22	12,7	30°	6,00																	
	08IR 1.5 TR	08IL 1.5 TR	8,2	4,76	30°	1,50																	
	08U IR 2 TR	08U IL 2 TR	8,2U	4,76U	30°	2,00																	
	16IR 2 TR	16IL 2 TR	16,5	9,52	30°	2,00																	
	16IR 3 TR	16IL 3 TR	16,5	9,52	30°	3,00																	
	16IR 4 TR	16IL 4 TR	16,5	9,52	30°	4,00																	
	22IR 4 TR	22IL 4 TR	22	12,7	30°	4,00																	
	22IR 5 TR	22IL 5 TR	22	12,7	30°	5,00																	
	22IR 6 TR	22IL 6 TR	22	12,7	30°	6,00																	

MATERIALE - MATERIAL - MATERIALIEN - MATÉRIAUX																							

P	ACCIAIO - STEEL - STAHL - ACIER																					
M	ACCIAIO INOX - STAINLESS STEEL - ROSTFREIER STAHL - ACIER INOXYDABLE																					
K	GHISA - CAST IRON - GRAUGUSS - FONTE GRISE																					
N	LEGHE DI ALLUMINIO - ALUMINIUM ALLOYS - ALUMINIUM-LEGIERUNGEN - ALLIAGES D'ALUMINIUM																					
S	LEGHE RESISTENTI AL CALORE - HEAT RESISTANT ALLOYS - WÄRMEBESTÄNDIGE LEGIERUNGEN - ALLIAGES RÉSISTANTES À LA CHALEUR																					
H	MATERIALI DURI E TEMPRATI - HARD AND HARDENED MATERIAL - HARTE UND GEHÄRTETE MATERIALIEN - MATERIAUX DURS ET TREMPÉS																					

■ DISPONIBILI - IN STOCK - LIEFERBAR - DISPONIBLES / ■ NEW
 ● APPLICAZIONE CONSIGLIATA-RECOMMENDED APPLICATION-
 EMPFOHLENER EINSATZ - APPLICATION CONSEILLÉE

□ A RICHIESTA - ON REQUEST - AUF ANFRAGE - SUR DEMANDE / □ NEW
 ○ APPLICAZIONE POSSIBILE - POSSIBLE APPLICATION -
 MÖGLICHE ANWENDUNG - APPLICATION POSSIBLE

...ER ... RD ...IL ... RD		...EL ... RD ...IR ... RD		HW				HC					
				NON RIVESTITI CEMENTED CARBIDE GRADES				RIVESTITI COATED GRADES BESCHICHTET RECOUVERTS					
ART.	COD.	l	d	b	P (Fill")	R		L		R		L	
						F7030	F7030	F1025	F1025				
TONDO b = 30° (DIN 405) ROUND b = 30° (DIN 405)													
	16ER 10 RD	16EL 10 RD	16,5	9,52	30°	10							
	16ER 8 RD	16EL 8 RD	16,5	9,52	30°	8							
	16ER 6 RD	16EL 6 RD	16,5	9,52	30°	6							
	22ER 6 RD	22EL 6 RD	22	12,7	30°	6							
	22ER 4 RD	22EL 4 RD	22	12,7	30°	4							
	16IR 10 RD	16IL 10 RD	16,5	9,52	30°	10							
	16IR 8 RD	16IL 8 RD	16,5	9,52	30°	8							
	16IR 6 RD	16IL 6 RD	16,5	9,52	30°	6							
	22IR 6 RD	22IL 6 RD	22	12,7	30°	6							
	22IR 4 RD	22IL 4 RD	22	12,7	30°	4							
MATERIALE - MATERIAL - MATERIALIEN - MATÉRIAUX													
P	ACCIAIO - STEEL - STAHL - ACIER												
M	ACCIAIO INOX - STAINLESS STEEL - ROSTFREIER STAHL - ACIER INOXYDABLE												
K	GHISA - CAST IRON - GRAUGUSS - FONTE GRISE												
N	LEGHE DI ALLUMINIO - ALUMINIUM ALLOYS - ALUMINIUM-LEGIERUNGEN - ALLIAGES D'ALUMINIUM												
S	LEGHE RESISTENTI AL CALORE - HEAT RESISTANT ALLOYS - WÄRMEBESTÄNDIGE LEGIERUNGEN - ALLIAGES RÉSISSANTES À LA CHALEUR												
H	MATERIALI DURI E TEMPRATI - HARD AND HARDENED MATERIAL - HARTE UND GEHÄRTETE MATERIALIEN - MATERIAUX DURS ET TREMPÉS												

...ER ... MJ		...IR ... MJ		HW		HC															
				NON RIVESTITI CEMENTED CARBIDE GRADES		RIVESTITI COATED GRADES BESCHICHTET RECOUVERTS															
ART.	COD.	l	d	b	P(mm)																
MJ b = 60° (ISO 5855)																					
 ..ER ..	16ER 1.0 MJ	16,5	9,52	60°	1,00																
	16ER 1.25 MJ	16,5	9,52	60°	1,25																
	16ER 1.5 MJ	16,5	9,52	60°	1,50																
	16ER 2,0 MJ	16,5	9,52	60°	2,00																
 ..IR ..	11IR 1.0 MJ	11	6,35	60°	1,00																
	11IR 1.25 MJ	11	6,35	60°	1,25																
	11IR 1.5 MJ	11	6,35	60°	1,50																
	11IR 2,0 MJ	11	6,35	60°	2,00																
	16IR 1.0 MJ	16,5	9,52	60°	1,00																
	16IR 1.25 MJ	16,5	9,52	60°	1,25																
	16IR 1.5 MJ	16,5	9,52	60°	1,50																
	16IR 2,0 MJ	16,5	9,52	60°	2,00																
MATERIALE - MATERIAL - MATERIALIEN - MATÉRIAUX																					
P	ACCIAIO - STEEL - STAHL - ACIER																				
M	ACCIAIO INOX - STAINLESS STEEL - ROSTFREIER STAHL - ACIER INOXYDABLE																				
K	GHISA - CAST IRON - GRAUGUSS - FONTE GRISE																				
N	LEGHE DI ALLUMINIO - ALUMINIUM ALLOYS - ALUMINIUM-LEGIERUNGEN - ALLIAGES D'ALUMINIUM																				
S	LEGHE RESISTENTI AL CALORE - HEAT RESISTANT ALLOYS - WÄRMEBESTÄNDIGE LEGIERUNGEN - ALLIAGES RÉSISTANTES À LA CHALEUR																				
H	MATERIALI DURI E TEMPRATI - HARD AND HARDENED MATERIAL - HARTE UND GEHÄRTETE MATERIALIEN - MATERIAUX DURS ET TREMPÉS																				

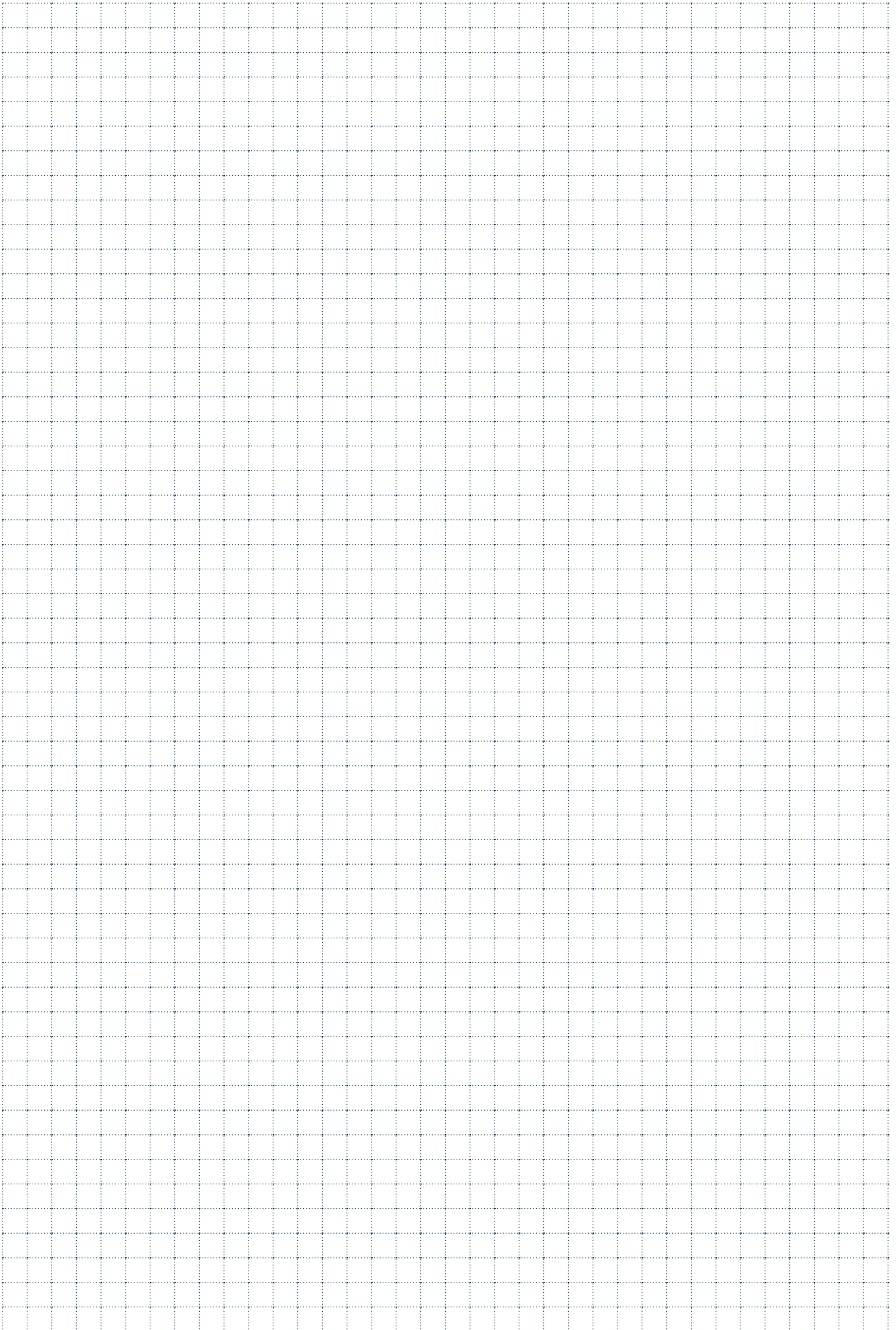

SCelta VELOCE QUICK PICK

Tenacità + ↑
Toughness - ↓

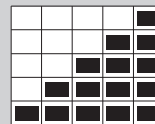

- METODO PER LA SCELTA VELOCE DEL GRADO DI METALLO DURO PIÙ IDONEO. CONTARE IL NUMERO DI RETTANGOLI COLORATI
- METHOD FOR A QUICK CHOICE OF THE MOST SUITABLE SOLID CARBIDE GRADE. COUNT THE NUMBER OF COLORED RECTANGLES
- METHODE ZUR RASCHEN AUSWAHL DER GEEIGNETSTEN HARTMETALLSORTE. DIE ANZAHL DER BUNTEN RECHTECKE ZÄHLEN
- METHODE POUR CHOISIR RAPIDEMENT LE DEGRÉ LE PLUS APPROPRIÉ DU METAL DUR. COMPTEZ LES RECTANGLES EN COULEURS
- METODO PARA LA ELECCION RAPIDA DE EL GRADO MAS ADECUADO DE METAL DURO. CONTAR LOS NUMEROS DE RECTANGULOS COLORADOS



- GRADO MOLTO RESISTENTE ALL'USURA, SOLO PER FINITURA, LAVORAZIONI AD ALTE VELOCITÀ DI TAGLIO E CONDIZIONI MOLTO RIGIDE E STABILI
- GRADE WITH HIGH RESISTANCE TO WEAR; ONLY FOR FINISHING, MACHINING AT HIGH CUTTING SPEEDS, AND VERY RIGID AND STABLE CONDITIONS



- GRADO CON ALTA RESISTENZA ALL'USURA, DISCRETA TENACITÀ PER LAVORAZIONI A VELOCITÀ MEDIO ALTE ED AVANZAMENTI MEDI, IN CONDIZIONI NORMALI
- GRADE WITH HIGH RESISTANCE TO WEAR, GOOD TOUGHNESS, FOR MEDIUM-HIGH MACHINING AND MEDIUM FEED UNDER NORMAL CONDITIONS



- GRADO CON BUONA RESISTENZA ALL'USURA UNITA A BUONA TENACITÀ, PER LAVORAZIONI GENERICHE IN CONDIZIONI NORMALI
- GRADE WITH GOOD RESISTANCE TO WEAR; COMBINED WITH A GOOD DEGREE OF TOUGHNESS, FOR GENERAL MACHINING UNDER NORMAL CONDITIONS



- GRADO CON OTTIMA TENACITÀ PER LAVORAZIONI MEDIO PESANTI O IN CONDIZIONI POCO STABILI
- GRADE WITH EXCELLENTE TOUGHNESS, FOR MEDIUM HEAVY MACHINING OR MACHINING UNDER CONDITIONS OF LOW STABILITY



- GRADO CON ECCEZIONALE TENACITÀ PER LAVORAZIONI PESANTI CON BASSE VELOCITÀ DI TAGLIO, ALTI AVANZAMENTI O IN CONDIZIONI SFAVOREVOLI
- GRADE WITH EXCELLENTE TOUGHNESS, FOR HEAVY MACHINING WITH LOW CUTTING SPEEDS, HIGH FEED, OR UNDER UNFAVORABLE CONDITIONS

GUIDA FACILE EASY GUIDE

16ER 1.25 ISO F7030	F	●	P	Vc = 90-160 m/min
	M	●	M	Vc = 70-130 m/min
	R	●	K	Vc = 80-130 m/min
		○	N	Vc = 300-800 m/min
		●	S	Vc = 40-100 m/min
		○	H	Vc = 20-50 m/min



16ER 1.25 ISO - F7030

P20-P40/M20-M30/K20-K30



- GUIDA ALL'USO DELL'INSERTO. PRESENTE ANCHE SU OGNI ETICHETTA
- GUIDE FOR THE USE OF THE INSERT. ALSO LISTED ON EACH LABEL
- LEITFADEN ZUR VERWENDUNG DER WENDEPLATTE, AUCH AUF JEDEM AUFKLEBER VORHANDEN
- INSTRUCTIONS POUR L'UTILISATION DE LA PLAQUETTE. SE TROUVANT EGALEMENT SUR CHAQUE ETIQUETTE
- GUIA POR EL UTILIZO DE LA PLAQUITA, PRESENTE TAMBIEN EN CADA ETIQUETA

GR. VDI 3323 MATERIALI MATERIALS Pag. 1199	6	P
	14.1	M
	16	K
	21	N
	33	S
	38	H



- = ACCIAIO BASSO LEGATO HB 180
- = ACCIAIO INOSSIDABILE AUSTENITICO HB 180
- = GHISA GRIGIA HB 260
- = LEGHE DI ALLUMINIO HB 60
- = LEGHE RESISTENTI AL CALORE (INCONEL) HB 250
- = ACCIAIO TEMPRATO HRC 55



- LOW STEEL ALLOY
- AUSTENITIC STAINLESS STEEL HB 180
- GRAY CAST IRON HB 260
- ALUMINUM ALLOYS HB 60
- HEAT RESISTANT ALLOYS (INCONEL) HB 250
- TEMPERED STEEL HRC 55

- F = FINITURA, LAVORAZIONI LEGGERE
- M = LAVORAZIONI MEDIE, IMPIEGO GENERICO
- R = SGROSSATURA, LAVORAZIONI PESANTI

- FINISHING, LIGHT MACHINING
- MEDIUM MACHINING, GENERAL USE
- ROUGHING, HEAVY MACHINING

- fn (mm) = AVANZAMENTO PER TORNITURA
- fz (mm/z) = AVANZAMENTO PER FRESATURA
- Vc (m/min) = VELOCITÀ DI TAGLIO

- FEED FOR TURNING
- FEED FOR MILLING
- CUTTING SPEED

- = APPLICAZIONE CONSIGLIATA
- = APPLICAZIONE POSSIBILE

- RECOMMENDED APPLICATION
- POSSIBLE APPLICATION

**COME SCEGLIERE I PARAMETRI DI LAVORO
HOW TO CHOOSE CUTTING DATA
EINSTELLUNG DER SCHNITTDATEN
COMMENT CHOISIR LES PARAMETRES DE SERVICE**

FASE 3 - PHASE 3

SCelta DEI PARAMETRI DI TAGLIO
CHOICE OF CUTTING PARAMETERS
WAHL DER SCHNEIDPARAMETER
TRIAGE DES PARAMETRES DE COUPE

SAU QUALITY TOOLING & MACHINERY

PARAMETRI DI TAGLIO
Cutting data
Schneidparameter
Paramètres de coupe

NUMERO DI PASSATE E PROFONDITÀ DI AVANZAMENTO
NUMBER OF RUNS AND FEED DEPTH
ANZAHL DER GÄNGE UND VORSCHUBTIEFE
NOMBRE DE PASSES ET PROFONDEUR D'AVANCE

Indicare un valore medio è un buon punto di partenza
Indicate a medium value is a good starting point
Angabe eines mittleren Wertes ist ein guter Ausgangspunkt
Indiquer une valeur moyenne est un bon point de départ

Preferire il numero più alto di passate
Prefer the greater number of runs
Vorziehen die größere Anzahl von Umdrehungen
Préférer le nombre le plus élevé de passes

Preferire la maggiore velocità
Prefer the higher speed
Vorziehen die höhere Drehzahl
Préférer la plus grande vitesse

Filettature profilo finito. External ISO metric finish. External ISO metric threads

Passo / Pitch (mm)	1	1.5	2	2.5	3	3.5	4	4.5	5	6	8	10	12	14	16	18	20	25	30
Prof.tot. / total depth (mm)	0.5	0.75	1.0	1.25	1.5	1.75	2.0	2.25	2.5	3.0	3.5	4.0	4.5	5.0	5.5	6.0	7.5	9.0	10.5
Passata / Step 1 (mm)	0.43	0.62	0.82	1.02	1.22	1.42	1.62	1.82	2.02	2.42	2.82	3.22	3.62	4.02	4.42	4.82	6.02	7.22	8.42
2	0.43	0.62	0.82	1.02	1.22	1.42	1.62	1.82	2.02	2.42	2.82	3.22	3.62	4.02	4.42	4.82	6.02	7.22	8.42
3	0.53	0.77	1.01	1.25	1.49	1.73	1.97	2.21	2.45	2.89	3.33	3.77	4.21	4.65	5.09	5.53	6.97	8.41	9.85
4	0.63	0.91	1.19	1.47	1.75	2.03	2.31	2.59	2.87	3.41	3.95	4.49	5.03	5.57	6.11	6.65	8.39	10.13	11.87
5	0.73	1.05	1.37	1.69	2.01	2.33	2.65	2.97	3.29	3.93	4.57	5.21	5.85	6.49	7.13	7.77	9.81	11.85	13.89
6	0.83	1.19	1.55	1.91	2.27	2.63	2.99	3.35	3.71	4.45	5.19	5.93	6.67	7.41	8.15	8.89	11.13	13.37	15.61
8	1.03	1.43	1.83	2.23	2.63	3.03	3.43	3.83	4.23	5.07	5.91	6.75	7.59	8.43	9.27	10.11	12.55	15.00	17.45
10	1.23	1.63	2.03	2.43	2.83	3.23	3.63	4.03	4.43	5.37	6.21	7.05	7.89	8.73	9.57	10.41	13.05	15.70	18.35
12	1.43	1.83	2.23	2.63	3.03	3.43	3.83	4.23	4.63	5.57	6.41	7.25	8.09	8.93	9.77	10.61	13.35	16.10	18.85
14	1.63	2.03	2.43	2.83	3.23	3.63	4.03	4.43	4.83	5.77	6.61	7.45	8.29	9.13	9.97	10.81	13.65	16.50	19.35
16	1.83	2.23	2.63	3.03	3.43	3.83	4.23	4.63	5.03	5.97	6.81	7.65	8.49	9.33	10.17	11.01	13.95	16.90	19.85
18	2.03	2.43	2.83	3.23	3.63	4.03	4.43	4.83	5.23	6.17	7.01	7.85	8.69	9.53	10.37	11.21	14.25	17.30	20.35

789

FASE 4 - PHASE 4

SCelta DI VC IN FUNZIONE DEL GR. VDI
CHOICE OF VC DEPENDING ON VDI GR.
WAHL VC JE NACH WERKSTOFF
CHOIX DE VC EN FONCTION DU GR. VDI

SAU QUALITY TOOLING & MACHINERY

IMPIEGIO DELLE QUALITÀ DI FILETTATURA
APPLICATION OF THE THREADING GRADE
EINSATZ GEWINDSCHNEIDEN
UTILISATION DE LES QUALITÉS DE FILETAGE

MATERIALE - MATERIAL
MATERIALIEN - MATERIALS
MATERIAUX

QUICK PICK
PAG. 782

INDICAZIONI - USO
INDICATIONS - USE
GEBRAUCHSANWEISUNGEN
INDICATION - USAGE

TOUGH QUALITY FOR HIGH CUTTING SPEEDS
- IDEAL FOR A WIDE RANGE OF MATERIALS

ZÄHNE SORTEN FÜR HOHE SCHNITTGESCHWINDIGKEITEN
- IDEAL FÜR EINE BREITE MATERIALPALETTE

GRADE TENACE POUR HAUTES VITESSES DE COUPE
- IDEAL POUR UNE VASTE GAMME DE MATERIALS

SELEZIONE DI FILETTATURA
CHOICE OF THREADING GRADE
WÄHLE DER SCHNITTQUALITÄTEN
VITESSE DE COUPE DE LA QUALITÉ DES PLAQUETTES DE FILETAGE

VDI 3323 GR.	HB HRC Rm	F102S	F7030	F7040	VDI 3323 GR.	HB HRC Rm	F7030	F7415	F7040	VDI 3323 GR.	HB HRC Rm	F7030	F7040
1	125 80-160 90-160 110-210	14.1	180 70-130 110-160 30-80	15	180 80-130 30-80								
2	180 80-160 90-160 110-210	14.2	220 70-130 110-160 30-80	16	260 80-130 30-80								
3	250 80-160 90-160 110-210	17	160 80-130 30-80	17	160 80-130 30-80								
4	220 80-160 90-160 110-210	18	250 80-130 30-80	18	250 80-130 30-80								
5	300 80-160 90-160 110-210	19	130 80-130 30-80	19	130 80-130 30-80								
6	180 80-120 30-80	20	230 80-130 30-80	20	230 80-130 30-80								
10	300 80-130 30-80	32	300 80-130 30-80	32	300 80-130 30-80								
11	350 50-100 80-120	33	300 80-130 30-80	33	300 80-130 30-80								
12	200 80-140 100-140 70-80	34	350 15-30	34	350 15-30								
13	330 80-140 100-140 70-80	35	320 40-100 15-30	35	320 40-100 15-30								
21	60 300-800 20-200	36	400 15-30	36	400 15-30								
22	100 300-800 20-200	37	1000 15-30	37	1000 15-30								
23	75 300-800 20-200	38	300 20-50 15-30	38	300 20-50 15-30								
24	90 300-800 20-200	39	50 20-50 15-30	39	50 20-50 15-30								
25	130 300-800 20-200	40	400 20-50 15-30	40	400 20-50 15-30								
26	110 300-800 20-200	41	50 20-50 15-30	41	50 20-50 15-30								
27	90 300-800 20-200												
28	100 300-800 20-200												
29	300-800 20-200												
30	300-800 20-200												

788



PANORAMICA QUALITÀ FILETTATURA



GENERAL VIEW OF THE THREADING GRADE



GEWINDESCHNEIDEN-ÜBERSICHT



VUE D' ENSEMBLE QUALITÉ DE FILETAGE



VISTA GENERAL DE LA CALIDAD DE ROSCADO

DIN ISO 513	P ACCIAI STEELS STAHL ACIERS					M ACCIAI INOSSIDABILI STAINLESS STEELS ROSTFREIER STAHL ACIER INOXYDABLE				K GHISE CAST IRON GRAUGUSS FONTE GRISE					N NON FERROSI NONFERROUS NICHTEISENMA PAS FERREUX				S MAT.DIFFICILI DIFFICULT MATERIAL SCHWIERIGE MATERIILIEN MAT.DIFICILES					H MATERIALI DURI HARD MATERIALS HARTE MATERIILIEN MATERIAUX DURS			
	01	10	20	30	40	50	10	20	30	40	01	10	20	30	40	01	10	20	30	01	10	20	30	40	01	10	20
HC	F7030					F7030				F7030																	
	F7415					F7415																					
	F1025																										
	F7040					F7040				F7030																	
TENACITÀ - TOUGHNESS - ZÄHIGKEIT - TÉNACITÉ																											
RESISTENZA ALL'USURA - RESISTANCE TO WEAR - VERSCHLEISSFESTIGKEIT - RÉSISTANCE À L'USURE																											
AVANZAMENTO - FEED - VORSCHUB - AVANCE																											
VELOCITÀ - SPEED - GESCHWINDIGKEIT - VITESSE																											
HT CERMET					HW METALLO DURO NON RICOPERTO UNCOATED CARBIDE UNBESCHICHTETES HARTMETALL MÉTAL DUR PAS RECOUVERT										HC METALLO DURO RICOPERTO COATED CARBIDE BESCHICHTETES HARTMETALL MÉTAL DUR RECOUVERT												

	IMPIEGO DELLE QUALITÀ DI FILETTATURA		APPLICATION OF THE THREADING GRADE
	EINSATZ GEWINDESCHNEIDEN		UTILISATION DE LES QUALITÉS DE FILETAGE

SAU	DIN ISO 513	MATERIALE - MATERIAL MATERIALIEN - MATÉRIAUX PAG. 1199						QUICK PICK PAG. 866	Tenacità + Toughness -	INDICAZIONI - USO
		P	M	K	N	S	H			
F7030	HC P20-40 M25-35	●	●	●	○	●	○			<p>INDICAZIONI - USO</p>
	PVD K20-30									
INDICATIONS - USE			GEBRAUCHSANWEISUNGEN					INDICATION - USAGE		
- SUB-MICROGRAIN GRADE WITH MULTILAYER PVD COATING - SUITABLE FOR MEDIUM TO HIGH CUTTING SPEED ON STAINLESS STEEL, EXOTIC AND DIFFICULT MATERIALS			- SUB-MIKROKORN-SORTE MIT PVD-MEHRSCICHTBESCHICHTUNG - FÜR MITTLERE BIS HOHE SCHNITTGESCHWINDIGKEIT BEI INOX-STAHL, EXOTISCHEN UND KOMPLIZIERTEN MATERIILIEN GEEIGNET					- QUALITÉ SUB-MICROGRAIN REVETUEE EN PVD MULTICOUCHES - INDIQUÉE POUR MOYEN ET ELEVÉ VITESSE DE COUPE SUR ACIERS INOXYDABLES, MATERIILIEN EXOTICS ET MATERIILIEN DIFFICILES		
F7415	HC P10-20 M10-20	○	●							<p>INDICAZIONI - USO</p>
	PVD									
INDICATIONS - USE			GEBRAUCHSANWEISUNGEN					INDICATION - USAGE		
- SUB-MICROGRAIN GRADE WITH TRIPLE LAYER PVD COATING - EXTENDED DURABILITY, HIGH RESISTANCE TO WEAR			- SUB-MIKROKORN-SORTE MIT PVD-DREISCHICHTBESCHICHTUNG - GUTE LEBENSDAUER, HOHE VERSCHLEISSFESTIGKEIT					- QUALITÉ SOUS-MICROGRAIN REVETUEE EN PVD TRIPLE-COUCHE - BONNE DUREE, HAUTE RESISTANCE A L'USURE		
F1025	HC P15-35	●								<p>INDICAZIONI - USO</p>
	PVD									
INDICATIONS - USE			GEBRAUCHSANWEISUNGEN					INDICATION - USAGE		
- GRADE FOR TREATED AND HARDENED STEEL (25 HRC AND OVER) - SUITABLE FOR MEDIUM TO LOW CUTTING SPEED			- SORTE FÜR BEHANDELTEN UND GEHÄRTETEN STAHL (AB 25HRC) - FÜR MITTLERE BIS GERINGE SCHNITTGESCHWINDIGKEIT GEEIGNET					- QUALITÉ POUR ACIERS AVEC TRAITEES ET DURCISSEES (25 HRC ET PLUS) - INDIQUÉE POUR MOYEN BAS VITESSE DE COUPE		



IMPIEGO DELLE QUALITÀ DI FILETTATURA



APPLICATION OF THE THREADING GRADE



EINSATZ GEWINDESCHNEIDEN



UTILISATION DE LES QUALITÉS DE FILETAGE

SAU	DIN ISO 513	MATERIALE - MATERIAL MATERIALIEN - MATÉRIAUX PAG. 1199						QUICK PICK PAG. 866	 INDICAZIONI - USO		
		P	M	K	N	S	H				
		ACCIAI STEELS STAHL ACIER	ACCIAI INOX STAINLESS STEELS ROSTFREIER STAHL ACIER INOXYDABLE	GHISA CAST IRON GRAUGUSS	MATTONI FERROSI NON FERROUS MAT. NICHT-EISENMATERIALIEN MAT. FERREUX	MAT DIFFICILI DIFFICULT MATERIAL SCHWERGE MATERIALIEN MAT. DIFICILES	MATERIALI DURI HARD MATERIALS HARTE MATERIALIEN MATÉRIAUX DURS				
F7040	HC P30-50 M20-40 PVD K25-40	●	○	●	●	○	○	 Tenacità + Toughness -	 		
		INDICATIONS - USE						GEBRAUCHSANWEISUNGEN		INDICATION - USAGE	
		- TOUGH QUALITY FOR HIGH CUTTING SPEEDS - IDEAL FOR A WIDE RANGE OF MATERIALS						- ZÄHE SORTE FÜR HOHE SCHNITTGESCHWINDIGKEITEN - IDEAL FÜR EINE BREITE MATERIALPALETTE		- DEGRE TENACE POUR DE HAUTES VITESSES DE COUPE - IDEAL POUR UNE VASTE GAMME DE MATÉRIAUX	



VELOCITÀ DI TAGLIO DELLE QUALITÀ DI FILETTATURA



CUTTING SPEED OF THREADING GRADE



SCHNITTGESCHWINDIGKEIT DER GEWINDEQUALITÄTEN



VITESSE DE COUPE DE LA QUALITÉ DES PLAQUETTES DE FILETAGE

MATERIAL PAG 1199	VDI 3323 GR.	HB HRC Rm	F7030	F7415	F1025	F7040	MATERIAL PAG 1199	VDI 3323 GR.	HB HRC Rm	F7030	F7415	F7040	MATERIAL PAG 1199	VDI 3323 GR.	HB HRC Rm	F7030	F7040		
P	1	125	90-160	110-210	80-160	20-100	M	14.1	180	70-130	110-160	30-90	K	15	180	80-130	30-90		
	2	180	90-160	110-210	80-160	20-100		14.2	230-260	70-130	110-160	30-90		16	260	80-130	30-90		
	3	250	90-160	110-210	80-160	20-100									17	160	80-130	30-90	
	4	220	90-160	110-210	80-160	20-100										18	250	80-130	30-90
	5	300	90-160	110-210	80-160	20-100										19	130	80-130	30-90
	6	180	80-150	90-140	80-120	30-80										20	230	80-130	30-90
	7-8	250-300	80-150	90-140	80-120	30-80													
	9	350	80-150	90-140	80-120	30-80													
	10	200	80-120	90-140	50-100	50-80													
	11	350	80-120	70-90	50-100	50-80													
	12	200	100-140	70-90	80-140	50-100													
	13	330	100-140	70-90	80-140	50-100													

MATERIAL PAG 1199	VDI 3323 GR.	HB HRC Rm	F7030	F7040
21	60		300-800	20-200
22	100		300-800	20-200
23	75		300-800	20-200
24	90		300-800	20-200
25	130		300-800	20-200
26	110		300-800	20-200
27	90		300-800	20-200
28	100		300-800	20-200
29			300-800	20-200
30			300-800	20-200

MATERIAL PAG 1199	VDI 3323 GR.	HB HRC Rm	F7030	F7040
31	200		40-100	15-30
32	280		40-100	15-30
33	250		40-100	15-30
34	350		40-100	15-30
35	320		40-100	15-30
36	Rm 400		40-100	15-30
37	Rm 1050		40-100	15-30

MATERIAL PAG 1199	VDI 3323 GR.	HB HRC Rm	F7030	F7040
38		55 HRC	20-50	15-30
39		60 HRC	20-50	15-30
40		400	20-50	15-30
41		55 HRC	20-50	15-30



NUMERO DI PASSATE E PROFONDITÀ DI AVANZAMENTO



NUMBER OF RUNS AND FEED DEPTH



ANZAHL DER GÄNGE UND VORSCHUBTIEFE



NOMBRE DE PASSES ET PROFONDEUR D'AVANCE

1. Per molte applicazioni utilizzare un valore medio è un buon punto di partenza
2. Per materiali tenaci si deve adottare il numero più alto di passate
3. Come regola generale minori passate sono da preferirsi a maggiore velocità

1. For many applications use an average value and a good starting point
2. In the case of tough materials you will have to use a greater number of runs
3. As a general rule, less runs are to be preferred to a higher speed

Filettature profilo finito/parziale ISO metriche esterne External ISO metric finished/partial profile threads

Passo / Pitch (mm)	6,0	5,5	5,0	4,5	4,0	3,5	3,0	2,5	2,0	1,75	1,5	1,25	1,0	0,80	0,75	0,50
Prof.tot. / total depth (mm)	3,54	3,25	2,96	2,65	2,33	2,05	1,78	1,48	1,17	1,05	0,85	0,75	0,60	0,49	0,46	0,31
Passata / Step 1 (mm)	0,46	0,43	0,42	0,37	0,34	0,32	0,28	0,26	0,23	0,22	0,20	0,17	0,17	0,17	0,16	0,10
2	0,43	0,40	0,40	0,34	0,31	0,30	0,26	0,25	0,21	0,20	0,18	0,17	0,15	0,14	0,13	0,08
3	0,35	0,33	0,32	0,28	0,24	0,24	0,21	0,18	0,17	0,15	0,15	0,14	0,11	0,11	0,10	0,07
4	0,30	0,26	0,26	0,23	0,21	0,19	0,16	0,15	0,15	0,13	0,13	0,10	0,09	0,07	0,07	0,06
5	0,26	0,22	0,22	0,21	0,18	0,17	0,14	0,13	0,12	0,10	0,11	0,09	0,08	-	-	-
6	0,22	0,20	0,20	0,19	0,15	0,15	0,13	0,12	0,11	0,09	0,08	0,08	-	-	-	-
7	0,20	0,18	0,17	0,16	0,14	0,14	0,12	0,11	0,10	0,08	-	-	-	-	-	-
8	0,19	0,17	0,16	0,15	0,13	0,13	0,11	0,10	0,08	0,08	-	-	-	-	-	-
9	0,18	0,16	0,16	0,14	0,12	0,12	0,10	0,10	-	-	-	-	-	-	-	-
10	0,16	0,15	0,15	0,13	0,12	0,11	0,10	0,08	-	-	-	-	-	-	-	-
11	0,15	0,14	0,14	0,12	0,11	0,10	0,09	-	-	-	-	-	-	-	-	-
12	0,15	0,14	0,14	0,12	0,10	0,08	0,08	-	-	-	-	-	-	-	-	-
13	0,14	0,13	0,12	0,11	0,10	-	-	-	-	-	-	-	-	-	-	-
14	0,13	0,12	0,10	0,10	0,08	-	-	-	-	-	-	-	-	-	-	-
15	0,12	0,12	-	-	-	-	-	-	-	-	-	-	-	-	-	-
16	0,10	0,10	-	-	-	-	-	-	-	-	-	-	-	-	-	-

Filettature profilo finito/parziale ISO metriche interne Internal ISO metric finished/partial profile threads

Passo / Pitch (mm)	6,0	5,5	5,0	4,5	4,0	3,5	3,0	2,5	2,0	1,75	1,5	1,25	1,0	0,80	0,75	0,50
Prof.tot. / total depth (mm)	3,54	3,25	2,96	2,65	2,33	2,05	1,78	1,48	1,17	1,05	0,85	0,75	0,60	0,49	0,46	0,31
Passata / Step 1 (mm)	0,46	0,43	0,42	0,37	0,34	0,32	0,28	0,26	0,23	0,22	0,20	0,17	0,17	0,17	0,16	0,10
2	0,43	0,40	0,40	0,34	0,31	0,30	0,26	0,25	0,21	0,20	0,18	0,17	0,15	0,14	0,13	0,08
3	0,35	0,33	0,32	0,28	0,24	0,24	0,21	0,18	0,17	0,15	0,15	0,14	0,11	0,11	0,10	0,07
4	0,30	0,26	0,26	0,23	0,21	0,19	0,16	0,15	0,15	0,13	0,13	0,10	0,09	0,07	0,07	0,06
5	0,26	0,22	0,22	0,21	0,18	0,17	0,14	0,13	0,12	0,10	0,11	0,09	0,08	-	-	-
6	0,22	0,20	0,20	0,19	0,15	0,15	0,13	0,12	0,11	0,09	0,08	0,08	-	-	-	-
7	0,20	0,18	0,17	0,16	0,14	0,14	0,12	0,11	0,10	0,08	-	-	-	-	-	-
8	0,19	0,17	0,16	0,15	0,13	0,13	0,11	0,10	0,08	0,08	-	-	-	-	-	-
9	0,18	0,16	0,16	0,14	0,12	0,12	0,10	0,10	-	-	-	-	-	-	-	-
10	0,16	0,15	0,15	0,13	0,12	0,11	0,10	0,08	-	-	-	-	-	-	-	-
11	0,15	0,14	0,14	0,12	0,11	0,10	0,09	-	-	-	-	-	-	-	-	-
12	0,15	0,14	0,14	0,12	0,10	0,08	0,08	-	-	-	-	-	-	-	-	-
13	0,14	0,13	0,12	0,11	0,10	-	-	-	-	-	-	-	-	-	-	-
14	0,13	0,12	0,10	0,10	0,08	-	-	-	-	-	-	-	-	-	-	-
15	0,12	0,12	-	-	-	-	-	-	-	-	-	-	-	-	-	-
16	0,10	0,10	-	-	-	-	-	-	-	-	-	-	-	-	-	-

Filettature Whitworth esterne/interne External/internal Whitworth threads

Passo / Pitch TPI	5	6	7	8	9	10	11	12	14	16	18	19	20	26	28
Prof.tot. / total depth (mm)	3,44	2,90	2,50	2,17	1,93	1,76	1,58	1,45	1,20	1,13	1,01	0,96	0,92	0,72	0,69
Passata / Step 1 (mm)	0,45	0,38	0,37	0,32	0,30	0,29	0,28	0,28	0,24	0,24	0,23	0,22	0,21	0,19	0,18
2	0,43	0,36	0,35	0,30	0,28	0,27	0,26	0,26	0,22	0,22	0,22	0,22	0,21	0,18	0,17
3	0,38	0,30	0,29	0,24	0,23	0,22	0,22	0,22	0,18	0,19	0,19	0,18	0,17	0,15	0,14
4	0,32	0,26	0,25	0,21	0,20	0,19	0,19	0,18	0,15	0,16	0,16	0,14	0,14	0,12	0,12
5	0,28	0,22	0,22	0,19	0,18	0,17	0,16	0,16	0,13	0,13	0,13	0,12	0,11	0,08	0,08
6	0,25	0,21	0,19	0,17	0,15	0,15	0,14	0,14	0,11	0,11	0,08	0,08	0,08	-	-
7	0,22	0,19	0,18	0,15	0,14	0,14	0,13	0,13	0,09	0,08	-	-	-	-	-
8	0,20	0,17	0,16	0,14	0,13	0,13	0,12	0,08	0,08	-	-	-	-	-	-
9	0,19	0,16	0,15	0,13	0,12	0,12	0,08	-	-	-	-	-	-	-	-
10	0,18	0,15	0,14	0,12	0,12	0,08	-	-	-	-	-	-	-	-	-
11	0,17	0,14	0,12	0,12	0,08	-	-	-	-	-	-	-	-	-	-
12	0,15	0,14	0,08	0,08	-	-	-	-	-	-	-	-	-	-	-
13	0,12	0,12	-	-	-	-	-	-	-	-	-	-	-	-	-
14	0,10	0,10	-	-	-	-	-	-	-	-	-	-	-	-	-



NUMERO DI PASSATE E PROFONDITÀ DI AVANZAMENTO



NUMBER OF RUNS AND FEED DEPTH



ANZAHL DER GÄNGE UND VORSCHUBTIEFE



NOMBRE DE PASSES ET PROFONDEUR D'AVANCE

Filettature UN esterne UN external threads

Passo / Pitch TPI	5	6	7	8	9	10	11	12	13	14	16	18	20	24	28	32
Prof.tot. / total depth (mm)	3,29	2,71	2,33	2,08	1,84	1,66	1,52	1,39	1,29	1,19	1,05	0,94	0,84	0,70	0,60	0,53
Passata / Step 1 (mm)	0,43	0,36	0,35	0,30	0,28	0,27	0,27	0,27	0,25	0,23	0,22	0,23	0,20	0,19	0,17	0,17
2	0,40	0,34	0,33	0,28	0,26	0,26	0,25	0,26	0,24	0,22	0,21	0,21	0,19	0,17	0,15	0,15
3	0,36	0,27	0,26	0,25	0,21	0,20	0,20	0,20	0,18	0,17	0,16	0,16	0,15	0,14	0,11	0,13
4	0,31	0,23	0,22	0,21	0,20	0,17	0,19	0,18	0,17	0,15	0,14	0,14	0,12	0,12	0,09	0,08
5	0,26	0,22	0,21	0,18	0,17	0,16	0,16	0,15	0,14	0,13	0,13	0,12	0,10	0,08	0,08	–
6	0,23	0,20	0,19	0,16	0,15	0,15	0,14	0,13	0,12	0,11	0,11	0,08	0,08	–	–	–
7	0,20	0,18	0,17	0,14	0,14	0,14	0,12	0,12	0,11	0,10	0,08	–	–	–	–	–
8	0,19	0,16	0,15	0,13	0,12	0,12	0,11	0,08	0,08	0,08	–	–	–	–	–	–
9	0,19	0,15	0,14	0,12	0,12	0,11	0,08	–	–	–	–	–	–	–	–	–
10	0,18	0,14	0,12	0,12	0,11	0,08	–	–	–	–	–	–	–	–	–	–
11	0,17	0,13	0,11	0,11	0,08	–	–	–	–	–	–	–	–	–	–	–
12	0,15	0,12	0,08	0,08	–	–	–	–	–	–	–	–	–	–	–	–
13	0,12	0,11	–	–	–	–	–	–	–	–	–	–	–	–	–	–
14	0,10	0,10	–	–	–	–	–	–	–	–	–	–	–	–	–	–

Filettature UN interne UN internal threads

Passo / Pitch TPI	5	6	7	8	9	10	11	12	13	14	16	18	20	24	28	32
Prof.tot. / total depth (mm)	2,99	2,46	2,13	1,88	1,66	1,49	1,36	1,25	1,14	1,06	0,93	0,84	0,76	0,64	0,56	0,49
Passata / Step 1 (mm)	0,42	0,35	0,34	0,30	0,28	0,27	0,27	0,27	0,25	0,23	0,22	0,23	0,20	0,18	0,17	0,17
2	0,38	0,33	0,32	0,28	0,26	0,25	0,23	0,23	0,20	0,18	0,18	0,17	0,16	0,15	0,14	0,14
3	0,33	0,25	0,24	0,22	0,19	0,18	0,18	0,18	0,15	0,14	0,14	0,14	0,13	0,13	0,09	0,10
4	0,27	0,21	0,21	0,18	0,16	0,15	0,15	0,15	0,13	0,13	0,12	0,12	0,10	0,10	0,08	0,08
5	0,23	0,18	0,17	0,15	0,14	0,13	0,13	0,13	0,12	0,11	0,10	0,10	0,09	0,08	0,08	–
6	0,20	0,16	0,15	0,13	0,13	0,12	0,11	0,11	0,11	0,10	0,09	0,08	0,08	–	–	–
7	0,18	0,15	0,14	0,12	0,12	0,11	0,11	0,10	0,10	0,09	0,08	–	–	–	–	–
8	0,17	0,14	0,13	0,11	0,11	0,10	0,10	0,08	0,08	0,08	–	–	–	–	–	–
9	0,16	0,13	0,12	0,11	0,10	0,10	0,08	–	–	–	–	–	–	–	–	–
10	0,15	0,12	0,12	0,10	0,09	0,08	–	–	–	–	–	–	–	–	–	–
11	0,14	0,12	0,11	0,10	0,08	–	–	–	–	–	–	–	–	–	–	–
12	0,14	0,11	0,08	0,08	–	–	–	–	–	–	–	–	–	–	–	–
13	0,12	0,11	–	–	–	–	–	–	–	–	–	–	–	–	–	–
14	0,10	0,10	–	–	–	–	–	–	–	–	–	–	–	–	–	–

Inserti Multidento esterni External multitooth inserts

Tipo / Type	ISO metrica - ISO metric					Whitworth	NPT
	3M	2M	3M	2M	3M	2M	2M
Passo / Pitch (mm)	1,0	1,5	1,5	2,0	2,0	–	–
TPI (filetti per pollice / threads per inch)	–	–	–	–	–	11	11,5
Prof.tot. / total depth (mm)	0,65	0,93	0,93	1,25	1,25	1,58	1,76
Passata / Step 1 (mm)	0,36	0,43	0,56	0,57	0,75	0,73	0,59
2	0,29	0,30	0,37	0,40	0,50	0,50	0,50
3	–	0,20	–	0,28	–	0,35	0,37
4	–	–	–	–	–	–	0,30

Inserti Multidento interni Internal multitooth inserts

Tipo / Type	ISO metrica - ISO metric					Whitworth	NPT
	3M	2M	3M	2M	3M	2M	2M
Passo / Pitch (mm)	1,0	1,5	1,5	2,0	2,0	–	–
TPI (filetti per pollice / threads per inch)	–	–	–	–	–	11	11,5
Prof.tot. / total depth (mm)	0,60	0,85	0,85	1,17	1,17	1,58	1,76
Passata / Step 1 (mm)	0,33	0,38	0,51	0,51	0,70	0,73	0,59
2	0,27	0,27	0,34	0,38	0,47	0,50	0,50
3	–	0,20	–	0,28	–	0,35	0,37
4	–	–	–	–	–	–	0,30



NUMERO DI PASSATE E PROFONDITÀ DI AVANZAMENTO



NUMBER OF RUNS AND FEED DEPTH



ANZAHL DER GÄNGE UND VORSCHUBTIEFE



NOMBRE DE PASSES ET PROFONDEUR D'AVANCE

Filettature NPT esterne/interne External/internal NPT threads

Passo / Pitch TPI	8	11,5	14	18	27
Prof.tot. / total depth (mm)	2,54	1,76	1,45	1,12	0,75
Passata / Step 1 (mm)	0,28	0,25	0,24	0,22	0,19
2	0,25	0,22	0,22	0,18	0,15
3	0,22	0,18	0,17	0,15	0,13
4	0,19	0,16	0,15	0,14	0,11
5	0,18	0,16	0,14	0,13	0,09
6	0,18	0,14	0,13	0,12	0,08
7	0,17	0,14	0,12	0,10	–
8	0,17	0,12	0,10	0,08	–
9	0,16	0,12	0,10	–	–
10	0,16	0,10	0,08	–	–
11	0,14	0,09	–	–	–
12	0,13	0,08	–	–	–
13	0,12	–	–	–	–
14	0,11	–	–	–	–
15	0,08	–	–	–	–

Filettature Tonde DIN 405 esterne External DIN 405 Round threads

Passo / Pitch TPI	4	6	8	10
Prof.tot. / total depth (mm)	3,43	2,23	1,73	1,40
Passata / Step 1 (mm)	0,44	0,33	0,29	0,26
2	0,40	0,29	0,26	0,25
3	0,34	0,25	0,21	0,23
4	0,32	0,23	0,19	0,20
5	0,28	0,20	0,18	0,16
6	0,26	0,18	0,16	0,12
7	0,24	0,16	0,14	0,10
8	0,22	0,15	0,12	0,08
9	0,20	0,14	0,10	–
10	0,19	0,12	0,08	–
11	0,17	0,10	–	–
12	0,15	0,08	–	–
13	0,12	–	–	–
14	0,10	–	–	–

Filettature Tonde DIN 405 interne Internal DIN 405 Round threads

Passo / Pitch TPI	4	6	8	10
Prof.tot. / total depth (mm)	3,59	2,44	1,66	1,49
Passata / Step 1 (mm)	0,46	0,38	0,26	0,27
2	0,43	0,34	0,22	0,26
3	0,40	0,30	0,21	0,25
4	0,35	0,25	0,19	0,22
5	0,30	0,21	0,18	0,18
6	0,26	0,19	0,16	0,13
7	0,24	0,17	0,14	0,10
8	0,22	0,16	0,12	0,08
9	0,20	0,14	0,10	–
10	0,19	0,12	0,08	–
11	0,17	0,10	–	–
12	0,15	0,08	–	–
13	0,12	–	–	–
14	0,10	–	–	–

Filettature TR esterne External TR threads

Passo / Pitch TPI	6,0	5,0	4,0	3,0	2,0	1,5
Prof.tot. / total depth (mm)	3,66	2,89	2,38	1,83	1,33	0,97
Passata / Step 1 (mm)	0,37	0,34	0,31	0,27	0,25	0,23
2	0,35	0,33	0,28	0,25	0,24	0,22
3	0,32	0,27	0,24	0,21	0,20	0,18
4	0,29	0,25	0,20	0,17	0,17	0,14
5	0,27	0,23	0,19	0,15	0,14	0,12
6	0,25	0,21	0,18	0,13	0,13	0,08
7	0,23	0,20	0,16	0,13	0,11	–
8	0,22	0,20	0,15	0,12	0,09	–
9	0,22	0,18	0,15	0,12	–	–
10	0,20	0,16	0,15	0,10	–	–
11	0,18	0,15	0,14	0,10	–	–
12	0,17	0,14	0,13	0,08	–	–
13	0,17	0,13	0,10	–	–	–
14	0,16	0,10	–	–	–	–
15	0,14	–	–	–	–	–
16	0,12	–	–	–	–	–

Filettature TR interne Internal TR threads

Passo / Pitch TPI	6,0	5,0	4,0	3,0	2,0	1,5
Prof.tot. / total depth (mm)	3,65	2,89	2,38	1,85	1,34	0,98
Passata / Step 1 (mm)	0,37	0,34	0,31	0,27	0,25	0,23
2	0,34	0,33	0,28	0,25	0,24	0,22
3	0,32	0,27	0,24	0,22	0,21	0,19
4	0,29	0,25	0,20	0,17	0,17	0,14
5	0,27	0,23	0,19	0,15	0,14	0,12
6	0,25	0,21	0,18	0,14	0,13	0,08
7	0,23	0,20	0,16	0,13	0,11	–
8	0,22	0,20	0,15	0,12	0,09	–
9	0,22	0,18	0,15	0,12	–	–
10	0,20	0,16	0,15	0,10	–	–
11	0,18	0,15	0,14	0,10	–	–
12	0,17	0,14	0,13	0,08	–	–
13	0,17	0,13	0,10	–	–	–
14	0,16	0,10	–	–	–	–
15	0,14	–	–	–	–	–
16	0,12	–	–	–	–	–

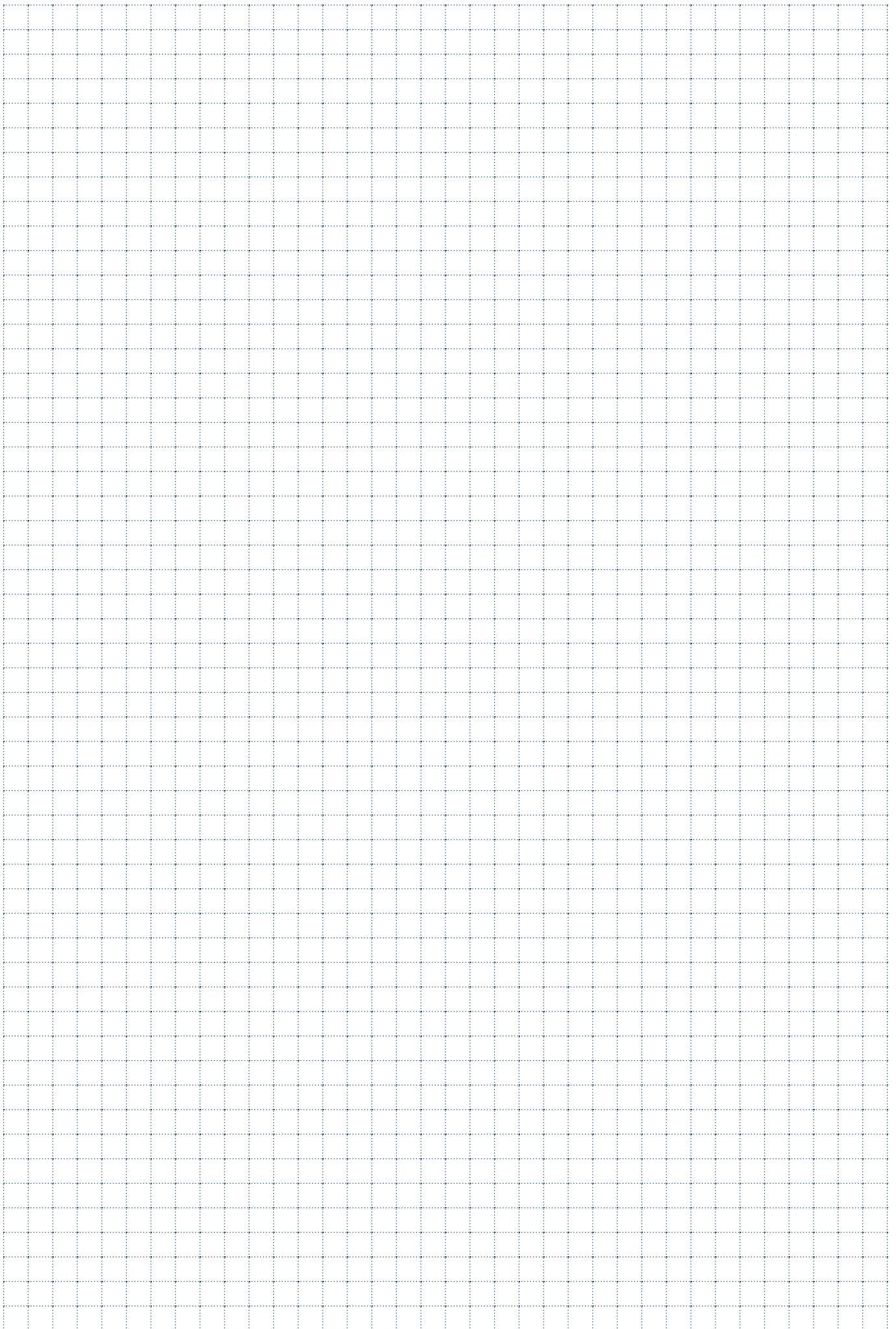

SISTEMA MODULARE BARENATURA



MODULAR TOOL SYSTEM - BORING / MODULARE WERKZEUGSYSTEME - AUSBOHREN
SYSTEMES MODULAIRE FLEXIBLE - ALÉSAGE / SISTEMA MODULAR FLEXIBLE - MANDRINADO

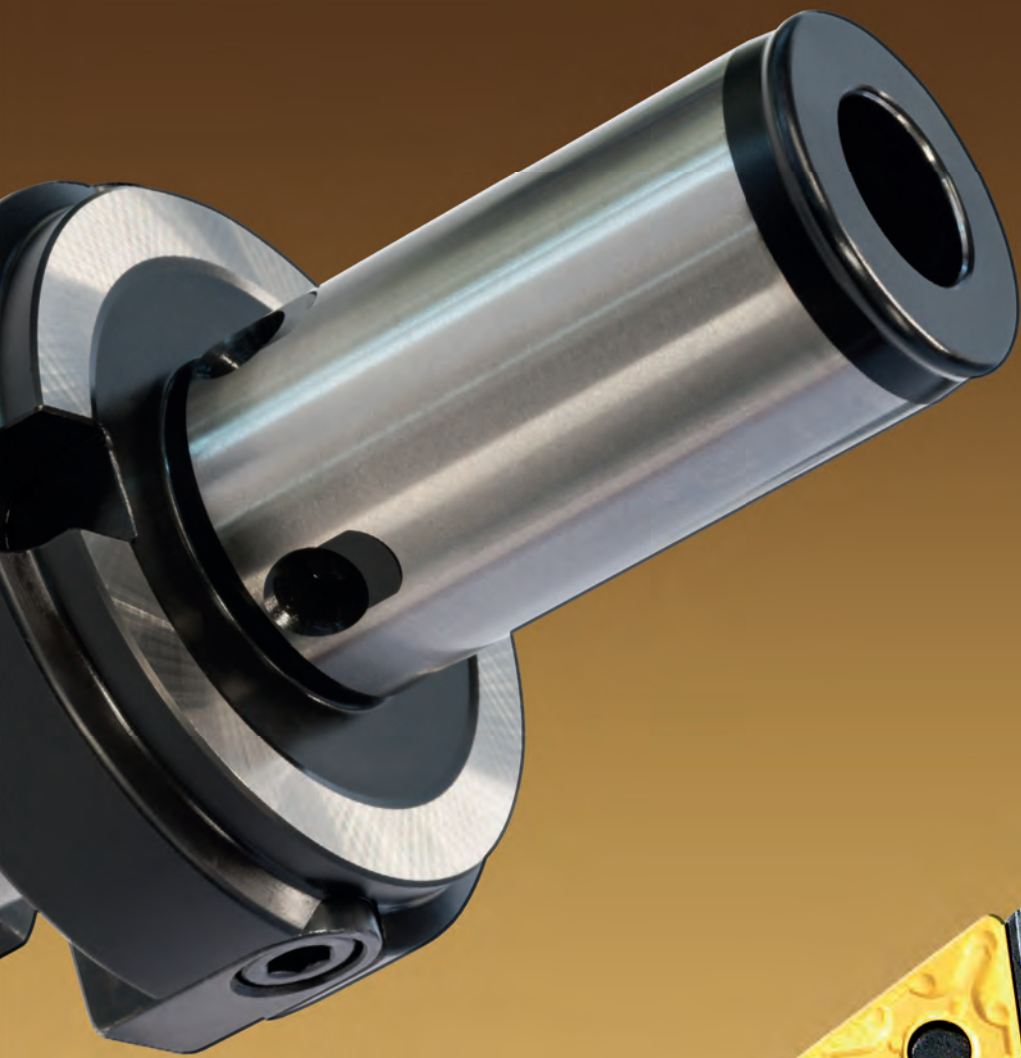



	SISTEMA MODULARE FLESSIBILE	
	MODULAR TOOL SYSTEM	
	MODULARE WERKZEUGSYSTEME	
	SYSTEMES MODULAIRE FLEXIBLE	
	SISTEMA MODULAR FLEXIBLE	

Pag. 883

	UTENSILI PER BARENATURA	
	BORING TOOLS	
	AUSBOHRWERKZEUGE + MODULAR WERKZEUGE	
	OUTILS D'ALÉSAGE	
	HERRAMIENTAS PARA MANDRINADO	

Pag. 898

	COMPONENTI PER BARENATURA	
	BORING COMPONENTS	
	EINBAUHALTER	
	COMPOSANTES POUR D'ALÉSAGE	
	COMPONENTES PARA MANDRINADO	

Pag. 914

	INSERTI PER BARENATURA	
	BORING INSERTS	
	WENDEPLATTEN ZUM AUSBOHREN	
	PLAQUÉTTES POUR ALÉSAGE	
	PLAQUITAS DE MANDRINADO	

Pag. 933

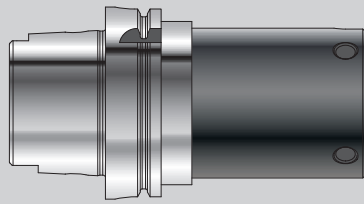

HSK-DIN 69893
HKA...DP...

PAG. 888

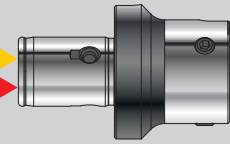

374...
RDU...

PAG. 890

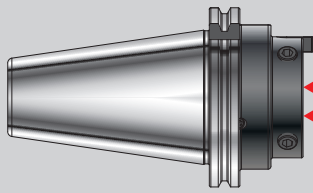

DIN 69871
370.3...

PAG. 888

DIN 69871
370.3... (*)

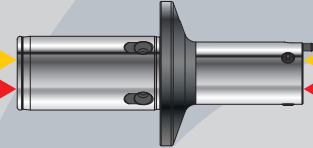

380.080.063.100
RDU.063.0...

PAG. 891

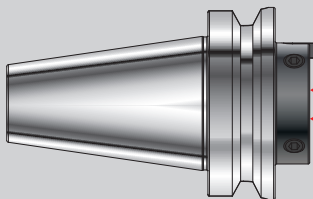

MAS-403-BT
370.9...

PAG. 889

MAS-403-BT
370.9... (*)

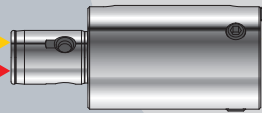

371...
PRL...

PAG. 891

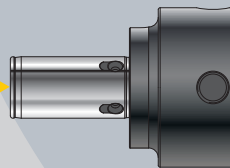

RDU...Q...SAU NIKKEN

PAG. 897

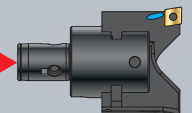

BLM 030...
a
BLM 064...

PAG. 908 - 909

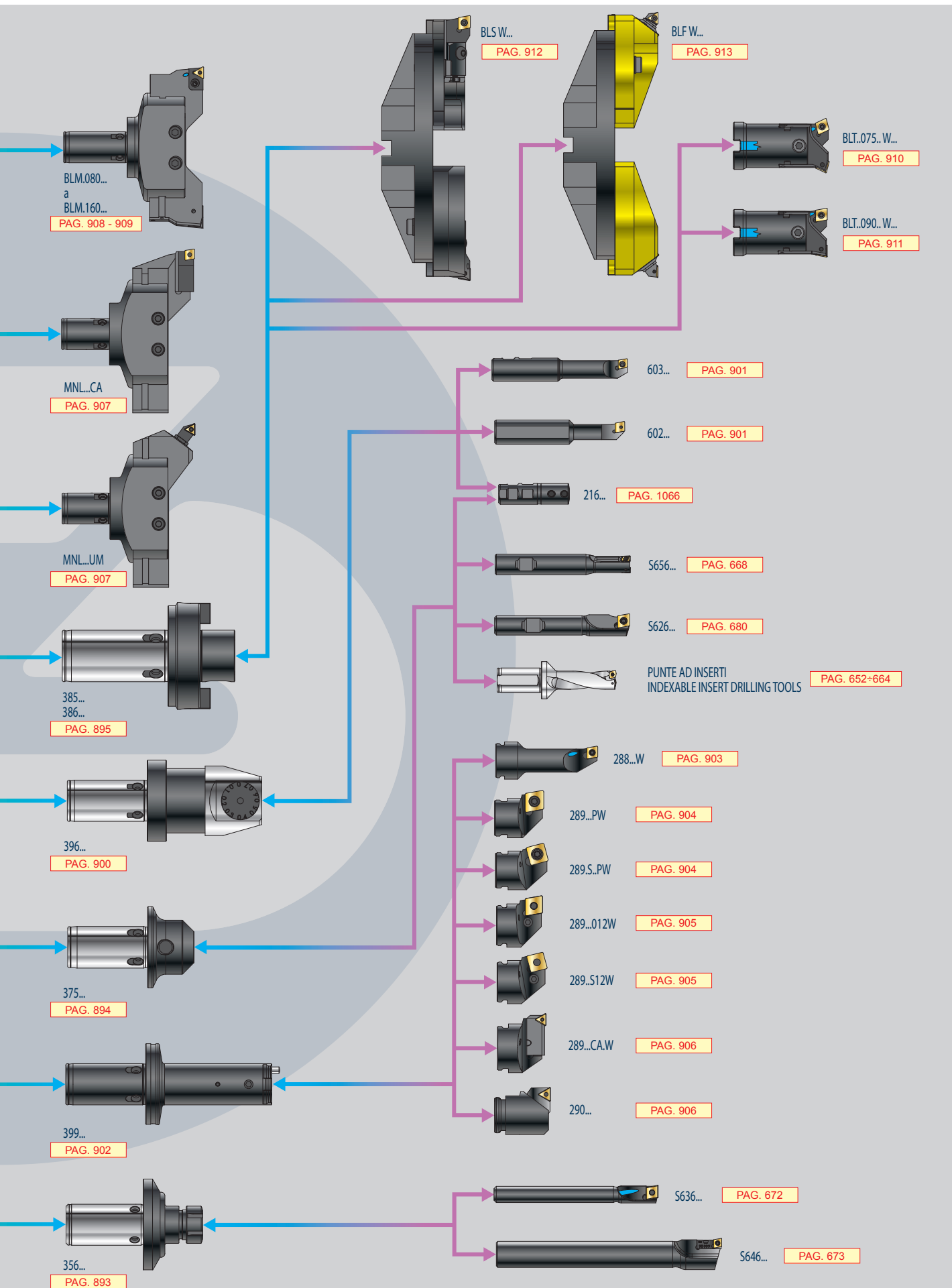

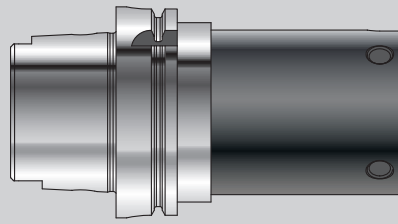

HSK-DIN 69893
HKA...DP...

PAG. 888

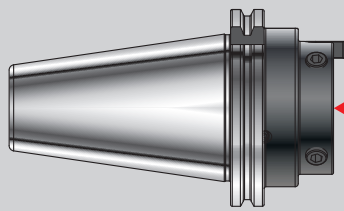

DIN 69871
370.3...

PAG. 888

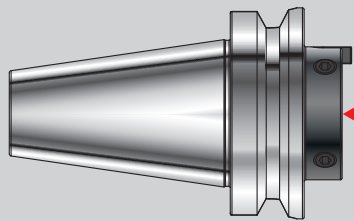

MAS-403-BT
370.9...

PAG. 889

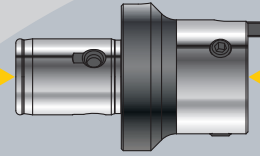

374...
RDU...

PAG. 890

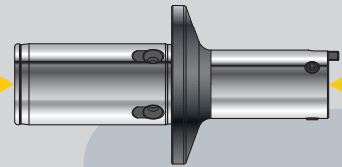

380.080.063.100
RDU.063.0....

PAG. 891



371...
PRL...

PAG. 891

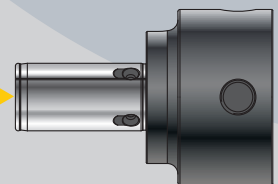

RDU...Q., SAU NIKKEN

PAG. 897

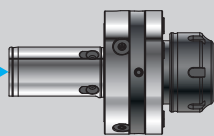

Portapinza Registrabile
Adjustable collet-holder

360... **PAG. 892**

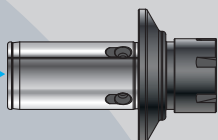

356...
357... **PAG. 893**

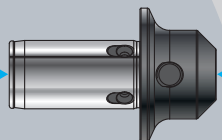

375... **PAG. 894**

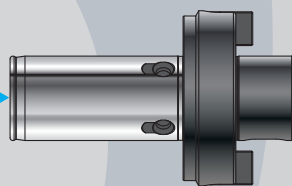

385...
386... **PAG. 895**

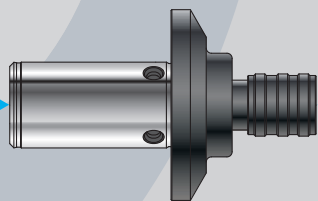

393... **PAG. 896**

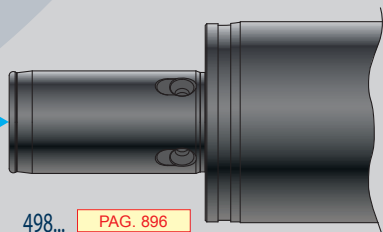

498... **PAG. 896**

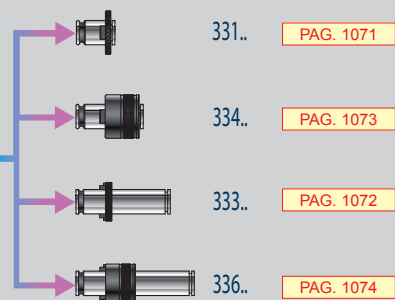
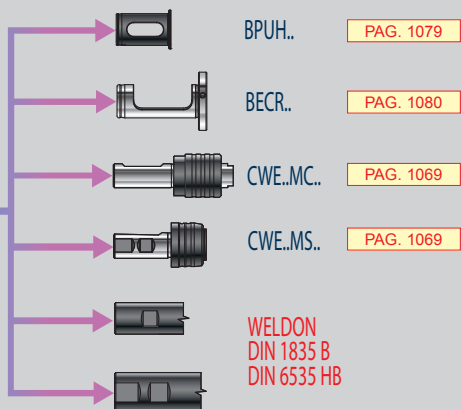

SCHEMA SISTEMA MODULARE BILAMA DA Ø30 A Ø82
DIAGRAM TWIN CUTTER MODULAR SYSTEM FROM Ø30 TO Ø82

PAG. 878

SCHEMA SISTEMA MODULARE, LAVORAZIONE FORI E BARENATURA DA Ø30 A Ø550
DIAGRAM MODULAR SYSTEM, BEARBEITUNG VON BOHRUNGEN AND BORING FROM Ø30 TO Ø550

PAG. 878

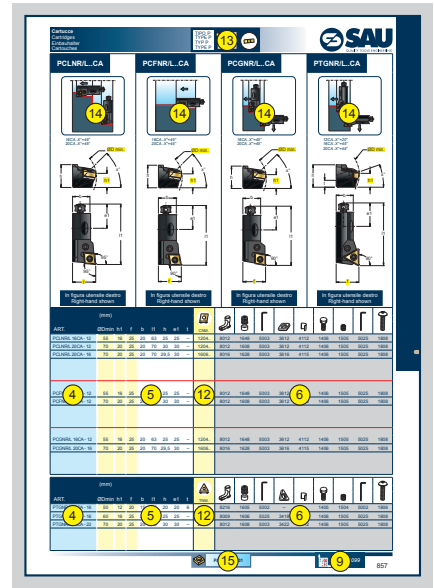
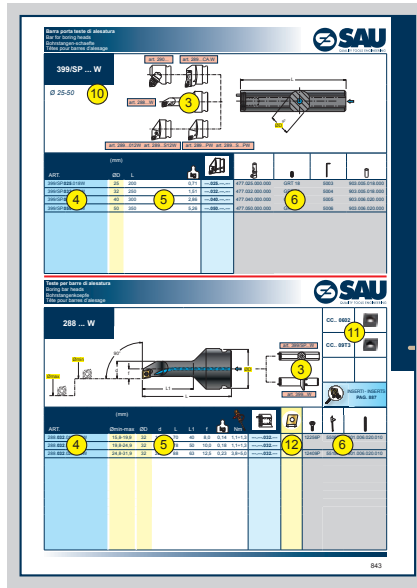
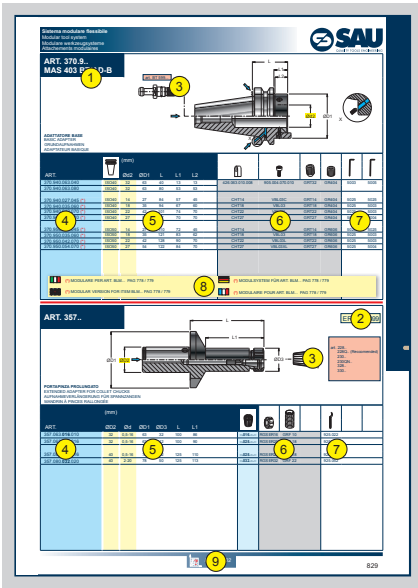

- 1 = NORMA ATTACCO
- 2 = NORMA PARTE ANTERIORE
- 3 = ACCESSORI OPZIONALI A RICHIESTA
- 4 = ARTICOLO
- 5 = MISURE, DATI, INDICAZIONI
- 6 = ACCESSORI E RICAMBI IN DOTAZIONE
- 7 = ACCESSORI E RICAMBI OPZIONALI A RICHIESTA
- 8 = NOTE E AVVERTIMENTI
- 9 = ULTERIORI DATI TECNICI E CONSIGLI D'USO
- 10 = ARTICOLO + GAMMA DIAMETRI
- 11 = INSERTI CONSIGLIATI
- 12 = GRANDEZZA INSERTO
- 13 = SISTEMA DI BLOCCAGGIO
- 14 = LAVORAZIONI CONSIGLIATE
- 15 = INSERTI DISPONIBILI



- 1 = SHANK STANDARD
- 2 = TOOL-HOLDER STANDARD
- 3 = OPTIONAL ACCESSORIES ON REQUEST
- 4 = ITEM
- 5 = MEASURES, DATA, INDICATIONS
- 6 = ACCESSORIES AND SPARE PARTS EQUIPMENT
- 7 = OPTIONAL ACCESSORIES AND SPARE PARTS ON REQUEST
- 8 = NOTES AND WARNINGS
- 9 = FURTHER TECHNICAL DATA AND SUGGESTIONS
- 10 = ITEM + DIAMETER RANGE
- 11 = RECOMMENDED INSERTS
- 12 = INSERT SIZE
- 13 = CLAMPING SYSTEM
- 14 = RECOMMENDED MACHINING TYPES
- 15 = AVAILABLE INSERTS









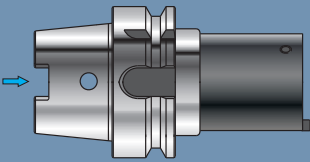
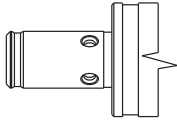
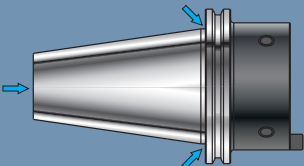
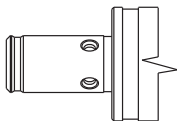
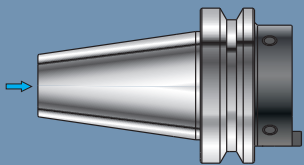
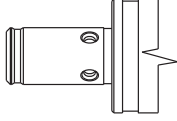
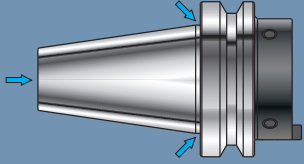
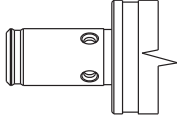
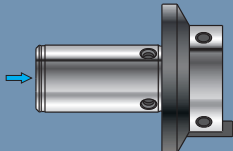
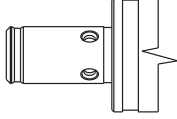
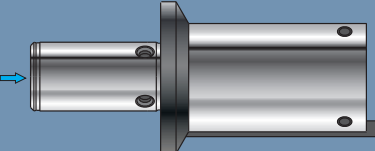
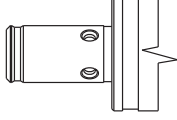

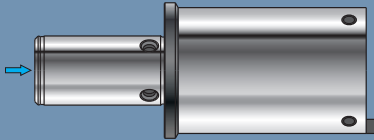
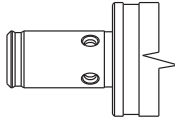
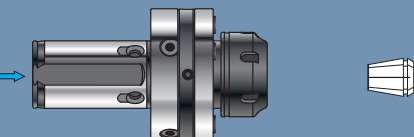

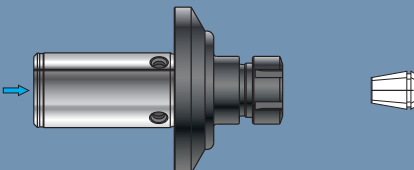
- 1 = KEGEL-NORM
- 2 = AUFNAHME-NORM
- 3 = OPTIONALZUBEHÖR AUF ANFRAGE
- 4 = ARTIKEL
- 5 = ABMESSUNGEN, DATEN, HINWEISE
- 6 = ZUBEHÖR UND ERSATZTEIL AUSSTATTUNG
- 7 = OPTIONALZUBEHÖR UND -ERSATZTEILE AUF ANFRAGE
- 8 = ANMERKUNGEN UND HINWEISE
- 9 = WEITERE TECHNISCHE DATEN UND TIPPS
- 10 = ARTIKEL + DURCHMESSERBEREICH
- 11 = EMPFOHLENE WENDESCHNEIDPLATTEN
- 12 = WENDEPLATTENGRÖSSE
- 13 = SPANNSYSTEM
- 14 = EMPFOHLENE BEARBEITUNGEN
- 15 = LIEFERBARE WENDESCHNEIDPLATTEN

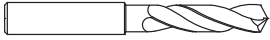
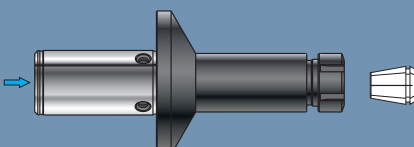

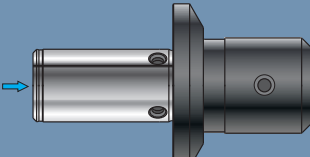
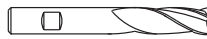
- 1 = NORMES POUR ATTACHEMENT
- 2 = NORME POUR MANDRIN
- 3 = ACCESSOIRES OPTIONNELS SUR DEMANDE
- 4 = ARTICLE
- 5 = DIMENSIONS, DONNÉES, INDICATIONS
- 6 = ACCESSOIRES ET RECHANGE EN DOTATION
- 7 = ACCESSOIRES ET RECHANGES OPTIONNELS SUR DEMANDE
- 8 = NOTES ET AVERTISSEMENTS
- 9 = ULTÉRIEURES DONNÉES TECHNIQUES ET CONSEILS D'USAGE
- 10 = ARTICLE + GAMME DE DIAMÈTRES
- 11 = PLAQUETTES CONSEILLÉES
- 12 = DIMENSIONS DE LA PLAQUETTE
- 13 = SYSTÈME DE BLOCCAGE
- 14 = USINAGES CONSEILLÉS
- 15 = PLAQUETTES DISPONIBLES

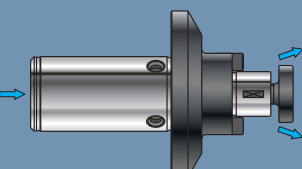
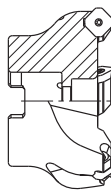
<p>ADATTATORE BASE - BASIC ADAPTER - GRUNDAUFNAHMEN - ADAPTATEUR BASIQUE</p>	<p>HKA.. DP.. ... /AD</p>  <p>DIN 69893-A HSK</p> <p>PAG 888</p>	
<p>ADATTATORE BASE - BASIC ADAPTER - GRUNDAUFNAHMEN - ADAPTATEUR BASIQUE</p>	<p>370.3.. ... /A - AD - B</p>  <p>DIN 69871</p> <p>PAG 888</p>	
<p>ADATTATORE BASE - BASIC ADAPTER - GRUNDAUFNAHMEN - ADAPTATEUR BASIQUE</p>	<p>370.8.. ... /AD</p>  <p>MAS-403-BT</p> <p>PAG 889</p>	
<p>ADATTATORE BASE - BASIC ADAPTER - GRUNDAUFNAHMEN - ADAPTATEUR BASIQUE</p>	<p>370.9.. ... /AD - B</p>  <p>MAS-403-BT</p> <p>PAG 889</p> <p>DIN 1835/B</p>	
<p>RIDUZIONE - REDUCTION - REDUZIERUNGEN - RÉDUCTION</p>	<p>RDU.. 374..</p>  <p>PAG 890</p>	
<p>RIDUZIONE PROLUNGATA - EXTENDED RÉDUCTION - LANGE REDUZIERUNGEN - RÉDUCTION RALLONGÉE</p>	<p>RDU.. 380..</p>  <p>PAG 891</p>	

<p>PROLUNGA - EXTENSION - VERLAENGERUNGEN - RALLONGE</p>	<p>PRL.. 371..</p>  <p>PAG 891</p>	
<p>PORTAPINZA REGISTRABILE ADJUSTABLE COLLET-HOLDER EINSTELLBARES SPANNFUTTER MANDRIN PORTE-PINCE RÉGLABLE</p>	<p>360..</p> <p>ER - DIN 6499</p>  <p>PAG 892</p>	<p>DIN 1835 A - DIN 6535 HA</p>  
<p>PORTAPINZA - COLLET HOLDER - FRÄSERSPANFUTTER - MANDRIN À PINCES</p>	<p>356..</p> <p>ER - DIN 6499</p>  <p>PAG 893</p>	<p>DIN 1835 A - DIN 6535 HA</p>  
<p>PORTAPINZA PROLUNGATO - EXTENDED ADAPTER FOR COLLET CHUCKS - AUFNAHMEVERLÄNGERUNG FÜR SPANNZANGEN - MANDRIN À PINCES RALLONGÉE</p>	<p>357..</p> <p>ER - DIN 6499</p>  <p>PAG 893</p>	<p>DIN 1835 A - DIN 6535 HA</p>  
<p>PORTAFRESA CON ATTACCO TIPO WELDON - END MILL HOLDERS WELDON TYPE - FRÄSERAUFNAHME MIT WELDON - MANDRIN PORTE-FRAISE AVEC ATTACHEMENT WELDON</p>	<p>375..</p> <p>DIN 1835/B</p>  <p>PAG 894</p>	<p>WELDON - DIN1835B - DIN6535HB</p>  
<p>PORTAFRESA COMBINATO A TRASCINAMENTO FRONTALE E FORI PER REFRIGERAZIONE - COMBINED SHELL-END MILL HOLDERS WITH COOLANT BORES - FRÄSERAUFNAHME MIT QUERNUT UND KÜHLMITTELBOHRUNGEN - MANDRIN PORTE FRAISE COMBINÉ À ENTRAÎNEMENT FRONTAL AVEC LUBRIFICATION</p>	<p>385..W</p>  <p>PAG 895</p>	<p>DIN 8030 A+B DIN 138</p>  



386..W

PORTAFRESA LUNGO COMBINATO A TRASCINAMENTO FRONTALE E FORI PER REFRIGERAZIONE

- COMBINED SHELL END MILL HOLDERS WITH COOLANT BORE, LONG-TYPE
- KOMBI-AUFNAHME MIT QUERNUT UND KÜHLMITTELBOHRUNGLANGE AUSFÜHRUNG
- MANDRIN COMBINÉ À ENTRAÎNEMENT FRONTAL AVEC LUBRIFICATION, SERIE-LONGUE

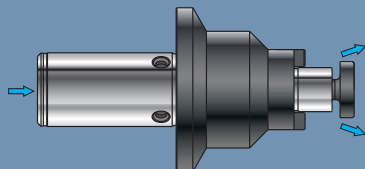

PAG 895

DIN 8030 A+B

DIN 138

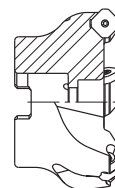

393..

PORTAMASCHIO A CAMBIO RAPIDO CON DOPPIA COMPENSAZIONE

- QUICK-CHANGE TAP HOLDER WITH DOUBLE COMPENSATION
- GEWINDESCHNEID-SCHNELLWECHSELFUTTER MIT DOPPELAUSGLEICH
- MANDRINS DE TARAUDAGE À CHANGEMENT RAPIDE À DOUBLE COMPENSATION

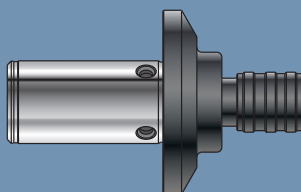

PAG 896

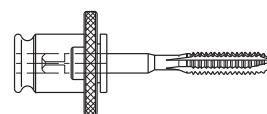

498..

BARRA A STELO TENERO

- BORING BAR BLANK
- STANGE MIT WEICHEM SCHAFT
- BARRE AVEC BOUT DOUX

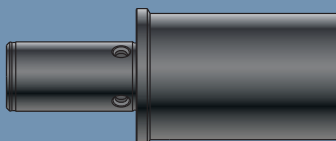

PAG 896

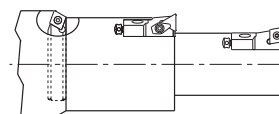

RDU.. Q..

RIDUZIONE S.A.U./NIKKEN

- REDUCTION S.A.U./NIKKEN
- REDUZIERUNGEN S.A.U./NIKKEN
- RÉDUCTION S.A.U./NIKKEN

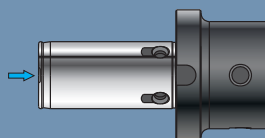

PAG 897

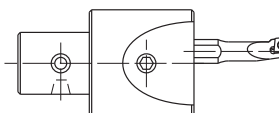

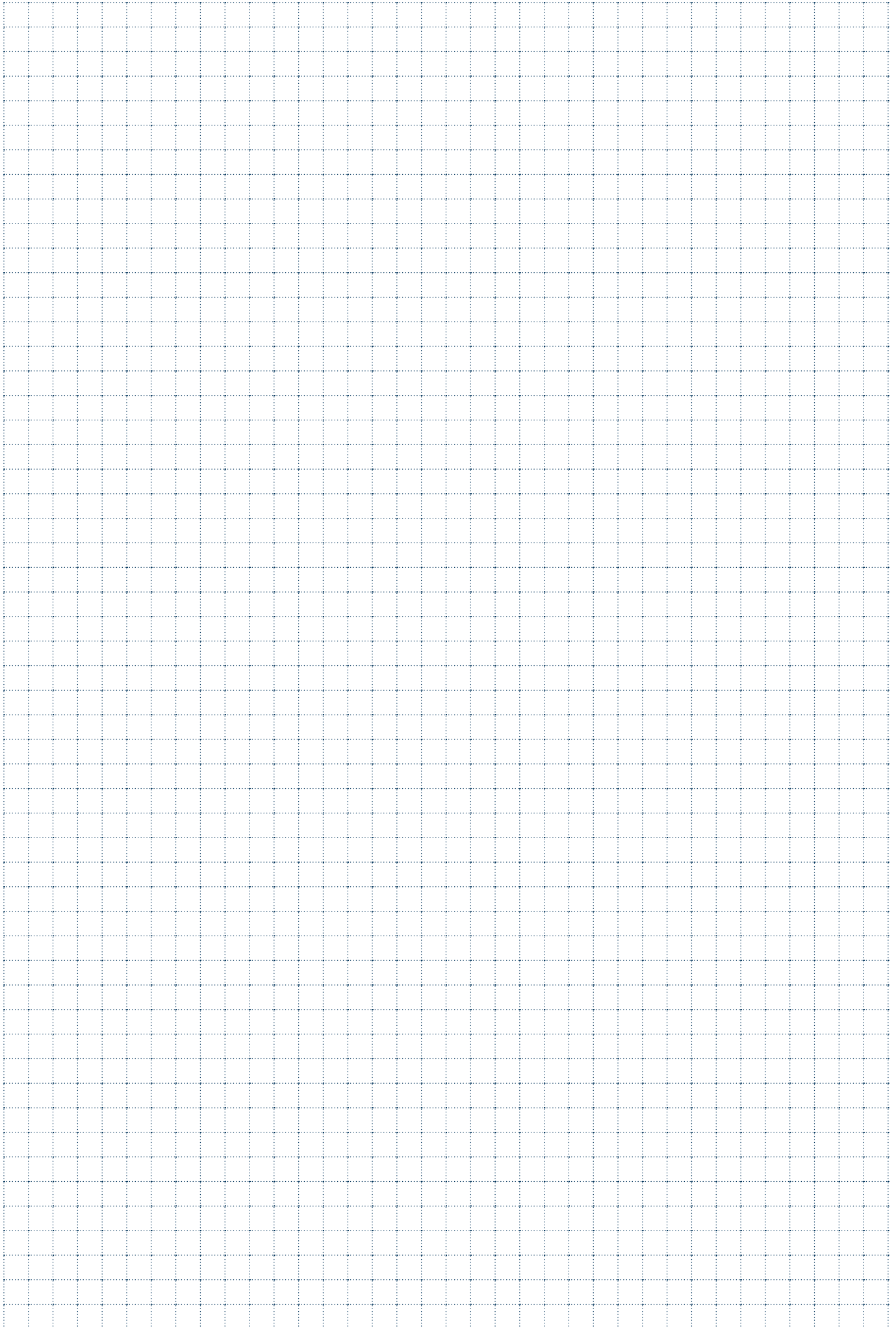



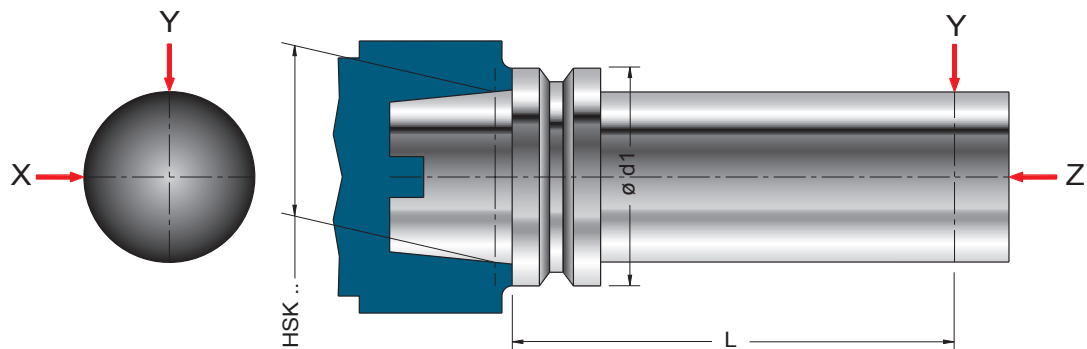

PRECISIONE ELEVATA DI RIPETIBILITÀ
 GREAT PRECISION IN TERMS OF REPEATABILITY
 HOHE GENAUIGKEIT HINSICHTLICH DER WIEDERHOLBARKEIT
 PRÉCISION DE POSSIBILITÉ RÉPÉTITIVE ÉLEVÉE



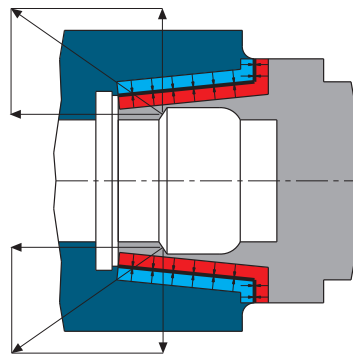



HSK	d1	L	X	Y	Z
32	32	50	0,002	0,002	0,002
40	40	60	0,002	0,002	0,002
50	50	75	0,002	0,002	0,002
63	63	100	0,002	0,002	0,002
100	100	150	0,002	0,002	0,002

ELEVATA RESISTENZA ALLA FLESSIONE
 GREAT BENDING STRENGTH
 OPTIMALE KRAFTÜBERTRAGUNG
 ÉLEVÉE RÉSISTANCE À LA FLEXION







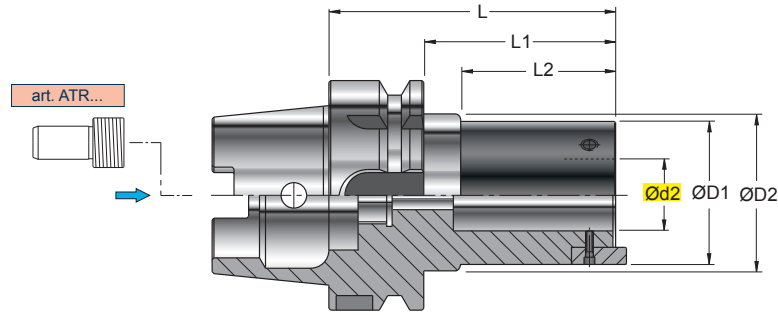

-  PARTICOLARMENTE ADATTO PER LE ALTE VELOCITÀ(HSC)
-  PARTICULARLY SUITABLE FOR HIGH SPEEDS(HSC)
-  BESONDERS FÜR HOCHGESCHWINDIGKEIT GEEIGNET(HSC)
-  PARTICULIÈREMENT INDIQUÉ POUR LES HAUTES VITESSES(HSC)

-  BREVI TEMPI DI CAMBIO UTENSILE E MIGLIORE MANIPOLAZIONE
-  SHORT TOOL-CHANGE TIME AND BETTER HANDLING
-  KURZE WERKZEUGWECHSELZEIT UND BESSERE HANDHABUNG
-  TEMPS BREFS DE CHANGEMENT OUTIL ET UNE MEILLEURE MANIPULATION

**ART. HKA.. DP..
HSK - AD (DIN 69893)**







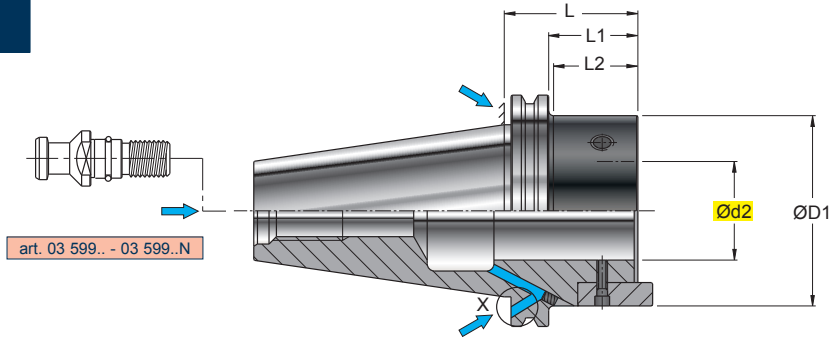

ADATTATORE BASE
BASIC ADAPTER
GRUNDAUFNAHMEN
ADAPTATEUR BASIQUE

ART.	 (mm)	Ød2	ØD1	ØD2	L	L1	L2					
HKA.063.DP063.105	HSK63	32	62	52,5	105	79	63	426.063.010.008	905.004.070.010	GRT32	5003	5005
HKA.100.DP063.110	HSK100	32	62	84,5	110	81	65					
HKA.100.DP080.135	HSK100	40	78	84,5	135	106	90	426.080.012.008	905.005.080.012	GRT40	5004	5006

**ART. 370.3..
DIN 69871/AD-B**



ADATTATORE BASE
BASIC ADAPTER
GRUNDAUFNAHMEN
ADAPTATEUR BASIQUE

ART.	 (mm)	Ød2	ØD1	L	L1	L2						
370.340.063.050	ISO40	32	63	50	31	31	426.063.010.008	905.004.070.010	GRT32	GR404	5003	5005
370.340.063.080	ISO40	32	63	80	61	61						
370.350.063.052	ISO50	32	63	52	33	33	426.063.010.008	905.004.070.010	GRT32	GR505	5003	5005
370.350.080.052	ISO50	40	78	52	33	33	426.080.012.008	905.005.080.012	GRT40	GR505	5004	5006
370.350.080.100	ISO50	40	78	100	81	81						
370.340.027.045 (*)	ISO40	14	27	76	57	45	CHT14	VBL03C	GRT14	GR404	5025	5025
370.340.035.060 (*)	ISO40	18	35	86	67	60	CHT18	VBL03	GRT18	GR404	5025	5003
370.340.042.070 (*)	ISO40	22	42	93	74	70	CHT22	VBL03L	GRT22	GR404	5025	5003
370.340.054.070 (*)	ISO40	27	54	89	70	70	CHT27	VBL03XL	GRT27	GR404	5025	5004
370.350.027.045 (*)	ISO50	14	27	97	72	45	CHT14	VBL03C	GRT14	GR505	5025	5025
370.350.035.060 (*)	ISO50	18	35	108	83	62	CHT18	VBL03	GRT18	GR505	5025	5003
370.350.042.070 (*)	ISO50	22	42	112	93	70	CHT22	VBL03L	GRT22	GR505	5025	5003
370.350.054.070 (*)	ISO50	27	54	105	86	70	CHT27	VBL03XL	GRT27	GR505	5025	5004

 (*) MODULARE PER ART. BLM... PAG 908 / 909

 (*) MODULSYSTEM FÜR ART. BLM... PAG 908 / 909

 (*) MODULAR VERSION FOR ITEM BLM... PAG 908 / 909

 (*) MODULAIRE POUR ART. BLM... PAG 908 / 909

ART. 370.8.. MAS 403 BT/AD

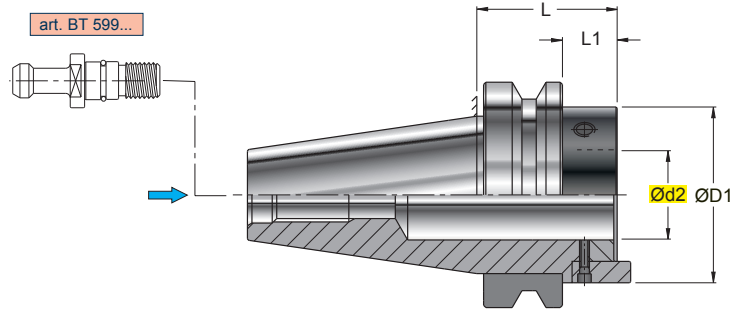

ADATTATORE BASE
BASIC ADAPTER
GRUNDAUFNAHMEN
ADAPTATEUR BASIQUE

ART.		(mm)								
		Ød2	ØD1	L	L1					
370.840.063.040	ISO40	32	63	40	13	426.063.010.008	905.004.070.010	GRT32	5003	5005
370.850.063.056	ISO50	32	63	56	18	426.063.010.008	905.004.070.010	GRT32	5003	5005
370.850.080.056	ISO50	40	78	56	18	426.080.012.008	905.005.080.012	GRT40	5004	5006

ART. 370.9.. MAS 403 BT/AD-B

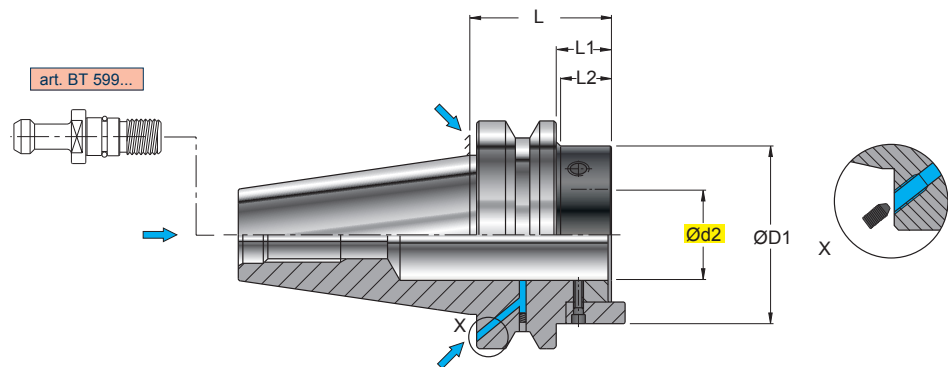

ADATTATORE BASE
BASIC ADAPTER
GRUNDAUFNAHMEN
ADAPTATEUR BASIQUE

ART.		(mm)										
		Ød2	ØD1	L	L1	L2						
370.940.063.040	ISO40	32	63	40	13	13	426.063.010.008	905.004.070.010	GRT32	GR404	5003	5005
370.940.063.080	ISO40	32	63	80	53	53						
370.940.027.045 (*)	ISO40	14	27	84	57	45	CHT14	VBL03C	GRT14	GR404	5025	5025
370.940.035.060 (*)	ISO40	18	35	94	67	60	CHT18	VBL03	GRT18	GR404	5025	5003
370.940.042.070 (*)	ISO40	22	42	101	74	70	CHT22	VBL03L	GRT22	GR404	5025	5003
370.940.054.070 (*)	ISO40	27	54	97	70	70	CHT27	VBL03XL	GRT27	GR404	5025	5004
370.950.027.045 (*)	ISO50	14	27	110	72	45	CHT14	VBL03C	GRT14	GR606	5025	5025
370.950.035.060 (*)	ISO50	18	35	121	83	62	CHT18	VBL03	GRT18	GR606	5025	5003
370.950.042.070 (*)	ISO50	22	42	128	90	70	CHT22	VBL03L	GRT22	GR606	5025	5003
370.950.054.070 (*)	ISO50	27	54	122	84	70	CHT27	VBL03XL	GRT27	GR606	5025	5004

(*) MODULARE PER ART. BLM... PAG 908 / 909

(*) MODULSYSTEM FÜR ART. BLM... PAG 908 / 909

(*) MODULAR VERSION FOR ITEM BLM... PAG 908 / 909

(*) MODULAIRE POUR ART. BLM... PAG 908 / 909

**ART. RDU..
ART. 374..**

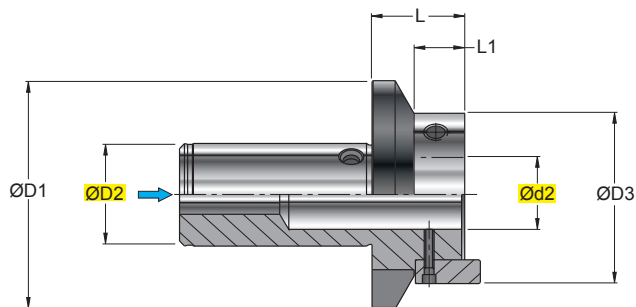

RIDUZIONE
REDUCTION
REDUZIERUNGEN
RÉDUCTION

ART.	(mm)										
	ØD2	Ød2	ØD1	ØD3	L	L1					
374.080.063.022	40	32	78	63	22	12	426.063.010.008	905.004.070.010	GRT32	5003	5005
RDU.035.027.030 (*)	18	14	35	27	30	18	CHT14	VBL03C	GRT14	5025	5025
RDU.042.035.035 (*)	22	18	42	35	35	22	CHT18	VBL03	GRT18	5025	5003
RDU.054.042.040 (*)	27	22	54	42	40	23	CHT22	VBL03L	GRT22	5025	5003
RDU.063.027.020 (*)	32	14	63	27	20	8	CHT14	VBL03C	GRT14	5025	5025
RDU.063.035.025 (*)	32	18	63	35	25	13	CHT18	VBL03	GRT18	5025	5003
RDU.063.042.038 (*)	32	22	63	42	38	28	CHT22	VBL03L	GRT22	5025	5003
RDU.063.054.045 (*)	32	27	63	54	45	35	CHT27	VBL03XL	GRT27	5025	5004
RDU.080.027.047 (*)	40	14	78	27	47	35	CHT14	VBL03C	GRT14	5025	5025
RDU.080.035.056 (*)	40	18	78	35	56	42	CHT18	VBL03	GRT18	5025	5003
RDU.080.042.066 (*)	40	22	78	42	66	50	CHT22	VBL03L	GRT22	5025	5003
RDU.080.054.062 (*)	40	27	78	54	62	50	CHT27	VBL03XL	GRT27	5025	5004

(*) MODULARE PER ART. BLM... PAG 908 / 909

(*) MODULSYSTEM FÜR ART. BLM... PAG 908 / 909

(*) MODULAR VERSION FOR ITEM BLM... PAG 908 / 909

(*) MODULAIRE POUR ART. BLM... PAG 908 / 909

ART. RDU..
ART. 380..

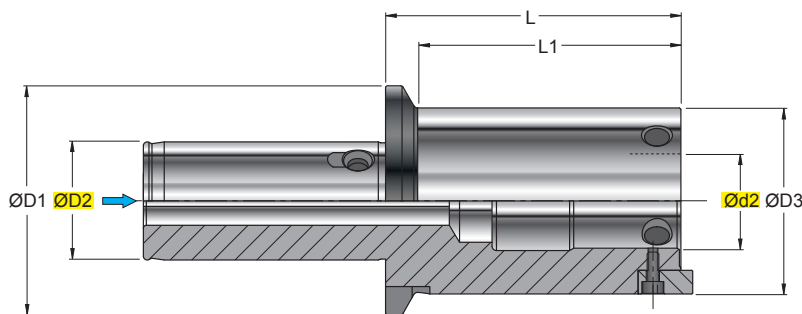

RIDUZIONE PROLUNGATA
EXTENDED REDUCTION
LANGE REDUZIERUNGEN
RÉDUCTION RALLONGÉE

(mm)											
ART.	ØD2	Ød2	ØD1	ØD3	L	L1					
380.080.063.100	40	32	78	63	100	90	426.063.010.008	905.004.070.010	GRT32	5003	5005
RDU.063.027.062 (*)	32	14	63	27	62	50	CHT14	VBL03C	GRT14	5025	5025
RDU.063.035.077 (*)	32	18	63	35	77	65	CHT18	VBL03	GRT18	5025	5003
RDU.063.042.086 (*)	32	22	63	42	86	74	CHT22	VBL03L	GRT22	5025	5003
RDU.063.054.096 (*)	32	27	63	54	96	84	CHT27	VBL03XL	GRT27	5025	5004

(*) MODULARE PER ART. BLM... PAG 908 / 909

(*) MODULSYSTEM FÜR ART. BLM... PAG 908 / 909

(*) MODULAR VERSION FOR ITEM BLM... PAG 908 / 909

(*) MODULAIRE POUR ART. BLM... PAG 908 / 909

ART. PRL..
ART. 371..

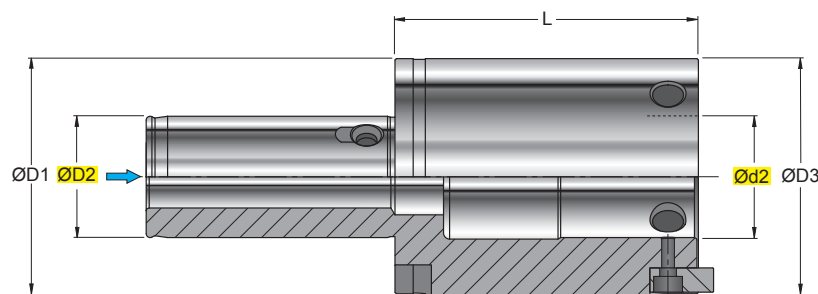

PROLUNGA
EXTENSION
VERLAENGERUNGEN
RALLONGE

(mm)										
ART.	ØD2	Ød2	ØD1	ØD3	L					
371.063.063.080	32	32	63	63	80	426.063.010.008	905.004.070.010	GRT32	5003	5005
371.080.080.100	40	40	78	78	100	426.080.012.008	905.005.080.012	GRT40	5004	5006
prl.027.027.045 (*)	14	14	27	27	45	CHT14	VBL03C	GRT14	5025	5025
prl.035.035.060 (*)	18	18	35	35	60	CHT18	VBL03	GRT18	5025	5003
prl.042.042.070 (*)	22	22	42	42	70	CHT22	VBL03L	GRT22	5025	5003
prl.054.054.070 (*)	27	27	54	54	70	CHT27	VBL03XL	GRT27	5025	5004

(*) MODULARE PER ART. BLM... PAG 908 / 909

(*) MODULSYSTEM FÜR ART. BLM... PAG 908 / 909

(*) MODULAR VERSION FOR ITEM BLM... PAG 908 / 909

(*) MODULAIRE POUR ART. BLM... PAG 908 / 909

ART. 360..

ER-DIN 6499

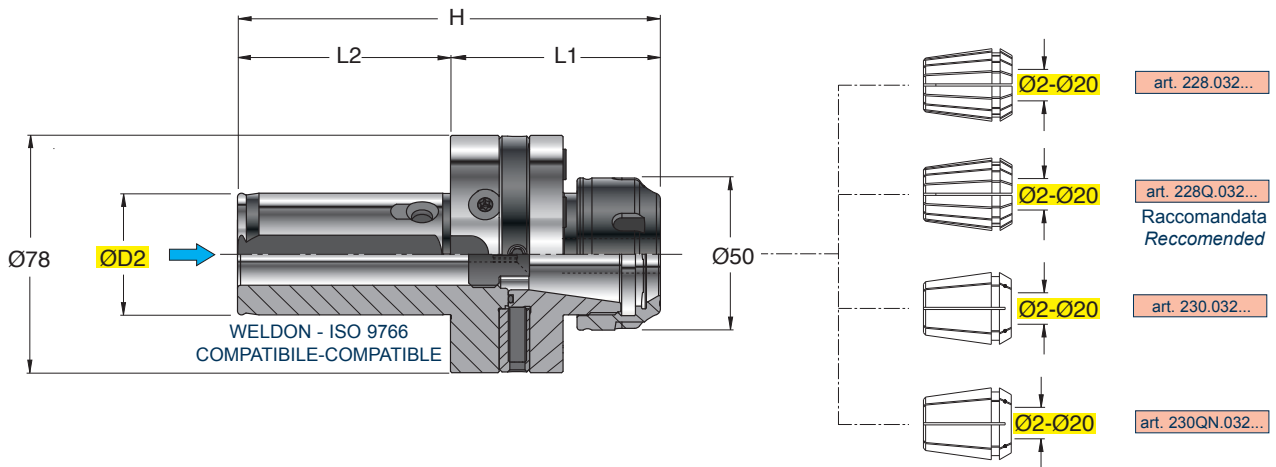

PORTAPINZA REGISTRABILE
ADJUSTABLE COLLET-HOLDER
EINSTELLBARES SPANNFUTTER
MANDRIN PORTE-PINCE RÉGLABLE

ART.	(mm)				Collet	Washer	Washer	Screw	Pin	Washer	Screw	Screw	Pin	Pin	Pin
	ØD2	H	L1	L2											
360.063.032.020	32	129	69	60	032										
360.078.032.020	40	139	69	70	032										

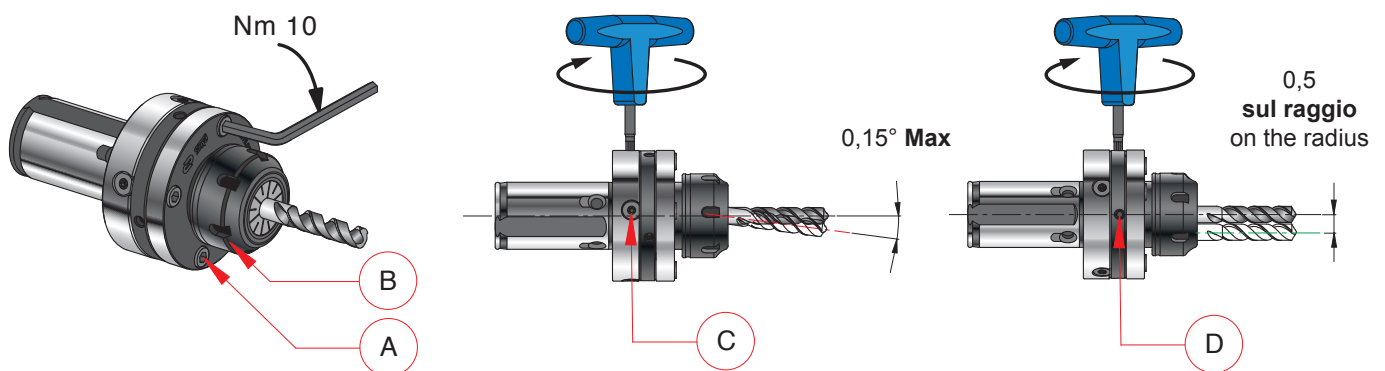

PER EFFETTUARE L'ALLINEAMENTO DELL'UTENSILE AGIRE NEL SEGUENTE MODO:

- 1) Il mandrino viene fornito standard con le viti (A) già preregistrate a 10Nm
- 2) Bloccare l'utensile e la pinza agendo sulla ghiera (B)
- 3) Agire sulle viti con cuneo (C) per l'allineamento assiale dell'utensile
- 4) Agire sulle viti (D) per portare in centro l'utensile

IN ORDER TO ALIGN THE TOOL, FOLLOW THE INSTRUCTIONS BELOW:

- 1) The arbor is supplied in the standard version with preadjusted screws (A) (10Nm)
- 2) Fasten tool and collet by turning the ring nut (B)
- 3) Turn the wedge screws (C) to obtain the axial alignment of the tool.
- 4) Turn the screws (D) to center the tool.

UM DAS WERKZEUG EINZUSTELLEN, GEHEN SIE WIE FOLGT VOR:

- 1) Die Aufnahme wird in der Standardausführung mit voreingestellten Schrauben (A) geliefert (10Nm)
- 2) Werkzeug und Spannzange Durch drehen der Nutmutter (B) festklemmen.
- 3) Die Keilschrauben (C) betätigen, um das Werkzeug axial einzustellen.
- 4) Die Schrauben (D) betätigen, um das Werkzeug zu zentrieren.

POUR EFFECTUER L'ALIGNEMENT DE L'OUTIL, SUIVRE LES INDICATIONS CI-DESSOUS:

- 1) Le mandrin est fourni standard avec le visse (A) déjà preenregistree a 10Nm
- 2) Bloquer l'outil et la pince à l'aide de la frette (B)
- 3) Tourner les visse avec coin (C) pour l'alignement axial de l'outil.
- 4) Tourner les visse (D) pour porter l'outil au centre.

ART. 356..

ER-DIN 6499

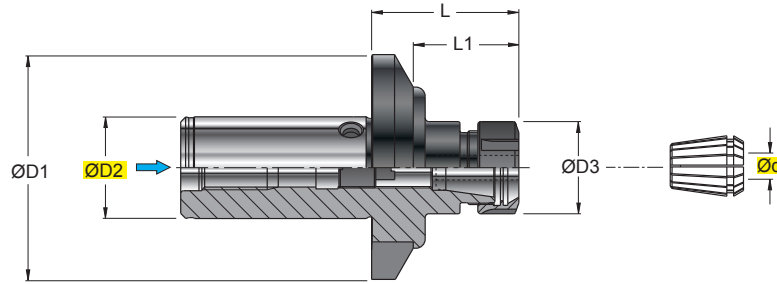

PORTAPINZA
COLLET HOLDER
FRÄSERSPANFUTTER
MANDRIN À PINCES

ART.	(mm)												
	ØD2	Ød	ØD1	ØD3	L	L1							
356.063.025.016	32	0,5-16	63	42	42	34	--.025.--	RGS ER25	GRF 18		925.040		
356.063.032.020	32	2-20	63	50	42	38	--.032.--	RGS ER32	GRF 22		925.052		
356.080.025.016	40	0,5-16	78	42	50	34	--.025.--	RGS ER25	GRF 18		925.040		
356.080.032.020	40	2-20	78	50	50	38	--.032.--	RGS ER32	GRF 22		925.052		

ART. 357..

ER-DIN 6499

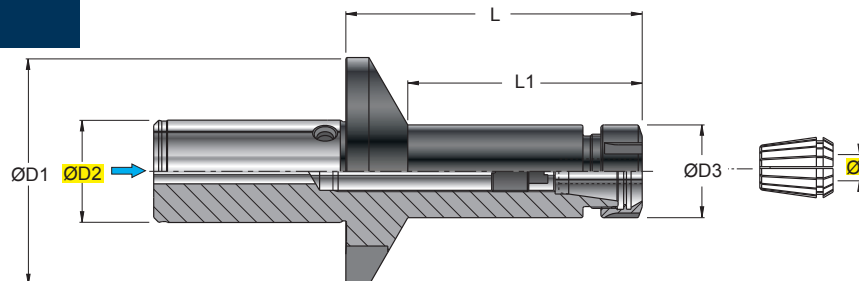

PORTAPINZA PROLUNGATO
EXTENDED ADAPTER FOR COLLET CHUCKS
AUFNAHMEVERLÄNGERUNG FÜR SPANNZANGEN
MANDRIN À PINCES RALLONGÉE

ART.	(mm)												
	ØD2	Ød	ØD1	ØD3	L	L1							
357.063.016.010	32	0,5-10	63	32	100	86	--.016.--	RGS ER16	GRF 10		925.022		
357.063.025.016	32	0,5-16	63	42	100	90	--.025.--	RGS ER25	GRF 18		925.040		
357.080.025.016	40	0,5-16	78	42	125	110	--.025.--	RGS ER25	GRF 18		925.040		
357.080.032.020	40	2-20	78	50	125	113	--.032.--	RGS ER32	GRF 22		925.052		

ART. 375..

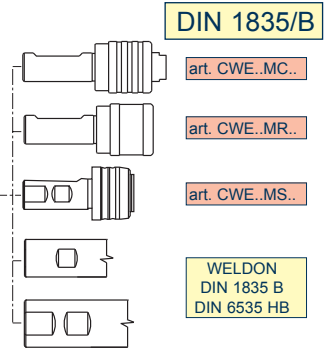
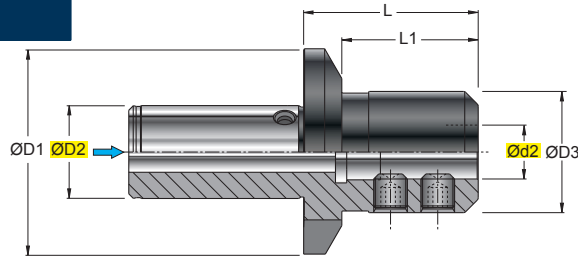

PORTAFRESA CON ATTACCO TIPO WELDON
 END MILL HOLDERS WELDON TYPE
 FRÄSERAUFNAHME MIT WELDON
 MANDRIN PORTE-FRAISE AVEC ATTACHEMENT WELDON

ART.	(mm)						GR	R	L
	ØD2	Ød2	ØD1	ØD3	L	L1			
375.063.016.000	32	16	63	48	36	28	GR 14		5006
375.063.020.000	32	20	63	50	36	29	GR 16		5008
375.063.025.000	32	25	63	50	40	33	GR 1814		5008
375.080.016.000	40	16	78	48	40	26	GR 14		5006
375.080.020.000	40	20	78	52	40	27	GR 16		5008
375.080.025.000	40	25	78	65	60	50	GR 18		5008
375.080.032.000	40	32	78	70	70	62	GR 20		5010

ART. 385..W

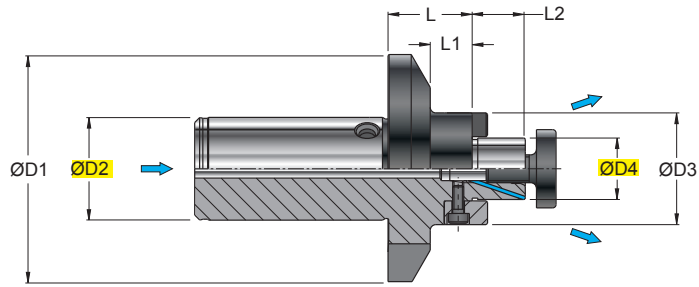
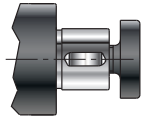

PORTAFRESA COMBINATO A TRASCINAMENTO FRONTALE E FORI PER REFRIGERAZIONE
COMBINED SHELL-END MILL HOLDERS WITH COOLANT BORES
FRÄSERAUFNAHME MIT QUERNUT UND KÜHLMITTELBOHRUNGEN
MANDRIN PORTE FRAISE COMBINÉ À ENTRAÎNEMENT FRONTAL AVEC LUBRIFICATION

(mm)														
ART.	ØD2	ØD4	ØD1	ØD3	L	L1	L2							
385.063.016.017W	32	16	63	32	20	10	17	CHF 16	VBC02	422.016..	CT0410		5025	423.016..
385.063.022.019W	32	22	63	48	20	12	19	CHF 22	VBC04	422.022..	CT0612		5003	423.022..
385.063.027.021W	32	27	63	58	20	15	21	CHF 27	VBC05	422.027..	CT0715		5004	423.027..
385.063.032.024W	32	32	63	70	20	15	24	CHF 32	VBC06	422.032..	CT0820		5005	423.032..
385.080.022.019W	40	22	78	48	25	10	19	CHF 22	VBC04	422.022..	CT0612		5003	423.022..
385.080.027.021W	40	27	78	58	25	13	21	CHF 27	VBC05	422.027..	CT0715		5004	423.027..
385.080.032.024W	40	32	78	70	25	16	24	CHF 32	VBC06	422.032..	CT0820		5005	423.032..
385.080.040.027W	40	40	78	83	25	16	27	CHF 40L	VBC06	422.040..	CT1020		5005	423.040..

ART. 386..W

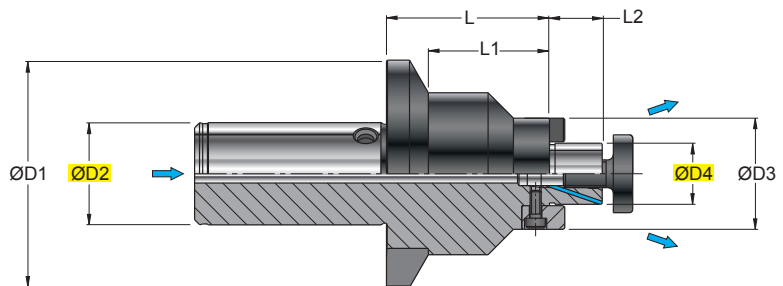
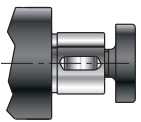

PORTAFRESA LUNGO COMBINATO A TRASCINAMENTO FRONTALE E FORI PER REFRIGERAZIONE
COMBINED SHELL END MILL HOLDERS WITH COOLANT BORES LONG-TYPE
KOMBI-AUFNAHME MIT QUERNUT UND KÜHLMITTELBOHRUNGLANGE ASFÜHRUNG
MANDRIN COMBINÉ À ENTRAÎNEMENT FRONTAL AVEC LUBRIFICATION SERIE-LONGUE

(mm)														
ART.	ØD2	ØD4	ØD1	ØD3	L	L1	L2							
LUNGI - LONGS														
386.063.022.019W	32	22	63	48	63	55	19	CHF 22	VBC04	422.022..	CT0612		5003	423.022..
386.063.027.021W	32	27	63	58	63	57	21	CHF 27	VBC05	422.027..	CT0715		5004	423.027..
386.080.022.019W	40	22	78	48	80	67	19	CHF 22	VBC04	422.022..	CT0612		5003	423.022..
386.080.027.021W	40	27	78	58	80	68	21	CHF 27	VBC05	422.027..	CT0715		5004	423.027..
386.080.032.024W	40	32	78	70	80	72	24	CHF 32	VBC06	422.032..	CT0820		5005	423.032..

ART. 393..

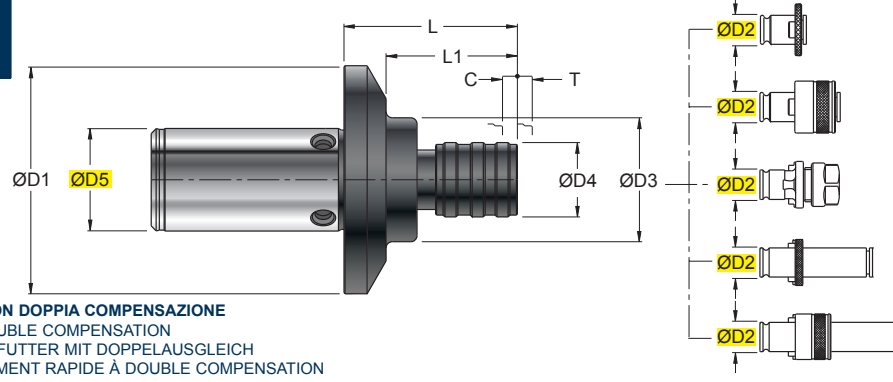

PORTAMASCHIO A CAMBIO RAPIDO CON DOPPIA COMPENSAZIONE
QUICK-CHANGE TAP HOLDER WITH DOUBLE COMPENSATION
GEWINDESCHNEID-SCHNELLWECHSELFUTTER MIT DOPPELAUSGLEICH
MANDRINS DE TARAUDAGE À CHANGEMENT RAPIDE À DOUBLE COMPENSATION

ART.	(mm)										Campo di maschiatura Tap range			
	ØD1	ØD2	ØD3	ØD4	ØD5	L	L1	C	T					
393.063.019.012	63	19	36	38	32	53	41	9	9	M3-M12				
393.063.031.020	63	31	36	55	32	76	64	15	15	M8-M24				
393.080.019.012	78	19	36	38	40	53	41	9	9	M3-M12				
393.080.031.024	78	31	49	55	40	76	64	15	15	M8-M30				

ART. 498..

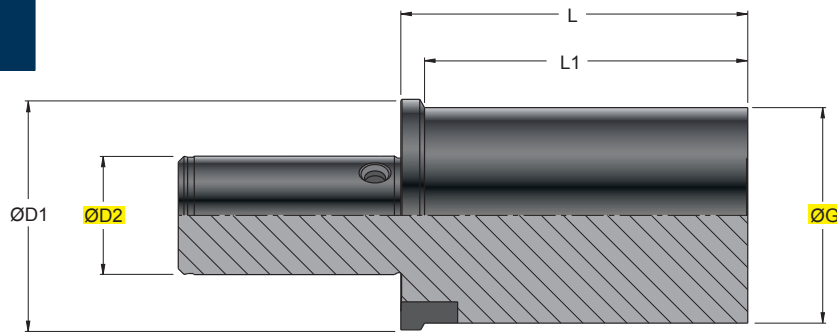

BARRA A STELO TENERO
BORING BAR BLANK
STANGE MIT WEICHEM SCHAFT
BARRE AVEC BOUT DOUX

ART.	(mm)									
	ØD2	ØG	ØD1	L	L1					
498.063.063.225	32	63	63	236	225					
498.063.078.200	32	78	63	211	200					
498.063.098.200	32	98	63	211	200					
498.080.078.250	40	78	78	263	250					
498.080.098.225	40	98	78	238	225					
498.080.123.200	40	123	78	213	200					

ART. RDU..Q..

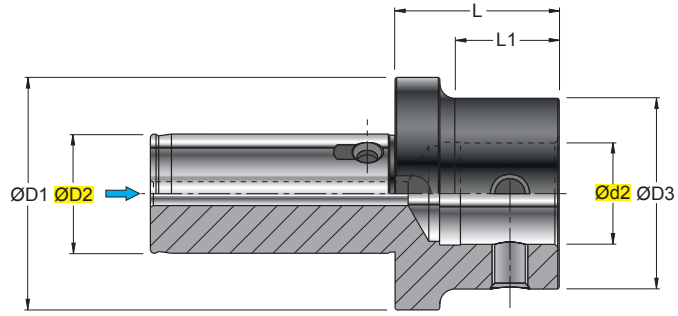

RIDUZIONE S.A.U./NIKKEN
 REDUCTION S.A.U./NIKKEN
 REDUZIERUNGEN S.A.U./NIKKEN
 RÉDUCTION S.A.U./NIKKEN

ART.	(mm)						GR	5005	5006	5008
	ØD2	Ød2	ØD1	ØD3	L	L1				
RDU.063.050.Q26	32	26	63	50	45	25	GR10Q26			
RDU.063.064.Q34	32	34	63	64	55	40	GR12Q34			
RDU.063.083.Q42	32	42	63	83	60	45	GR16Q42			
RDU.080.050.Q26	40	26	78	50	45	20	GR10Q26			
RDU.080.064.Q34	40	34	78	64	55	35	GR12Q34			
RDU.080.083.Q42	40	42	78	83	60	45	GR16Q42			

396		Pag. 900	399		Pag. 902	399/SP		Pag. 903	289...012W		Pag. 905
											$\varnothing D = 39,6 - 99,9$
396..	216...				399.063... 399.080...		399/SP...		289.012W		
											CNMA CNMG CNMM 1204
602		Pag. 901	603		Pag. 901	288...W		Pag. 903	289...S12W		Pag. 905
$\varnothing D = 13 - 24,9$			$\varnothing D = 5,8 - 41$								$\varnothing D = 39,6 - 99,9$
602.016.006	CC.. 0602		603.160.W02 603.160.C06	WC.. 0202 CC.. 0602		288.032.006W 288.032.009W		CC.. 0602 09T3	289.S012W		SNMA SNMG SNMM 1204
						289...PW		Pag. 904	289...CA.W		Pag. 906
											$\varnothing D = 79,5 - 159,9$
						289.009PW 289.012PW		CC.. 09T3 1204	289.CA.W	..12CA-..L ..16CA-..L	
						289...S...PW		Pag. 904	290...		Pag. 906
											$\varnothing D = 26,0 - 159,9$
						289.S09PW 289.S12PW		SC.. 09T3 1204	290...	L348C.31.0602 L348C.32. L348C.33. L348C.34.	

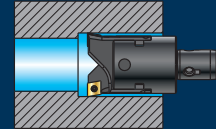
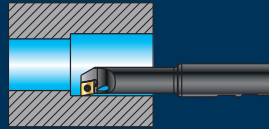
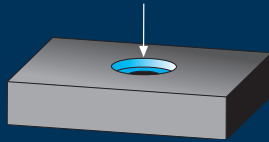

MNL..CA		Pag. 907	BLM...075...W		Pag. 908	BLS W ... 2T		Pag. 912	
	$\varnothing D = 160 - 300$	 .. 12CA..L .. 16CA..L	$\varnothing D = 30 - 210$		TC.. 16T3 CC.. 06-09 SC.. 1204 CA.. 75	$\varnothing D = 150 - 550$			
	MNL...CA		BLM...75°						
							.. 20CA..L		
MNL..UM		Pag. 907	BLM...090...W		Pag. 909	BLF W ... 2T		Pag. 913	
	$\varnothing D = 160 - 300$	 L348C.34.09T3 L348C.34.16T3	$\varnothing D = 30 - 210$		TC.. 16T3 CC.. 06-09-12 CA.. 90	$\varnothing D = 150 - 550$			
	MNL...UM		BLM...90°						
							L348C.33.09T3 L348C.33.1102		
			BLT...075...W		Pag. 910				
			$\varnothing D = 40 - 162$		TC.. 16T3 CC.. 09T3 SC.. 1204 CA.. 75				
			NEW			BLT...75°			
			BLT...090...W		Pag. 911				
			$\varnothing D = 40 - 162$		TC.. 16T3 CC.. 09-12 CA.. 90				
			NEW			BLT...90°			

396 ...

REGOLAZIONE RADIALE
RADIAL ADJUSTMENT

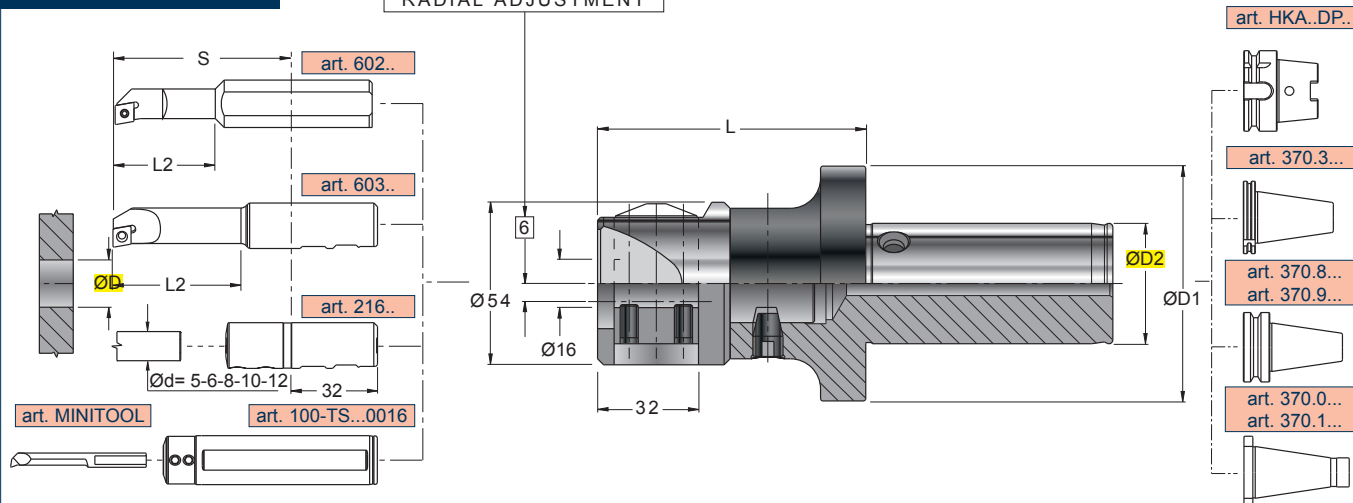

ART.	(mm)			kg	Icon 1	Icon 2	Icon 3	Icon 4	Icon 5	Icon 6	Icon 7	Icon 8	ØD	S	L2
	ØD2	ØD1	L												
396.063.026.016	32	63	89	1,76	395.026.016.000	RDU.063.050.Q26	GR10Q26	5025	5003	5005	603.050.160.W02	5,8-16	40	16	
											603.060.160.W02	7,8-18	41	26	
											603.080.160.C06	10-20	51	35	
											603.125.160.C06	15-25	61	45	
											603.170.160.C06	20-30	66	65	
											603.220.160.C06	25-35	71	70	
											603.270.160.C06	30-40	71	70	
											603.320.160.C06	35-45	71	70	
											602.016.010.006	13-23	68	36	
											602.016.012.006	16-26	80	40	
											602.016.016.006	20-30	93	45	
396.080.026.016	40	78	89	2,38	395.026.016.000	RDU.080.050.Q26	GR10Q26	5025	5003	5005	603.050.160.W02	5,8-16	40	16	
											603.060.160.W02	7,8-18	41	26	
											603.080.160.C06	10-20	51	35	
											603.125.160.C06	15-25	61	45	
											603.170.160.C06	20-30	66	65	
											603.220.160.C06	25-35	71	70	
											603.270.160.C06	30-40	71	70	
											603.320.160.C06	35-45	71	70	
											602.016.010.006	13-23	68	36	
											602.016.012.006	16-26	80	40	
											602.016.016.006	20-30	93	45	

- NOTA: ART. 602 PAG. 901 / 603 PAG. 901 / 216 PAG. 1066 DA ORDINARSI A PARTE
- NOTE: ART. 602 PAG. 901 / 603 PAG. 901 / 216 PAG. 1066 MUST BE ORDERED SEPARATELY
- ANMERKUNG: ART. 602 PAG. 901 / 603 PAG. 901 / 216 PAG. 1066 SIND SEPARAT ZU BESTELLEN
- NOTE: ART. 602 PAG. 901 / 603 PAG. 901 / 216 PAG. 1066 À COMMANDER À PART

- ANELLO DI REGISTRAZIONE GRADUATO CON PASSO DI 0,01 mm SUL DIAMETRO
- MINIMA REGOLAZIONE POSSIBILE CON NONIO 0,005 mm SUL DIAMETRO
- GRADUATED ADJUSTMENT RING WITH PITCH OF 0.01mm ON DIAMETER
- MINIMUM ADJUSTMENT POSSIBLE WITH 0,005 mm.NONIUS ON DIAMETER
- SKALENRING ZUR EINSTELLUNG MIT 0,01mm-ABSTAND AM DURCHMESSER
- MÖGLICHE KLEINSTE EINSTELLUNG MIT NONIUS 0,005mm AM DURCHMESSER
- BAGUE D'ENREGISTREMENT GRADUÉE AVEC PAS DE 0,01 mm SUR LE DIAMÈTRE
- MINIMUM RÉGLAGE POSSIBLE AVEC NONIUS 0,005 mm SUR LE DIAMÈTRE

602 ...

Ø 13-24,9

CC.. 0602

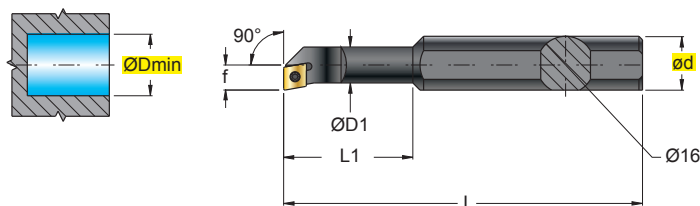

INSERTI - INSERTS
PAG. 935

(mm)

ART.	ØDmin	Ød	ØD1	L	L1	f	kg	Nm			
602.016.010.006	13	16	10	100	36	6,5	0,15	1,0±1,2	0602	12254P	5507P
602.016.012.006	16	16	12	112	40	8,0	0,15	1,0±1,2			
602.016.016.006	20	16	16	125	45	10,0	0,16	1,0±1,2			

603 ...

Ø 5,8-41

WC.. 0201



CC.. 0602

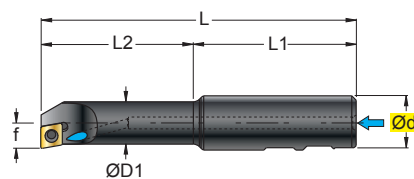
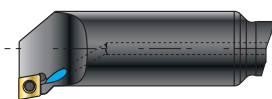
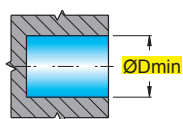

INSERTI - INSERTS
PAG. 939/935

(mm)

ART.	ØDmin	Ød	ØD1	L	L1	L2	f	kg	Nm				
603.050.160.W02	5,8	16	5	72	56	16	2,9	0,08	0,5±0,6	0201	-	12203	5506
603.060.160.W02	7,8	16	6	73	47	26	3,9	0,08	0,5±0,6				
603.080.160.C06	10	16	8	83	48	35	5	0,08	1,0±1,2	-	0602	12254P	5507P
603.125.160.C06	15	16	12,5	93	48	45	7,5	0,10	1,0±1,2				
603.170.160.C06	20	16	16	98	33	65	10	0,13	1,1±1,3	-	0602	12256P	5508P
603.220.160.C06	25	16	20	103	33	70	12,5	0,19	1,1±1,3				
603.270.160.C06	30	16	22	103	33	70	15	0,22	1,1±1,3				
603.320.160.C06	35	16	25	103	33	70	17,5	0,26	1,1±1,3				

399... W

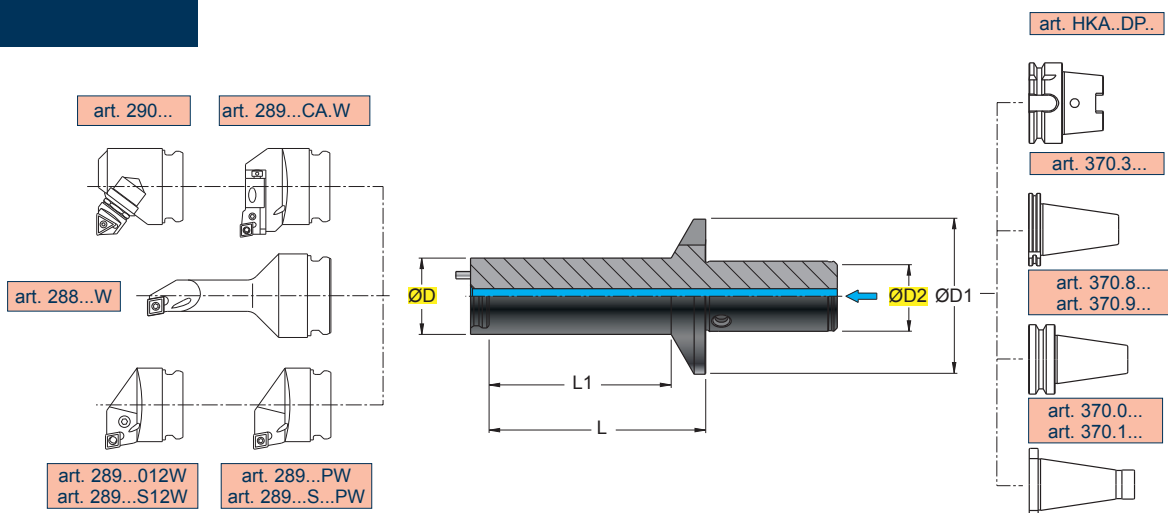

ART.	(mm)					kg					
	ØD2	ØD	ØD1	L	L1						
399.063.020.060W	32	20	63	52	35	0,79	---.020.---	477.020	GRT 14	5025	903.004.014.000
399.063.020.090W	32	20	63	82	65	0,85	---.020.---				
399.063.020.140W	32	20	63	131	115	0,96	---.020.---				
399.063.025.075W	32	25	63	62	46	0,87	---.025.---	477.025	GRT 18	5003	903.005.018.000
399.063.025.100W	32	25	63	87	72	0,96	---.025.---				
399.063.025.160W	32	25	63	146	132	1,17	---.025.---				
399.063.032.000W	32	32	63	32	19	0,79	---.032.---	477.032	GRT 22	5004	903.005.018.000
399.063.032.112W	32	32	63	91	78	1,15	---.032.---				
399.063.032.180W	32	32	63	158	146	1,55	---.032.---				
399.063.040.125W	32	40	63	96	85	1,48	---.040.---	477.040	GRT 32	5005	903.006.020.000
399.063.040.200W	32	40	63	171	160	2,20	---.040.---				
399.063.050.125W	32	50	63	83	75	1,73	---.050.---	477.050	GRT 40	5006	903.006.020.000
399.063.050.200W	32	50	63	158	150	2,88	---.050.---				
399.063.063.125W	32	63	63	66	-	2,08	---.063.---	477.063	GRT 63	5008	903.008.022.000
399.063.063.200W	32	63	63	141	-	3,89	---.063.---				
399.063.080.125W	32	80	63	49	-	2,32	---.080.---	477.080	GRT 80	5010	903.008.022.000
399.080.020.060W	40	20	80	59	34	1,50	---.020.---	477.020	GRT 14	5025	903.004.014.000
399.080.020.090W	40	20	80	88	65	1,56	---.020.---				
399.080.020.140W	40	20	80	137	115	1,66	---.020.---				
399.080.025.075W	40	25	80	68	45	1,57	---.025.---	477.025	GRT 18	5003	903.005.018.000
399.080.025.100W	40	25	80	93	72	1,67	---.025.---				
399.080.025.160W	40	25	80	153	132	1,90	---.025.---				
399.080.032.000W	40	32	80	32	12	1,48	---.032.---	477.032	GRT 22	5004	903.005.018.000
399.080.032.112W	40	32	80	98	78	1,87	---.032.---				
399.080.032.180W	40	32	80	166	146	2,23	---.032.---				
399.080.040.125W	40	40	80	102	85	2,17	---.040.---	477.040	GRT 32	5005	903.006.020.000
399.080.040.200W	40	40	80	177	160	2,90	---.040.---				
399.080.050.140W	40	50	80	105	90	2,71	---.050.---	477.050	GRT 40	5006	903.006.020.000
399.080.050.225W	40	50	80	190	175	4,02	---.050.---				
399.080.063.140W	40	63	80	88	77	3,11	---.063.---	477.063	GRT 63	5008	903.008.022.000
399.080.063.225W	40	63	80	173	162	5,17	---.063.---				
399.080.080.140W	40	80	80	60	-	3,44	---.080.---	477.080	GRT 80	5010	903.008.022.000
399.080.080.225W	40	80	80	151	-	6,73	---.080.---				

399/SP ... W

Ø 25-50

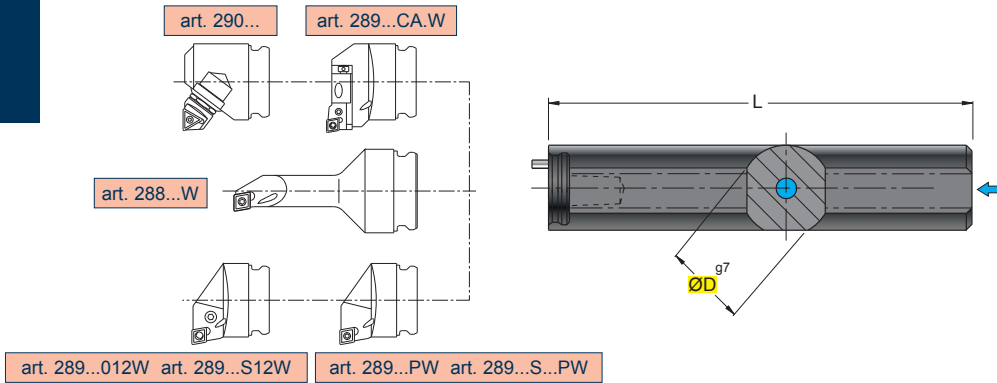

ART.	(mm)		kg					
	ØD	L						
399/SP.025.018W	25	200	0,71	---.025.---	477.025.000.000	GRT 18	5003	903.005.018.000
399/SP.032.022W	32	250	1,51	---.032.---	477.032.000.000	GRT 22	5004	903.005.018.000
399/SP.040.028W	40	300	2,86	---.040.---	477.040.000.000	GRT 32	5005	903.006.020.000
399/SP.050.036W	50	350	5,26	---.050.---	477.050.000.000	GRT 40	5006	903.006.020.000

288 ... W

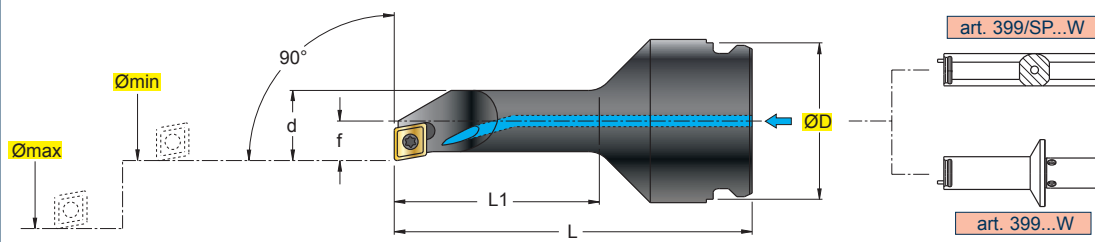

CC.. 0602	
CC.. 09T3	
INSERTI - INSERTS PAG. 935	

ART.	(mm)							kg	Nm				
	Ømin-max	ØD	d	L	L1	f							
288.032.012.006W	15,8-19,9	32	14,0	70	40	8,0	0,14	1,1+1,3	---.032.---	0602	12256P	5508P	901.006.020.010
288.032.016.006W	19,8-24,9	32	18,0	78	50	10,0	0,18	1,1+1,3	---.032.---				
288.032.020.009W	24,8-31,9	32	22,5	88	63	12,5	0,23	3,8+5,0	---.032.---	09T3	12409P	5515P	901.006.020.010

289 ... PW

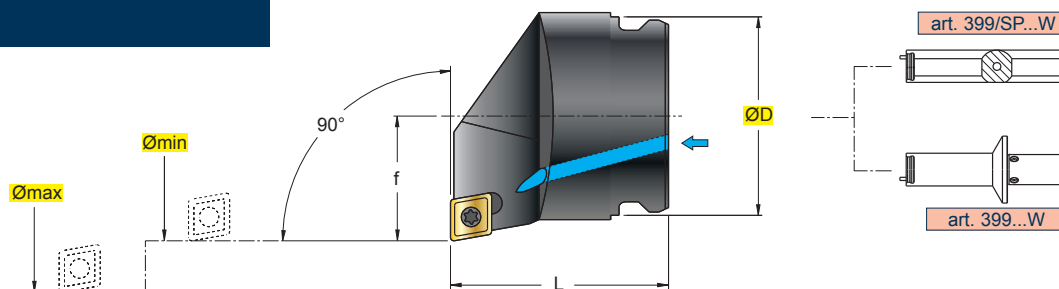

CC.. 09T3



CC.. 1204



INSERTI - INSERTS
PAG. 935

ART.	(mm)		L	f	kg	Nm									
	Ømin-max	ØD													
289.020.014.009PW	24,8-31,9	20	25	14	0,04	3,8+5,0	---	020---	09T3	-	-	-	12409P	5515P	901.004.012.000
289.025.018.009PW	31,7-39,9	25	28	18	0,06	3,8+5,0	---	025---	09T3	-	-	-	1240P	5515P	901.006.016.010
289.032.022.009PW	39,6-49,9	32	34	22	0,13	3,8+5,0	---	032---	09T3	-	-	-	1240P	5515P	901.006.020.010
289.032.022.012PW	39,6-49,9	32	34	22	0,13	4,0+5,0	---	032---	1204	3611	BCL15	5045	124510	5520	901.006.020.010
289.040.028.012PW	49,6-62,9	40	40	28	0,23	4,0+5,0	---	040---	1204	3611	BCL15	5045	124510	5520	901.006.025.010
289.050.036.012PW	62,5-79,9	50	50	36	0,50	4,0+5,0	---	050---	1204	3611	BCL15	5045	124510	5520	901.006.030.010
289.063.045.012PW	79,5-99,9	63	63	45	0,95	4,0+5,0	---	063---							

289 ... S ...PW

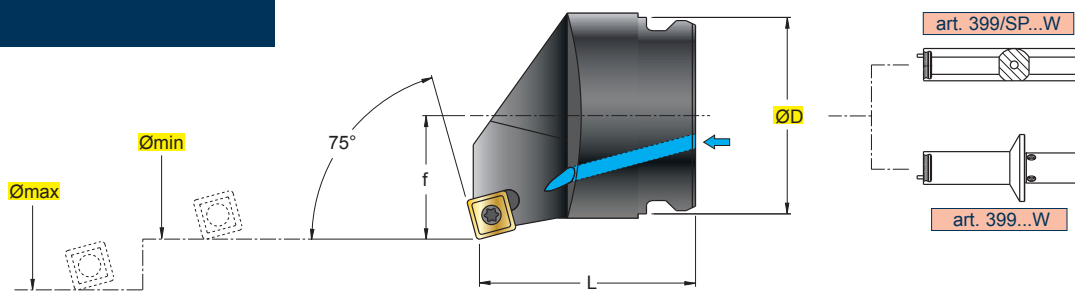

SC.. 09T3



SC.. 1204



INSERTI - INSERTS
PAG. 937

ART.	(mm)		L	f	kg	Nm									
	Ømin-max	ØD													
289.020.014.S09PW	24,8-31,9	20	25	14	0,04	3,8+5,0	---	020---	09T3	-	-	-	12409P	5515P	901.004.012.000
289.025.018.S09PW	31,7-39,9	25	28	18	0,06	3,8+5,0	---	025---	09T3	-	-	-	1240P	5515P	901.006.016.010
289.032.022.S09PW	39,6-49,9	32	34	22	0,14	3,8+5,0	---	032---	09T3	-	-	-	1240P	5515P	901.006.020.010
289.032.022.S12PW	39,6-49,9	32	34	22	0,14	4,0+5,0	---	032---	1204	3511	BCL15	5045	124510	5520	901.006.020.010
289.040.028.S12PW	49,6-62,9	40	40	28	0,24	4,0+5,0	---	040---	1204	3511	BCL15	5045	124510	5520	901.006.025.010
289.050.036.S12PW	62,5-79,9	50	50	36	0,51	4,0+5,0	---	050---	1204	3511	BCL15	5045	124510	5520	901.006.030.010
289.063.045.S12PW	79,5-99,9	63	63	45	0,99	4,0+5,0	---	063---							

289 ... 012W

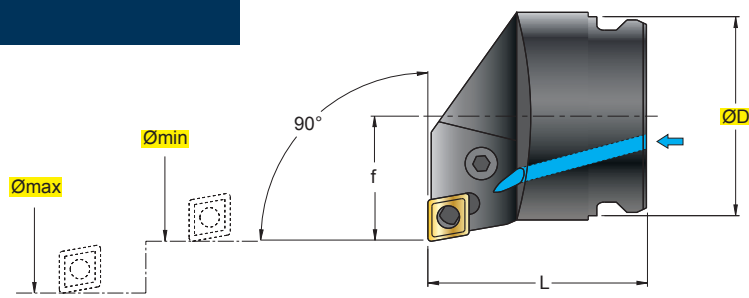

art. 399/SP...W

art. 399...W

CN.. 1204



INSERTI - INSERTS
 PAG. 193

ART.	(mm)		L	f	kg										
	Ømin-max	ØD													
289.032.022.012W	39,6-49,9	32	34	22	0,12	---	032---	1204	8012	1608	5003	3612	4112	901.006.020.010	0012
289.040.028.012W	49,6-62,9	40	40	28	0,24	---	040---	1204	8012	1608	5003	3612	4112	901.006.030.010	0012
289.050.036.012W	62,5-79,9	50	50	36	0,51	---	050---	1204	8012	1608	5003	3612	4112	901.006.030.010	0012
289.063.045.012W	79,5-99,9	63	63	45	1,01	---	063---	1204	8012	1608	5003	3612	4112	901.006.030.010	0012

289 ... S12W

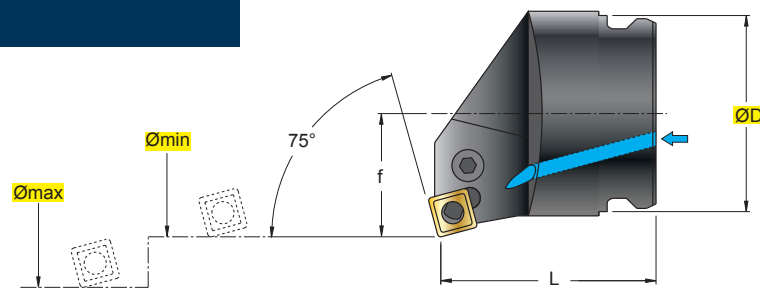

art. 399/SP...W

art. 399...W

SN.. 1204



INSERTI - INSERTS
 PAG. 196

ART.	(mm)		L	f	kg										
	Ømin-max	ØD													
289.032.022.S12W	39,6-49,9	32	34	22	0,13	---	032---	1204	8012	1608	5003	3512	4112	901.006.020.010	0012
289.040.028.S12W	49,6-62,9	40	40	28	0,25	---	040---	1204	8012	1608	5003	3512	4112	901.006.025.010	0012
289.050.036.S12W	62,5-79,9	50	50	36	0,53	---	050---	1204	8012	1608	5003	3512	4112	901.006.030.010	0012
289.063.045.S12W	79,5-99,9	63	63	45	1,02	---	063---	1204	8012	1608	5003	3512	4112	901.006.030.010	0012

289CA.W

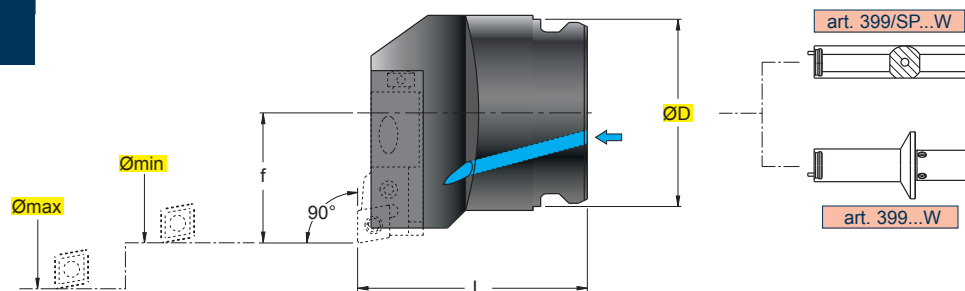

ART.	(mm)					kg				
	Ømin-max	ØD	L	f						
289.063.045.CA.W	79,5-99,9	63	63	46	0,80	----.063----	901.006.030.010	RD12	...L 12CA-...	...L 16CA-...
289.063.056.CA.W	99,4-129,9	63	70	57	1,02	----.063----	901.006.030.010	RD12	...L 12CA-...	...L 16CA-...
289.080.056.CA.W	99,4-129,9	80	80	57	1,87	----.080----	901.008.040.012	RD12	...L 12CA-...	...L 16CA-...
289.080.072.CA.W	129,4-159,9	80	80	73	1,98	----.080----	901.008.040.012	RD12	...L 12CA-...	...L 16CA-...

CARTUCCE ..12CA-../..16CA-.. DA ORDINARSI A PARTE : PAG. 918 / 927 - PER MONTARE LE CARTUCCE ..12CA-.. ORDINARE L'ADATTATORE RD12
 CARTRIDGES ..12CA-../..16CA-.. TO BE ORDERED SEPARATELY : PAG. 918 / 927 - ORDER ADAPTER RD12 TO FIT CARTRIDGES ..12CA-..
 EINBAUHALTER ..12CA-../..16CA-.. (MÜSSEN SEPARAT BESTELLT WERDEN) : PAG. 918 / 927 - BESTELLEN SIE DEN ADAPTER RD12 UM DIE EINBAUHALTER ..12CA-.. EINZUSETZEN
 CARTOUCHES ..12CA-../..16CA-.. POUR COMMANDER À PART : PAG. 918 / 927 - POUR MONTER LES CARTUCHES ..12CA-.. COMMANDER L'ADAPTATEUR RD12

290. ..

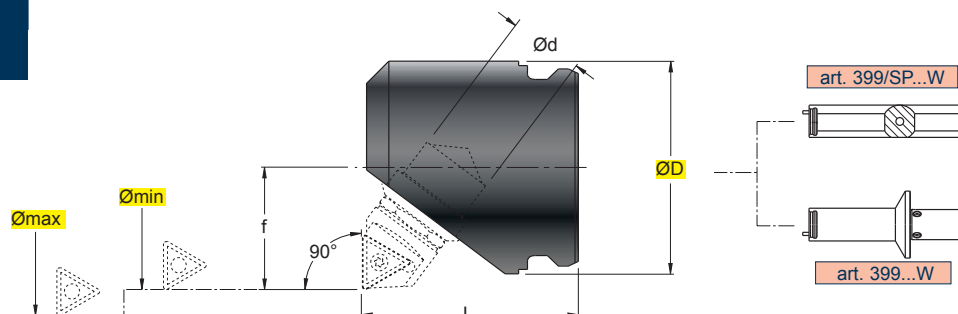

ART.	(mm)						kg			
	Ømin-max	ØD	Ød	L	f					
290.020.015.006	26-31,9	20	16	35	15	0,05	----.020----	901.004.012.000	L348C.31.0602	
290.025.018.006	31,7-39,9	25	16	36	18	0,09	----.025----	901.006.016.010	L348C.31.0602	
290.032.022.009	39,6-49,9	32	20	45	22	0,17	----.032----	901.006.020.010	L348C.32.0602 L348C.32.0902	
290.040.028.011	49,6-62,9	40	22	56	28	0,35	----.040----	901.006.025.010	L348C.33.1102 L348C.33.09T3	
290.050.036.011	62,5-79,9	50	22	56	36	0,68	----.050----	901.006.030.010	L348C.33.1102 L348C.33.09T3	
290.063.045.016	79,5-99,9	63	32	72	45	1,23	----.063----	901.006.030.010	L348C.34.09T3 L348C.34.16T3	
290.080.056.016	99,4-129,9	80	32	80	56	2,39	----.080----	901.008.040.012	L348C.34.09T3 L348C.34.16T3	
290.080.072.016	129,4-160	80	32	90	72	3,40	----.080----	901.008.040.012	L348C.34.09T3 L348C.34.16T3	

UNITÀ MICROREGISTRABILI DA ORDINARSI A PARTE : PAG. 928
 MICRO-BORING UNITS TO BE ORDERED SEPARATELY : PAG. 928
 FEINBOHRWERKZEUGE (MÜSSEN SEPARAT BESTELLT WERDEN) : PAG. 928
 UNITÉ MICRO METRIQUE POUR COMMANDER À PART : PAG. 928

MNL ... CA

SGROSSATURA
 ROUGHING
 SCHRUPPEN
 ÉBAUCHAGE

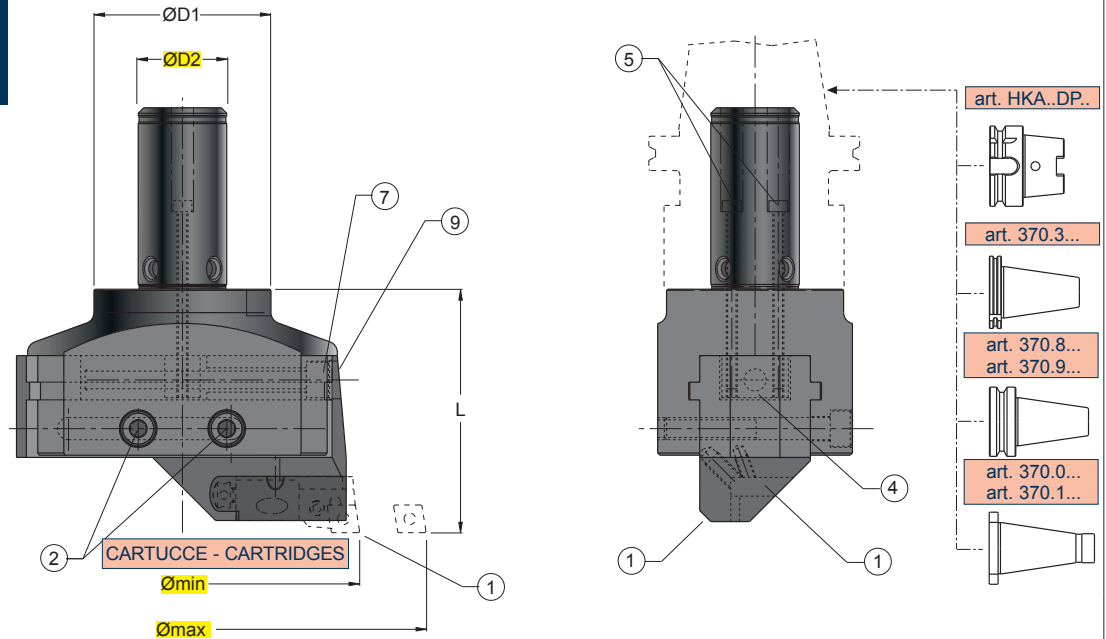

(mm)					1	2		4	5	7	9	10	11		
ART.	Ømin-max	ØD2	ØD1	L	kg										
MNL.160.080.CA	160-220	40	80	110	6,51	BRA.160.CA	VBL10L	5008	BRA.BLO.10	VBL5L	5004	VBTF10	5008	SG161	RD12 ..L 12/16CA..
MNL.220.080.CA	220-300	40	80	110	7,38	BRA.220.CA	VBL10L	5008	BRA.BLO.10	VBL5L	5004	VBTF10L	5008	SG161	RD12 ..L 12/16CA..

CARTUCCE ..12CA-../..16CA-... DA ORDINARSI A PARTE : PAG. 918 / 927 - PER MONTARE LE CARTUCCE ..12CA-... ORDINARE L'ADATTATORE RD12
 CARTRIDGES ..12CA-../..16CA-... TO BE ORDERED SEPARATELY : PAG. 918 / 927 - ORDER ADAPTER RD12 TO FIT CARTRIDGES ..12CA-...
 EINBAUHALTER ..12CA-../..16CA-... (MÜSSEN SEPARAT BESTELLT WERDEN) : PAG. 918 / 927 - BESTELLEN SIE DEN ADAPTER RD12 UM DIE EINBAUHALTER ..12CA-... EINZUSETZEN
 CARTOUCHES ..12CA-../..16CA-... POUR COMMANDER À PART : PAG. 918 / 927 - POUR MONTER LES CARTUCHES ..12CA-... COMMANDER L'ADAPTATEUR RD12

MNL ... UM

FINITURA
 FINISHING
 SCHLICHTEN
 FINISSAGE

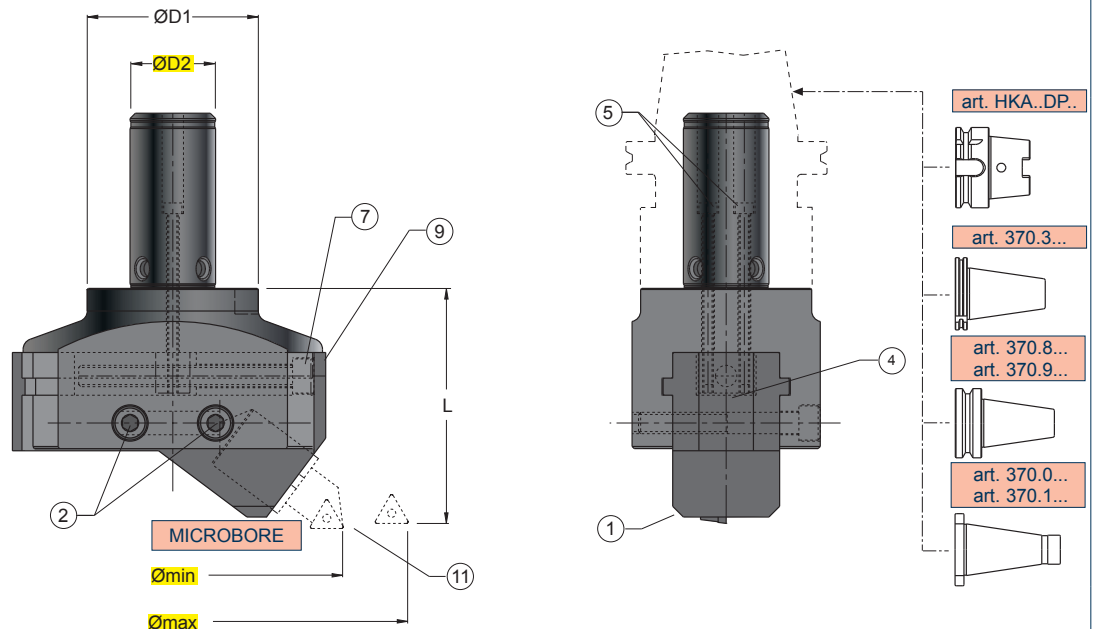

(mm)					1	2		4	5	7	9	10			
ART.	Ømin-max	ØD2	ØD1	L	kg										
MNL.160.080.UM	160-220	40	80	110	6,31	BRA.160.UM	VBL10L	5008	BRA.BLO.10	VBL5L	5004	VBTF10	5008	SG161	L348C.34..
MNL.220.080.UM	220-300	40	80	110	7,59	BRA.220.UM	VBL10L	5008	BRA.BLO.10	VBL5L	5004	VBTF10L	5008	SG161	L348C.34..

UNITÀ MICROREGISTRABILI L348C.34. ... DA ORDINARSI A PARTE : PAG. 928
 MICRO-BORING UNITS L348C.34. ... TO BE ORDERED SEPARATELY : PAG. 928
 FEINBOHRWERKZEUGE L348C.34. ... (MÜSSEN SEPARAT BESTELLT WERDEN) : PAG. 928
 UNITÉ MICRO METRIQUE L348C.34. ... POUR COMMANDER À PART : PAG. 928

BLM .. 075 ..W

Ø 30-210

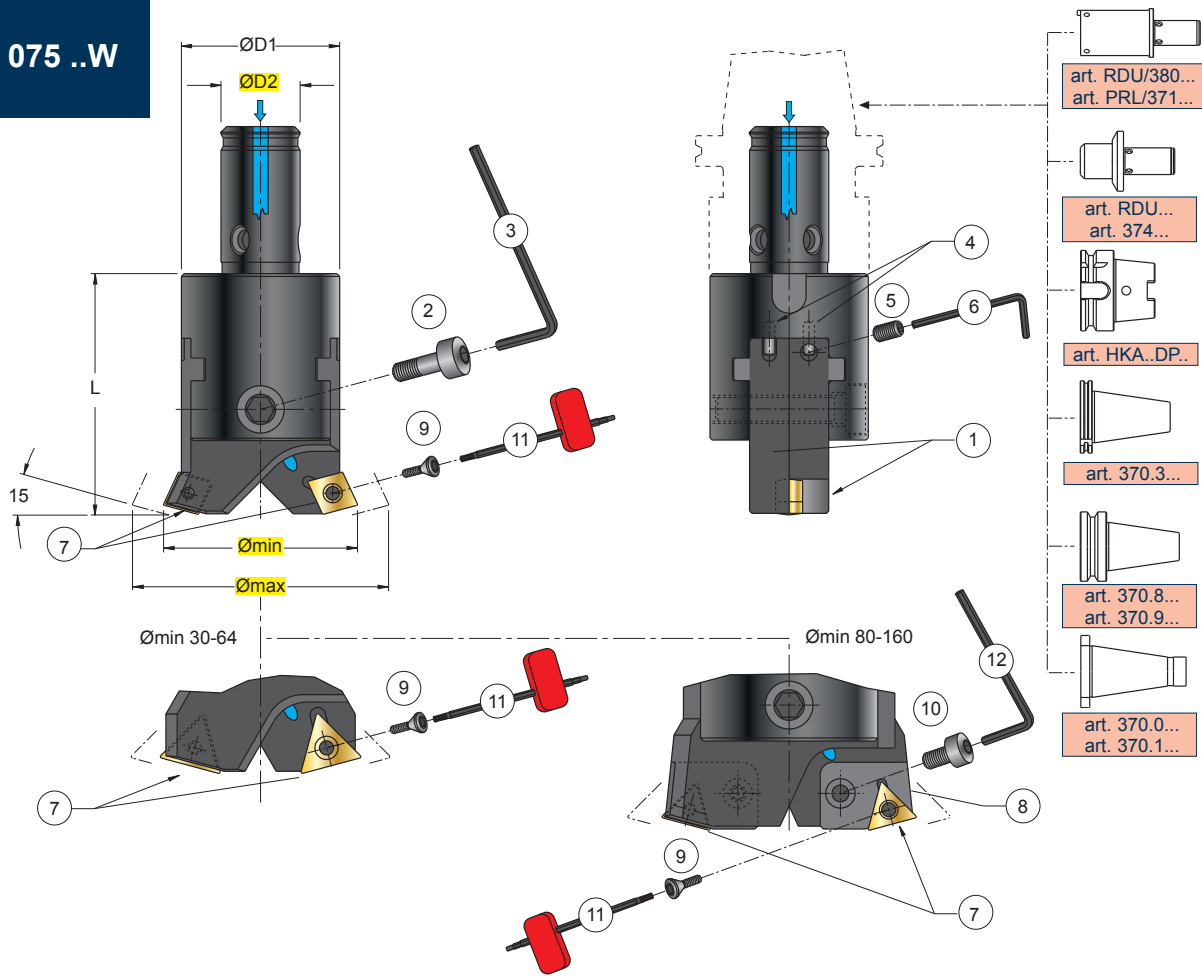

ART.	(mm)					kg	1	2	3	4	5	6	8	9	10	11	12	7
	Ømin-max	ØD2	ØD1	L	1		2	3	4	5	6	8	9	10	11	12	7	
BLM.030.075.C06W	30-41	14	27	42	0,15	LMA.030.075.C06W	VBL05	5004	3098	GRB3	5015	-	1225P	-	5507P	-	CC..06	
BLM.040.075.C09W	40-51	18	35	55	0,34	LMA.040.075.C09W	VBL06BL	5005	3098	GRB4C	5002	-	12409P	-	5515P	-	CC..09	
BLM.050.075.T16W	50-65	22	42	56	0,50	LMA.050.075.T16W	VBL06L	5005	3098	GRB4	5002	-	12409P	-	5515P	-	TC..16	
BLM.064.075.T16W	64-82	27	54	66	0,93	LMA.064.075.T16W	VBL08	5006	3098	GRB4L	5002	-	1240P	-	5515P	-		
BLM.080.075.CA1W	80-102	32	63	88	2,01	LMA.080.000.000W	VBL10C	5008	4158	901.006.040.010	5003	CA1-75	12409P	VBL6C	5515P	5005	SC..12	
BLM.100.075.CA1W	100-126	40	78	100	3,69	LMA.100.000.000W	VBL10	5008	4158	GRB6C	5003	CA1-75	12409P	VBL6C	5515P	5005	TC..16	
BLM.100.075.CA3W	100-126	40	78	100	3,69	LMA.100.000.000W	VBL10	5008	4158	GRB6C	5003	CA3-75	124510P	VBL6C	5520P	5005	SC..12	
BLM.125.075.CA1W	125-162	40	78	100	5,25	LMA.125.000.000W	VBL10L	5008	4158	GRB6	5003	CA1-75	12409P	VBL6C	5515P	5005	TC..16	
BLM.125.075.CA3W	125-162	40	78	100	5,25	LMA.125.000.000W	VBL10L	5008	4158	GRB6	5003	CA3-75	124510P	VBL6C	5520P	5005	SC..12	
BLM.160.075.CA1W	160-210	40	78	100	6,60	LMA.160.000.000W	VBL10L	5008	4158	GRB6L	5003	CA1-75	12409P	VBL6C	5515P	5005	TC..16	
BLM.160.075.CA3W	160-210	40	78	100	6,60	LMA.160.000.000W	VBL10L	5008	4158	GRB6L	5003	CA3-75	124510P	VBL6C	5520P	5005	SC..12	

CA ..-75



TC.. 16T3



SC.. 1204



CARTUCCE PER TESTA PER ALESARE BILAMA
 CARTRIDGES FOR TWIN CUTTER BORING HEADS
 EINBAUHALTER FÜR ZWEISCHNEIDEN-AUSDREHKOPF
 CARTOUCHES POUR TÊTE D'ALÉSAGE DOUBLE TRANCHANT

INSERTI - INSERTS
 PAG. 938 / 937

ART.	(mm)			kg	Nm	TC	SC	1	2	3	4	5	6	8	9	10	11	12				
	f	h	L																			
CA1-75	16,47	12,27	30	0,035	3,8±5,0	16T3	-	12409P	5515P											VBL06C	5005	
CA3-75	16,47	12,27	30	0,035	4,0±5,0	-	1204	124510P	5520P												VBL06C	5005

BLM .. 090 ..W

Ø 30-210

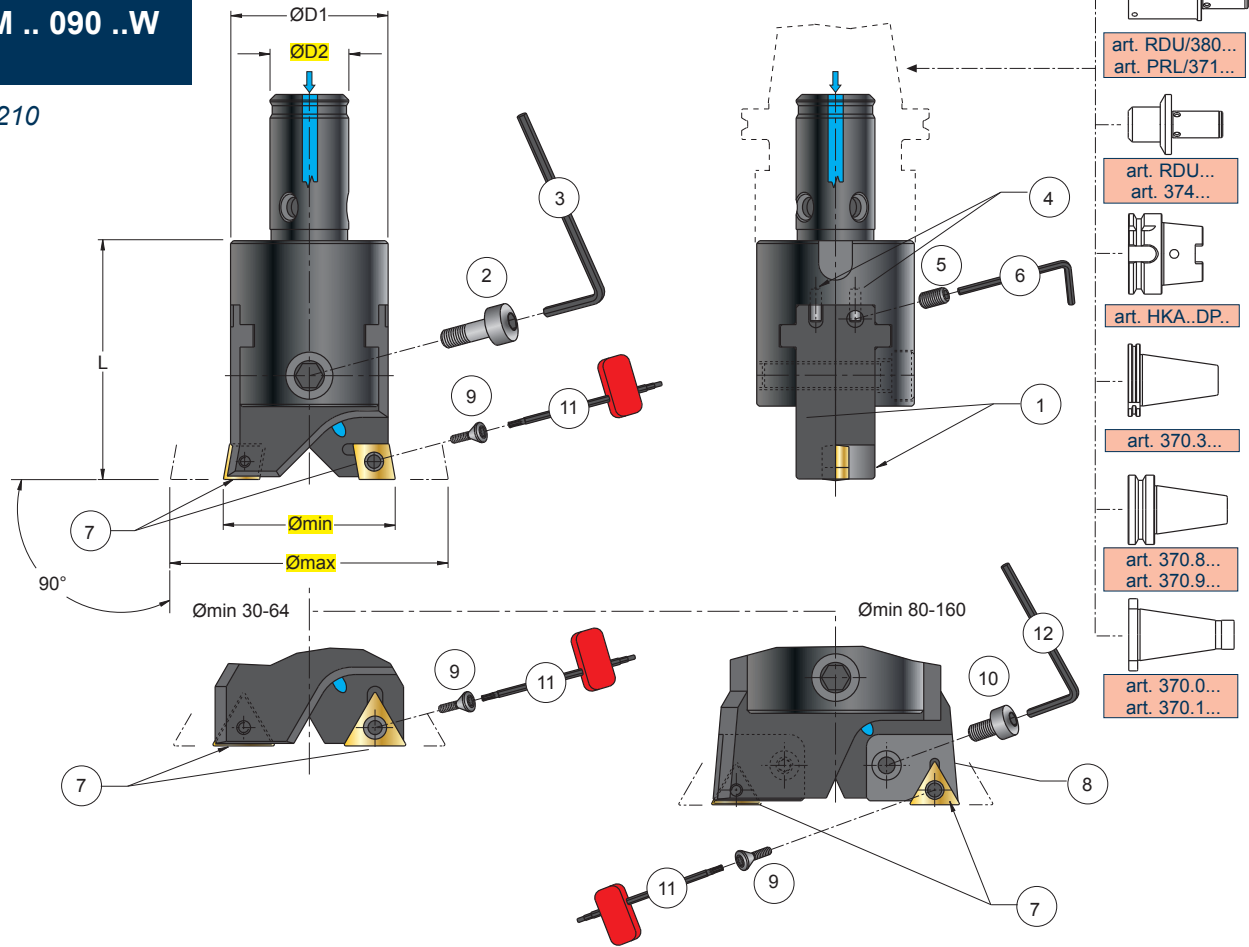

(mm)						1	2	3	4	5	6	8	9	10	11	12	7	
ART.	Ømin-max	ØD2	ØD1	L	kg													
BLM.030.090.C06W	30-41	14	27	42	0,15	LMA.030.090.C06W	VBL05	5004	3098	GRB3	5015	-	1225P	-	5507P	-	CC..06	
BLM.040.090.C09W	40-51	18	35	55	0,34	LMA.040.090.C09W	VBL06BL	5005	3098	GRB4C	5002	-	12409P	-	5515P	-	CC..09	
BLM.050.090.T16W	50-65	22	42	56	0,50	LMA.050.090.T16W	VBL06L	5005	3098	GRB4	5002	-	12409P	-	5515P	-	TC..16	
BLM.064.090.T16W	64-82	27	54	66	0,93	LMA.064.090.T16W	VBL08	5006	3098	GRB4L	5002	-	1240P	-	5515P	-		
BLM.080.090.CA1W	80-102	32	63	88	2,01	LMA.080.090.CA1W	VBL10C	5008	4158	901.006 040.010	5003	CA1-90	12409P	VBL6C	5515P	5005		
BLM.080.090.CA2W	80-102	32	63	88	2,01	LMA.080.000.000W	VBL10C	5008	4158	901.006 040.010	5003	CA2-90	124510P	VBL6C	5520P	5005	CC..12	
BLM.100.090.CA1W	100-126	40	78	100	3,69	LMA.100.000.000W	VBL10	5008	4158	GRB6C	5003	CA1-90	12409P	VBL6C	5515P	5005	TC..16	
BLM.100.090.CA2W	100-126	40	78	100	3,69	LMA.100.000.000W	VBL10	5008	4158	GRB6C	5003	CA2-90	124510P	VBL6C	5520P	5005	CC..12	
BLM.125.090.CA1W	125-162	40	78	100	5,25	LMA.125.000.000W	VBL10L	5008	4158	GRB6	5003	CA1-90	12409P	VBL6C	5515P	5005	TC..16	
BLM.125.090.CA2W	125-162	40	78	100	5,25	LMA.125.000.000W	VBL10L	5008	4158	GRB6	5003	CA2-90	124510P	VBL6C	5520P	5005	CC..12	
BLM.160.090.CA1W	160-210	40	78	100	6,60	LMA.160.000.000W	VBL10L	5008	4158	GRB6L	5003	CA1-90	12409P	VBL6C	5515P	5005	TC..16	
BLM.160.090.CA2W	160-210	40	78	100	6,60	LMA.160.000.000W	VBL10L	5008	4158	GRB6L	5003	CA2-90	124510P	VBL6C	5520P	5005	CC..12	

CA ..-90

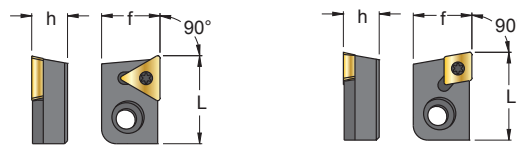

CARTUCCE PER TESTA PER ALESARE BILAMA
 CARTRIDGES FOR TWIN CUTTER BORING HEADS
 EINBAUHALTER FÜR ZWEISCHNEIDEN-AUSDREHKOPF
 CARTOUCHES POUR TÊTE D'ALÉSAGE DOUBLE TRANCHANT

TC.. 16T3



CC.. 1204



INSERTI - INSERTS
 PAG. 938 / 935

(mm)				kg	Nm						
ART.	f	h	L								
CA1-90	20,0	12,27	30	0,035	3,8+5,0	16T3	-	12409P	5515P	VBL06C	5005
CA2-90	20,0	12,27	30	0,035	4,0+5,0	-	1204	124510P	5520P	VBL06C	5005

BLT .. 075 ..W

Ø 40-162

NEW

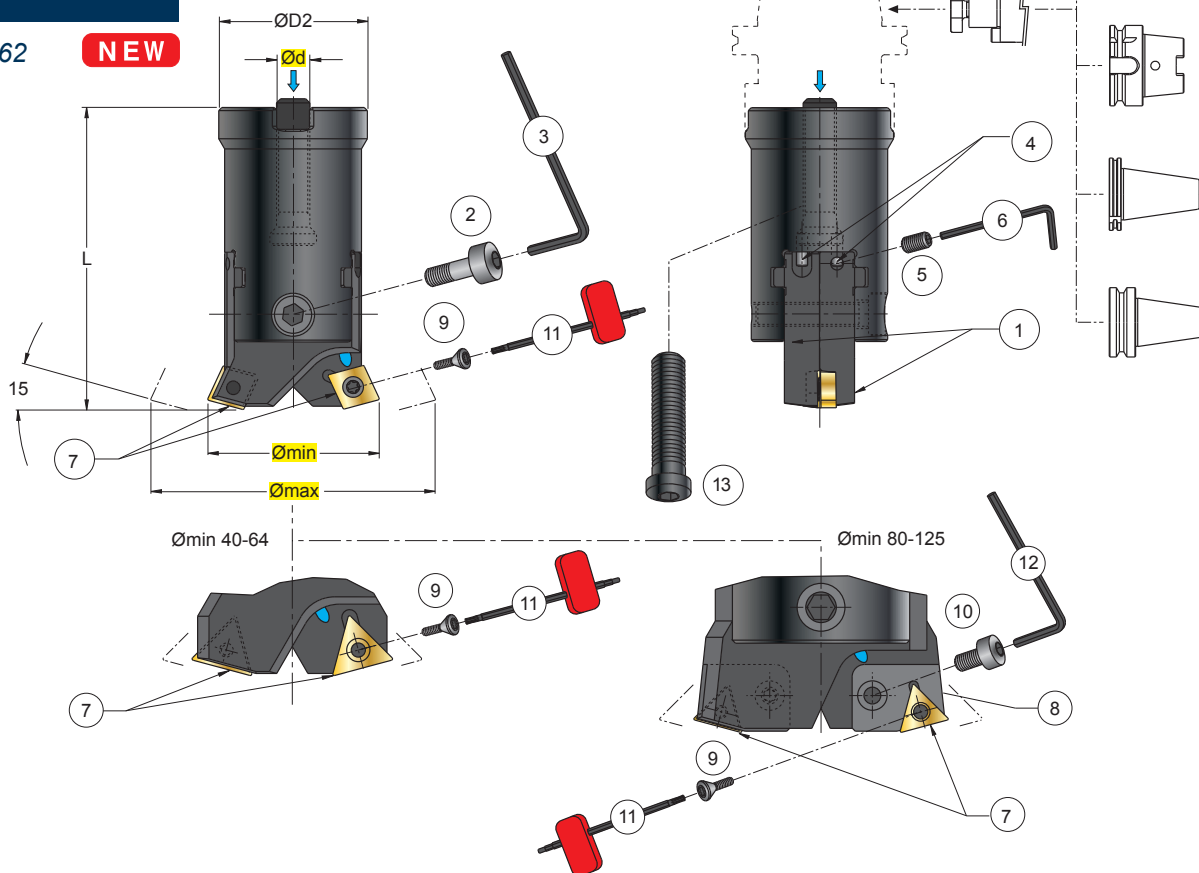

ART.	(mm)				kg	1	2	3	4	5	6	8	9	10	11	12	13	7
	Ømin-max	Ød	ØD2	L														
BLT.040.075.C09W	40-51	16	38	77	0,30	LMA.040.075.C09W	VBL06L	5005	3098	GRB4C	5002	-	12409P	-	5515P	-	VDST 2008	CC..09
BLT.050.075.T16W	50-65	22	48	85	0,50	LMA.050.075.T16W	VBL06L	5005	3098	GRB4	5002	-	12409P	-	5515P	-	VBSF 10AV	TC..16
BLT.064.075.T16W	64-82	27	60	101	0,90	LMA.064.075.T16W	VBL08	5006	3098	GRB4L	5002	-	1240P	-	5515P	-	VBSF 12	
BLT.080.075.CA1W	80-102	32	75	116	1,44	LMA.080.000.000W	VBL10C	5008	4158	901.006 040.010	5003	CA1-75	12409P	VBL6C	5515P	5005	VBSF 16	
BLT.080.075.CA3W	80-102	32	75	116	1,44	LMA.080.000.000W	VBL10C	5008	4158	901.006 040.010	5003	CA3-75	124510P	VBL6C	5520P	5005	VBSF 16	SC..12
BLT.100.075.CA1W	100-126	32	80	121	2,12	LMA.100.000.000W	VBL10	5008	4158	GRB6C	5003	CA1-75	12409P	VBL6C	5515P	5005	VBSF 16	TC..16
BLT.100.075.CA3W	100-126	32	80	121	2,12	LMA.100.000.000W	VBL10	5008	4158	GRB6C	5003	CA3-75	124510P	VBL6C	5520P	5005	VBSF 16	SC..12
BLT.125.075.CA1W	125-162	32	80	121	3,30	LMA.125.000.000W	VBL10L	5008	4158	GRB6	5003	CA1-75	12409P	VBL6C	5515P	5005	VBSF 16	TC..16
BLT.125.075.CA3W	125-162	32	80	121	3,30	LMA.125.000.000W	VBL10L	5008	4158	GRB6	5003	CA3-75	124510P	VBL6C	5520P	5005	VBSF 16	SC..12

CA ..-75



TC.. 16T3



SC.. 1204



CARTUCCE PER TESTA PER ALESARE BILAMA
 CARTRIDGES FOR TWIN CUTTER BORING HEADS
 EINBAUHALTER FÜR ZWEISCHNEIDEN-AUSDREHKOPF
 CARTOUCHES POUR TÊTE D'ALÉSAGE DOUBLE TRANCHANT



INSERTI - INSERTS
 PAG. 938 / 937

ART.	(mm)			kg	Nm	1	2	3	4	5	6	7	8	9	10	11	12	13
	f	h	L															
CA1-75	16,47	12,27	30	0,035	3,8+5,0	16T3	-			12409P	5515P					VBL06C	5005	
CA3-75	16,47	12,27	30	0,035	4,0+5,0	-	1204			124510P	5520P					VBL06C	5005	

BLT .. 090 ..W

Ø 40-162

NEW

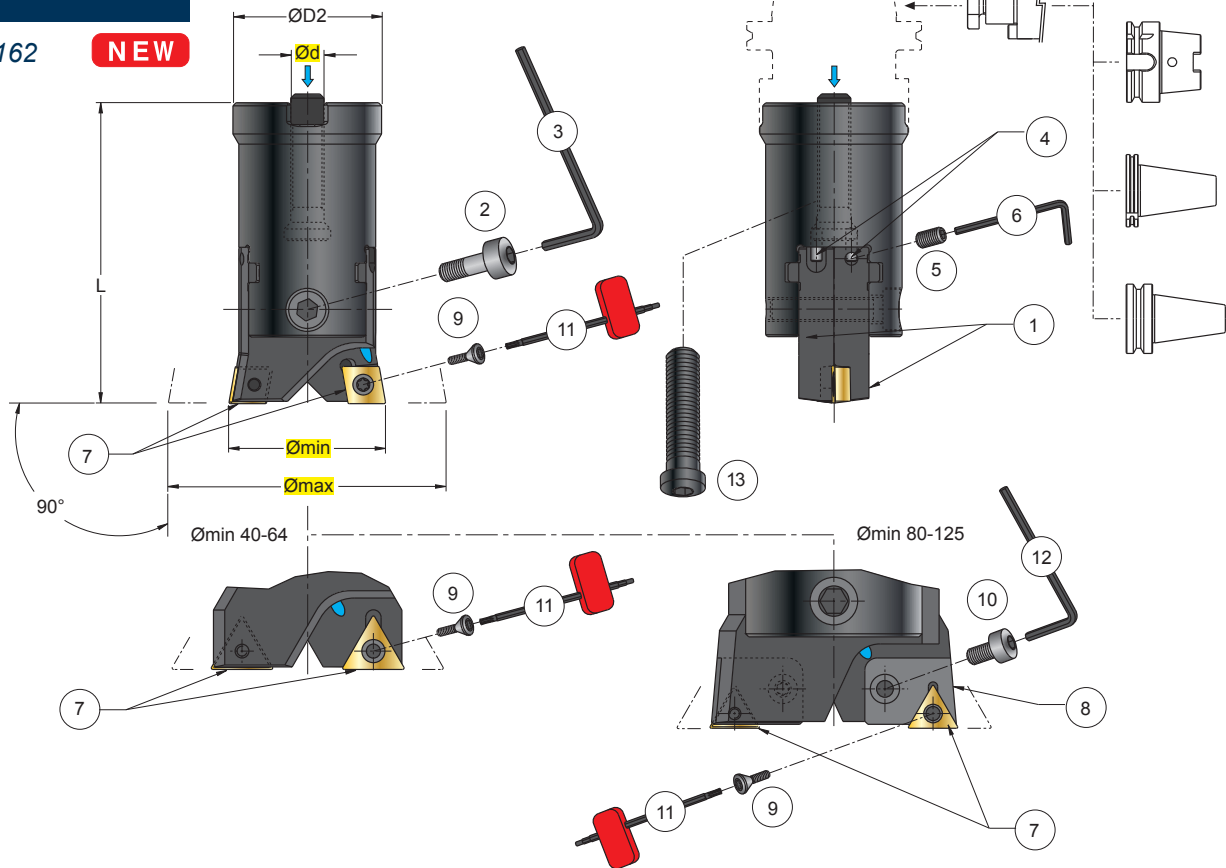

(mm)						1	2	3	4	5	6	8	9	10	11	12	13	7	
ART.	Ømin-max	Ød	ØD2	L	kg														
BLT.040.090.C09W	40-51	16	38	77	0,30	LMA.040.090.C09W	VBL06BL	5005	3098	GRB4C	5002	-	12409P	-	5515P	-	VDST 2008	CC..09	
BLT.050.090.T16W	50-65	22	48	85	0,50	LMA.050.090.T16W	VBL06L	5005	3098	GRB4	5002	-	12409P	-	5515P	-	VBSF 10AV	TC..16	
BLT.064.090.T16W	64-82	27	60	101	0,90	LMA.064.090.T16W	VBL08	5006	3098	GRB4L	5002	-	1240P	-	5515P	-	VBSF 12		
BLT.080.090.CA1W	80-102	32	75	116	1,44	LMA.080.000.000W	VBL10C	5008	4158	901.006 040.010	5003	CA1-90	12409P	VBL6C	5515P	5005	VBSF 16		
BLT.080.090.CA2W	80-102	32	75	116	1,44	LMA.080.000.000W	VBL10C	5008	4158	901.006 040.010	5003	CA2-90	124510P	VBL6C	5520P	5005	VBSF 16	CC..12	
BLT.100.090.CA1W	100-126	32	80	121	2,12	LMA.100.000.000W	VBL10	5008	4158	GRB6C	5003	CA1-90	12409P	VBL6C	5515P	5005	VBSF 16	TC..16	
BLT.100.090.CA2W	100-126	32	80	121	2,12	LMA.100.000.000W	VBL10	5008	4158	GRB6C	5003	CA2-90	124510P	VBL6C	5520P	5005	VBSF 16	CC..12	
BLT.125.090.CA1W	125-162	32	80	121	3,30	LMA.125.000.000W	VBL10L	5008	4158	GRB6	5003	CA1-90	12409P	VBL6C	5515P	5005	VBSF 16	TC..16	
BLT.125.090.CA2W	125-162	32	80	121	3,30	LMA.125.000.000W	VBL10L	5008	4158	GRB6	5003	CA2-90	124510P	VBL6C	5520P	5005	VBSF 16	CC..12	

CA ..-90

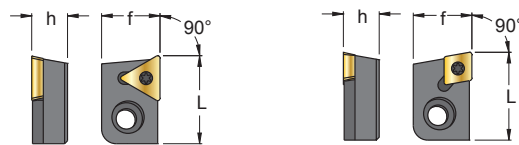

CARTUCCE PER TESTA PER ALESARE BILAMA
 CARTRIDGES FOR TWIN CUTTER BORING HEADS
 EINBAUHALTER FÜR ZWEISCHNEIDEN-AUSDREHKOPF
 CARTOUCHES POUR TÊTE D'ALÉSAGE DOUBLE TRANCHANT

TC.. 16T3



CC.. 1204



INSERTI - INSERTS
 PAG. 938 / 935

(mm)				kg	Nm	16T3	1204	12409P	5515P	VBL06C	5005
ART.	f	h	L								
CA1-90	20,0	12,27	30	0,035	3,8+5,0	16T3	-	12409P	5515P	VBL06C	5005
CA2-90	20,0	12,27	30	0,035	4,0+5,0	-	1204	124510P	5520P	VBL06C	5005

BLS W .. 2T

Ø 150-550

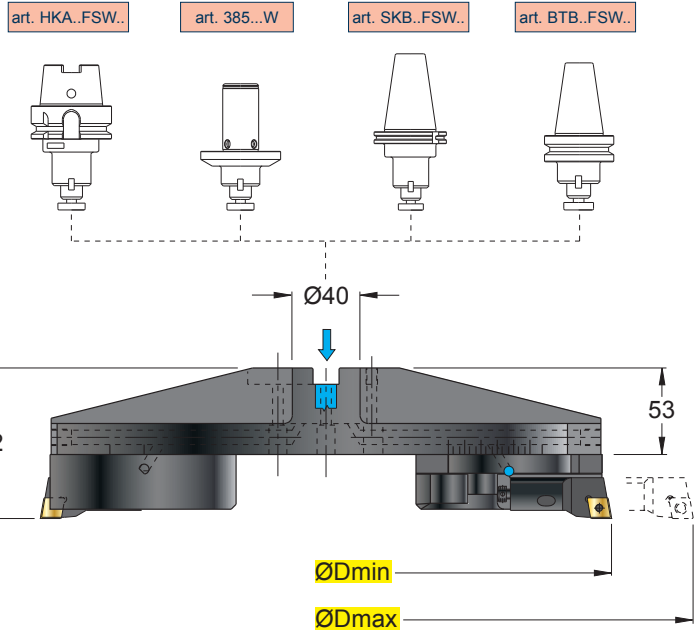
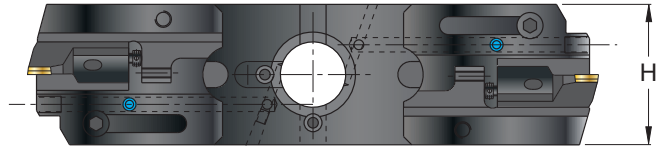
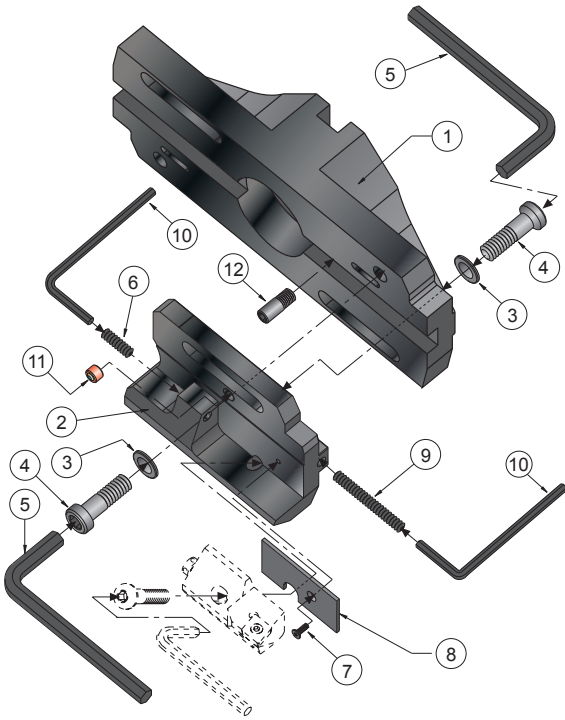

ART.	(mm)		kg	①	②	③	④	⑤	⑥	⑦	⑧	⑨	⑩	⑪	⑫	
	ØDmin-max	H														
BLS W.150.2T	150-200	104	5,3	n°1 FL 150	n°2 SL 150 CA 20	n°4 RP 101616	n°4 AL 10X40	n°1 5007	n°2 901.006. .020.010	n°2 VBS 0308	n°2 RDS 20	n°1 GRB 6C	n°1 5003	n°2 RUR 008	n°2 RPF 08	..20CA...
BLS W.200.2T	200-250	104	6,5	FL 200	SL 150 CA 20	RP 101616	AL 10X40	5007	901.006. .020.010	VBS 0308	RDS 20	GRB 6C	5003	RUR 008	RPF 08	..20CA...
BLS W.250.2T	250-350	86	6,8	FL 250	SL 250 CA 20	RP 101616	AL 10X40	5007	901.006. .020.010	VBS 0308	RDS 20	GRB 6C	5003	RUR 008	RPF 08	..20CA...
BLS W.350.2T	350-450	86	8,5	FL 350	SL 250 CA 20	RP 101616	AL 10X40	5007	901.006. .020.010	VBS 0308	RDS 20	GRB 6C	5003	RUR 008	RPF 08	..20CA...
BLS W.450.2T	450-550	86	10,5	FL 450	SL 250 CA 20	RP 101616	AL 10X40	5007	901.006. .020.010	VBS 0308	RDS 20	GRB 6C	5003	RUR 008	RPF 08	..20CA...

- CARTUCCE ..L 20CA.. DA ORDINARSI A PARTE : PAG. 919 / 920 / 924 / 925
 UTILIZZARE SOLO CARTUCCE SINISTRE

- CARTRIDGES .. L 20CA.. TO BE ORDERED SEPARATELY : PAG. 919 / 920 / 924 / 925
 USE LEFT-HAND CARTRIDGES ONLY

- EINBAUHALTER .. L 20CA.. (MÜSSEN SEPARAT BESTELLT WERDEN) : PAG. 919 / 920 / 924 / 925
 NUR LINKE EINBAUHALTER VERWENDEN

- CARTOUCHES .. L 20CA.. POUR COMMANDER À PART : PAG. 919 / 920 / 924 / 925
 UTILISER EXCLUSIVEMENT DES CARTOUCHES GAUCHES

BLF W .. 2T

Ø 150-550

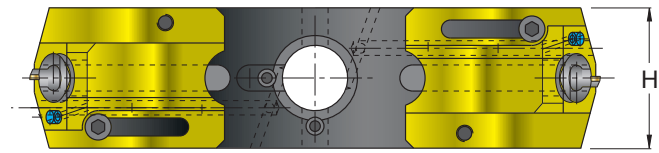
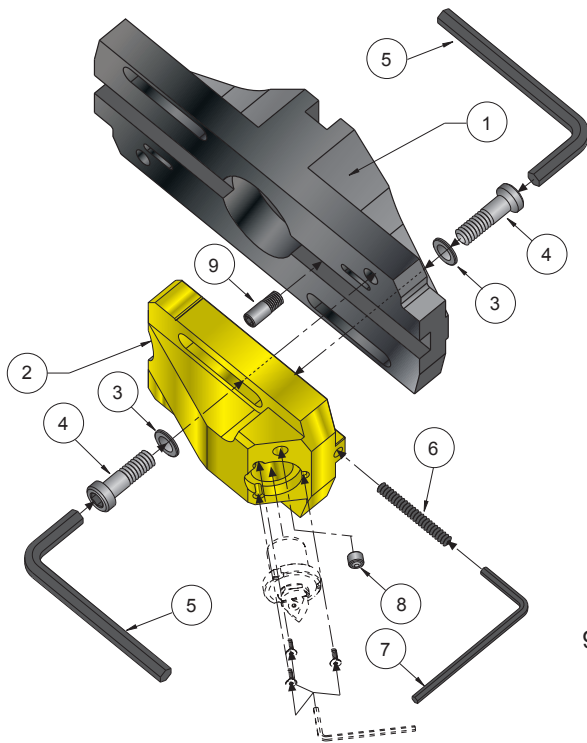

art. HKA..FSW.. art. 385...W art. SKB..FSW.. art. BTB..FSW..

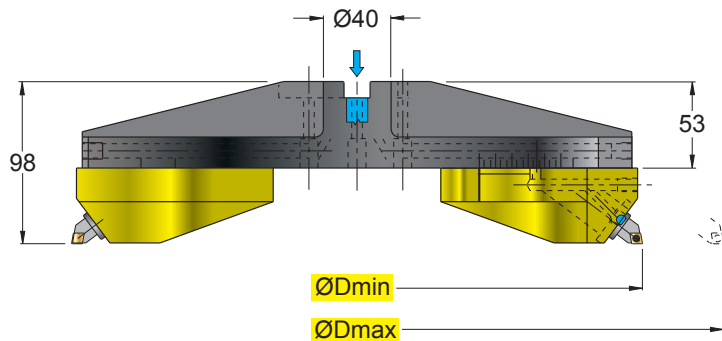
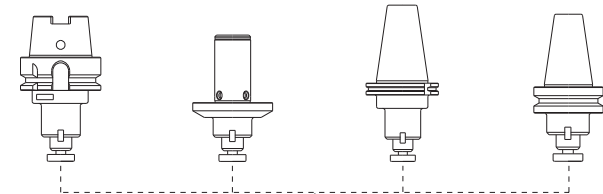

ART.	(mm)		kg	①	②	③	④	⑤	⑥	⑦	⑧	⑨	Icon
	ØDmin-max	H											
BLF W.150.2T	150-200	104	4,3	n°1 FL 150	n°2 SL 150 UM 33	n°4 RP 101616	n°4 AL 10X40	n°1 5007	n°2 GRB 6C	n°1 5003	n°2 RUR 008	n°2 RPF 08	L348C. .33 ...
BLF W.200.2T	200-250	104	5,5	FL 200	SL 150 UM 33	RP 101616	AL 10X40	5007	GRB 6C	5003	RUR 008	RPF 08	L348C. .33 ...
BLF W.250.2T	250-350	86	5,3	FL 250	SL 250 UM 33	RP 101616	AL 10X40	5007	GRB 6C	5003	RUR 008	RPF 08	L348C. .33 ...
BLF W.350.2T	350-450	86	7,0	FL 350	SL 250 UM 33	RP 101616	AL 10X40	5007	GRB 6C	5003	RUR 008	RPF 08	L348C. .33 ...
BLF W.450.2T	450-550	86	9,0	FL 450	SL 250 UM 33	RP 101616	AL 10X40	5007	GRB 6C	5003	RUR 008	RPF 08	L348C. .33 ...

- UNITÀ MICROREGISTRABILI L348C.33. ... DA ORDINARSI A PARTE : PAG. 928
- MICRO-BORING UNITS L.348C.33.09T3/L348C.33.1102 TO BE ORDERED SEPARATELY : PAG. 928
- FEINBOHRWERKZEUGE L.348C.33.09T3/L348C.33.1102(MÜSSEN SEPARAT BESTELT WERDEN) : PAG. 928
- UNITÉ MICRO METRIQUE L.348C.33.09T3/L348C.33.1102 POUR COMMANDER À PART : PAG. 928



COMPONENTI PER BARENATURA



BORING COMPONENTS



EINBAUHALTER



COMPOSANTES POUR ALÉSAGE



COMPONENTES PARA MANDRINADO

M	P	P	P	S	S
MCLNR/L...CA Pag.918	PCLNR/L...CA Pag.919	PTGNR/L...CA Pag.919	PSKNR/L...CA Pag.921	STFCR/L...CA Pag.922	SSSCR/L...CA Pag.923
 CNM. 1204..	 CNM. 1204..	 TNM. 1604.. 2204..	 SNM. 1204..	 TCMT 0902.. 1102.. 16T3..	 SCMT 09T3..
MCFNR/L...CA Pag.918	PCFNR/L...CA Pag.919	PTFNR/L...CA Pag.920	PSSNR/L...CA Pag.921	STWCR/L...CA Pag.922	SCLPR/L...CA Pag.924
 CNM. 1204..	 CNM. 1204..	 TNM. 1604..	 SNM. 1204..	 TCMT 0902.. 1102.. 16T3..	 CPMT 05T1..
MCGNR/L...CA Pag.918	PCGNR/L...CA Pag.919	PTWNR/L...CA Pag.920	PSRNR/L...CA Pag.921	STSCR/L...CA Pag.922	SCFPR/L...CA Pag.924
 CNM. 1204..	 CNM. 1204.. 1606..	 TNM. 1604.. 2204..	 SNM. 1204..	 TCMT 0902.. 1102.. 16T3..	 CPMT 05T1..
MCKNR/L...CA Pag.918		PTSNR/L...CA Pag.920	PWLNRL...CA Pag.921	STTCR/L...CA Pag.922	SCWPR/L...CA Pag.924
 CNM. 1204..		 TNM. 1604..	 WNM. 0804..	 TCMT 0902.. 1102.. 16T3..	 CPMT 05T1..
		PTTNR/L...CA Pag.920		STXCR/L...CA Pag.923	SCSPR/L...CA Pag.925
		 TNM. 1604.. 2204..		 TCMT 0902.. 1102.. 16T3..	 CPMT 05T1..
MSKNR/L...CA Pag.918				STGCR/L...CA Pag.923	SCTPR/L...CA Pag.925
 SNM. 1204..				 TCMT 0902.. 1102.. 16T3..	 CPMT 05T1..
				SSKCR/L...CA Pag.923	SCRPR/L...CA Pag.925
				 SCMT 09T3.. 1204..	 CPMT 05T1..

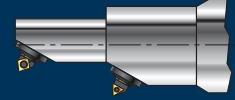
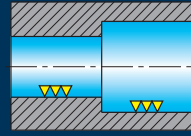
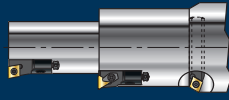
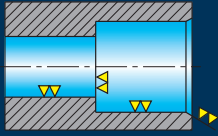

S	S	C	S	S	S
SCLCR/L..CA Pag.924	SCGCR/L..CA Pag.925	CTFPR/L..CA Pag.927	L/R348.C.3.. Pag.928	S..SCACL/R.. Pag.930	S..STAACL Pag.931
 95° 95° CCMT 0602.. 09T3.. 1204..	 90° CCMT 1204..	 90° TPMR 1103.. 1603..	 90° CC.T 0602.. 09T3..	 90° CCMT 0602.. 09T3..	 90° TCMT 1102..
SCFCR/L..CA Pag.924		CTWPR/L..CA Pag.927	L/R348.C.3.. Pag.928	S..SCECL/R.. Pag.930	S..STECL Pag.931
 90° CCMT 0602.. 09T3.. 1204..		 60° TPMR 1103.. 1603..	 90° TC.. 0902.. 1102.. 16T3..	 60° CCMT 0602.. 09T3..	 60° TCMT 1102..
SCBCR/L..CA Pag.924	SXFCR/L..CA Pag.926	CTSPR/L..CA Pag.927	L348.C.1.. Pag.929	S..SCDCL/R.. Pag.930	S..STDCL Pag.931
 75° CCMT 1204..	 90° NEW XC.. 0602.. 09T3..	 45° TPMR 1103.. 1603..	 90° CC.T 0602.. 09T3..	 45° CCMT 0602.. 09T3..	 45° TCMT 1102..
SCWCR/L..CA Pag.924	SXWCR/L..CA Pag.926	CTTPR/L..CA Pag.927	L348.C.1.. Pag.929	S..SCWCL/R.. Pag.930	S..STWCL Pag.931
 60° CCMT 0602.. 09T3.. 1204..	 60° NEW XC.. 0502.. 09T3..	 60° TPMR 1103.. 1603..	 90° TC.. 0902.. 1102.. 16T3..	 30° CCMT 0602.. 09T3..	 30° TCMT 1102..
SCSCR/L..CA Pag.925	SXSCR/L..CA Pag.926	CTGPR/L..CA Pag.927			
 45° CCMT 0602.. 09T3.. 1204..	 45° NEW XC.. 0502.. 09T3..	 90° TPMR 1103.. 1603..			
SCTCR/L..CA Pag.925	SXTCR/L..CA Pag.926				
 60° CCMT 0602.. 09T3.. 1204..	 30° NEW XC.. 0502.. 09T3..				
SCRCR/L..CA Pag.925					
 75° CCMT 0602.. 09T3.. 1204..					

- UNITÀ MICROMETRICHE PER FINITURA
 - MICRO-BORING UNITS FOR FINISHING
 - FEINBOHRWERKZEUGE ZUM SCHLICHTEN
 - UNITÉ MICROMETRIQUE POUR FINISSAGE

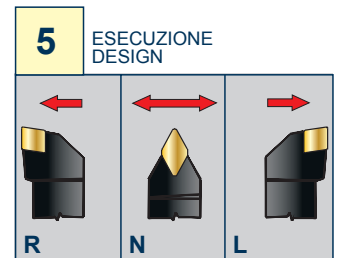
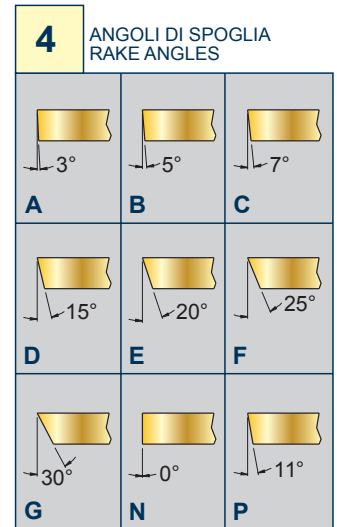
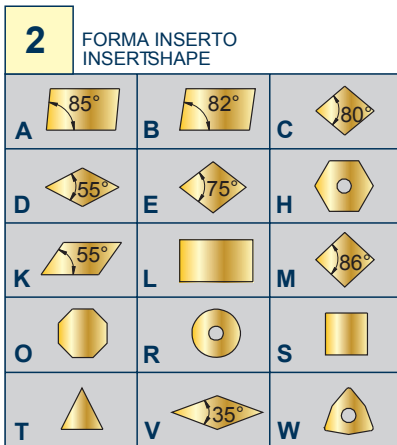
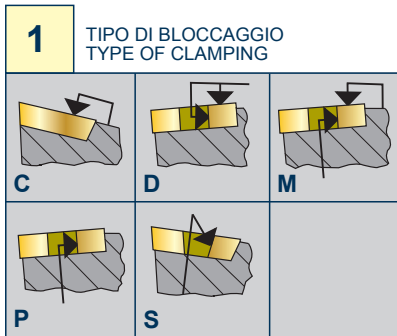

P	C	L	N	R	32	25	P	12	
1	2	3	4	5	6	7	8	9	10

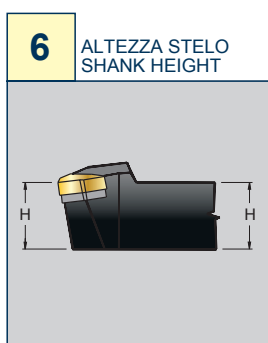

8 LUNGHEZZA UTENSILE
TOOL LENGTH

L1 mm	ISO
32	A
40	B
50	C
60	D
70	E
80	F
90	G
100	H
110	J
125	K
140	L
150	M
160	N
170	P
180	Q
200	R
250	S
300	T
350	U
400	V
450	W
500	Y
SPECIALE SPECIAL	X

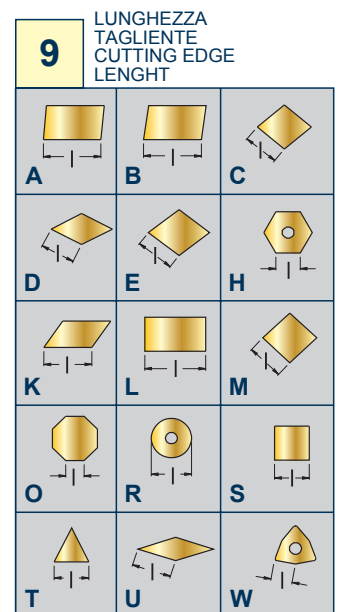

10 FACOLTATIVO
OPTIONAL
INDICAZIONI SUPPLEMENTARI
ADDITIONALS DETAILS

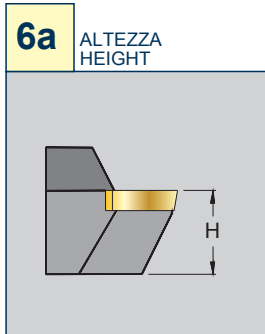

7a TIPO DI UTENSILE
TYPE OF TOOL

C = CARTUCCIA
C = CARTRIDGE

7b ESECUZIONE
EXECUTION

A = ISO 5611

C	T	F	P	R	12	C	A	16
1	2	3	4	5	6a	7a	7b	9



MCLNR/L..CA

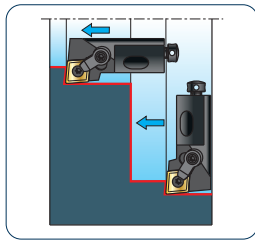

16CA..X°=45°

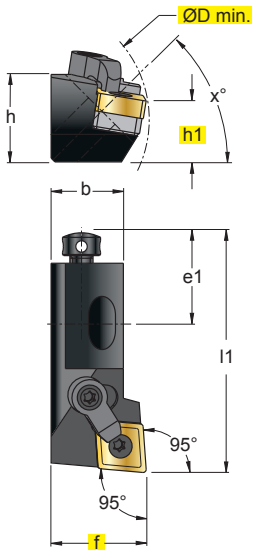

In figura utensile destro
Right-hand shown

MCFNR/L..CA

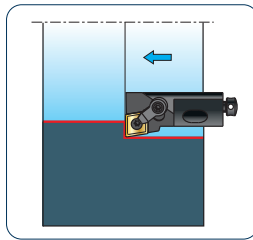

16CA..X°=45°

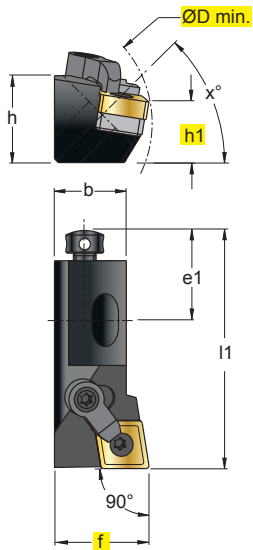

In figura utensile destro
Right-hand shown

MCGNR/L..CA

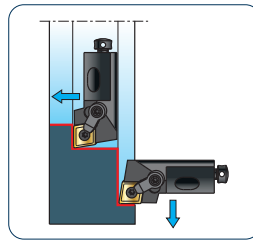

16CA..X°=45°

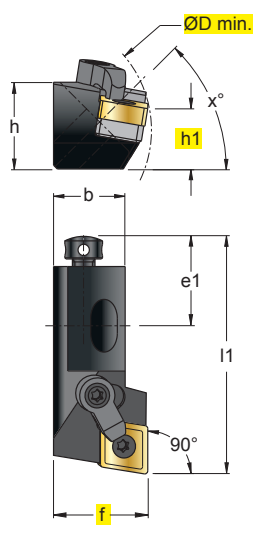

In figura utensile destro
Right-hand shown

MCKNR/L..CA

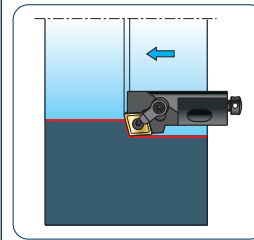

16CA..X°=45°

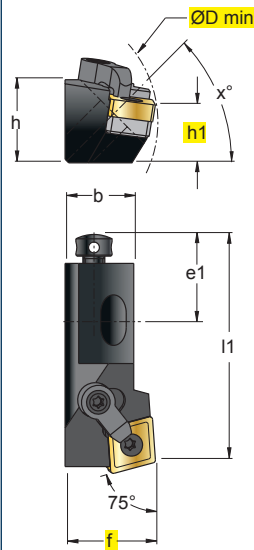

In figura utensile destro
Right-hand shown

MSKNR/L..CA

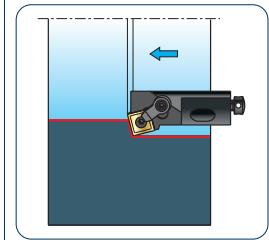

16CA..X°=45°

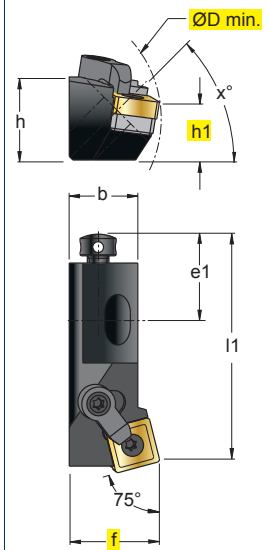

In figura utensile destro
Right-hand shown

(mm)																					
ART.	ØDmin	h1	f	b	l1	h	e1	t	CNM.												
MCLNR/L 16CA - 12	55	16	25	19	63	23	25	-	1204..	CKM21	STCM25	KLM46S	5515	KCN 433	1406	1505	5025	1808	KMS4S	RCN 1225	
MCFNR/L 16CA - 12	55	16	25	19	63	23	25	-	1204..	CKM21	STCM25	KLM46S	5515	KCN 433	1406	1505	5025	1808	KMS4S	RCN 1225	
MCGNR/L 16CA - 12	55	16	25	19	63	23	25	-	1204..	CKM21	STCM25	KLM46S	5515	KCN 433	1406	1505	5025	1808	KMS4S	RCN 1225	
MCKNR/L 16CA - 12	55	16	25	19	63	23	25	-	1204..	CKM21	STCM25	KLM46S	5515	KCN 433	1406	1505	5025	1808	KMS4S	RCK 1225	

(mm)																					
ART.	ØDmin	h1	f	b	l1	h	e1	t	SNM.												
MSKNR/L 16CA - 12	55	16	25	19	63	23	25	-	1204..	CKM21	STCM25	KLM46S	5515	KSN 433	1406	1505	5025	1808	KMS4S	RSN 1225	

- VITE DI FISSAGGIO DEL SOTTOPLACCHETTA PER INSERTI SENZA FORO - UNTERLEGPLATTENBEFESTIGUNGSSCHRAUBE FÜR WENDEPLATTEN OHNE BOHRUNG
 - SHIM CLAMPING SCREW FOR INSERTS WITHOUT BORE - VIS DE FIXAGE DE SOUS-PLAQUETTE POUR PLAQUETTES SANS TROU

- ROMPIRUCIOLO PER INSERTI CERAMICI E SENZA FORO - SPANBRECHER FÜR KERAMISCHE WENDEPLATTEN UND FÜR WENDEPLATTEN OHNE KUEHLMITTELBOHRUNG
 - CHIP BREAKER FOR CERAMIC INSERTS AND FOR INSERTS WITHOUT BORE - BRISE-CPEAUX POUR PLAQUETTES CERAMIQUES ET POUR PLAQUETTES SANS TROU

ART.	DIMENSIONI MEASURES ABMESSUNGEN DIMENSIONS			INSERTO INSERT WENDEPLATTEN PLAQUETTES	ART.	DIMENSIONI MEASURES ABMESSUNGEN DIMENSIONS			INSERTO INSERT WENDEPLATTEN PLAQUETTES	ART.	DIMENSIONI MEASURES ABMESSUNGEN DIMENSIONS			INSERTO INSERT WENDEPLATTEN PLAQUETTES												
RCN 1225	L	10,7	H	2,5	R	2,3	CN.. 1204..		RCK 1225	L	10,7	H	2,5	R	2,3	CN.. 1204..		RSN 1225	L	10,7	H	2,5	R	2,3	SN.. 1204..	





PCLNR/L..CA

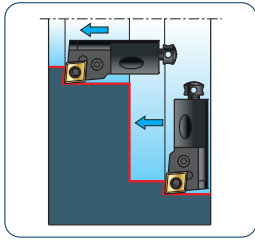

16CA..X°=45°
20CA..X°=45°

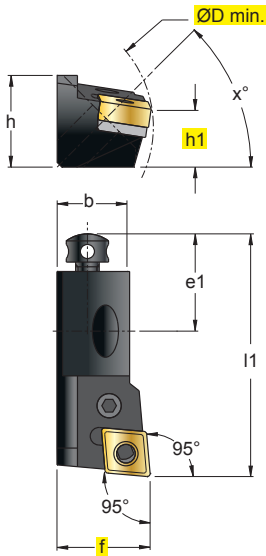

In figura utensile destro
Right-hand shown

PCFNR/L..CA

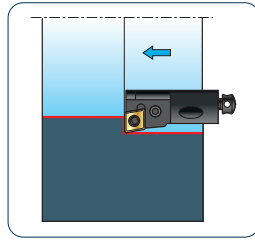

16CA..X°=45°
20CA..X°=45°

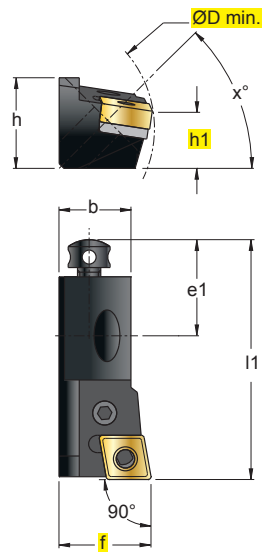

In figura utensile destro
Right-hand shown

PCGNR/L..CA

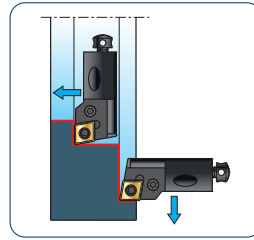

16CA..X°=45°
20CA..X°=45°

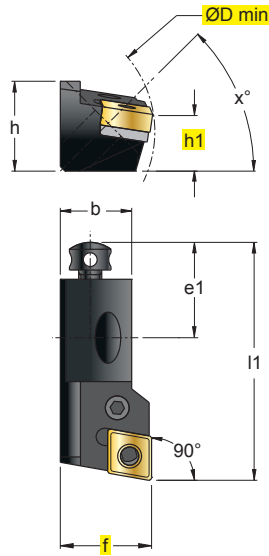

In figura utensile destro
Right-hand shown

PTGNR/L..CA

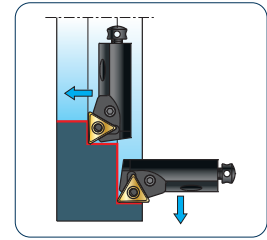

12CA..X°=20°
16CA..X°=45°
20CA..X°=45°

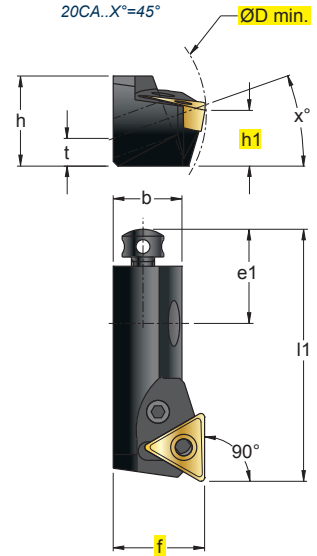

In figura utensile destro
Right-hand shown

(mm)																			
ART.	ØDmin	h1	f	b	l1	h	e1	t											
										CNM.									
PCLNR/L 16CA - 12	55	16	25	20	63	25	25	-		1204..	8012	1648	5003	3612	4112	1406	1505	5025	1808
PCLNR/L 20CA - 12	70	20	25	20	70	30	30	-		1204..	8012	1608	5003	3612	4112	1406	1505	5025	1808
PCLNR/L 20CA - 16	70	20	25	20	70	29,5	30	-		1606..	8016	1628	5003	3616	4115	1406	1505	5025	1808
PCFNR/L 16CA - 12	55	16	25	20	63	25	25	-		1204..	8012	1648	5003	3612	4112	1406	1505	5025	1808
PCFNR/L 20CA - 12	70	20	25	20	70	30	30	-		1204..	8012	1608	5003	3612	4112	1406	1505	5025	1808
PCGNR/L 16CA - 12	55	16	25	20	63	25	25	-		1204..	8012	1648	5003	3612	4112	1406	1505	5025	1808
PCGNR/L 20CA - 16	70	20	25	20	70	29,5	30	-		1606..	8016	1628	5003	3616	4115	1406	1505	5025	1808

(mm)																			
ART.	ØDmin	h1	f	b	l1	h	e1	t											
										TNM.									
PTGNR/L 12CA - 16	50	12	20	15	55	20	20	6		1604..	8216	1605	5002	-	-	1405	1504	5002	1806
PTGNR/L 16CA - 16	60	16	25	20	63	25	25	-		1604..	8009	1606	5025	3418	4109	1406	1505	5025	1808
PTGNR/L 20CA - 22	70	20	25	20	70	30	30	-		2204..	8012	1608	5003	3422	4112	1406	1505	5025	1808



PTFNR/L..CA

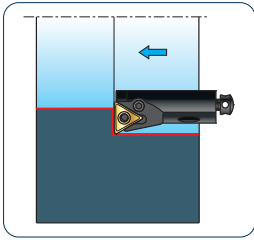

12CA..X°=20°
16CA..X°=45°
20CA..X°=45°

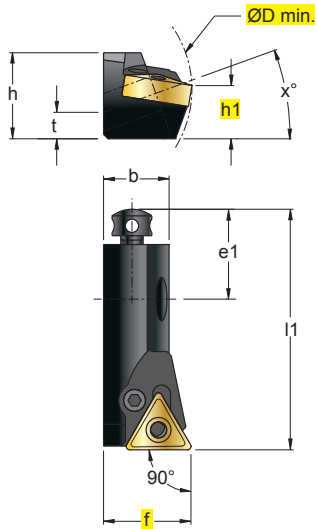

In figura utensile destro
right-hand shown

PTWNR/L..CA

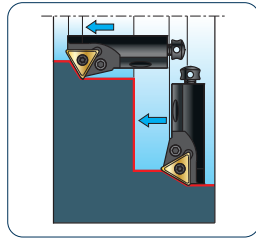

12CA..X°=20°
16CA..X°=45°
20CA..X°=45°

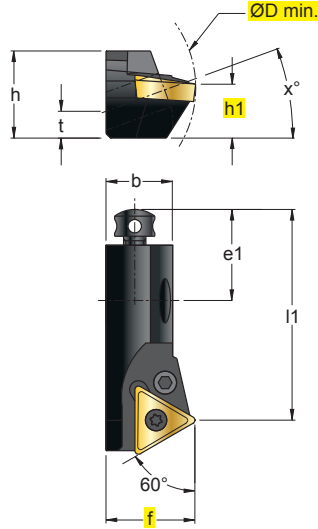

In figura utensile destro
Right-hand shown

PTSNR/L..CA

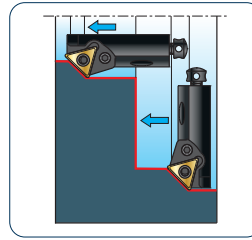

12CA..X°=20°
16CA..X°=45°

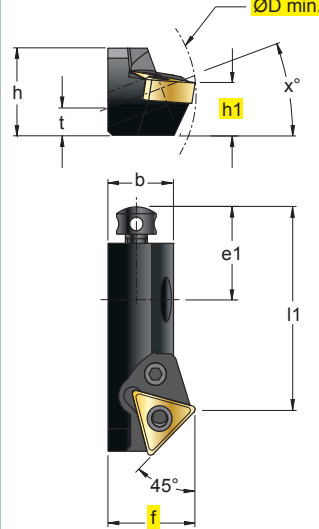

In figura utensile destro
Right-hand shown

PTTNR/L..CA

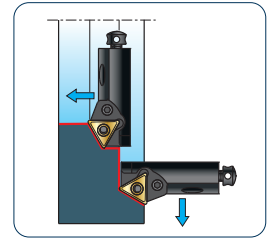

12CA..X°=20°
16CA..X°=45°
20CA..X°=45°

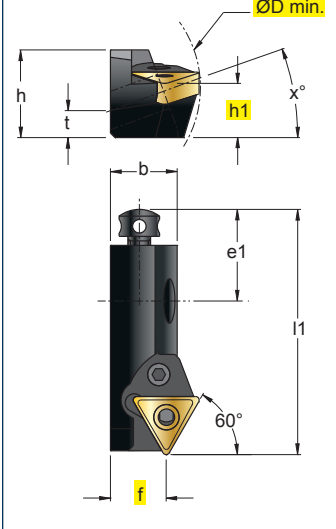

In figura utensile destro
Right-hand shown

(mm)									 TNM.									
ART.	ØDmin	h1	f	b	l1	h	e1	t										
PTFNR/L 12CA - 16	50	12	20	15	55	20	20	6	1604..	8216	1605	5002	-	-	1405	1504	5002	1806
PTFNR/L 16CA - 16	55	16	25	20	63	25	25	-	1604..	8009	1606	5025	3418	4109	1406	1505	5025	1808
PTFNR/L 20CA - 16	70	20	25	20	70	30	30	-	1604..	8009	1606	5025	3418	4109	1406	1505	5025	1808
PTWNR/L 12CA - 16	50	12	20	15	47	20	20	6	1604..	8216	1605	5002	-	-	1405	1504	5002	1806
PTWNR/L 16CA - 16	55	16	25	20	53	25	25	-	1604..	8009	1606	5025	3418	4109	1406	1505	5025	1808
PTWNR/L 20CA - 22	70	20	25	20	60	30	30	-	2204..	8012	1608	5003	3422	4112	1406	1505	5025	1808
PTSNR/L 12CA - 16	50	12	20	15	47	20	20	6	1604..	8216	1605	5002	-	-	1405	1504	5002	1806
PTSNR/L 16CA - 16	55	16	25	20	53	25	25	-	1604..	8009	1606	5025	3418	4109	1406	1505	5025	1808
PTTNR/L 12CA - 16	50	12	13	15	55	20	20	6	1604..	8216	1605	5002	-	-	1405	1504	5002	1806
PTTNR/L 16CA - 16	60	16	15	20	63	25	25	-	1604..	8009	1606	5025	3418	4109	1406	1505	5025	1808
PTTNR/L 20CA - 22	70	20	15	20	70	30	30	-	2204..	8012	1608	5003	3422	4112	1406	1505	5025	1808



PSKNR/L..CA

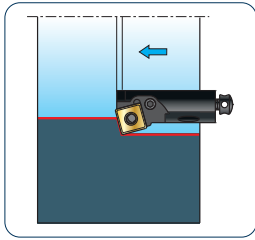

12CA..X°=20°
16CA..X°=45°

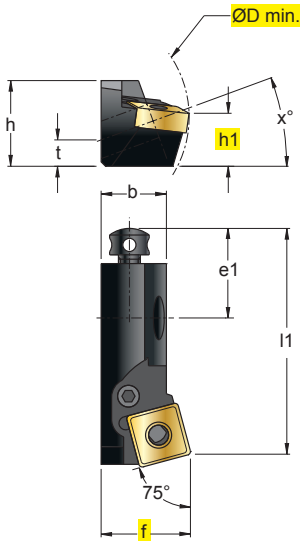

In figura utensile destro
Right-hand shown

PSSNR/L..CA

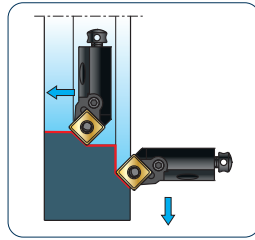

12CA..X°=20°
16CA..X°=45°

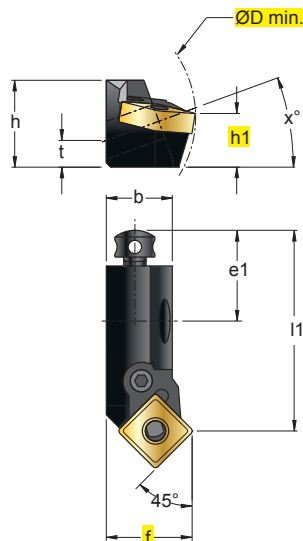

In figura utensile destro
Right-hand shown

PSRNR/L..CA

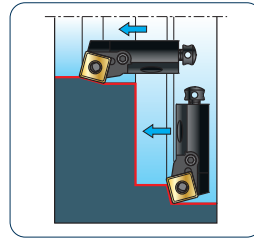

16CA..X°=45°

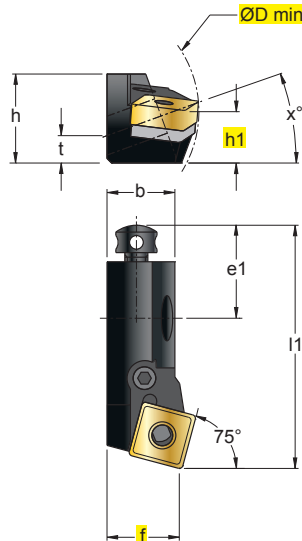

In figura utensile destro
Right-hand shown

PWLNRL..CA

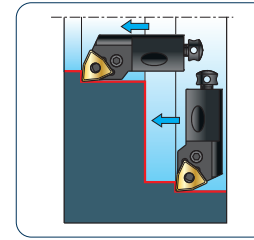

16CA..X°=45°

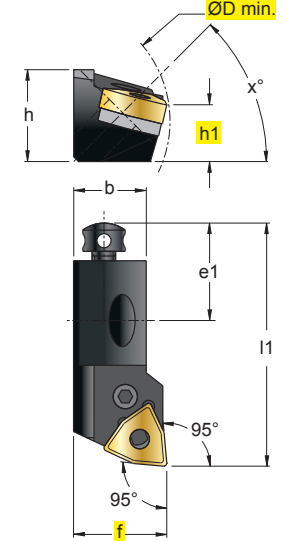

In figura utensile destro
Right-hand shown

(mm)																		
ART.	ØDmin	h1	f	b	l1	h	e1	t	SNM.									
PSKNR/L 12CA - 12	50	12	20	15	55	20	20	6	1204..	8212	1604	5025	-	-	1405	1504	5002	1806
PSKNR/L 16CA - 12	55	16	25	20	63	25	25	-	1204..	8012	1648	5003	3514	4112	1406	1505	5025	1808
PSSNR/L 12CA - 12	50	12	20	15	47	20	20	6	1204..	8212	1604	5025	-	-	1405	1504	5002	1806
PSSNR/L 16CA - 12	55	16	25	20	53	25	25	-	1204..	8012	1648	5003	3514	4112	1406	1505	5025	1808
PSRNR/L 16CA - 12	60	16	25	20	63	25	25	-	1204..	8012	1648	5003	3514	4112	1406	1505	5025	1808

(mm)																		
ART.	ØDmin	h1	f	b	l1	h	e1	t	WNM.									
PWLNRL 16CA - 08	55	16	25	20	63	25	25	-	0804..	8012	1648	5003	3308M	4112	1406	1505	5025	1808



STFCR/L..CA

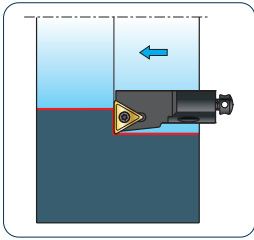

08CA..X°=20°
10CA..X°=20°
12CA..X°=20°
16CA..X°=45°

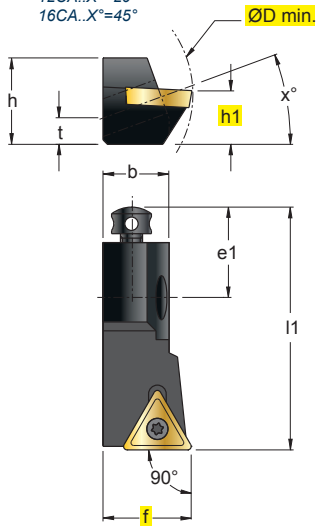

In figura utensile destro
Right-hand shown

STWCR/L..CA

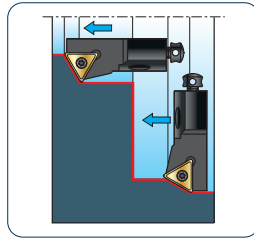

08CA..X°=20°
10CA..X°=20°
12CA..X°=20°

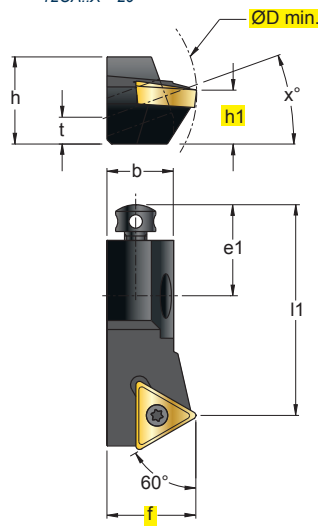

In figura utensile destro
Right-hand shown

STSCR/L..CA

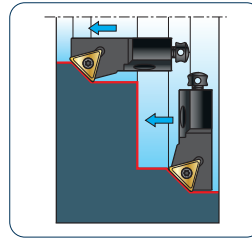

08CA..X°=20°
10CA..X°=20°
12CA..X°=20°

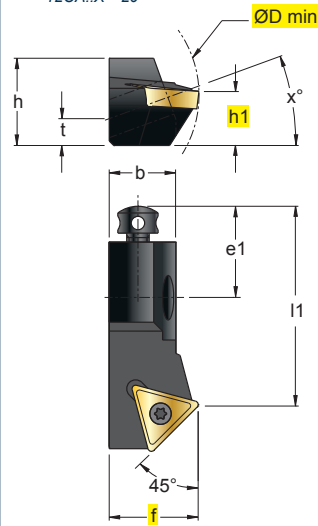

In figura utensile destro
Right-hand shown

STTCR/L..CA

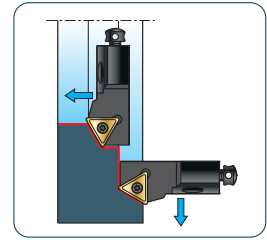

08CA..X°=20°
10CA..X°=20°
12CA..X°=20°

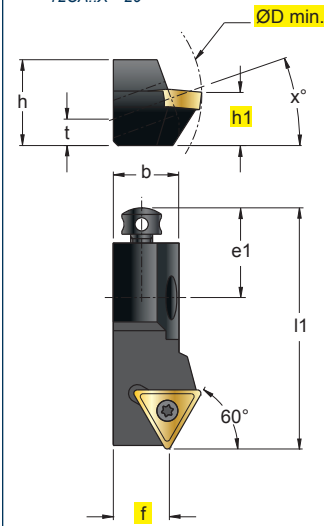

In figura utensile destro
Right-hand shown

		(mm)															
ART.	Code	ØDmin	h1	f	b	l1	h	e1	t	Nm	TC..						
STFCR/L 08CA - 09	T1-90	25	8	10	8	32	11	17	4,5	0,9+1,0	0902..	12225P	5507P	1403	1503	5015	1804
STFCR/L 10CA - 11	-	40	10	14	11	50	15	20	5,0	1,1+1,3	1102..	12256P	5508P	1405	1504	5002	1806C
STFCR/L 12CA - 16	-	50	12	20	15	55	20	20	6,0	3,8+5,0	16T3..	12409P	5515P	1405	1504	5002	1806
STFCR/L 16CA - 16	-	55	16	25	20	63	21	25	-	3,8+5,0	16T3..	12409P	5515P	1406	1505	5025	1808
STWCR/L 08CA - 09	T1-60	25	8	10	8	28	11	17	4,5	0,9+1,0	0902..	12225P	5507P	1403	1503	5015	1804
STWCR/L 10CA - 11	-	40	10	14	11	44	15	20	5,0	1,1+1,3	1102..	12256P	5508P	1405	1504	5002	1806C
STWCR/L 12CA - 16	-	50	12	20	15	47	20	20	6,0	3,8+5,0	16T3..	12409P	5515P	1405	1504	5002	1806
STSCR/L 08CA - 09	T1-45	25	8	10	8	28	11	17	4,5	0,9+1,0	0902..	12225P	5507P	1403	1503	5015	1804
STSCR/L 10CA - 11	-	40	10	14	11	44	15	20	5,0	1,1+1,3	1102..	12256P	5508P	1405	1504	5002	1806C
STSCR/L 12CA - 16	-	50	12	20	15	47	20	20	6,0	3,8+5,0	16T3..	12409P	5515P	1405	1504	5002	1806
STTCR/L 08CA - 09	T1-30	25	8	6	7,5	32	11	17	4,5	0,9+1,0	0902..	12225P	5507P	1403	1503	5015	1804
STTCR/L 10CA - 11	-	40	10	9	11	50	15	20	5,0	1,1+1,3	1102..	12256P	5508P	1405	1504	5002	1806C
STTCR/L 12CA - 16	-	50	12	13	15	55	20	20	6,0	3,8+5,0	16T3..	12409P	5515P	1405	1504	5002	1806



STXCR/L..CA

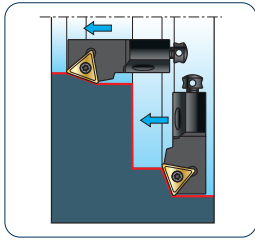

08CA..X°=20°
10CA..X°=20°
12CA..X°=20°

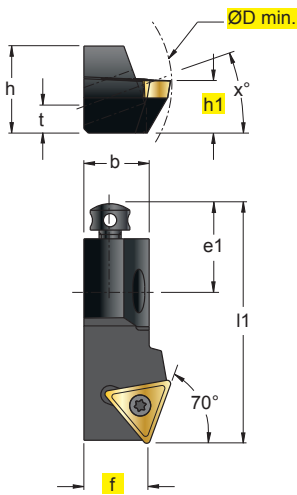

In figura utensile destro
Right-hand shown

STGCR/L..CA

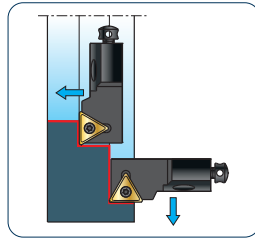

08CA..X°=20°
10CA..X°=20°
12CA..X°=20°

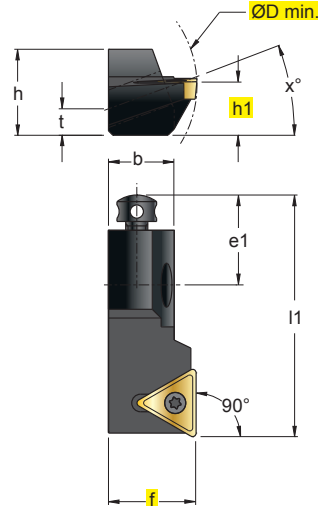

In figura utensile destro
Right-hand shown

SSKCR/L..CA

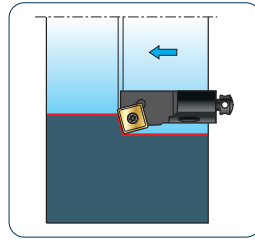

10CA..X°=20°
12CA..X°=20°

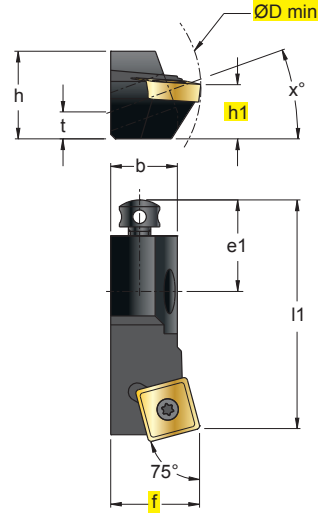

In figura utensile destro
Right-hand shown

SSSCR/L..CA

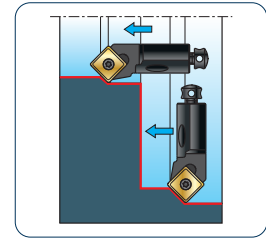

10CA..X°=20°

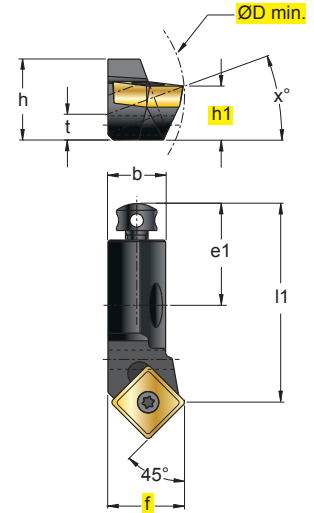

In figura utensile destro
Right-hand shown

(mm)											TC..						
ART.	Code	ØDmin	h1	f	b	l1	h	e1	t	Nm							
STXCR/L 08CA - 09	T1-20	25	8	7	7,5	32	11	17	4,5	0,9+1,0	0902..	12225P	5507P	1403	1503	5015	1804
STXCR/L 10CA - 11	-	40	10	10,5	11	50	15	20	5,0	1,1+1,3	1102..	12256P	5508P	1405	1504	5002	1806C
STXCR/L 12CA - 16	-	50	12	15	15	55	20	20	6,0	3,8+5,0	16T3..	12409P	5515P	1405	1504	5002	1806
STGCR/L 08CA - 09	T1-00	25	8	10	7,5	32	11	17	4,5	0,9+1,0	0902..	12225P	5507P	1403	1503	5015	1804
STGCR/L 10CA - 11	-	40	10	14	11	50	15	20	5,0	1,1+1,3	1102..	12256P	5508P	1405	1504	5002	1806C
STGCR/L 12CA - 16	-	50	12	20	15	55	20	20	6,0	3,8+5,0	16T3..	12409P	5515P	1405	1504	5002	1806

(mm)											SC..						
ART.	Code	ØDmin	h1	f	b	l1	h	e1	t	Nm							
SSKCR/L 10CA - 09	-	40	10	14	11	50	15	20	5,0	3,8+5,0	09T3..	12409P	5515P	1405	1504	5002	1806C
SSKCR/L 12CA - 12	-	50	12	20	15	55	20	20	6,0	4,0+5,0	1204..	124510P	5520P	1405	1504	5002	1806
SSSCR/L 10CA - 09	-	40	10	14	10,7	44	15	20	5,0	3,8+5,0	09T3..	12409P	5515P	1405	1504	5002	1806C



SCL.R/L..CA

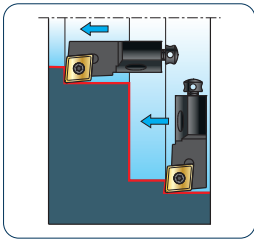

06CA..X°=20°
10CA..X°=20°
12CA..X°=20°

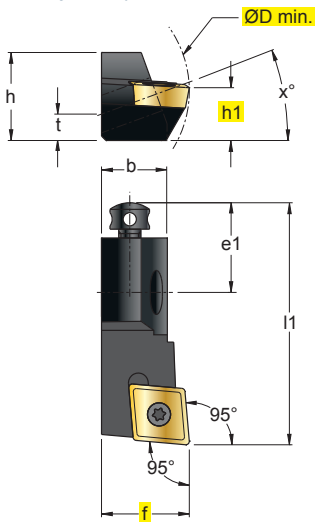

In figura utensile destro
Right-hand shown

SCF.R/L..CA

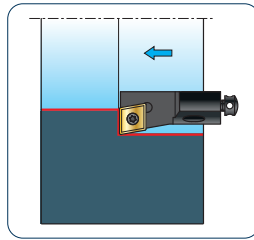

06CA..X°=20°
10CA..X°=20°
12CA..X°=20°

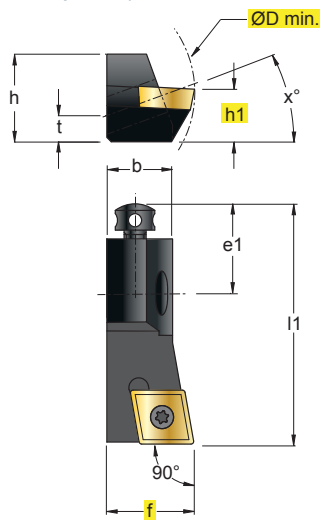

In figura utensile destro
Right-hand shown

SCBCR/L..CA

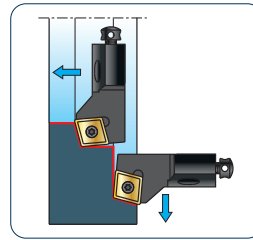

20CA..X°=45°

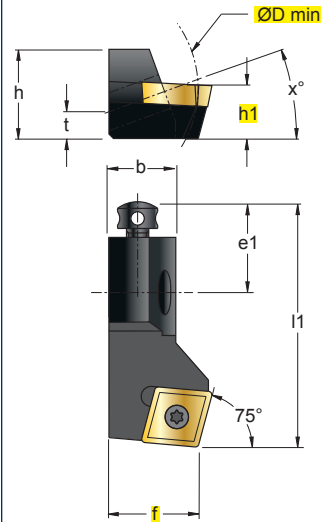

In figura utensile destro
Right-hand shown

SCW.R/L..CA

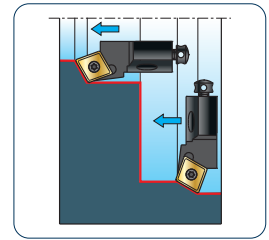

06CA..X°=20°
10CA..X°=20°
12CA..X°=20°

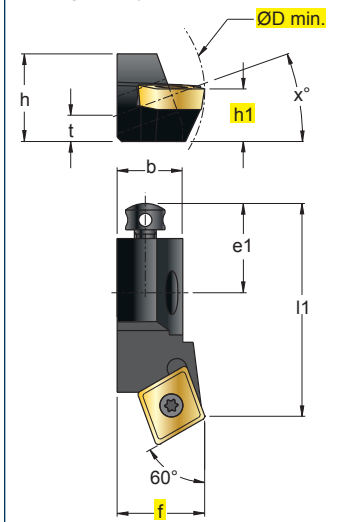

In figura utensile destro
Right-hand shown

		(mm)										CP.(*) CC..	12224	5507	1403	1503	5015	1803
ART.	Code	ØDmin	h1	f	b	l1	h	e1	t	Nm								
SCLPRL 06CA - 05	C0-95	15	5,5	8	6	26	7,5	13	2,1	0,9+1,0	05T1..(*)	12224	5507	1403	1503	5015	1803	
SCLCRL 06CA - 06	C1-95	20	6	8	6	25	8,5	12	3,5	1,1+1,3	0602..	12256CP	5508P	1403	1503	5015	1803	
SCLCRL 10CA - 09	-	40	10	14	11	50	15	20	5	3,8+5,0	09T3..	12409P	5515P	1405	1504	5002	1806C	
SCLCRL 12CA - 12	-	50	12	20	15	55	20	20	6	4,0+5,0	1204..	124510P	5520P	1405	1504	5002	1806	
SCFPRL 06CA - 05	C0-90	15	5,5	8	6	26	7,5	13	2,1	0,9+1,0	05T1..(*)	12224	5507	1403	1503	5015	1803	
SCFCRL 06CA - 06	C1-90	20	6	8	6	25	8,5	12	3,5	1,1+1,3	0602..	12256CP	5508P	1403	1503	5015	1803	
SCFCRL 10CA - 09	-	40	10	14	11	50	15	20	5	3,8+5,0	09T3..	12409P	5515P	1405	1504	5002	1806C	
SCFCRL 12CA - 12	-	50	12	20	15	55	20	20	6	4,0+5,0	1204..	124510P	5520P	1405	1504	5002	1806	
SCBCRL 20CA - 12	-	70	20	25	20	70	25	30	-	4,0+5,0	1204..	124510P	5520P	1406	1505	5025	1808	
SCWPRL 06CA - 05	C0-60	15	5,5	8	6	23,5	7,5	13	2,1	0,9+1,0	05T1..(*)	12224	5507	1403	1503	5015	1803	
SCWCRL 06CA - 06	C1-60	20	6	8	6	22	8,5	12	3,5	1,1+1,3	0602..	12256CP	5508P	1403	1503	5015	1803	
SCWCRL 10CA - 09	-	40	10	14	11	44	15	20	5	3,8+5,0	09T3..	12409P	5515P	1405	1504	5002	1806C	
SCWCRL 12CA - 12	-	50	12	20	15	47	20	20	6	4,0+5,0	1204..	124510P	5520P	1405	1504	5002	1806	



SCS.R/L..CA

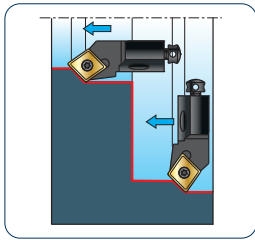

06CA..X°=20°
10CA..X°=20°
12CA..X°=20°

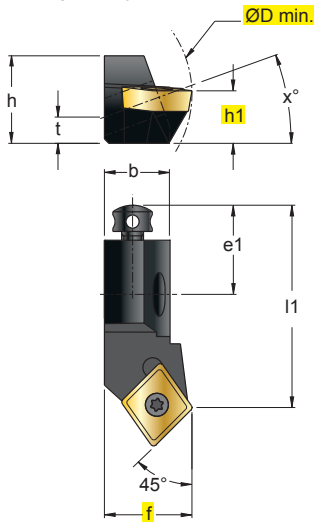

In figura utensile destro
Right-hand shown

SCT.R/L..CA

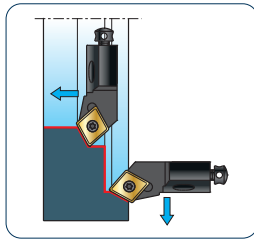

06CA..X°=20°
10CA..X°=20°
12CA..X°=20°

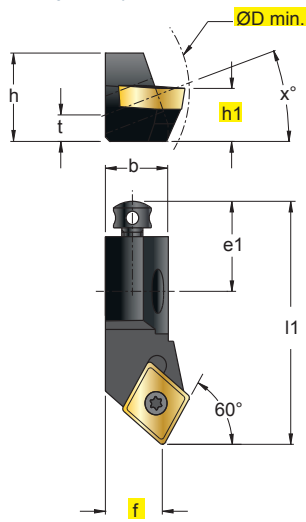

In figura utensile destro
Right-hand shown

SCR.R/L..CA

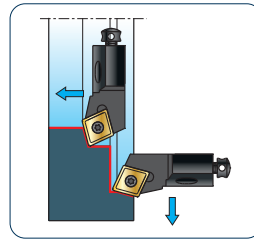

06CA..X°=20°
10CA..X°=20°
12CA..X°=20°

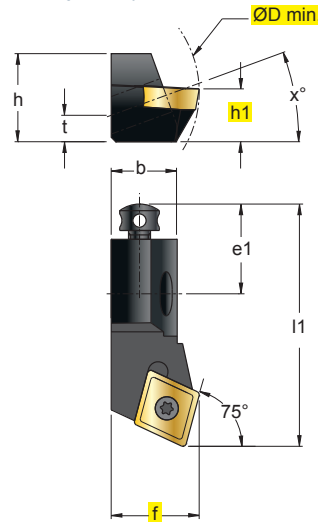

In figura utensile destro
Right-hand shown

SCGCR/L..CA

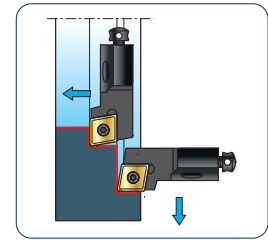

12CA..X°=20°
20CA..X°=45°

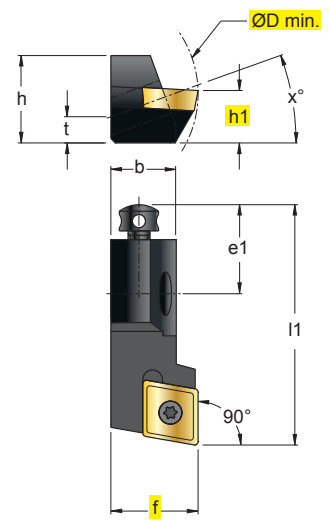

In figura utensile destro
Right-hand shown

		(mm)															
ART.	Code	ØDmin	h1	f	b	l1	h	e1	t	Nm	CPMT(*) CCMT						
SCSPR/L 06CA - 05	C0-45	15	5,5	8	6	22,5	7,5	13	2,1	0,9+1,0	05T1..(*)	12224	5507	1403	1503	5015	1803
SCSCL/R 06CA - 06	C1-45	20	6	8	6	21	8,5	12	3,5	1,1+1,3	0602..	12256CP	5508P	1403	1503	5015	1803
SCSCL/R 10CA - 09	-	40	10	14	11	44	15	20	5	3,8+5,0	09T3..	12409P	5515P	1405	1504	5002	1806C
SCSCL/R 12CA - 12	-	50	12	20	15	47	20	20	6	4,0+5,0	1204..	124510P	5520P	1405	1504	5002	1806
<hr/>																	
SCTPR/L 06CA - 05	C0-30	15	5,5	5,5	6	26	7,5	13	2,1	0,9+1,0	05T1..(*)	12224	5507	1403	1503	5015	1803
SCTCL/R 06CA - 06	C1-30	20	6	5,5	6	25	8,5	12	3,5	1,1+1,3	0602..	12256CP	5508P	1403	1503	5015	1803
SCTCL/R 10CA - 09	-	40	10	9	11	50	15	20	5	3,8+5,0	09T3..	12409P	5515P	1405	1504	5002	1806C
SCTCL/R 12CA - 12	-	50	12	13	15	55	20	20	6	4,0+5,0	1204..	124510P	5520P	1405	1504	5002	1806
<hr/>																	
SCRPR/L 06CA - 05	C0-15	15	5,5	8	6	26	7,5	13	2,1	0,9+1,0	05T1..(*)	12224	5507	1403	1503	5015	1803
SCRCL/R 06CA - 06	C1-15	20	6	8	6	25	8,5	12	3,5	1,1+1,3	0602..	12256CP	5508P	1403	1503	5015	1803
SCRCL/R 10CA - 09	-	40	10	14	11	50	15	20	5	3,8+5,0	09T3..	12409P	5515P	1405	1504	5002	1806C
SCRCL/R 12CA - 12	-	50	12	20	15	55	20	20	6	4,0+5,0	1204..	124510P	5520P	1405	1504	5002	1806
<hr/>																	
SCGCL/R 12CA - 12	-	50	12	20	16	55	20	20	6	4,0+5,0	1204..	124510P	5520P	1405	1504	5002	1806
SCGCL/R 20CA - 12	-	70	20	25	20	70	25	30	-	4,0+5,0	1204..	124510P	5520P	1406	1505	5025	1808



SXFCR/L..CA

NEW

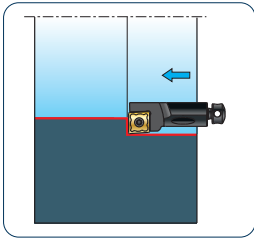

06CA..X°=20°
10CA..X°=20°

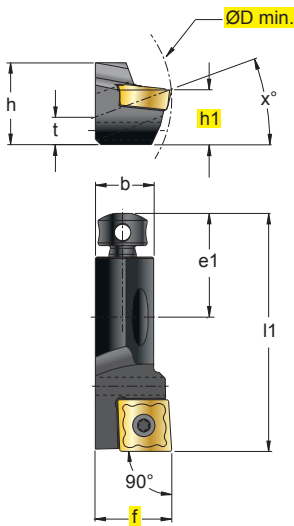

In figura utensile destro
Right-hand shown

SXWCR/L..CA

NEW

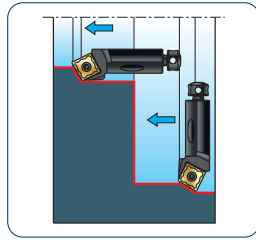

06CA..X°=20°
10CA..X°=20°

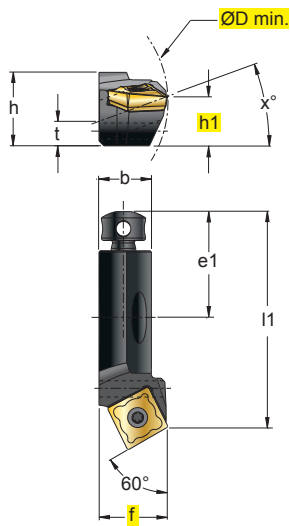

In figura utensile destro
Right-hand shown

SXSCR/L..CA

NEW

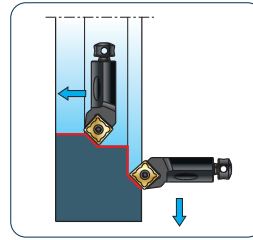

06CA..X°=20°
10CA..X°=20°

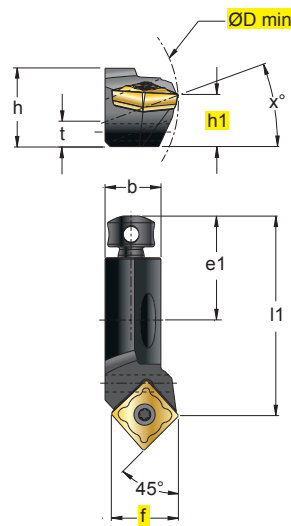

In figura utensile destro
Right-hand shown

SXTCR/L..CA

NEW

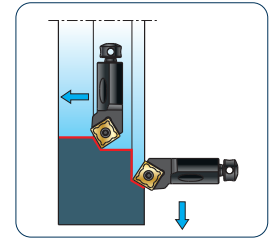

06CA..X°=20°
10CA..X°=20°

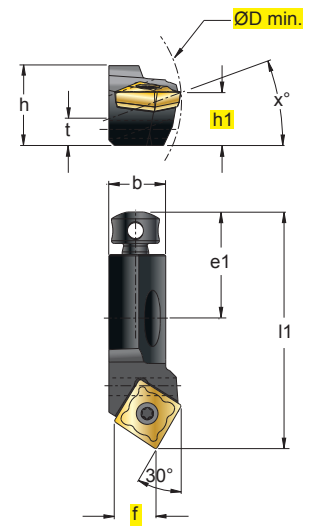

In figura utensile destro
Right-hand shown

		(mm)																
ART.	Code	ØDmin	h1	f	b	l1	h	e1	t	Nm	xc..							
SXFCR/L 06CA-06	X2-90	20	6	8	6	25	8,5	12	3,5	0,9+1,0	0602..	12225P	5507P	1403	1503	5015	1803	
SXFCR/L 10CA-09	-	40	10	14	11	50	15	20	5	1,2+1,5	09T3..	123008P	5508P	1405	1504	5002	1806C	
SXWCR/L 06CA-05	X1-60	20	6	8	6	22	8,5	12	3,5	0,5+0,6	0502..	12204P	5506P	1403	1503	5015	1803	
SXWCR/L 10CA-09	-	40	10	14	11	44	15	20	5	1,2+1,5	09T3..	123008P	5508P	1405	1504	5002	1806C	
SXSCR/L 06CA-05	X1-45	20	6	8	6	21	8,5	12	3,5	0,5+0,6	0502..	12204P	5506P	1403	1503	5015	1803	
SXSCR/L 10CA-09	-	40	10	14	11	44	15	20	5	1,2+1,5	09T3..	123008P	5508P	1405	1504	5002	1806C	
SXTCR/L 06CA-05	X1-30	20	6	5,5	6	25	8,5	12	3,5	0,5+0,6	0502..	12204P	5506P	1403	1503	5015	1803	
SXTCR/L 10CA-09	-	40	10	9	11	50	15	20	5	1,2+1,5	09T3..	123008P	5508P	1405	1504	5002	1806C	

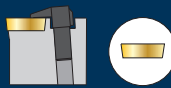

CTFPR/L..CA

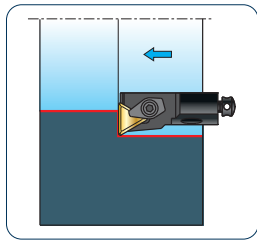

10CA..X°=20°
12CA..X°=20°

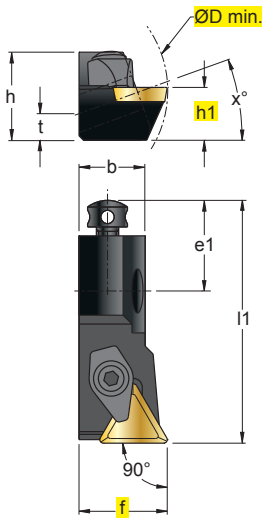

In figura utensile destro
Right-hand shown

CTWPR/L..CA

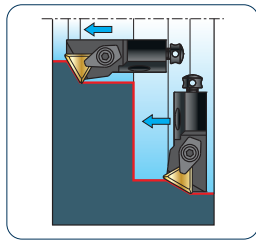

10CA..X°=20°
12CA..X°=20°

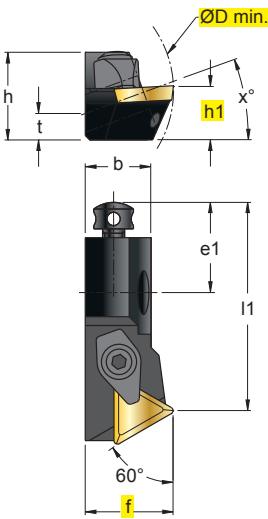

In figura utensile destro
Right-hand shown

CTSPR/L..CA

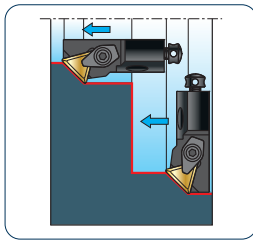

10CA..X°=20°
12CA..X°=20°

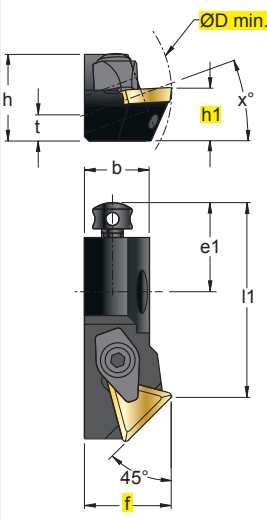

In figura utensile destro
Right-hand shown

CTTPR/L..CA

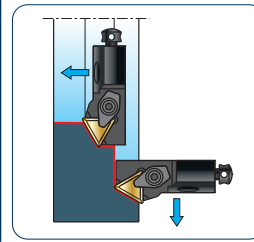

10CA..X°=20°
12CA..X°=20°

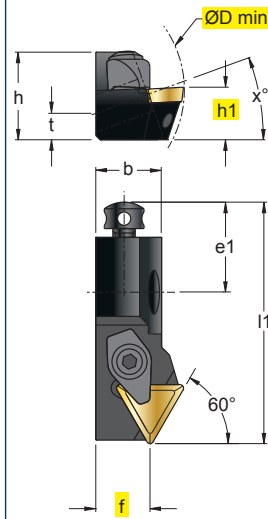

In figura utensile destro
Right-hand shown

CTGPR/L..CA

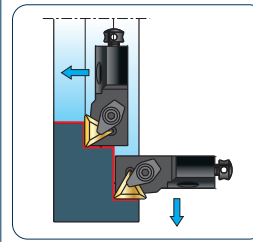

10CA..X°=20°
12CA..X°=20°

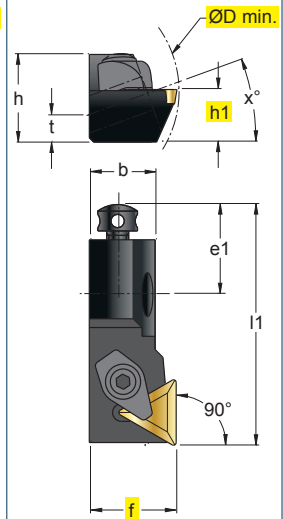

In figura utensile destro
Right-hand shown

ART.	(mm)								TPMR						
	ØDmin	h1	f	b	l1	h	e1	t							
CTFPR/L 10CA - 11	40	10	14	11	50	15	20	5	1103..	2304	5025	1405	1504	5002	1806C
CTFPR/L 12CA - 16	50	12	20	15	55	20	20	6	1603..	2305	5003	1405	1504	5002	1806
CTWPR/L 10CA - 11	40	10	14	11	44	15	20	5	1103..	2304	5025	1405	1504	5002	1806C
CTWPR/L 12CA - 16	50	12	20	15	47	20	20	6	1603..	2305	5003	1405	1504	5002	1806
CTSPR/L 10CA - 11	40	10	14	11	44	15	20	5	1103..	2304	5025	1405	1504	5002	1806C
CTSPR/L 12CA - 16	50	12	20	15	47	20	20	6	1603..	2305	5003	1405	1504	5002	1806
CTTPR/L 10CA - 11	40	10	9	11	50	15	20	5	1103..	2304	5025	1405	1504	5002	1806C
CTTPR/L 12CA - 16	50	12	13	15	55	20	20	6	1603..	2305	5003	1405	1504	5002	1806
CTGPR/L 10CA - 11	40	10	14	11	50	15	20	5	1103..	2304	5025	1405	1504	5002	1806C
CTGPR/L 12CA - 16	50	12	20	15	55	20	20	6	1603..	2305	5003	1405	1504	5002	1806

L/R348C.3..

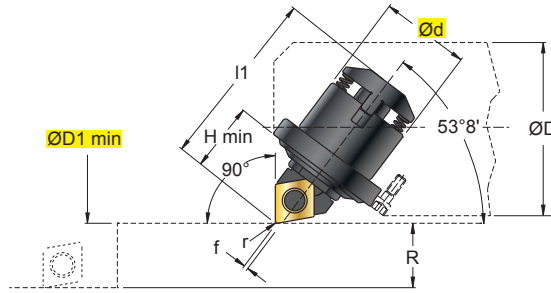

In figura utensile sinistro - Left-hand shown

CC.. 0602	
CC.. 09T3	
INSERTI - INSERTS PAG. 935	

(mm)																	
ART.	Ød	ØD1min	ØD	l1	Hmin	f	R	r	kg	Nm							
L/R348C.31.0602	16	25,4	22,0	25,0	10,9	0,36	1,52	0,4	0,03	1,1+1,3	0602	12256P	5508P	KIT 3 PZ.	5508P	45.95.640	UM050003R/L
L/R348C.32.0602	20	33,1	28,5	32,4	14,6	1,07	2,24	0,4	0,05	1,1+1,3	0602	12256P	5508P	45.95.532	5508P	45.95.640	UM060003R/L
L/R348C.33.09T3	22	42,6	38,0	43,6	17,1	1,30	2,80	0,8	0,10	3,8+5,0	09T3	12409P	5515P	45.95.536	5515P	45.95.644	UM070003R/L
L/R348C.34.09T3	32	60,0	55,0	63,2	25,9	1,56	4,00	0,8	0,27	3,8+5,0	09T3	12409P	5515P	45.95.538	5520P	45.95.644	UM080006R/L

- DATI PER IL MONTAGGIO PAG 1179
 - ASSEMBLY DATA PAG 1179
 - MONTAGEDATEN PAG 1179
 - DONNÉES POUR LE MONTAGE PAG 1179

L/R348C.3..

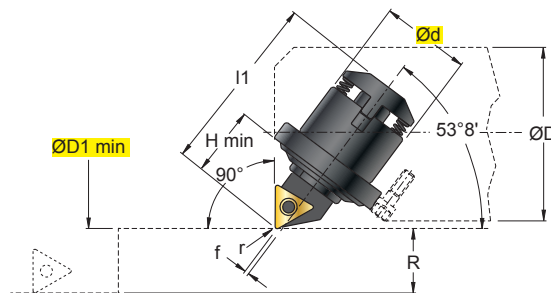

In figura utensile sinistro - Left-hand shown

TC.. 0902	
TC.. 1102	
TC.. 16T3	
INSERTI - INSERTS PAG. 938	

(mm)																	
ART.	Ød	ØD1min	ØD	l1	Hmin	f	R	r	kg	Nm							
L/R348C.32.0902	20	33,1	28,5	32,4	14,77	1,07	2,24	0,2	0,05	0,9+1,0	0902	12225P	5507P	KIT 3 PZ.	5508P	45.95.640	UM060007R/L
L/R348C.33.1102	22	42,6	38,0	43,6	17,27	1,30	2,80	0,4	0,10	1,1+1,3	1102	12256P	5508P	45.95.536	5515P	45.95.644	UM070007R/L
L/R348C.34.16T3	32	60,0	55,0	63,2	25,87	1,56	4,00	0,8	0,27	3,8+5,0	16T3	12409P	5515P	45.95.538	5520P	45.95.644	UM080007R/L

- DATI PER IL MONTAGGIO PAG 1179
 - ASSEMBLY DATA PAG 1179
 - MONTAGEDATEN PAG 1179
 - DONNÉES POUR LE MONTAGE PAG 1179

L348C.1..

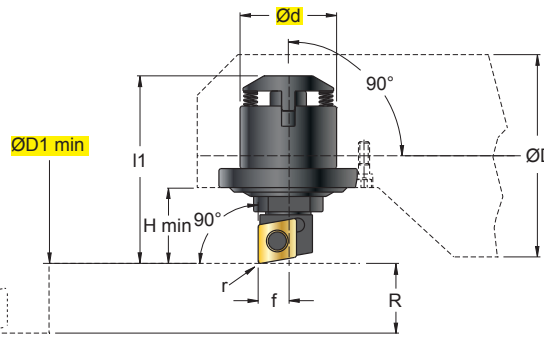

In figura utensile sinistro - Left-hand shown

CC.. 0602



CC.. 09T3



INSERTI - INSERTS
 PAG. 935

(mm)																		
ART.	Ød	ØD1min	ØD	l1	Hmin	f	R	r	kg	Nm								
L348C.11.0602	16	27,6	22,6	24,3	10,2	5,1	1,9	0,4	0,03	1,1+1,3	0602	12256P	5508P	KIT 3 PZ.	45.95.532	5508P	45.95.640	UM010003
L348C.12.0602	20	37,1	34,5	31,5	13,7	6,3	2,9	0,4	0,05	1,1+1,3	0602	12256P	5508P	45.95.532	5508P	45.95.640	UM020003	
L348C.13.09T3	22	49,1	46,5	42,8	16,3	7,2	3,5	0,8	0,10	3,8+5,0	09T3	12409P	5515P	45.95.536	5515P	45.95.644	UM030003	
L348C.14.09T3	32	69,0	67,0	62,1	25,1	10,0	5,0	0,8	0,27	3,8+5,0	09T3	12409P	5515P	45.95.538	5520P	45.95.644	UM040006	

- DATI PER IL MONTAGGIO PAG 1179
 - ASSEMBLY DATA PAG 1179
 - MONTAGEDATEN PAG 1179
 - DONNÉES POUR LE MONTAGE PAG 1179

L348C.1..

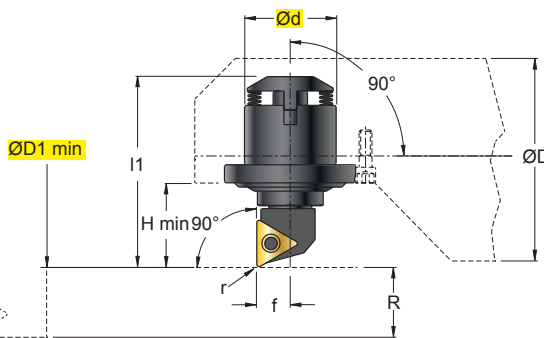

In figura utensile sinistro - Left-hand shown

TC.. 0902



TC.. 1102



TC.. 16T3



INSERTI - INSERTS
 PAG. 938

(mm)																		
ART.	Ød	ØD1min	ØD	l1	Hmin	f	R	r	kg	Nm								
L348C.12.0902	20	37,1	34,5	32,45	14,45	6,3	2,9	0,2	0,05	0,9+1,0	0902	12225P	5507P	KIT 3 PZ.	45.95.532	5508P	45.95.640	UM020007
L348C.13.1102	22	49,1	46,5	42,8	16,30	7,2	3,5	0,4	0,10	1,1+1,3	1102	12256P	5508P	45.95.536	5515P	45.95.644	UM030007	
L348C.14.16T3	32	69,0	67,0	62,1	25,10	10,0	5,0	0,8	0,27	3,8+5,0	16T3	12409P	5515P	45.95.538	5520P	45.95.644	UM040007	

- DATI PER IL MONTAGGIO PAG 1179
 - ASSEMBLY DATA PAG 1179
 - MONTAGEDATEN PAG 1179
 - DONNÉES POUR LE MONTAGE PAG 1179



S..SCACL/R

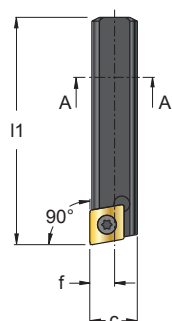
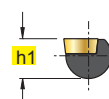
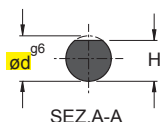
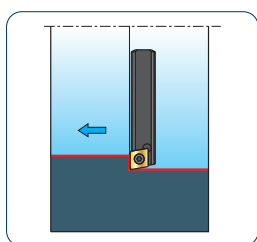

In figura utensile sinistro
Left-hand shown

S..SCECL/R

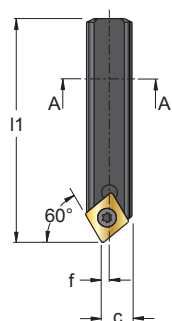
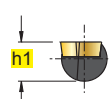
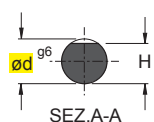
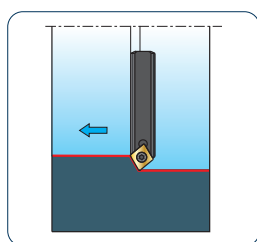

In figura utensile sinistro
Left-hand shown

S..SCDCL/R

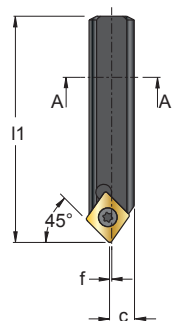
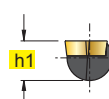
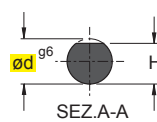
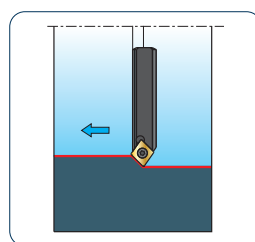

In figura utensile sinistro
Left-hand shown

S..SCWCL/R

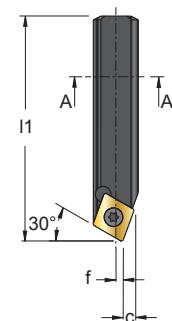
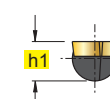
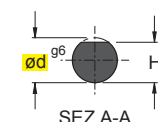
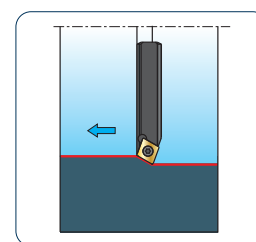

In figura utensile sinistro
Left-hand shown

		(mm)										
ART.		$\varnothing d$	h1	f	c	H	l1	kg	Nm	CC..		
S08A	SCACL/R 06	8	6,5	4,50	8,50	6,3	32	0,011	1,1+1,3	0602..	12256P	5508P
S10C	SCACL/R 06	10	8,5	5,30	10,30	8,3	50	0,028	1,1+1,3			
S12D	SCACL/R 09	12	10,5	6,70	12,70	10,3	60	0,046	3,8+5,0	09T3..	12409P	5515P
S16G	SCACL/R 09	16	11	8,20	16,20	13,8	90	0,118	3,8+5,0			
S08A	SCECL/R 06	8	6,5	1,50	5,50	6,3	32	0,011	1,1+1,3	0602..	12256P	5508P
S10C	SCECL/R 06	10	8,5	2,40	7,40	8,3	50	0,028	1,1+1,3			
S12D	SCECL/R 09	12	10,5	2,30	8,30	10,3	60	0,046	3,8+5,0	09T3..	12409P	5515P
S16G	SCECL/R 09	16	11	3,80	11,80	13,8	90	0,118	3,8+5,0			
S08A	SCDCL/R 06	8	6,5	0,10	4,10	6,3	32	0,011	1,1+1,3	0602..	12256P	5508P
S10C	SCDCL/R 06	10	8,5	1,20	6,20	8,3	50	0,028	1,1+1,3			
S12D	SCDCL/R 09	12	10,5	0,20	6,20	10,3	60	0,046	3,8+5,0	09T3..	12409P	5515P
S16G	SCDCL/R 09	16	11	2,00	10,00	13,8	90	0,118	3,8+5,0			
S08A	SCWCL/R 06	8	6,5	1,50	2,50	6,3	32	0,011	1,1+1,3	0602..	12256P	5508P
S10C	SCWCL/R 06	10	8,5	0,75	4,25	8,3	50	0,028	1,1+1,3			
S12D	SCWCL/R 09	12	10,5	1,75	4,25	10,3	60	0,046	3,8+5,0	09T3..	12409P	5515P
S16G	SCWCL/R 09	16	11	0,50	8,50	13,8	90	0,118	3,8+5,0			



S..STACL

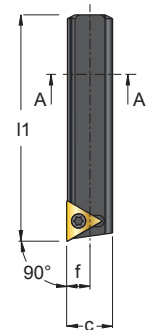
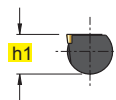
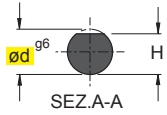
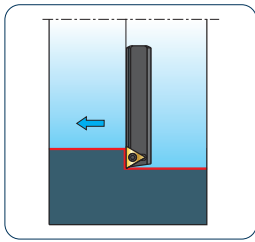

In figura utensile sinistro
Left-hand shown

S..STECL

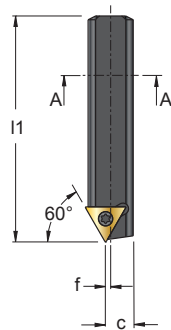
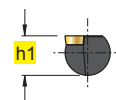
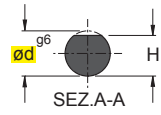
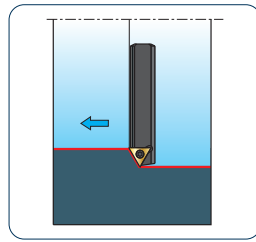

In figura utensile sinistro
Left-hand shown

S..STDCL

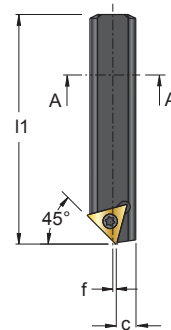
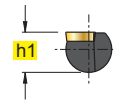
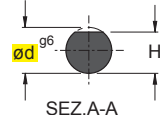
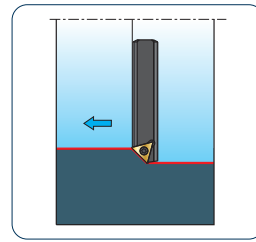

In figura utensile sinistro
Left-hand shown

S..STWCL

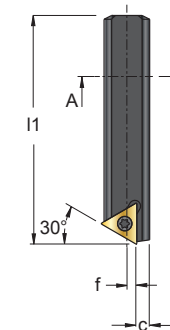
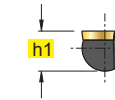
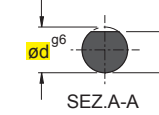
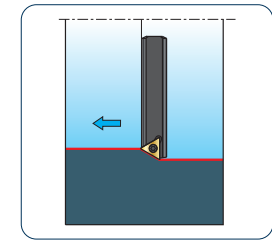



In figura utensile sinistro
Left-hand shown

(mm)																	
ART.			$\varnothing d$	h1	f	c	H	l1	kg	Nm	TC..						
S12D	STACL	11	12	10,5	6,0	12,0	10,3	60	0,046	1,1+1,3	1102..	12256P	5508P				
S16G	STACL	11	16	11	8,2	16,2	13,8	90	0,118	1,1+1,3							
S12D	STECL	11	12	10,5	1,5	7,5	10,3	60	0,046	1,1+1,3	1102..	12256P	5508P				
S16G	STECL	11	16	11	3,5	11,5	13,8	90	0,118	1,1+1,3							
S12D	STDCL	11	12	10,5	0,5	5,5	10,3	60	0,046	1,1+1,3	1102..	12256P	5508P				
S16G	STDCL	11	16	11	1,5	9,5	13,8	90	0,118	1,1+1,3							
S12D	STWCL	11	12	10,5	2,1	3,9	10,3	60	0,046	1,1+1,3	1102..	12256P	5508P				
S16G	STWCL	11	16	11	0,1	7,9	13,8	90	0,118	1,1+1,3							



	DENOMINAZIONI DEGLI INSERTI PER BARENATURA	Pag. 934
	CATALOGO DISPONIBILITÀ INSERTI	Pag. 935
	COME SCEGLIERE I PARAMETRI DI LAVORO	Pag. 941
	PANORAMICA QUALITÀ DI BARENATURA	Pag. 943
	IMPIEGO DELLE QUALITÀ DI BARENATURA	Pag. 944
	VELOCITÀ DI TAGLIO DELLE QUALITÀ DI BARENATURA	Pag. 950
	CAMPI DI IMPIEGO DEI ROMPIRUCIOLI PER BARENATURA	Pag. 954

	INSERTS DESIGNATION FOR BORING	Pag. 934
	INSERTS STOCK CATALOGUE	Pag. 935
	HOW TO CHOOSE CUTTING DATA	Pag. 941
	GENERAL VIEW OF THE BORING GRADE	Pag. 943
	APPLICATION OF THE BORING GRADE	Pag. 944
	CUTTING SPEED OF BORING GRADE	Pag. 950
	FIELDS OF APPLICATION FOR CHIP BREAKERS	Pag. 954

	BEZEICHNUNG DER WENDEPLATTEN ZUM AUSBOHREN	Pag. 934
	WENDEPLATTEN-KATALOG	Pag. 935
	EINSTELLUNG DER SCHNITTDATEN	Pag. 941
	AUSBOHREN-ÜBERSICHT	Pag. 943
	EINSATZ DER AUSBOHREN	Pag. 944
	SCHNITTGESCHWINDIGKEIT AUSBOHREN (V_c)	Pag. 950
	EINSATZGEBIETE DER SPANBRECHER	Pag. 954

	DÉNOMINATION DE LES PLAQUETTES POUR L'ALÉSAGE	Pag. 934
	CATALOGUE DE DISPONIBILITÉ PLAQUETTES	Pag. 935
	COMMENT CHOISIR LES PARAMETRES DE SERVICE	Pag. 941
	VUE D' ENSEMBLE QUALITÉ D' ALÉSAGE	Pag. 943
	UTILISATION DE LES QUALITÉS D' ALÉSAGE	Pag. 944
	VITESSE DECOUPE DE LA QUALITÉ DE PLAQUETTES D' ALÉSAGE	Pag. 950
	CHAMPS D'USINAGE DE LE BRISE-COPEAUX	Pag. 954

INSERTI PER BARENATURA



BORING INSERTS / WENDEPLATTEN ZUM AUSBOHREN / PLAQUÉTTES POUR ALÉSAGE
PLAQUITAS DE MANDRINADO



C	N	M	G
1	2	3	4

12	04	08
5	6	7

-	-
8	9

W	5	2	P
10	11	12	13

1 FORMA INSERTO
SHAPE OF INSERT

A	B
C	D
E	H
K	L
M	R
S	T
V	W

2 SPOGLIA INFER.
RELIEF ANGLE

A	3°
B	5°
C	7°
D	15°
E	20°
F	25°
G	30°
N	0°
P	11°

3 TOLLERANZA+/- (mm)
TOLERANCE+/- (mm)

	m	s	d
A	+/-0,005	+/-0,025	+/-0,025
C	+/-0,013	+/-0,025	+/-0,025
E	+/-0,025	+/-0,025	+/-0,025
F	+/-0,005	+/-0,025	+/-0,013
G	+/-0,025	+/-0,05 +/-0,13	+/-0,025
H	+/-0,013	+/-0,025	+/-0,013
J	+/-0,005	+/-0,025	+/-0,05 +/-0,13
K	+/-0,013	+/-0,025	+/-0,05 +/-0,13
L	+/-0,05	+/-0,013	+/-0,025
M	+/-0,08 +/-0,18	+/-0,13	+/-0,05 +/-0,18
N	+/-0,08 +/-0,18	+/-0,025	+/-0,05 +/-0,13
U	+/-0,13 +/-0,38	+/-0,05 +/-0,13	+/-0,08 +/-0,32

4 TIPO INSERTO
TYPE OF INSERT

A	N
B	Q
C	R
F	T
G	U
H	W
J	X SPECIALE SPECIAL
M	

5 LUNGHEZZA TAGLIANTE
CUTTING EDGE LENGTH

Ød CERCHIO INSCRITTO INSCRIBED CIRCLE	A	C	D	E	K	L	M	R	S	T	V	W
3,97												02
4,76										08		02-03
5,56		05								09		
6,00												03
6,35		06	07	06			06	06	11	11		04
6,70	10								07			
7,94				08								05
8,00												
9,45	16											
9,52	15-16	09	11	09	16	15	09		09	16	16	06
10,00								10				06
11,00									11			
11,50						12						
12,00								12				07
12,62						18						
12,70		12	15	12	15-20				12	22		08
15,87		16								15		
19,05		19								19		

6 SPESSORE
THICKNESS

S	mm
01	1,59
T1	1,97
02	2,38
T2	2,78
03	3,18
T3	3,97
04	4,76
05	5,56
06	6,35
07	7,94
09	9,52

7 RAGGIO
RADIUS

MO (mm)	r (mm)
02	r=0,2
04	r=0,4
05	r=0,5
06	r=0,6
08	r=0,8
10	r=1,0
12	r=1,2
16	r=1,6

8

F
E
T
S

9

R
L
N

10 LETTERA DI IDENTIF.
IDENTIFICATION LETTER

A	N
C	P
D	R
E	S
H	T
I	U
J	W
K	Y
L	Z
M	

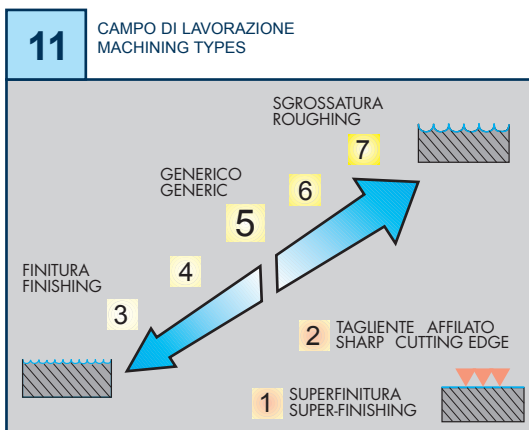

12 PREPARAZIONE TAGLIANTE
CUTTING EDGE PREPARATION

1 =	SPECIFICO PER GHISA SPECIFIC FOR CAST IRON
3 =	SPECIFICO PER ACCIAIO INOX SPECIFIC FOR STAINLESS STEEL
7 =	SPECIFICO PER LEGHE DI ALLUMINIO SPECIFIC FOR ALUMINIUM ALLOYS
	SPECIFICO PER ACCIAIO SPECIFIC FOR STEEL
2 =	
4 =	
5 =	INTERMEDI DI USO GENERICO INTERMEDIATE FOR GENERAL USE
6 =	
8 =	

13

P =	LUCIDATO POLISH
W =	GEOMETRIA CON WIPER GEOMETRY WITH WIPER

CCET CCGT CCGW CCMT							HT		HW			HC					DP					
							CERMET		NON RIVESTITI CEMENTED CARBIDE GRADES			RIVESTITI COATED GRADES BESCHICHTET RECOUVERTS					PCD					
INSERTI POSITIVI - POSITIVE INSERTS - POSITIVE WENDEPLATTEN - PLAQUÉTTES POSITIVES																						
ART.	COD.	l	d	s	d1	r	C4010	DT63	T115			T3310 €mZ	F2120	F2326 €mZ	T531			T1215 €mZ	T1225 €mZ	D3010		
	CCET 060202 L .B22	6,5	6,35	2,38	2,8	0,2		■														
	CCET 060204 L .B22	6,5	6,35	2,38	2,8	0,4		■														
	CCET 09T304 L .B22	9,7	9,52	3,97	4,4	0,4		■														
	CCGT 060202 .F47	6,5	6,35	2,38	2,8	0,2						■										
	CCGT 060204 .F47	6,5	6,35	2,38	2,8	0,4						■										
	CCGT 09T302 .F47	9,7	9,52	3,97	4,4	0,2						■										
	CCGT 09T304 .F47	9,7	9,52	3,97	4,4	0,4						■										
	CCGT 09T308 .F47	9,7	9,52	3,97	4,4	0,8						■										
	CCGT 120404 .F47	12,9	12,7	4,76	5,5	0,4						■										
	CCGT 120408 .F47	12,9	12,7	4,76	5,5	0,8						■										
	NEW																					
	CCGT 060200 .G13	6,5	6,35	2,38	2,8	0,0							■									
	CCGT 060201 .G13	6,5	6,35	2,38	2,8	0,1							■									
	CCGT 09T300 .G13	9,7	9,52	3,97	4,4	0,0							■									
	CCGT 09T301 .G13	9,7	9,52	3,97	4,4	0,1							■									
	CCGT 060201 .G57P	6,5	6,35	2,38	2,8	0,1			■													
	CCGT 060202 .G57P	6,5	6,35	2,38	2,8	0,2			■													
	CCGT 060204 .G57P	6,5	6,35	2,38	2,8	0,4			■													
	CCGT 09T302 .G57P	9,7	9,52	3,97	4,4	0,2			■													
	CCGT 09T304 .G57P	9,7	9,52	3,97	4,4	0,4			■													
	CCGT 09T308 .G57P	9,7	9,52	3,97	4,4	0,8			■													
	CCGT 120404 .G57P	12,9	12,7	4,76	5,5	0,4			■													
	CCGT 120408 .G57P	12,9	12,7	4,76	5,5	0,8			■													
	CCGW 060202 .X47	6,5	6,35	2,38	2,8	0,2															■	
	CCGW 060204 .X47	6,5	6,35	2,38	2,8	0,4															■	
	CCGW 09T302 .X47	9,7	9,52	3,97	4,4	0,2															■	
	CCGW 09T304 .X47	9,7	9,52	3,97	4,4	0,4															■	
	CCGW 09T308 .X47	9,7	9,52	3,97	4,4	0,8															■	
	CCGW 120404 .X47	12,9	12,7	4,76	5,5	0,4															■	
	CCGW 120408 .X47	12,9	12,7	4,76	5,5	0,8															■	
	CCMT 060202 .F32	6,5	6,35	2,38	2,8	0,2															■	
	CCMT 060204 .F32	6,5	6,35	2,38	2,8	0,4															■	
	CCMT 060208 .F32	6,5	6,35	2,38	2,8	0,8															■	
	CCMT 09T304 .F32	9,7	9,52	3,97	4,4	0,4															■	
	CCMT 09T308 .F32	9,7	9,52	3,97	4,4	0,8															■	
	NEW																					
	CCMT 060202 .F33	6,5	6,35	2,38	2,8	0,2							■									
	CCMT 060204 .F33	6,5	6,35	2,38	2,8	0,4							■									
	CCMT 09T304 .F33	9,7	9,52	3,97	4,4	0,4							■									
	NEW																					
	CCMT 060204 .G39	6,5	6,35	2,38	2,8	0,4		■														
	CCMT 09T304 .G39	9,7	9,52	3,97	4,4	0,4		■														
MATERIALE - MATERIAL - MATERIALIEN - MATÉRIAUX							C4010	DT63	T115			T3310 €mZ	F2120	F2326 €mZ	T531			T1215 €mZ	T1225 €mZ	D3010		
P	ACCIAIO - STEEL - STAHL - ACIER						●	●				○	○	○	○			●	●			
M	ACCIAIO INOX - STAINLESS STEEL - ROSTFREIER STAHL - ACIER INOXYDABLE						●	●				○	●	●	●				○			
K	GHISA - CAST IRON - GRAUGUSS - FONTE GRISE						○	●	○			○	○					○				
N	LEGHE DI ALLUMINIO - ALUMINIUM ALLOYS - ALUMINIUM-LEGIERUNGEN - ALLIAGES D'ALUMINIUM								●			●	○								●	
S	LEGHE RESISTENTI AL CALORE - HEAT RESISTANT ALLOYS - WÄRMEBESTÄNDIGE LEGIERUNGEN - ALLIAGES RÉISTANTES À LA CHALEUR								○			○										
H	MATERIALI DURI E TEMPRATI - HARD AND HARDENED MATERIAL - HARTE UND GEHÄRTETE MATERIALIEN - MATERIAUX DURS ET TREMPÉS																					

● DISPONIBILI - IN STOCK - LIEFERBAR - DISPONIBLES / ■ NEW
 ● APPLICAZIONE CONSIGLIATA-RECOMMENDED APPLICATION-
 EMPFOHLENER EINSATZ - APPLICATION CONSEILLÉE

○ A RICHIESTA - ON REQUEST - AUF ANFRAGE - SUR DEMANDE / □ NEW
 ○ APPLICAZIONE POSSIBILE - POSSIBLE APPLICATION -
 MÖGLICHE ANWENDUNG - APPLICATION POSSIBLE

CCMT CCMX			CPGT CPMT			HT	HW	HC										DP										
						CERMET	NON RIVESTITI CEMENTED CARBIDE GRADES	RIVESTITI COATED GRADES BESCHICHTET RECOUVERTS										PCD										
INSERTI POSITIVI - POSITIVE INSERTS - POSITIVE WENDEPLATTEN - PLAQUÉTTES POSITIVES															DT61T	T120	F2425	T1126	F2435	T1415	T1425	T3112	T3121	T3220	T1435			
ART.	COD.		l	d	s	d1	r																					
	CCMT 060202 .G42		6,5	6,35	2,38	2,8	0,2																					
	CCMT 060204 .G42		6,5	6,35	2,38	2,8	0,4																					
	CCMT 09T302 .G42		9,7	9,52	3,97	4,4	0,2																					
	CCMT 09T304 .G42		9,7	9,52	3,97	4,4	0,4																					
	CCMT 09T308 .G42		9,7	9,52	3,97	4,4	0,8																					
	CCMT 120404 .G42		12,9	12,7	4,76	5,5	0,4																					
	CCMT 09T304 .F51		9,7	9,52	3,97	4,4	0,4																					
	CCMT 09T308 .F51		9,7	9,52	3,97	4,4	0,8																					
	CCMT 120408 .F51		12,9	12,7	4,76	5,5	0,8																					
		NEW																										
	CCMT 060204 .G52		6,5	6,35	2,38	2,8	0,4																					
	CCMT 060208 .G52		6,5	6,35	2,38	2,8	0,8																					
	CCMT 09T304 .G52		9,7	9,52	3,97	4,4	0,4																					
	CCMT 09T308 .G52		9,7	9,52	3,97	4,4	0,8																					
	CCMT 120404 .G52		12,9	12,7	4,76	5,5	0,4																					
	CCMT 120408 .G52		12,9	12,7	4,76	5,5	0,8																					
	CCMT 120412 .G52		12,9	12,7	4,76	5,5	1,2																					
	CCMX 09T304 .G32W		9,7	9,52	3,97	4,4	0,4																					
	CPGT 05T102 EN .D34		5,6	5,56	1,97	2,5	0,2	■																				
	CPGT 05T104 EN .D34		5,6	5,56	1,97	2,5	0,4	■																				
	CPGT 05T102 FN .D42		5,6	5,56	1,97	2,5	0,2		■																			
	CPGT 05T104 FN .D42		5,6	5,56	1,97	2,5	0,4		■																			
	CPMT 05T102 EN .G42		5,6	5,56	1,97	2,5	0,2																					
	CPMT 05T104 EN .G42		5,6	5,56	1,97	2,5	0,4																					
MATERIALE - MATERIAL - MATERIALIEN - MATÉRIAUX								DT61T	T120	F2425	T1126	F2435	T1415	T1425	T3112	T3121	T3220	T1435										
P	ACCIAIO - STEEL - STAHL - ACIER							●			○ ● ○	● ● ○	○ ○	● ●	○ ○	○ ● ●	○ ● ●	○ ● ●	○ ● ●									
M	ACCIAIO INOX - STAINLESS STEEL - ROSTFREIER STAHL - ACIER INOXYDABLE							●	○		● ● ●	○	○	○	○				○									
K	GHISA - CAST IRON - GRAUGUSS - FONTE GRISE							○	●		●	○	○	○	● ● ●	● ● ●	● ● ●	● ● ●										
N	LEGHE DI ALLUMINIO - ALUMINIUM ALLOYS - ALUMINIUM-LEGIERUNGEN - ALLIAGES D'ALUMINIUM							○	○																			
S	LEGHE RESISTENTI AL CALORE - HEAT RESISTANT ALLOYS - WÄRMEBESTÄNDIGE LEGIERUNGEN - ALLIAGES RÉSIDANTES À LA CHALEUR																											
H	MATERIALI DURI E TEMPRATI - HARD AND HARDENED MATERIAL - HARTE UND GEHÄRTETE MATERIALIEN - MATERIAUX DURS ET TREMPÉS																											

SCGT SCMT							HT	HW	HC						DP										
							CERMET	NON RIVESTITI CEMENTED CARBIDE GRADES	RIVESTITI COATED GRADES BESCHICHTET RECOUVERTS						PCD										
INSERTI POSITIVI - POSITIVE INSERTS - POSITIVE WENDEPLATTEN - PLAQUÉTTES POSITIVES																									
ART.	COD.	l	d	s	d1	r		T115			F2115	F2425	T1126	T1425	T3121	T3220		T1435							
 .G57 NEW	SCGT 120408 .G57	12,7	12,7	4,76	5,3	0,8																			
	NEW																								
 .G57P	SCGT 09T304 .G57P	9,52	9,52	3,97	4,4	0,4		■																	
	SCGT 09T308 .G57P	9,52	9,52	3,97	4,4	0,8		■																	
 .F51 NEW	SCMT 120408 .F51	12,7	12,7	4,76	5,3	0,8																			
	NEW																								
 .G52	SCMT 09T304 .G52	9,52	9,52	3,97	4,4	0,4						■		■											
	SCMT 09T308 .G52	9,52	9,52	3,97	4,4	0,8						■	■	■	■										
	SCMT 120404 .G52	12,7	12,7	4,76	5,3	0,4						■		■											
	SCMT 120408 .G52	12,7	12,7	4,76	5,3	0,8						■		■	■								■		
	SCMT 120412 .G52	12,7	12,7	4,76	5,3	1,2						■		■									■		
MATERIALE - MATERIAL - MATERIALIEN - MATÉRIAUX																									
P	ACCIAIO - STEEL - STAHL - ACIER								T115			F2115	F2425	T1126	T1425	T3121	T3220		T1435						
M	ACCIAIO INOX - STAINLESS STEEL - ROSTFREIER STAHL - ACIER INOXYDABLE											○	●		○				○						
K	GHISA - CAST IRON - GRAUGUSS - FONTE GRISE								○				●		○	●	●								
N	LEGHE DI ALLUMINIO - ALUMINIUM ALLOYS - ALUMINIUM-LEGIERUNGEN - ALLIAGES D'ALUMINIUM								●			●													
S	LEGHE RESISTENTI AL CALORE - HEAT RESISTANT ALLOYS - WÄRMEBESTÄNDIGE LEGIERUNGEN - ALLIAGES RÉISTANTES À LA CHALEUR								○			●													
H	MATERIALI DURI E TEMPRATI - HARD AND HARDENED MATERIAL - HARTE UND GEHÄRTETE MATERIALIEN - MATERIAUX DURS ET TREMPÉS																								

■ DISPONIBILI - IN STOCK - LIEFERBAR - DISPONIBLES / ■ NEW
 ● APPLICAZIONE CONSIGLIATA-RECOMMENDED APPLICATION-
 EMPFOHLENER EINSATZ - APPLICATION CONSEILLÉE

□ A RICHIESTA - ON REQUEST - AUF ANFRAGE - SUR DEMANDE / □ NEW
 ○ APPLICAZIONE POSSIBILE - POSSIBLE APPLICATION -
 MÖGLICHE ANWENDUNG - APPLICATION POSSIBLE

TCGT TCGW TCMT	TPMR						HT	HW		HC							DP								
	CERMET		NON RIVESTITI CEMENTED CARBIDE GRADES		RIVESTITI COATED GRADES BESCHICHTET RECOUVERTS							PCD													
INSERTI POSITIVI - POSITIVE INSERTS - POSITIVE WENDEPLATTEN - PLAQUÉTTES POSITIVES													C4010	T115	T120	T1625	F2425	T7725	F2435	T1415	T1425	T3220	T1435	T540	D3010
ART.	COD.	l	d	s	d1	r																			
	TCGT 110202 .G39	11,0	6,35	2,38	2,8	0,2	■																		
	TCGT 090202 .G57P	9,6	5,56	2,38	2,5	0,2		■																	
	TCGT 090204 .G57P	9,6	5,56	2,38	2,5	0,4		■																	
	TCGT 110204 .G57P	11,0	6,35	2,38	2,8	0,4		■																	
	TCGT 16T304 .G57P	16,5	9,52	3,97	4,4	0,4		■																	
	TCGT 16T308 .G57P	16,5	9,52	3,97	4,4	0,8		■																	
	TCGW 090202 .X47	9,6	5,56	2,38	2,5	0,2																		■	
	TCGW 090204 .X47	9,6	5,56	2,38	2,5	0,4																		■	
	TCGW 110202 .X47	11,0	6,35	2,38	2,8	0,2																		■	
	TCGW 110204 .X47	11,0	6,35	2,38	2,8	0,4																		■	
	TCGW 16T304 .X47	16,5	9,52	3,97	4,4	0,4																		■	
	TCMT 110204 .G39	11,0	6,35	2,38	2,8	0,4	■																		
	TCMT 110202 .S42	11,0	6,35	2,38	2,8	0,2																		■	
	TCMT 110204 .S42	11,0	6,35	2,38	2,8	0,4			■															■	
	TCMT 16T304 .S42	16,5	9,52	3,97	4,4	0,4			■															■	
	TCMT 16T308 .S42	16,5	9,52	3,97	4,4	0,8			■															■	
	TCMT 090204 .G52	9,6	5,56	2,38	2,5	0,4					■			■	■										
	TCMT 110204 .G52	11,0	6,35	2,38	2,8	0,4					■		■	■	■	■					■				
	TCMT 110208 .G52	11,0	6,35	2,38	2,8	0,8					■		■	■	■	■					■				
	TCMT 16T304 .G52	16,5	9,52	3,97	4,4	0,4					■			■	■						■				
	TCMT 16T308 .G52	16,5	9,52	3,97	4,4	0,8					■			■	■						■				
	TCMT 16T312 .G52	16,5	9,52	3,97	4,4	1,2					■			■	■						■				
	TPMR 110304 .S44	11,0	6,35	3,18	-	0,4					■														
	TPMR 110308 .S44	11,0	6,35	3,18	-	0,8					■														
	TPMR 160304 .S44	16,5	9,52	3,18	-	0,4																			
	TPMR 160308 .S44	16,5	9,52	3,18	-	0,8																			
MATERIALE - MATERIAL - MATERIALIEN - MATÉRIAUX							C4010	T115	T120	T1625	F2425	T7725	F2435	T1415	T1425	T3220	T1435	T540	D3010						
P	ACCIAIO - STEEL - STAHL - ACIER						●			●	○	○	●	○	○			●	●						
M	ACCIAIO INOX - STAINLESS STEEL - ROSTFREIER STAHL - ACIER INOXYDABLE						●		○	○	○	○	○	○	○			○	○						
K	GHISA - CAST IRON - GRAUGUSS - FONTE GRISE						○	○	●	○	○	○	○	○	○	○									
N	LEGHE DI ALLUMINIO - ALUMINIUM ALLOYS - ALUMINIUM-LEGIERUNGEN - ALLIAGES D'ALUMINIUM							●	○													○	●		
S	LEGHE RESISTENTI AL CALORE - HEAT RESISTANT ALLOYS - WÄRMEBESTÄNDIGE LEGIERUNGEN - ALLIAGES RÉSISSANTES À LA CHALEUR							○	○													○			
H	MATERIALI DURI E TEMPRATI - HARD AND HARDENED MATERIAL - HARTE UND GEHÄRTETE MATERIALIEN - MATERIAUX DURS ET TREMPÉS																								

WCGT WCMT								HT	HW	HC	DP
								CERMET	NON RIVESTITI CEMENTED CARBIDE GRADES	RIVESTITI COATED GRADES BESCHICHTET RECOUVERTS	PCD
INSERTI POSITIVI - POSITIVE INSERTS - POSITIVE WENDEPLATTEN - PLAQUÉTTES POSITIVES											
ART.	COD.	l	d	s	d1	r	C4010	DT63			
 .B22	WCGT 020102 L .B22	2,62	3,97	1,59	2,3	0,2	■				
	WCGT 020102 R .B22	2,62	3,97	1,59	2,3	0,2	■				
	WCGT 020104 L .B22	2,62	3,97	1,59	2,3	0,4	■				
 .G39	WCGT 020102 .G39	2,62	3,97	1,59	2,3	0,2	■				
 .B56	WCMT 020102 .B56	2,62	3,97	1,59	2,3	0,2	■				
	WCMT 020104 .B56	2,62	3,97	1,59	2,3	0,4	■				
MATERIALE - MATERIAL - MATERIALIEN - MATÉRIAUX							C4010	DT63			
P	ACCIAIO - STEEL - STAHL - ACIER						●	●			
M	ACCIAIO INOX - STAINLESS STEEL - ROSTFREIER STAHL - ACIER INOXYDABLE						●	●		●	
K	GHISA - CAST IRON - GRAUGUSS - FONTE GRISE						○	●			
N	LEGHE DI ALLUMINIO - ALUMINIUM ALLOYS - ALUMINIUM-LEGIERUNGEN - ALLIAGES D'ALUMINIUM										
S	LEGHE RESISTENTI AL CALORE - HEAT RESISTANT ALLOYS - WÄRMEBESTÄNDIGE LEGIERUNGEN - ALLIAGES RÉSIANTES À LA CHALEUR										
H	MATERIALI DURI E TEMPRATI - HARD AND HARDENED MATERIAL - HARTE UND GEHÄRTETE MATERIALIEN - MATÉRIAUX DURS ET TREMPÉS										

DISPONIBILI - IN STOCK - LIEFERBAR - DISPONIBLES / NEW
 APPLICAZIONE CONSIGLIATA-RECOMMENDED APPLICATION-
 EMPFOHLENER EINSATZ - APPLICATION CONSEILLÉE

A RICHIESTA - ON REQUEST - AUF ANFRAGE - SUR DEMANDE / NEW
 APPLICAZIONE POSSIBILE - POSSIBLE APPLICATION -
 MÖGLICHE ANWENDUNG - APPLICATION POSSIBLE

SCelta VELOCE QUICK PICK

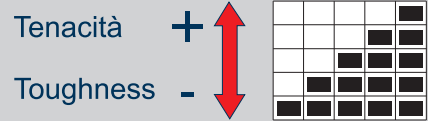

- METODO PER LA SCELTA VELOCE DEL GRADO DI METALLO DURO PIÙ IDONEO. CONTARE IL NUMERO DI RETTANGOLI COLORATI
- METHOD FOR A QUICK CHOICE OF THE MOST SUITABLE SOLID CARBIDE GRADE. COUNT THE NUMBER OF COLORED RECTANGLES
- METHODE ZUR RASCHEN AUSWAHL DER GEEIGNETSTEN HARTMETALLSORTE. DIE ANZAHL DER BUNTEN RECHTECKE ZÄHLEN
- METHODE POUR CHOISIR RAPIDEMENT LE DEGRÉ LE PLUS APPROPRIÉ DU METAL DUR. COMPTEZ LES RECTANGLES EN COULEURS
- METODO PARA LA ELECCION RAPIDA DE EL GRADO MAS ADECUADO DE METAL DURO. CONTAR LOS NUMEROS DE RECTANGULOS COLORADOS

- GRADO MOLTO RESISTENTE ALL'USURA, SOLO PER FINITURA, LAVORAZIONI AD ALTE VELOCITÀ DI TAGLIO E CONDIZIONI MOLTO RIGIDE E STABILI
- GRADE WITH HIGH RESISTANCE TO WEAR; ONLY FOR FINISHING, MACHINING AT HIGH CUTTING SPEEDS, AND VERY RIGID AND STABLE CONDITIONS
- GRADO CON ALTA RESISTENZA ALL'USURA, DISCRETA TENACITÀ PER LAVORAZIONI A VELOCITÀ MEDIO ALTE ED AVANZAMENTI MEDI, IN CONDIZIONI NORMALI
- GRADE WITH HIGH RESISTANCE TO WEAR, GOOD TOUGHNESS, FOR MEDIUM-HIGH MACHINING AND MEDIUM FEED UNDER NORMAL CONDITIONS
- GRADO CON BUONA RESISTENZA ALL'USURA UNITA A BUONA TENACITÀ, PER LAVORAZIONI GENERICHE IN CONDIZIONI NORMALI
- GRADE WITH GOOD RESISTANCE TO WEAR; COMBINED WITH A GOOD DEGREE OF TOUGHNESS, FOR GENERAL MACHINING UNDER NORMAL CONDITIONS
- GRADO CON OTTIMA TENACITÀ PER LAVORAZIONI MEDIO PESANTI O IN CONDIZIONI POCO STABILI
- GRADE WITH EXCELLENTE TOUGHNESS, FOR MEDIUM HEAVY MACHINING OR MACHINING UNDER CONDITIONS OF LOW STABILITY
- GRADO CON ECCEZIONALE TENACITÀ PER LAVORAZIONI PESANTI CON BASSE VELOCITÀ DI TAGLIO, ALTI AVANZAMENTI O IN CONDIZIONI SFAVOREVOLI
- GRADE WITH EXCELLENTE TOUGHNESS, FOR HEAVY MACHINING WITH LOW CUTTING SPEEDS, HIGH FEED, OR UNDER UNFAVORABLE CONDITIONS

GUIDA FACILE EASY GUIDE

CCMT 060204 .G52 - T1415

F	M	R	fn = 0,1-0,2 mm
○	●		P Vc = 180-400 m/min
○			M
○			K Vc = 140-430 m/min
			N
			S
			H

CCMT 060204 .G52 - T1415

P05-25 / K20-30

T1415

- GUIDA ALL'USO DELL'INSERTO. PRESENTE ANCHE SU OGNI ETICHETTA
- GUIDE FOR THE USE OF THE INSERT. ALSO LISTED ON EACH LABEL
- LEITFADEN ZUR VERWENDUNG DER WENDEPLATTE, AUCH AUF JEDEM AUFKLEBER VORHANDEN
- INSTRUCTIONS POUR L'UTILISATION DE LA PLAQUETTE. SE TROUVANT EGALEMENT SUR CHAQUE ETIQUETTE
- GUIA POR EL UTILIZO DE LA PLAQUITA, PRESENTE TAMBIEN EN CADA ETIQUETA

GR. VDI 3323 MATERIALI MATERIALS Pag. 1199	6	P	= ACCIAIO BASSO LEGATO HB 180	= LOW STEEL ALLOY
	14.1	M	= ACCIAIO INOSSIDABILE AUSTENITICO HB 180	= AUSTENITIC STAINLESS STEEL HB 180
	16	K	= GHISA GRIGIA HB 260	= GRAY CAST IRON HB 260
	21	N	= LEGHE DI ALLUMINIO HB 60	= ALUMINUM ALLOYS HB 60
	33	S	= LEGHE RESISTENTI AL CALORE (INCONEL) HB 250	= HEAT RESISTANT ALLOYS (INCONEL) HB 250
	38	H	= ACCIAIO TEMPRATO HRC 55	= TEMPERED STEEL HRC 55

- | | | |
|---|---------------------------------------|---------------------------------|
| F | = FINITURA, LAVORAZIONI LEGGERE | = FINISHING, LIGHT MACHINING |
| M | = LAVORAZIONI MEDIE, IMPIEGO GENERICO | = MEDIUM MACHINING, GENERAL USE |
| R | = SGROSSATURA, LAVORAZIONI PESANTI | = ROUGHING, HEAVY MACHINING |

- | | | |
|------------|-----------------------------|---------------------------|
| fn (mm) | = AVANZAMENTO PER TORNITURA | = FEED FOR TURNING |
| fz (mm/z) | = AVANZAMENTO PER FRESATURA | = FEED FOR MILLING |
| Vc (m/min) | = VELOCITÀ DI TAGLIO | = CUTTING SPEED |
| ● | = APPLICAZIONE CONSIGLIATA | = RECOMMENDED APPLICATION |
| ○ | = APPLICAZIONE POSSIBILE | = POSSIBLE APPLICATION |

COME SCEGLIERE I PARAMETRI DI LAVORO
HOW TO CHOOSE CUTTING DATA
EINSTELLUNG DER SCHNITTDATEN
COMMENT CHOISIR LES PARAMETRES DE SERVICE

FASE 3 - PHASE 3

SCelta DELL' AVANZAMENTO
 CHOICE OF FEED
 EINSTELLUNG DES VORSCHUBS
 CHOIX DE L'AVANCEMENT

SAU technical manual page 884. The page contains three rows of data for different materials: .G52, .G57P, and .S42. Each row includes a material image, a graph of feed rate (Fz) vs. depth of cut (Ap), and a table of recommended grades. Three magnifying glasses are overlaid on the page, highlighting the .G52, .G57P, and .S42 sections.

FASE 4 - PHASE 4

SCelta DI VC IN FUNZIONE DEL GR. VDI
 CHOICE OF VC DEPENDING ON VDI GR.
 WAHL VC JE NACH WERKSTOFF
 CHOIX DE VC EN FONCTION DU GR. VDI

SAU technical manual page 881. The page shows a table titled 'Vc(m/min)' for selecting cutting speed based on VDI material grade. The table has columns for VDI, HB, HRC, and various grades (T1425, T330, T531, T1435, T520T, T2335, T540, D3010). A magnifying glass highlights the T1425 grade in the first row.

VDI	HB	HRC	T1425	T330	T531	T1435	T520T	T2335	T540	D3010
1	125	170-240	200-340	170-300	170-190	220-280	180-230	180-230	180-230	
2	180	170-240	200-340	180-290	170-190	200-260	170-190	170-190	170-190	
3	250	170-240	200-340	170-190	170-190	180-240	180-240	130-190	130-190	
4	220	170-240	200-340	170-190	170-190	180-240	140-200	140-200	140-200	
5	300	170-240	200-340	170-190	170-190	200-260	150-190	150-190	150-190	

DIN ISO 513	P ACCIAI STEELS STAHL ACIERS					M ACCIAI INOSSIDABILI STAINLESS STEELS ROSTFREIER STAHL ACIER INOXYDABLE				K GHISE CAST IRON GRAUGUSS FONTE GRISE					N NON FERROSI NONFERROUS NICHTEISENMA PAS FERREUX				S MAT.DIFFICILI DIFFICULT MATERIAL SCHWIERIGE MATERIILIEN MAT.DIFICILES					H MATERIALI DURI HARD MATERIALS HARTE MATERIILIEN MATERIAUX DURS			
	01	10	20	30	40	50	10	20	30	40	01	10	20	30	40	01	10	20	30	01	10	20	30	40	01	10	20
HT	C4010					C4010				C4010																	
	DT61T					DT61T				DT61T																	
	DT63					DT63				DT63																	
HW						T120				T115					T115				T115								
										T120																	
HC	T1215									T3112					T3310				NEW								
	T1415									T1215					NEW												
	T1415									T1415																	
	T3220					F2120				F2120					F2115				NEW								
	T3220									T3220																	
	T1625					T1625				T1625					NEW												
	T1225					T1225				T1225																	
	T1425					T1425				T1425																	
	F2425					F2425				F2425																	
	T7725					T7725				T7725					NEW												
	T1126					T1126				T1126																	
	F2326					F2326				F2326					NEW												
	T531					T531				T531																	
	T1435					T1435				T1435																	
	DP															D3010											
TENACITÀ - TOUGHNESS - ZÄHIGKEIT - TÉNACITÉ																											
→					←				→					←				→					←				
RESISTENZA ALL'USURA - RESISTANCE TO WEAR - VERSCHLEISSFESTIGKEIT - RÉSISTANCE À L'USURE																											
AVANZAMENTO - FEED - VORSCHUB - AVANCE																											
→					←				→					←				→					←				
VELOCITÀ - SPEED - GESCHWINDIGKEIT - VITESSE																											
HT	CERMET					HW	METALLO DURO NON RICOPERTO UNCOATED CARBIDE UNBESCHICHTETES HARTMETALL MÉTAL DUR PAS RECOUVERT				HC	METALLO DURO RICOPERTO COATED CARBIDE BESCHICHTETES HARTMETALL MÉTAL DUR RECOUVERT					DP	DIAMANTE POLICRISTALLINO (PCD) POLYCRYSTALLINE DIAMOND (PCD) POLYKRISTALLINER DIAMANT (PCD) DIAMANT POLYCRISTALLIN (PCD)									

SAU	DIN ISO 513	MATERIALE - MATERIAL MATERIALIEN - MATÉRIAUX						PAG. 1199	QUICK PICK PAG. 940	 INDICAZIONI - USO
		P	M	K	N	S	H			
		ACCIAI STEELS STAHL ACIER	ACCIAI INOX STAINLESS STEELS ROSTFREIER STAHL ACIER INOXYDABLE	GHISA CAST IRON GRAUGUSS FONTE GRISE	MATTONI FERROSI NON FERROUS MAT. NICHT-EISENMATERIALIEN MAT. FERREUX	MAT DIFFICILI DIFFICULT MATERIAL SCHWERIGE MATERIALIEN MAT. DIFICILES	MATERIALI DURI HARTE MATERIALIEN MATÉRIAUX DURS			
C4010	HT	P10-20 M05-15 K05-15	●	●	○				 Tenacità + Toughness -	<ul style="list-style-type: none"> - QUALITÀ UNIVERSALE - ALTA RESISTENZA AL CALORE E ALL'USURA, BUONA TENACITÀ - INDICATO PER LE ALTE VELOCITÀ DI TAGLIO
DT61T	HT	P05-30 M05-30 K05-30	●	●	○	○			<ul style="list-style-type: none"> - ALTA RESISTENZA ALL' USURA E BUONA TENACITÀ - INDICATO PER ALTE VELOCITÀ DI TAGLIO IN SEMIFINITURA E FINITURA 	
DT63	HT	P05-25 M05-25 K05-25	●	●	●				<ul style="list-style-type: none"> - QUALITÀ MICROGRANO MOLTO RESISTENTE ALLA ROTTURA ED ALL'USURA - INDICATO PER MEDIO-ALTE VELOCITÀ DI TAGLIO IN FINITURA. 	
T115	HW	K10-20 N10-20 S10-20			○	●	○		<ul style="list-style-type: none"> - QUALITÀ MICROGRANO CON BUONA RESISTENZA ALL' USURA ELEVATA STABILITÀ DEL FILO TAGLIANTE, BASSA TENDENZA ALL'INCOLLAMENTO - INDICATO PER MEDIO-BASSE VELOCITÀ DI TAGLIO SU GHISA GRIGIA E ALTE PER MATERIALI NON FERROSI 	
T120	HW	M10-20 K10-25		○	●	●			<ul style="list-style-type: none"> - QUALITÀ MICROGRANO CON BUONA TENACITÀ - INDICATO PER MEDIO-BASSE VELOCITÀ DI TAGLIO E ALTI AVANZAMENTI. PER ASPORTAZIONI MEDIE IN SGROSSATURA 	
T3310 NEW	HC CVD	N05-20	○	○	○	●			<ul style="list-style-type: none"> - QUALITÀ MICROGRANO CON ALTA RESISTENZA ALL' USURA - INDICATO PER MEDIE VELOCITÀ DI TAGLIO IL SUO RIVESTIMENTO PERMETTE DI GARANTIRE OTTIME FINITURE SU MATERIALI ISO M-S - OTTIMA APPLICAZIONE SU FINITURE DI TUTTI GLI ALTRI MATERIALI 	
F2115 NEW	HC PVD	N10-20 S10-20				●	●		<ul style="list-style-type: none"> - QUALITÀ MICROGRANO CON ALTA RESISTENZA ALL' USURA - INDICATO PER MEDIO-BASSE VELOCITÀ DI TAGLIO SU MATERIALI ISO M-N-S 	
F2120	HC PVD	M15-25 K15-25		●	○	○	○		<ul style="list-style-type: none"> - QUALITÀ SPECIFICA PER LA LAVORAZIONE DEGLI ACCIAI INOX, PARTICOLARMENTE ADATTO ALLE LAVORAZIONI DI SUPER FINITURA - PUÒ ESSERE IMPIEGATO NELLE LAVORAZIONI DI GHISA, ALLUMINIO E LEGHE RESISTENTI AL CALORE 	
T1625	HC CVD	P10-40 M05-25 K10-40	●	○	○				<ul style="list-style-type: none"> - QUALITÀ PER UNA VASTA GAMMA DI MATERIALI - ADATTO PER LE LAVORAZIONI DI SGROSSATURA E FINITURA 	
F2425	HC PVD	P30-40 M15-35	○	●					<ul style="list-style-type: none"> - SUBSTRATO DI CARBURO APPPOSITAMENTE SVILUPPATO, RIVESTIMENTO IN PVD INNOVATIVO. - QUALITÀ CON UN'ECCELLENTI ROBUSTEZZA SENZA PREGIUDICARE LA DUREZZA A CALDO E LA RESISTENZA ALL'USURA SIA A BASSE CHE AD ALTE VELOCITÀ DI TAGLIO 	

● APPLICAZIONE CONSIGLIATA
RECOMMENDED APPLICATION
EMPFOHLENER EINSATZ
APPLICATION CONSEILLÉE

○ APPLICAZIONE POSSIBILE
POSSIBLE APPLICATION
MÖGLICHE ANWENDUNG
APPLICATION POSSIBLE

● APPLICAZIONE CONSIGLIATA
RECOMMENDED APPLICATION
EMPFOHLENER EINSATZ
APPLICATION CONSEILLÉE

○ APPLICAZIONE POSSIBILE
POSSIBLE APPLICATION
MÖGLICHE ANWENDUNG
APPLICATION POSSIBLE

 INDICATIONS - USE	 GEBRAUCHSANWEISUNGEN	 INDICATION - USAGE
<ul style="list-style-type: none"> - UNIVERSAL GRADE - HIGH HEAT AND WEAR RESISTANCE, GOOD TOUGHNESS - SUITABLE FOR HIGH CUTTING SPEEDS 	<ul style="list-style-type: none"> - UNIVERSALSORTE - HOHE HITZE- UND VERSCHLEISSBESTÄNDIGKEIT, GUTE ZÄHIGKEIT - FÜR HOHE SCHNITTGESCHWINDIGKEITEN GEEIGNET 	<ul style="list-style-type: none"> - QUALITE UNIVERSELLE - HAUTE RESISTANCE A LA CHALEUR ET A L'USURE, BONNE TENACITE - INDIQUE POUR LES HAUTES VITESSES DE COUPE
<ul style="list-style-type: none"> -HIGH RESISTANCE TO WEAR AND GOOD TOUGHNESS -SUITABLE FOR HIGH CUTTING SPEEDS FOR SEMI-FINISHING AND FINISHING 	<ul style="list-style-type: none"> -HÖHE VERSCHLEISSFESTIGKEIT UND GUTE ZÄHIGKEIT -FÜR HOHE SCHNITTGESCHWINDIGKEITEN BEIM HALBSCHLICHTEN UND SCHLICHTEN 	<ul style="list-style-type: none"> -HAUTE RÉSISTANCE À L'USURE ET BONNE TENACITÉ -INDIQUÉ POUR HAUTE VITESSE DE COUPE EN SEMIFINISSAGE ET FINISSAGE
<ul style="list-style-type: none"> -MICROGRAIN GRADE WITH VERY HIGH ULTIMATE STRENGTH AND RESISTANCE TO WEAR -SUITABLE FOR MEDIUM-HIGH CUTTING SPEEDS FOR FINISHING 	<ul style="list-style-type: none"> -MIKROKORNSORTE MIT SEHR HOHER BRUCH- UND VERSCHLEISSFESTIGKEIT -FÜR HOHE SCHNITTGESCHWINDIGKEITEN BEIM SCHLICHTEN GEEIGNET 	<ul style="list-style-type: none"> -QUALITÉ DE MICROGRAIN TRÈS RÉSIDANT À LA RUPTURE ET À L'USURE -INDIQUÉ POUR HAUTE VITESSE DE COUPE EN FINISSAGE
<ul style="list-style-type: none"> - MICROGRAIN GRADE WITH GOOD WEAR RESISTANCE, HIGH CUTTING EDGE STABILITY, LOW TENDENCY TO STICKING - SUITABLE FOR LOW-MEDIUM CUTTING SPEEDS ON GREY CAST IRON AND OTHER NON-FERROUS MATERIALS 	<ul style="list-style-type: none"> - FEINKORNSORTE MIT GUTER VERSCHLEISSBESTÄNDIGKEIT, HOHE ECKENSTABILITÄT, GERINGERE NEIGUNG ZUM KLEBEN - FÜR MITTLERE BIS NIEDRIGE SCHNITTGESCHWINDIGKEITEN FÜR GUSS UND ANDERE NICHT-EISENMATERIALIEN GEEIGNET 	<ul style="list-style-type: none"> - QUALITÉ MICROGRAIN AVEC BONNE RESISTANCE A L'USURE ELEVEE, STABILITE DU FIL TRANCHANT, FAIBLE TENDANCE A L'ADHERENCE - INDIQUE POUR DES VITESSES HAUTES-MOYENNES DE COUPE SUR FONTE GRISE ET VITESSES HAUTES POUR DES MATERIAUX NON FERREUX
<ul style="list-style-type: none"> - MICROGRAIN GRADE WITH GOOD TOUGHNESS - SUITABLE FOR MEDIUM CUTTING SPEEDS AND HIGH FEED FOR ROUGHING WITH MEDIUM REMOVAL OF MATERIAL 	<ul style="list-style-type: none"> -MIKROKORN SORTE MIT GUTER ZÄHIGKEIT -FÜR MITTEL-NIEDRIGE SCHNITTGESCHWINDIGKEITEN GROSSE VORSCHÜBE FÜR MITTLERE ZERSPANNUNG BEIM SCHRUPPEN GEEIGNET 	<ul style="list-style-type: none"> -QUALITÉ DE MICROGRAIN AVEC BONNE TENACITE -INDIQUÉE POUR MOYENNE-FAIBLE VITESSE DE COUPE ET HAUTE DÉPLACEMENT POUR MOYEN EMPORTATION EN ÉBAUCHAGE
<ul style="list-style-type: none"> - MICROGRAIN GRADE WITH HIGH RESISTANCE TO WEAR - SUITABLE FOR MEDIUM CUTTING SPEEDS, ITS COATING ALLOWS FOR EXCELLENT FINISHES ON ISO M-S MATERIALS - EXCELLENT FOR FINISHING APPLICATIONS ON ALL OTHER MATERIALS 	<ul style="list-style-type: none"> - MIKROKORN-SORTE MIT HOHER VERSCHLEISSFESTIGKEIT - GEEIGNET FÜR MITTLERE SCHNITTGESCHWINDIGKEITEN. HERVORRAGENDE OBERFLÄCHENGÜTE AUF ISO – M-S-MATERIALIEN DANK DER BESONDEREN BESCHICHTUNG - HERVORRAGEND ZUM SCHLICHTEN AUF ALLEN ANDEREN MATERIALIEN 	<ul style="list-style-type: none"> - QUALITÉ MICROGRAIN AVEC HAUTE RÉSISTANCE À L'USURE - INDIQUÉ POUR DES VITESSES DE DÉCOUPE MOYENNES, SON REVÊTEMENT PERMET DE GARANTIR DES FINITIONS PARFAITES SUR DES MATÉRIAUX ISO M-S - APPLICATION PARFAITE SUR LES FINITIONS DE TOUS LES AUTRES MATÉRIAUX
<ul style="list-style-type: none"> - MICROGRAIN GRADE WITH HIGH RESISTANCE TO WEAR - SUITABLE FOR MEDIUM TO LOW CUTTING SPEEDS ON ISO M-S MATERIALS 	<ul style="list-style-type: none"> - MIKROKORN-SORTE MIT HOHER VERSCHLEISSFESTIGKEIT - GEEIGNET FÜR MITTLERE BIS NIEDRIGE SCHNITTGESCHWINDIGKEITEN AUF ISO-M-S-MATERIALIEN. 	<ul style="list-style-type: none"> - QUALITÉ MICROGRAIN AVEC HAUTE RÉSISTANCE À L'USURE - INDIQUÉ POUR VITESSE DE DÉCOUPE FAIBLE À MOYENNE SUR MATÉRIAUX ISO M-N-S
<ul style="list-style-type: none"> - SPECIFIC GRADE FOR INOX STEEL, PARTICULARLY SUITABLE FOR SUPER-FINISHING - IT CAN BE USED FOR CAST IRON, ALUMINIUM AND HEAT-RESISTANT ALLOYS 	<ul style="list-style-type: none"> - SPEZIALSORTE FÜR INOX-STAHL, BESONDERS ZUM FEIN-SCHLICHTEN GEEIGNET -EINSETZBAR FÜR GUSS, ALUMINIUM UND HITZEBESTÄNDIGE LEGIERUNGEN 	<ul style="list-style-type: none"> - QUALITE SPECIFIQUE POUR L'USINAGE DES ACIERS INOX, SPECIALEMENT PREVUE POUR LES USINAGES DE SUPER FINITION - PEUT ETRE EMPLOYEE DANS LES USINAGES DE FONTE, ALUMINIUM ET ALLIAGES RESISTANTS A LA CHALEUR
<ul style="list-style-type: none"> - GRADE FOR A WIDE RANGE OF MATERIALS - SUITABLE FOR ROUGHING AND FINISHING 	<ul style="list-style-type: none"> - SORTE FÜR EINE VIELZAHL VON MATERIALIEN - FÜR SCHRUPPEN UND SCHLICHTEN GEEIGNET 	<ul style="list-style-type: none"> - QUALITE POUR UNE VASTE GAMME DE MATERIAUX - PREVU POUR LES USINAGES DE DEGROSSISSAGE ET DE FINITION
<ul style="list-style-type: none"> - SPECIALLY DEVELOPED CARBIDE SUBSTRATE, INNOVATIVE PVD COATING - GRADE WITH EXCELLENT TOUGHNESS WHICH DOES NOT AFFECT RED HARDNESS AND WEAR RESISTANCE, AT BOTH LOW AND HIGH CUTTING SPEEDS 	<ul style="list-style-type: none"> - SPEZIELL ENTWICKELTES KARBIDSUBSTRAT, INNOVATIVE PVD-BESCHICHTUNG. - SORTE MIT HERVORRAGENDER ROBUSTHEIT BEI UNVERÄNDERTER WARMHÄRTE UND VERSCHLEISSBESTÄNDIGKEIT SOWOHL MIT NIEDRIGEN ALS AUCH MIT HOHEN SCHNITTGESCHWINDIGKEITEN 	<ul style="list-style-type: none"> - SUBSTRAT DE CARBURE SPÉCIALEMENT DÉVELOPPÉ, REVÊTEMENT EN PVD INNOVANT. - QUALITÉ AVEC UNE ROBUSTESSE EXCELLENTE SANS PORTER PRÉJUDICE À LA DURETÉ À CHAUD ET À LA RÉSISTANCE À L'USURE À BASSES VITESSES COMME À HAUTES VITESSES DE COUPE

HT CERMET

HW

METALLO DURO NON RICOPERTO
UNCOATED CARBIDE
UNBESCHICHTETES HARTMETALL
MÉTAL DUR PAS RECOUVERT

HC

METALLO DURO RICOPERTO
COATED CARBIDE
BESCHICHTETES HARTMETALL
MÉTAL DUR RECOUVERT

DP

DIAMANTE POLICRISTALLINO (PCD)
POLYCRYSTALLINE DIAMOND (PCD)
POLYKRISTALLINER DIAMANT (PCD)
DIAMANT POLYCRISTALLIN (PCD)

SAU	DIN ISO 513	MATERIALE - MATERIAL MATERIALEN - MATÉRIAUX PAG. 1199						QUICK PICK PAG. 940	 INDICAZIONI - USO	
		P	M	K	N	S	H			
		ACCIAI STEELS STAHL ACIER	ACCIAI INOX STAINLESS STEELS ROSTFREIER STAHL ACIER INOXYDABLE	GHISA CAST IRON GRAUGUSS FONTE GRISE	MATTONI FERROSI NON FERROUS MAT. NICHT-EISENMATERIALIEN MAT. FERREUX	MAT. DIFFICILI DIFFICULT MATERIAL SCHWERIGE MATERIALIEN MAT. DIFCILES	MATERIALI DURI HARD MATERIALS HARTE MATERIALIEN MATÉRIAUX DURS			
T7725 NEW	HC	P15-35	●	○	○			 Tenacità + Toughness -		<ul style="list-style-type: none"> - QUALITÀ UNIVERSALE - ALTA RESISTENZA ALL'USURA E TAGLIANTE TENACE PER TORNITURA DI ACCIAI, INDICATA ANCHE PER GLI ACCIAI INOSSIDABILI E GHISE. - AFFIDABILE PER LAVORAZIONE CON VELOCITÀ DI TAGLIO LIMITATE
	CVD	M10-30 K15-35								
T1126	HC	P15-35	●	●	●					<ul style="list-style-type: none"> - SUBSTRATO MIGLIORATO CON BUONA RESISTENZA ALL'USURA E ALL'ABRASIONE - ADATTO PERE LAVORAZIONI SENZA L'AUSILIO DEL LUBROREFRIGERANTE.
	CVD	M10-25 K25-35								
F2326 NEW	HC	P15-30	○	●						<ul style="list-style-type: none"> - QUALITA' MICR OGRANO CON ALTA RESISTENZA ALL' USURA E BUONA TENACITA' - OTTIMA APPLICAZIONE PER LAVORI DI FINITURA SU ISO M-S
	PVD	M15-30								
F2435	HC	P35-45	○	●						<ul style="list-style-type: none"> - SUBSTRATO DI CARBURO APPPOSITAMENTE SVILUPPATO - RIVESTIMENTO IN PVD INNOVATIVO. FORNISCE UN'ECCELLEENTE ROBUSTEZZA E OTTIMA TENACITÀ SENZA PREGIUDICARE LA DUREZZA A CALDO SIA A BASSE CHE AD ALTE VELOCITÀ DI TAGLIO
	PVD	M25-45								
T3112 NEW	HC				●					<ul style="list-style-type: none"> - ALTA RESISTENZA ALL'USURA, ADATTO PER LAVORAZIONI DI SPIANATURA IN CONDIZIONI STABILI
	CVD	K05-20								
T1415	HC	P05-25	●		○					<ul style="list-style-type: none"> - GRADO INSERTO IDEALE PER LA PRODUZIONE AD ALTO VOLUME - BUONA RESISTENZA AL CALORE CHE LO RENDE PERFETTAMENTE ADATTO PER LA LAVORAZIONE A SECCO ANCHE AD ALTE VELOCITÀ DI TAGLIO
	CVD	K10-35								
T3220	HC	P01-20	○		●					<ul style="list-style-type: none"> - GRADO DA TORNITURA PER LA LAVORAZIONE DELLA GHIA GRIGIA E SFEROIDALE
	CVD	K10-30								
T3121 NEW	HC				●					<ul style="list-style-type: none"> - GRADO SPECIFICO PER LAVORAZIONE DI GHISA. PER LAVORAZIONI IN GENERE ANCHE PER TAGLIO INTERROTTO, IDEALE PER GHISE GRIGIE E SFEROIDALI
	CVD	K10-25								
T1425	HC	P15-35	●	○	○					<ul style="list-style-type: none"> - VASTA GAMMA DI IMPIEGHI, IDEALE PER TUTTE LE LEGHE DI ACCIAIO E GHISA, BUONE PRESTAZIONI ANCHE SU INOX
	CVD	M10-25 K25-35								
T531	HC	P15-30	○	●						<ul style="list-style-type: none"> -QUALITA' MICROGRANO TENACE CON BUONA RESISTENZA AGLI URTI ED AGLI SHOCK TERMICI - INDICATO PER MEDIE E MEDIO-BASSE VELOCITA' DI TAGLIO
	CVD	M20-40								

● APPLICAZIONE CONSIGLIATA
RECOMMENDED APPLICATION
EMPFOHLENER EINSATZ
APPLICATION CONSEILLÉE

○ APPLICAZIONE POSSIBILE
POSSIBLE APPLICATION
MÖGLICHE ANWENDUNG
APPLICATION POSSIBLE

● APPLICAZIONE CONSIGLIATA
RECOMMENDED APPLICATION
EMPFOHLENER EINSATZ
APPLICATION CONSEILLÉE

○ APPLICAZIONE POSSIBILE
POSSIBLE APPLICATION
MÖGLICHE ANWENDUNG
APPLICATION POSSIBLE

 INDICATIONS - USE	 GEBRAUCHSANWEISUNGEN	 INDICATION - USAGE
<ul style="list-style-type: none"> - UNIVERSAL GRADE - HIGH RESISTANCE TO WEAR AND TOUGH CUTTING EDGE FOR TURNING STEEL, ALSO SUITABLE FOR STAINLESS STEEL AND CAST IRON. - RELIABLE FOR MACHINING AT LIMITED CUTTING SPEEDS 	<ul style="list-style-type: none"> - UNIVERSALSORTE - HOHE VERSCHLEIßFESTIGKEIT UND ZÄHE SCHNEIDKANTE FÜR DAS DREHEN VON STÄHLEN, AUCH GEEIGNET FÜR ROSTFREIE STÄHLE UND GUSS. - ZUVERLÄSSIG BEIM BEARBEITEN MIT BEGRENZTEN SCHNITTGESCHWINDIGKEITEN 	<ul style="list-style-type: none"> - QUALITÉ UNIVERSELLE - HAUTE RÉSIDANCE À L'USURE ET ARÊTE DE COUPE RÉSIDANTE POUR LE TOURNAGE DES ACIERS, CONVIENT AUSSI AUX ACIERS INOXYDABLES ET FONTES. - FIABLE EN CAS D'USINAGE AVEC DES VITESSES DE DÉCOUPE LIMITÉES
<ul style="list-style-type: none"> - IMPROVED SUBSTRATE WITH GOOD RESISTANCE TO WEAR AND ABRASION - SUITABLE FOR MACHINING WITHOUT COOLING LUBRICANT 	<ul style="list-style-type: none"> - VERBESSERTES SUBSTRAT MIT GUTER VERSCHLEIßBESTÄNDIGKEIT UND ABRIEBFESTIGKEIT - ZUR BEARBEITUNG OHNE KÜHLSCHMIERSTOFF GEEIGNET 	<ul style="list-style-type: none"> - SUBSTRAT AMÉLIORÉ AVEC BONNE RÉSIDANCE À L'USURE ET À L'ABRASION - SPÉCIALEMENT PRÉVU POUR LES USINAGES SANS LUBRIFIANT-RÉFRIGÉRANT.
<ul style="list-style-type: none"> - MICROGRAIN GRADE WITH HIGH RESISTANCE TO WEAR AND GOOD TOUGHNESS - EXCELLENT FOR FINISHING APPLICATIONS ON ISO M-S MATERIALS 	<ul style="list-style-type: none"> - MIKROKORN-SORTE MIT HOHER VERSCHLEIßFESTIGKEIT UND GUTER ZÄHIGKEIT - HERVORRAGEND ZUM SCHLICHTEN AUF ISO-M-S-MATERIALIEN 	<ul style="list-style-type: none"> - QUALITÉ MICROGRAIN AVEC HAUTE RÉSIDANCE À L'USURE ET BONNE DURETÉ - APPLICATION PARFAITE POUR TRAVAUX DE FINITION SUR ISO M-S
<ul style="list-style-type: none"> - SPECIALLY DEVELOPED CARBIDE SUBSTRATE - INNOVATIVE PVD COATING PROVIDING EXCELLENT STRENGTH AND VERY GOOD TOUGHNESS WITHOUT AFFECTING RED HARDNESS AT BOTH LOW AND HIGH CUTTING SPEED 	<ul style="list-style-type: none"> - SPEZIELL ENTWICKELTES KARBID-SUBSTRAT - INNOVATIVE PVD-BESCHICHTUNG FÜR EXCELLENTE ROBUSTHEIT UND OPTIMALE ZÄHIGKEIT OHNE BEEINTRÄCHTIGUNG DER WARMHÄRTE BEI SOWOHL HOHEN ALS AUCH NIEDRIGEN SCHNITTGESCHWINDIGKEITEN 	<ul style="list-style-type: none"> - SUBSTRAT DE CARBURE SPÉCIALEMENT DÉVELOPPÉ - REVÊTEMENT EN PVD INNOVANT, FOURNIT UNE ROBUSTESSE ET TENACITÉ EXCELLENTE, SANS POUR AUTANT PORTER PRÉJUDICE À LA DURETÉ À CHAUD À DE BASSES COMME À DE HAUTES VITESSES DE COUPE.
<ul style="list-style-type: none"> - HIGH RESISTANCE TO WEAR, SUITABLE FOR FACING UNDER STABLE CONDITIONS 	<ul style="list-style-type: none"> - HOHE VERSCHLEISSFESTIGKEIT, ZUR PLANBEARBEITUNG UNTER STABILEN BEDINGUNGEN GEEIGNET 	<ul style="list-style-type: none"> - HAUTE RÉSIDANCE À L'USURE, INDIQUÉ POUR LES OPÉRATIONS DE SURFAÇAGE DANS DES CONDITIONS STABLES.
<ul style="list-style-type: none"> - IDEAL GRADE FOR HIGH VOLUME MACHINING - GOOD HEAT RESISTANCE AND THEREFORE PERFECTLY SUITABLE FOR DRY MACHINING, EVEN AT HIGH CUTTING SPEEDS 	<ul style="list-style-type: none"> - IDEALE SORTE FÜR HOCHVOLUMENFERTIGUNG - GUTE HITZEBESTÄNDIGKEIT UND DAHER PERFEKT FÜR DIE TROCKENBEARBEITUNG, AUCH MIT HOHEN SCHNITTGESCHWINDIGKEITEN 	<ul style="list-style-type: none"> - DEGRÉ PLAQUETTE IDÉAL POUR LA PRODUCTION À HAUT VOLUME - BONNE RÉSIDANCE À LA CHALEUR, QUI LE REND PARFAITEMENT INDIQUÉ POUR L'USINAGE À SEC MÊME À DE HAUTES VITESSES DE COUPE
<ul style="list-style-type: none"> - TURNING GRADE FOR GREY CAST IRON AND NODULAR CAST IRON 	<ul style="list-style-type: none"> - DREHSORTE FÜR DIE BEARBEITUNG VON GUSS UND SPHÄROGUSS 	<ul style="list-style-type: none"> - DEGRÉ DE TOURNAGE POUR L'USINAGE DE LA FONTE GRISE ET SPHÉROÏDALE
<ul style="list-style-type: none"> - CAST IRON-SPECIFIC INSERT GRADE FOR GENERAL PURPOSE, ALSO FOR INTERRUPTED CUTTING. BEST SUITED FOR GREY AND NODULAR CAST IRON 	<ul style="list-style-type: none"> - SPÉCIFIQUE SORTE FÜR GUSSEISEN ALLGEMEIN EINSETZBAR, AUCH FÜR UNTERBROCHENEN SCHNITT, IDEAL FÜR GRAU- UND SPHÄROGUSS 	<ul style="list-style-type: none"> - DEGRÉ SPÉCIFIQUE POUR L'USINAGE DE LA FONTE. POUR LES EXÉCUTIONS EN GÉNÉRAL MÊME EN CAS DE DÉCOUPAGE INTERROMPU, PARFAIT POUR LES FONTES GRISES ET SPHÉROÏDALES
<ul style="list-style-type: none"> - WIDE RANGE OF APPLICATIONS, IDEAL FOR ALL STEEL AND CAST IRON ALLOYS, GOOD PERFORMANCE ALSO ON INOX 	<ul style="list-style-type: none"> - HOHE VIELSEITIGKEIT, IDEAL FÜR ALLE STAHL- UND GUSSLEGIERUNGEN, GUTE LEISTUNG AUCH MIT INOXSTAHL 	<ul style="list-style-type: none"> - VASTE GAMME D'EMPLOIS, IDÉAL POUR TOUS LES ALLIAGES EN ACIER ET FONTE, BONNES PERFORMANCES MÊME SUR INOX
<ul style="list-style-type: none"> - TOUGH MICROGRAIN GRADE WITH HIGH RESISTANCE TO SHOCK AND THERMAL SHOCK. - SUITABLE FOR MEDIUM AND MEDIUM-LOW CUTTING SPEEDS 	<ul style="list-style-type: none"> - MIKROKORNSORTE MIT HOHER STOSSFESTIGKEIT UND TEMPERATURWECHSELBESTÄNDIGKEIT - FÜR MITTLERE UND MITTEL-NIEDRIGE SCHNITTGESCHWINDIGKEITEN GEEIGNET 	<ul style="list-style-type: none"> - QUALITÉ DE MICROGRAIN TENACE AVEC BONNE RÉSIDANCE AU COUPS ET AU SHOCKS THERMIQUES. - INDIQUÉE POUR MOYENNE ET MOYENNE-FAIBLE VITESSE DE COUPE

HT CERMET

HW

METALLO DURO NON RICOPERTO
UNCOATED CARBIDE
UNBESCHICHTETES HARTMETALL
MÉTAL DUR PAS RECOUVERT

HC

METALLO DURO RICOPERTO
COATED CARBIDE
BESCHICHTETES HARTMETALL
MÉTAL DUR RECOUVERT

DP

DIAMANTE POLICRISTALLINO (PCD)
POLYCRYSTALLINE DIAMOND (PCD)
POLYKRISTALLINER DIAMANT (PCD)
DIAMANT POLYCRISTALLIN (PCD)

SAU	DIN ISO 513	MATERIALE - MATERIAL MATERIALEN - MATÉRIAUX PAG. 1199						QUICK PICK PAG. 940	 INDICAZIONI - USO	
		P	M	K	N	S	H			
		ACCIAI STEELS STAHL ACIER	ACCIAI INOX STAINLESS STEELS ROSTFREIER STAHL ACIER INOXYDABLE	GHISA CAST IRON GRAUGUSS FONTE GRISE	MATTONI FERROSI NON FERROSI MAT. NICHT-EISENMATERIALIEN MAT. FERREUX	MAT. DIFFICILI DIFFICIL MATERIALIEN SCHWERIGE MATERIALIEN MAT. DIFICILES	MATERIALI DURI HARTE MATERIALIEN MATÉRIAUX DURS	Tenacità + Toughness -	 	
T1435	HC P25-45 M20-30 CVD	●	○						● ●	- GRADO INSERTO TENACE PER LAVORAZIONI DIFFICILI CON CONDIZIONI INSTABILI E A TAGLIO INTERROTTO
T1215 NEW	HC P10-25 CVD K10-25	●		○						- QUALITÀ PER MASSIMA VELOCITÀ DI TAGLIO CON TORNITURA DA LEGGERA A MEDIA, GRAZIE ALLO SPECIALE RIVESTIMENTO QUESTO TIPO È ESTREMAMENTE RESISTENTE ALL'USURA
T1225 NEW	HC P15-35 M15-35 CVD	●	○						● ●	- QUESTA VARIETÀ MULTI-GAMMA È CARATTERIZZATA DA ELEVATA RESISTENZA ALL'USURA ED ECCELLENTI PROPRIETÀ DI TENACITÀ A UNA VASTA GAMMA DI APPLICAZIONI.
T2335	HC M25-45 CVD		●						●	- BUONA TENACITÀ E RESISTENZA ALL'USURA. - QUALITÀ, IDEALE PER LA TORNITURA DI ACCIAI AUSTENITICI INOSSIDABILI.
T540	HC P20-43 M25-40 CVD	●	○			○			●	- OTTIMA TENACITÀ, RESISTENZA ALL'USURA E ALLA SCHEGGIATURA - INDICATO PER MEDIO-BASSE VELOCITÀ DI TAGLIO
D3010	DP N01-10				●				●	- GRADO INDICATO PER LA TORNITURA DI MATERIALI NON FERROSI, ES. LEGHE DI ALLUMINIO, MEGLIO SE AD ALTO TENORE DI SILICIO, RAME, BRONZO TERMOPLASTICI RINFORZATI E COMPOSITI. - OTTIMA FINITURA E VITA UTENSILE.

● APPLICAZIONE CONSIGLIATA
RECOMMENDED APPLICATION
EMPFOHLENER EINSATZ
APPLICATION CONSEILLÉE

○ APPLICAZIONE POSSIBILE
POSSIBLE APPLICATION
MÖGLICHE ANWENDUNG
APPLICATION POSSIBLE

● APPLICAZIONE CONSIGLIATA
RECOMMENDED APPLICATION
EMPFOHLENER EINSATZ
APPLICATION CONSEILLÉE

○ APPLICAZIONE POSSIBILE
POSSIBLE APPLICATION
MÖGLICHE ANWENDUNG
APPLICATION POSSIBLE



















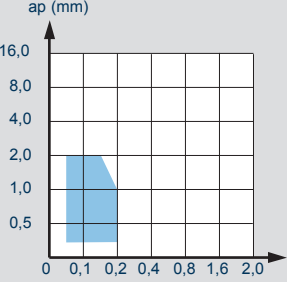

















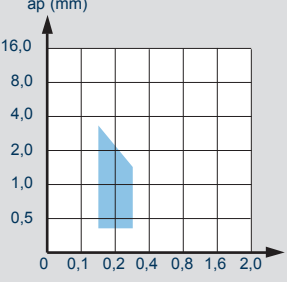

















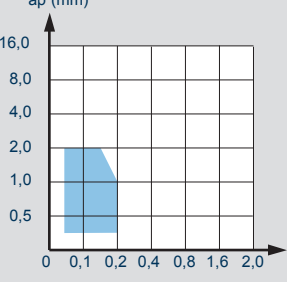









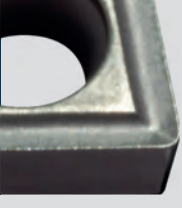







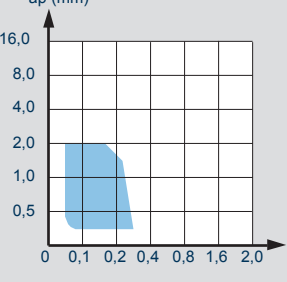









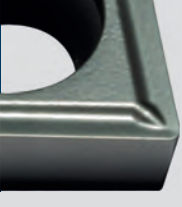





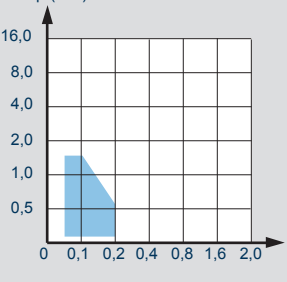

 INDICATIONS - USE	 GEBRAUCHSANWEISUNGEN	 INDICATION - USAGE
- TOUGH DEGREE FOR DIFFICULT MACHINING UNDER UNSTABLE CONDITIONS AND WITH INTERRUPTED CUT	- ZÄHE SORTE FÜR SCHWERE BEARBEITUNGEN UNTER UNSTABILEN BEDINGUNGEN UND MIT UNTERBROCHENEM SCHNITT	- DEGRÉ PLAQUETTE TENACE POUR USINAGES DIFFICILES DANS DES CONDITIONS INSTABLES ET À COUPE INTERROMPUE
- GRADE FOR MAXIMUM CUTTING SPEED IN LIGHT TO MEDIUM TURNING OPERATIONS. THANKS TO ITS SPECIAL COATING, IT IS EXTREMELY RESISTANT TO WEAR	- SORTE FÜR MAXIMALE SCHNITTGESCHWINDIGKEIT BEI LEICHTEN BIS MITTLEREN DREHANWENDUNGEN. ÄUSSERST VERSCHLEISSFEST DANK SEINER SPEZIELLEN BESCHICHTUNG.	- QUALITÉ POUR UNE VITESSE DE DÉCOUPE MAXIMUM AVEC TOURNAGE DE LÉGER À MOYEN, GRÂCE AU REVÊTEMENT SPÉCIAL CE TYPE EST EXTRÊMEMENT RÉSISTANT À L'USURE.
- THIS MULTI-RANGE GRADE FEATURES HIGH RESISTANCE TO WEAR AND OUTSTANDING TOUGHNESS FOR A BROAD SPECTRUM OF APPLICATIONS	- DIESE MEHRBEREICHSSORTE ZEICHNET SICH DURCH HOHE VERSCHLEIßFESTIGKEIT UND HERVORRAGENDE ZÄHIGKEITSEIGENSCHAFTEN FÜR EINE VIELZAHL VON ANWENDUNGEN AUS	- CETTE VARIÉTÉ MULTI-GAMME SE CARACTÉRISE PAR UNE RÉSISTANCE ÉLEVÉE À L'USURE ET DES PROPRIÉTÉS DE DURETÉ EXCELLENTE S'ÉTENDANT À UNE VASTE GAMME D'APPLICATIONS.
-GOOD TOUGHNESS AND WEAR RESISTANCE -IDEAL GRADE FOR AUSTENITIC STAINLESS STEEL.	-GUTE ZÄHIGLEIT UND VERSCHLEISSFESTIGKEIT -IDEALE SORTE ZUM DREHEN VON AUSTENITISCHEM ROSTFREIEM STAHL	-BONNE TENACITÉ ET RESISTANCE À L'USURE -QUALITÉ IDEALE POUR LE TOURNAGE DES ACIERS AUSTENITICI INOXIDABLES
-HIGH TOUGHNESS, RESISTANCE TO WEAR AND CHIPPING -SUITABLE FOR MEDIUM-LOW CUTTING SPEEDS	-SEHR GUTER VERSCHLEISS, UND AUSBRUCHFESTIGKEIT -FÜR MITTEL-NIEDRIGE SCHNITTGESCHWINDIGKEITEN	-HAUTE TENACITÉ, RÉSISTANCE À L'USURE ET À L'ÉBRÈCHEMENT -INDIQUÉE POUR MOYENNE-FAIBLE VITESSE DE COUPE
- TURNING GRADE FOR NON-FERROUS MATERIALS, SUCH AS ALUMINUM ALLOYS, PREFERABLY WITH HIGH SILICON, COPPER, BRONZE CONTENT, REINFORCED THERMOPLASTIC MATERIALS AND COMPOUNDS - EXCELLENT FINISHING AND TOOL LIFE	- SORTE ZUM DREHEN FÜR NICHT-EISENMATERIALIEN, z.B. ALUMINIUM-LEGIERUNGEN, VORZUGSWEISE MIT HOHEM SILIZIUM-, KUPFER- UND BRONZEHALT, VERSTÄRKTE THERMOPLASTE UND VERBUNDMATERIALIEN. - HERVORRAGENDE OBERFLÄCHENGÜTE UND WERKZEUGSTANDZEIT	- DEGRÉ INDIQUÉ POUR LE TOURNAGE DE MATÉRIAUX NON FERREUX, TELS QUE ALLIAGES D'ALUMINIUM, AUTANT QUE POSSIBLE À TENEUR ÉLEVÉE DE SILICIUM, CUIVRE, BRONZE, THERMOPLASTIQUES RENFORCÉS ET COMPOSITES. - FINITION ET VIE DE L'OUTIL EXCELLENTE.











MATERIALE MATERIAL MATERIALIEN MATERIAUX PAG 1199	VDI 3323 GR.	HB HRC Rm	C4010	DT61T	DT63	T115	T120	T3310 NEW	F2115 NEW	F2120	T1625	F2425	T7725 NEW
P ACCIAI STEELS STAHL ACIER	1	125	230-270	320-600	310-400						450-680	130-250	170-450
	2	180	230-270	300-560	260-350						450-680	130-250	170-450
	3	250	230-270	270-430	220-300						450-680	130-250	170-450
	4	220	230-270	300-450	220-330						300-500	130-250	170-450
	5	300	230-270	220-340	180-280						300-500	130-250	130-330
	6	180	230-270	250-420	250-350						200-450	130-250	130-330
	7-8	250-300	180-230	160-300	200-350						200-450	60-180	130-330
	9	350	180-230	130-200	150-220						200-450	60-180	130-330
	10	200	160-200	150-310	200-350						200-400	80-200	130-230
	11	350	160-200	130-200	150-220						200-400	80-200	130-230
	12	200	230-270	260-320	180-300			80-150			200-400	120-250	130-270
	13	330	170-240	160-240	150-250			40-70			200-400	120-250	130-270
	M ACCIAI INOX STAINLESS STEELS ROSTFREIER STAHL ACIER INOXYDABLE	14.1	180	170-240	180-280	150-280		50-100			120-200	160-260	100-250
14.2		230-260	130-160	130-230	100-150		50-90			60-160	160-260	40-160	130-210
K GHISA CAST IRON GRAUGUSS FONTE GRISE	15	180	200-300	220-260	200-300	120-160	100-150			120-160	110-180		110-210
	16	260	200-300	130-170	150-260	120-160	70-120			120-160	110-180		110-210
	17	160	220-300	200-240	180-300	130-170	100-140			120-160	110-180		80-180
	18	250	220-300	150-200	150-240	130-170	80-120			120-160	110-180		80-180
	19	130	250-350	230-300	170-280	140-200	120-180			140-220	110-180		90-210
	20	230	250-350	130-170	150-220	140-200	70-120			120-160	110-180		90-210
N MAT. NON FERROSI NON FERROUS MAT. NICHT-EISEN MATERIALIEN MAT. FERREUX	21	60		500-900		100-950	300-950	450-950	100-950	100-400			
	22	100		500-900		100-950	300-800	450-950	100-950	100-400			
	23	75		500-900		100-950	200-500	450-950	100-950	100-400			
	24	90		500-900		100-950	200-400	450-950	100-950	100-400			
	25	130		500-900		100-800	200-300	450-950	100-950	100-400			
	26	110		500-900		100-800	200-450	250-950	100-500	100-400			
	27	90				100-300	200-400	250-950	100-500	100-400			
	28	100				100-300	250-350	250-950	100-500	100-400			
	29					100-950	300-500	250-950	100-300	100-600			
	30					100-950	100-300	250-950	100-300	100-600			
S MAT. DIFFICILI DIFFICULT MATERIAL SCHWERIGE MATERIALIEN MAT. DIFFICILES	31	200				30-45			30-45	20-50			
	32	280				20-35			20-35	20-50			
	33	250				20-35			20-35	15-40			
	34	350				18-30			20-35	20-35			
	35	320				18-30			15-30	20-35			
	36	Rm400				60-120			40-60	80-140			
	37	Rm1050				60-120			30-50	80-140			
H MATERIALI DURI HARD MATERIALS HARTE MATERIALIEN MATERIAUX DURS	38	55HRC											
	39	60HRC											
	40	400											
	41	55HRC											

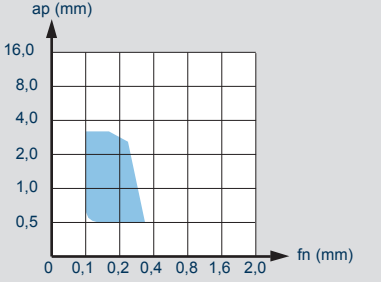
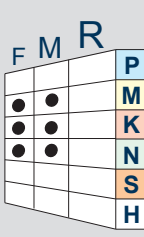

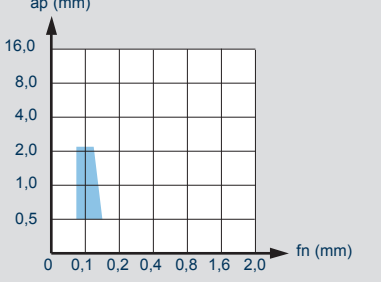
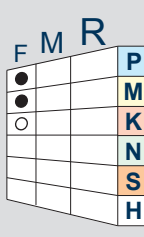

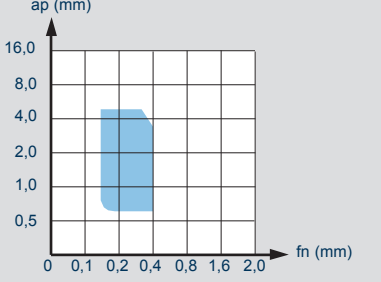
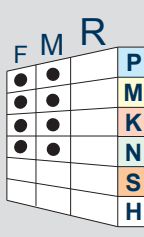

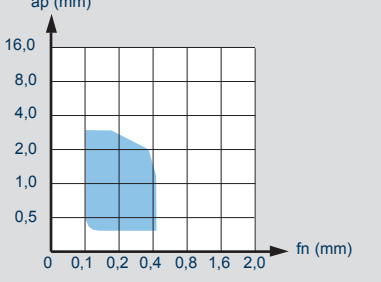
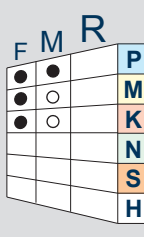

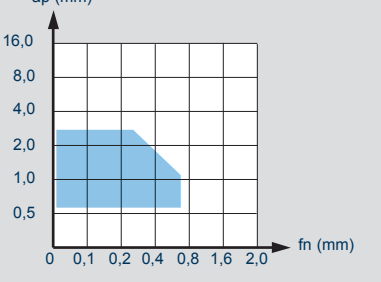
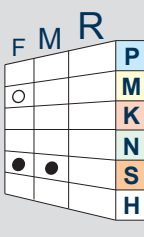
MATERIALE MATERIAL MATERIALIEN MATÉRIAUX PAG 1199	VDI 3323 GR.	HB HRC Rm	T1126	F2326 NEW	F2435	T3112 NEW	T1415	T3220	T3121 NEW	T1425	T531	T1435	T1215 NEW
P ACCIAI STEELS STAHL ACIER	1	125	170-240	130-200	170-190		220-400	200-340		170-240	200-300	170-190	140-360
	2	180	170-240	130-200	170-190		220-400	200-340		170-240	180-280	170-190	140-360
	3	250	170-240	130-200	170-190		220-400	200-340		170-240		170-190	140-360
	4	220	170-240	130-200	170-190		220-400	200-340		170-240		170-190	140-360
	5	300	170-240	130-200	170-190		220-400	200-340		170-240		170-190	130-260
	6	180	170-240		90-150		220-400	200-340		170-240		170-190	130-260
	7-8	250-300	100-190		90-150		200-320	150-290		100-190		90-150	130-260
	9	350	130-210		90-150		200-320	150-290		130-210		120-200	130-260
	10	200	130-210		120-200		180-320	160-290		130-210		120-200	110-210
	11	350	130-220		120-200		180-320	160-290		130-220		140-180	110-210
	12	200	130-220		140-180		200-320	160-290		130-220	130-180	140-180	110-210
	13	330	130-220		140-180		200-320	160-290		130-220	100-140	140-200	110-210
	M ACCIAI INOX STAINLESS STEELS ROSTFREIER STAHL ACIER INOXYDABLE	14.1	180	100-210	130-200	110-200					100-210	100-160	100-190
14.2		230-260	70-100	100-180	55-150					70-100	80-120	50-150	
K GHISA CAST IRON GRAUGUSS FONTE GRISÉ	15	180	130-210			210-500	140-370	150-400	200-400	130-210			110-360
	16	260	130-210			140-270	140-370	150-400	140-270	130-210			110-360
	17	160	120-240			150-300	190-430	200-450	120-300	120-240			110-360
	18	250	120-240			110-200	190-430	200-450	100-200	120-240			110-360
	19	130	150-250			200-330	180-520	200-550	180-320	150-250			110-210
	20	230	150-250			100-240	180-520	200-550	100-240	150-250			110-210
N MAT/IRON FERROSI NONFERROUS MAT. NICHT-EISENMATERIALIEN MAT. FERREUX	21	60											
	22	100											
	23	75											
	24	90											
	25	130											
	26	110											
	27	90											
	28	100											
	29												
	30												
S MAT/DIFFICILI DIFFICULT MATERIAL SCHWERIGE MATERIALIEN MAT. DIFCILES	31	200									20-40		
	32	280									15-35		
	33	250									10-30		
	34	350									5-18		
	35	320									5-18		
	36	Rm400									80-130		
	37	Rm1050									20-40		
H MATERIALI DURI HARD MATERIALS HARTE MATERIALIEN MATÉRIAUX DURS	38	55HRC											
	39	60HRC											
	40	400											
	41	55HRC											

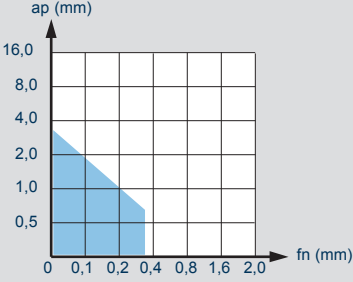
MATERIALE MATERIAL MATERIALIEN MATERIAUX PAG 1199	VDI 3323 GR.	HB HRC Rm	T1225 NEW	T2335	T540	D3010							
P ACCIAI STEELS STÄHL ACIER	1	125	100-250		180-230								
	2	180	100-250		170-190								
	3	250	100-250		130-150								
	4	220	100-250										
	5	300	100-180										
	6	180	100-180		150-190								
	7-8	250-300	100-180		90-150								
	9	350	100-180		70-130								
	10	200	80-160		120-200								
	11	350	80-160		50-100								
	12	200	80-160		140-180								
	13	330	80-160		110-160								
	M ACCIAI INOX STAINLESS STEELS ROSTFREIER STAHL ACIER INOXYDABLE	14.1	180	100-130	80-120	110-190							
14.2		230-260	100-130	70-100	80-150								
K GHISA CAST IRON GRAUGUSS FONTE GRISE	15	180											
	16	260											
	17	160											
	18	250											
	19	130											
	20	230											
N MAT/NON FERROSI NONFERROUS MAT NICHT-EISENMATERIALIEN MAT. FERREUX	21	60				300-950							
	22	100				300-950							
	23	75				200-950							
	24	90				200-950							
	25	130				180-500							
	26	110				180-350							
	27	90				180-350							
	28	100				200-950							
	29					300-950							
	30					300-950							
S MAT/DIFFICILI DIFFICULT MATERIAL SCHWERIGE MATERIALIEN MAT. DIFFICILES	31	200			20-40								
	32	280			15-35								
	33	250			8-25								
	34	350			4-15								
	35	320			4-15								
	36	Rm400			80-130								
	37	Rm1050			15-35								
H MATERIALI DURI HARD MATERIALS HARTE MATERIALIEN MATERIAUX DURS	38	55HRC											
	39	60HRC											
	40	400											
	41	55HRC											

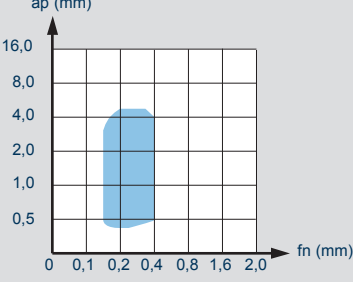
MATERIALE MATERIAL MATERIALIEN MATÉRIAUX PAG 1199	VDI 3323 GR.	HB HRC Rm												
P ACCIAI STEELS STAHL ACIER	1	125												
	2	180												
	3	250												
	4	220												
	5	300												
	6	180												
	7-8	250-300												
	9	350												
	10	200												
	11	350												
	12	200												
	13	330												
	M ACCIAI INOX STAINLESS STEELS ROSTFREIER STAHL ACIER INOXYDABLE	14.1	180											
14.2		230-260												
K GHISA CAST IRON GRAUGUSS FONTE GRISE	15	180												
	16	260												
	17	160												
	18	250												
	19	130												
	20	230												
N MAT. NON FERROSI NON FERROUS MAT. NICHT-EISEN MATERIALIEN MAT. FERREUX	21	60												
	22	100												
	23	75												
	24	90												
	25	130												
	26	110												
	27	90												
	28	100												
	29													
	30													
S MAT. DIFFICILI DIFFICULT MATERIAL SCHWERIGE MATERIALIEN MAT. DIFCILES	31	200												
	32	280												
	33	250												
	34	350												
	35	320												
	36	Rm400												
	37	Rm1050												
H MATERIALI DURI HARD MATERIALS HARTE MATERIALIEN MATÉRIAUX DURS	38	55HRC												
	39	60HRC												
	40	400												
	41	55HRC												

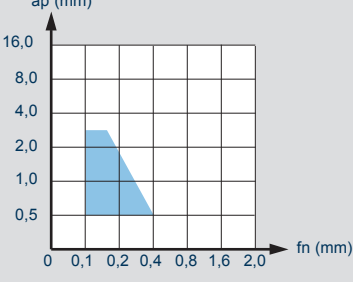
 <p>.F32 NEW</p>	<ul style="list-style-type: none"> <input checked="" type="checkbox"/>  <input type="checkbox"/>  <input type="checkbox"/>  <input type="checkbox"/>  <input type="checkbox"/>  <input type="checkbox"/>  <input type="checkbox"/>  <input type="checkbox"/>  	<p>ap (mm)</p>  <p>fn (mm)</p>	<table border="1"> <thead> <tr> <th>F</th> <th>M</th> <th>R</th> <th></th> <th></th> <th></th> <th></th> </tr> </thead> <tbody> <tr> <td><input checked="" type="checkbox"/></td> <td></td> <td></td> <td>P</td> <td>T1215-T1225</td> <td></td> <td></td> </tr> <tr> <td><input type="checkbox"/></td> <td></td> <td></td> <td>M</td> <td>T1225</td> <td></td> <td></td> </tr> <tr> <td><input type="checkbox"/></td> <td></td> <td></td> <td>K</td> <td>T1215</td> <td></td> <td></td> </tr> <tr> <td></td> <td></td> <td></td> <td>N</td> <td></td> <td></td> <td></td> </tr> <tr> <td></td> <td></td> <td></td> <td>S</td> <td></td> <td></td> <td></td> </tr> <tr> <td></td> <td></td> <td></td> <td>H</td> <td></td> <td></td> <td></td> </tr> </tbody> </table>	F	M	R					<input checked="" type="checkbox"/>			P	T1215-T1225			<input type="checkbox"/>			M	T1225			<input type="checkbox"/>			K	T1215						N							S							H			
F	M	R																																																		
<input checked="" type="checkbox"/>			P	T1215-T1225																																																
<input type="checkbox"/>			M	T1225																																																
<input type="checkbox"/>			K	T1215																																																
			N																																																	
			S																																																	
			H																																																	
 <p>.G32W</p>	<ul style="list-style-type: none"> <input checked="" type="checkbox"/>  <input type="checkbox"/>  <input type="checkbox"/>  <input type="checkbox"/>  <input type="checkbox"/>  <input type="checkbox"/>  <input type="checkbox"/>  <input type="checkbox"/>  	<p>ap (mm)</p>  <p>fn (mm)</p>	<table border="1"> <thead> <tr> <th>F</th> <th>M</th> <th>R</th> <th></th> <th></th> <th></th> <th></th> </tr> </thead> <tbody> <tr> <td><input checked="" type="checkbox"/></td> <td></td> <td></td> <td>P</td> <td>T1425</td> <td></td> <td></td> </tr> <tr> <td><input type="checkbox"/></td> <td></td> <td></td> <td>M</td> <td>T1425</td> <td></td> <td></td> </tr> <tr> <td><input type="checkbox"/></td> <td></td> <td></td> <td>K</td> <td>T1425</td> <td></td> <td></td> </tr> <tr> <td></td> <td></td> <td></td> <td>N</td> <td></td> <td></td> <td></td> </tr> <tr> <td></td> <td></td> <td></td> <td>S</td> <td></td> <td></td> <td></td> </tr> <tr> <td></td> <td></td> <td></td> <td>H</td> <td></td> <td></td> <td></td> </tr> </tbody> </table>	F	M	R					<input checked="" type="checkbox"/>			P	T1425			<input type="checkbox"/>			M	T1425			<input type="checkbox"/>			K	T1425						N							S							H			
F	M	R																																																		
<input checked="" type="checkbox"/>			P	T1425																																																
<input type="checkbox"/>			M	T1425																																																
<input type="checkbox"/>			K	T1425																																																
			N																																																	
			S																																																	
			H																																																	
 <p>.F33 NEW</p>	<ul style="list-style-type: none"> <input checked="" type="checkbox"/>  <input type="checkbox"/>  <input type="checkbox"/>  <input type="checkbox"/>  <input type="checkbox"/>  <input type="checkbox"/>  <input type="checkbox"/>  <input type="checkbox"/>  	<p>ap (mm)</p>  <p>fn (mm)</p>	<table border="1"> <thead> <tr> <th>F</th> <th>M</th> <th>R</th> <th></th> <th></th> <th></th> <th></th> </tr> </thead> <tbody> <tr> <td><input type="checkbox"/></td> <td></td> <td></td> <td>P</td> <td>F2326</td> <td></td> <td></td> </tr> <tr> <td><input checked="" type="checkbox"/></td> <td></td> <td></td> <td>M</td> <td>F2326</td> <td></td> <td></td> </tr> <tr> <td></td> <td></td> <td></td> <td>K</td> <td></td> <td></td> <td></td> </tr> <tr> <td></td> <td></td> <td></td> <td>N</td> <td></td> <td></td> <td></td> </tr> <tr> <td></td> <td></td> <td></td> <td>S</td> <td></td> <td></td> <td></td> </tr> <tr> <td></td> <td></td> <td></td> <td>H</td> <td></td> <td></td> <td></td> </tr> </tbody> </table>	F	M	R					<input type="checkbox"/>			P	F2326			<input checked="" type="checkbox"/>			M	F2326						K							N							S							H			
F	M	R																																																		
<input type="checkbox"/>			P	F2326																																																
<input checked="" type="checkbox"/>			M	F2326																																																
			K																																																	
			N																																																	
			S																																																	
			H																																																	
 <p>.D34</p>	<ul style="list-style-type: none"> <input checked="" type="checkbox"/>  <input type="checkbox"/>  <input type="checkbox"/>  <input type="checkbox"/>  <input type="checkbox"/>  <input type="checkbox"/>  <input type="checkbox"/>  <input type="checkbox"/>  	<p>ap (mm)</p>  <p>fn (mm)</p>	<table border="1"> <thead> <tr> <th>F</th> <th>M</th> <th>R</th> <th></th> <th></th> <th></th> <th></th> </tr> </thead> <tbody> <tr> <td><input checked="" type="checkbox"/></td> <td></td> <td></td> <td>P</td> <td>DT61T</td> <td></td> <td></td> </tr> <tr> <td><input checked="" type="checkbox"/></td> <td></td> <td></td> <td>M</td> <td>DT61T</td> <td></td> <td></td> </tr> <tr> <td></td> <td></td> <td></td> <td>K</td> <td></td> <td></td> <td></td> </tr> <tr> <td></td> <td></td> <td></td> <td>N</td> <td></td> <td></td> <td></td> </tr> <tr> <td></td> <td></td> <td></td> <td>S</td> <td></td> <td></td> <td></td> </tr> <tr> <td></td> <td></td> <td></td> <td>H</td> <td></td> <td></td> <td></td> </tr> </tbody> </table>	F	M	R					<input checked="" type="checkbox"/>			P	DT61T			<input checked="" type="checkbox"/>			M	DT61T						K							N							S							H			
F	M	R																																																		
<input checked="" type="checkbox"/>			P	DT61T																																																
<input checked="" type="checkbox"/>			M	DT61T																																																
			K																																																	
			N																																																	
			S																																																	
			H																																																	
 <p>.G39</p>	<ul style="list-style-type: none"> <input checked="" type="checkbox"/>  <input type="checkbox"/>  <input type="checkbox"/>  <input checked="" type="checkbox"/>  <input type="checkbox"/>  <input type="checkbox"/>  <input checked="" type="checkbox"/>  <input type="checkbox"/>  	<p>ap (mm)</p>  <p>fn (mm)</p>	<table border="1"> <thead> <tr> <th>F</th> <th>M</th> <th>R</th> <th></th> <th></th> <th></th> <th></th> </tr> </thead> <tbody> <tr> <td><input checked="" type="checkbox"/></td> <td></td> <td></td> <td>P</td> <td>C4010</td> <td></td> <td></td> </tr> <tr> <td></td> <td></td> <td></td> <td>M</td> <td>C4010</td> <td></td> <td></td> </tr> <tr> <td></td> <td></td> <td></td> <td>K</td> <td>C4010</td> <td></td> <td></td> </tr> <tr> <td></td> <td></td> <td></td> <td>N</td> <td></td> <td></td> <td></td> </tr> <tr> <td></td> <td></td> <td></td> <td>S</td> <td></td> <td></td> <td></td> </tr> <tr> <td></td> <td></td> <td></td> <td>H</td> <td></td> <td></td> <td></td> </tr> </tbody> </table>	F	M	R					<input checked="" type="checkbox"/>			P	C4010						M	C4010						K	C4010						N							S							H			
F	M	R																																																		
<input checked="" type="checkbox"/>			P	C4010																																																
			M	C4010																																																
			K	C4010																																																
			N																																																	
			S																																																	
			H																																																	

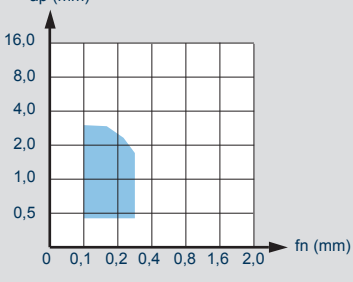
 <p>.D42</p>			 <table border="1" data-bbox="1053 235 1476 470"> <thead> <tr> <th></th> <th>○</th> <th>○</th> <th>⊗</th> </tr> </thead> <tbody> <tr> <td>P</td> <td></td> <td></td> <td></td> </tr> <tr> <td>M</td> <td>T120</td> <td>T120</td> <td></td> </tr> <tr> <td>K</td> <td>T120</td> <td>T120</td> <td></td> </tr> <tr> <td>N</td> <td>T120</td> <td>T120</td> <td></td> </tr> <tr> <td>S</td> <td></td> <td></td> <td></td> </tr> <tr> <td>H</td> <td></td> <td></td> <td></td> </tr> </tbody> </table>		○	○	⊗	P				M	T120	T120		K	T120	T120		N	T120	T120		S				H			
	○	○	⊗																												
P																															
M	T120	T120																													
K	T120	T120																													
N	T120	T120																													
S																															
H																															
 <p>.G42</p>			 <table border="1" data-bbox="1053 638 1476 873"> <thead> <tr> <th></th> <th>○</th> <th>○</th> <th>⊗</th> </tr> </thead> <tbody> <tr> <td>P</td> <td>T1415-T1425-F2425</td> <td>T1415-T1425-F2425</td> <td></td> </tr> <tr> <td>M</td> <td>T1425-F2425</td> <td>T1425-F2425</td> <td></td> </tr> <tr> <td>K</td> <td>T1415-T1425</td> <td>T1415-T1425</td> <td></td> </tr> <tr> <td>N</td> <td></td> <td></td> <td></td> </tr> <tr> <td>S</td> <td></td> <td></td> <td></td> </tr> <tr> <td>H</td> <td></td> <td></td> <td></td> </tr> </tbody> </table>		○	○	⊗	P	T1415-T1425-F2425	T1415-T1425-F2425		M	T1425-F2425	T1425-F2425		K	T1415-T1425	T1415-T1425		N				S				H			
	○	○	⊗																												
P	T1415-T1425-F2425	T1415-T1425-F2425																													
M	T1425-F2425	T1425-F2425																													
K	T1415-T1425	T1415-T1425																													
N																															
S																															
H																															
 <p>.S42</p>			 <table border="1" data-bbox="1053 1037 1476 1272"> <thead> <tr> <th></th> <th>○</th> <th>○</th> <th>⊗</th> </tr> </thead> <tbody> <tr> <td>P</td> <td>T540</td> <td>T540</td> <td>T540</td> </tr> <tr> <td>M</td> <td>T540</td> <td>T540</td> <td>T540</td> </tr> <tr> <td>K</td> <td>T120</td> <td>T120</td> <td></td> </tr> <tr> <td>N</td> <td>T120</td> <td>T120</td> <td>T120</td> </tr> <tr> <td>S</td> <td></td> <td></td> <td></td> </tr> <tr> <td>H</td> <td></td> <td></td> <td></td> </tr> </tbody> </table>		○	○	⊗	P	T540	T540	T540	M	T540	T540	T540	K	T120	T120		N	T120	T120	T120	S				H			
	○	○	⊗																												
P	T540	T540	T540																												
M	T540	T540	T540																												
K	T120	T120																													
N	T120	T120	T120																												
S																															
H																															
 <p>.S44</p>			 <table border="1" data-bbox="1053 1440 1476 1675"> <thead> <tr> <th></th> <th>○</th> <th>○</th> <th>⊗</th> </tr> </thead> <tbody> <tr> <td>P</td> <td>T7725-T1625</td> <td>T7725-T1625</td> <td></td> </tr> <tr> <td>M</td> <td>T7725-T1625</td> <td>T7725-T1625</td> <td></td> </tr> <tr> <td>K</td> <td>T7725-T1625</td> <td>T7725-T1625</td> <td></td> </tr> <tr> <td>N</td> <td></td> <td></td> <td></td> </tr> <tr> <td>S</td> <td></td> <td></td> <td></td> </tr> <tr> <td>H</td> <td></td> <td></td> <td></td> </tr> </tbody> </table>		○	○	⊗	P	T7725-T1625	T7725-T1625		M	T7725-T1625	T7725-T1625		K	T7725-T1625	T7725-T1625		N				S				H			
	○	○	⊗																												
P	T7725-T1625	T7725-T1625																													
M	T7725-T1625	T7725-T1625																													
K	T7725-T1625	T7725-T1625																													
N																															
S																															
H																															
 <p>.F47 NEW</p>			 <table border="1" data-bbox="1053 1843 1476 2078"> <thead> <tr> <th></th> <th>○</th> <th>○</th> <th>⊗</th> </tr> </thead> <tbody> <tr> <td>P</td> <td></td> <td></td> <td></td> </tr> <tr> <td>M</td> <td>T3310</td> <td></td> <td></td> </tr> <tr> <td>K</td> <td></td> <td></td> <td></td> </tr> <tr> <td>N</td> <td></td> <td></td> <td></td> </tr> <tr> <td>S</td> <td>T3310</td> <td>T3310</td> <td></td> </tr> <tr> <td>H</td> <td></td> <td></td> <td></td> </tr> </tbody> </table>		○	○	⊗	P				M	T3310			K				N				S	T3310	T3310		H			
	○	○	⊗																												
P																															
M	T3310																														
K																															
N																															
S	T3310	T3310																													
H																															

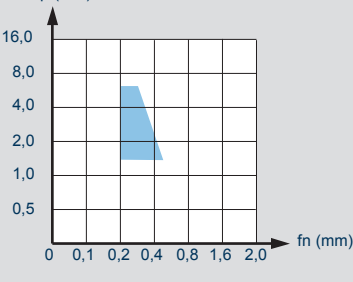
 <p>.X37 .X47</p>	<ul style="list-style-type: none"> <input checked="" type="checkbox"/> <input type="checkbox"/> <input type="checkbox"/> <input type="checkbox"/> <input checked="" type="checkbox"/> <input type="checkbox"/> <input type="checkbox"/> <input type="checkbox"/> <input type="checkbox"/> 		<table border="1"> <tr> <td></td> <td></td> <td></td> <td></td> <td></td> <td></td> </tr> <tr> <td>F</td> <td>M</td> <td>R</td> <td></td> <td></td> <td></td> </tr> <tr> <td></td> <td></td> <td></td> <td>P</td> <td></td> <td></td> </tr> <tr> <td></td> <td></td> <td></td> <td>M</td> <td></td> <td></td> </tr> <tr> <td></td> <td></td> <td></td> <td>K</td> <td></td> <td></td> </tr> <tr> <td></td> <td></td> <td></td> <td>N</td> <td>D3010</td> <td></td> </tr> <tr> <td></td> <td></td> <td></td> <td>S</td> <td></td> <td></td> </tr> <tr> <td></td> <td></td> <td></td> <td>H</td> <td></td> <td></td> </tr> </table>							F	M	R							P						M						K						N	D3010					S						H		
F	M	R																																																	
			P																																																
			M																																																
			K																																																
			N	D3010																																															
			S																																																
			H																																																
 <p>.F51 NEW</p>	<ul style="list-style-type: none"> <input checked="" type="checkbox"/> <input type="checkbox"/> <input checked="" type="checkbox"/> <input type="checkbox"/> <input type="checkbox"/> <input type="checkbox"/> <input type="checkbox"/> <input type="checkbox"/> <input type="checkbox"/> 		<table border="1"> <tr> <td></td> <td></td> <td></td> <td></td> <td></td> <td></td> </tr> <tr> <td>F</td> <td>M</td> <td>R</td> <td></td> <td></td> <td></td> </tr> <tr> <td></td> <td></td> <td></td> <td>P</td> <td></td> <td></td> </tr> <tr> <td></td> <td></td> <td></td> <td>M</td> <td></td> <td></td> </tr> <tr> <td></td> <td></td> <td></td> <td>K</td> <td>T3112-T3121</td> <td>T3112-T3121</td> </tr> <tr> <td></td> <td></td> <td></td> <td>N</td> <td></td> <td></td> </tr> <tr> <td></td> <td></td> <td></td> <td>S</td> <td></td> <td></td> </tr> <tr> <td></td> <td></td> <td></td> <td>H</td> <td></td> <td></td> </tr> </table>							F	M	R							P						M						K	T3112-T3121	T3112-T3121				N						S						H		
F	M	R																																																	
			P																																																
			M																																																
			K	T3112-T3121	T3112-T3121																																														
			N																																																
			S																																																
			H																																																
 <p>.G52</p>	<ul style="list-style-type: none"> <input checked="" type="checkbox"/> <input type="checkbox"/> <input checked="" type="checkbox"/> <input checked="" type="checkbox"/> <input type="checkbox"/> <input type="checkbox"/> <input type="checkbox"/> <input type="checkbox"/> <input type="checkbox"/> 		<table border="1"> <tr> <td></td> <td></td> <td></td> <td></td> <td></td> <td></td> </tr> <tr> <td>F</td> <td>M</td> <td>R</td> <td></td> <td></td> <td></td> </tr> <tr> <td></td> <td></td> <td></td> <td>P</td> <td>F2425-F2435-T1415 T1425-T1435-T3220</td> <td>F2425-F2435-T1425 T1435-T3220</td> </tr> <tr> <td></td> <td></td> <td></td> <td>M</td> <td>F2425-F2435-T1126 T1425-T1435</td> <td>F2425-F2435-T1126 T1425-T1435</td> </tr> <tr> <td></td> <td></td> <td></td> <td>K</td> <td>T3220-T1415 T1425-T1126</td> <td>T3220-T1425-T1126</td> </tr> <tr> <td></td> <td></td> <td></td> <td>N</td> <td></td> <td>F2435-T1435-T1126</td> </tr> <tr> <td></td> <td></td> <td></td> <td>S</td> <td></td> <td></td> </tr> <tr> <td></td> <td></td> <td></td> <td>H</td> <td></td> <td></td> </tr> </table>							F	M	R							P	F2425-F2435-T1415 T1425-T1435-T3220	F2425-F2435-T1425 T1435-T3220				M	F2425-F2435-T1126 T1425-T1435	F2425-F2435-T1126 T1425-T1435				K	T3220-T1415 T1425-T1126	T3220-T1425-T1126				N		F2435-T1435-T1126				S						H		
F	M	R																																																	
			P	F2425-F2435-T1415 T1425-T1435-T3220	F2425-F2435-T1425 T1435-T3220																																														
			M	F2425-F2435-T1126 T1425-T1435	F2425-F2435-T1126 T1425-T1435																																														
			K	T3220-T1415 T1425-T1126	T3220-T1425-T1126																																														
			N		F2435-T1435-T1126																																														
			S																																																
			H																																																
 <p>.B56</p>	<ul style="list-style-type: none"> <input type="checkbox"/> <input type="checkbox"/> <input type="checkbox"/> <input type="checkbox"/> <input type="checkbox"/> <input type="checkbox"/> <input checked="" type="checkbox"/> <input type="checkbox"/> <input type="checkbox"/> 		<table border="1"> <tr> <td></td> <td></td> <td></td> <td></td> <td></td> <td></td> </tr> <tr> <td>F</td> <td>M</td> <td>R</td> <td></td> <td></td> <td></td> </tr> <tr> <td></td> <td></td> <td></td> <td>P</td> <td>DT63</td> <td></td> </tr> <tr> <td></td> <td></td> <td></td> <td>M</td> <td>DT63-T2335</td> <td>T2335</td> </tr> <tr> <td></td> <td></td> <td></td> <td>K</td> <td></td> <td></td> </tr> <tr> <td></td> <td></td> <td></td> <td>N</td> <td></td> <td></td> </tr> <tr> <td></td> <td></td> <td></td> <td>S</td> <td></td> <td></td> </tr> <tr> <td></td> <td></td> <td></td> <td>H</td> <td></td> <td></td> </tr> </table>							F	M	R							P	DT63					M	DT63-T2335	T2335				K						N						S						H		
F	M	R																																																	
			P	DT63																																															
			M	DT63-T2335	T2335																																														
			K																																																
			N																																																
			S																																																
			H																																																
 <p>.G57 .G57P</p>	<ul style="list-style-type: none"> <input checked="" type="checkbox"/> <input type="checkbox"/> <input checked="" type="checkbox"/> <input checked="" type="checkbox"/> <input type="checkbox"/> <input type="checkbox"/> <input type="checkbox"/> <input type="checkbox"/> <input type="checkbox"/> 		<table border="1"> <tr> <td></td> <td></td> <td></td> <td></td> <td></td> <td></td> </tr> <tr> <td>F</td> <td>M</td> <td>R</td> <td></td> <td></td> <td></td> </tr> <tr> <td></td> <td></td> <td></td> <td>P</td> <td></td> <td></td> </tr> <tr> <td></td> <td></td> <td></td> <td>M</td> <td></td> <td></td> </tr> <tr> <td></td> <td></td> <td></td> <td>K</td> <td>T115</td> <td>T115</td> </tr> <tr> <td></td> <td></td> <td></td> <td>N</td> <td>T115-F2115</td> <td>T115-F2115</td> </tr> <tr> <td></td> <td></td> <td></td> <td>S</td> <td>T115-F2115</td> <td>T115-F2115</td> </tr> <tr> <td></td> <td></td> <td></td> <td>H</td> <td></td> <td></td> </tr> </table>							F	M	R							P						M						K	T115	T115				N	T115-F2115	T115-F2115				S	T115-F2115	T115-F2115				H		
F	M	R																																																	
			P																																																
			M																																																
			K	T115	T115																																														
			N	T115-F2115	T115-F2115																																														
			S	T115-F2115	T115-F2115																																														
			H																																																

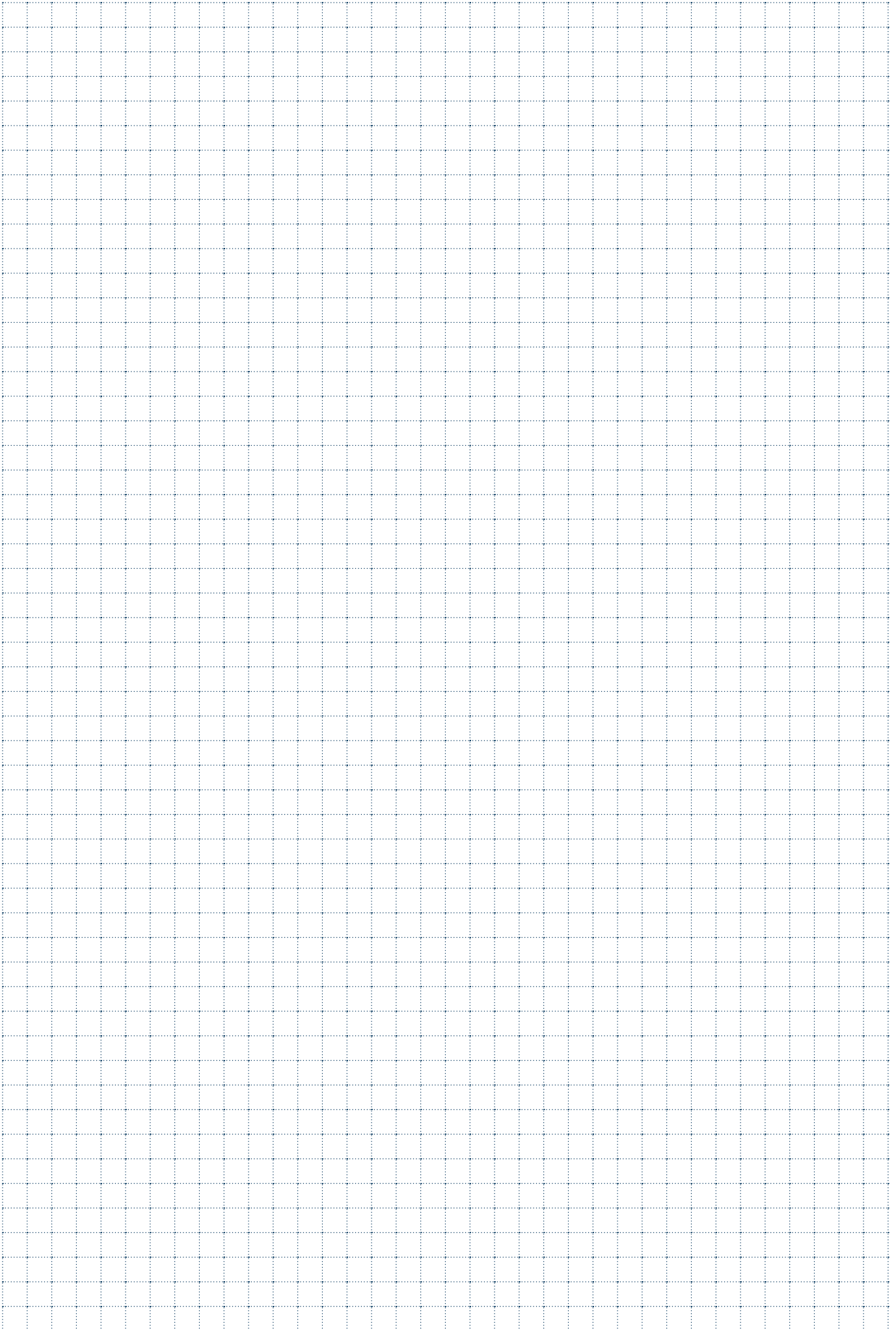

MANDRINI E ACCESSORI



CHUCKS AND ACCESSORIES / AUFNAHMEN UND ZUBEHÖR
MANDRINS ET ACCESSOIRES / CONOS Y ACCESORIOS



    	<p>HSK-DIN 69893</p>		<p>Pag. 963</p>
---	----------------------	---	-----------------

    	<p>DIN 69871 (ISO 7388-1)</p>		<p>Pag. 984</p>
---	-------------------------------	---	-----------------

    	<p>MAS 403 BT (ISO 7388-2)</p>		<p>Pag. 1008</p>
--	--------------------------------	--	------------------

    	<p>ISO 26623-1</p>		<p>Pag. 1032</p>
---	--------------------	---	------------------

    	<p>ACCESSORI</p> <p>ACCESSORIES</p> <p>ZUBEHÖR</p> <p>ACCESSOIRES</p> <p>ACCESORIOS</p>		<p>Pag. 1044</p>
---	---	--	------------------



**ADDUZIONE REFRIGERANTE
KÜHLMITTELZUFUHR**



**COOLANT FEED
ABDUCTION DU RÉFRIGÉRANTE**

***HSK-DIN 69893
PAG. 1184 / 1185***

DIN 69871/...

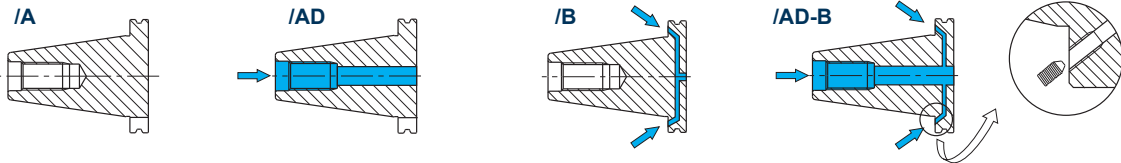

JIS B 6339 - MAS 403 BT/...

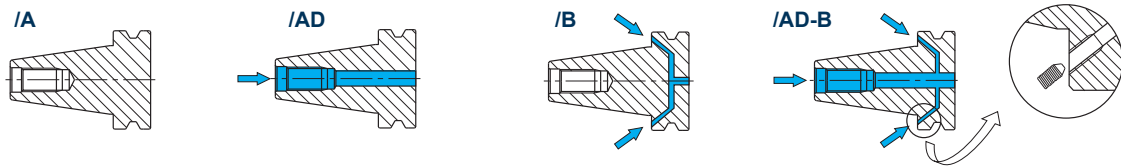

**SIMBOLI
SYMBOLS**



**SYMBOLS
SYMBOLES**



**CONCENTRICITÀ
CONCENTRICITY
RUNDLAUF
CONCENTRICITÉ**



**EQUILIBRATURA
BALANCING
AUSWUCHTUNG
ÉQUILIBRAGE**



**TOLLERANZA FORO
BORE TOLERANCE
BOHRUNGSTOLERANZ
TOLERANCE TROUS**



**ANTIVIBRANTE
VIBRATION-DAMPING
SCHWINGUNGSDÄMPFEND
ANTI-VIBRATIONS**



**MASCHIATURA SINCRONIZZATA
SYNCHRONIZED TAPPING
STARREN GEWINDESCHNEIDEN
TARAUDAGE SYNCHRONISÉ**

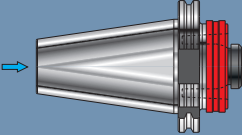
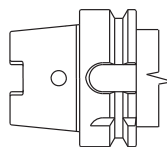
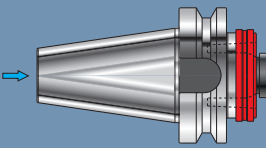
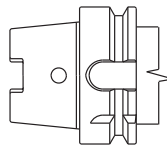
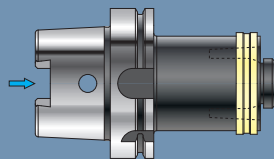
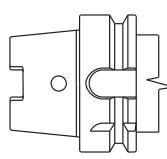
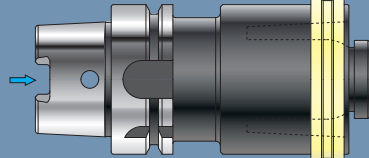
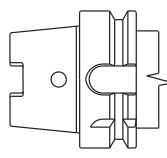
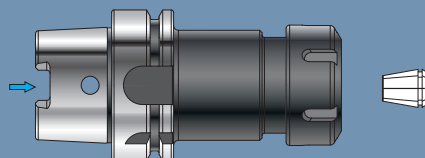
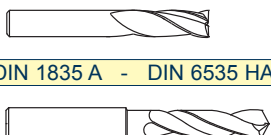
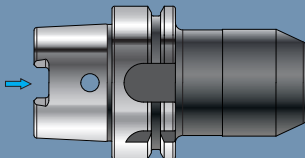
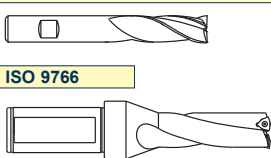

**FORTE SERRAGGIO
HIGH CLAMPING
KRAFT-SPANNUNG
FORT SERRAGE**

<p>ADATTATORE BASE - BASIC ADAPTER - GRUNDAUFNAHMEN - ADAPTATEUR BASIQUE</p>	<p>ISO.A50.HSK ...</p>  <p>DIN 69871 PAG 968</p>	
<p>ADATTATORE BASE - BASIC ADAPTER - GRUNDAUFNAHMEN - ADAPTATEUR BASIQUE</p>	<p>MAS.A50.HSK ...</p>  <p>MAS-403-BT PAG 968</p>	
<p>RIDUZIONE - REDUCTION - REDUZIERUNGEN - RÉDUCTION</p>	<p>HSK.100.RDU ...</p>  <p>DIN 69893-A HSK PAG 969</p>	
<p>PROLUNGA - EXTENSION - VERLAENGERUNGEN - RALLONGE</p>	<p>HSK.063.PRL ...</p>  <p>DIN 69893-A HSK PAG 969</p>	
<p>PORTAPINZA DI PRECISIONE - PRECISION COLLET HOLDER - PRÄZISIONSSPANNFUTTER - MANDRIN PORTE-PINCE DE PRÉCISION</p>	<p>HSK..ER.. ER-DIN 6499</p>  <p>PAG 970</p>	<p>DIN 1835 A - DIN 6535 HA</p> 
<p>MANDRINO PER ATTACCHI TIPO WELDON - END MILL HOLDER FOR WELDON CONNECTION - WERKZEUGAUFNAHME FÜR WELDON-TYPE - MANDRIN POUR ATTACHEMENT WELDON</p>	<p>HSK..WEH.. DIN 6359 B</p>  <p>PAG 971</p>	<p>WELDON - DIN1835B - DIN6535HB</p> <p>ISO 9766</p> 

PORTAPUNTA UNIVERSALE

- UNIVERSAL ADAPTER FOR DRILLING TOOLS
- WELDON-AUFNAHME FÜR VOLLBOHRER
- PORTE-FORET UNIVERSEL

HSK...PU..

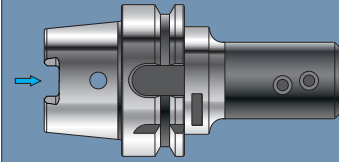

PAG 972

WHISTLE-NOTCH - DIN1835E - DIN6535HE



ISO 9766



PORTAFRESA A TRASCINAMENTO FRONTALE CON TENONE

- SHELL END-MILL HOLDERS WITH TENON
- FRÄSERAUFNAHME MIT QUERNUT UND LAPPEN
- PORTE-FRAISE A ENTRAINEMENT FRONTAL AVEC TENON

HSK...FSW..

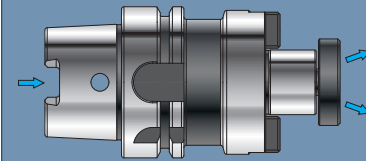

ISO 3937

PAG 973

ISO 6462

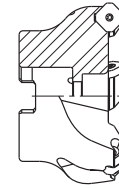

PORTAFRESA ANTIVIBRANTE A TRASCINAMENTO FRONTALE CON TENONE

- VIBRATION-DAMPED SHELL END-MILL HOLDERS WITH TENON
- SCHWINGUNGSGEDÄMPFTE FRÄSERAUFNAHME MIT QUERNUT UND LAPPEN
- MANDRIN PORTE-FRAISE ANTIVIBRATOIRE A ENTRAINEMENT FRONTAL AVEC TENON

HSK...FSV..

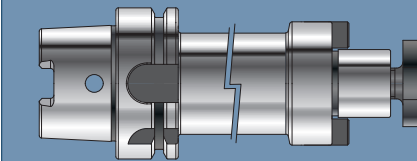

ISO 3937

PAG 974

ISO 6462

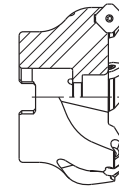

HSK...FC..

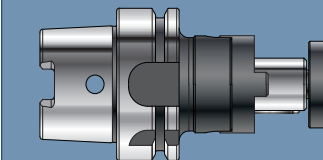

DIN 6358 B

PAG 975

ISO 6462

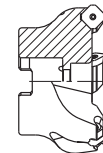

DIN 138



PORTAFRESA A TRASCINAMENTO COMBINATO PER FRESE A MANICOTTO E A DISCO

- COMBI FACE MILL HOLDERS FOR SHELL-END AND DISC MILLING CUTTERS
- FRÄSERAUFNAHME KOMBINIERT FÜR AUFSTECK-UND SCHEIBENFRÄSER
- MANDRIN PORTE-FRAISE À ENTRAINEMENT COMBINÉ POUR FRAISES À MANCHON ET DE DISQUE

PORTAMASCHIO A CAMBIO RAPIDO PER MASCHIATURA SINCRONIZZATA

- QUICK CHANGE TAP HOLDER FOR SYNCHRONIZED TAPPING
- GEWINDESCHNEID-SCHNELLWECHSELFUTTER ZUM STARREN GEWINDESCHNEIDEN
- APPAREIL PORTE-TARAUDS À CHANGEMENT RAPIDE POUR TARAUDAGE SYNCHRONISÉ

HSK...MS..

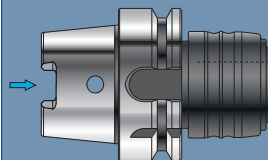

PAG 976

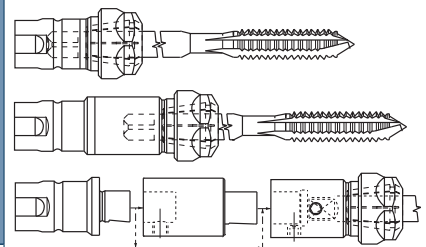

BARRA CON CONO FINITO E STELO TENERO

- BORING BARS WITH FINISHED TAPER AND BLANK SHAFT
- ROHLINGE
- BARRE AVEC CONE FINI ET BOUT DOUX

HSK...SF..

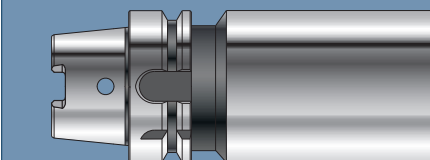

PAG 977

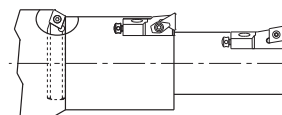



HSK.063.MD...

PORTAFRESA CON ATTACCO MODULARE FILETTATO

- CUTTER-HOLDER WITH MODULAR THREADED CONNECTION
- FRASERAUFNAHME MIT MODULAR-GEWINDE AUFNAHME
- MANDRIN PORTE-FRAISE AVEC ATTACHEMENT MODULAIRE FILETÉ

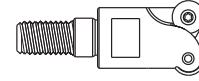
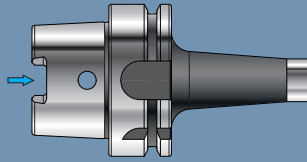

PAG 978

HSK...MDV...

PORTAFRESA ANTIVIBRANTE CON ATTACCO MODULARE FILETTATO

- VIBRATION-DAMPED CUTTER-HOLDER WITH MODULAR THREADED CONNECTION
- SCHWINGUNGSGEDÄMPFTE FRASERAUFNAHME MIT MODULAR-GEWINDEAUFNAHME
- MANDRIN PORTE-FRAISE ANTIVIBRATOIRE AVEC ATTACHEMENT MODULAIRE FILETÉ

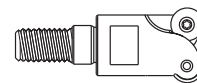
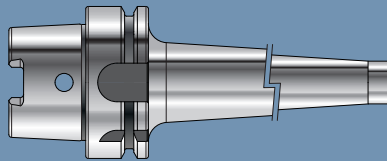

PAG 979

HSK..CTS..

DIN 69882-8

NEW

MANDRINO A CALETTAMENTO TERMICO

- SHRINKING-ON TAPER SHANKS
- WERKZEUGAUFNAHMEN MIT SCHRUMPFVERBINDUNG
- MANDRIN À EMBOÏTEMENT THERMIQUE

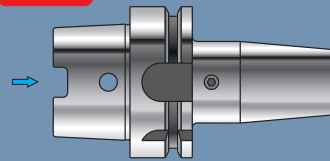

DIN 1835 A - DIN 6535 HA



PAG 980

HSK..CTPN..

MANDRINO A CALETTAMENTO TERMICO PROLUNGABILE

- EXTENSIBLE SHRINK FIT
- VERLÄNGERBARES SCHRUMPFUTTER
- MANDRIN PROLONGEABLE À EMBOÏTEMENT THERMIQUE.

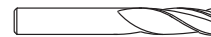
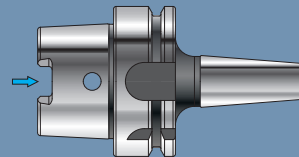

DIN 1835 A - DIN 6535 HA



PAG 981

HSK..MFSN..

MANDRINO A FORTE SERRAGGIO

- HIGH CLAMPING CHUCKS
- KRAFTSPANNFUTTER
- MANDRIN À FORT SERRAGE

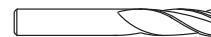
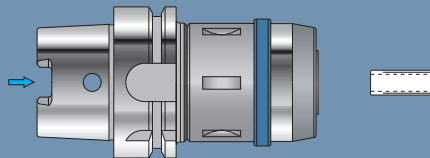

DIN 1835 A - DIN 6535 HA



PAG 982

HSK..MI..

NEW

MANDRINO A BLOCCAGGIO IDRAULICO

- HYDRAULIC CLAMPING CHUCK
- AUFNAHME MIT HYDRODEHNSPANNUNG
- MANDRIN AVEC BLOCAGE HYDRAULIC

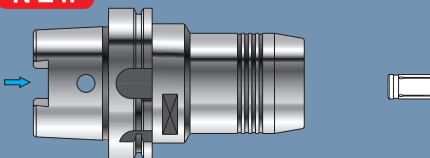

DIN 1835 A - DIN 6535 HA



PAG 983

HSK - DIN 69893

ART. HSK. ER. DIN 69893/A

SAU

ER-DIN 6499

PORTINAZIONE DI PRECISIONE
 PRECISION TOOL HOLDER
 PREZISIONSCORNFANLEITER
 MANIPOLAZIONE DI PRECISIONE

ART.	Cl.	OD1	L
HSK 100 ER10 150	HSK10	ES-10	20	100
HSK 100 ER16 150	HSK10	ES-16	21	100
HSK 100 ER20 150	HSK10	ES-18	42	100
HSK 100 ER25 150	HSK10	ES-18	42	100
HSK 100 ER32 150	HSK10	ES-20	53	100
HSK 100 ER40 150	HSK10	ES-20	53	100
HSK 100 ER50 150	HSK10	ES-25	64	100
HSK 100 ER63 150	HSK10	ES-25	64	100
HSK 100 ER80 150	HSK10	ES-30	81	100
HSK 100 ER100 150	HSK10	ES-30	81	100
HSK 150 ER16 150	HSK15	ES-16	20	150
HSK 150 ER20 150	HSK15	ES-16	41	150
HSK 150 ER25 150	HSK15	ES-16	42	150
HSK 150 ER32 150	HSK15	ES-20	53	150
HSK 150 ER40 150	HSK15	ES-20	53	150
HSK 150 ER50 150	HSK15	ES-25	64	150
HSK 150 ER63 150	HSK15	ES-25	64	150

902

902



- 1 = NORMA ATTACCO
- 2 = NORMA PARTE ANTERIORE
- 3 = ACCESSORI OPZIONALI A RICHIESTA
- 4 = CARATTERISTICHE TECNICHE
- 5 = ARTICOLO
- 6 = MISURE, DATI, INDICAZIONI
- 7 = ACCESSORI E RICAMBI IN DOTAZIONE
- 8 = ACCESSORI E RICAMBI OPZIONALI A RICHIESTA
- 9 = NOTE E AVVERTIMENTI







- 1 = SHANK STANDARD
- 2 = TOOL-HOLDER STANDARD
- 3 = OPTIONAL ACCESSORIES ON REQUEST.
- 4 = TECHNICAL FEATURES
- 5 = ITEM
- 6 = MEASURES, DATA, INDICATIONS
- 7 = ACCESORIES AND SPARE PARTS EQUIPMENT
- 8 = OPTIONAL ACCESORIES AND SPARE PARTS ON REQUEST
- 9 = NOTES AND WARNINGS



- 1 = KEGEL-NORM
- 2 = AUFNAHME-NORM
- 3 = OPTIONALZUBEHÖR AUF ANFRAGE
- 4 = TECHNISCHE HAUPTMERKMALE
- 5 = ARTKEL
- 6 = ABMESSUNGEN, DATEN, HINWEISE
- 7 = ZUBEHÖR UND ERSATZTEIL AUSSTATTUNG
- 8 = OPTIONALZUBEHÖR UND -ERSATZTEILE AUF ANFRAGE
- 9 = ANMERKUNGEN UND HINWEISE





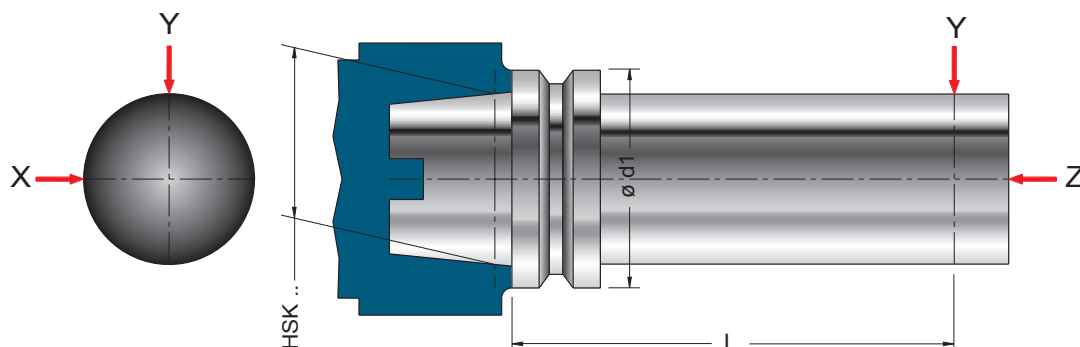

- 1 = NORMES POUR ATTACHEMENT
- 2 = NORME POUR MANDRIN
- 3 = ACCESSOIRES OPTIONNELS SUR DEMANDE
- 4 = CARACTERISTIQUES TECHNIQUES
- 5 = ARTICLE
- 6 = DIMENSIONES, DONNÉES, INDICATIONS
- 7 = ACCESSOIRES ET RECHANGE EN DOTATION
- 8 = ACCESSOIRES ET RECHANGES OPTIONNELS SUR DEMANDE
- 9 = NOTES ET AVERTISSEMENTS





-  PRECISIONE ELEVATA DI RIPETIBILITÀ
-  GREAT PRECISION IN TERMS OF REPEATABILITY
-  HOHE GENAUIGKEIT HINSICHTLICH DER WIEDERHOLBARKEIT
-  PRÉCISION DE POSSIBILITÉ RÉPÉTITIVE ÉLEVÉE



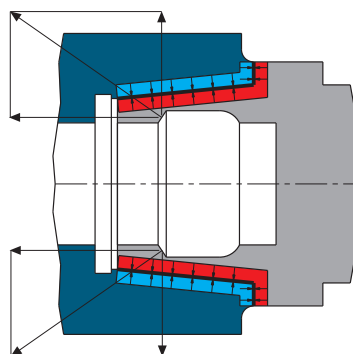



HSK	d1	L	X	Y	Z
32	32	50	0,002	0,002	0,002
40	40	60	0,002	0,002	0,002
50	50	75	0,002	0,002	0,002
63	63	100	0,002	0,002	0,002
100	100	150	0,002	0,002	0,002

-  ELEVATA RESISTENZA ALLA FLESSIONE
-  GREAT BENDING STRENGTH
-  OPTIMALE KRAFTÜBERTRAGUNG
-  ÉLEVÉE RÉSISTANCE À LA FLEXION



-  PARTICOLARMENTE ADATTO PER LE ALTE VELOCITÀ(HSC)
-  PARTICULARLY SUITABLE FOR HIGH SPEEDS(HSC)
-  BESONDERS FÜR HOCHGESCHWINDIGKEIT GEEIGNET(HSC)
-  PARTICULIÈREMENT INDIQUÉ POUR LES HAUTES VITESSES(HSC)

-  BREVI TEMPI DI CAMBIO UTENSILE E MIGLIORE MANIPOLAZIONE
-  SHORT TOOL-CHANGE TIME AND BETTER HANDLING
-  KURZE WERKZEUGWECHSELZEIT UND BESSERE HANDHABUNG
-  TEMPS BREFS DE CHANGEMENT OUTIL ET UNE MEILLEURE MANIPULATION

ART. ISO.A50.HSK.. DIN 69871/AD

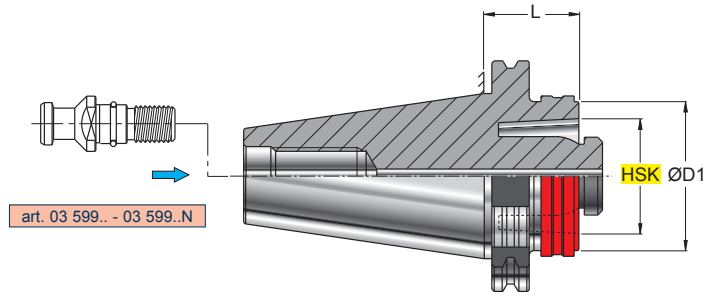

ADATTATORE BASE
BASIC ADAPTER
GRUNDAUFNAHMEN
ADAPTATEUR BASIQUE

PRE-EQUILIBRATO PRE-BALANCED
G 6,3 8000 min⁻¹

ART.	 (mm)	HSK	ØD1	L
ISO.A50.HSK063.040	ISO50	HSK63	63	40

ART. MAS.A50.HSK.. MAS 403 BT/AD

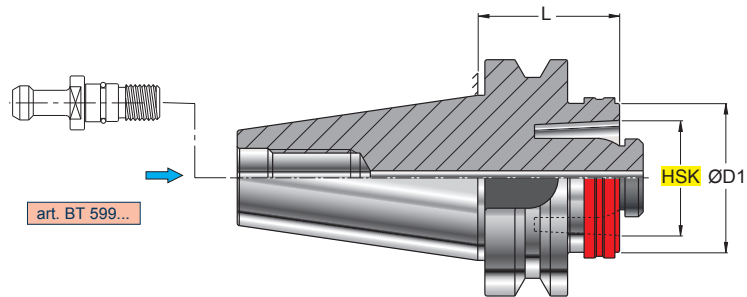

ADATTATORE BASE
BASIC ADAPTER
GRUNDAUFNAHMEN
ADAPTATEUR BASIQUE

PRE-EQUILIBRATO PRE-BALANCED
G 6,3 8000 min⁻¹

ART.	 (mm)	HSK	ØD1	L
MAS.A50.HSK063.060	ISO50	HSK63	63	60

ART. HSK.100.RDU.. DIN 69893/A

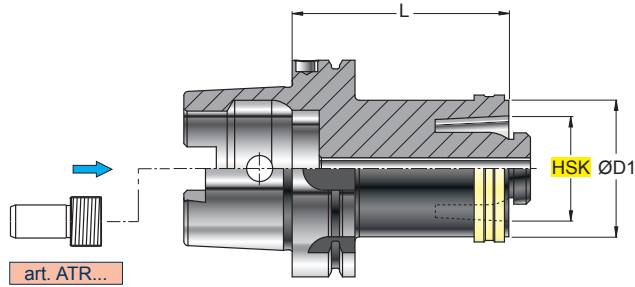

RIDUZIONE
REDUCTION
REDUZIERUNGEN
RÉDUCTION

PRE-EQUILIBRATO PRE-BALANCED
G 6,3 8000 min⁻¹

ART.	 (mm)	HSK	ØD1	L					
HSK.100.RDU063.100	HSK100	HSK63	63	100					

ART. HSK.063.PRL.. DIN 69893/A

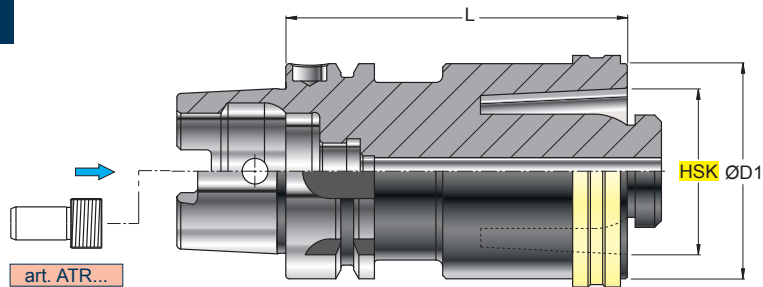

PROLUNGA
EXTENSION
VERLÄNGERUNG
RALLONGE

PRE-EQUILIBRATO PRE-BALANCED
G 6,3 8000 min⁻¹

ART.	 (mm)	HSK	ØD1	L					
HSK.063.PRL063.100	HSK63	HSK63	63	100					

**ART. HSK..ER..
DIN 69893/A**

ER-DIN 6499

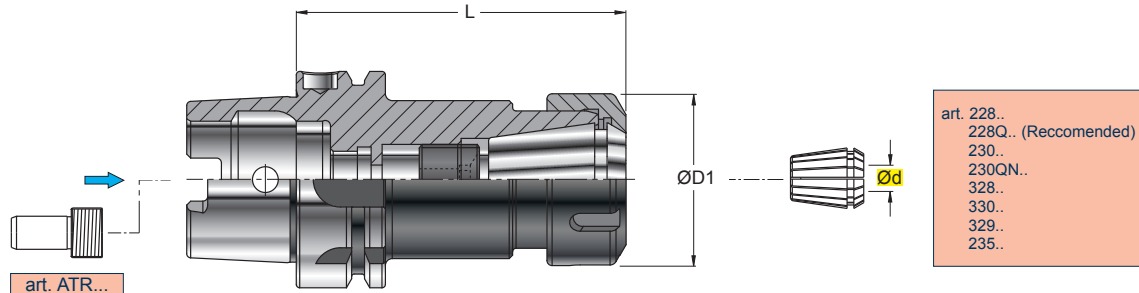

PORTAPINZA DI PRECISIONE
PRECISION COLLET HOLDER
PRÄZISIONSSPANNFUTTER
MANDRIN PORTE-PINCE DE PRÉCISION

	0,003 L ≤ 140
	0,005 L ≤ 200

	PRE-EQUILIBRATO PRE-BALANCED
	G 6,3 8000 min ⁻¹

ART.		(mm)								
		Ød	ØD1	L						
HSK.063.ER016.100	HSK63	0,5-10	28	100	--016---	RGS ER16		925.022	RGC ER16	925.022
HSK.063.ER016.160	HSK63	0,5-10	22	160	--016---	RGM ER16		938.016	RGC ER16	925.022
HSK.063.ER025.100	HSK63	0,5-16	42	100	--025---	RGS ER25		925.040	RGC ER25	925.040
HSK.063.ER025.150	HSK63	0,5-16	42	150	--025---					
HSK.063.ER032.100	HSK63	2-20	50	100	--032---	RGS ER32		925.052	RGC ER32	925.052
HSK.063.ER032.150	HSK63	2-20	50	150	--032---					
HSK.063.ER032.200	HSK63	2-20	50	200	--032---					
HSK.063.ER040.100	HSK63	3-30	63	100	--040---	RGS ER40		925.068	RGC ER40	925.068
HSK.100.ER016.100	HSK100	0,5-10	28	100	--016---	RGS ER16		925.022	RGC ER16	925.022
HSK.100.ER025.120	HSK100	0,5-16	42	120	--025---	RGS ER25		925.040	RGC ER25	925.040
HSK.100.ER025.150	HSK100	0,5-16	42	150	--025---					
HSK.100.ER032.120	HSK100	2-20	50	120	--032---	RGS ER32		925.052	RGC ER32	925.052
HSK.100.ER032.160	HSK100	2-20	50	160	--032---					
HSK.100.ER040.120	HSK100	3-30	63	120	--040---	RGS ER40		925.068	RGC ER40	925.068

ART. HSK..WEH.. DIN 69893/A

DIN 6359 B

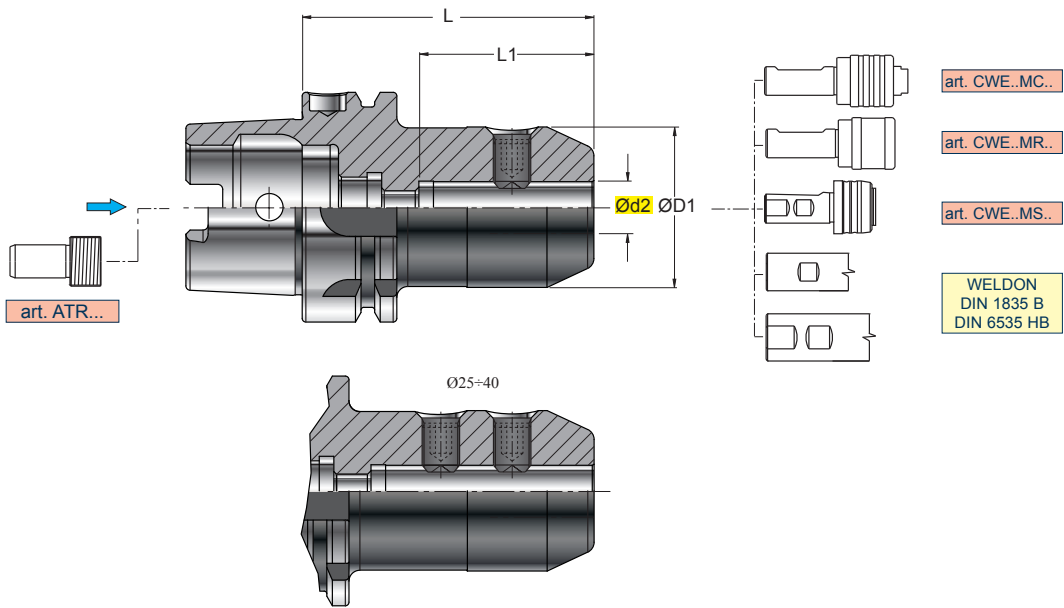



MANDRINO PER ATTACCHI TIPO WELDON
END MILL HOLDER FOR WELDON CONNECTION
WERKZEUGAUFNAHME FÜR WELDON-TYPE
MANDRIN POUR ATTACHEMENT WELDON

Ød2 H5

0,005

PRE-EQUILIBRATO PRE-BALANCED
G 6,3 8000 min⁻¹

ART.		(mm)								
		Ød2	ØD1	L	L1					
HSK.063.WEH008.065	HSK63	8	28	65	38	GR08	5004			
HSK.063.WEH008.150	HSK63	8	28	150	38					
HSK.063.WEH010.075	HSK63	10	35	75	45	GR10	5005			
HSK.063.WEH012.080	HSK63	12	42	80	48	GR1215	5006			
HSK.063.WEH014.080	HSK63	14	44	80	48					
HSK.063.WEH016.150	HSK63	16	48	150	50	GR1415	5006			
HSK.063.WEH020.080	HSK63	20	52	80	50	GR1615	5008			
HSK.063.WEH020.150	HSK63	20	52	150	55					
HSK.063.WEH025.110	HSK63	25	65	110	65	GR1815	5008			
HSK.063.WEH032.110	HSK63	32	72	110	65	GR2015	5010			
HSK.100.WEH010.150	HSK100	10	35	150	45	GR10 GR1215	5005 5006			
HSK.100.WEH012.090	HSK100	12	42	90	50					
HSK.100.WEH014.090	HSK100	14	44	90	50					
HSK.100.WEH016.100	HSK100	16	48	100	55	GR1415	5006			
HSK.100.WEH018.100	HSK100	18	50	100	55					
HSK.100.WEH020.100	HSK100	20	52	100	55	GR1615	5008			
HSK.100.WEH020.150	HSK100	20	52	150	55					
HSK.100.WEH025.100	HSK100	25	65	100	60	GR1815	5010			
HSK.100.WEH032.150	HSK100	32	72	150	65	GR2015	5010			
HSK.100.WEH040.110 New	HSK100	40	80	110	75					

ART. HSK..PU.. DIN 69893/A

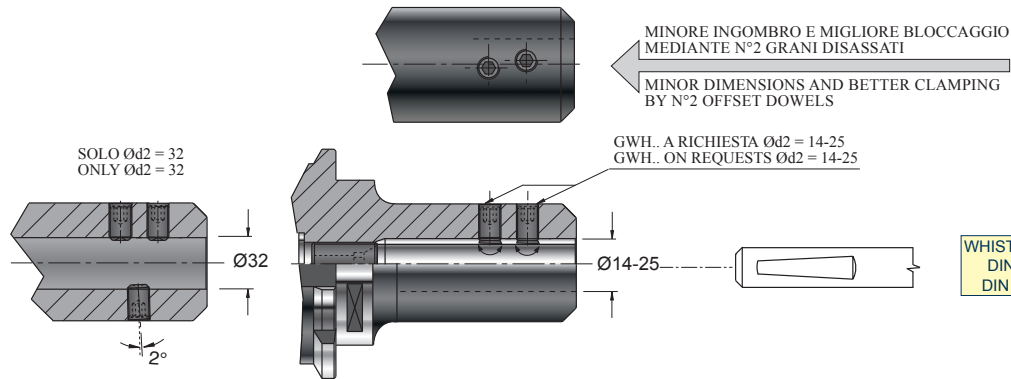
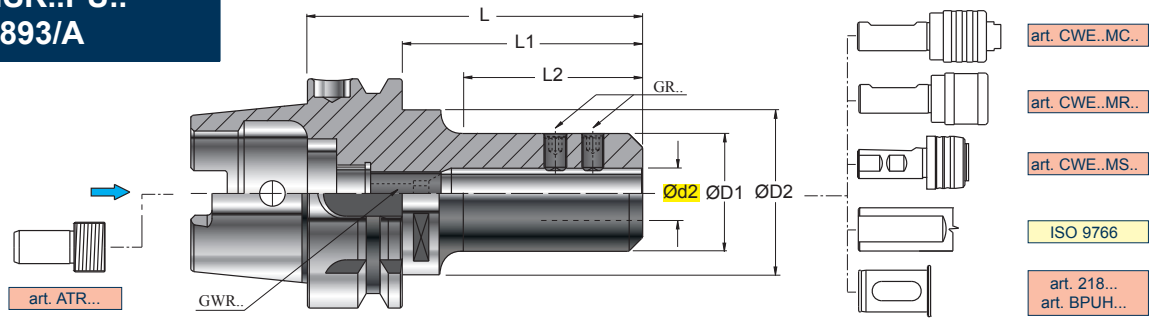

PORTAPUNTA UNIVERSALE
UNIVERSAL ADAPTER FOR DRILLING TOOLS
WELDON-AUFNAHME FÜR VOLLBOHRER
PORTE-FORET UNIVERSEL

Ød2 H5

0,003

PRE-EQUILIBRATO	PRE-BALANCED
	HSK63 = G6,3 10000 min ⁻¹
	HSK100 = G6,3 8000 min ⁻¹

ART.		(mm)											
		Ød2	ØD1	ØD2	L	L1	L2						
HSK.063.PU016.100	HSK63	16	38	52,5	100	74	52	n°2 GR10	GWR12	5005	5006	GWH10	5005
HSK.063.PU020.100	HSK63	20	42	52,5	100	74	52	n°2 GR10	GWR16	5005	5008	GWH10	5005
HSK.063.PU025.090	HSK63	25	48	52,5	90	64	46	n°2 GR10	-	5005	-	GWH10	5005
HSK.063.PU032.090	HSK63	32	58	52,5	90	64	-	n°3 GR14	-	5006	-	-	-
HSK.063.PU040.100	HSK63	40	64	52,5	100	74	-						
HSK.100.PU020.140	HSK100	20	42	84,5	140	111	50	n°2 GR10	GWR16	5005	5008	GWH10	5005
HSK.100.PU032.130	HSK100	32	58	84,5	130	101	60	n°3 GR14	-	5006	-	-	-

**ART. HSK..FSW..
DIN 69893/A**

ISO 3937

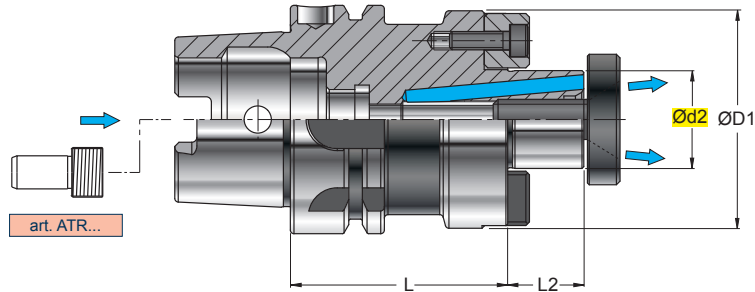







PORTAFRESA A TRASCINAMENTO FRONTALE CON TENONE
SHELL END-MILL HOLDERS WITH TENON
FRÄSERAUFNÄHME MIT QUERNUT UND LAPPEN
PORTE-FRAISE A ENTRAINEMENT FRONTAL AVEC TENON

PRE-EQUILIBRATO PRE-BALANCED

0,01

G 6,3 8000 min⁻¹

ART.		(mm)									
		Ød2	ØD1	L	L2						
HSK.063.FSW016.050	HSK63	16	40	50	17	RS16	VBS08	TSFS16	VB 02		5025
HSK.063.FSW022.050	HSK63	22	50	50	19	RS22	VBS10	TSFS22	VB 04		5003
HSK.063.FSW027.060	HSK63	27	60	60	21	RS27	VBS12	TSFS27	VB 05		5004
HSK.063.FSW032.060	HSK63	32	68	60	24	RS32	VBS16	TSFS32	VB 05		5004
HSK.063.FSW040.060	HSK63	40	82	60	27	RS40	VBS20	TSFS40	VB 06		5005
HSK.100.FSW022.050	HSK100	22	50	50	19	RS22	VBS10	TSFS22	VB 04		5003
HSK.100.FSW027.050	HSK100	27	60	50	21	RS27	VBS12	TSFS27	VB 05		5004
HSK.100.FSW032.050	HSK100	32	68	50	24	RS32	VBS16	TSFS32	VB 05		5004
HSK.100.FSW040.060	HSK100	40	82	60	27	RS40	VBS20	TSFS40	VB 06		5005

**ART. HSK..FSV..
DIN 69893/A**

ISO 3937

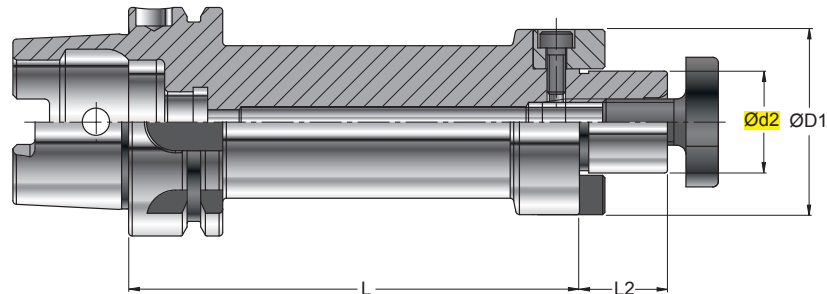

PORTAFRESA ANTIVIBRANTE A TRASCINAMENTO FRONTALE CON TENONE
 VIBRATION-DAMPED SHELL END-MILL HOLDERS WITH TENON
 SCHWINGUNGSGEDÄMPFTE FRÄSERAUFNÄHME MIT QUERNUT UND LAPPEN
 MANDRIN PORTE-FRAISE ANTIVIBRATOIRE A ENTRAÎNEMENT FRONTAL AVEC TENON

0,015

PRE-EQUILIBRATO PRE-BALANCED
 G 6,3 8000 min⁻¹

ART.		(mm)				kg						
		Ød2	ØD1	L	L2							
HSK.063.FSV016.200	HSK63	16	38	200	17	2,30	CHF16V	VB 02	422.016..		5025	423.016..
HSK.063.FSV016.300	HSK63	16	38	300	17	3,60						
HSK.063.FSV022.200	HSK63	22	48	200	19	2,80	CHF22V	VB 04	422.022..		5003	423.022..
HSK.063.FSV022.300	HSK63	22	48	300	19	4,10						
HSK.063.FSV027.200	HSK63	27	58	200	21	3,10	CHF27V	905.005. 080.012	422.027..		5004	423.027..
HSK.100.FSV016.200	HSK100	16	38	200	17	5,40	CHF16V	VB 02	422.016..		5025	423.016..
HSK.100.FSV016.300	HSK100	16	38	300	17	6,20						
HSK.100.FSV022.200	HSK100	22	48	200	19	5,10	CHF22V	VB 04	422.022..		5003	423.022..
HSK.100.FSV022.300	HSK100	22	48	300	19	6,50						
HSK.100.FSV027.200	HSK100	27	58	200	21	5,80	CHF27V	905.005. 080.012	422.027..		5004	423.027..
HSK.100.FSV027.300	HSK100	27	78	300	21	7,80						
HSK.100.FSV032.300	HSK100	32	78	300	24	8,10	CHF32V	905.005. 080.012	422.032..		5004	423.032..

ART. HSK..FC..
DIN 69893/A



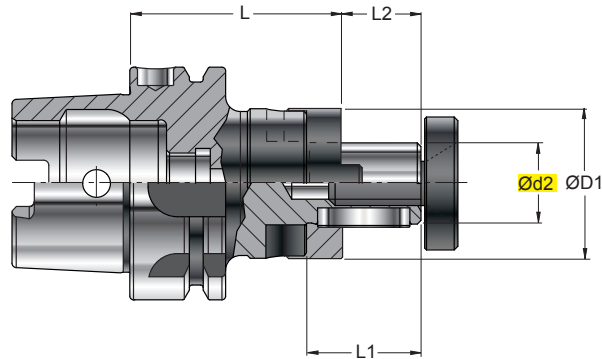

DIN 6358 B







PORTAFRESA A TRASCINAMENTO COMBINATO PER FRESE A MANICOTO E A DISCO
COMBI FACE MILL HOLDERS FOR SHELL-END AND DISC MILLING CUTTERS.
FRÄSERAUFNAHME KOMBINIERT FÜR AUFSTECK-UND SCHEIBENFRÄSER
MANDRIN PORTE-FRAISE À ENTRAÎNEMENT COMBINÉ POUR FRAISES À MANCHON ET DE DISQUE

PRE-EQUILIBRATO PRE-BALANCED
G 6,3 8000 min⁻¹

0,015

ART.		(mm)									
		Ød2	ØD1	L	L1	L2					
HSK.063.FC016.060	HSK63	16	32	60	27	17	RS 16	VBS08	CT0420	08.3501.016.AT	
HSK.063.FC022.060	HSK63	22	40	60	31	19	RS 22	VBS10	CT0625	08.3502.022.AT	
HSK.063.FC027.060	HSK63	27	48	60	33	21	RS 27	VBS12	CT0725	08.3503.027.AT	
HSK.063.FC032.100	HSK63	32	58	100	38	24	RS 32	VBS16	CT0828	08.3504.032.AT	
HSK.063.FC040.100	HSK63	40	70	100	41	27	RS 40	VBS20	CT1032	08.3505.040.AT	

 PER IL MONTAGGIO DELLE FRESE A DISCO OCCORRE L'ANELLO DISTANZIATORE **195..** , PAG 1095
 FOR THE INSTALLATION OF THE DISC MILLING CUTTERS THE DISTANCE RING **195..** (PAGE 1095) IS REQUIRED.
 ZUM EINBAU DER SCHEIBENFRÄSER WIRD DER DISTANZRING **195..** (SEITE 1095) BENÖTIGT.
 EN CAS DE MONTAGE DES FRAISES-DISQUES LA BAGUE D'ENTRETOISE **195..** , PAGE 1095 S'IMPOSE

ART. HSK..MS.. DIN 69893/A

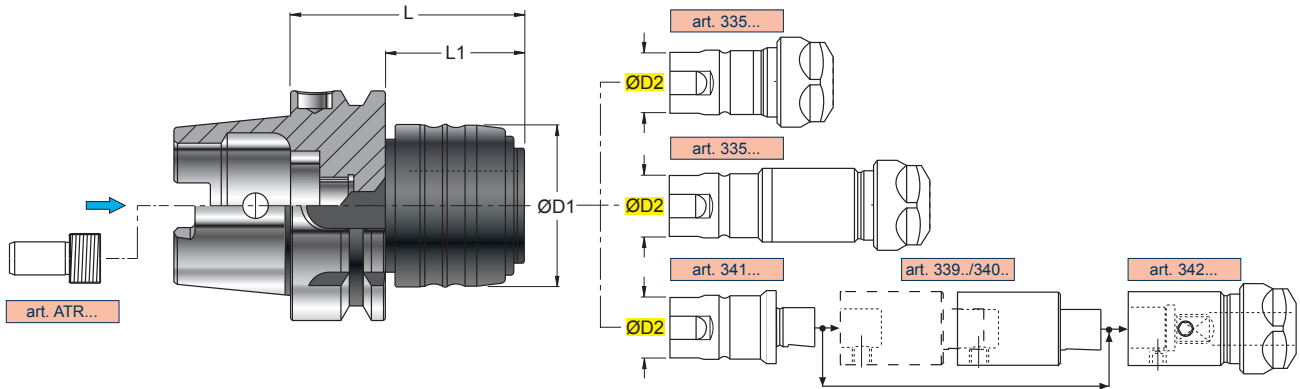

PORTA MASCHIO A CAMBIO RAPIDO PER MASCHIATURA SINCRONIZZATA
 QUICK CHANGE TAP HOLDER FOR SYNCHRONIZED TAPPING
 GEWINDESCHNEID-SCHNELLWECHSELFUTTER ZUM STARREN GEWINDESCHNEIDEN
 APPAREIL PORTE-TARAUDS À CHANGEMENT RAPIDE POUR TARAUDAGE SYNCHRONISÉ

ART.		(mm)				Campo di maschiatura Tap range					
		ØD1	ØD2	L	L1						
HSK.063.MS020.064	HSK63	43	20	64	38	M3-M12					
HSK.063.MS032.097	HSK63	60	32	97	71	M6-M20					
HSK.100.MS020.070	HSK100	43	20	70	41	M3-M12					
HSK.100.MS032.091	HSK100	60	32	91	62	M6-M20					
HSK.100.MS050.115	HSK100	87	50	115	86	M14-M33					

ART. HSK..SF.. DIN 69893/A

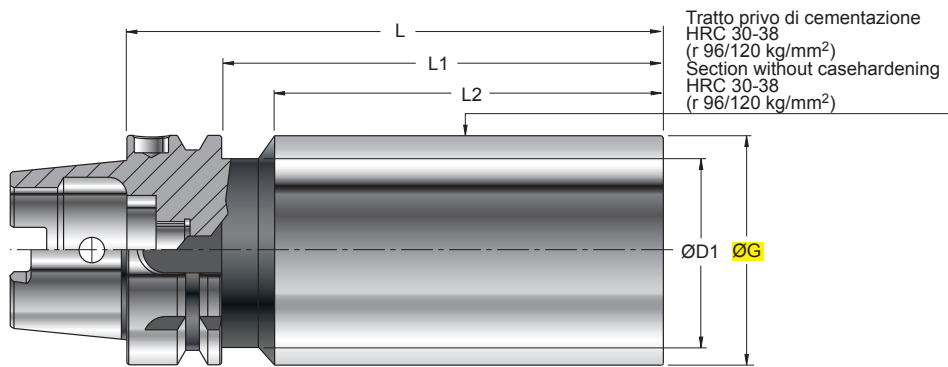

BARRA CON CONO FINITO E STELO TENERO
BORING BARS WITH FINISHED TAPER AND BLANK SHAFT
ROHLINGE
BARRE AVEC CONE FINI ET BOUT DOUX

ART.		(mm)									
		ØG	ØD1	L	L1	L2					
HSK.063.SF063.226	HSK63	63	52,5	226	200	184					
HSK.063.SF063.326	HSK63	63	52,5	326	300	284					
HSK.063.SF098.250	HSK63	98	52,5	250	225	209					
HSK.100.SF100.279	HSK100	100	84,5	279	250	234					

ART. HSK.063.MD.. DIN 69893/A

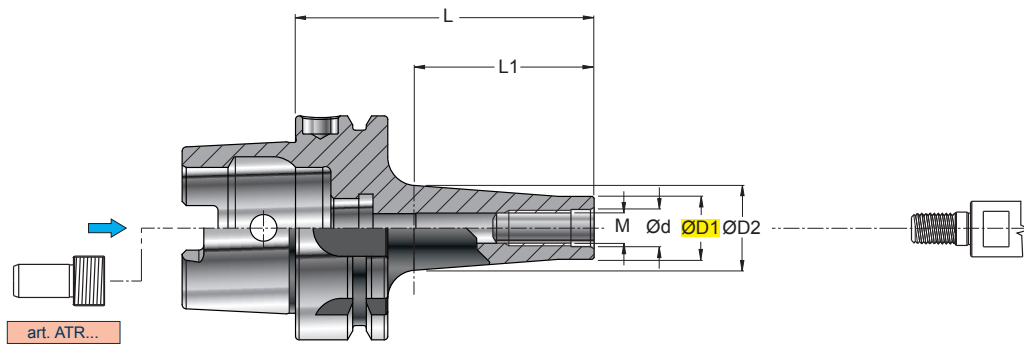

- art. 253..VW
S1089W..
S1503.9W..
S2000.89W..
S613/4.9.45W..
S659W..
S809W..
S849W..
S929..
S959..
S9002.9W..
S9004.9W..
S9005.9W..
S9006.9W..

PORTAFRESA CON ATTACCO MODULARE-FILETTATO
CUTTER-HOLDER WITH MODULAR THREADED CONNECTION
FRASERAUFNAHME MIT MODULAR-GEWINDEAUFNAHME
MANDRIN PORTE-FRAISE AVEC ATTACHEMENT MODULAIRE FILETÉ

0,005

EQUILIBRATO
BALANCED
G 6,3 15000 min⁻¹

ART.		(mm)										
		M	Ød	ØD1	ØD2	L	L1					
HSK.063.MD008.134	HSK63	8	8,5	12,7	25	134	100					
HSK.063.MD010.059	HSK63	10	10,5	17,7	20	59	25					
HSK.063.MD010.084	HSK63	10	10,5	17,7	25	84	50					
HSK.063.MD010.109	HSK63	10	10,5	17,7	28	109	75					
HSK.063.MD010.134	HSK63	10	10,5	17,7	30	134	100					
HSK.063.MD012.084	HSK63	12	12,5	20,7	24	84	50					
HSK.063.MD012.109	HSK63	12	12,5	20,7	31	109	75					
HSK.063.MD012.134	HSK63	12	12,5	20,7	31	134	100					
HSK.063.MD016.059	HSK63	16	17	28,7	34	59	25					
HSK.063.MD016.084	HSK63	16	17	28,7	34	84	50					
HSK.063.MD016.109	HSK63	16	17	28,7	34	109	75					
HSK.063.MD016.134	HSK63	16	17	28,7	39	134	100					

ART. HSK. ..MDV.. DIN 69893/A

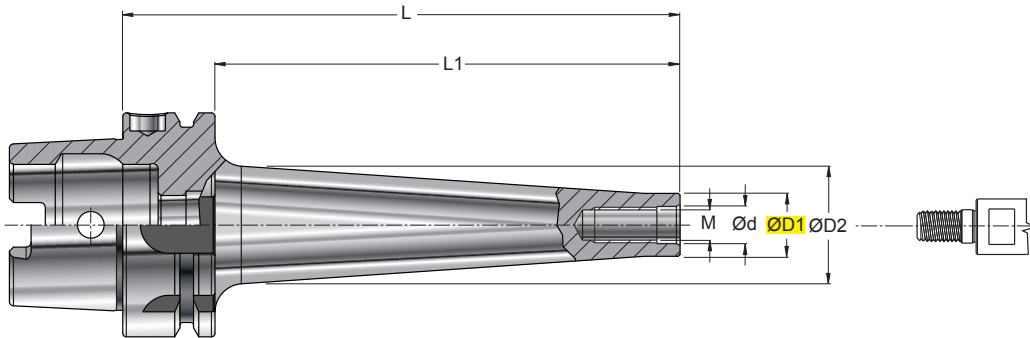

- art. 253..VW
S1089W..
S1503.9W..
S2000.89W..
S613/4.9.45W..
S659W..
S809W..
S849W..
S929..
S959..
S9002.9W..
S9004.9W..
S9005.9W..
S9006.9W..

PORTAFRESA ANTIVIBRANTE CON ATTACCO MODULARE-FILETTATO
VIBRATION-DAMPED CUTTER-HOLDER WITH MODULAR THREADED CONNECTION
SCHWINGUNGSGEDÄMPFTE FRASERAUFNAHME MIT MODULAR-GEWINDEAUFNAHME
MANDRIN PORTE-FRAISE ANTIVIBRATOIRE AVEC ATTACHEMENT MODULAIRE FILETÉ

0,015

PRE-EQUILIBRATO	PRE-BALANCED
	HSK63 = G6,3 15000 min ⁻¹
	HSK100 = G6,3 10000 min ⁻¹

ART.		(mm)						kg						
		M	Ød	ØD1	ØD2	L	L1							
HSK.063.MDV010.200	HSK63	10	10,5	18	35	200	174	1,30						
HSK.063.MDV012.200	HSK63	12	12,5	21	38	200	174	1,30						
HSK.063.MDV012.250	HSK63	12	12,5	21	47	250	224	1,50						
HSK.063.MDV016.250	HSK63	16	17,0	29	50	250	224	2,10						
HSK.100.MDV012.300	HSK100	12	12,5	21	47	300	271	3,60						
HSK.100.MDV016.300	HSK100	16	17,0	29	55	300	271	4,40						

ART. HSK..CTS..
DIN 69893/A

DIN 69882-8

NEW

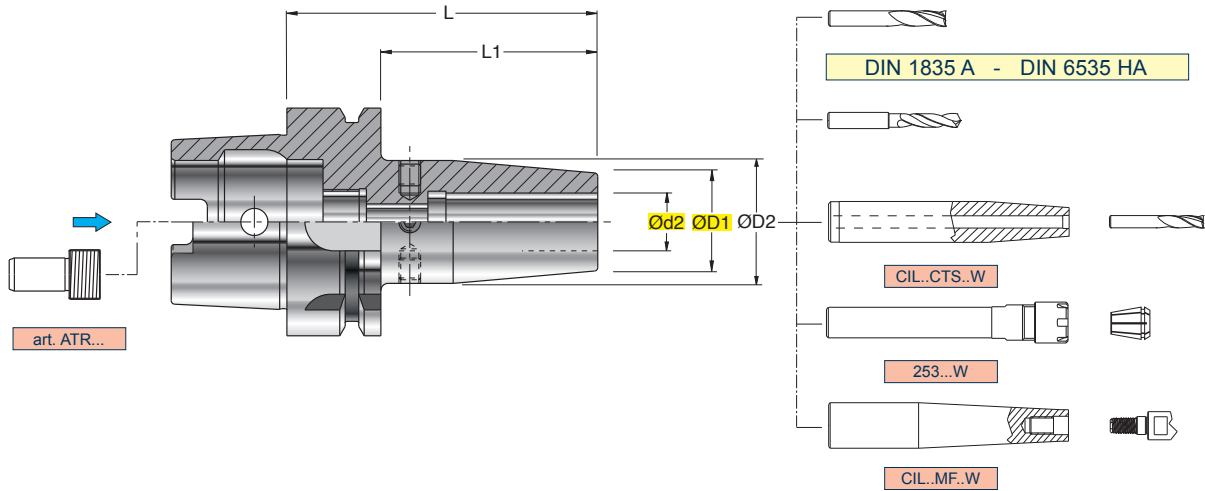

MANDRINO A CALETTAMENTO TERMICO
SHRINKING-ON TAPER SHANKS
WERKZEUGAUFNAHMEN MIT SCHRUMPFVERBINDUNG
MANDRIN À EMBOÎTEMENT THERMIQUE

0,003

EQUILIBRATO
BALANCED
G 2,5 25000 min⁻¹

ART.	(mm)	Ød2	ØD1	ØD2	L	L1
HSK.063.CTS006.080	HSK63	6	21	27	80	54
HSK.063.CTS006.130	HSK63	6	21	27	130	104
HSK.063.CTS006.160	HSK63	6	21	27	160	134
HSK.063.CTS008.080	HSK63	8	21	27	80	54
HSK.063.CTS008.130	HSK63	8	21	27	130	104
HSK.063.CTS008.160	HSK63	8	21	27	160	134
HSK.063.CTS010.085	HSK63	10	24	32	85	59
HSK.063.CTS010.130	HSK63	10	24	32	130	104
HSK.063.CTS010.160	HSK63	10	24	32	160	134
HSK.063.CTS012.090	HSK63	12	24	32	90	64
HSK.063.CTS012.130	HSK63	12	24	32	130	104
HSK.063.CTS012.160	HSK63	12	24	32	160	134
HSK.063.CTS014.090	HSK63	14	27	34	90	64
HSK.063.CTS014.130	HSK63	14	27	34	130	104
HSK.063.CTS014.160	HSK63	14	27	34	160	134
HSK.063.CTS016.095	HSK63	16	27	34	95	69
HSK.063.CTS016.130	HSK63	16	27	34	130	104
HSK.063.CTS016.160	HSK63	16	27	34	160	134
HSK.063.CTS018.095	HSK63	18	33	42	95	69
HSK.063.CTS018.130	HSK63	18	33	42	130	104
HSK.063.CTS018.160	HSK63	18	33	42	160	134
HSK.063.CTS020.100	HSK63	20	32	42	100	74
HSK.063.CTS020.130	HSK63	20	32	42	130	104
HSK.063.CTS020.160	HSK63	20	32	42	160	134
HSK.063.CTS025.130	HSK63	25	44	53	130	104
HSK.063.CTS025.160	HSK63	25	44	53	160	134
HSK.100.CTS006.085	HSK100	6	21	27	85	56
HSK.100.CTS006.130	HSK100	6	21	27	130	101
HSK.100.CTS006.160	HSK100	6	21	27	160	131
HSK.100.CTS008.085	HSK100	8	21	27	85	56
HSK.100.CTS008.130	HSK100	8	21	27	130	101
HSK.100.CTS008.160	HSK100	8	21	27	160	131
HSK.100.CTS010.090	HSK100	10	24	32	90	61
HSK.100.CTS010.130	HSK100	10	24	32	130	101
HSK.100.CTS010.160	HSK100	10	24	32	160	131
HSK.100.CTS012.095	HSK100	12	24	32	95	66
HSK.100.CTS012.130	HSK100	12	24	32	130	101
HSK.100.CTS012.160	HSK100	12	24	32	160	131
HSK.100.CTS014.095	HSK100	14	27	34	95	66
HSK.100.CTS014.130	HSK100	14	27	34	130	101
HSK.100.CTS014.160	HSK100	14	27	34	160	131
HSK.100.CTS016.100	HSK100	16	27	34	100	71
HSK.100.CTS016.130	HSK100	16	27	34	130	101
HSK.100.CTS016.160	HSK100	16	27	34	160	131
HSK.100.CTS018.100	HSK100	18	33	42	100	71
HSK.100.CTS018.130	HSK100	18	33	42	130	101
HSK.100.CTS018.160	HSK100	18	33	42	160	131
HSK.100.CTS020.130	HSK100	20	33	42	130	101
HSK.100.CTS020.160	HSK100	20	33	42	160	131
HSK.100.CTS025.115	HSK100	25	44	53	115	86
HSK.100.CTS025.160	HSK100	25	44	53	160	131
HSK.100.CTS032.120	HSK100	32	44	53	120	91
HSK.100.CTS032.160	HSK100	32	44	53	160	131

ART. HSK..CTPN.. DIN 69893/A

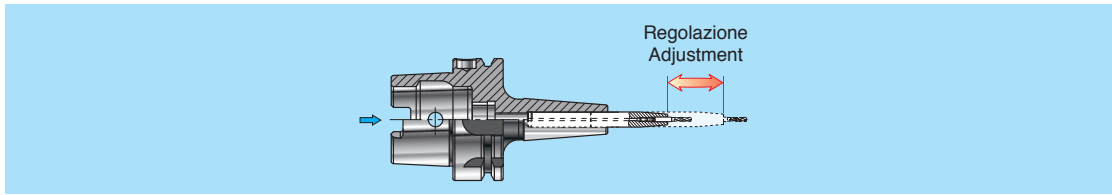
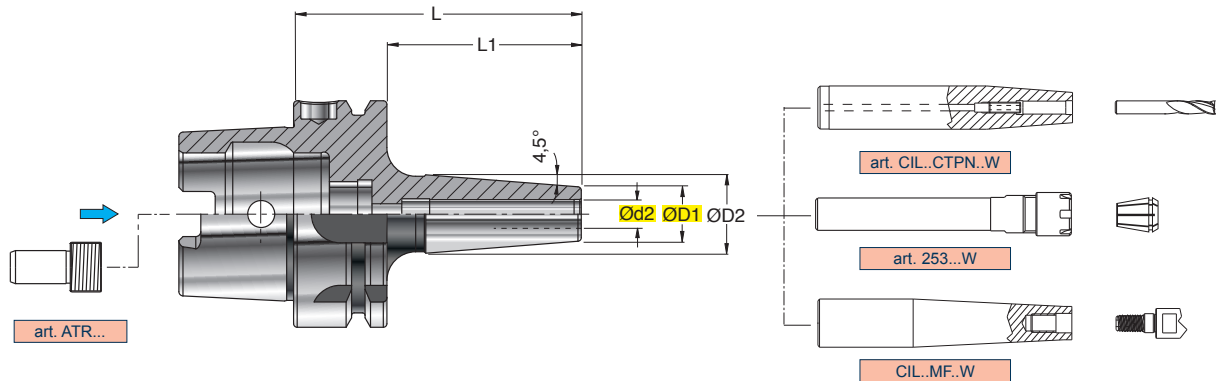

MANDRINO A CALETTAMENTO TERMICO
SHRINKING-ON TAPER SHANKS
WERKZEUGAUFNAHMEN MIT SCHRUMPFVERBINDUNG
MANDRIN À EMBOÏTEMENT THERMIQUE

ART.		(mm)									
		Ød2	ØD1	ØD2	L	L1					
HSK.063.CTPN016.130	HSK63	16	27	34	130	104					
HSK.063.CTPN025.130	HSK63	25	44	52	130	104					
HSK.100.CTPN016.130	HSK100	16	27	34	130	101					
HSK.100.CTPN025.130	HSK100	25	44	53	130	101					
HSK.100.CTPN032.130	HSK100	32	44	53	130	101					

ART. HSK..MFSN.. DIN 69893/A

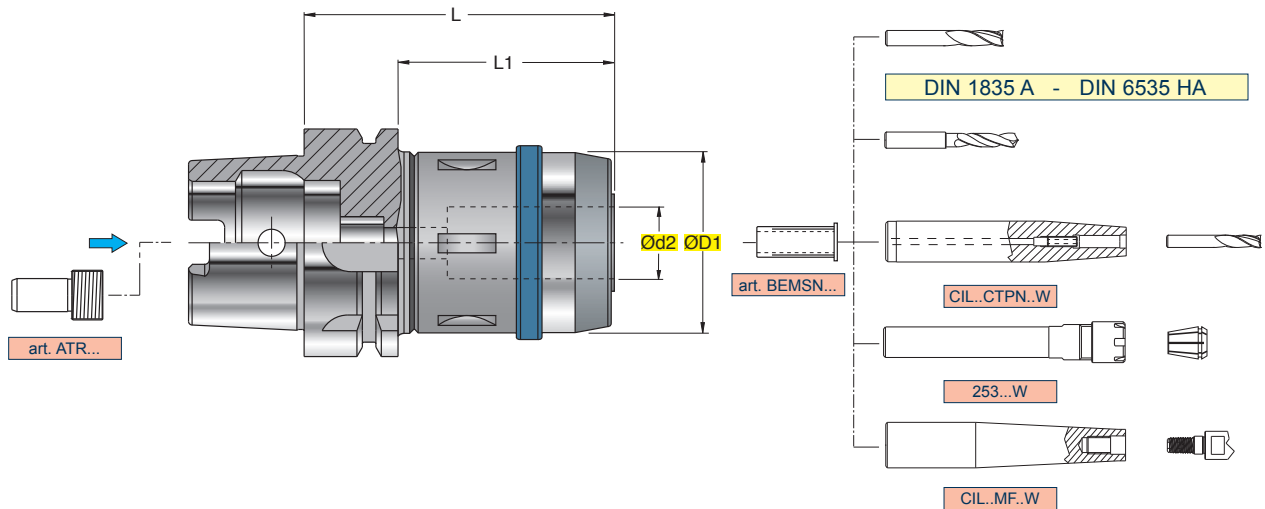

MANDRINO A FORTE SERRAGGIO
HIGH CLAMPING CHUCKS
KRAFTSPANNFUTTER
MANDRIN À FORT SERRAGE

	0,003 2,5 x Ø
	0,004 2,5 x Ø

	EQUILIBRATO BALANCED
	G 2,5 20000 min ⁻¹

ART.		(mm)	Ød2	ØD1	L	L1			
HSK.063.MFSN020.086	HSK63	20	50	86	60	BEMSN.20		925.052	ESMS.010
HSK.063.MFSN032.108	HSK63	32	67	108	82	BEMSN.32		925.068	ESMS.010
HSK.100.MFSN020.105	HSK100	20	50	105	76	BEMSN.20		925.052	ESMS.010
HSK.100.MFSN032.105	HSK100	32	67	105	76	BEMSN.32		925.068	ESMS.010

CARATTERISTICHE TECNICHE - TECHNICAL CHARACTERISTICS

- Ridotte dimensioni di ingombro (lunghezza e diametro esterno) che consentono una migliore equilibratura (G 2,5 fino a 20000 rpm)
- Aumento della rigidità del mandrino per una resa migliore in lavorazione
- Perfetta centratura dell'utensile (0,003/0,004 mm a 2,5xØ) che determinano un incremento della durata degli inserti fino a raddoppiare la durata
- Aumento della potenza di serraggio Max 1750 Nm
- Adatto anche per frese con attacco cilindrico, weldon, whistle notch e punte in metallo duro
- Passaggio del lubrificante attraverso l'utensile fino a 100 bar
- Serraggio ottimale garantito dall'allineamento delle tacche (ghiera mandrino)

- Reduced dimensions (length and external diameter) for a better balancing (G 2,5 till to 20000 rpm)
- High rigidity of the chuck for a better performance
- Perfect concentricity (0,003/0,004 mm 2,5xØ) for an increase in toollife
- Increase of tightening force Max 1750 Nm
- Suitable for endmills tools with cylindrical, weldon and whistle notch shank and for carbide drills
- Coolant through the tool till 100 bar
- Best clamping assured by alignment of notches (fixin ring nut/arbor)

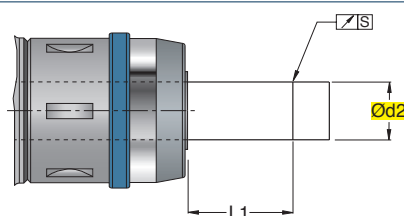

Ød2 (mm)	L1 (mm)	Concentricità "S" Concentricity "S" (mm)	Forza di serraggio Clamping force (Nm)
20	40	0,003	1000
32	64	0,004	1750

PER AVERE UNA TENUTA DEL LUBRIFICANTE FINO A 100 bar BISOGNA ACQUISTARE IL MANDRINO CON ANELLO DI TENUTA. PER ORDINARE TALE MANDRINO, BISOGNA AGGIUNGERE AL CODICE DEL MANDRINO SCELTO UNA "F" FINALE E SPECIFICARLO AL MOMENTO DELL' ORDINE. UTILIZZANDO LE PINZE DI RIDUZIONE CILINDRICHE BISOGNA SOSTITUIRE L'ANELLO DI TENUTA DEL DIAMETRO DELL'UTENSILE PRESCELTO. IL MANDRINO GARANTISCE IL PASSAGGIO DEL LUBRIFICANTE (max 100 bar), SIA CON UTENSILI CALETTATI DIRETTAMENTE SIA CON PINZE DI RIDUZIONE CILINDRICHE BEMS.. INTERPOSTE.

TO OBTAIN A COOLANT FLOW UP TO 100 bar YOU MUST PURCHASE THE CHUCK WITH SEALING RING. TO ORDER THIS CHUCK YOU MUST ADD A FINAL "F" TO THE SELECTED CHUCK CODE AND SPECIFY IT WHEN PLACING THE ORDER. FOR THE USE OF THE CYLINDRICAL REDUCTION SLEEVES THE SEALING RING MUST BE REPLACED WITH ONE OF THE SAME DIAMETER AS THE TOOL CHOSEN. THE HIGH CLAMPING CHUCK IS SUITABLE FOR A COOLANT FLOW (UP TO 100 bar) BOTH WITH DIRECTLY SHRUNK-ON TOOLS AND WITH BEMS CYLINDRICAL REDUCTION SLEEVES.

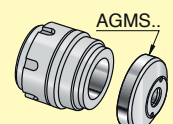

ART. HSK..MI.. DIN 69893/A

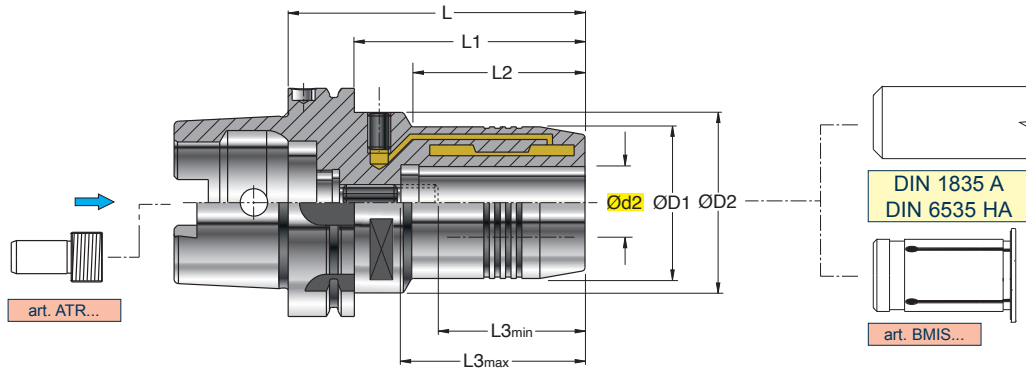

NEW



MANDRINO A BLOCCAGGIO IDRAULICO
HYDRAULIC CLAMPING CHUCK
AUFNAHME MIT HYDRODEHNSTANNUNG
MANDRIN AVEC BLOCAGE HYDRAULIC

0,005 L<= 3xd2

EQUILIBRATO
BALANCED
G 2,5 25000 min⁻¹

ART.		(mm)												
		HSK	Ød2	ØD1	ØD2	L	L1	L2	L3min					
HSK.063.MI020.090	HSK63	20	43	50	90	64	48	42,5	52,5	BMIS 20..				
HSK.100.MI020.105	HSK100	20	43	50	105	76	59	42,5	52,5	BMIS 20..				

PORTAPINZA STANDARD

- COLLET HOLDER STANDARD
- SPANNFUTTER STANDARD
- MANDRIN PORTE-PINCE STANDARD

ISO.B..ER..
... /AD - B

ER-DIN 6499

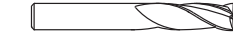
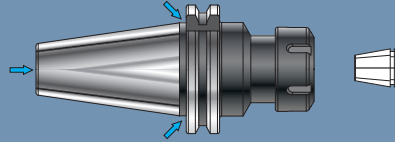

DIN 1835 A - DIN 6535 HA



PAG 988

MANDRINO CORTO PER ATTACCHI TIPO WELDON

- END-MILL HOLDER FOR WELDON CONNECTION SHORT-TYPE
- AUFNAHME FÜR WELDON-TYPE, KURZE AUSFÜHRUNG
- MANDRIN POUR ATTACHEMENT WELDON, SERIE COURTE

ISO.A..WEC..
... /AD

PAG 989

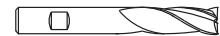
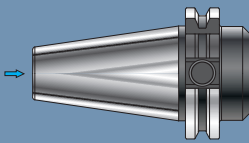

WELDON - DIN1835B - DIN6535HB

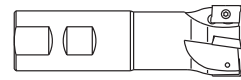

MANDRINO PER ATTACCHI TIPO WELDON

- END MILL HOLDER FOR WELDON CONNECTION
- WERKZEUGAUFNAHME FÜR WELDON-TYPE
- MANDRIN POUR ATTACHEMENT WELDON

ISO.B..WE..
... /AD - B

DIN 6359 B

PAG 990-991

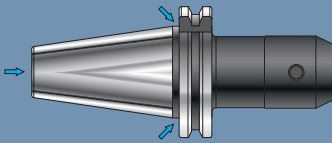

WELDON - DIN1835B - DIN6535HB

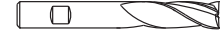

ISO 9766



PORTAPUNTA UNIVERSALE

- UNIVERSAL ADAPTER FOR DRILLING TOOLS
- WELDON-AUFNAHME FÜR VOLLBOHRER
- PORTE-FORET UNIVERSEL

ISO.B..PUH..
... /AD - B

PAG 992

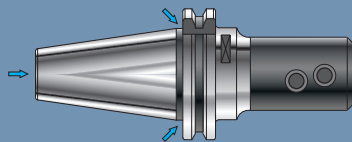

WHISTLE-NOTCH - DIN1835E - DIN6535HE

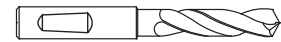

ISO 9766



PORTAFRESA A TRASCINAMENTO FRONTALE CON TENONE

- SHELL END-MILL HOLDERS WITH TENON
- FRÄSERAUFNAHME MIT QUERNUT UND LAPPEN
- PORTE-FRAISE A ENTRAÎNEMENT FRONTAL AVEC TENON

ISO.B..FSW..
... /AD - B

ISO 3937

PAG 993

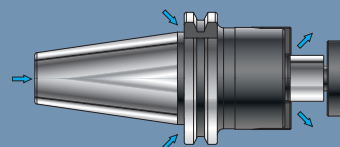

ISO 6462

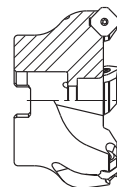

PORTAFRESA ANTIVIBRANTE A TRASCINAMENTO FRONTALE CON TENONE

- VIBRATION-DAMPED SHELL END-MILL HOLDERS WITH TENON
- SCHWINGUNGSGEDÄMPFTE FRÄSERAUFNAHME MIT QUERNUT UND LAPPEN
- MANDRIN PORTE-FRAISE ANTIVIBRATOIRE A ENTRAÎNEMENT FRONTAL AVEC TENON

ISO.A..FSV..
... /A

ISO 3937

PAG 994

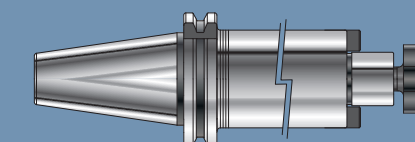

ISO 6462

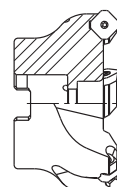

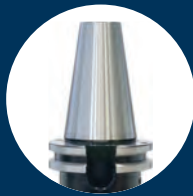

**PORTAFRESA ANTIVIBRANTE
A TRASCINAMENTO FRONTALE CON TENONE**
- VIBRATION-DAMPED SHELL END-MILL
HOLDERS WITH TENON
- SCHWINGUNGSGEDÄMPFTE
FRÄSERAUFNAHME MIT QUERNUT UND
LAPPEN
- MANDRIN PORTE-FRAISE ANTIVIBRATOIRE A
ENTRAÎNEMENT FRONTAL AVEC TENON

ISO.A..FSCV..
... /A

ISO 6462

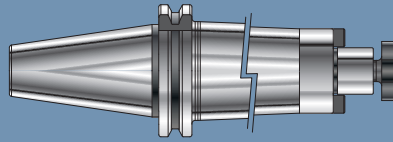

ISO 6462

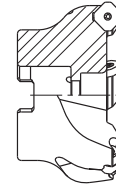

PAG 995

**PORTAFRESA A TRASCINAMENTO
FRONTALE CON TENONE**
- SHELL END-MILL HOLDERS WITH TENON
- FRÄSERAUFNAHME MIT QUERNUT UND
LAPPEN
- PORTE-FRAISE A ENTRAÎNEMENT FRONTAL
AVEC TENON

ISO.A..FF..
... /A

DIN 6357 B

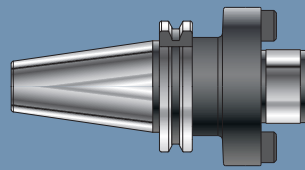

DIN 8030 C



PAG 996

**PORTAFRESA A TRASCINAMENTO
COMBINATO PER FRESE A MANICOTTO
E A DISCO**
- COMBI FACE MILL HOLDERS FOR SHELL-END
AND DISC MILLING CUTTERS
- FRÄSERAUFNAHME KOMBINIERT FÜR
AUFSTECK-UND SCHEIBENFRÄSER
- MANDRIN PORTE-FRAISE À ENTRAÎNEMENT
COMBINÉ POUR FRAISES À MANCHON ET DE
DISQUE

ISO.A..FC..
... /A

DIN 6358 B

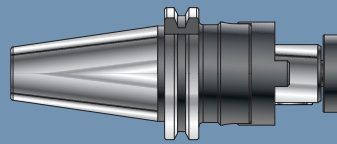

ISO 6462

DIN 138

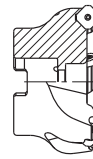

PAG 997

**PORTAMASCHIO A CAMBIO RAPIDO
CON DOPPIA COMPENSAZIONE**
- QUICK-CHANGE TAP HOLDER WITH DOUBLE
COMPENSATION
- GEWINDESCHNEID-SCHNELLWECHSELFUTTER
MIT DOPPELAUSGLEICH
- MANDRINS DE TARAUDAGE À CHANGEMENT
RAPIDE À DOUBLE COMPENSATION

ISO.A..MC..
... /A

PAG 998

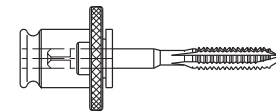
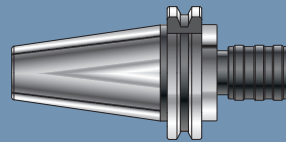

**PORTAMASCHIO A CAMBIO RAPIDO
PER MASCHIATURA SINCRONIZZATA**
- QUICK CHANGE TAP HOLDER FOR
SYNCHRONIZED TAPPING
- GEWINDESCHNEID-SCHNELLWECHSELFUTTER
ZUM STARREN GEWINDESCHNEIDEN
- APPAREIL PORTE-TARAUDS À CHANGEMENT
RAPIDE POUR TARAUDAGE SYNCHRONISÉ

ISO.A/B..MS..
... /AD /... /AD - B

PAG 999

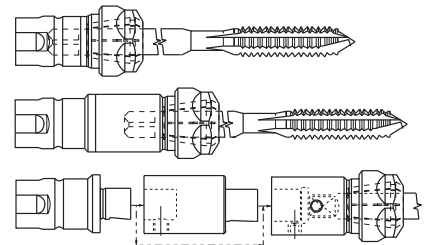
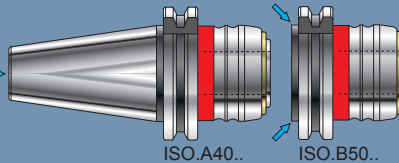

BARRA CON CONO FINITO E STELO TENERO
- BORING BARS WITH FINISHED TAPER
AND BLANK SHAFT
- ROHLINGE
- BARRE AVEC CONE FINI ET BOUT DOUX

ISO.A..SF..
... /A

PAG 1000

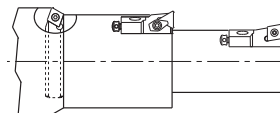
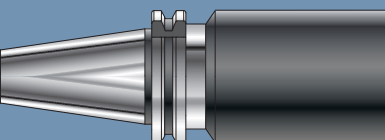

PORTAFRESA CON ATTACCO MODULARE FILETTATO

- CUTTER-HOLDER WITH MODULAR THREADED CONNECTION
- FRASERAUFNAHME MIT MODULAR-GEWINDEAUFNAHME
- MANDRIN PORTE-FRAISE AVEC ATTACHEMENT MODULAIRE FILETÉ

ISO.B40.MD..
... /AD - B

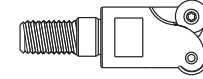
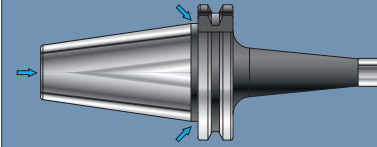

PAG 1001

PORTAFRESA ANTIVIBRANTE CON ATTACCO MODULARE FILETTATO

- VIBRATION-DAMPED CUTTER-HOLDER WITH MODULAR THREADED CONNECTION
- SCHWINGUNGSGEDÄMPFTE FRASERAUFNAHME MIT MODULAR-GEWINDEAUFNAHME
- MANDRIN PORTE-FRAISE ANTIVIBRATOIRE AVEC ATTACHEMENT MODULAIRE FILETÉ

ISO.A..MDV..
... /A

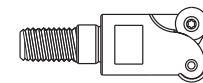
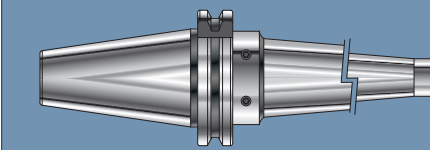

PAG 1002

MANDRINO A CALETTAMENTO TERMICO

- SHRINKING-ON TAPER SHANKS
- WERKZEUGAUFNAHMEN MIT SCHRUMPFVERBINDUNG
- MANDRIN À EMBOÎTEMENT THERMIQUE

ISO.B..CTS..
... /AD - B

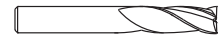
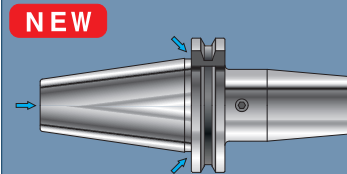

DIN 1835 A - DIN 6535 HA



PAG 1003

MANDRINO A CALETTAMENTO TERMICO PROLUNGABILE

- EXTENSIBLE SHRINK FIT
- VERLÄNGERBARES SCHRUMPFUTTER
- MANDRIN PROLONGEABLE À EMBOÎTEMENT THERMIQUE.

ISO.B..CTPN..
... /AD - B

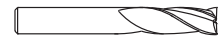
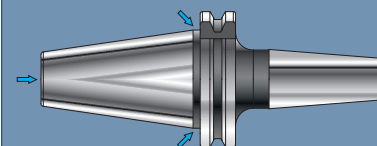

DIN 1835 A - DIN 6535 HA



PAG 1004

MANDRINO A FORTE SERRAGGIO

- HIGH CLAMPING CHUCKS
- KRAFTSPANNFUTTER
- MANDRIN À FORT SERRAGE

ISO.B..MFSN..
... /AD - B

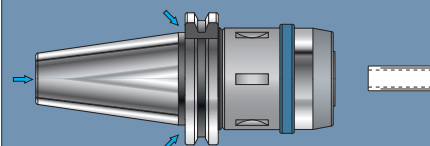

DIN 1835 A - DIN 6535 HA



PAG 1005

MANDRINO A BLOCCAGGIO IDRAULICO

- HYDRAULIC CLAMPING CHUCK
- AUFNAHME MIT HYDRODEHNSPANNUNG
- MANDRIN AVEC BLOCAGE HYDRAULIC

ISO.A..MI..
... /AD

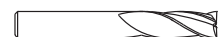
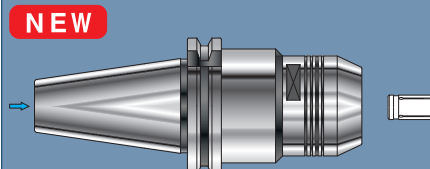

DIN 1835 A - DIN 6535 HA



PAG 1006

ART. ISO.B..ER..
DIN 69871/AD-B

DIN 6499

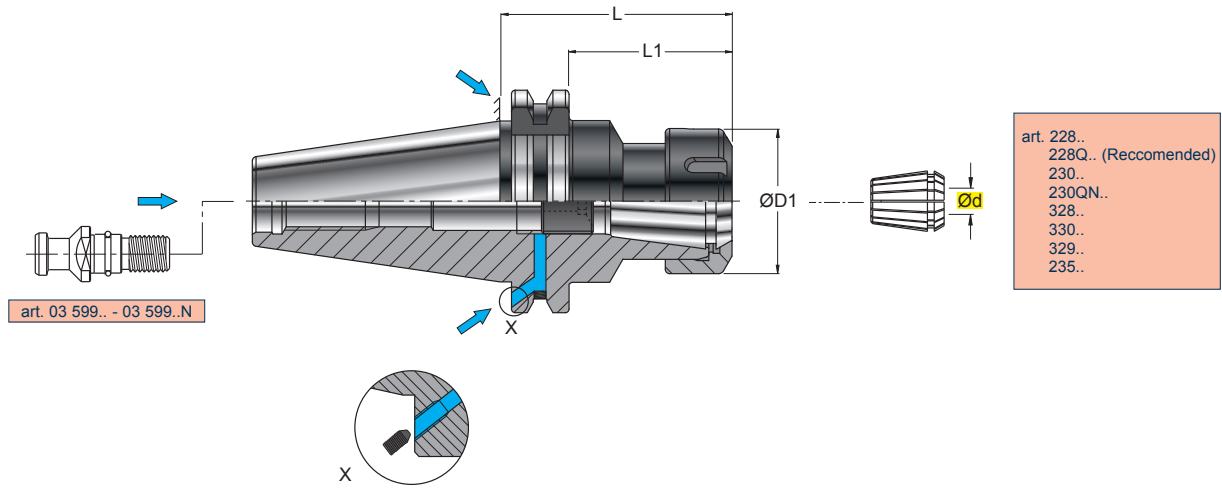







art. 03 599.. - 03 599..N

art. 228..
228Q.. (Reccomended)
230..
230QN..
328..
330..
329..
235..

PORTAPINZA STANDARD
COLLET HOLDER STANDARD
SPANNFUTTER STANDARD
MANDRIN PORTE-PINCE STANDARD

PRE-EQUILIBRATO
PRE-BALANCED
G 6,3 8000 min⁻¹

ART.		(mm)										
		Ød	ØD1	L	L1							
ISO.B40.ER016.065	ISO40	0,5-10	28	65	46	--.016.--	RGS ER16			925.022	RGC ER16	925.022
ISO.B40.ER016.120	ISO40	0,5-10	28	120	101	--.016.--						
ISO.B40.ER016.150	ISO40	0,5-10	28	150	131	--.016.--						
ISO.B40.ER025.065	ISO40	0,5-16	42	65	46	--.025.--	RGS ER25			925.040	RGC ER25	925.040
ISO.B40.ER025.120	ISO40	0,5-16	42	120	101	--.025.--						
ISO.B40.ER025.150	ISO40	0,5-16	42	150	131	--.025.--						
ISO.B40.ER025.200	ISO40	0,5-16	42	200	181	--.025.--						
ISO.B40.ER032.070	ISO40	2-20	50	70	51	--.032.--	RGS ER32			925.052	RGC ER32	925.052
ISO.B40.ER032.100	ISO40	2-20	50	100	81	--.032.--						
ISO.B40.ER032.120	ISO40	2-20	50	120	101	--.032.--						
ISO.B40.ER032.150	ISO40	2-20	50	150	131	--.032.--						
ISO.B40.ER032.200	ISO40	2-20	50	200	181	--.032.--						
ISO.B40.ER040.070	ISO40	3-30	63	70	51	--.040.--	RGS ER40			925.068	RGC ER40	925.068
ISO.B40.ER040.100	ISO40	3-30	63	100	81	--.040.--						
ISO.B50.ER016.200	ISO50	0,5-10	28	200	181	--.016.--	RGS ER16			925.022	RGC ER16	925.022
ISO.B50.ER025.075	ISO50	0,5-16	42	75	56	--.025.--	RGS ER25			925.040	RGC ER25	925.040
ISO.B50.ER025.120	ISO50	0,5-16	42	120	101	--.025.--						
ISO.B50.ER025.160 New	ISO50	0,5-16	42	160	131	--.025.--						
ISO.B50.ER032.075	ISO50	2-20	50	75	56	--.032.--	RGS ER32			925.052	RGC ER32	925.052
ISO.B50.ER032.100	ISO50	2-20	50	100	81	--.032.--						
ISO.B50.ER032.120	ISO50	2-20	50	120	101	--.032.--						
ISO.B50.ER032.150	ISO50	2-20	50	150	131	--.032.--						
ISO.B50.ER032.200	ISO50	2-20	50	200	181	--.032.--						
ISO.B50.ER040.075	ISO50	3-30	63	75	56	--.040.--	RGS ER40			925.068	RGC ER40	925.068
ISO.B50.ER040.100	ISO50	3-30	63	100	81	--.040.--						
ISO.B50.ER040.150	ISO50	3-30	63	150	131	--.040.--						

ART. ISO.A..WEC..
DIN 69871/AD

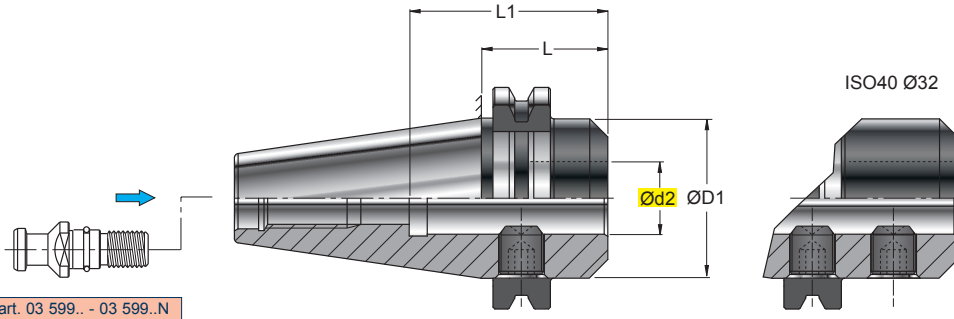

MANDRINO CORTO PER ATTACCHI TIPO WELDON
 END-MILL HOLDER FOR WELDON CONNECTION-SHORT TYPE
 AUFNAHME FÜR WELDON-TYPE, KURZE AUSFÜHRUNG
 MANDRIN POUR ATTACHEMENT WELDON, SERIE COURTE

Ød2 H5

0,005

PRE-EQUILIBRATO
 PRE-BALANCED
 G 6,3 8000 min⁻¹

ART.	(mm)	Dimensions (mm)				GR	GR	ISO	ISO
		Ød2	ØD1	L	L1				
ISO.A40.WEC016.035	ISO40	16	44	35	45	GR1415	-	5006	-
ISO.A40.WEC020.035	ISO40	20	44	35	45				
ISO.A40.WEC025.035	ISO40	25	44	35	55				
ISO.A40.WEC032.070	ISO40	32	65	70	60	GR1610	GR2015	5008	5010
ISO.A50.WEC016.035	ISO50	16	70	35	45	GR1415	-	5006	-
ISO.A50.WEC020.035	ISO50	20	70	35	45	GR1615	-	5008	-
ISO.A50.WEC025.035	ISO50	25	70	35	55	GR1815	-	5008	-
ISO.A50.WEC032.035	ISO50	32	70	35	60	GR2015	-	5010	-
ISO.A50.WEC040.052	ISO50	40	74	52	75	GR2016	-	5010	-

ART. ISO.B40.WE..
DIN 69871/AD-B

DIN 6359 B

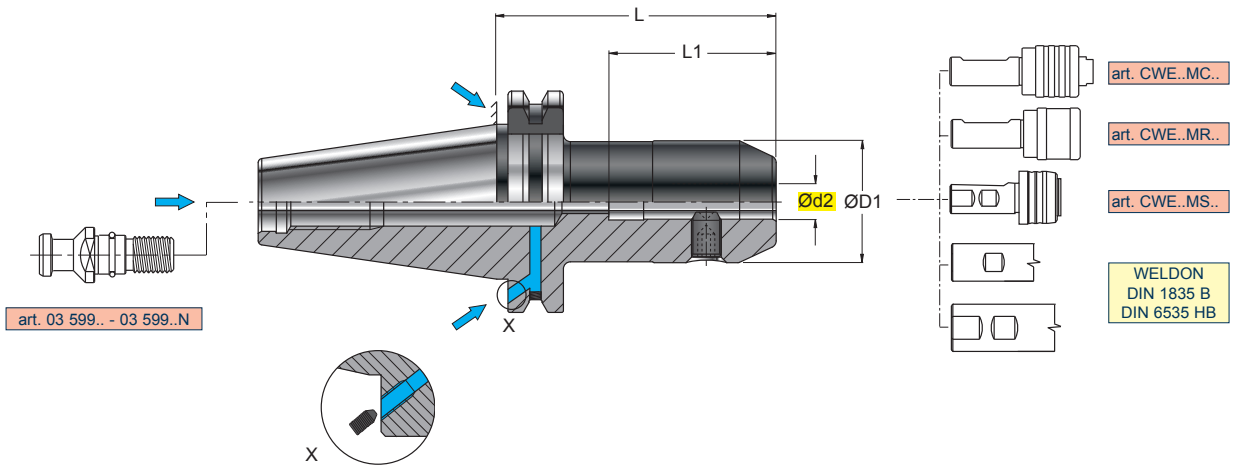

MANDRINO PER ATTACCHI TIPO WELDON
END MILL HOLDER FOR WELDON CONNECTION
WERKZEUGAUFNAHME FÜR WELDON-TYPE
MANDRIN POUR ATTACHEMENT WELDON

Ød2 H5

0,005

PRE-EQUILIBRATO
PRE-BALANCED
 G 6,3 8000 min⁻¹

ART.		(mm)								
		Ød2	ØD1	L	L1					
ISO.B40.WE006.050	ISO40	6	25	50	35	GR06	5003			
ISO.B40.WE006.100	ISO40	6	25	100	35					
ISO.B40.WE006.150	ISO40	6	25	150	35					
ISO.B40.WE008.050	ISO40	8	28	50	35	GR08	5004			
ISO.B40.WE008.100	ISO40	8	28	100	35					
ISO.B40.WE008.150	ISO40	8	28	150	35					
ISO.B40.WE010.050	ISO40	10	35	50	39	GR10	5005			
ISO.B40.WE010.100	ISO40	10	35	100	39					
ISO.B40.WE010.150	ISO40	10	35	150	39					
ISO.B40.WE012.050	ISO40	12	42	50	44	GR1215	5006			
ISO.B40.WE012.100	ISO40	12	42	100	44					
ISO.B40.WE012.150	ISO40	12	42	150	44					
ISO.B40.WE014.063	ISO40	14	44	63	44	GR1215	5006			
ISO.B40.WE014.100	ISO40	14	44	100	44					
ISO.B40.WE016.063	ISO40	16	48	63	47					
ISO.B40.WE016.100	ISO40	16	48	100	47					
ISO.B40.WE016.150	ISO40	16	48	150	47					
ISO.B40.WE018.063	ISO40	18	50	63	47					
ISO.B40.WE018.100	ISO40	18	50	100	47					
ISO.B40.WE020.063	ISO40	20	52	63	49					
ISO.B40.WE020.100	ISO40	20	52	100	49					
ISO.B40.WE020.150	ISO40	20	52	150	49					
ISO.B40.WE025.100 New	ISO40	25	65	100	54	GR1815	5008			
ISO.B40.WE025.150	ISO40	25	65	150	54					
ISO.B40.WE032.100 New	ISO40	32	72	100	58	GR2015	5010			
ISO.B40.WE040.115	ISO40	40	80	115	68					

ART. ISO.B50.WE..
DIN 69871/AD-B

DIN 6359 B

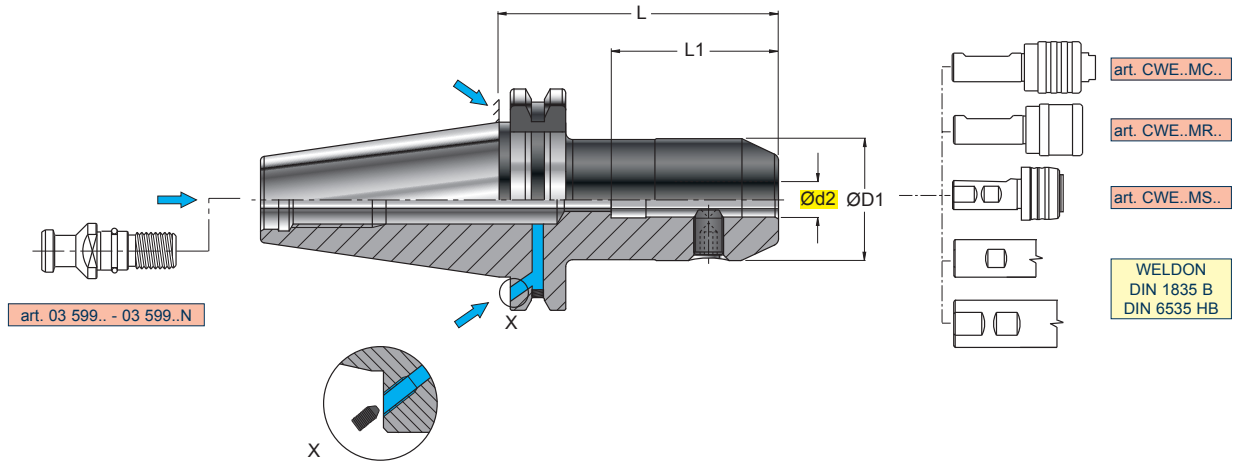

MANDRINO PER ATTACCHI TIPO WELDON
END MILL HOLDER FOR WELDON CONNECTION
WERKZEUGAUFNAHME FÜR WELDON-TYPE
MANDRIN POUR ATTACHEMENT WELDON

Ød2 H5

0,005

PRE-EQUILIBRATO
PRE-BALANCED
 G 6,3 8000 min⁻¹

ART.	(mm)									
		Ød2	ØD1	L	L1					
ISO.B50.WE006.150	ISO50	6	25	150	35	GR06				5003
ISO.B50.WE008.150	ISO50	8	28	150	35	GR08				5004
ISO.B50.WE010.100	ISO50	10	35	100	39	GR10				5005
ISO.B50.WE010.150	ISO50	10	35	150	39					
ISO.B50.WE012.100	ISO50	12	42	100	44	GR1215				5006
ISO.B50.WE014.100	ISO50	14	44	100	44	GR1215				5006
ISO.B50.WE016.063	ISO50	16	48	63	47	GR1415				5006
ISO.B50.WE016.100	ISO50	16	48	100	47					
ISO.B50.WE016.150	ISO50	16	48	150	47					
ISO.B50.WE018.063	ISO50	18	50	63	47	GR1615				5008
ISO.B50.WE018.100	ISO50	18	50	100	47					
ISO.B50.WE020.063	ISO50	20	52	63	49					
ISO.B50.WE020.100	ISO50	20	52	100	49	GR1815				5010
ISO.B50.WE020.150	ISO50	20	52	150	49					
ISO.B50.WE025.080	ISO50	25	65	80	54					
ISO.B50.WE025.100	ISO50	25	65	100	54	GR2015				5010
ISO.B50.WE025.150	ISO50	25	65	150	54					
ISO.B50.WE032.100	ISO50	32	72	100	58					
ISO.B50.WE032.150	ISO50	32	72	150	58	GR2420				5017
ISO.B50.WE040.100	ISO50	40	80	100	68					
ISO.B50.WE050.105	ISO50	50	90	105	78					

**ART. ISO.B..PUH..
DIN 69871/AD-B**

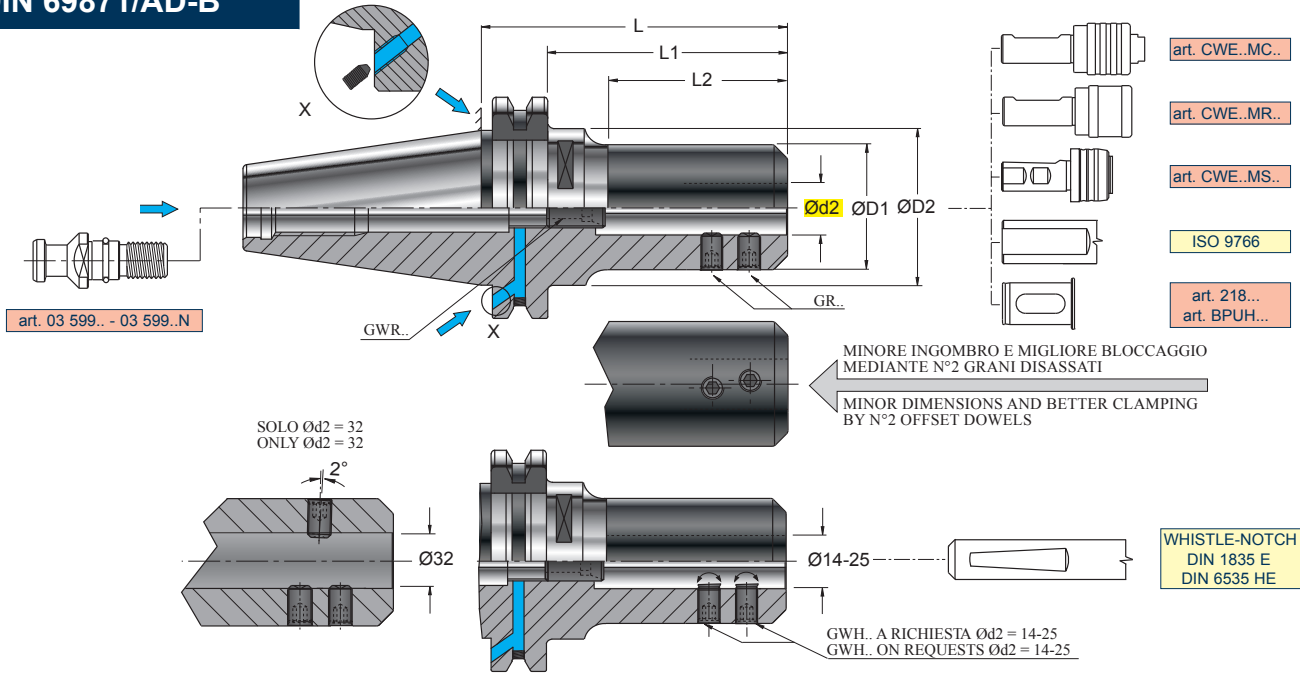

PORTAPUNTA UNIVERSALE
UNIVERSAL ADAPTER FOR DRILLING TOOLS
WELDON-AUFNAHME FÜR VOLLBOHRER
PORTE-FORET UNIVERSEL

Ød2 H5

0,003	L ≤ 140
0,005	L ≤ 200

PRE-EQUILIBRATO	PRE-BALANCED
SK40	= G6,3 8000 min ⁻¹
SK50	= G6,3 6000 min ⁻¹

ART.		(mm)											
		Ød2	ØD1	ØD2	L	L1	L2						
ISO.B40.PUH016.100	ISO40	16	38	44,7	100	81	-	n°2 GR10	GWR12	5005	5006	GWH10	5005
ISO.B40.PUH020.100	ISO40	20	42	44,7	100	81	-	n°2 GR10	GWR16	5005	5008	GWH10	5005
ISO.B40.PUH025.100	ISO40	25	48	50	100	81	-	n°2 GR10	GWR20	5005	5010	GWH10	5005
ISO.B40.PUH032.080	ISO40	32	58	50	80	61	-	n°3 GR14	-	5006	-	-	-
ISO.B40.PUH040.080 New	ISO40	40	68	50	80	66	-	n°2 GR14	-	5006	-	-	-
ISO.B50.PUH014.140	ISO50	14	36	70	140	121	80	n°2 GR10	GWR12	5005	5006	GWH10	5005
ISO.B50.PUH014.200	ISO50	14	36	70	200	181	130						
ISO.B50.PUH016.140	ISO50	16	38	70	140	121	80						
ISO.B50.PUH016.200	ISO50	16	38	70	200	181	130						
ISO.B50.PUH018.140	ISO50	18	40	70	140	121	80	n°2 GR10	GWR16	5005	5008	GWH10	5005
ISO.B50.PUH018.200	ISO50	18	40	70	200	181	130						
ISO.B50.PUH020.140	ISO50	20	42	70	140	121	80						
ISO.B50.PUH025.140	ISO50	25	48	70	140	121	90	n°2 GR10	GWR20	5005	5010	GWH10	5005
ISO.B50.PUH032.080	ISO50	32	58	70	80	61	40	n°3 GR14	-	5006	-	-	-
ISO.B50.PUH032.140	ISO50	32	58	70	140	121	95						
ISO.B50.PUH040.090	ISO50	40	68	80	90	71	-	n°2 GR16	-	5008	-	-	-
ISO.B50.PUH040.140	ISO50	40	68	80	140	121	-						
ISO.B50.PUH050.090	ISO50	50	76	80	90	71	-						

ART. ISO.B..FSW..
DIN 69871/AD-B

ISO 3937

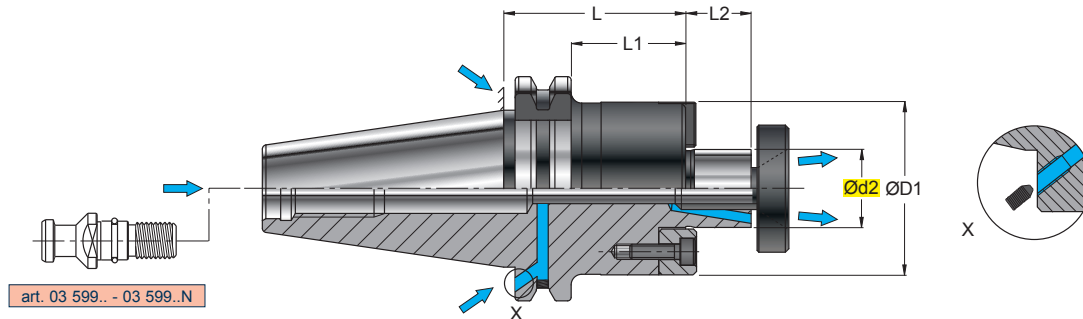

PORTAFRESA A TRASCINAMENTO FRONTALE CON TENONE
SHELL END-MILL HOLDERS WITH TENON
FRÄSERAUFNAHME MIT QUERNUT UND LAPPEN
PORTE-FRAISE A ENTRAINEMENT FRONTAL AVEC TENON

PRE-EQUILIBRATO	PRE-BALANCED
	SK40 = G6,3 8000 min ⁻¹
	SK50 = G6,3 6000 min ⁻¹

ART.		(mm)										
		Ød2	ØD1	L	L1	L2						
ISO.B40.FSW016.050	ISO40	16	40	50	31	17	RS 16	VBS08	TSFS16	VB02	5015	
ISO.B40.FSW016.100 New	ISO40	16	40	100	71	17						
ISO.B40.FSW022.035	ISO40	22	50	35	16	19	RS 22	VBS10	TSFS22	VB04	5003	
ISO.B40.FSW022.050	ISO40	22	49	50	31	19						
ISO.B40.FSW022.100	ISO40	22	49	100	71	19						
ISO.B40.FSW027.060	ISO40	27	60	60	41	21	RS 27	VBS12	TSFS27	VB05	5005	
ISO.B40.FSW027.090	ISO40	27	60	90	71	21						
ISO.B40.FSW032.060	ISO40	32	65	60	41	24	RS 32	VBS16	TSFS32	VB05	5004	
ISO.B40.FSW032.090	ISO40	32	65	90	71	24						
ISO.B40.FSW040.060	ISO40	40	75	60	41	27	RS 40	VBS20	TSFS40	VB06	5005	
ISO.B40.FSW040.090	ISO40	40	75	90	71	27						
ISO.B50.FSW016.063	ISO50	16	40	63	44	17	RS16	VBS08	TSFS16	VB02	5015	
ISO.B50.FSW016.100	ISO50	16	40	100	81	17						
ISO.B50.FSW022.063	ISO50	22	49	63	44	19	RS 22	VBS10	TSFS22	VB04	5003	
ISO.B50.FSW022.100	ISO50	22	50	100	81	19						
ISO.B50.FSW022.169	ISO50	22	49	169	150	19						
ISO.B50.FSW022.219	ISO50	22	49	219	200	19						
ISO.B50.FSW027.035	ISO50	27	60	35	16	21	RS 27	VBS12	TSFS27	VB05	5005	
ISO.B50.FSW027.063	ISO50	27	60	63	44	21						
ISO.B50.FSW027.100	ISO50	27	60	100	81	21						
ISO.B50.FSW027.169	ISO50	27	60	169	150	21						
ISO.B50.FSW027.219	ISO50	27	60	219	200	21						
ISO.B50.FSW032.035	ISO50	32	75	35	16	24	RS 32	VBS16	TSFS32	VB05	5004	
ISO.B50.FSW032.063	ISO50	32	75	63	44	24						
ISO.B50.FSW032.100	ISO50	32	75	100	81	24						
ISO.B50.FSW040.063	ISO50	40	85	63	44	27	RS 40	VBS20	TSFS40	VB06	5005	
ISO.B50.FSW040.100	ISO50	40	85	100	81	27						

ART. ISO.A.. FSV..
DIN 69871/A

ISO 3937





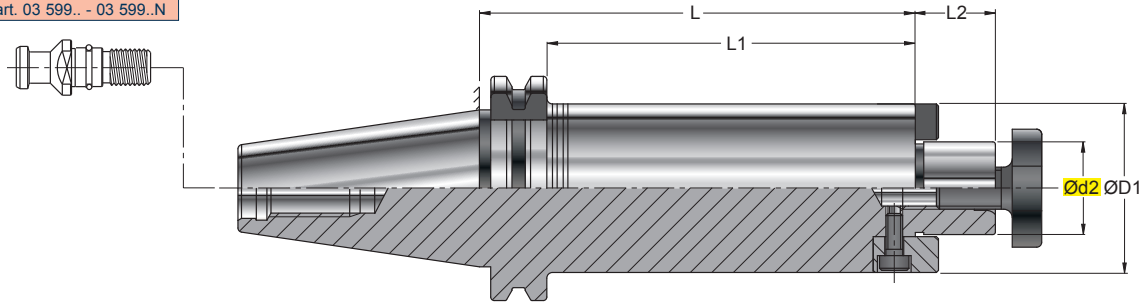



art. 03 599.. - 03 599..N



PORTAFRESA ANTIVIBRANTE A TRASCINAMENTO FRONTALE CON TENONE
VIBRATION-DAMPED SHELL END-MILL HOLDERS WITH TENON
SCHWINGUNGSGEDÄMPFTE FRÄSERAUFNAHME MIT QUERNUT UND LAPPEN
MANDRIN PORTE-FRAISE ANTIVIBRATOIRE A ENTRAÎNEMENT FRONTAL AVEC TENON

0,015

PRE-EQUILIBRATO
PRE-BALANCED
G 6,3 8000 min⁻¹

ART.		(mm)										
		Ød2	ØD1	L	L1	L2						
ISO.A40.FSV016.150	ISO40	16	38	150	131	17	2,00	CHF16V	VB 02	422.016..	5025	423.016..
ISO.A40.FSV016.200	ISO40	16	38	200	181	17	2,50					
ISO.A40.FSV016.250	ISO40	16	38	250	231	17	2,90					
ISO.A40.FSV016.300	ISO40	16	38	300	281	17	3,40					
ISO.A40.FSV022.150	ISO40	22	48	150	131	19	2,40	CHF22V	VB 04	422.022..	5003	423.022..
ISO.A40.FSV022.200	ISO40	22	48	200	181	19	3,10					
ISO.A40.FSV022.250	ISO40	22	48	250	231	19	4,20					
ISO.A40.FSV022.300	ISO40	22	48	300	281	19	4,90					
ISO.A40.FSV027.150	ISO40	27	54	150	131	21	2,90	CHF27V	905.005.080.012	422.027..	5004	423.027..
ISO.A40.FSV027.200	ISO40	27	54	200	181	21	3,60					
ISO.A40.FSV027.250	ISO40	27	54	250	231	21	4,40					
ISO.A40.FSV027.300	ISO40	27	54	300	281	21	5,40					
ISO.A50.FSV016.150	ISO50	16	38	150	131	17	4,20	CHF16V	VB 02	422.016..	5025	423.016..
ISO.A50.FSV016.200	ISO50	16	38	200	181	17	4,40					
ISO.A50.FSV016.250	ISO50	16	38	250	231	17	5,30					
ISO.A50.FSV016.300	ISO50	16	38	300	281	17	5,90					
ISO.A50.FSV016.400	ISO50	16	38	400	381	17	5,90					
ISO.A50.FSV022.200	ISO50	22	48	200	181	19	5,20	CHF22V	VB 04	422.022..	5003	423.022..
ISO.A50.FSV022.250	ISO50	22	48	250	231	19	5,30					
ISO.A50.FSV022.300	ISO50	22	48	300	281	19	5,90					
ISO.A50.FSV022.400	ISO50	22	48	400	381	19	7,30					
ISO.A50.FSV022.500	ISO50	22	48	500	481	19	8,50					
ISO.A50.FSV022.200B	ISO50	22	60	200	181	19	7,30					
ISO.A50.FSV022.250B	ISO50	22	60	250	231	19	7,80					
ISO.A50.FSV022.300B	ISO50	22	60	300	281	19	8,10					
ISO.A50.FSV022.400B	ISO50	22	60	400	381	19	9,20					
ISO.A50.FSV022.500B	ISO50	22	60	500	481	19	12,30					
ISO.A50.FSV027.200	ISO50	27	60	200	181	21	6,80	CHF27V	905.005.080.012	422.027..	5004	423.027..
ISO.A50.FSV027.250	ISO50	27	60	250	231	21	7,10					
ISO.A50.FSV027.300	ISO50	27	60	300	281	21	6,80					
ISO.A50.FSV027.400	ISO50	27	60	400	381	21	6,80					
ISO.A50.FSV027.500	ISO50	27	60	500	481	21	8,10					
ISO.A50.FSV032.200	ISO50	32	76	200	181	24	7,60	CHF32V	905.005.080.012	422.032..	5004	423.032..
ISO.A50.FSV032.250	ISO50	32	76	250	231	24	9,60					
ISO.A50.FSV032.300	ISO50	32	76	300	281	24	10,60					
ISO.A50.FSV032.400	ISO50	32	76	400	381	24	13,10					
ISO.A50.FSV032.500	ISO50	32	76	500	481	24	16,10					

ART. ISO.A.. FSCV..
DIN 69871/A

ISO 3937





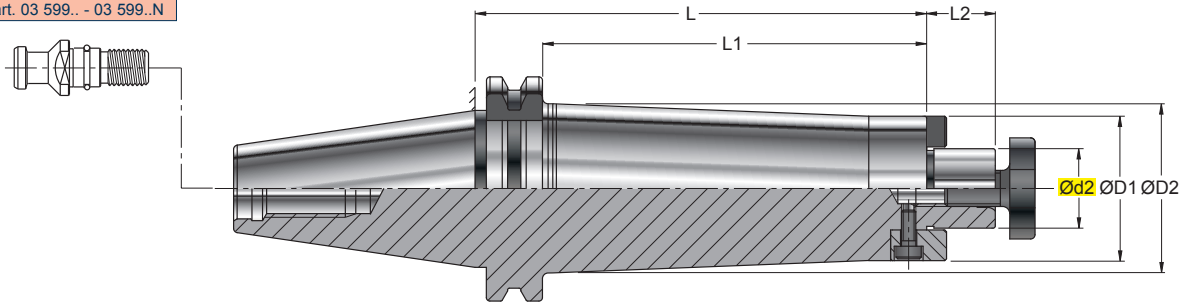



art. 03 599.. - 03 599..N



PORTAFRESA ANTIVIBRANTE A TRASCINAMENTO FRONTALE CON TENONE
VIBRATION-DAMPED SHELL END-MILL HOLDERS WITH TENON
SCHWINGUNGSGEDÄMPFTE FRÄSERAUFNAHME MIT QUERNUT UND LAPPEN
MANDRIN PORTE-FRAISE ANTIVIBRATOIRE A ENTRAÎNEMENT FRONTAL AVEC TENON

0,015

PRE-EQUILIBRATO
PRE-BALANCED
G 6,3 8000 min⁻¹

ART.	 (mm)	Dimensions (mm)						 kg					
		Ød2	ØD1	ØD2	L	L1	L2						
ISO.A40.FSCV016.150	ISO40	16	38	50	150	131	17	2,20	CHF16V	VB 02	422.016..	5025	423.016..
ISO.A40.FSCV016.200	ISO40	16	38	50	200	181	17	2,70					
ISO.A40.FSCV016.250	ISO40	16	38	50	250	231	17	3,30					
ISO.A40.FSCV016.300	ISO40	16	38	50	300	281	17	3,70					
ISO.A40.FSCV022.150	ISO40	22	48	50	150	131	19	2,60	CHF22V	VB 04	422.022..	5003	423.022..
ISO.A40.FSCV022.200	ISO40	22	48	50	200	181	19	3,30					
ISO.A40.FSCV022.250	ISO40	22	48	50	250	231	19	4,00					
ISO.A40.FSCV022.300	ISO40	22	48	50	300	281	19	4,80					
ISO.A50.FSCV016.150	ISO50	16	38	80	150	131	17	4,60	CHF16V	VB 02	422.016..	5025	423.016..
ISO.A50.FSCV016.200	ISO50	16	38	80	200	181	17	5,90					
ISO.A50.FSCV016.250	ISO50	16	38	80	250	231	17	5,90					
ISO.A50.FSCV016.300	ISO50	16	38	80	300	281	17	6,80					
ISO.A50.FSCV016.400	ISO50	16	38	80	400	381	17	10,50					
ISO.A50.FSCV022.200	ISO50	22	48	80	200	181	19	5,80	CHF22V	VB 04	422.022..	5003	423.022..
ISO.A50.FSCV022.250	ISO50	22	48	80	250	231	19	6,60					
ISO.A50.FSCV022.300	ISO50	22	48	80	300	281	19	7,40					
ISO.A50.FSCV022.400	ISO50	22	48	80	400	381	19	10,40					
ISO.A50.FSCV022.500	ISO50	22	48	80	500	481	19	11,50					
ISO.A50.FSCV027.200	ISO50	27	58	80	200	181	21	6,60	CHF27V	905.005.080.012	422.027..	5004	423.027..
ISO.A50.FSCV027.250	ISO50	27	58	80	250	231	21	7,50					
ISO.A50.FSCV027.300	ISO50	27	58	80	300	281	21	8,60					
ISO.A50.FSCV027.400	ISO50	27	58	80	400	381	21	10,70					
ISO.A50.FSCV027.500	ISO50	27	58	80	500	481	21	13,50					





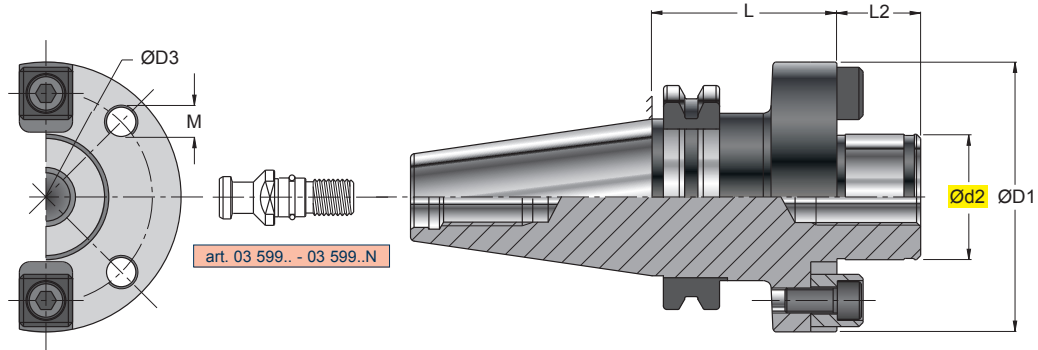

ART. ISO.A..FF..
DIN 69871/A

DIN 6357 B



PORTAFRESA A TRASCINAMENTO FRONTALE CON TENONE
SHELL END-MILL HOLDERS WITH TENON
FRÄSERAUFNHME MIT QUERNUT UND LAPPEN
PORTE-FRAISE A ENTRAINEMENT FRONTAL AVEC TENON

0,01

ART.		(mm)										
		Ød2	M	ØD1	ØD3	L	L2					
ISO.A50.FF040.070	ISO50	40	M12	89	66,7	70	25	TSFF40	VB06	5005	RS 40	VBS20
ISO.A50.FF060.070	ISO50	60	M16	129	101,6	70	40	TSFF60	VB12C	5010	RS 60	VBS24

ART. ISO.A..FC..
DIN 69871/A



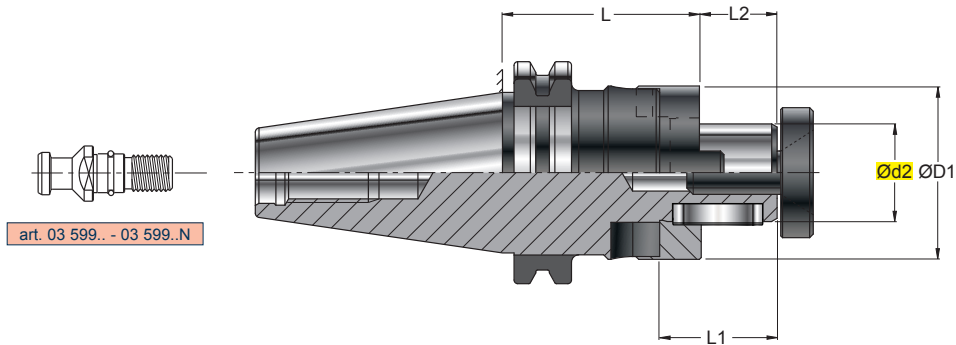

DIN 6358 B







PORTAFRESA A TRASCINAMENTO COMBINATO PER FRESE A MANICOTTO E A DISCO
COMBI FACE MILL HOLDERS FOR SHELL-END AND DISC MILLING CUTTERS
FRÄSERAUFNAHME KOMBINIERT FÜR AUFSTECK-UND SCHEIBENFRÄSER
MANDRIN PORTE-FRAISE À ENTRAÎNEMENT COMBINÉ POUR FRAISES À MANCHON ET DE DISQUE

0,01

PRE-EQUILIBRATO
PRE-BALANCED
G 6,3 8000 min⁻¹

ART.	 (mm)										
		Ød2	ØD1	L	L1	L2					
ISO.A40.FC016.055	ISO40	16	32	55	27	17	RS 16	VBS08	CT0420	08.3501.016.AT	
ISO.A40.FC016.090	ISO40	16	32	90	27	17					
ISO.A40.FC022.055	ISO40	22	40	55	31	19	RS 22	VBS10	CT0625	08.3502.022.AT	
ISO.A40.FC022.090	ISO40	22	40	90	31	19					
ISO.A40.FC027.055	ISO40	27	48	55	33	21	RS 27	VBS12	CT0725	08.3503.027.AT	
ISO.A40.FC027.090	ISO40	27	48	90	33	21					
ISO.A40.FC032.063	ISO40	32	58	63	38	24	RS 32	VBS16	CT0828	08.3504.032.AT	
ISO.A40.FC032.090	ISO40	32	58	90	38	24					
ISO.A40.FC040.063	ISO40	40	70	63	41	27	RS 40	VBS20	CT1032	08.3505.040.AT	
ISO.A40.FC040.090	ISO40	40	70	90	41	27					
ISO.A50.FC016.063	ISO50	16	32	63	27	17	RS 16	VBS08	CT0420	08.3501.016.AT	
ISO.A50.FC022.063	ISO50	22	40	63	31	19	RS 22	VBS10	CT0625	08.3502.022.AT	
ISO.A50.FC022.090	ISO50	22	40	90	31	19					
ISO.A50.FC027.063	ISO50	27	48	63	33	21	RS 27	VBS12	CT0725	08.3503.027.AT	
ISO.A50.FC027.090	ISO50	27	48	90	33	21					
ISO.A50.FC032.063	ISO50	32	58	63	38	24	RS 32	VBS16	CT0828	08.3504.032.AT	
ISO.A50.FC032.090	ISO50	32	58	90	38	24					
ISO.A50.FC040.100	ISO50	40	70	100	41	27	RS 40	VBS20	CT1032	08.3505.040.AT	

 PER IL MONTAGGIO DELLE FRESE A DISCO OCCORRE L'ANELLO DISTANZIATORE **195..** , PAG 1095
 FOR THE INSTALLATION OF THE DISC MILLING CUTTERS THE DISTANCE RING **195..** (PAGE 1095) IS REQUIRED.
 ZUM EINBAU DER SCHEIBENFRÄSER WIRD DER DISTANZRING **195..** (SEITE 1095) BENÖTIGT.
 EN CAS DE MONTAGE DES FRAISES-DISQUES LA BAGUE D'ENTRETOISE **195..** , PAGE 1095 S'IMPOSE

ART. ISO.A..MC..
DIN 69871/A

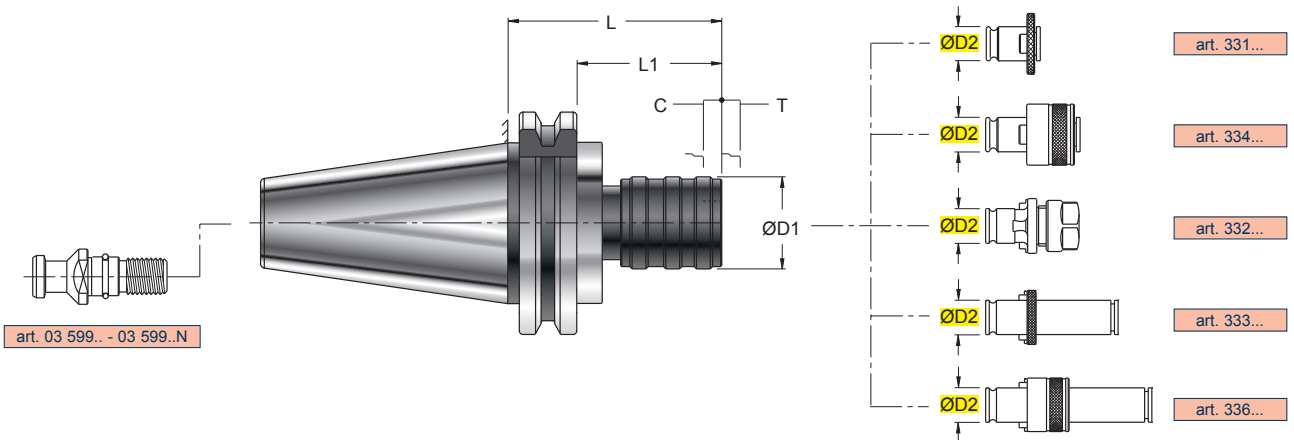

PORTA MASCHIO A CAMBIO RAPIDO CON DOPPIA COMPENSAZIONE
 QUICK-CHANGE TAP HOLDER WITH DOUBLE COMPENSATION
 GEWINDESCHNEID-SCHNELLWECHSELFUTTER MIT DOPPELAUSGLEICH
 MANDRINS DE TARAUDAGE À CHANGEMENT RAPIDE À DOUBLE COMPENSATION

ART.		(mm)						Campo di maschiatura Tap range				
		ØD1	ØD2	L	L1	C	T					
ISO.A40.MC019.060	ISO40	38	19	60	41	7,5	7,5	M3-M12				
ISO.A40.MC031.100	ISO40	55	31	100	81	12,5	12,5	M8-M24				
ISO.A50.MC019.062	ISO50	38	19	62	43	7,5	7,5	M3-M12				
ISO.A50.MC031.083	ISO50	55	31	83	64	12,5	12,5	M8-M24				
ISO.A50.MC048.133	ISO50	79	48	133	114	20,5	20,5	M16-M36				

ART. ISO.A..MS..
DIN 69871/AD

ART. ISO.B..MS..
DIN 69871/AD-B

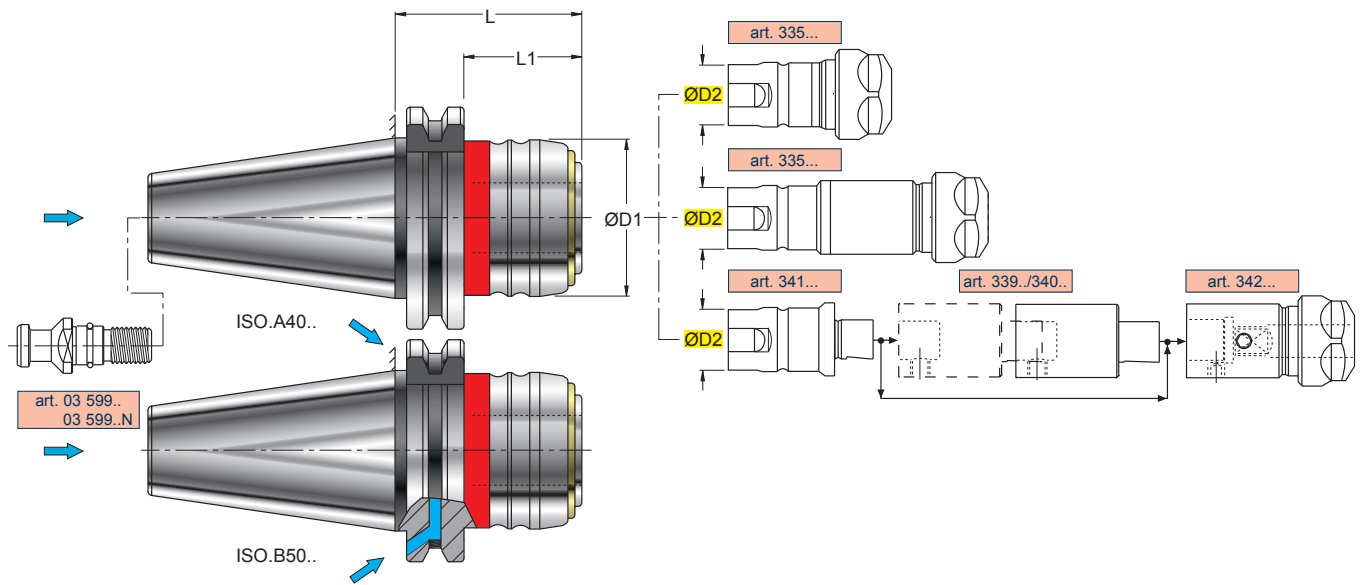

PORTA MASCHIO A CAMBIO RAPIDO PER MASCHIATURA SINCRONIZZATA
 QUICK CHANGE TAP HOLDER FOR SYNCHRONIZED TAPPING
 GEWINDESCHNEID-SCHNELLWECHSELFUTTER ZUM STARREN GEWINDESCHNEIDEN
 APPAREIL PORTE-TARAUDS À CHANGEMENT RAPIDE POUR TARAUDAGE SYNCHRONISÉ

ART.	 (mm)					Campo di maschiatura Tap range				
		ØD1	ØD2	L	L1					
ISO.A40.MS020.053	ISO40	43	20	53	34	M3-M12				
ISO.A40.MS032.090	ISO40	60	32	90	71	M6-M20				
ISO.B50.MS020.053	ISO50	43	20	53	34	M3-M12				
ISO.B50.MS032.074	ISO50	60	32	74	55	M6-M20				

ART. ISO.A..SF..
DIN 69871/A

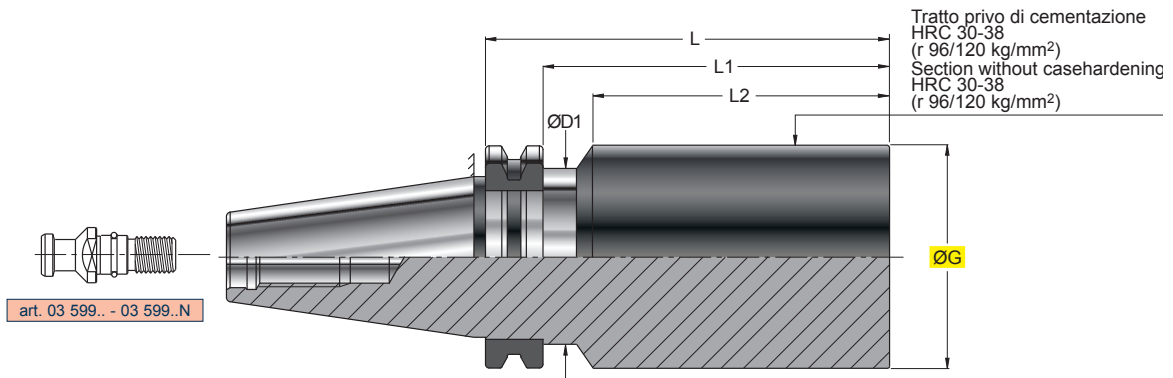

BARRA CON CONO FINITO E STELO TENERO
BORING BARS WITH FINISHED TAPER AND BLANK SCHAFT
ROHLINGE
BARRE AVEC CONE FINI ET BOUT DOUX

ART.		(mm)								
		ØG	ØD1	L	L1	L2				
ISO.A50.SF063.315 New	ISO50	63	—	315	250	—				
ISO.A50.SF063.419	ISO50	63	—	419	400	—				
ISO.A50.SF097.419	ISO50	97	79.5	419	400	384				

ART. ISO.B40.MD..
DIN 69871/AD-B

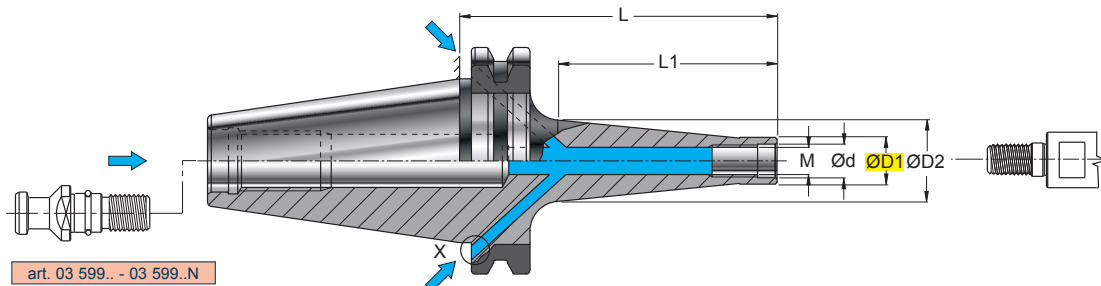

- art. 253..VW
S1089W..
S1503.9W..
S2000.89W..
S613/4.9.45W..
S659W..
S809W..
S849W..
S929..
S959..
S9002.9W..
S9004.9W..
S9005.9W..
S9006.9W..

art. 03 599.. - 03 599..N

PORTAFRESA CON ATTACCO MODULARE- FILETTATO
CUTTER-HOLDER WITH MODULAR THREADED CONNECTION
FRÄSERAUFNAHME MIT MODULAR-GEWINDEAUFNAHME
MANDRIN PORTE-FRAISE AVEC ATTACHEMENT MODULAIRE FILETÉ

0,005

EQUILIBRATO BALANCED
G6,3 15000 min⁻¹

ART.	(mm)	M	Ød	ØD1	ØD2	L	L1
ISO.B40.MD010.058	ISO40	10	10,5	17,7	20	58	30
ISO.B40.MD010.078	ISO40	10	10,5	17,7	25	78	50
ISO.B40.MD012.058	ISO40	12	12,5	20,7	24	58	30
ISO.B40.MD012.078	ISO40	12	12,5	20,7	24	78	50
ISO.B40.MD012.098	ISO40	12	12,5	20,7	31	98	70
ISO.B40.MD012.118	ISO40	12	12,5	20,7	31	118	90
ISO.B40.MD016.058	ISO40	16	17	28,7	29	58	30
ISO.B40.MD016.078	ISO40	16	17	28,7	34	78	50
ISO.B40.MD016.098	ISO40	16	17	28,7	34	98	70
ISO.B40.MD016.118	ISO40	16	17	28,7	34	118	90

PER UNA PERFETTA TENUTA SULL'ASSE DEL MANDRINO SI CONSIGLIA DI AVERE UN TIRANTE CON ANELLO DI TENUTA.
 WE RECOMMEND THE APPLICATION OF A RETENTION KNOB WITH AN O-RING FOR A PERFECT STABILITY ON THE TAPER SHANK AXIS
 FÜR EINE GUTE ABDICHTUNG AUF DER ACHSE DER AUFNAHME EMPFEHLEN WIR EINEN ANZUGSBOLZEN MIT DICHTUNGSRING
 POUR UNE PARFAITE TENUE SUR L'AX DU MANDRIN IL EST CONSEILLÉ D'AVOIR UN TIRANT AVEC UNE BAGUE DE TENUE

ART. ISO.A..MDV..
DIN 69871/A

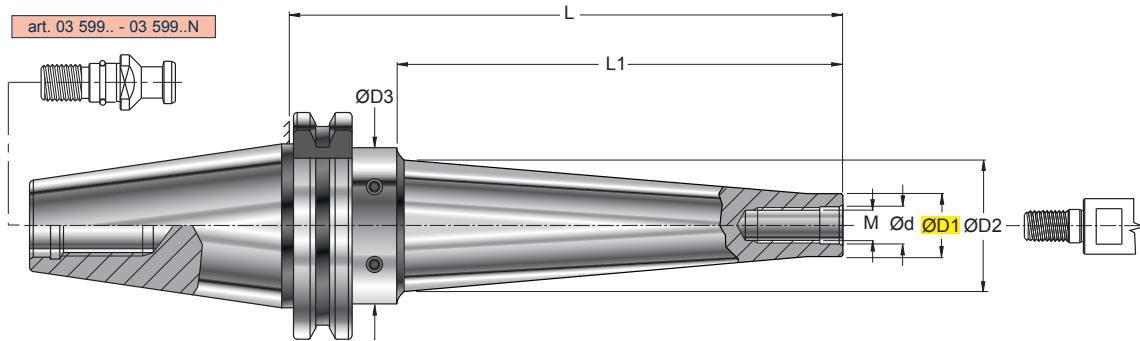

- art. 253..VW
S1089W..
S1503.9W..
S2000.89W..
S613/4.9.45W..
S659W..
S809W..
S849W..
S929..
S959..
S9002.9W..
S9004.9W..
S9005.9W..
S9006.9W..

PORTAFRESA ANTIVIBRANTE CON ATTACCO MODULARE-FILETTATO
VIBRATION-DAMPED CUTTER-HOLDER WITH MODULAR THREADED CONNECTION
SCHWINGUNGSGEDÄMPFTE FRASERAUFNAHME MIT MODULAR-GEWINDEAUFNAHME
MANDRIN PORTE-FRAISE ANTIVIBRATOIRE AVEC ATTACHEMENT MODULAIRE FILETÉ

0,015

PRE-EQUILIBRATO	PRE-BALANCED
	SK40 = G6,3 15000 min ⁻¹
	SK50 = G6,3 10000 min ⁻¹

ART.		(mm)									kg						
		M	Ød	ØD1	ØD2	ØD3	L	L1									
ISO.A40.MDV010.200	ISO40	10	10,5	18	35	50	200	165	1,70								
ISO.A40.MDV010.250	ISO40	10	10,5	18	41	50	250	215	2,20								
ISO.A40.MDV010.300	ISO40	10	10,5	18	46	50	300	265	2,80								
ISO.A40.MDV012.200	ISO40	12	12,5	21	38	50	200	165	2,10								
ISO.A40.MDV012.250	ISO40	12	12,5	21	44	50	250	215	2,40								
ISO.A40.MDV012.300	ISO40	12	12,5	21	49	50	300	265	3,10								
ISO.A40.MDV016.200	ISO40	16	17,0	29	46	50	200	165	2,30								
ISO.A40.MDV016.250	ISO40	16	17,0	29	48	50	250	215	2,70								
ISO.A40.MDV016.300	ISO40	16	17,0	29	50	50	300	265	3,40								
ISO.A50.MDV012.250	ISO50	12	12,5	21	44	80	250	215	4,80								
ISO.A50.MDV012.300	ISO50	12	12,5	21	49	80	300	265	5,10								
ISO.A50.MDV012.400	ISO50	12	12,5	21	60	80	400	365	7,00								
ISO.A50.MDV016.250	ISO50	16	17,0	29	52	80	250	215	5,50								
ISO.A50.MDV016.300	ISO50	16	17,0	29	57	80	300	265	6,10								
ISO.A50.MDV016.400	ISO50	16	17,0	29	68	80	400	365	7,60								
ISO.A50.MDV016.500	ISO50	16	17,0	29	78	80	500	465	11,70								

ART. ISO.B..CTS..
DIN 69871/AD-B

DIN 69882-8

NEW

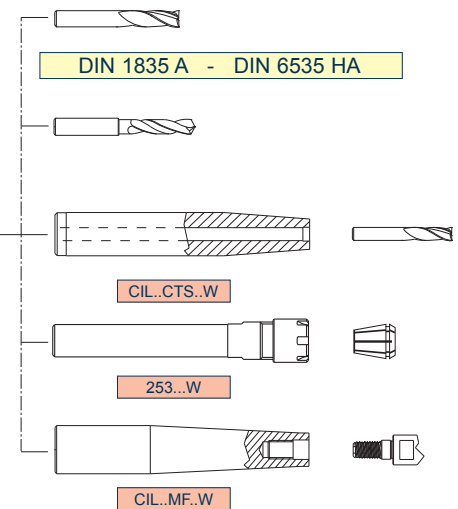
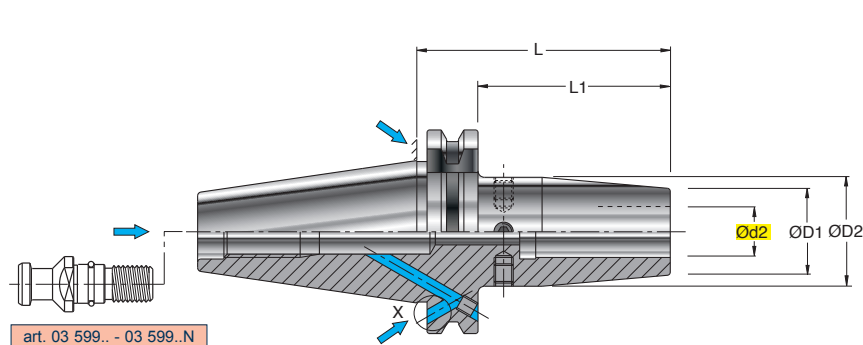

MANDRINO A CALETTAMENTO TERMICO
SHRINKING-ON TAPER SHANKS
WERKZEUGAUFNAHMEN MIT SCHRUMPFVERBINDUNG
MANDRIN À EMBOÏTEMENT TERMIQUE

0,003

EQUILIBRATO
BALANCED
G 2,5 25000 min⁻¹

ART.	(mm)	Ød2	ØD1	ØD2	L	L1
ISO.B40.CTS006.080	ISO40	6	21	27	80	60,9
ISO.B40.CTS006.130	ISO40	6	21	27	130	110,9
ISO.B40.CTS006.160	ISO40	6	21	27	160	140,9
ISO.B40.CTS008.080	ISO40	8	21	27	80	60,9
ISO.B40.CTS008.130	ISO40	8	21	27	130	110,9
ISO.B40.CTS008.160	ISO40	8	21	27	160	140,9
ISO.B40.CTS010.080	ISO40	10	24	32	80	60,9
ISO.B40.CTS010.130	ISO40	10	24	32	130	110,9
ISO.B40.CTS010.160	ISO40	10	24	32	160	140,9
ISO.B40.CTS012.080	ISO40	12	24	32	80	60,9
ISO.B40.CTS012.130	ISO40	12	24	32	130	110,9
ISO.B40.CTS012.160	ISO40	12	24	32	160	140,9
ISO.B40.CTS014.080	ISO40	14	27	34	80	60,9
ISO.B40.CTS014.130	ISO40	14	27	34	130	110,9
ISO.B40.CTS014.160	ISO40	14	27	34	160	140,9
ISO.B40.CTS016.080	ISO40	16	27	34	80	60,9
ISO.B40.CTS016.130	ISO40	16	27	34	130	110,9
ISO.B40.CTS016.160	ISO40	16	27	34	160	140,9
ISO.B40.CTS018.080	ISO40	18	33	42	80	60,9
ISO.B40.CTS018.130	ISO40	18	33	42	130	110,9
ISO.B40.CTS018.160	ISO40	18	33	42	160	140,9
ISO.B40.CTS020.080	ISO40	20	33	42	80	60,9
ISO.B40.CTS020.130	ISO40	20	33	42	130	110,9
ISO.B40.CTS020.160	ISO40	20	33	42	160	140,9
ISO.B40.CTS025.100	ISO40	25	44	53	100	80,9
ISO.B50.CTS006.080	ISO50	6	21	27	80	60,9
ISO.B50.CTS006.120	ISO50	6	21	27	120	100,9
ISO.B50.CTS006.160	ISO50	6	21	27	160	140,9
ISO.B50.CTS008.080	ISO50	8	21	27	80	60,9
ISO.B50.CTS008.120	ISO50	8	21	27	120	100,9
ISO.B50.CTS008.160	ISO50	8	21	27	160	140,9
ISO.B50.CTS010.080	ISO50	10	24	32	80	60,9
ISO.B50.CTS010.120	ISO50	10	24	32	120	100,9
ISO.B50.CTS010.160	ISO50	10	24	32	160	140,9
ISO.B50.CTS012.080	ISO50	12	24	32	80	60,9
ISO.B50.CTS012.120	ISO50	12	24	32	120	100,9
ISO.B50.CTS012.160	ISO50	12	24	32	160	140,9
ISO.B50.CTS014.080	ISO50	14	27	34	80	60,9
ISO.B50.CTS014.120	ISO50	14	27	34	120	100,9
ISO.B50.CTS014.160	ISO50	14	27	34	160	140,9
ISO.B50.CTS016.080	ISO50	16	27	34	80	60,9
ISO.B50.CTS016.120	ISO50	16	27	34	120	100,9
ISO.B50.CTS016.160	ISO50	16	27	34	160	140,9
ISO.B50.CTS018.080	ISO50	18	33	42	80	60,9
ISO.B50.CTS018.120	ISO50	18	33	42	120	100,9
ISO.B50.CTS018.160	ISO50	18	33	42	160	140,9
ISO.B50.CTS020.080	ISO50	20	33	42	80	60,9
ISO.B50.CTS020.120	ISO50	20	33	42	120	100,9
ISO.B50.CTS020.160	ISO50	20	33	42	160	140,9
ISO.B50.CTS025.120	ISO50	25	44	53	120	100,9
ISO.B50.CTS025.160	ISO50	25	44	53	160	140,9
ISO.B50.CTS032.120	ISO50	32	44	53	120	100,9
ISO.B50.CTS032.160	ISO50	32	44	53	160	140,9

ART. ISO.B..CTPN..
DIN 69871/AD-B

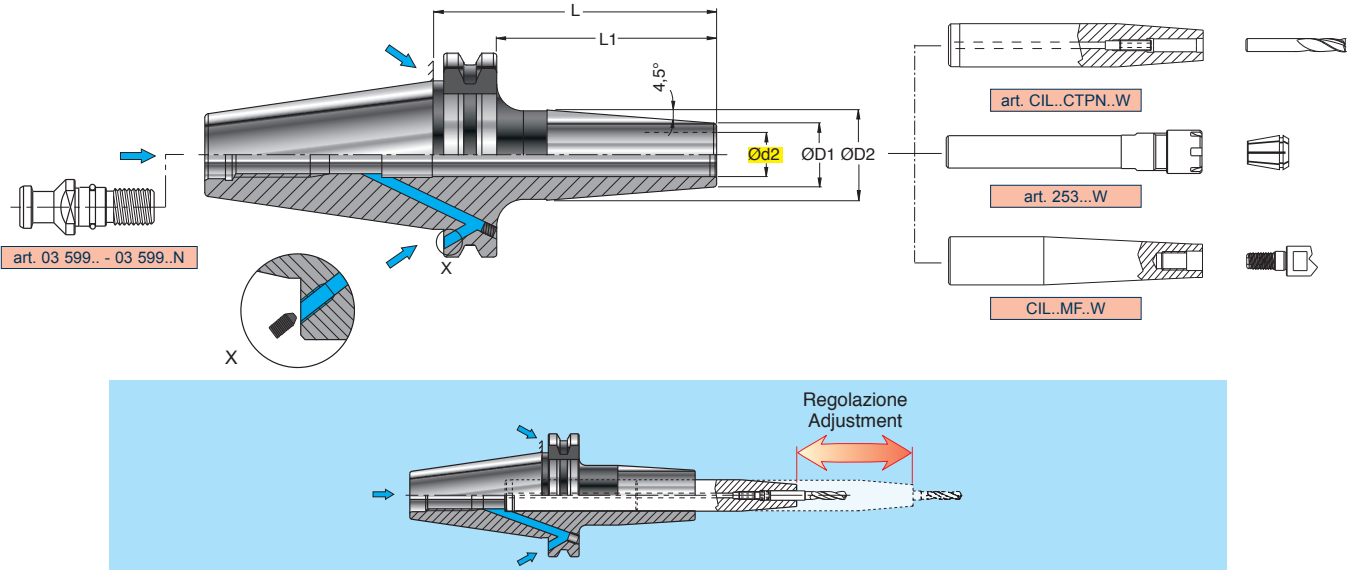

MANDRINO A CALETTAMENTO TERMICO PROLUNGABILE
EXTENSIBLE SHRINK FIT
VERLÄNGERBARES SCHRUMPFUTTER
MANDRIN PROLONGEABLE À EMBOÎTEMENT THERMIQUE.

ART.		(mm)									
		Ød2	ØD1	ØD2	L	L1					
ISO.B40.CTPN016.080	ISO40	16	27	34	80	61					
ISO.B40.CTPN025.090	ISO40	25	44	50	90	71					
ISO.B50.CTPN016.130	ISO50	16	27	34	130	111					
ISO.B50.CTPN025.130	ISO50	25	44	53	130	111					
ISO.B50.CTPN032.130	ISO50	32	44	53	130	111					

**ART. ISO.B..MFSN..
DIN 69871/AD-B**

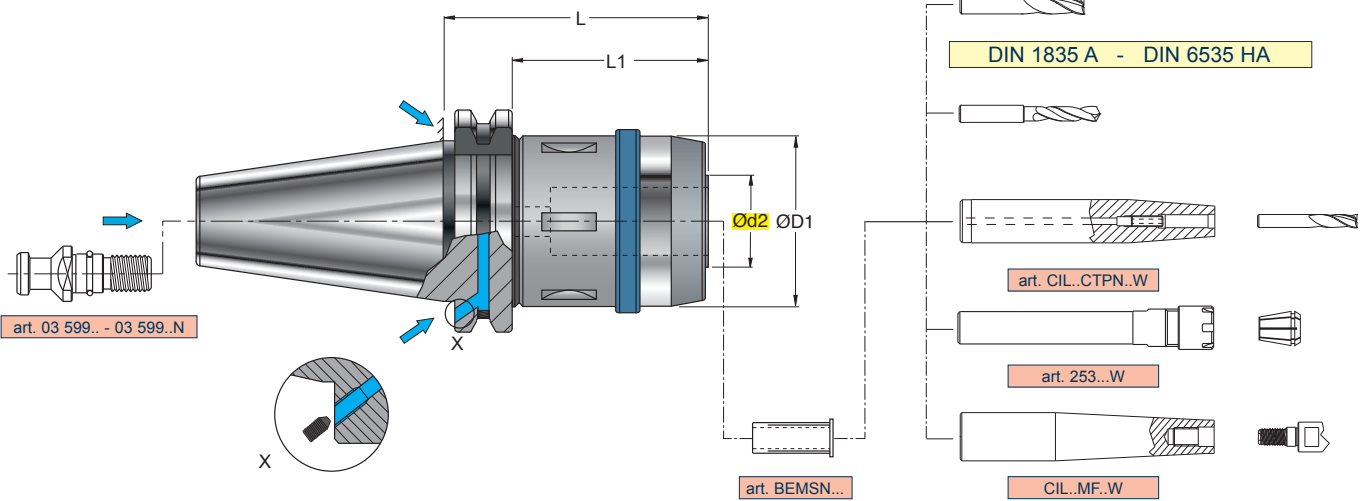

MANDRINO A FORTE SERRAGGIO
HIGH CLAMPING CHUCKS
KRAFTSPANNFUTTER
MANDRIN À FORT SERRAGE

	0,003	2,5 x Ø	EQUILIBRATO BALANCED G 2,5 20000 min-1
	0,004	2,5 x Ø	

ART.		(mm)	Ød2	ØD1	L	L1		
ISO.B40.MFSN020.075	ISO40	20	50	75	55,9	BEMSN.20	925.052	ESMS.010
ISO.B40.MFSN032.100	ISO40	32	67	100	80,9	BEMSN.32	925.068	ESMS.010
ISO.B50.MFSN020.080	ISO50	20	50	80	60,9	BEMSN.20	925.052	ESMS.010
ISO.B50.MFSN032.084	ISO50	32	67	84	64,9	BEMSN.32	925.068	ESMS.010

CARATTERISTICHE TECNICHE - TECHNICAL CHARACTERISTICS

- Ridotte dimensioni di ingombro (lunghezza e diametro esterno) che consentono una migliore equilibratura (G 2,5 fino a 20000 rpm)
 - Aumento della rigidità del mandrino per una resa migliore in lavorazione
 - Perfetta centricità dell'utensile (0,003/0,004 mm a 2,5xØ) che determinano un incremento della durata degli inserti fino a raddoppiare la durata
 - Aumento della potenza di serraggio Max 1750 Nm
 - Adatto anche per frese con attacco cilindrico, weldon, whistle notch e punte in metallo duro
 - Passaggio del lubrificante attraverso l'utensile fino a 100 bar
 - Serraggio ottimale garantito dall'allineamento delle tacche (ghiera mandrino)
- Reduced dimensions (length and external diameter) for a better balancing (G 2,5 till to 20000 rpm)
 - High rigidity of the chuck for a better performance
 - Perfect concentricity (0,003/0,004 mm 2,5xØ) for an increase in toollife
 - Increase of tightening force Max 1750 Nm
 - Suitable for endmills tools with cylindrical, weldon and whistle notch shank and for carbide drills
 - Coolant through the tool till 100 bar
 - Best clamping assured by alignment of notches (fixin ring nut/arbor)

	Ød2 (mm)	L1 (mm)	Concentricità "S" Concentricity "S" (mm)	Forza di serraggio Clamping force (Nm)
	20	40	0,003	1000
	32	64	0,004	1750

PER AVERE UNA TENUTA DEL LUBRIFICANTE FINO A 100 bar BISOGNA ACQUISTARE IL MANDRINO CON ANELLO DI TENUTA. PER ORDINARE TALE MANDRINO, BISOGNA AGGIUNGERE AL CODICE DEL MANDRINO SCELTO UNA "F" FINALE E SPECIFICARLO AL MOMENTO DELL' ORDINE. UTILIZZANDO LE PINZE DI RIDUZIONE CILINDRICHE BISOGNA SOSTITUIRE L'ANELLO DI TENUTA DEL DIAMETRO DELL'UTENSILE PRESCELTO. IL MANDRINO GARANTISCE IL PASSAGGIO DEL LUBRIFICANTE (max 100 bar), SIA CON UTENSILI CALETTATI DIRETTAMENTE SIA CON PINZE DI RIDUZIONE CILINDRICHE BEMS.. INTERPOSTE.

TO OBTAIN A COOLANT FLOW UP TO 100 bar YOU MUST PURCHASE THE CHUCK WITH SEALING RING. TO ORDER THIS CHUCK YOU MUST ADD A FINAL "F" TO THE SELECTED CHUCK CODE AND SPECIFY IT WHEN PLACING THE ORDER. FOR THE USE OF THE CYLINDRICAL REDUCTION SLEEVES THE SEALING RING MUST BE REPLACED WITH ONE OF THE SAME DIAMETER AS THE TOOL CHOSEN. THE HIGH CLAMPING CHUCK IS SUITABLE FOR A COOLANT FLOW (UP TO 100 bar) BOTH WITH DIRECTLY SHRUNK-ON TOOLS AND WITH BEMS CYLINDRICAL REDUCTION SLEEVES.



PAG 1088

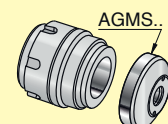

ART. ISO.A..MI.
DIN 69871/A

NEW

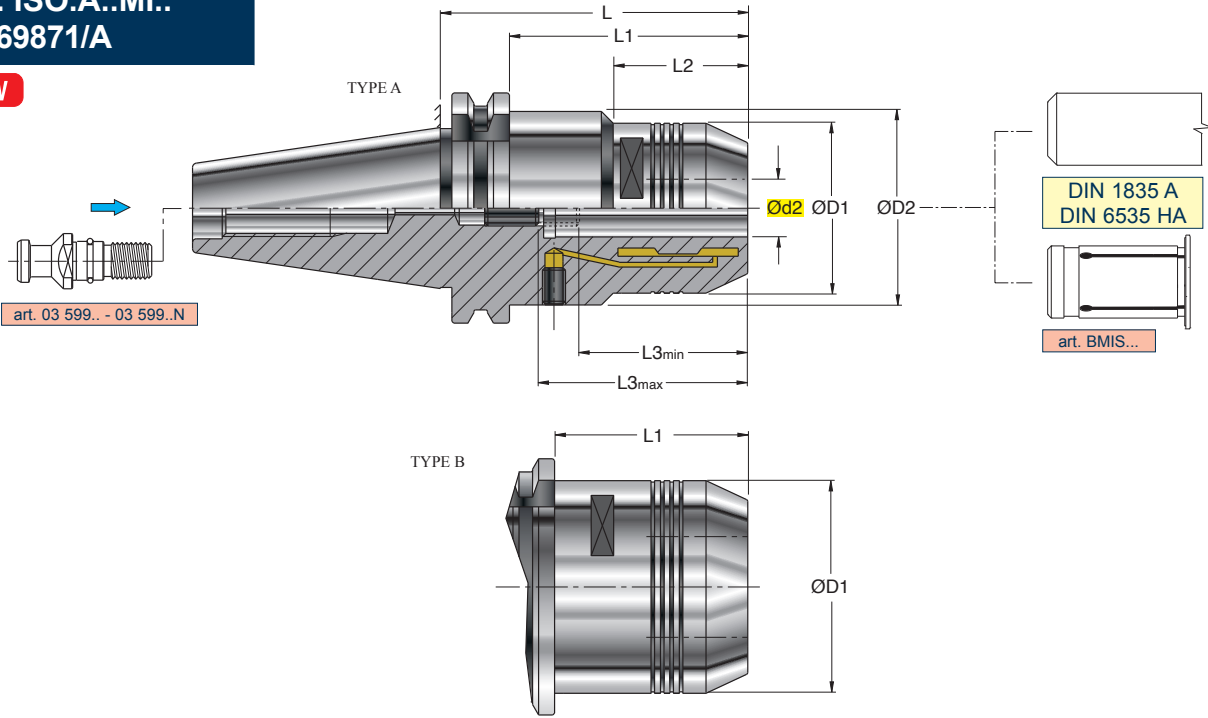

MANDRINO A BLOCCAGGIO IDRAULICO
HYDRAULIC CLAMPING CHUCK
AUFNAHME MIT HYDRODEHNSPANNUNG
MANDRIN AVEC BLOCCAGE HYDRAULIC

0,005 L <= 3x d2

EQUILIBRATO
BALANCED
G 2,5 25000 min⁻¹

ART.		(mm)			L	L1	L2	L3min	L3max	TYPE				
		Ød2	ØD1	ØD2										
ISO.A40.MI020.065	ISO40	20	49,5	-	64,5	45,5	-	42,5	52,5	B	BMIS 20..			
ISO.A50.MI020.090	ISO50	20	50	43	90	70,9	48	42,5	52,5	A	BMIS 20..			
ISO.A50.MI032.081	ISO50	32	72	-	81	61,9	-	55	65	B	BMIS 32..			

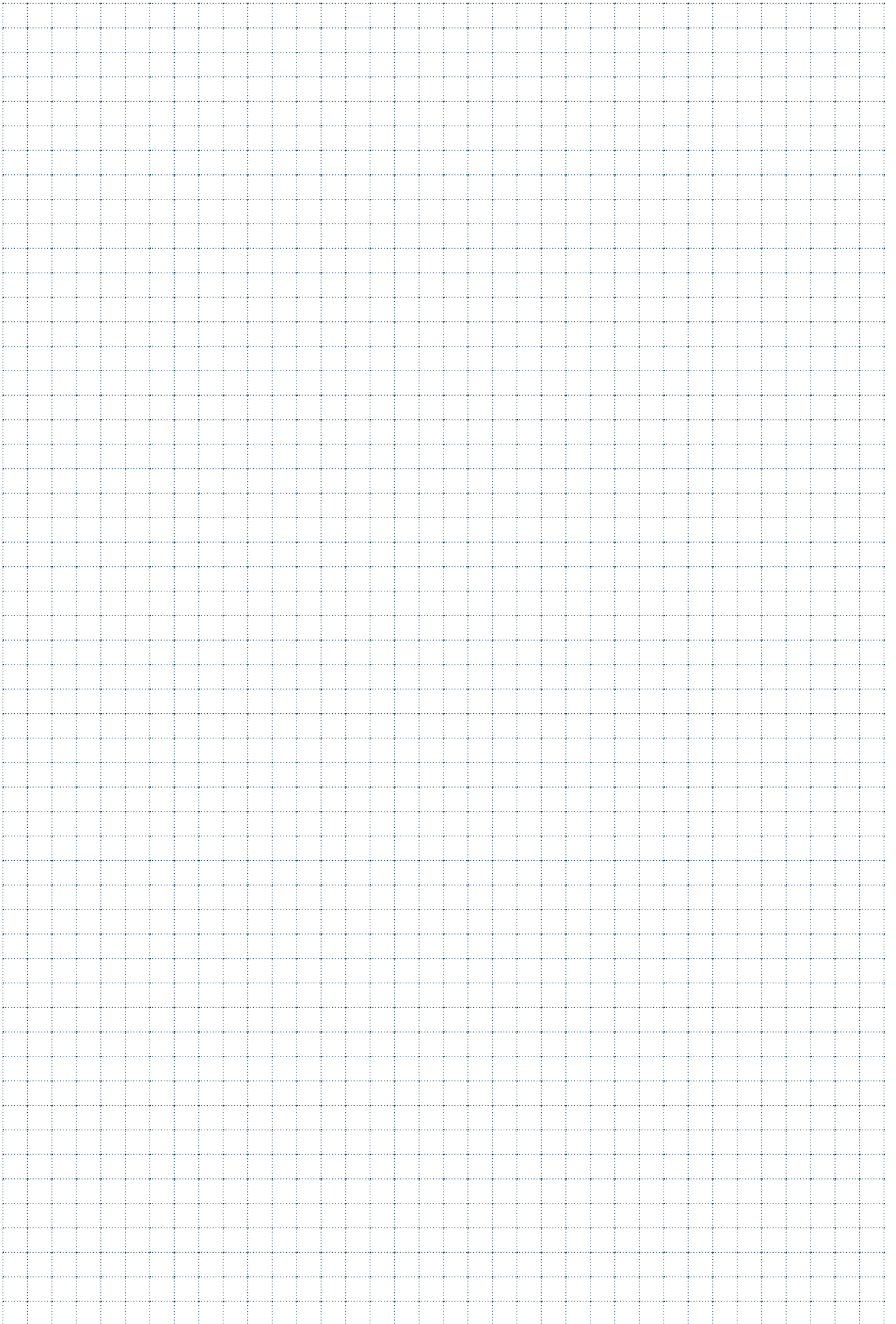

PORTAPINZA STANDARD

- COLLET HOLDER STANDARD
- SPANNFUTTER STANDARD
- MANDRIN PORTE-PINCE STANDARD

MAS.B..ER..
... /AD - B

ER-DIN 6499

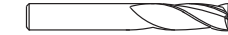
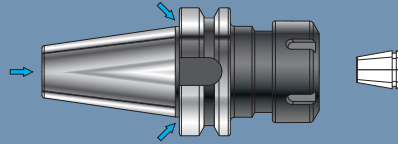

DIN 1835 A - DIN 6535 HA

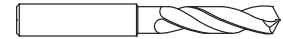

PAG 1012

MANDRINO CORTO PER ATTACCHI TIPO WELDON

- END-MILL HOLDER FOR WELDON CONNECTION SHORT-TYPE
- AUFNAHME FÜR WELDON-TYPE, KURZE AUSFÜHRUNG
- MANDRIN POUR ATTACHEMENT WELDON, SERIE COURTE

MAS.A..WEC..
... /AD

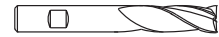
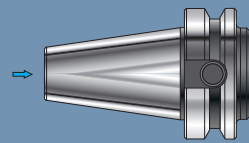

WELDON - DIN1835B - DIN6535HB

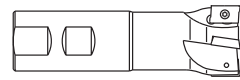

PAG 1013

MANDRINO PER ATTACCHI TIPO WELDON

- END MILL HOLDER FOR WELDON CONNECTION
- WERKZEUGAUFNAHME FÜR WELDON-TYPE
- MANDRIN POUR ATTACHEMENT WELDON

MAS.B..WE..
... /AD - B

DIN 6359 B

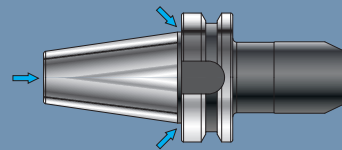

WELDON - DIN1835B - DIN6535HB

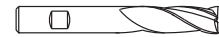

ISO 9766



PAG 1014-1015

PORTAPUNTA UNIVERSALE

- UNIVERSAL ADAPTER FOR DRILLING TOOLS
- WELDON-AUFNAHME FÜR VOLLBOHRER
- PORTE-FORET UNIVERSEL

MAS.B..PUH..
... /AD - B

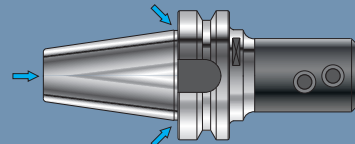

WHISTLE-NOTCH - DIN1835E - DIN6535HE

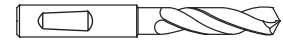

ISO 9766



PAG 1016

PORTAFRESA A TRASCINAMENTO FRONTALE CON TENONE

- SHELL END-MILL HOLDERS WITH TENON
- FRÄSERAUFNAHME MIT QUERNUT UND LAPPEN
- PORTE-FRAISE A ENTRAINEMENT FRONTAL AVEC TENON

MAS.B..FSW..
... /AD - B

ISO 3937

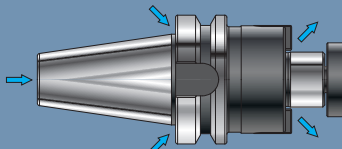

ISO 6462

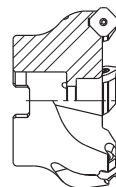

PAG 1017

PORTAFRESA ANTIVIBRANTE A TRASCINAMENTO FRONTALE CON TENONE

- VIBRATION-DAMPED SHELL END-MILL HOLDERS WITH TENON
- SCHWINGUNGSGEDÄMPFTE FRÄSERAUFNAHME MIT QUERNUT UND LAPPEN
- MANDRIN PORTE-FRAISE ANTIVIBRATOIRE A ENTRAINEMENT FRONTAL AVEC TENON

MAS.A..FSV..
... /AD

ISO 3937

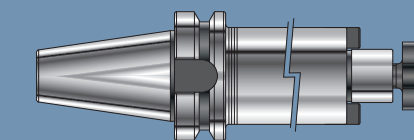

ISO 6462

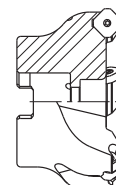

PAG 1018



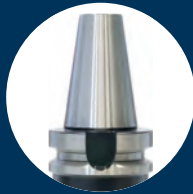

MAS.A..FSCV..
... /AD

ISO 3937

**PORTAFRESA ANTIVIBRANTE
A TRASCINAMENTO FRONTALE CON TENONE**

- VIBRATION-DAMPED SHELL END-MILL HOLDERS WITH TENON
- SCHWINGUNGSGEDÄMPFTE FRÄSERAUFNAHME MIT QUERNUT UND LAPPEN
- MANDRIN PORTE-FRAISE ANTIVIBRATOIRE A ENTRAÎNEMENT FRONTAL AVEC TENON

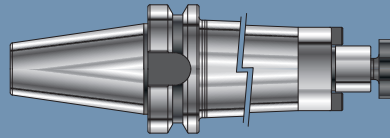

ISO 6462

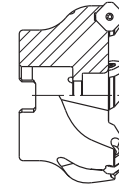

PAG 1019

MAS.A..FF..
... /A

DIN 6357 B

**PORTAFRESA A TRASCINAMENTO
FRONTALE CON TENONE**

- SHELL END-MILL HOLDERS WITH TENON
- FRÄSERAUFNAHME MIT QUERNUT UND LAPPEN
- PORTE-FRAISE A ENTRAÎNEMENT FRONTAL AVEC TENON

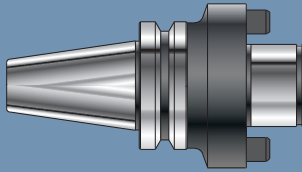

DIN 8030 C



PAG 1020

MAS.A..FC..
... /A

DIN 6358 B

**PORTAFRESA A TRASCINAMENTO
COMBINATO PER FRESE A MANICOTTO
E A DISCO**

- COMBI FACE MILL HOLDERS FOR SHELL-END AND DISC MILLING CUTTERS
- FRÄSERAUFNAHME KOMBINIERT FÜR AUFSTECK-UND SCHEIBENFRÄSER
- MANDRIN PORTE-FRAISE À ENTRAÎNEMENT COMBINÉ POUR FRAISES À MANCHON ET DE DISQUE

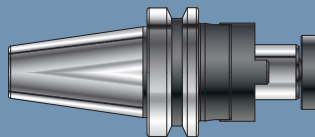

ISO 6462

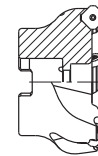

DIN 138



PAG 1021

MAS.A..MC..
... /A

**PORTAMASCHIO A CAMBIO RAPIDO
CON DOPPIA COMPENSAZIONE**

- QUICK-CHANGE TAP HOLDER WITH DOUBLE COMPENSATION
- GEWINDESCHNEID-SCHNELLWECHSELFUTTER MIT DOPPELAUSGLEICH
- MANDRINS DE TARAUDAGE À CHANGEMENT RAPIDE À DOUBLE COMPENSATION

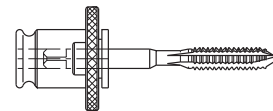
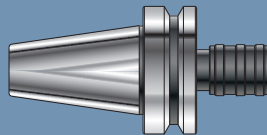

PAG 1022

MAS.A..MS..
... /AD

**PORTAMASCHIO A CAMBIO RAPIDO
PER MASCHIATURA SINCRONIZZATA**

- QUICK CHANGE TAP HOLDER FOR SYNCHRONIZED TAPPING
- GEWINDESCHNEID-SCHNELLWECHSELFUTTER ZUM STARREN GEWINDESCHNEIDEN
- APPAREIL PORTE-TARAUDS À CHANGEMENT RAPIDE POUR TARAUDAGE SYNCHRONISÉ

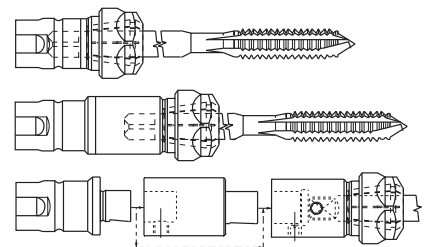
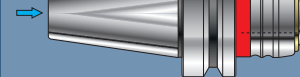

PAG 1023

MAS.A..SF..
... /A

BARRA CON CONO FINITO E STELO TENERO

- BORING BARS WITH FINISHED TAPER AND BLANK SHAFT
- ROHLINGE
- BARRE AVEC CONE FINI ET BOUT DOUX

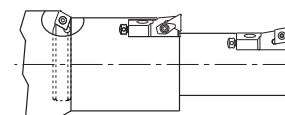
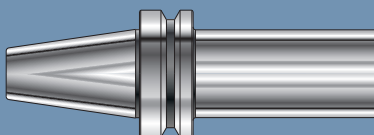

PAG 1024

PORTAFRESA CON ATTACCO MODULARE FILETTATO

- CUTTER-HOLDER WITH MODULAR THREADED CONNECTION
- FRASERAUFNAHME MIT MODULAR-GEWINDEAUFNAHME
- MANDRIN PORTE-FRAISE AVEC ATTACHEMENT MODULAIRE FILETÉ

MAS.B40.MD..
... /AD - B

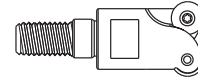
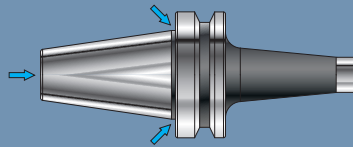

PAG 1025

PORTAFRESA ANTIVIBRANTE CON ATTACCO MODULARE FILETTATO

- VIBRATION-DAMPED CUTTER-HOLDER WITH MODULAR THREADED CONNECTION
- SCHWINGUNGSGEDÄMPFTE FRASERAUFNAHME MIT MODULAR-GEWINDEAUFNAHME
- MANDRIN PORTE-FRAISE ANTIVIBRATOIRE AVEC ATTACHEMENT MODULAIRE FILETÉ

MAS.A..MDV..
... /A

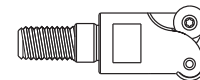
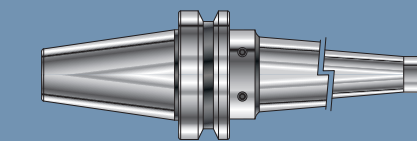

PAG 1026

MANDRINO A CALETTAMENTO TERMICO

- SHRINKING-ON TAPER SHANKS
- WERKZEUGAUFNAHMEN MIT SCHRUMPFVERBINDUNG
- MANDRIN À EMBOÎTEMENT THERMIQUE

MAS.B..CTS..
... /AD - B

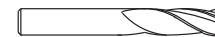
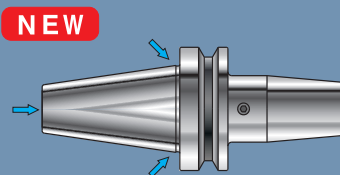

DIN 1835 A - DIN 6535 HA



PAG 1027

MANDRINO A CALETTAMENTO TERMICO PROLUNGABILE

- EXTENSIBLE SHRINK FIT
- VERLÄNGERBARES SCHRUMPFUTTER
- MANDRIN PROLONGEABLE À EMBOÎTEMENT THERMIQUE.

MAS.B..CTPN..
... /AD - B

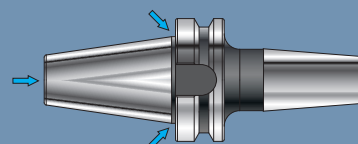

DIN 1835 A - DIN 6535 HA



PAG 1028

MANDRINO A FORTE SERRAGGIO

- HIGH CLAMPING CHUCKS
- KRAFTSPANNFUTTER
- MANDRIN À FORT SERRAGE

MAS.B..MFSN..
... /AD - B

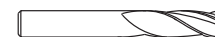
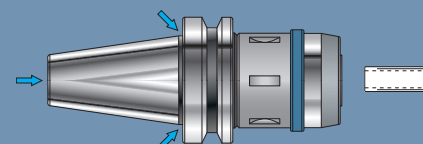

DIN 1835 A - DIN 6535 HA



PAG 1029

MANDRINO A BLOCCAGGIO IDRAULICO

- HYDRAULIC CLAMPING CHUCK
- AUFNAHME MIT HYDRODEHNSPANNUNG
- MANDRIN AVEC BLOCAGE HYDRAULIC

MAS.A..MI..
... /AD

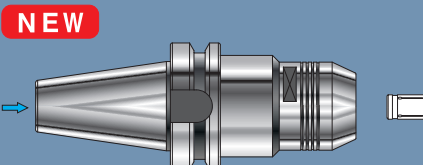

DIN 1835 A - DIN 6535 HA



PAG 1030

MAS-403-BT
ART. MAS B. ER.
MAS 403 BT/AD-B

SAU
DIN 6499

PORTAFANDE STANDARD
TOOL-HOLDER STANDARD
DINAMIT-UTZUG-STANDARDB
DYNAMITE FORCE-DRIVE STANDARD

ART	Ød	ØD1	L	L1	Ød	ØD1	L	L1	Ød	ØD1	L	L1	Ød	ØD1	L	L1
MAS-403-ER150	150	150	25	150	150	150	25	150	150	150	25	150	150	150	25	150
MAS-403-ER170	170	170	40	170	170	170	40	170	170	170	40	170	170	170	40	170
MAS-403-ER120	120	120	40	120	120	120	40	120	120	120	40	120	120	120	40	120
MAS-403-ER150	150	150	40	150	150	150	40	150	150	150	40	150	150	150	40	150
MAS-403-ER200	200	200	40	200	200	200	40	200	200	200	40	200	200	200	40	200
MAS-403-ER150	150	150	40	150	150	150	40	150	150	150	40	150	150	150	40	150
MAS-403-ER120	120	120	50	120	120	120	50	120	120	120	50	120	120	120	50	120
MAS-403-ER150	150	150	50	150	150	150	50	150	150	150	50	150	150	150	50	150
MAS-403-ER120	120	120	50	120	120	120	50	120	120	120	50	120	120	120	50	120
MAS-403-ER150	150	150	50	150	150	150	50	150	150	150	50	150	150	150	50	150
MAS-403-ER120	120	120	50	120	120	120	50	120	120	120	50	120	120	120	50	120
MAS-403-ER150	150	150	50	150	150	150	50	150	150	150	50	150	150	150	50	150
MAS-403-ER120	120	120	50	120	120	120	50	120	120	120	50	120	120	120	50	120
MAS-403-ER150	150	150	50	150	150	150	50	150	150	150	50	150	150	150	50	150
MAS-403-ER120	120	120	50	120	120	120	50	120	120	120	50	120	120	120	50	120
MAS-403-ER150	150	150	50	150	150	150	50	150	150	150	50	150	150	150	50	150
MAS-403-ER120	120	120	50	120	120	120	50	120	120	120	50	120	120	120	50	120
MAS-403-ER150	150	150	50	150	150	150	50	150	150	150	50	150	150	150	50	150
MAS-403-ER120	120	120	50	120	120	120	50	120	120	120	50	120	120	120	50	120

ADM. - GIERRE CON DIAMETRO ØD1 MINORATO, PAG. 1012
ADM. - RING-NUTS WITH REDUCED DIAMETER ØD1, SEE PAGE 1012
ADM. - GEWINDRINGE MIT BESCHRÄNKTEM DURCHMESSER Ø D1, SEITE 1012
ADM. - FRITES AVEC DIAMÈTRE ØD1 AMOINRI, PAGE 1012

942



- 1 = NORMA ATTACCO
- 2 = NORMA PARTE ANTERIORE
- 3 = ACCESSORI OPZIONALI A RICHIESTA
- 4 = CARATTERISTICHE TECNICHE
- 5 = ARTICOLO
- 6 = MISURE, DATI, INDICAZIONI
- 7 = ACCESSORI E RICAMBI IN DOTAZIONE
- 8 = ACCESSORI E RICAMBI OPZIONALI A RICHIESTA
- 9 = NOTE E AVVERTIMENTI



- 1 = SHANK STANDARD
- 2 = TOOL-HOLDER STANDARD
- 3 = OPTIONAL ACCESSORIES ON REQUEST.
- 4 = TECHNICAL FEATURES
- 5 = ITEM
- 6 = MEASURES, DATA, INDICATIONS
- 7 = ACCESSORIES AND SPARE PARTS EQUIPMENT
- 8 = OPTIONAL ACCESSORIES AND SPARE PARTS ON REQUEST
- 9 = NOTES AND WARNINGS



- 1 = KEGEL-NORM
- 2 = AUFNAHME-NORM
- 3 = OPTIONALZUBEHÖR AUF ANFRAGE
- 4 = TECHNISCHE HAUPTMERKMALE
- 5 = ARTKEL
- 6 = ABMESSUNGEN, DATEN, HINWEISE
- 7 = ZUBEHÖR UND ERSATZTEIL AUSSTATTUNG
- 8 = OPTIONALZUBEHÖR UND -ERSATZTEILE AUF ANFRAGE
- 9 = ANMERKUNGEN UND HINWEISE



- 1 = NORMES POUR ATTACHEMENT
- 2 = NORME POUR MANDRIN
- 3 = ACCESSOIRES OPTIONNELS SUR DEMANDE
- 4 = CARACTERISTIQUES TECHNIQUES
- 5 = ARTICLE
- 6 = DIMENSIONES, DONNÉES, INDICATIONS
- 7 = ACCESSOIRES ET RECHANGE EN DOTATION
- 8 = ACCESSOIRES ET RECHANGES OPTIONNELS SUR DEMANDE
- 9 = NOTES ET AVERTISSEMENTS

**ART. MAS.B..ER..
MAS 403 BT/AD-B**

DIN 6499

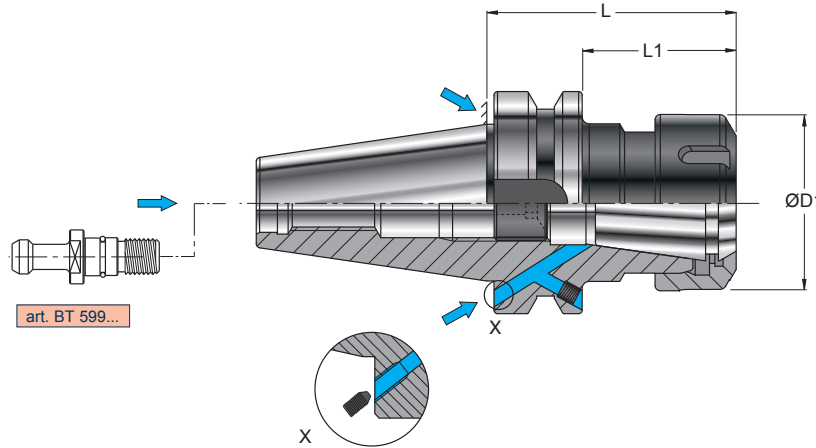

art. 228..
228Q.. (Reccomended)
230..
230QN..
328..
330..
329..
235..

PORTAPINZA STANDARD
COLLET HOLDER STANDARD
SPANNFUTTER STANDARD
MANDRIN PORTE-PINCE STANDARD

PRE-EQUILIBRATO
PRE-BALANCED
G 6,3 8000 min⁻¹

ART.		(mm)										
		Ød	ØD1	L	L1							
MAS.B40.ER016.150	ISO40	0,5-10	28	150	123	--.016.--.	RGS ER16			925.022	RGC ER16	925.022
MAS.B40.ER025.070	ISO40	1-16	42	70	33	--.025.--.	RGS ER25			925.040	RGC ER25	925.040
MAS.B40.ER025.120	ISO40	1-16	42	120	93	--.025.--.	RGS ER25			925.040	RGC ER25	925.040
MAS.B40.ER025.150	ISO40	1-16	42	150	123	--.025.--.	RGS ER25			925.040	RGC ER25	925.040
MAS.B40.ER025.200	ISO40	1-16	42	200	173	--.025.--.						
MAS.B40.ER032.070	ISO40	1-20	50	70	43	--.032.--.	RGS ER32			925.052	RGC ER32	925.052
MAS.B40.ER032.120	ISO40	1-20	50	120	93	--.032.--.						
MAS.B40.ER032.150	ISO40	1-20	50	150	123	--.032.--.						
MAS.B40.ER032.200	ISO40	1-20	50	200	173	--.032.--.						
MAS.B40.ER040.070	ISO40	2-30	63	70	43	--.040.--.	RGS ER40			925.068	RGC ER40	925.068
MAS.B50.ER025.120	ISO50	1-16	42	120	82	--.025.--.	RGS ER25			925.040	RGC ER25	925.040
MAS.B50.ER032.090	ISO50	1-20	50	90	52	--.032.--.	RGS ER32			925.052	RGC ER32	925.052
MAS.B50.ER032.120	ISO50	1-20	50	120	82	--.032.--.						
MAS.B50.ER040.120	ISO50	2-30	63	120	82	--.040.--.	RGS ER40			925.068	RGC ER40	925.068

ART. MAS.A..WEC..
MAS 403 BT/AD

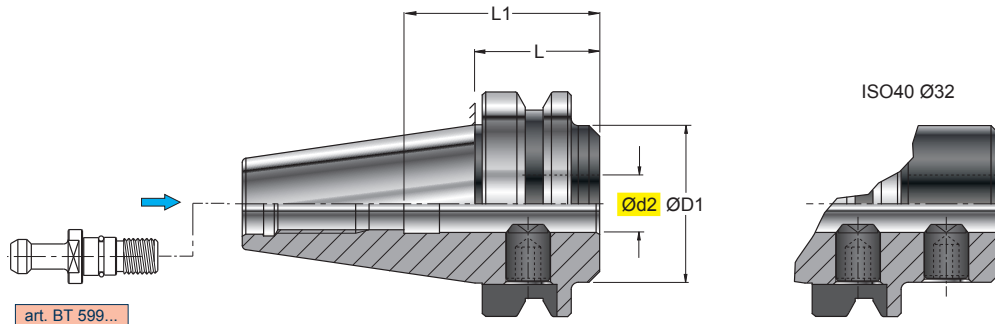

MANDRINO CORTO PER ATTACCHI TIPO WELDON
END-MILL HOLDER FOR WELDON CONNECTION-SHORT TYPE
AUFNAHME FÜR WELDON-TYPE, KURZE AUSFÜHRUNG
MANDRIN POUR ATTACHEMENT WELDON, SERIE COURTE

Ød2 H5

0,005

PRE-EQUILIBRATO
PRE-BALANCED
 G 6,3 8000 min⁻¹

ART.	(mm)										
		ISO40	Ød2	ØD1	L						
MAS.A40.WEC016.035	ISO40	16	44	35	45	GR1415	–	5006	–		
MAS.A40.WEC020.035	ISO40	20	44	35	45						
MAS.A40.WEC025.035	ISO40	25	44	35	55						
MAS.A40.WEC032.070	ISO40	32	72	70	60	GR1610	GR2015	5008	5010		
MAS.A50.WEC016.045	ISO50	16	70	45	45	GR1415	–	5006	–		
MAS.A50.WEC020.045	ISO50	20	70	45	45	GR1615	–	5008	–		
MAS.A50.WEC025.045	ISO50	25	70	45	55	GR1815	–	5008	–		
MAS.A50.WEC032.045	ISO50	32	70	45	60	GR2015	–	5010	–		

ART. MAS.B40.WE..
MAS 403 BT/AD-B

DIN 6359 B

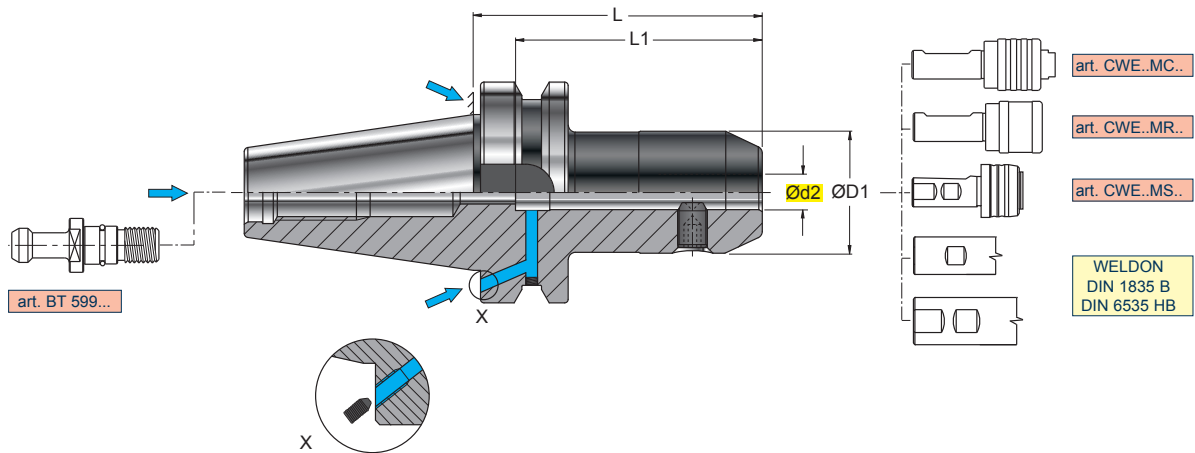

MANDRINO PER ATTACCHI TIPO WELDON
END MILL HOLDER FOR WELDON CONNECTION
WERKZEUGAUFNAHME FÜR WELDON-TYPE
MANDRIN POUR ATTACHEMENT WELDON

Ød2 H5

0,005

PRE-EQUILIBRATO
PRE-BALANCED
G 6,3 8000 min⁻¹

ART.		(mm)									
		ISO40	Ød2	ØD1	L						
MAS.B40.WE006.065	ISO40	6	25	65	35	GR06	5003				
MAS.B40.WE006.100	ISO40	6	25	100	35						
MAS.B40.WE006.150	ISO40	6	25	150	35	GR08	5004				
MAS.B40.WE008.065	ISO40	8	28	65	35						
MAS.B40.WE008.100	ISO40	8	28	100	35	GR10	5005				
MAS.B40.WE010.100	ISO40	10	35	100	39						
MAS.B40.WE012.065	ISO40	12	42	65	44	GR1215	5006				
MAS.B40.WE012.100	ISO40	12	42	100	44						
MAS.B40.WE014.065	ISO40	14	44	65	44	GR1215	5006				
MAS.B40.WE016.065	ISO40	16	48	65	47						
MAS.B40.WE016.100	ISO40	16	48	100	47	GR1415	5006				
MAS.B40.WE018.150	ISO40	18	50	150	47						
MAS.B40.WE020.065	ISO40	20	52	65	49	GR1615	5008				
MAS.B40.WE020.100	ISO40	20	52	100	49						
MAS.B40.WE020.150	ISO40	20	52	150	49	GR1815	5008				
MAS.B40.WE025.090	ISO40	25	65	90	54						
MAS.B40.WE032.090	ISO40	32	72	90	58	GR2015	5010				
MAS.B40.WE032.150	ISO40	32	72	150	58						
MAS.B40.WE040.105	ISO40	40	80	105	68						

ART. MAS.B50.WE..
MAS 403 BT/AD-B

DIN 6359 B

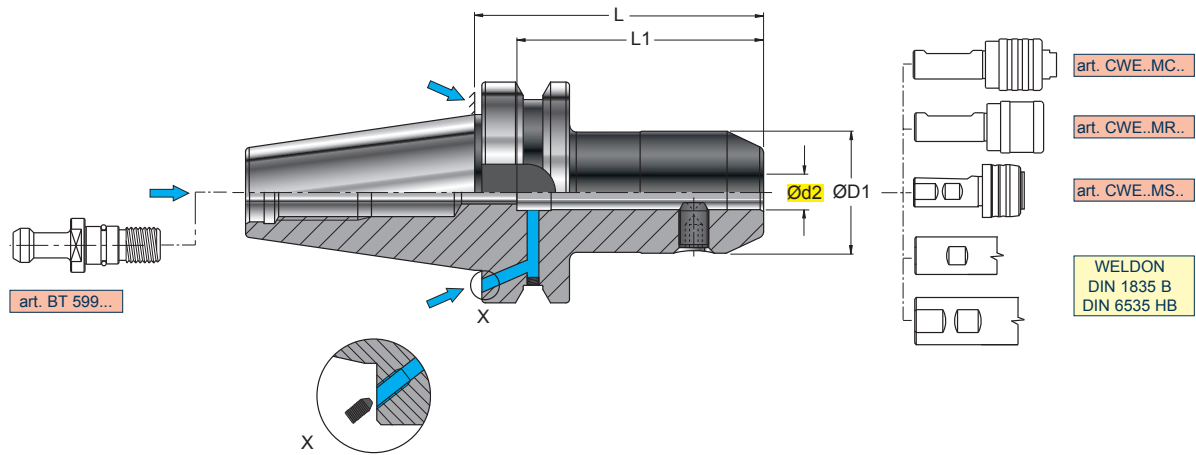

MANDRINO PER ATTACCHI TIPO WELDON
END MILL HOLDER FOR WELDON CONNECTION
WERKZEUGAUFNAHME FÜR WELDON-TYPE
MANDRIN POUR ATTACHEMENT WELDON

Ød2 H5

0,005

PRE-EQUILIBRATO
PRE-BALANCED
 G 6,3 8000 min⁻¹

ART.	(mm)										
		ISO50	Ød2	ØD1	L						
MAS.B50.WE012.080	ISO50	12	42	80	44	GR1215	5006				
MAS.B50.WE016.080	ISO50	16	48	80	47	GR1415	5006				
MAS.B50.WE018.100	ISO50	18	50	100	47						
MAS.B50.WE020.100	ISO50	20	52	100	49	GR1615	5008				
MAS.B50.WE025.100	ISO50	25	65	100	54	GR1815	5010				
MAS.B50.WE032.100	ISO50	32	72	100	58	GR2015	5010				
MAS.B50.WE032.150	ISO50	32	72	150	58						
MAS.B50.WE050.115	ISO50	50	90	115	78	GR2420	5017				

ART. MAS.B..PUH.. MAS 403 BT/AD-B

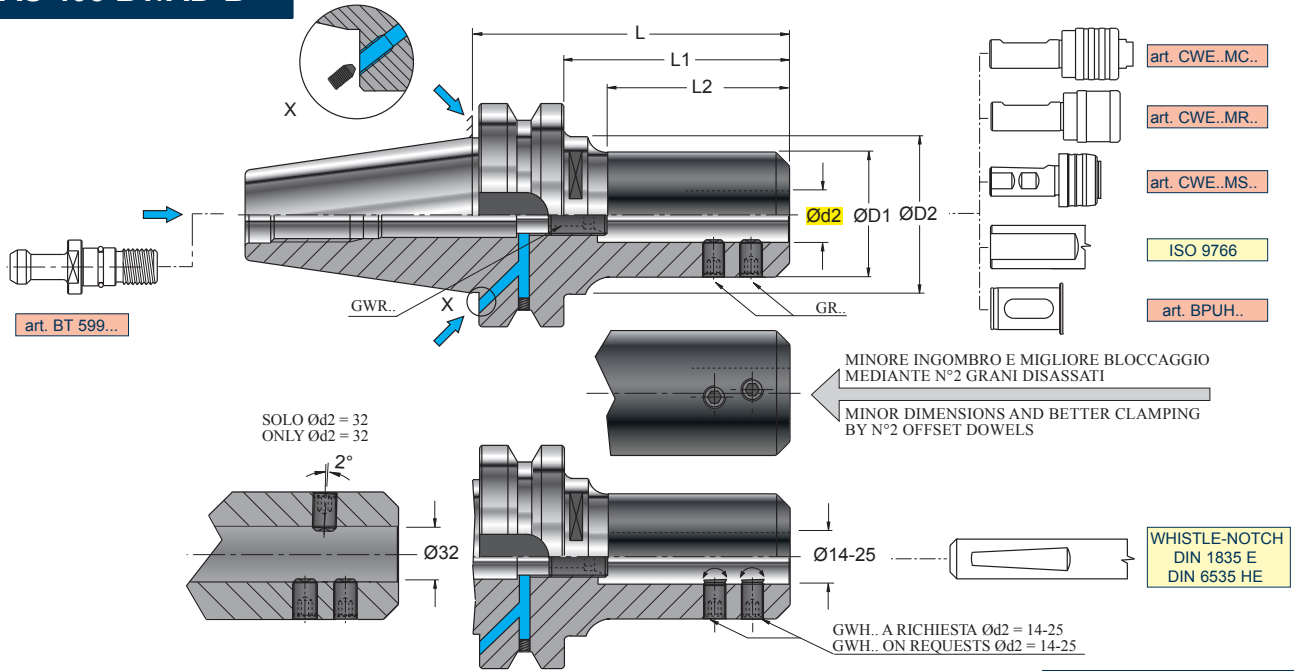

PORTAPUNTA UNIVERSALE
UNIVERSAL ADAPTER FOR DRILLING TOOLS
WELDON-AUFNAHME FÜR VOLLBOHRER
PORTE-FORET UNIVERSEL

Ød2 H5

0,003

PRE-EQUILIBRATO PRE-BALANCED
BT40 = G6,3 8000 min⁻¹
BT50 = G6,3 6000 min⁻¹

ART.	ISO40	(mm)						GR	GWR	5005	5006	GWH	5005
		Ød2	ØD1	ØD2	L	L1	L2						
MAS.B40.PUH014.100	ISO40	14	36	44,7	100	73	45	n°2 GR10	GWR12	5005	5006	GWH10	5005
MAS.B40.PUH016.100	ISO40	16	38	44,7	100	73	45						
MAS.B40.PUH018.100	ISO40	18	40	44,7	100	73	48						
MAS.B40.PUH020.100	ISO40	20	42	50	100	73	48	n°2 GR10	GWR16	5005	5008	GWH10	5005
MAS.B40.PUH025.100	ISO40	25	48	55	100	73	48	n°2 GR10	GWR20	5005	5010	GWH10	5005
MAS.B40.PUH032.080	ISO40	32	58	-	80	53	-	n°2 GR10	-	5005	-	GWH10	5005
MAS.B40.PUH040.080	ISO40	40	68	-	80	53	-	n°3 GR14	-	5006	-	-	-

ART. MAS.B..FSW..
MAS 403 BT/AD-B

ISO 3937

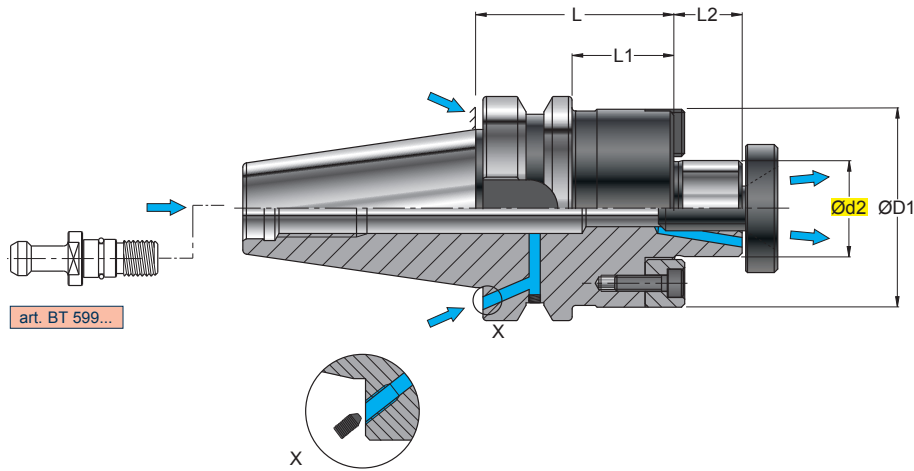

PORTAFRESA A TRASCINAMENTO FRONTALE CON TENONE
SHELL END-MILL HOLDERS WITH TENON
FRÄSERAUFNAHME MIT QUERNUT UND LAPPEN
PORTE-FRAISE A ENTRAÎNEMENT FRONTAL AVEC TENON

	PRE-EQUILIBRATO	PRE-BALANCED
	BT40 = G6,3 8000 min ⁻¹	
		BT50 = G6,3 6000 min ⁻¹

ART.		(mm)											
		ISO	Ød2	ØD1	L	L1	L2						
MAS.B40.FSW016.060	ISO40	16	40	60	33	17	RS 16	VBS08	TSFS16	VB02		5025	
MAS.B40.FSW016.100	ISO40	16	40	100	73	17							
MAS.B40.FSW022.060	ISO40	22	50	60	33	19	RS 22	VBS10	TSFS22	VB04		5003	
MAS.B40.FSW022.100	ISO40	22	50	100	73	19							
MAS.B40.FSW027.045	ISO40	27	60	45	18	21	RS 27	VBS12	TSFS27	VB05		5004	
MAS.B40.FSW027.100	ISO40	27	60	100	73	21							
MAS.B40.FSW032.060	ISO40	32	65	60	33	24	RS 32	VBS16	TSFS32	VB05		5004	
MAS.B50.FSW016.075	ISO50	16	40	75	37	17	RS 16	VBS08	TSFS16	VB02		5025	
MAS.B50.FSW022.075	ISO50	22	50	75	37	19	RS 22	VBS10	TSFS22	VB04		5003	
MAS.B50.FSW022.100	ISO50	22	50	100	62	19							
MAS.B50.FSW027.060	ISO50	27	60	60	22	21	RS 27	VBS12	TSFS27	VB05		5004	
MAS.B50.FSW027.100	ISO50	27	60	100	62	21							
MAS.B50.FSW032.075	ISO50	32	75	75	37	24	RS 32	VBS16	TSFS32	VB05		5004	
MAS.B50.FSW032.100	ISO50	32	75	100	62	24							

**ART. MAS.A..FSV..
MAS 403 BT/A**

ISO 3937

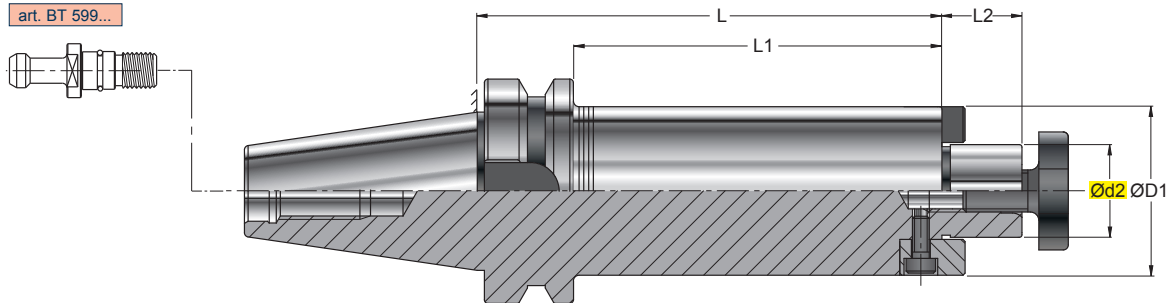

PORTAFRESA ANTIVIBRANTE A TRASCINAMENTO FRONTALE CON TENONE
 VIBRATION-DAMPED SHELL END-MILL HOLDERS WITH TENON
 SCHWINGUNGSGEDÄMPFTE FRÄSERAUFNAHME MIT QUERNUT UND LAPPEN
 MANDRIN PORTE-FRAISE ANTIVIBRATOIRE A ENTRAÎNEMENT FRONTAL AVEC TENON

0,015

PRE-EQUILIBRATO
PRE-BALANCED
G 6,3 8000 min⁻¹

ART.		(mm)										
		Ød2	ØD1	L	L1	L2						kg
MAS.A40.FSV016.150	ISO40	16	38	150	123	17	2,10	CHF16V	VB 02	422.016..	5025	423.016..
MAS.A40.FSV016.200	ISO40	16	38	200	173	17	2,60					
MAS.A40.FSV016.250	ISO40	16	38	250	223	17	3,00					
MAS.A40.FSV016.300	ISO40	16	38	300	273	17	3,50					
MAS.A40.FSV022.150	ISO40	22	48	150	123	19	2,80	CHF22V	VB 04	422.022..	5003	423.022..
MAS.A40.FSV022.200	ISO40	22	48	200	173	19	3,50					
MAS.A40.FSV022.250	ISO40	22	48	250	223	19	4,20					
MAS.A40.FSV022.300	ISO40	22	48	300	273	19	4,90					
MAS.A40.FSV027.150	ISO40	27	54	150	123	21	3,60	CHF27V	905.005.080.012	422.027..	5004	423.027..
MAS.A40.FSV027.200	ISO40	27	54	200	173	21	4,70					
MAS.A40.FSV027.250	ISO40	27	54	250	223	21	5,70					
MAS.A40.FSV027.300	ISO40	27	54	300	273	21	6,70					
MAS.A50.FSV016.150	ISO50	16	38	150	112	17	4,70	CHF16V	VB 02	422.016..	5025	423.016..
MAS.A50.FSV016.200	ISO50	16	38	200	162	17	5,20					
MAS.A50.FSV016.250	ISO50	16	38	250	212	17	5,60					
MAS.A50.FSV016.300	ISO50	16	38	300	262	17	6,10					
MAS.A50.FSV016.400	ISO50	16	38	400	362	17	7,00					
MAS.A50.FSV022.200	ISO50	22	48	200	162	19	6,10	CHF22V	VB 04	422.022..	5003	423.022..
MAS.A50.FSV022.250	ISO50	22	48	250	212	19	6,80					
MAS.A50.FSV022.300	ISO50	22	48	300	262	19	7,50					
MAS.A50.FSV022.400	ISO50	22	48	400	362	19	8,90					
MAS.A50.FSV022.500	ISO50	22	48	500	462	19	10,30					
MAS.A50.FSV022.200B	ISO50	22	60	200	162	19	7,10					
MAS.A50.FSV022.250B	ISO50	22	60	250	212	19	9,20					
MAS.A50.FSV022.300B	ISO50	22	60	300	262	19	9,20					
MAS.A50.FSV022.400B	ISO50	22	60	400	362	19	11,30					
MAS.A50.FSV022.500B	ISO50	22	60	500	462	19	13,30					
MAS.A50.FSV027.200	ISO50	27	60	200	162	21	7,10	CHF27V	905.005.080.012	422.027..	5004	423.027..
MAS.A50.FSV027.250	ISO50	27	60	250	212	21	8,20					
MAS.A50.FSV027.300	ISO50	27	60	300	262	21	9,20					
MAS.A50.FSV027.400	ISO50	27	60	400	362	21	11,30					
MAS.A50.FSV027.500	ISO50	27	60	500	462	21	13,40					
MAS.A50.FSV032.200	ISO50	32	76	200	162	24	9,90	CHF32V	905.005.080.012	422.032..	5004	423.032..
MAS.A50.FSV032.250	ISO50	32	76	250	212	24	11,80					
MAS.A50.FSV032.300	ISO50	32	76	300	262	24	13,60					
MAS.A50.FSV032.400	ISO50	32	76	400	362	24	17,40					
MAS.A50.FSV032.500	ISO50	32	76	500	462	24	21,10					

**ART. MAS.A..FSCV..
MAS 403 BT/A**

ISO 3937





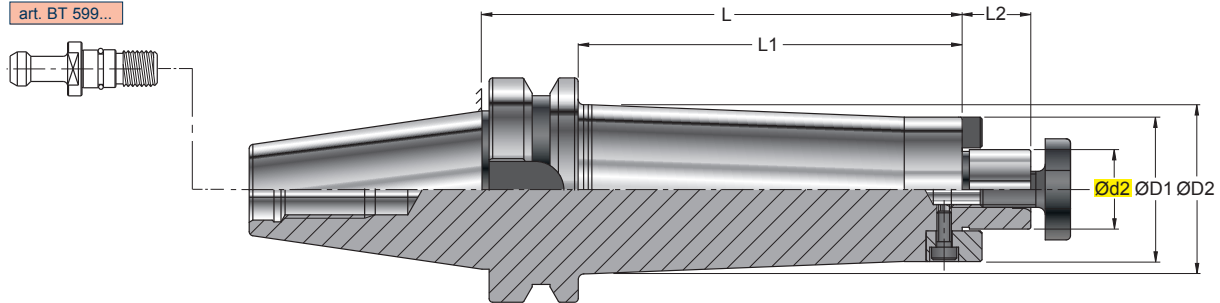



art. BT 599...



PORTAFRESA ANTIVIBRANTE A TRASCINAMENTO FRONTALE CON TENONE
 VIBRATION-DAMPED SHELL END-MILL HOLDERS WITH TENON
 SCHWINGUNGSGEDÄMPFTE FRÄSERAUFNAHME MIT QUERNUT UND LAPPEN
 MANDRIN PORTE-FRAISE ANTIVIBRATOIRE A ENTRAÎNEMENT FRONTAL AVEC TENON

0,015

PRE-EQUILIBRATO
PRE-BALANCED
G 6,3 8000 min⁻¹

ART.		(mm)			kg								
		Ød2	ØD1	ØD2							L	L1	L2
MAS.A40.FSCV016.150	ISO40	16	38	50	150	123	17	2,60	CHF16V	VB 02	422.016..	5025	423.016..
MAS.A40.FSCV016.200	ISO40	16	38	50	200	173	17	3,20					
MAS.A40.FSCV016.250	ISO40	16	38	50	250	223	17	3,80					
MAS.A40.FSCV016.300	ISO40	16	38	50	300	273	17	4,40					
MAS.A40.FSCV022.150	ISO40	22	48	50	150	123	19	2,80	CHF22V	VB 04	422.022..	5003	423.022..
MAS.A40.FSCV022.200	ISO40	22	48	50	200	173	19	3,40					
MAS.A40.FSCV022.250	ISO40	22	48	50	250	223	19	4,10					
MAS.A40.FSCV022.300	ISO40	22	48	50	300	273	19	4,80					
MAS.A50.FSCV016.150	ISO50	16	38	80	150	112	17	6,50	CHF16V	VB 02	422.016..	5025	423.016..
MAS.A50.FSCV016.200	ISO50	16	38	80	200	162	17	7,60					
MAS.A50.FSCV016.250	ISO50	16	38	80	250	212	17	8,80					
MAS.A50.FSCV016.300	ISO50	16	38	80	300	262	17	9,90					
MAS.A50.FSCV016.400	ISO50	16	38	80	400	362	17	12,10					
MAS.A50.FSCV022.200	ISO50	22	48	80	200	162	19	8,10	CHF22V	VB 04	422.022..	5003	423.022..
MAS.A50.FSCV022.250	ISO50	22	48	80	250	212	19	9,40					
MAS.A50.FSCV022.300	ISO50	22	48	80	300	262	19	10,70					
MAS.A50.FSCV022.400	ISO50	22	48	80	400	362	19	13,30					
MAS.A50.FSCV022.500	ISO50	22	48	80	500	462	19	15,80					
MAS.A50.FSCV027.200	ISO50	27	58	80	200	162	21	8,80	CHF27V	905.005.080.012	422.027..	5004	423.027..
MAS.A50.FSCV027.250	ISO50	27	58	80	250	212	21	10,30					
MAS.A50.FSCV027.300	ISO50	27	58	80	300	262	21	11,80					
MAS.A50.FSCV027.400	ISO50	27	58	80	400	362	21	14,90					
MAS.A50.FSCV027.500	ISO50	27	58	80	500	462	21	17,90					





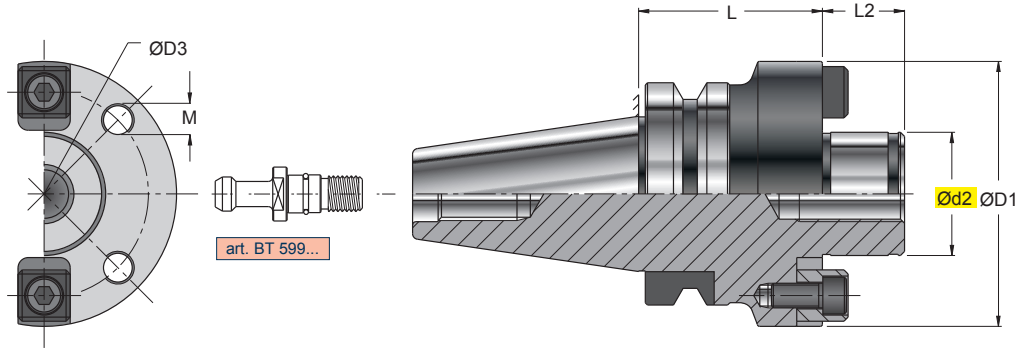

ART. MAS.A..FF..
MAS 403 BT/A

DIN 6357 B



PORTAFRESA A TRASCINAMENTO FRONTALE CON TENONE
SHELL END-MILL HOLDERS WITH TENON
FRÄSERAUFNHME MIT QUERNUT UND LAPPEN
PORTE-FRAISE A ENTRAINEMENT FRONTAL AVEC TENON

0,003

ART.		(mm)												
		Ød2	ØD1	ØD3	L	L2	M							
MAS.A50.FF040.050 New	ISO50	40	89	66,7	50	25	12	TSFF40	VB06			5005	RS 40	VBS20
MAS.A50.FF060.088	ISO50	60	129	101,6	88	40	16	TSFF60	VB12C			5010	RS 60	VBS24

ART. MAS.A..FC..
MAS 403 BT/A



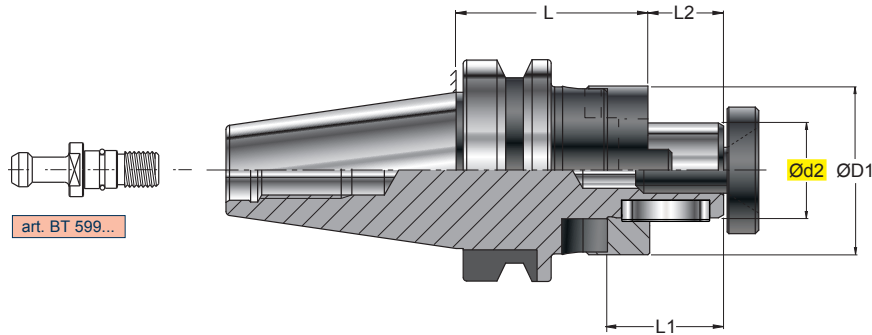

DIN 6358 B







PORTAFRESA A TRASCINAMENTO COMBINATO PER FRESE A MANICOTTO E A DISCO
 COMBI FACE MILL HOLDERS FOR SHELL-END AND DISC MILLING CUTTERS
 FRÄSERAUFNAHME KOMBINIERT FÜR AUFSTECK-UND SCHEIBENFRÄSER
 MANDRIN PORTE-FRAISE À ENTRAÎNEMENT COMBINÉ POUR FRAISES À MANCHON ET DE DISQUE

0,01

PRE-EQUILIBRATO
PRE-BALANCED
G 6,3 8000 min⁻¹

ART.		(mm)									
		ISO	Ød2	ØD1	L	L1					
MAS.A40.FC016.090	ISO40	16	32	90	27	17	RS 16	VBS08	CT0420	08.3501.016.AT	
MAS.A40.FC022.055	ISO40	22	40	55	31	19	RS 22	VBS10	CT0625	08.3502.022.AT	
MAS.A40.FC022.090	ISO40	22	40	90	31	19					
MAS.A40.FC027.055	ISO40	27	48	55	33	21	RS 27	VBS12	CT0725	08.3503.027.AT	
MAS.A40.FC027.090	ISO40	27	48	90	33	21					
MAS.A40.FC032.090	ISO40	32	58	90	38	24	RS 32	VBS16	CT0828	08.3504.032.AT	
MAS.A40.FC040.090	ISO40	40	70	90	41	27	RS 40	VBS20	CT1032	08.3505.040.AT	
MAS.A50.FC027.120	ISO50	27	48	120	33	21	RS 27	VBS12	CT0725	08.3503.027.AT	
MAS.A50.FC032.120	ISO50	32	58	120	38	24	RS 32	VBS16	CT0828	08.3504.032.AT	
MAS.A50.FC040.120	ISO50	40	70	120	41	27	RS 40	VBS20	CT1032	08.3505.040.AT	

 PER IL MONTAGGIO DELLE FRESE A DISCO OCCORRE L'ANELLO DISTANZIATORE **195..** , PAG 1095
 FOR THE INSTALLATION OF THE DISC MILLING CUTTERS THE DISTANCE RING **195..** (PAGE 1095) IS REQUIRED.
 ZUM EINBAU DER SCHEIBENFRÄSER WIRD DER DISTANZRING **195..** (SEITE 1095) BENÖTIGT.
 EN CAS DE MONTAGE DES FRAISES-DISQUES LA BAGUE D'ENTRETOISE **195..** , PAGE 1095 S'IMPOSE

ART. MAS.A..MC..
MAS 403 BT/A

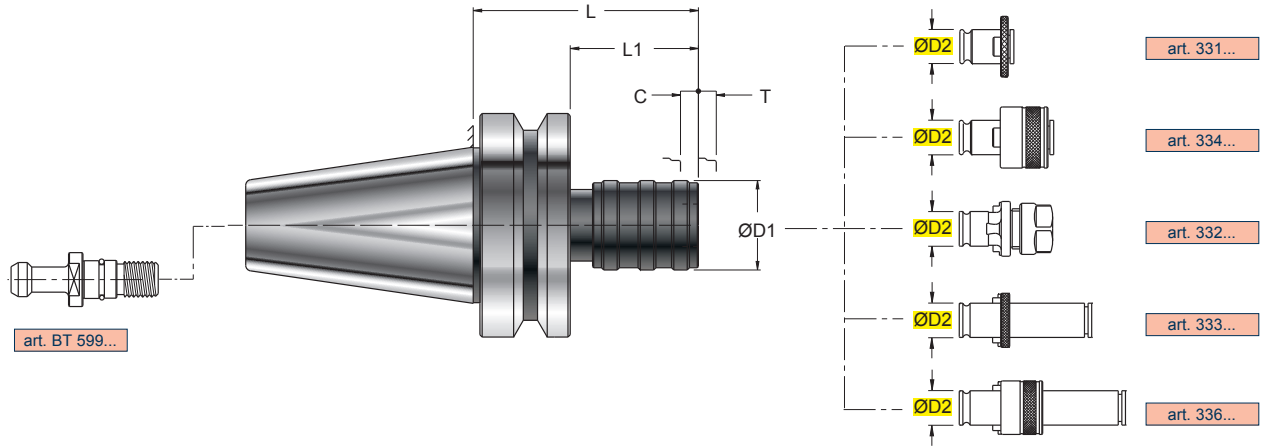

PORTA MASCHIO A CAMBIO RAPIDO CON DOPPIA COMPENSAZIONE
 QUICK-CHANGE TAP HOLDER WITH DOUBLE COMPENSATION
 GEWINDESCHNEID-SCHNELLWECHSELFUTTER MIT DOPPELAUSGLEICH
 MANDRINS DE TARAUDAGE À CHANGEMENT RAPIDE À DOUBLE COMPENSATION

ART.		(mm)						Campo di maschiatura Tap range				
		ØD1	ØD2	L	L1	C	T					
MAS.A40.MC019.068	ISO40	38	19	68	41	9	9	M3-M12				
MAS.A40.MC031.093	ISO40	55	31	93	66	15	15	M8-M24				
MAS.A50.MC019.080	ISO50	38	19	80	42	9	9	M3-M12				
MAS.A50.MC031.102	ISO50	55	31	102	64	15	15	M8-M24				
MAS.A50.MC048.135	ISO50	79	48	135	97	24	24	M16-M36				

ART. MAS.A..MS..
MAS 403 BT/AD

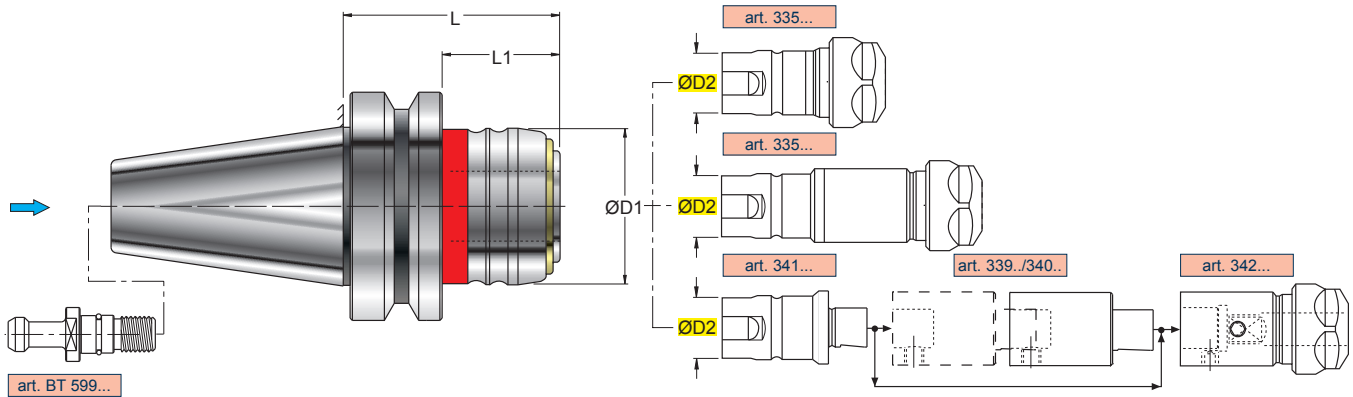

PORTA MASCHIO A CAMBIO RAPIDO PER MASCHIATURA SINCRONIZZATA
 QUICK CHANGE TAP HOLDER FOR SYNCHRONIZED TAPPING
 GEWINDESCHNEID-SCHNELLWECHSELFUTTER ZUM STARREN GEWINDESCHNEIDEN
 APPAREIL PORTE-TARAUDS À CHANGEMENT RAPIDE POUR TARAUDAGE SYNCHRONISÉ

ART.		(mm)				Campo di maschiatura Tap range					
		ISO	ØD1	ØD2	L						
MAS.A40.MS020.061	ISO40	43	20	61	34	M3-M12					
MAS.A40.MS032.082	ISO40	60	32	82	55	M6-M20					
MAS.A50.MS020.072	ISO50	43	20	72	34	M3-M12					
MAS.A50.MS032.093	ISO50	60	32	93	55	M6-M20					

ART. MAS.A..SF..
MAS 403 BT/A

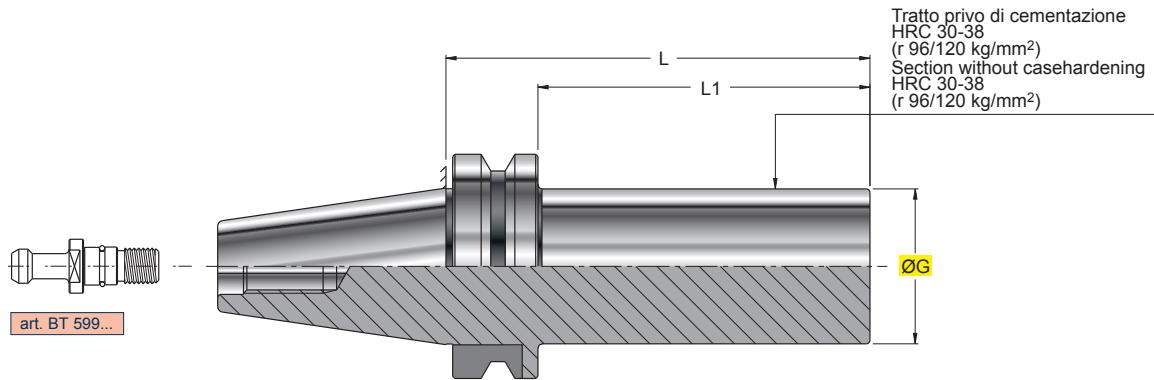

BARRA CON CONO FINITO E STELO TENERO
BORING BARS WITH FINISHED TAPER AND BLANK SCHAFT
ROHLINGE
BARRE AVEC CONE FINI ET BOUT DOUX

ART.	 (mm)								
		ØG	L	L1					
MAS.A40.SF063.177	ISO40	63	177	150					
MAS.A50.SF100.288	ISO50	100	288	250					

ART. MAS.B40.MD..
MAS 403 BT/AD-B

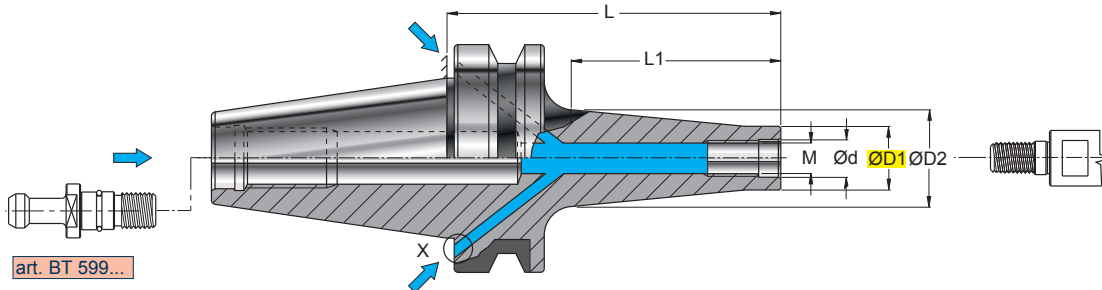

- art. 253..VW
S1089W..
S1503.9W..
S2000.89W..
S613/4.9.45W..
S659W..
S809W..
S849W..
S929..
S959..
S9002.9W..
S9004.9W..
S9005.9W..
S9006.9W..

art. BT 599...

PORTAFRESA CON ATTACCO MODULARE- FILETTATO
CUTTER-HOLDER WITH MODULAR THREADED CONNECTION
FRÄSERAUFNAHME MIT MODULAR-GEWINDEAUFNAHME
MANDRIN PORTE-FRAISE AVEC ATTACHEMENT MODULAIRE FILETÉ

0,005

EQUILIBRATO BALANCED
G6,3 15000 min⁻¹

ART.	 (mm)						
		M	Ød	ØD1	ØD2	L	L1
MAS.B40.MD010.106	ISO40	10	10,5	17,7	28	106	71
MAS.B40.MD012.066	ISO40	12	12,5	20,7	24	66	31
MAS.B40.MD012.106	ISO40	12	12,5	20,7	31	106	71
MAS.B40.MD016.066	ISO40	16	17	28,7	34	66	31
MAS.B40.MD016.086	ISO40	16	17	28,7	34	86	51
MAS.B40.MD016.106	ISO40	16	17	28,7	34	106	71
MAS.B40.MD016.126	ISO40	16	17	28,7	34	126	91
MAS.B40.MD016.185	ISO40	16	17	28,7	34	185	150

ART. MAS.A.. MDV.. MAS 403 BT/A

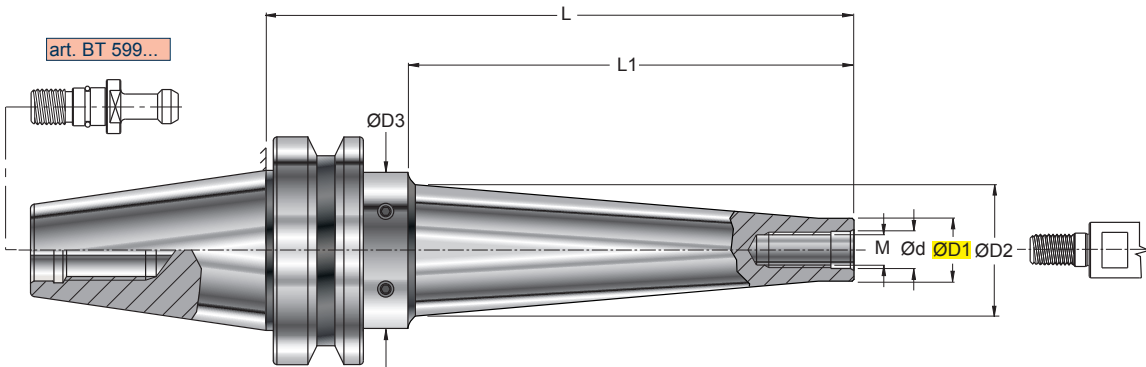

- art. 253..VW
 S1089W..
 S1503.9W..
 S2000.89W..
 S613/4.9.45W..
 S659W..
 S809W..
 S849W..
 S929..
 S959..
 S9002.9W..
 S9004.9W..
 S9005.9W..
 S9006.9W..

PORTAFRESA ANTIVIBRANTE CON ATTACCO MODULARE-FILETTATO
 VIBRATION-DAMPED CUTTER-HOLDER WITH MODULAR THREADED CONNECTION
 SCHWINGUNGSGEDÄMPFTE FRASERAUFNAHME MIT MODULAR-GEWINDEAUFNAHME
 MANDRIN PORTE-FRAISE ANTIVIBRATOIRE AVEC ATTACHEMENT MODULAIRE FILETÉ

PRE-EQUILIBRATO	PRE-BALANCED
	BT40 = G6,3 15000 min ⁻¹
	BT50 = G6,3 10000 min ⁻¹

0,015

ART.		(mm)												
		M	Ød	ØD1	ØD2	ØD3	L	L1		kg				
MAS.A40.MDV010.200	ISO40	10	10,5	18	35	50	200	158	2,00					
MAS.A40.MDV010.250	ISO40	10	10,5	18	40	50	250	208	2,30					
MAS.A40.MDV010.300	ISO40	10	10,5	18	45	50	300	258	2,80					
MAS.A40.MDV012.200	ISO40	12	12,5	21	38	50	200	158	2,00					
MAS.A40.MDV012.250	ISO40	12	12,5	21	43	50	250	208	2,50					
MAS.A40.MDV012.300	ISO40	12	12,5	21	44	50	300	258	3,10					
MAS.A40.MDV016.200	ISO40	16	17,0	29	43	50	200	158	2,50					
MAS.A40.MDV016.250	ISO40	16	17,0	29	44	50	250	208	2,80					
MAS.A40.MDV016.300	ISO40	16	17,0	29	47	50	300	258	3,50					
MAS.A50.MDV012.300	ISO50	12	12,5	21	47	80	300	247	5,90					
MAS.A50.MDV012.400	ISO50	12	12,5	21	57	80	400	347	7,60					
MAS.A50.MDV016.300	ISO50	16	17,0	29	55	80	300	247	6,80					
MAS.A50.MDV016.400	ISO50	16	17,0	29	65	80	400	347	9,00					
MAS.A50.MDV016.500	ISO50	16	17,0	29	76	80	500	447	12,00					

ART. MAS.B..CTS..
MAS 403 BT/AD-B

DIN 69882-8

NEW

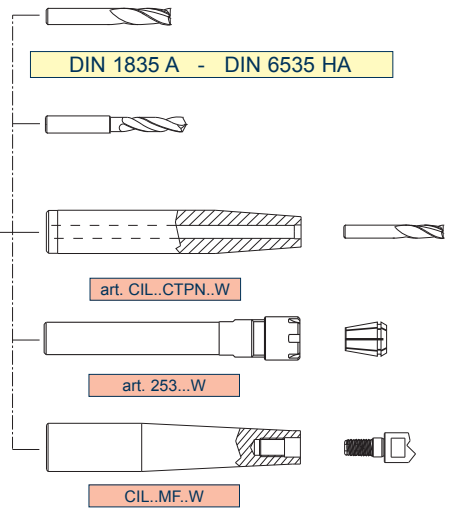
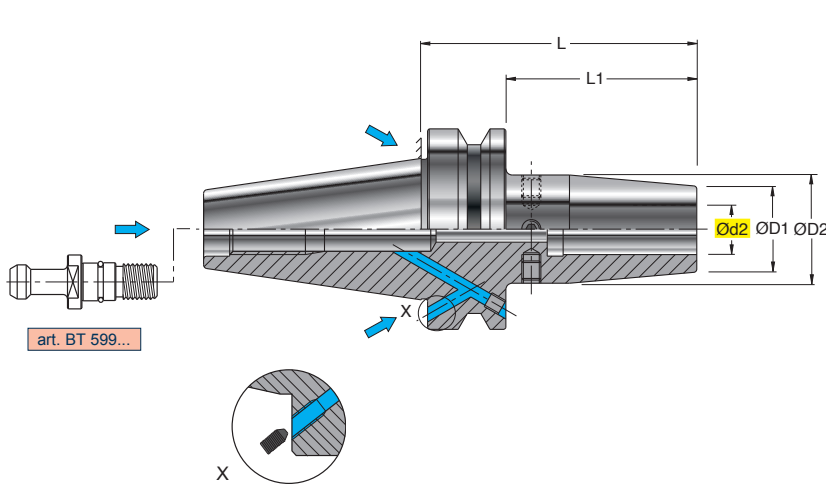

MANDRINO A CALETTAMENTO TERMICO
SHRINKING-ON TAPER SHANKS
WERKZEUGAUFNAHMEN MIT SCHRUMPFVERBINDUNG
MANDRIN À EMBOÏTEMENT TERMIQUE

0,003

EQUILIBRATO
BALANCED
G 2,5 25000 min⁻¹

ART.	(mm)	Ød2	ØD1	ØD2	L	L1
MAS.B40.CTS006.090	ISO40	6	21	27	90	63
MAS.B40.CTS006.130	ISO40	6	21	27	130	103
MAS.B40.CTS006.160	ISO40	6	21	27	160	133
MAS.B40.CTS008.090	ISO40	8	21	27	90	63
MAS.B40.CTS008.130	ISO40	8	21	27	130	103
MAS.B40.CTS008.160	ISO40	8	21	27	160	133
MAS.B40.CTS010.090	ISO40	10	24	32	90	63
MAS.B40.CTS010.130	ISO40	10	24	32	130	103
MAS.B40.CTS010.160	ISO40	10	24	32	160	133
MAS.B40.CTS012.090	ISO40	12	24	32	90	63
MAS.B40.CTS012.130	ISO40	12	24	32	130	103
MAS.B40.CTS012.160	ISO40	12	24	32	160	133
MAS.B40.CTS014.090	ISO40	14	27	34	90	63
MAS.B40.CTS014.130	ISO40	14	27	34	130	103
MAS.B40.CTS014.160	ISO40	14	27	34	160	133
MAS.B40.CTS016.090	ISO40	16	27	34	90	63
MAS.B40.CTS016.130	ISO40	16	27	34	130	103
MAS.B40.CTS016.160	ISO40	16	27	34	160	133
MAS.B40.CTS018.090	ISO40	18	33	42	90	63
MAS.B40.CTS018.130	ISO40	18	33	42	130	103
MAS.B40.CTS018.160	ISO40	18	33	42	160	133
MAS.B40.CTS020.090	ISO40	20	33	42	90	63
MAS.B40.CTS020.130	ISO40	20	33	42	130	103
MAS.B40.CTS020.160	ISO40	20	33	42	160	133
MAS.B40.CTS025.100	ISO40	25	44	53	100	73
MAS.B50.CTS006.100	ISO50	6	21	27	100	62
MAS.B50.CTS006.160	ISO50	6	21	27	160	122
MAS.B50.CTS008.100	ISO50	8	21	27	100	62
MAS.B50.CTS008.160	ISO50	8	21	27	160	122
MAS.B50.CTS010.100	ISO50	10	24	32	100	62
MAS.B50.CTS010.160	ISO50	10	24	32	160	122
MAS.B50.CTS012.100	ISO50	12	24	32	100	62
MAS.B50.CTS012.160	ISO50	12	24	32	160	122
MAS.B50.CTS014.100	ISO50	14	27	34	100	62
MAS.B50.CTS014.160	ISO50	14	27	34	160	122
MAS.B50.CTS016.100	ISO50	16	27	34	100	62
MAS.B50.CTS016.160	ISO50	16	27	34	160	122
MAS.B50.CTS018.100	ISO50	18	33	42	100	62
MAS.B50.CTS018.160	ISO50	18	33	42	160	122
MAS.B50.CTS020.120	ISO50	20	33	42	120	82
MAS.B50.CTS020.160	ISO50	20	33	42	160	122
MAS.B50.CTS025.120	ISO50	25	44	53	120	82
MAS.B50.CTS025.160	ISO50	25	44	53	160	122
MAS.B50.CTS032.120	ISO50	32	44	53	120	82
MAS.B50.CTS032.160	ISO50	32	44	53	160	122

ART. MAS.B..CTPN..
MAS 403 BT/AD-B

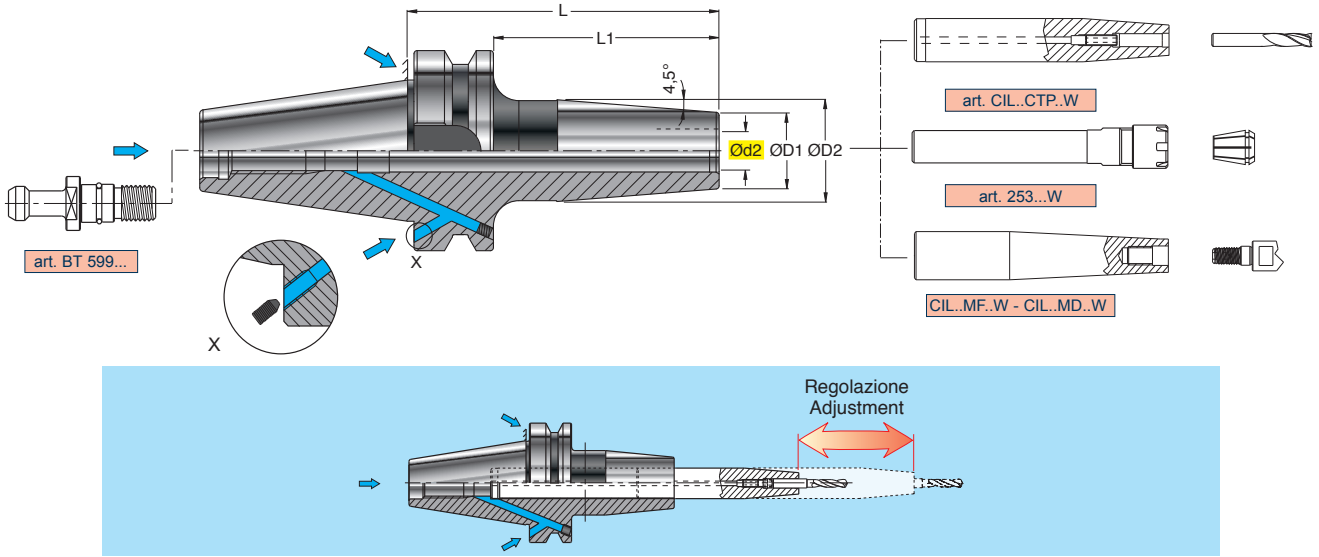

MANDRINO A CALETTAMENTO TERMICO PROLUNGABILE
EXTENSIBLE SHRINK FIT
VERLÄNGERBARES SCHRUMPFUTTER
MANDRIN PROLONGEABLE À EMBOÎTEMENT THERMIQUE.

ART.		(mm)					L	L1					
		ISO	Ød2	ØD1	ØD2								
MAS.B40.CTPN016.090	ISO40	16	27	34	90	63							
MAS.B40.CTPN025.100	ISO40	25	44	53	100	73							
MAS.B50.CTPN016.130	ISO50	16	27	34	130	92							
MAS.B50.CTPN025.130	ISO50	25	44	53	130	92							
MAS.B50.CTPN032.130	ISO50	32	44	53	130	92							

ART. MAS.B..MFSN..
MAS 403 BT/AD-B

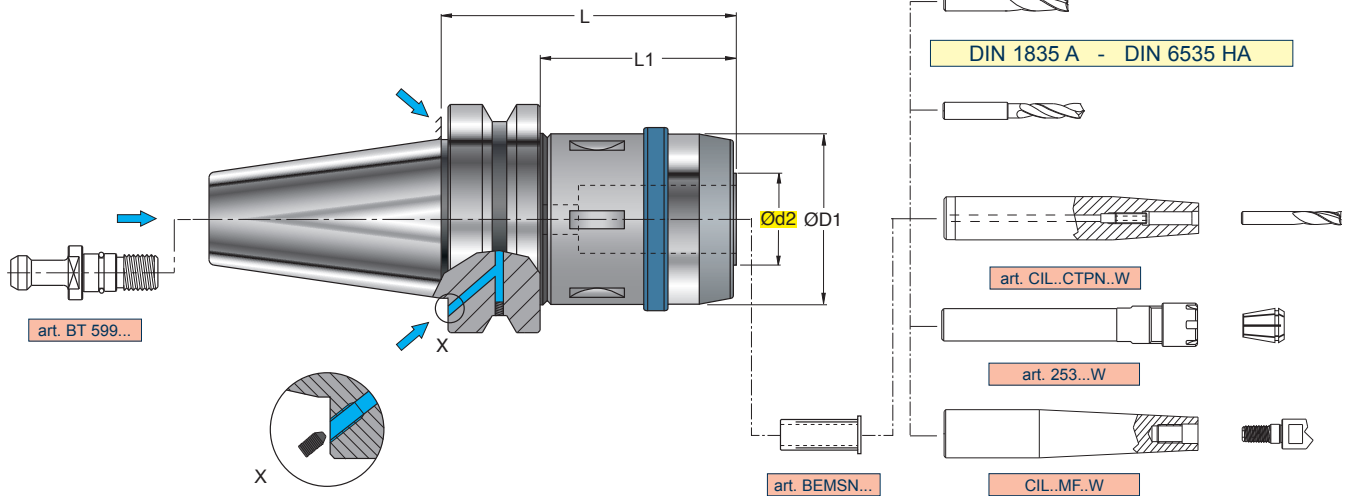

MANDRINO A FORTE SERRAGGIO
HIGH CLAMPING CHUCKS
KRAFTSPANNFUTTER
MANDRIN À FORT SERRAGE

	0,003 2,5 x Ø	EQUILIBRATO BALANCED 	G 2,5 20000 min ⁻¹
	0,004 2,5 x Ø		

ART.		(mm)								
		Ød2	ØD1	L	L1					
MAS.B40.MFSN020.093	ISO40	20	50	93	66	BEMSN.20			925.052	ESMS.010
MAS.B40.MFSN032.092	ISO40	32	67	92	65	BEMSN.32			925.068	ESMS.010
MAS.B50.MFSN020.094	ISO50	20	50	94	56	BEMSN.20			925.052	ESMS.010
MAS.B50.MFSN032.103	ISO50	32	67	103	65	BEMSN.32			925.068	ESMS.010

CARATTERISTICHE TECNICHE - TECHNICAL CHARACTERISTICS

1. Ridotte dimensioni di ingombro (lunghezza e diametro esterno) che consentono una migliore equilibratura (G 2,5 fino a 20000 rpm)
2. Aumento della rigidità del mandrino per una resa migliore in lavorazione
3. Perfetta centratura dell'utensile (0,003/0,004 mm a 2,5xØ) che determinano un incremento della durata degli inserti fino a raddoppiare la durata
4. Aumento della potenza di serraggio Max 1750 Nm
5. Adatto anche per frese con attacco cilindrico, weldon, whistle notch e punte in metallo duro
6. Passaggio del lubrificante attraverso l'utensile fino a 100 bar
7. Serraggio ottimale garantito dall'allineamento delle tacche (ghiera mandrino)

1. Reduced dimensions (length and external diameter) for a better balancing (G 2,5 till to 20000 rpm)
2. High rigidity of the chuck for a better performance
3. Perfect concentricity (0,003/0,004 mm 2,5xØ) for an increase in toolife
4. Increase of tightening force Max 1750 Nm
5. Suitable for endmills tools with cylindrical, weldon and whistle notch shank and for carbide drills
6. Coolant through the tool till 100 bar
7. Best clamping assured by alignment of notches (fixin ring nut/arbor)

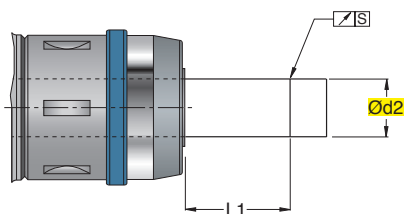

Ød2 (mm)	L1 (mm)	Concentricità "S" Concentricity "S" (mm)	Forza di serraggio Clamping force (Nm)
20	40	0,003	1000
32	64	0,004	1750

PER AVERE UNA TENUTA DEL LUBRIFICANTE FINO A 100 bar BISOGNA ACQUISTARE IL MANDRINO CON ANELLO DI TENUTA. PER ORDINARE TALE MANDRINO, BISOGNA AGGIUNGERE AL CODICE DEL MANDRINO SCELTO UNA "F" FINALE E SPECIFICARLO AL MOMENTO DELL' ORDINE. UTILIZZANDO LE PINZE DI RIDUZIONE CILINDRICHE BISOGNA SOSTITUIRE L'ANELLO DI TENUTA DEL DIAMETRO DELL'UTENSILE PRESCELTO. IL MANDRINO GARANTISCE IL PASSAGGIO DEL LUBRIFICANTE (max 100 bar), SIA CON UTENSILI CALETTATI DIRETTAMENTE SIA CON PINZE DI RIDUZIONE CILINDRICHE BEMSN.. INTERPOSTE.

TO OBTAIN A COOLANT FLOW UP TO 100 bar YOU MUST PURCHASE THE CHUCK WITH SEALING RING. TO ORDER THIS CHUCK YOU MUST ADD A FINAL "F" TO THE SELECTED CHUCK CODE AND SPECIFY IT WHEN PLACING THE ORDER. FOR THE USE OF THE CYLINDRICAL REDUCTION SLEEVES THE SEALING RING MUST BE REPLACED WITH ONE OF THE SAME DIAMETER AS THE TOOL CHOSEN. THE HIGH CLAMPING CHUCK IS SUITABLE FOR A COOLANT FLOW (UP TO 100 bar) BOTH WITH DIRECTLY SHRUNK-ON TOOLS AND WITH BEMS CYLINDRICAL REDUCTION SLEEVES.



ART. MAS.A.. MI.. MAS 403 BT/AD

NEW

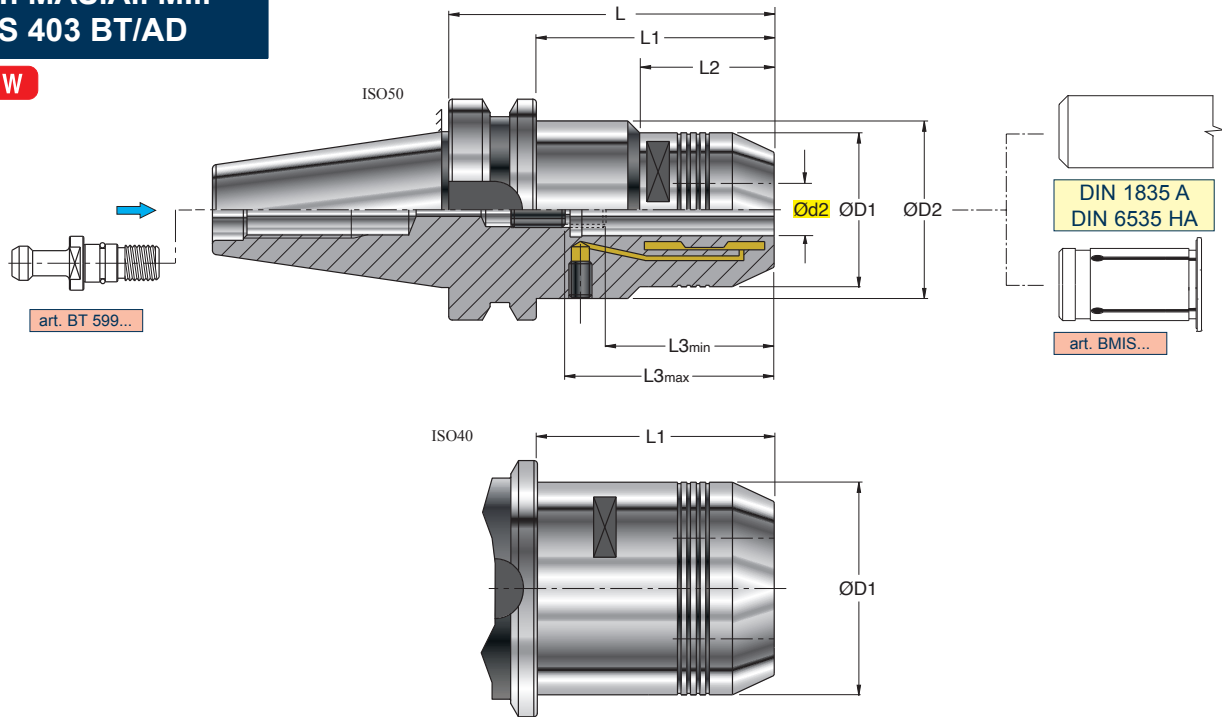

MANDRINO A BLOCCAGGIO IDRAULICO
HYDRAULIC CLAMPING CHUCK
AUFNAHME MIT HYDRODEHNSPANNUNG
MANDRIN AVEC BLOCCAGE HYDRAULIC

0,005 L ≤ 3x d2

EQUILIBRATO
BALANCED
G 2,5 25000 min⁻¹

ART.		(mm)												
		Ød2	ØD1	ØD2	L	L1	L2	L3min	L3max					
MAS.A40.MI020.073	ISO40	20	49,5	-	72,5	45,5	-	42,5	52,5	BMIS 20..				
MAS.A50.MI020.090	ISO50	20	43	50	90	52	32	42,5	52,5	BMIS 20..				

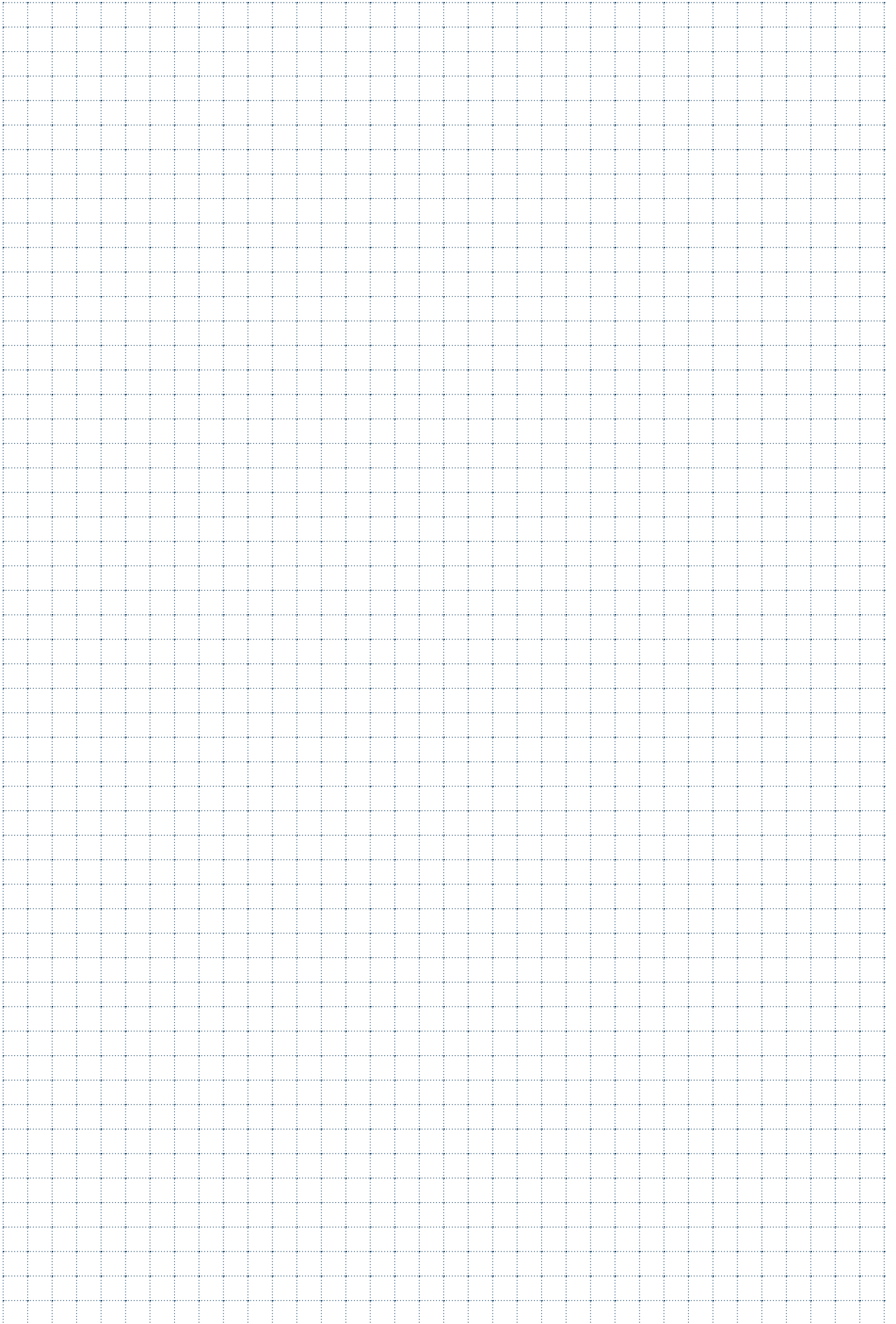

ADATTATORE BASE
- BASIC ADAPTER
- GRUNDAUFNAHMEN
- ADAPTATEUR BASIQUE

HSK..C..
... /AD

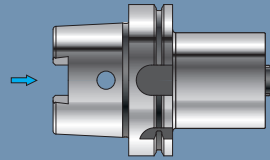

DIN 69893-A HSK

PAG 1036

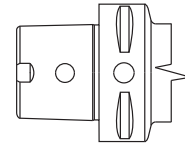

ADATTATORE BASE
- BASIC ADAPTER
- GRUNDAUFNAHMEN
- ADAPTATEUR BASIQUE

370.3..C..
... /AD-B

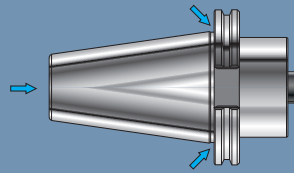

DIN 69871

PAG 1036

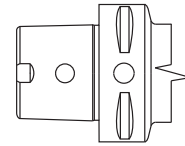

ADATTATORE BASE
- BASIC ADAPTER
- GRUNDAUFNAHMEN
- ADAPTATEUR BASIQUE

370.9..C..
... /AD-B

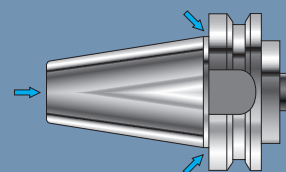

MAS-403-BT

PAG 1036

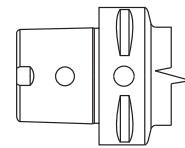

PROLUNGA
- EXTENSION
- VERLÄNGERUNG
- RALLONGE

PSC.C..PRL..
... /A

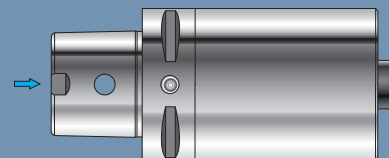

PAG 1037

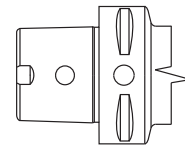

PORTAPUNTA UNIVERSALE
- UNIVERSAL ADAPTER FOR DRILLING TOOLS
- WELDON-AUFNAHME FÜR VOLLBOHRER
- PORTE-FORET UNIVERSEL

PSC.C63.PU..
... /A

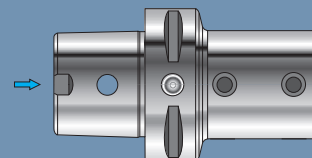

PAG 1037

WHISTLE-NOTCH - DIN1835E - DIN6535HE



ISO 9766



PORTAPINZA STANDARD
- COLLET HOLDER STANDARD
- SPANNFUTTER STANDARD
- MANDRIN PORTE-PINCE STANDARD

PSC.C..ER..
... /A

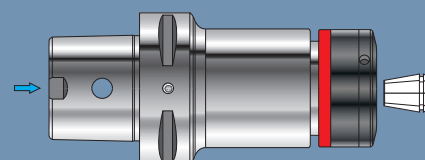

PAG 1038



DIN 1835 A - DIN 6535 HA





PSC.C..FSW..
... /A

ISO 3937

ISO 6462

PORTAFRESA A TRASCINAMENTO FRONTALE CON TENONE

- SHELL END-MILL HOLDERS WITH TENON
- FRÄSERAUFNAHME MIT QUERNUT UND LAPPEN
- PORTE-FRAISE A ENTRAINEMENT FRONTAL AVEC TENON

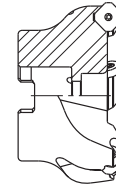
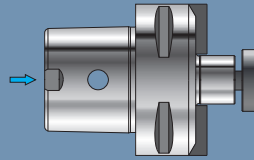

PAG 1038

PSC.C..WE..
... /A

WELDON - DIN1835B - DIN6535HB

MANDRINO PER ATTACCHI TIPO WELDON

- END MILL HOLDER FOR WELDON CONNECTIONS
- WELDON-WERKZEUGAUFNAHME
- MANDRIN POUR ATTACHES TYPE WELDON

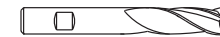
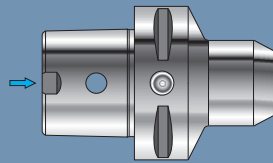

ISO 9766



PAG 1039

PSC.C..MC..
... /A

DIN 1835/B

MASCHIATORI A CAMBIO RAPIDO CON COMPENSAZIONE ASSIALE

- TAPPING CHUCK WITH AXIAL COMPENSATION
- GEWINDESCHNEIDFUTTER MIT DOPPEL LÄNGENAUSGLEICH
- APPAREILS À TARAUDER AVEC COMPENSATION AXIALE

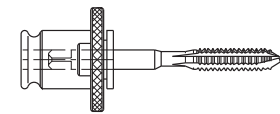
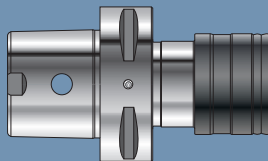

PAG 1039

PSC.C..MS..
... /A

DIN 1835/B

MASCHIATORI PER MASCHIATURA SINCRONIZZATA

- TAPPING CHUCKS FOR SYNCHRONIZED TAPPING
- GEWINDESCHNEIDER FÜR STARRES GEWINDESCHNEIDEN
- APPAREIL À TARAUDER POUR TARAUDAGE SYNCHRONISÉ

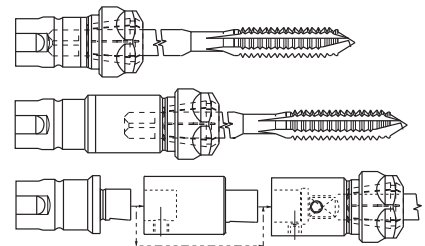
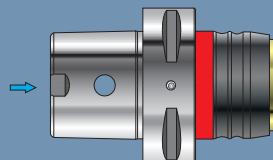

PAG 1040

PSC.C..SF..
... /A

BARRA CON CONO FINITO E STELO TENERO

- BORING BARS WITH FINISHED TAPER AND BLANK SHAFT
- ROHLINGE
- BARRE AVEC CONE FINI ET BOUT DOUX

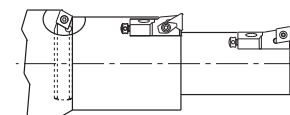
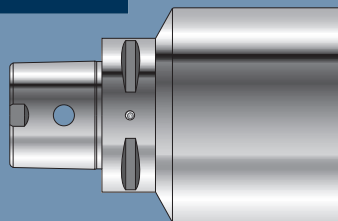

PAG 1040

PSC.C..CTS..
... /A

NEW

MANDRINO A CALETTAMENTO TERMICO

- SHRINKING-ON TAPER SHANKS
- WERKZEUGAUFNAHMEN MIT SCHRUMPFVERBINDUNG
- MANDRIN À EMBOÏTEMENT THERMIQUE

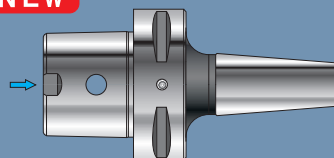

DIN 1835 A - DIN 6535 HA



PAG 1041

MANDRINO A FORTE SERRAGGIO
- HIGH CLAMPING CHUCK
- KRAFTSPANNFUTTER
- MANDRIN À SERRAGE FORT

PSC.C63.MFSN..
... /A

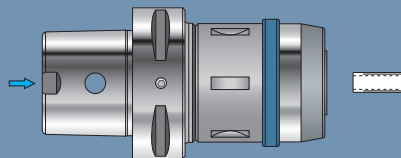

PAG 1042

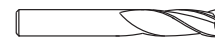

DIN 1835 A - DIN 6535 HA



ADATTATORE PER UTENSILI A STELO QUADRO
- ADAPTOR FOR SHANK TOOL
- ADAPTER FÜR SCHAFT WERKZEUGE
- ADAPTATEUR POUR OUTIL À MANCHE

PSC.C63.1PAR/L..
... /A

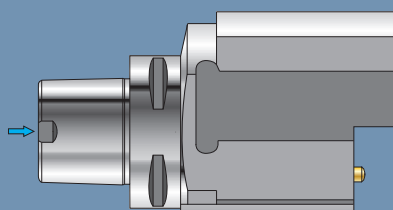

PAG 1043



ADATTATORE PER UTENSILI A STELO QUADRO A 45°
- ADAPTOR FOR SHANK TOOL 45°
- ADAPTER FÜR SCHAFT WERKZEUGE 45°
- ADAPTATEUR POUR OUTIL À MANCHE 45°

PSC.C63.U45..
... /A

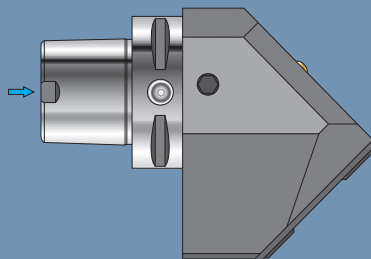

PAG 1043



ISO 26623-1
 ART. PSC.C63.MFSV
 ISO 26623-1/A

MANDRINO A FORTE SERRAGGIO
 HIGH CLAMPING CHUCK
 HOCHDRUCKHALTER
 MANDRIN À SERRAGE CDT

ART	ØD2	ØD1	ØD2	L	L1	SEMPL.	ISO 2100
1000000000	20	25	25	50	50	SEMPL.	1000000000
1000000000	32	32	32	80	80	SEMPL.	1000000000

CARATTERISTICHE TECNICHE - TECHNICAL CHARACTERISTICS

1. Minimo diametro di ingombro (lunghezza e diametro esterno) che consentano una migliore equilibratura (Ø 2,5 fino a 20000 rpm)
 2. Aumento della rigidità del mandrino per una resa migliore in lavorazione
 3. Profilo superiore ad U con un raggio Ø 0,025 (da 2 a 2,5) che determinano un incremento della durata degli inserti fino a raddoppiare la durata
 4. Aumento della potenza di serraggio Max 1700 Nm
 5. Punta anche nel caso con attacco cilindrico, rettilo, wheel, wheel notch e punta in metallo duro
 6. Foraggi di lubrificante opzionali (velocità fino a 100 bar)

1. Minimal dimensions (length and external diameter) for a better balancing (Ø 2.5 till to 20000 rpm)
 2. High rigidity of the chuck for a better performance
 3. U-shaped top profile (Ø 0.025 (2 to 2.5)) for an increase in tool life
 4. Increase of gripping force (max 1700 Nm)
 5. Suitable for extreme tools with cylindrical, reticul and wheel notch shank and for carbide bits
 6. Coated through the tool till 100 bar

ØD2	L1	Concentricità "S" Concentricity "S"	Forza di serraggio Clamping Force (Nm)
20	50	0.003	1000
32	80	0.004	1750

PER AVERE UNA TENUTA DEL LUBRIFICANTE FINO A 100 bar BISOGNA ACQUISTARE IL MANDRINO CON ANELLO DI TENUTA. PER OTTENERE IL MANDRINO BISOGNA RISPONDERE AL CODICE DEL MANDRINO SELETO USA "9" FINALE E SPECIFICARE IL MOMENTO DELL'ORIGINE UTILIZZANDO LE PUNTE DI RIDUZIONE CILINDRICHE BISOGNA SOTTILINARE L'ANNO DI FONDAZIONE DEL VENDITORE PRECEDUTO DA MANDRINO GARANTITE E FORGIATO DEL LUBRIFICANTE 100 bar, SIA CON UTENSILI CALZATI DIRETTAMENTE SIA CON PUNTE DI RIDUZIONE CILINDRICHE BESS. INTERI

TO OBTAIN COOLANT FLOW UP TO 100 bar YOU MUST PURCHASE THE CHUCK WITH SEALING RING. TO OBTAIN THE CHUCK YOU MUST ANSWER TO THE CHUCK CODE AND SPECIFY IT WHEN PLACING THE ORDER. FOR THE USE OF THE CYLINDRICAL REDUCERS BELIEVES THE SEALING RING MUST BE REPLACED WITH ONE OF THE SAME CALIBER AS THE TOOL CHOSEN. THE HIGH CLAMPING CHUCK IS SUITABLE FOR A COOLANT FLOW (UP TO 100 bar) BOTH WITH DIRECTLY DRINKING TOOL AND WITH BESS CYLINDRICAL REDUCERS BELIEVES.

970



- 1 = NORMA ATTACCO
- 2 = NORMA PARTE ANTERIORE
- 3 = ACCESSORI OPZIONALI A RICHIESTA
- 4 = CARATTERISTICHE TECNICHE
- 5 = ARTICOLO
- 6 = MISURE, DATI, INDICAZIONI
- 7 = ACCESSORI E RICAMBI IN DOTAZIONE
- 8 = ACCESSORI E RICAMBI OPZIONALI A RICHIESTA
- 9 = NOTE E AVVERTIMENTI



- 1 = SHANK STANDARD
- 2 = TOOL-HOLDER STANDARD
- 3 = OPTIONAL ACCESSORIES ON REQUEST.
- 4 = TECHNICAL FEATURES
- 5 = ITEM
- 6 = MEASURES, DATA, INDICATIONS
- 7 = ACCESSORIES AND SPARE PARTS EQUIPMENT
- 8 = OPTIONAL ACCESSORIES AND SPARE PARTS ON REQUEST
- 9 = NOTES AND WARNINGS



- 1 = KEGEL-NORM
- 2 = AUFNAHME-NORM
- 3 = OPTIONALZUBEHÖR AUF ANFRAGE
- 4 = TECHNISCHE HAUPTMERKMALE
- 5 = ARTKEL
- 6 = ABMESSUNGEN, DATEN, HINWEISE
- 7 = ZUBEHÖR UND ERSATZTEIL AUSSTATTUNG
- 8 = OPTIONALZUBEHÖR UND -ERSATZTEILE AUF ANFRAGE
- 9 = ANMERKUNGEN UND HINWEISE



- 1 = NORMES POUR ATTACHEMENT
- 2 = NORME POUR MANDRIN
- 3 = ACCESSOIRES OPTIONNELS SUR DEMANDE
- 4 = CARACTERISTIQUES TECHNIQUES
- 5 = ARTICLE
- 6 = DIMENSIONS, DONNÉES, INDICATIONS
- 7 = ACCESSOIRES ET RECHANGE EN DOTATION
- 8 = ACCESSOIRES ET RECHANGES OPTIONNELS SUR DEMANDE
- 9 = NOTES ET AVERTISSEMENTS

**ART. HSK..C..
HSK - AD (DIN 69893)**

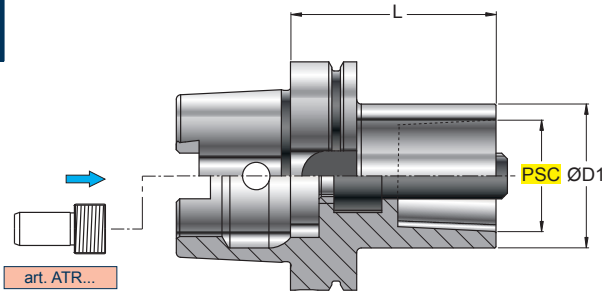

ADATTATORE BASE
BASIC ADAPTER
GRUNDAUFNAHMEN
ADAPTATEUR BASIQUE

PRE-EQUILIBRATO PRE-BALANCED
G 6,3 8000 min⁻¹

ART.		(mm)							
		PSC	ØD1	L					
HSK.063.C63.110	HSK63	PSC63	63	110					
HSK.100.C63.090	HSK100	PSC63	63	090					

**ART. 370.3..C..
DIN 69871/AD-B**

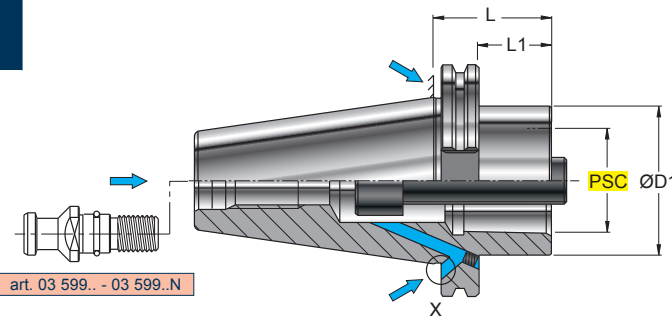

ADATTATORE BASE
BASIC ADAPTER
GRUNDAUFNAHMEN
ADAPTATEUR BASIQUE

PRE-EQUILIBRATO PRE-BALANCED
G 6,3 8000 min⁻¹

ART.		(mm)							
		PSC	ØD1	L	L1				
370.350.C40.030	ISO50	PSC40	40	30	10,9				
370.350.C50.030	ISO50	PSC50	50	30	10,9				
370.350.C63.050	ISO50	PSC63	63	50	31				

**ART. 370.9..C..
MAS 403 BT/A-AD**

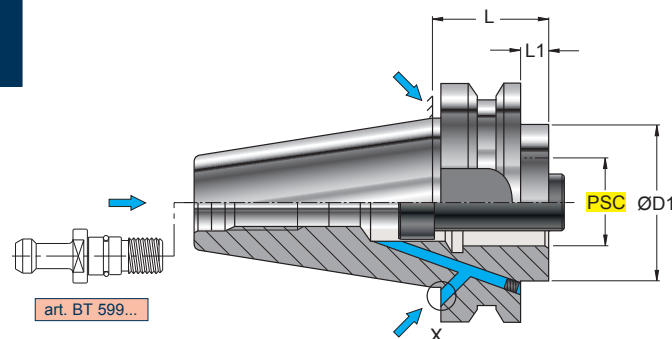

ADATTATORE BASE
BASIC ADAPTER
GRUNDAUFNAHMEN
ADAPTATEUR BASIQUE

PRE-EQUILIBRATO PRE-BALANCED
G 6,3 8000 min⁻¹

ART.		(mm)							
		PSC	ØD1	L	L1				
370.940.C40.030	ISO40	PSC40	40	30	3				
370.950.C50.040	ISO50	PSC50	50	40	2				
370.950.C63.090	ISO50	PSC63	63	90	52				

ART. PSC.C..PRL..
ISO 26623-1/A

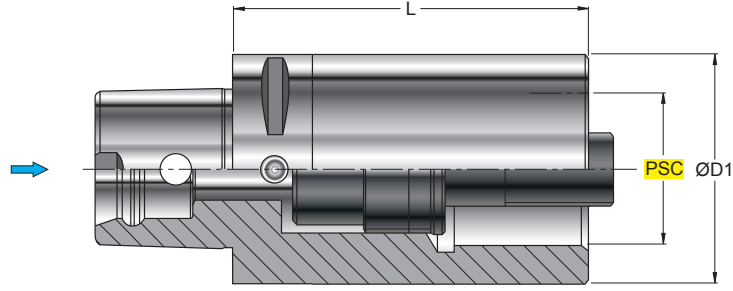

PROLUNGA
EXTENSION
VERLÄNGERUNG
RALLONGE

PRE-EQUILIBRATO PRE-BALANCED
G 6,3 8000 min⁻¹

ART.		(mm)								
		PSC	ØD1	L						
PSC.C40.PRL40.060	PSC40	PSC40	40	60						
PSC.C50.PRL50.080	PSC50	PSC50	50	80						
PSC.C63.PRL63.100	PSC63	PSC63	63	100						

ART. PSC.C63.PU..
ISO 26623-1/A

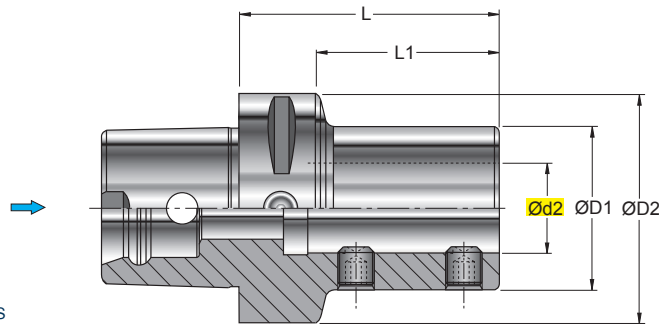

PORTAPUNTA UNIVERSALE
UNIVERSAL ADAPTER FOR DRILLING TOOLS
WELDON-AUFNAHME FÜR VOLLBOHRER
PORTE-FORET UNIVERSEL

PRE-EQUILIBRATO PRE-BALANCED
G 6,3 8000 min⁻¹

ART.		(mm)									
		Ød2	ØD1	ØD2	L	L1					
PSC.C63.PU016.070	PSC63	16	36	63	70	41					
PSC.C63.PU020.070	PSC63	20	40	63	70	42					
PSC.C63.PU025.072	PSC63	25	45	63	72	48					
PSC.C63.PU032.075	PSC63	32	52	63	75	50					



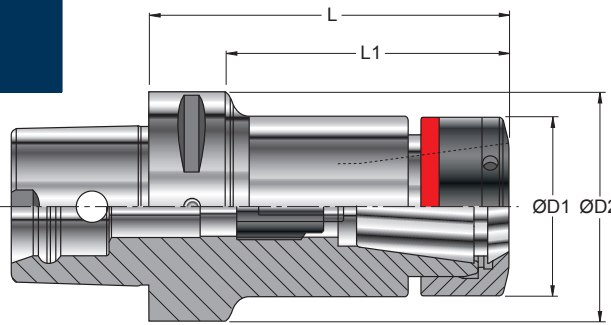

**ART. PSC.C..ER..
ISO 26623-1/A**



PRE-EQUILIBRATO PRE-BALANCED
G 6,3 8000 min⁻¹

PORTAPINZA STANDARD
COLLET HOLDER STANDARD
SPANNFUTTER STANDARD
MANDRIN PORTE-PINCE STANDARD

art. 228..
228Q.. (Reccomended)
230..
230QN..
328..
330..
329..
235..

ART.	 (mm)	Ød	ØD1	ØD2	L	L1							
PSC.C40.ER016.070	PSC40	0,5-10	28	40	70	44	-.016.-.-	RGC ER16	925.022				
PSC.C40.ER025.052	PSC40	0,5-16	40	40	52	52	-.025.-.-	RGC ER25	925.040				
PSC.C50.ER032.057	PSC50	2,5-20	50	50	57	57	-.032.-.-	RGC ER32	925.052				
PSC.C63.ER016.100	PSC63	0,5-10	28	63	100	60	-.016.-.-	RGC ER16	925.022				
PSC.C63.ER025.060	PSC63	0,5-16	40	63	60	33	-.025.-.-	RGC ER25	925.040				
PSC.C63.ER025.100	PSC63	0,5-16	40	63	100	75	-.025.-.-						
PSC.C63.ER032.060	PSC63	2,5-20	50	63	60	35	-.032.-.-	RGC ER32	925.052				
PSC.C63.ER032.100	PSC63	2,5-20	50	63	100	75	-.032.-.-						
PSC.C63.ER040.065	PSC63	3-30	63	63	65	65	-.040.-.-	RGC ER40	925.068				
PSC.C63.ER040.130	PSC63	3-30	63	63	130	130	-.040.-.-						

**ART. PSC.C..FSW..
ISO 26623-1/A**

ISO 3937

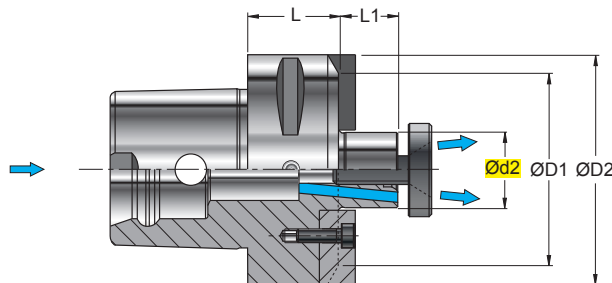

PORTAFRESA A TRASCINAMENTO FRONTALE CON TENONE
SHELL END-MILL HOLDERS WITH TENON
FRÄSERAUFNAHME MIT QUERNUT UND LAPPEN
PORTE-FRAISE A ENTRAÎNEMENT FRONTAL AVEC TENON

PRE-EQUILIBRATO PRE-BALANCED
G 6,3 8000 min⁻¹

ART.	 (mm)	Ød2	ØD1	ØD2	L	L1							
PSC.C40.FSW016.032	PSC40	16	32	40	32	11							
PSC.C50.FSW022.025	PSC50	22	50	50	25	16							
PSC.C50.FSW027.025	PSC50	27	56	50	25	18							
PSC.C63.FSW016.040	PSC63	16	32	63	40	11							
PSC.C63.FSW022.025	PSC63	22	55	63	25	16							
PSC.C63.FSW027.025	PSC63	27	63	63	25	18							

ART. PSC.C..WE..
ISO 26623-1/A

PRE-EQUILIBRATO PRE-BALANCED
G 6,3 8000 min⁻¹

MANDRINO PER ATTACCHI TIPO WELDON
END MILL HOLDER FOR WELDON CONNECTION
WELDON-WERKZEUGAUFNAHME
MANDRIN POUR ATTACHES TYPE WELDON

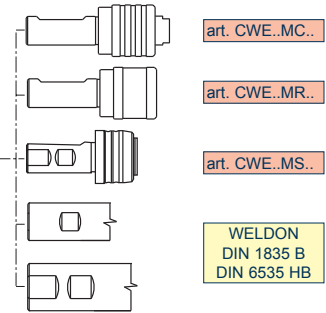
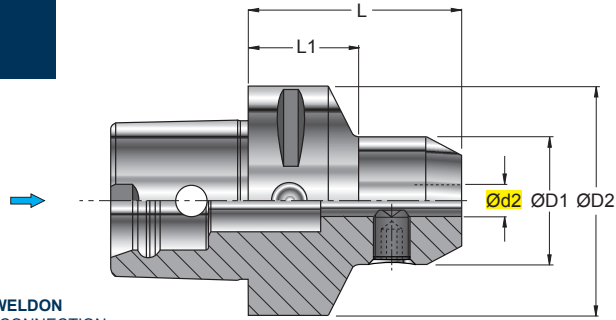

ART.	 (mm)	Ød2	ØD1	ØD2	L	L1					
PSC.C40.WE008.050	PSC40	8	28	40	50	26					
PSC.C40.WE010.051	PSC40	10	35	40	51	29					
PSC.C50.WE006.050	PSC50	6	25	50	50	25,5					
PSC.C50.WE008.050	PSC50	8	28	50	50	26					
PSC.C50.WE010.055	PSC50	10	35	50	55	27,5					
PSC.C50.WE012.060	PSC50	12	42	50	60	36					
PSC.C50.WE016.060	PSC50	16	48	50	60	39					
PSC.C50.WE020.060	PSC50	20	52	50	60	40					
PSC.C50.WE025.080	PSC50	25	64	50	80	60					
PSC.C63.WE006.055	PSC63	6	25	63	55	25					
PSC.C63.WE008.055	PSC63	8	28	63	55	26					
PSC.C63.WE010.060	PSC63	10	35	63	60	30					
PSC.C63.WE012.060	PSC63	12	42	63	60	33					
PSC.C63.WE014.060	PSC63	14	44	63	60	33,5					
PSC.C63.WE016.065	PSC63	16	48	63	65	35,5					
PSC.C63.WE020.065	PSC63	20	52	63	65	37,5					
PSC.C63.WE025.080	PSC63	25	64	63	80	80					
PSC.C63.WE032.090	PSC63	32	72	63	90	90					

ART. PSC.C..MC..
ISO 26623-1/A

MASCHIATORI A CAMBIO RAPIDO CON COMPENSAZIONE ASSIALE
TAPPING CHUCK WITH AXIAL COMPENSATION
GEWINDESCHNEIDFUTTER MIT DOPPEL LÄNGENAUSGLEICH
APPAREILS À TARAUDER AVEC COMPENSATION AXIALE

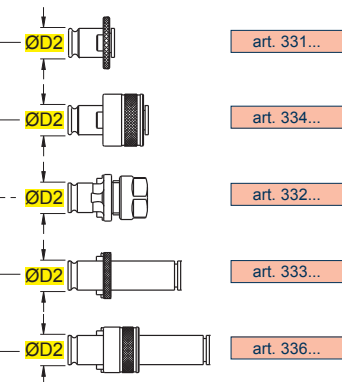
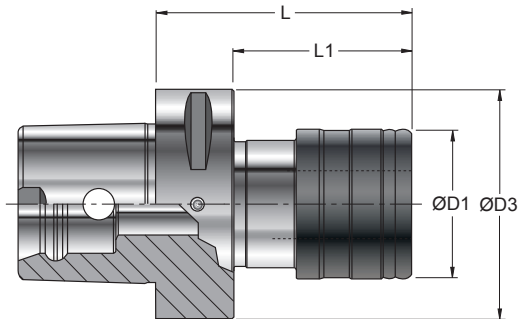

ART.	 (mm)	ØD1	ØD2	ØD3	L	L1	Campo di maschiatura Tap range				
PSC.C40.MC019.068	PSC40	41	19	40	68	48	M3-M12				
PSC.C40.MC031.091	PSC40	60	31	40	91	71	M8-M24				
PSC.C50.MC019.068	PSC50	41	19	50	68	48	M3-M12				
PSC.C50.MC031.091	PSC50	60	31	50	91	71	M8-M24				
PSC.C63.MC019.073	PSC63	41	19	63	73	51	M3-M12				
PSC.C63.MC031.097	PSC63	60	31	63	97	75	M8-M24				

ART. PSC.C..MS..
ISO 26623-1/A

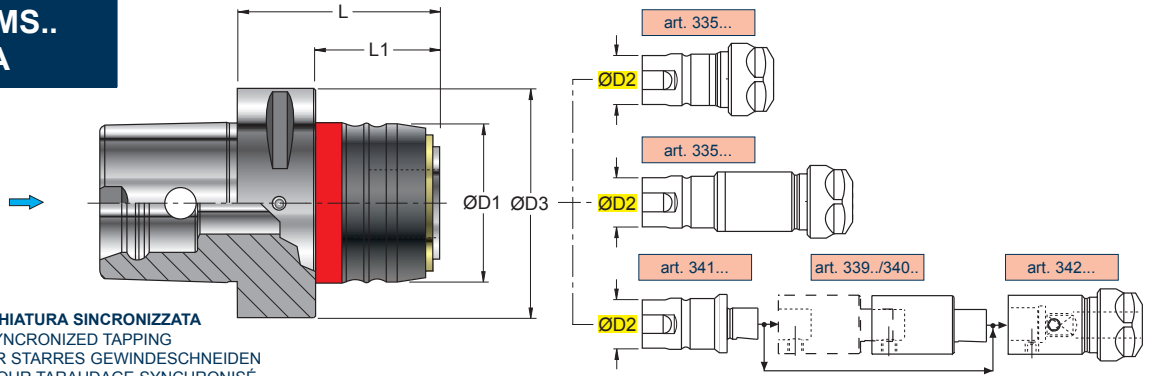

MASCHIATORI PER MASCHIATURA SINCRONIZZATA
TAPPING CHUCKS FOR SYNCRONIZED TAPPING
GEWINDESCHNEIDER FÜR STARRES GEWINDESCHNEIDEN
APPAREIL À TARAUDER POUR TARAUDAGE SYNCHRONISÉ

ART.		(mm)					Campo di maschiatura Tap range					
		ØD1	ØD2	ØD3	L	L1						
PSC.C40.MS020.055	PSC40	43	20	40	55	35	M3-M12					
PSC.C40.MS032.075	PSC40	60	32	40	75	55	M6-M20					
PSC.C50.MS020.055	PSC50	43	20	50	55	35	M3-M12					
PSC.C50.MS032.075	PSC50	60	32	50	75	55	M6-M20					
PSC.C63.MS020.057	PSC63	43	20	63	57	35	M3-M12					
PSC.C63.MS032.077	PSC63	60	32	63	77	55	M6-M20					

ART. PSC.C..SF..
ISO 26623-1/A

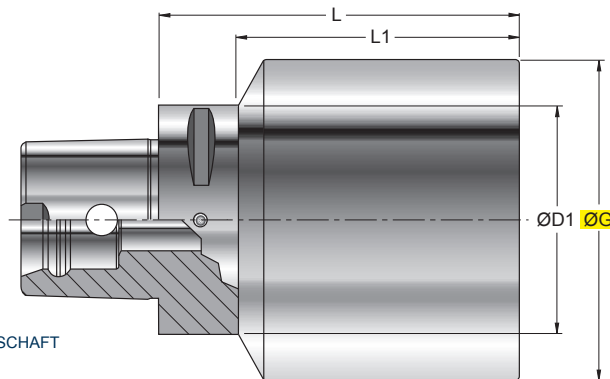

BARRA CON CONO FINITO E STELO TENERO
BORING BARS WITH FINISHED TAPER AND BLANK SCHAFT
ROHLINGE
BARRÉ AVEC CONE FINI ET BOUT DOUX

ART.		(mm)									
		ØG	ØD1	L	L1						
PSC.C40.SF063.165	PSC40	63	40	165	145						
PSC.C50.SF050.150	PSC50	50	50	150	130						
PSC.C63.SF063.180	PSC63	63	63	180	158						

NEW

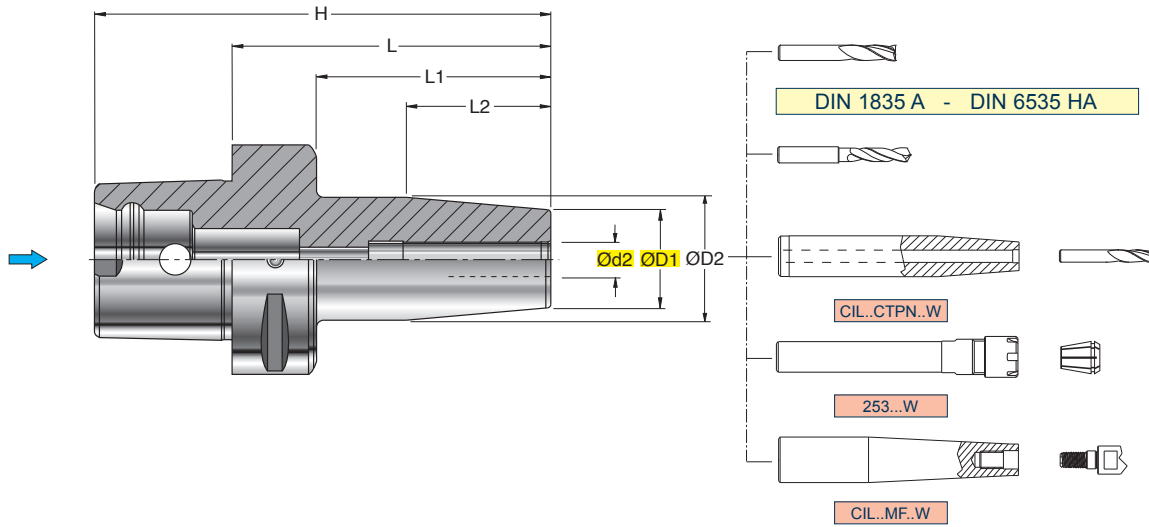

MANDRINO A CALETTAMENTO TERMICO
SHRINKING-ON TAPER SHANKS
WERKZEUGAUFNAHMEN MIT SCHRUMPFVERBINDUNG
MANDRIN À EMBÔTEMENT THERMIQUE

0,003

EQUILIBRATO
BALANCED
G 2,5 25000 min⁻¹

ART.		(mm)											
		Ød2	ØD1	ØD2	H	L	L1	L2					
PSC.C63.CTS003.080	PSC63	3	10	16	118	80	58	14					
PSC.C63.CTS004.080	PSC63	4	12	20	118	80	58	17					
PSC.C63.CTS005.080	PSC63	5	12	20	118	80	58	20					
PSC.C63.CTS006.080	PSC63	6	20	26	118	80	58	36					
PSC.C63.CTS008.080	PSC63	8	20	26	118	80	58	36					
PSC.C63.CTS010.080	PSC63	10	24	32	118	80	58	42					
PSC.C63.CTS012.080	PSC63	12	24	32	118	80	58	47					
PSC.C63.CTS014.085	PSC63	14	27	34	123	85	63	47					
PSC.C63.CTS016.085	PSC63	16	27	34	123	85	63	50					
PSC.C63.CTS018.085	PSC63	18	33	42	123	85	63	52					
PSC.C63.CTS020.085	PSC63	20	33	42	123	85	63	52					
PSC.C63.CTS025.090	PSC63	25	44	53	128	90	68	58					
PSC.C80.CTS010.090	PSC80	10	24	32	138	90	60	42					
PSC.C80.CTS012.090	PSC80	12	24	32	138	90	60	47					
PSC.C80.CTS016.095	PSC80	16	27	34	143	95	65	50					
PSC.C80.CTS020.095	PSC80	20	33	42	143	95	65	52					
PSC.C80.CTS025.100	PSC80	25	44	53	148	100	70	58					

ART. PSC.C63.MFSN..
ISO 26623-1/A

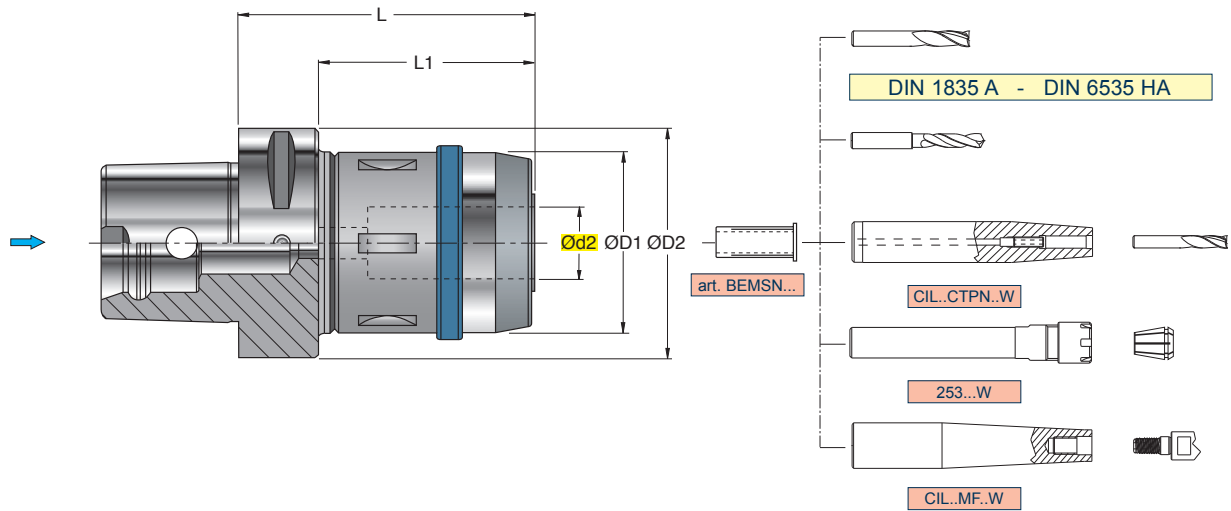

MANDRINO A FORTE SERRAGGIO
HIGH CLAMPING CHUCK
KRAFTSPANNFUTTER
MANDRIN À SERRAGE FORT

	0,003 2,5 x Ø
	0,004 2,5 x Ø

PRE-EQUILIBRATO	PRE-BALANCED
	G 2,5 20000 min ⁻¹

ART.	(mm)	Ød2	ØD1	ØD2	L	L1			
PSC.C63.MFSN020.080	PSC63	20	50	63	80	58	BEMSN.20		925.052 ESMS.010
PSC.C80.MFSN032.100	PSC80	32	67	63	100	78	BEMSN.32		925.068 ESMS.010

CARATTERISTICHE TECNICHE - TECHNICAL CHARACTERISTICS

- Ridotte dimensioni di ingombro (lunghezza e diametro esterno) che consentono una migliore equilibratura (G 2,5 fino a 20000 rpm)
- Aumento della rigidità del mandrino per una resa migliore in lavorazione
- Perfetta centratura dell'utensile (0,003/0,004 mm a 2,5xØ) che determinano un incremento della durata degli inserti fino a raddoppiare la durata
- Aumento della potenza di serraggio Max 1750 Nm
- Adatto anche per frese con attacco cilindrico, weldon, whistle notch e punte in metallo duro
- Passaggio del lubrificante attraverso l'utensile fino a 100 bar
- Serraggio ottimale garantito dall'allineamento delle tacche (ghiera mandrino)

- Reduced dimensions (length and external diameter) for a better balancing (G 2,5 till to 20000 rpm)
- High rigidity of the chuck for a better performance
- Perfect concentricity (0,003/0,004 mm 2,5xØ) for an increase in toollife
- Increase of tightening force Max 1750 Nm
- Suitable for endmills tools with cylindrical, weldon and whistle notch shank and for carbide drills
- Coolant through the tool till 100 bar
- Best clamping assured by alignment of notches (fixin ring nut/arbor)

	Ød2 (mm)	L1 (mm)	Concentricità "S" Concentricity "S" (mm)	Forza di serraggio Clamping force (Nm)
	20	40	0,003	1000
	32	64	0,004	1750

PER AVERE UNA TENUTA DEL LUBRIFICANTE FINO A 100 bar BISOGNA ACQUISTARE IL MANDRINO CON ANELLO DI TENUTA. PER ORDINARE TALE MANDRINO, BISOGNA AGGIUNGERE AL CODICE DEL MANDRINO SCELTO UNA "F" FINALE E SPECIFICARLO AL MOMENTO DELL' ORDINE. UTILIZZANDO LE PINZE DI RIDUZIONE CILINDRICHE BISOGNA SOSTITUIRE L'ANELLO DI TENUTA DEL DIAMETRO DELL'UTENSILE PRESCELTO. IL MANDRINO GARANTISCE IL PASSAGGIO DEL LUBRIFICANTE (max 100 bar), SIA CON UTENSILI CALETTATI DIRETTAMENTE SIA CON PINZE DI RIDUZIONE CILINDRICHE BEMS.. INTERPOSTE.

TO OBTAIN A COOLANT FLOW UP TO 100 bar YOU MUST PURCHASE THE CHUCK WITH SEALING RING. TO ORDER THIS CHUCK YOU MUST ADD A FINAL "F" TO THE SELECTED CHUCK CODE AND SPECIFY IT WHEN PLACING THE ORDER. FOR THE USE OF THE CYLINDRICAL REDUCTION SLEEVES THE SEALING RING MUST BE REPLACED WITH ONE OF THE SAME DIAMETER AS THE TOOL CHOSEN. THE HIGH CLAMPING CHUCK IS SUITABLE FOR A COOLANT FLOW (UP TO 100 bar) BOTH WITH DIRECTLY SHRUNK-ON TOOLS AND WITH BEMS CYLINDRICAL REDUCTION SLEEVES.



PAG 1088

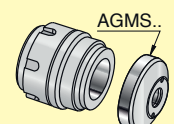

ART. PSC.C63.1PA..
ISO 26623-1/A

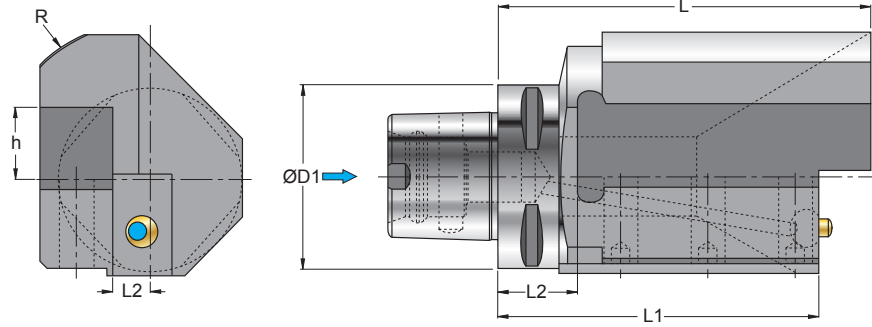

ADATTATORE PER UTENSILI A STELO QUADRO
ADAPTOR FOR SHANK TOOL
ADAPTER FÜR SCHAFT WERKZEUGE
ADAPTATEUR POUR OUTIL À MANCHE

ART.	(mm)								
		ØD1	L	L1	L2	R	f	h	
PSC.C63.1PAL.25.163	PSC63	63	130	112	28	55	13	25	
PSC.C63.1PAR.25.163	PSC63	63	130	112	28	55	13	25	

ART. PSC.C63.U45..
ISO 26623-1/A

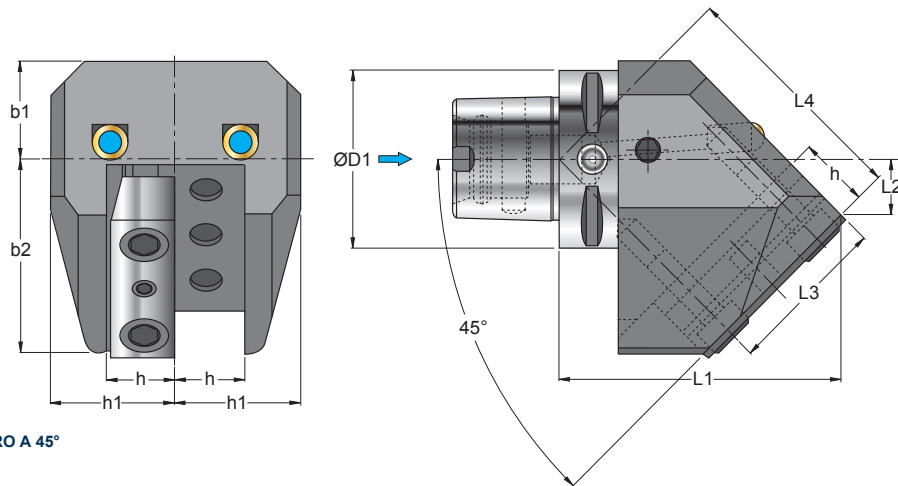

ADATTATORE PER UTENSILI A STELO QUADRO A 45°
ADAPTOR FOR SHANK TOOL 45°
ADAPTER FÜR SCHAFT WERKZEUGE 45°
ADAPTATEUR POUR OUTIL À MANCHE 45°

ART.	(mm)									
		ØD1	b1	b2	h	h1	L1	L2	L3	L4
PSC.C63.U45.25102	PSC63	63	35	70	25	45	102	20	58	86



ADUTTORE REFRIGERANTE PER MANDRINI HSK

- COOLANT FEED FOR HSK CHUCK
- KÜHLMITTELZUFUHR FÜR HSK-AUFNAHME
- ABDUCTEUR DU RÉFRIGÉRANTE POUR MANDRINS HSK

ATR..

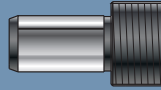

PAG 1056

DIN 69893 - HSK

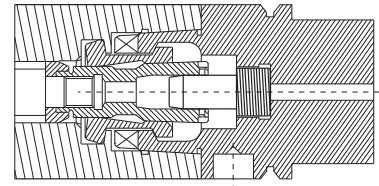

TIRANTE CON GUARNIZIONE

- TENSION ROD WITH PACKING
- ANZUGSBOLZEN MIT DICHTUNG
- TIRANT AVEC GARNITURE

03 599../03 599.N

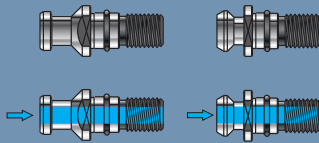

PAG 1056

DIN 69871

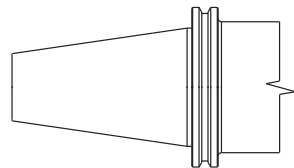

TIRANTE CON GUARNIZIONE

- TENSION ROD WITH PACKING
- ANZUGSBOLZEN MIT DICHTUNG
- TIRANT AVEC GARNITURE

BT 599..

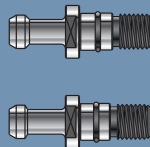

PAG 1057

MAS 403 BT

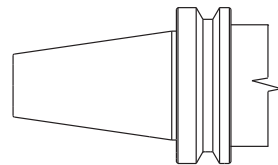

TIRANTE DA DIN69871 A MANDRINO MAS 403 BT

- DIN69871 A CHUCK RETENTION KNOB MAS 403 BT
- ANZUGSBOLZEN NACH DIN69871 MIT AUFNAHME MAS 403 BT
- TIRANT DE DIN69871 À BROCHE MAS 403 BT

03 599../MAZAK
03 599../JIS

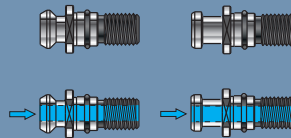

PAG 1057

MAS 403 BT

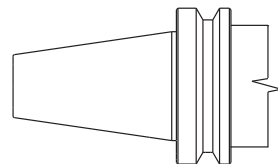

TIRANTE DA MAS 403 BT A MANDRINO DIN69871

- MAS 403 BT A CHUCK RETENTION KNOB DIN69871
- ANZUGSBOLZEN NACH MAS 403 BT MIT AUFNAHME DIN69871
- TIRANT DE MAS 403 BT À BROCHE DIN69871

BT 599../XDIN69871

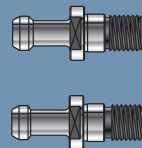

PAG 1057

DIN 69871

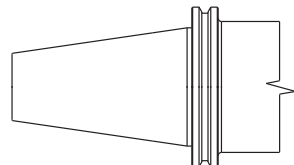

PORTAPINZA DIN 6499

- COLLET HOLDER DIN 6499
- FRÄSERSPANFUTTER DIN 6499
- MANDRINS A PINCES DIN 6499

253..W



PAG 1058

ER-DIN 6499

ER-DIN 6499 A-B

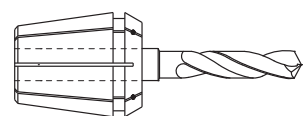

PORTAPINZA DIN 6499

- COLLET HOLDER DIN 6499
- FRÄSERSPANFUTTER DIN 6499
- MANDRINS A PINCES DIN 6499

253..NCW



PAG 1058

ER-DIN 6499

ER-DIN 6499 A-B

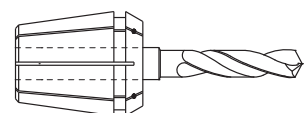



228.. STANDARD
228Q.. PRECISION

ER-DIN 6499

PINZA AUTOESTRAIBILE DIN 6499
- AUTO-CENTERING COLLET DIN 6499
- SELBSTZENTRIER-SPANNZANGEN
DIN 6499
- PINCE AUTO-EXTRACTIBLE DIN 6499

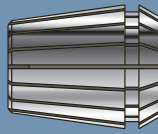

PAG 1059
PAG 1061

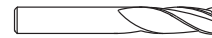

DIN 1835 A - DIN 6535 HA



SET 228-ER..

KIT PINZA AUTOESTRAIBILE DIN 6499
- AUTO-CENTERING COLLET SET DIN 6499
- SELBSTZENTRIER-SPANNZANGEN-SATZ
DIN 6499
- JEU PINCE AUTO-EXTRACTIBLE DIN 6499



PAG 1060

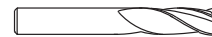

DIN 1835 A - DIN 6535 HA



230.. STANDARD
230QN.. PRECISION

ER-DIN 6499

**PINZA AUTOESTRAIBILE CON GOMMA DI
TENUTA DIN 6499**
- AUTO-CENTERING COLLET WITH RETAINING
RUBBER DIN 6499
- SELBSTZENTRIER-SPANNZANGEN MIT
DICHTGUMMI DIN 6499
- PINCE AUTO-EXTRACTIBLE AVEC JOINT
D'ETANCHÉITÉ DIN 6499

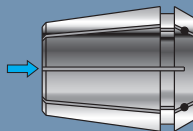

PAG 1062
PAG 1063

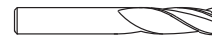

DIN 1835 A - DIN 6535 HA

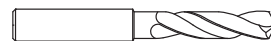

328..

**PINZA AUTOESTRAIBILE PORTAMASCHI
DIN 6499-AZ**
- AUTO-CENTERING COLLET TAP HOLDERS
DIN 6499-AZ
- SELBSTZENTRIER-SPANNZANGEN
GEWINDEBOHRERAUFNAHME DIN 6499-AZ
- PINCE AUTO-EXTRACTIBLE PORTE-TARAUDS
DIN 6499-AZ

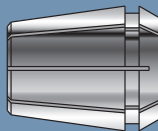

PAG 1064



330..

**PINZA AUTOESTRAIBILE PORTAMASCHI CON
GOMMA DI TENUTA**
- AUTO-CENTERING COLLET WITH RETAINING
RUBBER
- SELBSTZENTRIER-SPANNZANGEN MIT
DICHTGUMMI
- PINCE AUTO-EXTRACTIBLE PORTE-MALES
AVEC CAOUTCHOUC D'ETANCHEITE

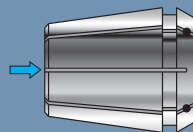

PAG 1064



329..

**PINZA PORTAMASCHI CON COMPENSAZIONE
ASSIALE DIN 6499**
- TAPPING COLLETS WITH AXIAL
COMPENSATION DIN 6499
- SPANNZANGE ZUM GEWINDEBOHREN MIT
AXIALEM AUSGLEICH DIN 6499
- PINCE PORTE-TARAUDS AVEC
COMPENSATION AXIALE DIN 6499

NEW

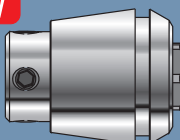

PAG 1065



235..

**PINZA PER ALESATORI CON OSCILLAZIONE
RADIALE DIN 6499**
- COLLET WITH RADIAL COMPENSATION FOR
REAMING DIN 6499
- SPANNZANGEN MIT RADIALAUSGLEICH ZUM
REIBEN DIN 6499
- PINCE POUR ALESOIRS AVEC OSCILLATION
RADIALE DIN 6499

NEW

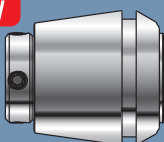

PAG 1065





BOCCOLA DI RIDUZIONE PER UTENSILI PER MINIALESATURA

- COLLET ADAPTERS FOR MINI BOHRING TOOL
- REDUKTION FÜR MINI BOHRSTANGE
- DOUILLE DE RÉDUCTION POUR OUTIL À ALÉSER MINIATURE

216..



ART.603



PAG 1066

PROLUNGA IN ACCIAIO CON ATTACCO CILINDRICO PER MODULARE FILETTATO

- STEEL EXTENSION WITH CYLINDRICAL CONNECTION FOR THREADED MODULAR TOOL SYSTEM
- STAHLVERLÄNGERUNG MIT ZYLINDRAUFNHAME FÜR GEWINDE-MODULARWERKZEUGSYSTEM
- RALLONGE EN ACIER AVEC ATTACHEMENT CYLINDRIQUE PAR LE SYSTEME MODULAIRE FILETÉ

CIL..MF..W

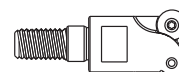

PAG 1066

PROLUNGA IN ACCIAIO CON ATTACCO A CALETTAMENTO TERMICO

- STEEL SHRINK-FIT EXTENSION
- STAHLVERLÄNGERUNG MIT SCHRUMPFVERBINDUNG
- RALLONGE EN ACIER AVEC ATTACHEMENT À EMBOÛTEMENT THERMIQUE

CIL..CTS..W

NEW



DIN 1835 A - DIN 6535 HA

PAG 1067

PROLUNGA ANTIVIBRANTE IN METALLO DURO CON ATTACCO CILINDRICO PER MODULARE FILETTATO

- DAMPED SOLID CARBIDE EXTENSION WITH CYLINDRICAL SHANK FOR THREADED MODULAR SYSTEM
- SCHWINGUNGSGEDÄMPFTE VOLLHARTMETALLVERLÄNGERUNG MIT ZYLINDERAUFNAHME FÜR MODULARSYSTEM
- RALLONGE ANTIVIBRATOIRE EN CARBURE AVEC QUEUE CYLINDRIQUE POUR SYSTEME MODULAIRE FILETE

CIL..MFV..W

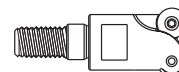

PAG 1068

ADATTATORE PORTAPINZA CON ATTACCO FILETTATO

- COLLET CHUCK ADAPTER WITH THREADED CONNECTION
- SPANNZANGENFUTTER-ADAPTER MIT GEWINDEAUFNAHME
- ADAPTEUR PORTE-PINCE AVEC RACCORD FILETE

253..VW

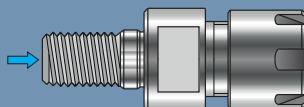

ER-DIN 6499 A-B

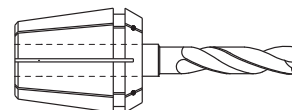

PAG 1068

PORTAMASCHIO A CAMBIO RAPIDO CON DOPPIA COMPENSAZIONE ASSIALE

- QUICK-CHANGE TAP HOLDER WITH DOUBLE AXIAL COMPENSATION
- GEWINDESCHNEID-SCHNELLWECHSELFUTTER MIT DOPPELAUSGLEICH
- MANDRINS DE TARAUDAGE À CHANGEMENT RAPIDE À DOUBLE COMPENSATION AXIALE

CWE..MC..

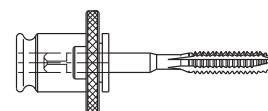
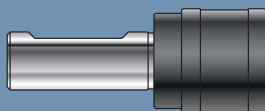

PAG 1069

PORTAMASCHIO PER MASCHIATURA SINCRONIZZATA





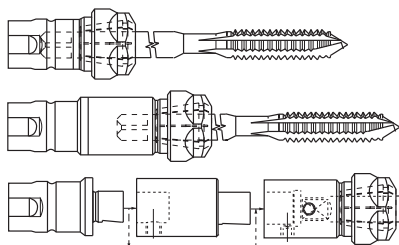
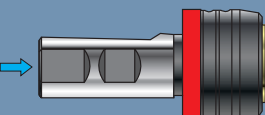





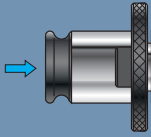

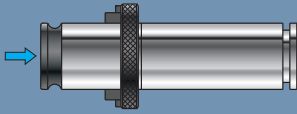
- TAP HOLDERS FOR SYNCHRONIZED TAPPING
- GEWINDEBOHRERHALTER FÜR SYNCHRON STEUERUNG
- MANDRINS DE TARAUDAGE POUR TARAUDAGE SYNCHRONISÉ

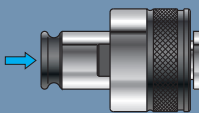
CWE..MS..

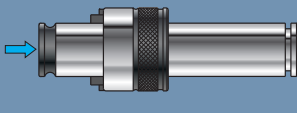

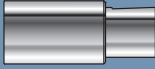
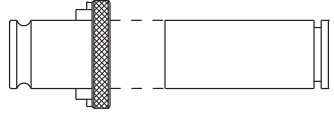
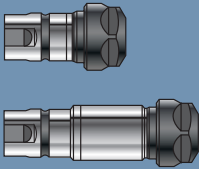
PAG 1069

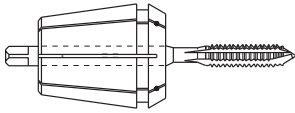
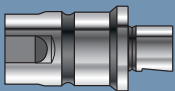

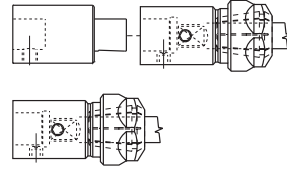
<p>BUSSOLA PORTAMASCHI - TAP-COLLET - GEWINDEBOHRER-AUFNAHME - DOUILLE PORTE-TARAUDS</p>	<p>331..</p>  <p>PAG 1071</p>	
<p>BUSSOLA PORTAMASCHI MODULARE PROLUNGATA - EXTENDED MODULAR TAP-COLLET LONG TYPE - VERLÄNGERTE MODULARE GEWINDEBOHRER-AUFNAHME - DOUILLE PORTE-TARAUDS MODULAIRE SERIE LONGUE</p>	<p>333..</p>  <p>PAG 1072</p>	 
<p>BUSSOLA PORTAMASCHI CON FRIZIONE - TAP-COLLET WITH OVERLOAD CLUTCH - GEWINDEBOHRER-AUFNAHME MIT DREHMOMENTBEGRENZUNG - DOUILLE PORTE-TARAUDS AVEC EMBRAYAGE</p>	<p>334..</p>  <p>PAG 1073</p>	
<p>BUSSOLA PORTAMASCHI MODULARE PROLUNGATA CON FRIZIONE - EXTENDED MODULAR TAP-COLLET WITH OVERLOAD CLUTCH - VERLÄNGERTE MODULARE GEWINDEBOHRER-AUFNAHME MIT DREHMOMENTBEGRENZUNG - DOUILLE PORTE-TARAUDS MODULAIRE PROLONGÉ AVEC EMBRAYAGE</p>	<p>336..</p>  <p>PAG 1074</p>	 
<p>PROLUNGA PER BUSSOLA PORTAMASCHI MODULARE - EXTENSION FOR MODULAR TAP-COLLET - VERLÄNGERUNG FÜR MODULARE GEWINDEBOHRER-AUFNAHME - RALLONGE POUR DOUILLE PORTE-TARAUDS MODULAIRE</p>	<p>339../340..</p>  <p>PAG 1075</p>	
<p>BUSSOLA PORTAMASCHIO PER MASCHIATURE SINCRONIZZATE - TAP-COLLET FOR SYNCHRONIZED TAPPING - GEWINDEBOHRER-AUFNAHME FÜR SYNCHRONSTEUERUNG - DOUILLE PORTE-TARAUD POUR TARAUDAGES SYNCHRONISEES</p>	<p>335..</p>   <p>PAG 1076</p>	<p>ER-DIN 6499 B</p> 
<p>CORPO BUSSOLA PROLUNGATA - EXTENDED TAP ADAPTER BODY - EINSATZ MIT LANGE AUSFÜHRUNG - CORPS DE LA DOUILLE PROLONGÉ</p>	<p>341..</p>   <p>PAG 1076</p>	

TERMINALE

- TERMINAL
- TERMINAL
- TERMINAL

342..

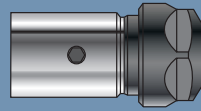

PAG 1077

ER-DIN 6499 B

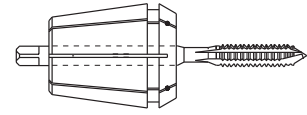

SUPPORTO DI MONTAGGIO

- ASSEMBLY SUPPORT
- MONTAGE BLOCK
- SUPPORT DE MONTAGE

RCDM ...

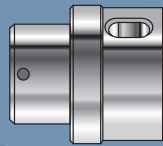

PAG 1077

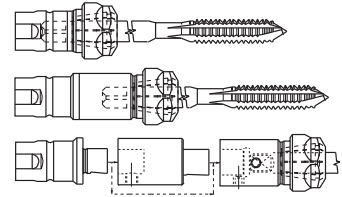

PORTA ALESATORI FLOTTANTI CON REFRIGERAZIONE INTERNA

- FLOATING REAMER HOLDERS WITH INNER COOLING
- SCHWIMMENDE REIBAHLENHALTER MIT INNENKÜHLUNG
- PINCE POUR ALESOIRS AVEC OSCILLATION RADIALE DIN 6499

361..ER..

NEW

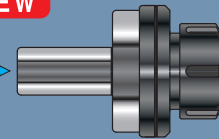

ER-DIN 6499

PAG 1078



BOCCOLA DI RIDUZIONE

- COLLET ADAPTERS
- REDUKTION
- DOUILLES DE RÉDUCTION

218..



PAG 1078

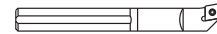

BOCCOLA DISASSATRICE AD INTERASSE FISSO

- OFFSET COLLETS WITH FIXED CENTER DISTANCE
- ACHSVERSATZ-BÜCHSEN MIT FESTEM ACHSABSTAND
- DOUILLES DESAXANTES AVEC ENTRE-AXES FIXE

BPUH..

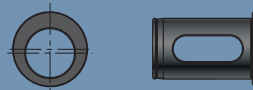

PAG 1079

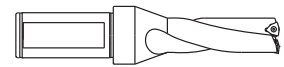

BOCCOLE DI RIDUZIONE CILINDRICHE PER MANDRINI A FORTE SERRAGGIO

- CYLINDRICAL REDUCTION COLLETS FOR HEAVY-DUTY CHUCKS
- ZYLINDRISCHE REDUZIERBUCHSEN FÜR KRAFTSPANNFUTTER
- DOUILLES DE RÉDUCTION CYLINDRIQUES POUR MANDRINS A SERRAGE FORT

BEMSN..



PAG 1079

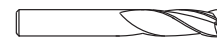

DIN 1835 A - DIN 6535 HA



BOCCOLE DI RIDUZIONE CILINDRICHE CON GOMMA DI TENUTA PER MANDRINI IDRAULICI

- CYLINDRICAL REDUCTION COLLETS WITH O-RING FOR HYDRAULIC CHUCKS
- ZYLINDRISCHE REDUZIERBUCHSEN MIT GUMMIDICHTUNG FÜR HYDRAULISCHE WERKZEUGAUFNAHMEN
- DOUILLES DE RÉDUCTION CYLINDRIQUES AVEC JOINT TORIQUE ETANCHE EN CAOUTCHOUC POUR MANDRINS HYDRAULIQUES

BMIS..

NEW

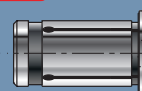

PAG 1079

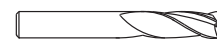

DIN 1835 A - DIN 6535 HA





BECR..

BOCCOLA DISASSATRICE REGOLABILE

- ADJUSTABLE OFFSET COLLETS
- EINSTELLBARE ACHSVERSATZ-BÜCHSEN
- DOUILLES DESAXANTES AVEC REGULATION

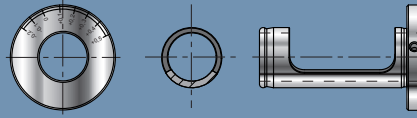

PAG 1080

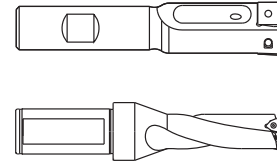

BOCCOLA DI RIDUZIONE PORTA BARENO CON PASSAGGIO DEL REFRIGERANTE

- THROUGH COOLANT BORING BAR REDUCING COUPLING
- BOHRSTANGEN-REDUZIERHÜLSE MIT SCHMIERSTOFFDURCHFLUSS
- DOUILLE DE RÉDUCTION PORTE BARRE D'ALEPAGE AVEC PASSAGE DU FLUIDE DE RÉFRIGÉRATION

BKN-...-...



PAG 1083



ATTREZZO PER IL MONTAGGIO E LO SMONTAGGIO DI MANDRINI

- TOOL FOR THE ASSEMBLY AND DISASSEMBLY OF ARBORS
- MONTAGE HILFE
- OUTIL POUR LE MONTAGE ET LE DEMONTAGE DE MANDRINS

06 36.. .UN

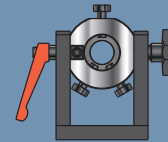

PAG 1085

TELAIO DA BANCO PORTAMANDRINI

- BENCH-MOUNTED STORAGE RACK ARBORS
- AUFNAHMETRAEGER
- BOITE DE COMPTOIR PORTE-MANDRINS

A-140..

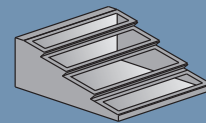

PAG 1085

BOCCOLA PORTAMANDRINI

- STORAGE BASE FOR ARBORS
- AUFNAHMEBUCHSE
- RÉDUCTIONS PORTE-MANDRINS

A-1..



PAG 1085

GHIERA DI PRECISIONE

- PRECISION RING NUTS
- PRÄZISIONSRINGE
- FRETTE DE PRECISION

RGC..



PAG 1086

GHIERA STANDARD PER PINZE ER-DIN6499

- STANDARD METAL RING FOR ER-DIN6499 COLLET
- STANDARDRING FÜR ER-DIN6499 SPANNZANGEN
- FRETTE STANDARD POUR PINCES ER-DIN6499

RGS..



PAG 1086

GHIERA ESAGONALE PER PINZE ER-DIN6499

- METAL RING FOR ER-DIN6499 COLLETS
- SECHSECKIGER GEWINDERING FÜR ER-DIN6499 SPANNZANGEN
- FRETTE À SIX PANS POUR PINCES ER-DIN6499

RGSE..



PAG 1086

MINI GHIERA PER PINZE ER-DIN6499

- MINI METAL RING FOR ER-DIN6499 COLLET
- MINI-RING FÜR ER-DIN6499 SPANNZANGEN
- MINI FRETTE POUR PINCES ER-DIN6499

RGM..



PAG 1086



GHIERE A TENUTA IDRAULICA

- SEALING RINGS
- DICHTSCHEIBEN
- FRETTE À ÉTANCHÉITÉ HYDRAULIQUE

RGSW..



PAG 1086

ANELLI PER ADDUZIONE ATTRAVERSO L'UTENSILE

- RINGS FOR COOLANT THROUGH THE TOOL
- RINGE ZUR KÜHLMITTEL-INNENFÜHRUNG
- BAGUES D'ADDITION À TRAVES L'OUTIL

AGT..

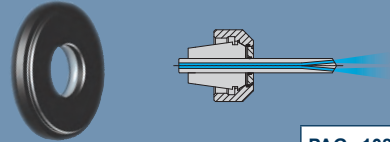

PAG 1087

ANELLI PER ADDUZIONE INTORNO ALL'UTENSILE

- RINGS FOR COOLANT AROUND THE TOOL
- RINGE ZUR KÜHLMITTELFÜHRUNG UM DAS WERKZEUG
- BAGUES D'ADDITION AUTOUR L'OUTIL

AGW..

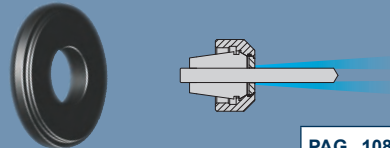

PAG 1087

ANELLO DI TENUTA

- SEALING RING
- DICHTRING
- BAGUE D'ÉTANCHÉITÉ

AGMS..



PAG 1088

CACCIAVITE

- SCREWDRIVERS
- SCHRAUBENDREHER
- TOURNEVISSES

56..

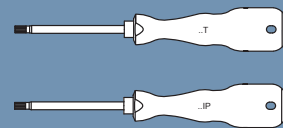

PAG 1089

KIT DINAPLUS

- DINAPLUS KIT
- DINAPLUS KIT
- KIT DINAPLUS

KITDP00000



PAG 1090

MANICO CACCIAVITE DINAPLUS

- DYNAPLUS SCREWDRIVER HANDLE
- DYNAPLUS SCHRAUBENDREHER-GRIF
- MANCHE TOURNEVIS DYNAPLUS

26000



PAG 1090

LAME

- BLADES
- MESSERS
- LAME

270../290..



PAG 1090

CHIAVE A BANDIERA

- FLAG KEY
- FLAGGE-SCHLÜSSEL
- CLÉ À "PAVILLON"

55..



PAG 1091

CHIAVE TORX A L







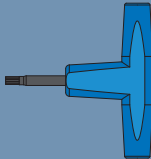

- TORX KEY (L-SHAPED)
- TORX-SCHLÜSSEL (L-FÖRMIG)
- CLÉ TORX À L

54..

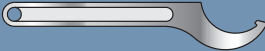
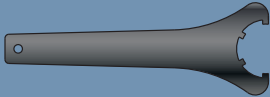

PAG 1091



<p>CHIAVE TORX A T - TORX KEY (T-SHAPED) - TORX-SCHLÜSSEL (T-FÖRMIG) - CLÉ TORX À T</p>	<p>CTT..</p>  <p>PAG 1091</p>
<p>CHIAVE A BRUGOLA A L - L-SETSCREW WRENCH - L-INBUSSCHLÜSSEL - CLÉ À 6 PANS À L</p>	<p>50..</p>  <p>PAG 1092</p>
<p>CHIAVE ERGONOMICA MONTAGGIO/ESTRAZIONE INSERTI - INSERT ASSEMBLY/REMOVAL ERGONOMIC KEY - ERGONOMISCHER MONTAGE-/AUSZIEHSCHLÜSSEL FÜR WENDEPLATTEN - CLÉ A MANCHE ERGONOMIQUE DE MONTAGE/EXTRACTION DES PLAQUETTES</p>	<p>CH-TRL30-40</p>  <p>PAG 1092</p>
<p>CHIAVE PER UNITÀ MICROREGISTRABILE - KEY FOR MICRO-BORING UNITS - SCHLÜSSEL FÜR FEINBOHREINHEITEN - CLÉ POUR UNITÉS MICROMÉTRIQUES</p>	<p>45.95.6..</p>  <p>PAG 1093</p>
<p>CHIAVE A DENTI PER BOCCOLE BCF - PIN WRENCH FOR BCF BUSHING - ZAPFENSCHLÜSSEL FÜR BCF-BUCHSEN - CLÉ À GIFFES POUR DOUILLE BCF</p>	<p>CH-HK..</p>  <p>PAG 1093</p>
<p>CHIAVE A SETTORE CON DENTE PER GHIERE RGS/RGC - PIN WRENCH FOR RGS/RGC - ZAPFENSCHLÜSSEL FÜR RGS/RGE RING - CLÉ À SECTEUR AVEC GRIFFE POUR FRETTE RGS/RGC</p>	<p>925..</p>  <p>PAG 1094</p>
<p>CHIAVE A SETTORE CON 4 DENTI PER GHIERE RGS - PIN WRENCH(4TEETH) FOR RGS - ZAPFENSCHLÜSSEL FÜR RGS (4 ZÄHNE) - CLÉ À SECTEUR À 4 GRIFFES POUR FRETTE RGS</p>	<p>927..</p>  <p>PAG 1094</p>
<p>CHIAVE A SETTORI PER GHIERE RGM - PIN WRENCH FOR RGM - ZAPFENSCHLÜSSEL FÜR RGM-RINGE - CLÉ À SECTEUR POUR FRETTE RGM</p>	<p>938..</p>  <p>PAG 1094</p>
<p>CHIAVE PER VITI CON TESTA A CROCE - CROSS-SLOTTED SCREW WRENCH - KREUZSCHLÜSSEL - CLÉ POUR VIS AVEC TÊTE À CROIX</p>	<p>423..</p>  <p>PAG 1095</p>
<p>ANELLO DISTANZIATORE PER PORTAFRESA COMBINATO - DISTANCE RING FOR COMBI MILL-HOLDER - DISTANZRING FÜR KOMBI-FRÄSERAUFNAHME - BAGUE D'ENTRETOISE POUR MANDRIN PORTE-FRAISE COMBINÉ</p>	<p>195..</p>  <p>PAG 1095</p>

ESTRATTORE PER PINZE

- EXTRACTOR FOR COLLETS
- ENTFERNER FÜR REDUZIERHULSEN
- EXTRACTEUR POUR PINCES

ESMS..

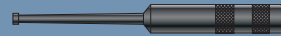

PAG 1096

TUBO DRITTO RACCORDATO

- FITTED HOSE STRAIGHT
- GERADE SCHLAUCHLEITUNG
- TUBE DROIT RACCORDE

ATUB..



PAG 1096

RACCORDO DRITTO

- STRAIGHT FITTING
- GERADE VERBINDUNGSSTÜCK
- RACCORD DROIT

A00MM18..



PAG 1096

RIDUZIONE

- ADAPTER
- REDUZIERUNGEN
- RÉDUCTION

ARIMF14180

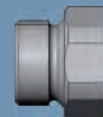

PAG 1096

RACCORDO 90°

- 90° FITTING
- 90°-KUPPLUNG
- RACCORD 90°

A90MM18..



PAG 1097

ANELLO DI TENUTA

- SEALING RING
- DICHRING
- ANNEAU D'ÉTANCHEITE

ABS000M100



PAG 1097

OGIVA LUBROREFRIGERANTE

- COOLING LUBRICANT NOSE CONE
- KÜHLSCHMIERMITTEL-NASENKEGEL
- OGIVE LUBRIFIANTE-RÉFRIGÉRANTE

AOG...F18

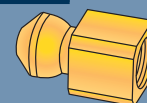

PAG 1097

MORSA MODULARE DI PRECISIONE

- MODULAR PRECISION VICE
- MODULARER PRÄZISIONSSCHRAUBSTOCK
- ETAU MODULAIRE DE PRECISION

MS...

NEW

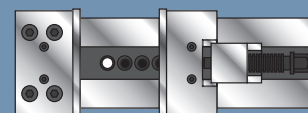

PAG 1098

GANASCIA LISCIA

- SMOOTH JAW
- GLATTE BACKE
- MACHOIRE LISSE

GNL...

NEW



PAG 1098

GANASCIA RIGATA

- GROOVED JAW
- RIFFELBACKE
- MACHOIRE STRIEE

GNR...

NEW



PAG 1098



GANASCIA "SMART GRIP"

- "SMART GRIP" JAW
- "SMART GRIP" BACKE
- MACHOIRE "SMART GRIP"

GNS...

NEW



PAG 1099

GANASCIA A PRISMA

- PRISM JAW
- PRISMA-BACKE
- MACHOIRE A PRISME

GNP...

NEW

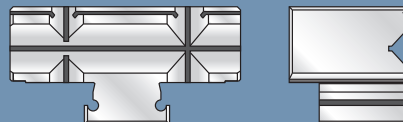

PAG 1099

BLOCCHETTO - VITE

- BLOCK - SCREW
- BLOCK - SCHRAUBE
- CALE - VIS

BLV...

NEW

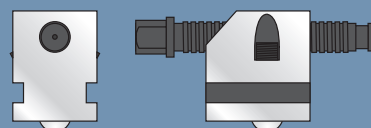

PAG 1099

BASE GIREVOLE

- SWIVEL BASE
- SCHWENKFUSS
- BASE TOURNANTE

BAG...

NEW

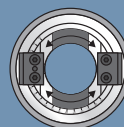

PAG 1099

PIASTRE PARALLELE MAGNETICHE AL NEODIMIO

- NEODYMIUM MAGNETIC PARALLEL PLATES
- PARALLEL-MAGNETPLATTEN AUS NEODYM
- PLAQUES PARALLELES MAGNETIQUES AU NEODYME

SPM-CN...

NEW



PAG 1100

KIT DI ACCESSORI DI BATTUTA E DISTANZIALI PER MORSE DI PRECISIONE

- STOP SET AND SPACERS FOR PRECISION VISES
- ANSCHLAGSET UND ABSTANDSHALTER FÜR PRÄZISIONSSCHRAUBSTÖCKE
- JEU D'ACCESSOIRES DE BUTEE ET ENTRETOISES POUR ETAUX DE PRECISION

KIT-DIS-M10

NEW

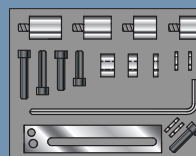

PAG 1101

PASTA MOLYKOTE HSC PLUS TUBETTO 100gr.

- MOLYKOTE HSC PLUS PASTE, TUBE 100G
- MOLYKOTE HSC PLUS PASTE, TUBE 100G
- PATE MOLYKOTE HSC PLUS TUBE 100 G

MOLYKOTE
HSC PLUS 1000

NEW



PAG 1102

Accessori
Accessories
Zubehör
Accessories

ART. 228Q... **ER-DIN 6499**

PIAZZA AUTO-RITRATTILE DI PRESSIONE DIN 6499
PRESSION SELF-RETRACTING COLLET
PRESSIONSSELBSTZURÜCKSPANNUNGS-
PIAZZA AUTO-RITRATTILE DI PRESSIONE

ART.	Ød1	ØD2	L	ØD3	ØD4	L1	ØD5	L2
PIAZZA BT 201 000	10,5	11,5	18	—	—	—	—	—
PIAZZA BT 202 000	12,5	13,5	18	—	—	—	—	—
PIAZZA BT 203 000	15,5	16,5	18	—	—	—	—	—
PIAZZA BT 204 000	17,5	18,5	18	—	—	—	—	—
PIAZZA BT 205 000	20,5	21,5	18	—	—	—	—	—
PIAZZA BT 206 000	22,5	23,5	18	—	—	—	—	—
PIAZZA BT 207 000	25,5	26,5	18	—	—	—	—	—
PIAZZA BT 208 000	27,5	28,5	18	—	—	—	—	—

ART. BT 599... **JIS B 6338(BT)**

PIAZZA BT 599 000

ART.	ØD1	ØD2	ØD3	ØD4	L	L1	L2	ØD5	ØD6	ØD7	ØD8	ØD9	ØD10	ØD11	ØD12	ØD13	ØD14	ØD15	ØD16	ØD17	ØD18	ØD19	ØD20	ØD21	ØD22	ØD23	ØD24	ØD25	ØD26	ØD27	ØD28	ØD29	ØD30	ØD31	ØD32	ØD33	ØD34	ØD35	ØD36	ØD37	ØD38	ØD39	ØD40	ØD41	ØD42	ØD43	ØD44	ØD45	ØD46	ØD47	ØD48	ØD49	ØD50	ØD51	ØD52	ØD53	ØD54	ØD55	ØD56	ØD57	ØD58	ØD59	ØD60	ØD61	ØD62	ØD63	ØD64	ØD65	ØD66	ØD67	ØD68	ØD69	ØD70	ØD71	ØD72	ØD73	ØD74	ØD75	ØD76	ØD77	ØD78	ØD79	ØD80	ØD81	ØD82	ØD83	ØD84	ØD85	ØD86	ØD87	ØD88	ØD89	ØD90	ØD91	ØD92	ØD93	ØD94	ØD95	ØD96	ØD97	ØD98	ØD99	ØD100
PIAZZA BT 599 000	10	12	14	16	18	20	22	24	26	28	30	32	34	36	38	40	42	44	46	48	50	52	54	56	58	60	62	64	66	68	70	72	74	76	78	80	82	84	86	88	90	92	94	96	98	100	102	104	106	108	110	112	114	116	118	120	122	124	126	128	130	132	134	136	138	140	142	144	146	148	150	152	154	156	158	160	162	164	166	168	170	172	174	176	178	180	182	184	186	188	190	192	194	196	198	200							

ART. 253... W **ER-DIN 6499**

PIAZZA BT 253 000

ART.	ØD1	ØD2	ØD3	ØD4	L	L1	ØD5	ØD6	ØD7	ØD8	ØD9	ØD10	ØD11	ØD12	ØD13	ØD14	ØD15	ØD16	ØD17	ØD18	ØD19	ØD20	ØD21	ØD22	ØD23	ØD24	ØD25	ØD26	ØD27	ØD28	ØD29	ØD30	ØD31	ØD32	ØD33	ØD34	ØD35	ØD36	ØD37	ØD38	ØD39	ØD40	ØD41	ØD42	ØD43	ØD44	ØD45	ØD46	ØD47	ØD48	ØD49	ØD50	ØD51	ØD52	ØD53	ØD54	ØD55	ØD56	ØD57	ØD58	ØD59	ØD60	ØD61	ØD62	ØD63	ØD64	ØD65	ØD66	ØD67	ØD68	ØD69	ØD70	ØD71	ØD72	ØD73	ØD74	ØD75	ØD76	ØD77	ØD78	ØD79	ØD80	ØD81	ØD82	ØD83	ØD84	ØD85	ØD86	ØD87	ØD88	ØD89	ØD90	ØD91	ØD92	ØD93	ØD94	ØD95	ØD96	ØD97	ØD98	ØD99	ØD100
PIAZZA BT 253 000	10	12	14	16	18	20	22	24	26	28	30	32	34	36	38	40	42	44	46	48	50	52	54	56	58	60	62	64	66	68	70	72	74	76	78	80	82	84	86	88	90	92	94	96	98	100	102	104	106	108	110	112	114	116	118	120	122	124	126	128	130	132	134	136	138	140	142	144	146	148	150	152	154	156	158	160	162	164	166	168	170	172	174	176	178	180	182	184	186	188	190	192	194	196	198	200						

- 1 = NORMA ATTACCO
- 2 = NORMA PARTE ANTERIORE
- 3 = ACCESSORI OPZIONALI A RICHIESTA
- 4 = CARATTERISTICHE TECNICHE
- 5 = ARTICOLO
- 6 = MISURE, DATI, INDICAZIONI
- 7 = ACCESSORI E RICAMBI IN DOTAZIONE
- 8 = ACCESSORI E RICAMBI OPZIONALI A RICHIESTA
- 9 = NOTE E AVVERTIMENTI

- 1 = SHANK STANDARD
- 2 = TOOL-HOLDER STANDARD
- 3 = OPTIONAL ACCESSORIES ON REQUEST.
- 4 = TECHNICAL FEATURES
- 5 = ITEM
- 6 = MEASURES, DATA, INDICATIONS
- 7 = ACCESSORIES AND SPARE PARTS EQUIPMENT
- 8 = OPTIONAL ACCESSORIES AND SPARE PARTS ON REQUEST
- 9 = NOTES AND WARNINGS



- 1 = KEGEL-NORM
- 2 = AUFNAHME-NORM
- 3 = OPTIONALZUBEHÖR AUF ANFRAGE
- 4 = TECHNISCHE HAUPTMERKMALE
- 5 = ARTKEL
- 6 = ABMESSUNGEN, DATEN, HINWEISE
- 7 = ZUBEHÖR UND ERSATZTEIL AUSSTATTUNG
- 8 = OPTIONALZUBEHÖR UND -ERSATZTEILE AUF ANFRAGE
- 9 = ANMERKUNGEN UND HINWEISE

- 1 = NORMES POUR ATTACHEMENT
- 2 = NORME POUR MANDRIN
- 3 = ACCESSOIRES OPTIONNELS SUR DEMANDE
- 4 = CARACTERISTIQUES TECHNIQUES
- 5 = ARTICLE
- 6 = DIMENSIONES, DONNÉES, INDICATIONS
- 7 = ACCESSOIRES ET RECHANGE EN DOTATION
- 8 = ACCESSOIRES ET RECHANGES OPTIONNELS SUR DEMANDE
- 9 = NOTES ET AVERTISSEMENTS

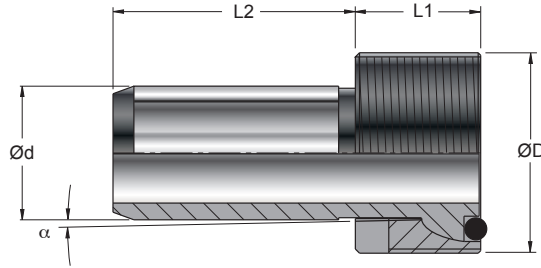
ART. ATR..



ADDUTTORE REFRIGERANTE PER MANDRINI HSK
COOLANT FEED FOR HSK CHUCK
KÜHLMITTELZUFHUR FÜR HSK-AUFNAHME
ABDUCTEUR DU RÉFRIGÉRANTE POUR MANDRINS HSK

ART.		(mm)							
		ØD	Ød	L1	L2	α			
ATR012 HK40	HSK40	M12x1	8	8	21,5	-	OR-HK040	CH-HK040	
ATR016 HK50	HSK50	M16x1	10	10	23	-	OR-HK050	CH-HK050	
ATR018 HK63	HSK63	M18x1	12	11,5	36,2	1,3°	OR-HK063	CH-HK063	
ATR020 HK80	HSK80	M20x1,5	14	13,5	39,7	1,4°	OR-HK080	CH-HK080	
ATR024 HK100	HSK100	M24x1,5	16	15	43,6	1,4°	OR-HK100	CH-HK100	

ART. 03 599..
ART. 03 599..N

DIN 69872 A-B
ISO 7388 A-B
ISO 7388/2 A-B

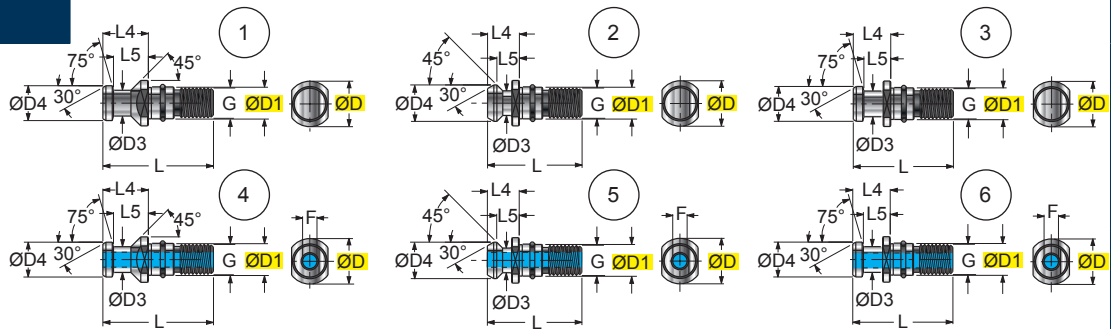

TIRANTE CON GUARNIZIONE
TENSION ROD WITH PACKING
ANZUGSBOLZEN MIT DICHTUNG
TIRANT AVEC GARNITURE

ART.		(mm)										FIGURA FIGURE BILD FIGURE		
		ØD	ØD1	ØD3	ØD4	L	L4	L5	G	F				
03 599.040.01 DIN	ISO40	23,0	17	14,0	19,0	54,0	26,0	20,0	M16	7,0	4	DIN 69872 A		
03 599.050.05 DIN	ISO50	36,0	25	21,0	28,0	74,0	34,0	25,0	M24	11,5	4			
03 599.040.01 ISO	ISO40	23,0	17	14,0	19,0	54,0	26,0	20,0	M16	7,0	6	ISO 7388/2 A		
03 599.050.05 ISO	ISO50	36,0	25	21,0	28,0	74,0	34,0	25,0	M24	11,5	6			
03 599.040.02 ISO	ISO40	22,5	17	12,95	18,95	44,5	16,4	11,15	M16	7,35	5	ISO 7388 A		
03 599.050.06 ISO	ISO50	37,0	25	19,6	29,1	65,5	25,55	17,95	M24	11,55	5			
03 599.040.01N DIN	ISO40	23,0	17	14,0	19,0	54,0	26,0	20,0	M16	-	1	DIN 69872 B		
03 599.050.05N DIN	ISO50	36,0	25	21,0	28,0	74,0	34,0	25,0	M24	-	1			
03 599.040.01N ISO	ISO40	23,0	17	14,0	19,0	54,0	26,0	20,0	M16	-	3	ISO 7388/2 B		
03 599.050.05N ISO	ISO50	36,0	25	21,0	28,0	74,0	34,0	25,0	M24	-	3			
03 599.040.02N ISO	ISO40	22,5	17	12,95	18,95	44,5	16,4	11,15	M16	-	2	ISO 7388 B		
03 599.050.06N ISO	ISO50	37,0	25	19,6	29,1	65,5	25,55	17,95	M24	-	2			

ART. BT 599..

JIS B 6339/BT

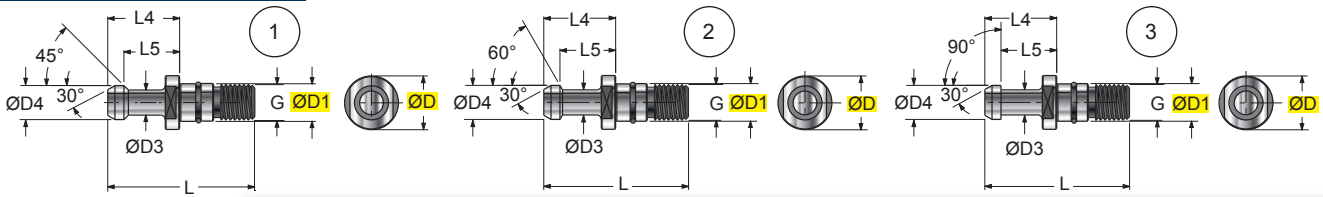

TIRANTE CON GUARNIZIONE
TENSION ROD WITH PACKING
ANZUGSBOLZEN MIT DICHTUNG
TIRANT AVEC GARNITURE

IL TIRANTE PUÒ ESSERE FORNITO FORATO SU RICHIESTA DEL CLIENTE CHE NE SPECIFICHI IL DIAMETRO DEL FORO. (SI DECLINA OGNI RESPONSABILITÀ)
THE RETENTION SCREEN CAN BE SUPPLIED CUSTOM-DRILLED TO SPECIFICATIONS OF THE CUSTOM. (WE DECLINE RESPONSIBILITY FOR CUSTOM ORDERS)
DURCHBOHRTE ANZUGSBOLZEN KOENNEN NACH SPEZIFISCH VON DEN KUNDEN ANGEGEBENEN DURCHMESSER GROESSEN AUCH GELIEFERT WERDEN.
SELBSTVERSTÄNDLICH WIRD JEDLICHE VERANTWORTUNG ABGELEHNT.
LE TIRANT PEUT ÊTRE LIVRE SUR DEMANDE DU CLIENT QUI SPECIFIERA LE DIAMETRE DU TROU-NATURELLEMENT ON DECLINE TOUTE RESPONSABILITE

ART.	 (mm)	ØD	ØD1	ØD3	ØD4	L	L4	L5	G	FIGURA FIGURE BILD FIGURE
BT 599.040.01	ISO40	23	17	10	15	60	35	28	M16	1
BT 599.040.02	ISO40	23	17	10	15	60	35	28	M16	2
BT 599.040.03	ISO40	23	17	10	15	60	35	28	M16	3
BT 599.050.05	ISO50	38	25	17	23	85	45	35	M24	1
BT 599.050.06	ISO50	38	25	17	23	85	45	35	M24	2
BT 599.050.07	ISO50	38	25	17	23	85	45	35	M24	3

ART. 03 599..MAZAK
ART. 03 599..JIS

ISO 7388/2 B
JIS 6339

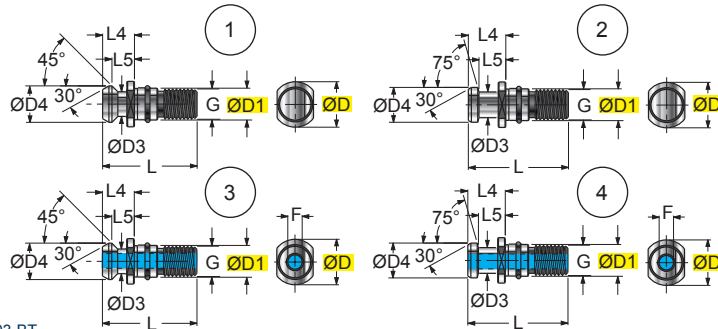

TIRANTE DA DIN69871 A MANDRINO MAS 403 BT
DIN69871 A CHUCK RETENTION KNOB MAS 403 BT
ANZUGSBOLZEN NACH DIN69871 MIT AUFNAHME MAS 403 BT
TIRANT DE DIN69871 À BROCHE MAS 403 BT

ART.	 (mm)	ØD	ØD1	ØD3	ØD4	L	L4	L5	G	F	FIGURA FIGURE BILD FIGURE
03 599.040.02NxBT MAZAK*	ISO40	22,5	17	12,95	18,95	44,5	19,1	14,1	M16	-	1
03 599.040.02xBT MAZAK*	ISO40	22,5	17	12,95	18,95	44,5	19,1	14,1	M16	7,35	3
03 599.040.01NxBT JIS	ISO40	23	17	14	19	54	29	23	M16	-	2
03 599.040.01xBT JIS	ISO40	23	17	14	19	54	29	23	M16	5,5	4

ART. BT 599.. xDIN69871

JIS B 6339/BT

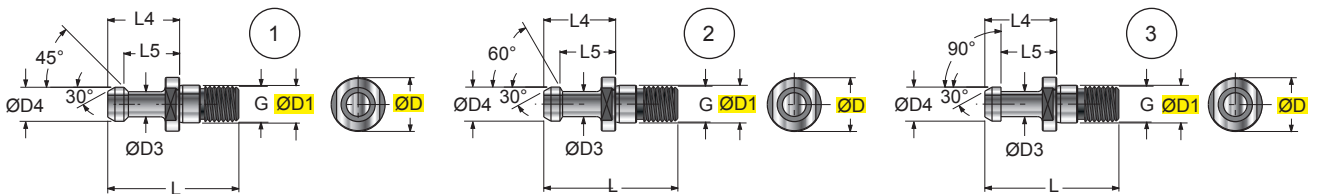

TIRANTE DA MAS 403 BT A MANDRINO DIN69871
MAS 403 BT A CHUCK RETENTION KNOB DIN69871
ANZUGSBOLZEN NACH MAS 403 BT MIT AUFNAHME DIN69871
TIRANT DE MAS 403 BT À BROCHE DIN69871

ART.	 (mm)	ØD	ØD1	ØD3	ØD4	L	L4	L5	G	FIGURA FIGURE BILD FIGURE
BT 599.040.01xDIN69871	ISO40	23	17	10	15	57	32	25	M16	1
BT 599.040.02xDIN69871	ISO40	23	17	10	15	57	32	25	M16	2
BT 599.040.03xDIN69871	ISO40	23	17	10	15	57	32	25	M16	3

ART. 253..W

ER-DIN 6499



RGM
Ghiera ad ingombro ridotto (SLIM)
Smaller ring nut (SLIM)

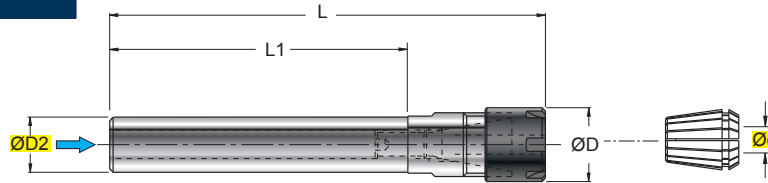

art. 228..
228Q.. (Reccomended)
230..
230QN..
328..
330..
329..
235..

PORTAPINZA DIN 6499
COLLET HOLDER DIN 6499
FRÄSERSPANFUTTER DIN 6499
MANDRINS A PINCES DIN 6499

RGM... , GHIERE CON DIAMETRO ØD1 MINORATO, PAG 1086
 RGM... , RING NUTS WITH REDUCED DIAMETER ØD1, SEE PAGE 1086
 RGM... , GEWINDERINGE MIT BESCHRÄNKTEM DURCHMESSER Ø D1, SEITE 1086
 RGM... , FRETTE AVEC DIAMÈTRE ØD1 AMOINDRI, PAGE 1086

ART.	(mm)								
	ØD2	Ød	ØD1	L	L1				
253.016.011.187MW	16	0,5-7	16	187	165	GWR06	RGM ER11	938.011	-
253.016.016.200MW	16	0,5-10	22	200	160	GWR08	RGM ER16	938.016	-
253.016.016.205W	16	0,5-10	28	205	160	GWR08	RGSE ER16	-	-
253.020.011.187MW	20	0,5-7	16	187	165	GWR06	RGM ER11	938.011	-
253.020.016.200MW	20	0,5-10	22	200	160	GWR10	RGM ER16	938.016	-
253.020.016.205W	20	0,5-10	28	205	160	GWR10	RGSE ER16	-	-
253.020.025.210W	20	0,5-16	42	210	160	GWR10	RGS ER25	-	925.040
253.020.025.210MW	20	0,5-16	35	210	160	GWR10	RGM ER25	938.025	-
253.025.016.205W	25	0,5-10	28	205	160	GWR08	RGSE ER16	-	-
253.025.025.210MW	25	0,5-16	35	210	160	GWR10	RGM ER25	938.025	-
253.025.025.210W	25	0,5-16	42	210	160	GWR10	RGS ER25	-	925.040
253.025.032.213W	25	2-20	50	213	160	GWR10	RGS ER32	-	925.052
253.032.016.205W	32	0,5-10	28	205	160	GWR08	RGSE ER16	-	-
253.032.025.210W	32	0,5-16	42	210	160	GWR10	RGS ER25	-	925.040
253.032.032.210W	32	2-20	50	210	160	GWR10	RGS ER32	-	925.052
253.032.040.140W	32	3-30	63	140	80	GWR14	RGS ER40	-	925.068
253.040.032.210W	40	2-20	50	210	160	GWR10	RGS ER32	-	925.052
253.040.040.140W	40	3-30	63	140	80	GWR14	RGS ER40	-	925.068

ART. 253..NCW

ER-DIN 6499

SEZ A-A

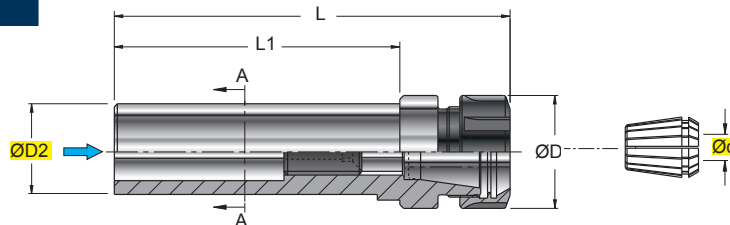
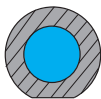

art. 228..
228Q.. (Reccomended)
230..
230QN..
328..
330..
329..
235..

PORTAPINZA PER TORNIO DIN 6499
COLLET HOLDER DIN 6499
FRÄSERSPANFUTTER DIN 6499
MANDRINS A PINCES POUR TOUR DIN 6499

ART.	(mm)								
	ØD2	Ød	ØD1	L	L1				
253.032.032.130NCW	32	2-20	50	128	80	GRF22	RGS ER32	925.052	
253.040.032.130NCW	40	2-20	50	128	80	GRF22	RGS ER32	925.052	

ART. 228..

ER-DIN 6499

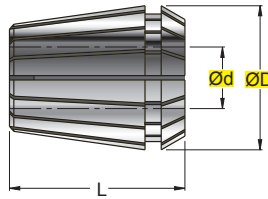

PINZA AUTOESTRAIBILE DIN 6499
AUTO-CENTERING COLLET DIN 6499
SELBSTZENTRIER-SPANNZANGEN DIN 6499
PINCE AUTO-EXTRACTIBLE DIN 6499

ART.	(mm)			
	Ød	ØD	L	
228.011.001.000	0,5-1	11,5	18	---ER-11---
228.011.001.500	1-1,5	11,5	18	---ER-11---
228.011.002.000	1,5-2	11,5	18	---ER-11---
228.011.002.500	2-2,5	11,5	18	---ER-11---
228.011.003.000	2-2,5	11,5	18	---ER-11---
228.011.003.500	3-3,5	11,5	18	---ER-11---
228.011.004.000	3,5-4	11,5	18	---ER-11---
228.011.004.500	4-4,5	11,5	18	---ER-11---
228.011.005.000	4,5-5	11,5	18	---ER-11---
228.011.005.500	5-5,5	11,5	18	---ER-11---
228.011.006.000	5,5-6	11,5	18	---ER-11---
228.011.006.500	6-6,5	11,5	18	---ER-11---
228.011.007.000	6,5-7	11,5	18	---ER-11---
228.016.001.000	0,5-1	17,0	27	---ER-16---
228.016.001.500	1-1,5	17,0	27	---ER-16---
228.016.002.000	1,5-2	17,0	27	---ER-16---
228.016.002.500	2-2,5	17,0	27	---ER-16---
228.016.003.000	2,5-3	17,0	27	---ER-16---
228.016.004.000	3-4	17,0	27	---ER-16---
228.016.005.000	4-5	17,0	27	---ER-16---
228.016.006.000	5-6	17,0	27	---ER-16---
228.016.007.000	6-7	17,0	27	---ER-16---
228.016.008.000	7-8	17,0	27	---ER-16---
228.016.009.000	8-9	17,0	27	---ER-16---
228.016.010.000	9-10	17,0	27	---ER-16---
228.025.001.000	0,5-1	26,0	35	---ER-25---
228.025.001.500	1-1,5	26,0	35	---ER-25---
228.025.002.000	1,5-2	26,0	35	---ER-25---
228.025.002.500	2-2,5	26,0	35	---ER-25---
228.025.003.000	2,5-3	26,0	35	---ER-25---
228.025.004.000	3-4	26,0	35	---ER-25---
228.025.005.000	4-5	26,0	35	---ER-25---
228.025.006.000	5-6	26,0	35	---ER-25---
228.025.007.000	6-7	26,0	35	---ER-25---
228.025.008.000	7-8	26,0	35	---ER-25---
228.025.009.000	8-9	26,0	35	---ER-25---
228.025.010.000	9-10	26,0	35	---ER-25---
228.025.011.000	10-11	26,0	35	---ER-25---
228.025.012.000	11-12	26,0	35	---ER-25---
228.025.013.000	12-13	26,0	35	---ER-25---
228.025.014.000	13-14	26,0	35	---ER-25---
228.025.015.000	14-15	26,0	35	---ER-25---
228.025.016.000	15-16	26,0	35	---ER-25---
228.032.003.000	2-3	33	40	---ER-32---
228.032.004.000	3-4	33	40	---ER-32---
228.032.005.000	4-5	33	40	---ER-32---
228.032.006.000	5-6	33	40	---ER-32---
228.032.007.000	6-7	33	40	---ER-32---
228.032.008.000	7-8	33	40	---ER-32---
228.032.009.000	8-9	33	40	---ER-32---
228.032.010.000	9-10	33	40	---ER-32---
228.032.011.000	10-11	33	40	---ER-32---
228.032.012.000	11-12	33	40	---ER-32---
228.032.013.000	12-13	33	40	---ER-32---
228.032.014.000	13-14	33	40	---ER-32---
228.032.015.000	14-15	33	40	---ER-32---
228.032.016.000	15-16	33	40	---ER-32---
228.032.017.000	16-17	33	40	---ER-32---
228.032.018.000	17-18	33	40	---ER-32---

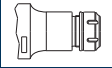
ART.	(mm)			
	Ød	ØD	L	
228.032.019.000	18-19	33	40	---ER-32---
228.032.020.000	19-20	33	40	---ER-32---
228.040.004.000	3-4	41	46	---ER-40---
228.040.005.000	4-5	41	46	---ER-40---
228.040.006.000	5-6	41	46	---ER-40---
228.040.007.000	6-7	41	46	---ER-40---
228.040.008.000	7-8	41	46	---ER-40---
228.040.009.000	8-9	41	46	---ER-40---
228.040.010.000	9-10	41	46	---ER-40---
228.040.011.000	10-11	41	46	---ER-40---
228.040.012.000	11-12	41	46	---ER-40---
228.040.013.000	12-13	41	46	---ER-40---
228.040.014.000	13-14	41	46	---ER-40---
228.040.015.000	14-15	41	46	---ER-40---
228.040.016.000	15-16	41	46	---ER-40---
228.040.017.000	16-17	41	46	---ER-40---
228.040.018.000	17-18	41	46	---ER-40---
228.040.019.000	18-19	41	46	---ER-40---
228.040.020.000	19-20	41	46	---ER-40---
228.040.021.000	20-21	41	46	---ER-40---
228.040.022.000	21-22	41	46	---ER-40---
228.040.023.000	22-23	41	46	---ER-40---
228.040.024.000	23-24	41	46	---ER-40---
228.040.025.000	24-25	41	46	---ER-40---
228.040.026.000	25-26	41	46	---ER-40---
228.040.027.000	26-27	41	46	---ER-40---
228.040.028.000	27-28	41	46	---ER-40---
228.040.029.000	28-29	41	46	---ER-40---
228.040.030.000	29-30	41	46	---ER-40---

ART. SET 228-ER16

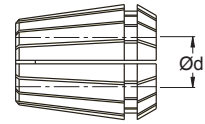

SET PINZA AUTOESTRAIBILE DIN 6499
AUTO-CENTERING COLLET SET DIN 6499
SELBSTZENTRIER-SPANNZANGEN-SATZ DIN 6499
JEU PINCE AUTO-EXTRACTIBLE DIN 6499

**Ød 1÷10mm
n° 10 Pinze - Collet**

Contenuto del KIT - SET Content

Q.	ART.	Ød	Q.	ART.	Ød	Q.	ART.	Ød						
n°1	228.016.001.000	0,5-1	n°1	228.016.005.000	4-5	n°1	228.016.009.000	8-9						
n°1	228.016.002.000	1,5-2	n°1	228.016.006.000	5-6	n°1	228.016.010.000	9-10						
n°1	228.016.003.000	2,5-3	n°1	228.016.007.000	6-7									
n°1	228.016.004.000	3-4	n°1	228.016.008.000	7-8									

ART. SET 228-ER25

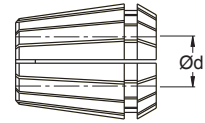

SET PINZA AUTOESTRAIBILE DIN 6499
AUTO-CENTERING COLLET SET DIN 6499
SELBSTZENTRIER-SPANNZANGEN-SATZ DIN 6499
JEU PINCE AUTO-EXTRACTIBLE DIN 6499

**Ød 2÷16mm
n° 15 Pinze - Collet**

Contenuto del KIT - SET Content

Q.	ART.	Ød	Q.	ART.	Ød	Q.	ART.	Ød	Q.	ART.	Ød			
n°1	228.025.002.000	1,5-2	n°1	228.025.006.000	5-6	n°1	228.025.010.000	9-10	n°1	228.025.014.000	13-14			
n°1	228.025.003.000	2,5-3	n°1	228.025.007.000	6-7	n°1	228.025.011.000	10-11	n°1	228.025.015.000	14-15			
n°1	228.025.004.000	3-4	n°1	228.025.008.000	7-8	n°1	228.025.012.000	11-12	n°1	228.025.016.000	15-16			
n°1	228.025.005.000	4-5	n°1	228.025.009.000	8-9	n°1	228.025.013.000	12-13						

ART. SET 228-ER32

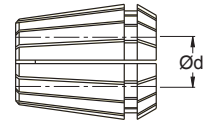

SET PINZA AUTOESTRAIBILE DIN 6499
AUTO-CENTERING COLLET SET DIN 6499
SELBSTZENTRIER-SPANNZANGEN-SATZ DIN 6499
JEU PINCE AUTO-EXTRACTIBLE DIN 6499

**Ød 3÷20mm
n° 18 Pinze - Collet**

Contenuto del KIT - SET Content

Q.	ART.	Ød	Q.	ART.	Ød	Q.	ART.	Ød	Q.	ART.	Ød	Q.	ART.	Ød
n°1	228.032.003.000	2-3	n°1	228.032.007.000	6-7	n°1	228.032.011.000	10-11	n°1	228.032.015.000	14-15	n°1	228.032.019.000	18-19
n°1	228.032.004.000	3-4	n°1	228.032.008.000	7-8	n°1	228.032.012.000	11-12	n°1	228.032.016.000	15-16	n°1	228.032.020.000	19-20
n°1	228.032.005.000	4-5	n°1	228.032.009.000	8-9	n°1	228.032.013.000	12-13	n°1	228.032.017.000	16-17			
n°1	228.032.006.000	5-6	n°1	228.032.010.000	9-10	n°1	228.032.014.000	13-14	n°1	228.032.018.000	17-18			

ART. SET 228-ER40

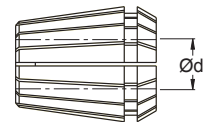

SET PINZA AUTOESTRAIBILE DIN 6499
AUTO-CENTERING COLLET SET DIN 6499
SELBSTZENTRIER-SPANNZANGEN-SATZ DIN 6499
JEU PINCE AUTO-EXTRACTIBLE DIN 6499

**Ød 4÷26mm
n° 23 Pinze - Collet**

Contenuto del KIT - SET Content

Q.	ART.	Ød	Q.	ART.	Ød	Q.	ART.	Ød	Q.	ART.	Ød	Q.	ART.	Ød
n°1	228.040.004.000	3-4	n°1	228.040.008.000	7-8	n°1	228.040.012.000	11-12	n°1	228.040.016.000	15-16	n°1	228.040.020.000	19-20
n°1	228.040.005.000	4-5	n°1	228.040.009.000	8-9	n°1	228.040.013.000	12-13	n°1	228.040.017.000	16-17	n°1	228.040.021.000	20-21
n°1	228.040.006.000	5-6	n°1	228.040.010.000	9-10	n°1	228.040.014.000	13-14	n°1	228.040.018.000	17-18	n°1	228.040.022.000	21-22
n°1	228.040.007.000	6-7	n°1	228.040.011.000	10-11	n°1	228.040.015.000	14-15	n°1	228.040.019.000	18-19	n°1	228.040.023.000	22-23
												n°1	228.040.024.000	23-24
												n°1	228.040.025.000	24-25
												n°1	228.040.026.000	25-26

ART. 228Q..

Raccomandata
Recommended

ER-DIN 6499

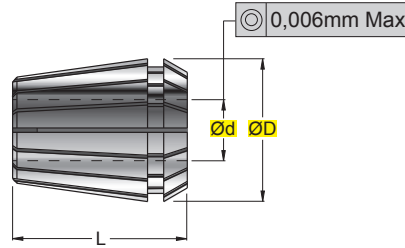

PINZA AUTOESTRAIBILE DI PRECISIONE DIN 6499
PRECISION AUTO-CENTERING COLLET
PRÄZISIONS-SELBSTZETRIERER - SPANNZANGE
PINCE AUTO-EXTRACTIBLE DE PRECISION

ART.	(mm)		L	
	Ød	ØD		
228Q.011.001.000	0,5-1	11,5	18	---ER-11---
228Q.011.001.500	1-1,5	11,5	18	---ER-11---
228Q.011.002.000	1,5-2	11,5	18	---ER-11---
228Q.011.002.500	2-2,5	11,5	18	---ER-11---
228Q.011.003.000	2,5-3	11,5	18	---ER-11---
228Q.011.003.500	3-3,5	11,5	18	---ER-11---
228Q.011.004.000	3,5-4	11,5	18	---ER-11---
228Q.011.004.500	4-4,5	11,5	18	---ER-11---
228Q.011.005.000	4,5-5	11,5	18	---ER-11---
228Q.011.005.500	5-5,5	11,5	18	---ER-11---
228Q.011.006.000	5,5-6	11,5	18	---ER-11---
228Q.011.006.500	6-6,5	11,5	18	---ER-11---
228Q.011.007.000	6,5-7	11,5	18	---ER-11---
228Q.016.001.000	0,5-1	17,0	27,5	---ER-16---
228Q.016.001.500	1-1,5	17,0	27,5	---ER-16---
228Q.016.002.000	1,5-2	17,0	27,5	---ER-16---
228Q.016.002.500	2-2,5	17,0	27	---ER-16---
228Q.016.003.000	2,5-3	17,0	27	---ER-16---
228Q.016.004.000	3-4	17,0	27,5	---ER-16---
228Q.016.005.000	4-5	17,0	27	---ER-16---
228Q.016.006.000	5-6	17,0	27	---ER-16---
228Q.016.007.000	6-7	17,0	27	---ER-16---
228Q.016.008.000	7-8	17,0	27,5	---ER-16---
228Q.016.009.000	8-9	17,0	27	---ER-16---
228Q.016.010.000	9-10	17,0	27	---ER-16---
228Q.025.001.000	0,5-1	26,0	35	---ER-25---
228Q.025.001.500	1-1,5	26,0	35	---ER-25---
228Q.025.002.000	1,5-2	26,0	35	---ER-25---
228Q.025.002.500	2-2,5	26,0	34	---ER-25---
228Q.025.003.000	2,5-3	26,0	35	---ER-25---
228Q.025.004.000	3-4	26,0	35	---ER-25---
228Q.025.005.000	4-5	26,0	34	---ER-25---
228Q.025.006.000	5-6	26,0	35	---ER-25---
228Q.025.007.000	6-7	26,0	35	---ER-25---
228Q.025.008.000	7-8	26,0	34	---ER-25---
228Q.025.009.000	8-9	26,0	35	---ER-25---
228Q.025.010.000	9-10	26,0	35	---ER-25---
228Q.025.011.000	10-11	26,0	35	---ER-25---
228Q.025.012.000	11-12	26,0	35	---ER-25---
228Q.025.013.000	12-13	26,0	35	---ER-25---
228Q.025.014.000	13-14	26,0	35	---ER-25---
228Q.025.015.000	14-15	26,0	35	---ER-25---
228Q.025.016.000	15-16	26,0	34	---ER-25---
228Q.032.002.000	1,5-2	33	40	---ER-32---
228Q.032.002.500	2-2,5	33	40	---ER-32---
228Q.032.003.000	2,5-3	33	40	---ER-32---
228Q.032.004.000	3-4	33	40	---ER-32---
228Q.032.005.000	4-5	33	40	---ER-32---
228Q.032.006.000	5-6	33	40	---ER-32---
228Q.032.007.000	6-7	33	40	---ER-32---
228Q.032.008.000	7-8	33	40	---ER-32---
228Q.032.009.000	8-9	33	40	---ER-32---
228Q.032.010.000	9-10	33	40	---ER-32---
228Q.032.011.000	10-11	33	40	---ER-32---
228Q.032.012.000	11-12	33	40	---ER-32---
228Q.032.013.000	12-13	33	40	---ER-32---
228Q.032.014.000	13-14	33	40	---ER-32---
228Q.032.015.000	14-15	33	40	---ER-32---
228Q.032.016.000	15-16	33	40	---ER-32---

ART.	(mm)			
	Ød	ØD	L	
228Q.032.017.000	16-17	33	40	---ER-32---
228Q.032.018.000	17-18	33	40	---ER-32---
228Q.032.019.000	18-19	33	40	---ER-32---
228Q.032.020.000	19-20	33	40	---ER-32---
228Q.040.004.000	3-4	41	46	---ER-40---
228Q.040.005.000	4-5	41	46	---ER-40---
228Q.040.006.000	5-6	41	46	---ER-40---
228Q.040.007.000	6-7	41	46	---ER-40---
228Q.040.008.000	7-8	41	46	---ER-40---
228Q.040.009.000	8-9	41	46	---ER-40---
228Q.040.010.000	9-10	41	46	---ER-40---
228Q.040.011.000	10-11	41	46	---ER-40---
228Q.040.012.000	11-12	41	46	---ER-40---
228Q.040.013.000	12-13	41	46	---ER-40---
228Q.040.014.000	13-14	41	46	---ER-40---
228Q.040.015.000	14-15	41	46	---ER-40---
228Q.040.016.000	15-16	41	46	---ER-40---
228Q.040.017.000	16-17	41	46	---ER-40---
228Q.040.018.000	17-18	41	46	---ER-40---
228Q.040.019.000	18-19	41	46	---ER-40---
228Q.040.020.000	19-20	41	46	---ER-40---
228Q.040.021.000	20-21	41	46	---ER-40---
228Q.040.022.000	21-22	41	46	---ER-40---
228Q.040.023.000	22-23	41	46	---ER-40---
228Q.040.024.000	23-24	41	46	---ER-40---
228Q.040.025.000	24-25	41	46	---ER-40---
228Q.040.026.000	25-26	41	46	---ER-40---

ART. 230..

ER-DIN 6499

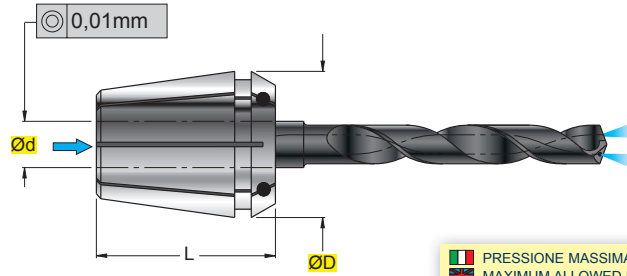

PINZA AUTOESTRAIBILE CON GOMMA DI TENUTA DIN 6499
AUTO-CENTERING COLLET WITH RETAINING RUBBER DIN 6499
SELBSTZENTRIER-SPANNZANGEN MIT DICHTGUMMI DIN 6499
PINCE AUTO-EXTRACTIBLE AVEC JOINT D'ÉTANCHÉITÉ DIN 6499

PRESSIONE MASSIMA CONSENTITA 25 bar
 MAXIMUM ALLOWED PRESSURE 25 BAR
 MAXIMAL ZULÄSSIGER DRUCK 25 BAR
 PRESSION MAXIMUM AUTORISÉE 25 bars

(mm)





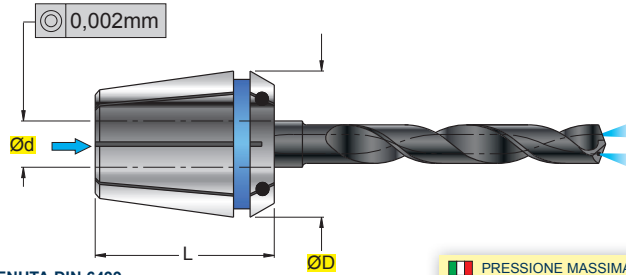

ART.	Ød	ØD	L	
230.025.003.000	3	26	35	---ER-25---
230.025.004.000	4	26	35	---ER-25---
230.025.005.000	5	26	35	---ER-25---
230.025.006.000	6	26	35	---ER-25---
230.025.007.000	7	26	35	---ER-25---
230.025.008.000	8	26	35	---ER-25---
230.025.009.000	9	26	35	---ER-25---
230.025.010.000	10	26	35	---ER-25---
230.025.011.000	11	26	35	---ER-25---
230.025.012.000	12	26	35	---ER-25---
230.025.013.000	13	26	35	---ER-25---
230.025.014.000	14	26	35	---ER-25---
230.025.015.000	15	26	35	---ER-25---
230.025.016.000	16	26	35	---ER-25---
230.032.003.000	3	33	40	---ER-32---
230.032.004.000	4	33	40	---ER-32---
230.032.005.000	5	33	40	---ER-32---
230.032.006.000	6	33	40	---ER-32---
230.032.007.000	7	33	40	---ER-32---
230.032.008.000	8	33	40	---ER-32---
230.032.009.000	9	33	40	---ER-32---
230.032.010.000	10	33	40	---ER-32---
230.032.011.000	11	33	40	---ER-32---
230.032.012.000	12	33	40	---ER-32---
230.032.013.000	13	33	40	---ER-32---
230.032.014.000	14	33	40	---ER-32---
230.032.015.000	15	33	40	---ER-32---
230.032.016.000	16	33	40	---ER-32---
230.032.017.000	17	33	40	---ER-32---
230.032.018.000	18	33	40	---ER-32---
230.032.019.000	19	33	40	---ER-32---
230.032.020.000	20	33	40	---ER-32---
230.040.004.000	4	41	46	---ER-40---
230.040.005.000	5	41	46	---ER-40---
230.040.006.000	6	41	46	---ER-40---
230.040.007.000	7	41	46	---ER-40---
230.040.008.000	8	41	46	---ER-40---
230.040.009.000	9	41	46	---ER-40---
230.040.010.000	10	41	46	---ER-40---
230.040.011.000	11	41	46	---ER-40---
230.040.012.000	12	41	46	---ER-40---
230.040.013.000	13	41	46	---ER-40---
230.040.014.000	14	41	46	---ER-40---
230.040.015.000	15	41	46	---ER-40---
230.040.016.000	16	41	46	---ER-40---
230.040.017.000	17	41	46	---ER-40---
230.040.018.000	18	41	46	---ER-40---
230.040.019.000	19	41	46	---ER-40---
230.040.020.000	20	41	46	---ER-40---
230.040.021.000	21	41	46	---ER-40---
230.040.022.000	22	41	46	---ER-40---
230.040.023.000	23	41	46	---ER-40---
230.040.024.000	24	41	46	---ER-40---
230.040.025.000	25	41	46	---ER-40---
230.040.026.000	26	41	46	---ER-40---

ART. 230QN..

ER-DIN 6499



PINZA AUTOESTRAIBILE DI PRECISIONE CON GOMMA DI TENUTA DIN 6499
PRECISION AUTO-CENTERING COLLET WITH RETAINING RUBBER DIN 6499
PRÄZISIONS-SELBSTZENTRIER-SPANNZANGEN MIT DICHTGUMMI DIN 6499
PINCE AUTO-EXTRACTIBLE DE PRECISION AVEC JOINT D'ÉTANCHÉITÉ DIN 6499

 PRESSIONE MASSIMA CONSENTITA 25 bar
 MAXIMUM ALLOWED PRESSURE 25 BAR
 MAXIMAL ZULÄSSIGER DRUCK 25 BAR
 PRESSION MAXIMUM AUTORISÉE 25 bars

ART.	(mm)			---ER---
	Ød	ØD	L	
230QN.025.006.000	6	25,7	34	---ER-25---
230QN.025.007.000	7	25,7	34	---ER-25---
230QN.025.008.000	8	25,7	34	---ER-25---
230QN.025.009.000	9	25,7	34	---ER-25---
230QN.025.010.000	10	25,7	34	---ER-25---
230QN.025.011.000	11	25,7	34	---ER-25---
230QN.025.012.000	12	25,7	34	---ER-25---
230QN.025.013.000	13	25,7	34	---ER-25---
230QN.025.014.000	14	25,7	34	---ER-25---
230QN.025.015.000	15	25,7	34	---ER-25---
230QN.025.016.000	16	25,7	34	---ER-25---
230QN.032.006.000	6	32,7	40	---ER-32---
230QN.032.007.000	7	32,7	40	---ER-32---
230QN.032.008.000	8	32,7	40	---ER-32---
230QN.032.009.000	9	32,7	40	---ER-32---
230QN.032.010.000	10	32,7	40	---ER-32---
230QN.032.011.000	11	32,7	40	---ER-32---
230QN.032.012.000	12	32,7	40	---ER-32---
230QN.032.013.000	13	32,7	40	---ER-32---
230QN.032.014.000	14	32,7	40	---ER-32---
230QN.032.015.000	15	32,7	40	---ER-32---
230QN.032.016.000	16	32,7	40	---ER-32---
230QN.032.017.000	17	32,7	40	---ER-32---
230QN.032.018.000	18	32,7	40	---ER-32---
230QN.040.006.000	6	40,7	46	---ER-40---
230QN.040.008.000	8	40,7	46	---ER-40---
230QN.040.010.000	10	40,7	46	---ER-40---
230QN.040.012.000	12	40,7	46	---ER-40---
230QN.040.014.000	14	40,7	46	---ER-40---
230QN.040.016.000	16	40,7	46	---ER-40---
230QN.040.018.000	18	40,7	46	---ER-40---

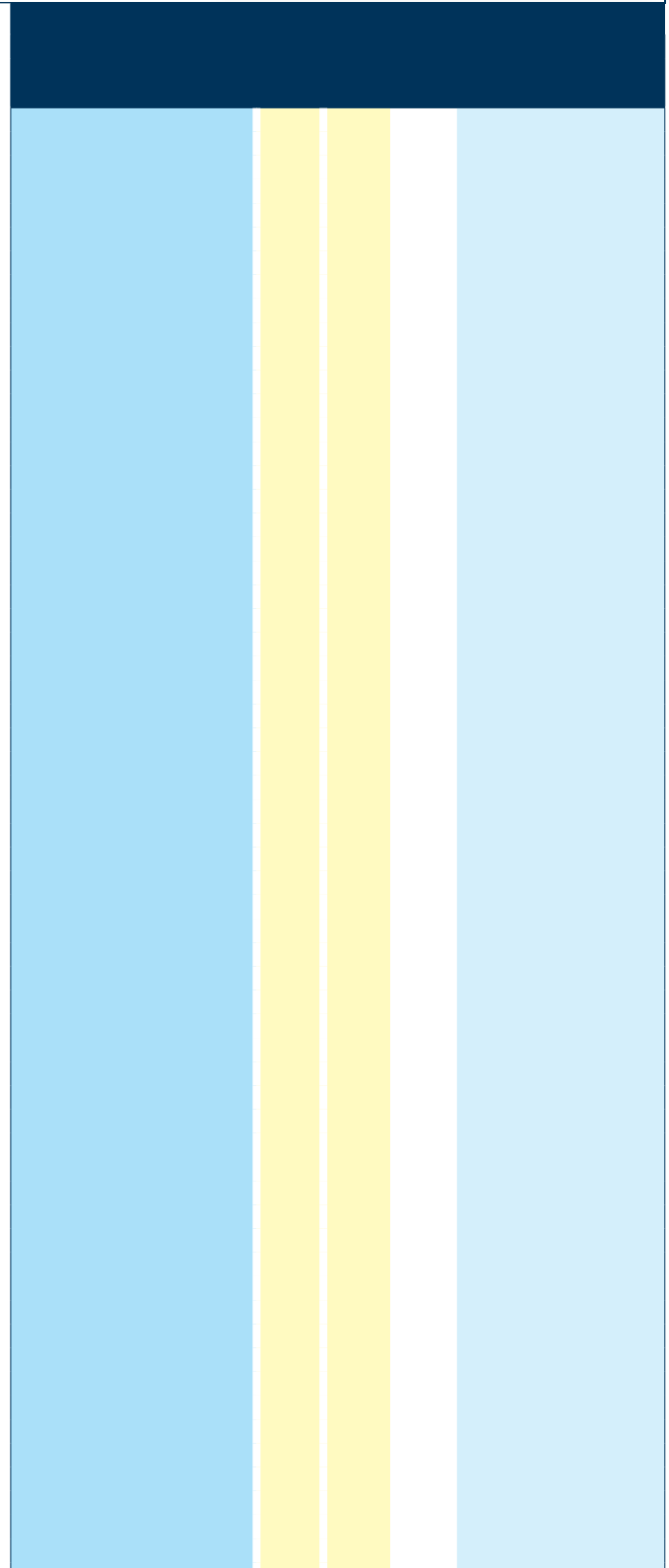

ART. 328..

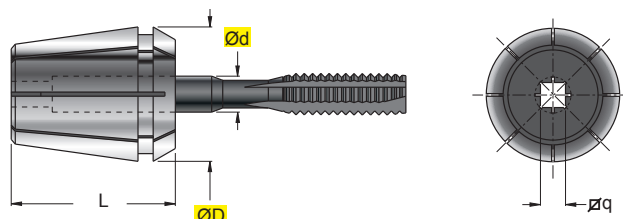

PINZA AUTOESTRAIBILE PORTA MASCHI DIN 6499-AZ
AUTO-CENTERING COLLET TAP HOLDERS DIN 6499-AZ
SELBSTZENTRIER-SPANNZANGEN GEWINDEBOHREAUFNAHME DIN 6499-AZ
PINCE AUTO-EXTRACTIBLE PORTE TAURAUDS DIN 6499-AZ

ART.	Ød	ØD	L	øq	
328.016.035.027	3,5	17	27,5	2,7	---ER-16---
328.016.040.030	4,0	17	27,5	3,0	---ER-16---
328.016.045.034	4,5	17	27,5	3,4	---ER-16---
328.016.050.040	5,0	17	27,5	4,0	---ER-16---
328.016.055.043	5,5	17	27,5	4,3	---ER-16---
328.016.060.049	6,0	17	27,5	4,9	---ER-16---
328.016.063.050	6,3	17	27,5	5,0	---ER-16---
328.016.070.055	7,0	17	27,5	5,5	---ER-16---
328.016.080.062	8,0	17	27,5	6,2	---ER-16---
328.016.090.070	9,0	17	27,5	7,0	---ER-16---
328.016.100.080	10,0	17	27,5	8,0	---ER-16---
328.025.045.034	4,5	26	34	3,4	---ER-25---
328.025.055.043	5,5	26	34	4,3	---ER-25---
328.025.060.049	6,0	26	34	4,9	---ER-25---
328.025.070.055	7,0	26	34	5,5	---ER-25---
328.025.080.062	8,0	26	34	6,2	---ER-25---
328.025.090.070	9,0	26	34	7,0	---ER-25---
328.025.100.080	10,0	26	34	8,0	---ER-25---
328.025.110.090	11,0	26	34	9,0	---ER-25---
328.025.120.090	12,0	26	34	9,0	---ER-25---

ART.	Ød	ØD	L	øq	
328.032.045.034	4,5	33	40	3,4	---ER-32---
328.032.055.043	5,5	33	40	4,3	---ER-32---
328.032.060.049	6,0	33	40	4,9	---ER-32---
328.032.070.055	7,0	33	40	5,5	---ER-32---
328.032.080.062	8,0	33	40	6,2	---ER-32---
328.032.090.070	9,0	33	40	7,0	---ER-32---
328.032.100.080	10,0	33	40	8,0	---ER-32---
328.032.110.090	11,0	33	40	9,0	---ER-32---
328.032.120.090	12,0	33	40	9,0	---ER-32---
328.032.140.110	14,0	33	40	11,0	---ER-32---
328.032.160.120	16,0	33	40	12,0	---ER-32---
328.040.070.055	7,0	41	46	5,5	---ER-40---
328.040.080.062	8,0	41	46	6,2	---ER-40---
328.040.090.070	9,0	41	46	7,0	---ER-40---
328.040.100.080	10,0	41	46	8,0	---ER-40---
328.040.110.090	11,0	41	46	9,0	---ER-40---
328.040.120.090	12,0	41	46	9,0	---ER-40---
328.040.140.110	14,0	41	46	11,0	---ER-40---
328.040.160.120	16,0	41	46	12,0	---ER-40---
328.040.180.145	18,0	41	46	14,5	---ER-40---
328.040.200.160	20,0	41	46	16,0	---ER-40---

ART. 330..

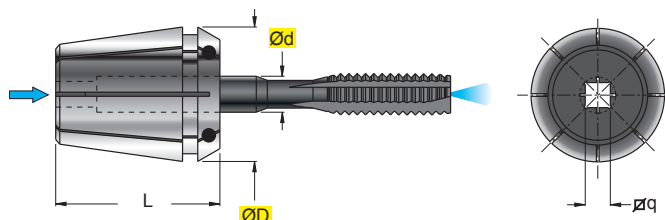

PINZA AUTOESTRAIBILE PORTA MASCHI CON GOMMA DI TENUTA
AUTO-CENTERING COLLET WITH RETAINING RUBBER
SELBSTZENTRIER-SPANNZANGEN MIT DICHTGUMMI
PINCE AUTO-EXTRACTIBLE PORTE-MALES AVEC CAOUTCHOUC D'ETANCHEITE

PRESSIONE MASSIMA CONSENTITA 25 bar
 MAXIMUM ALLOWED PRESSURE 25 BAR
 MAXIMAL ZULÄSSIGER DRUCK 25 BAR
 PRESSION MAXIMUM AUTORISEE 25 bars

ART.	Ød	ØD	L	øq	
330.016.040.030	4,0	17	27,5	3,0	---ER-16---
330.016.045.034	4,5	17	27,5	3,4	---ER-16---
330.016.050.040	5,0	17	27,5	4,0	---ER-16---
330.016.055.043	5,5	17	27,5	4,3	---ER-16---
330.016.060.049	6,0	17	27,5	4,9	---ER-16---
330.016.070.055	7,0	17	27,5	5,5	---ER-16---
330.016.080.062	8,0	17	27,5	6,2	---ER-16---
330.025.040.030	4,0	26	34	3,0	---ER-25---
330.025.045.034	4,5	26	34	3,4	---ER-25---
330.025.050.040	5,0	26	34	4,0	---ER-25---
330.025.055.043	5,5	26	34	4,3	---ER-25---
330.025.060.049	6,0	26	34	4,9	---ER-25---
330.025.070.055	7,0	26	34	5,5	---ER-25---
330.025.080.062	8,0	26	34	6,2	---ER-25---
330.025.090.070	9,0	26	34	7,0	---ER-25---
330.025.100.080	10,0	26	34	8,0	---ER-25---
330.025.110.090	11,0	26	34	9,0	---ER-25---
330.025.120.090	12,0	26	34	9,0	---ER-25---
330.032.045.034	4,5	33	40	3,4	---ER-32---
330.032.050.040	5,0	33	40	4,0	---ER-32---

ART.	Ød	ØD	L	øq	
330.032.055.043	5,5	33	40	4,3	---ER-32---
330.032.060.049	6,0	33	40	4,9	---ER-32---
330.032.070.055	7,0	33	40	5,5	---ER-32---
330.032.080.062	8,0	33	40	6,2	---ER-32---
330.032.090.070	9,0	33	40	7,0	---ER-32---
330.032.100.080	10,0	33	40	8,0	---ER-32---
330.032.110.090	11,0	33	40	9,0	---ER-32---
330.032.120.090	12,0	33	40	9,0	---ER-32---
330.032.140.110	14,0	33	40	11,0	---ER-32---
330.032.160.120	16,0	33	40	12,0	---ER-32---
330.040.060.049	6,0	41	46	4,9	---ER-40---
330.040.070.055	7,0	41	46	5,5	---ER-40---
330.040.080.062	8,0	41	46	6,2	---ER-40---
330.040.090.070	9,0	41	46	7,0	---ER-40---
330.040.100.080	10,0	41	46	8,0	---ER-40---
330.040.110.090	11,0	41	46	9,0	---ER-40---
330.040.120.090	12,0	41	46	9,0	---ER-40---
330.040.140.110	14,0	41	46	11,0	---ER-40---
330.040.160.120	16,0	41	46	12,0	---ER-40---
330.040.180.145	18,0	41	46	14,5	---ER-40---
330.040.200.160	20,0	41	46	16,0	---ER-40---

ART. 329..

NEW

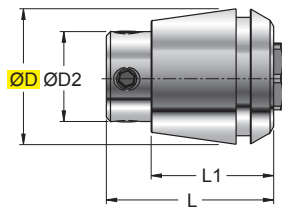
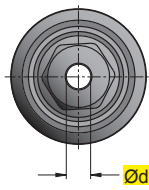

Corsa a Trazione
Tension stroke

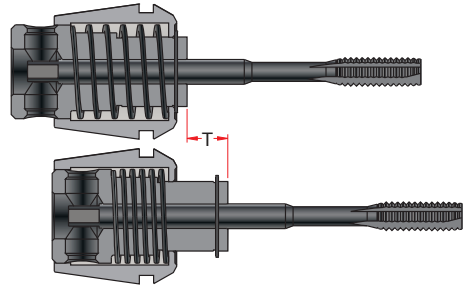

PINZA PORTAMASCHI CON COMPENSAZIONE ASSIALE DIN 6499
TAPPING COLLETS WITH AXIAL COMPENSATION DIN 6499
SPANNZANGE ZUM GEWINDEBOHREN MIT AXIALEM AUSGLEICH DIN 6499
PINCE PORTE-TARAUDS AVEC COMPENSATION AXIALE DIN 6499

ART.	Ød	ØD	ØD2	L	L1	T	
329.025.028.021	2,8	25	19	34	24,5	8	---ER-25---
329.025.035.027	3,5	25	19	34	24,5	8	---ER-25---
329.025.045.034	4,5	25	19	34	24,5	8	---ER-25---
329.025.060.049	6,0	25	19	34	24,5	8	---ER-25---
329.025.070.055	7,0	25	19	34	24,5	8	---ER-25---
329.025.080.062	8,0	25	19	34	24,5	8	---ER-25---
329.025.090.070	9,0	25	19	34	24,5	8	---ER-25---
329.025.100.080	10,0	25	19	34	24,5	8	---ER-25---

ART.	Ød	ØD	ØD2	L	L1	T	
329.032.045.034	4,5	32	23	43	31	10	---ER-32---
329.032.060.049	6,0	32	23	43	31	10	---ER-32---
329.032.070.055	7,0	32	23	43	31	10	---ER-32---
329.032.080.062	8,0	32	23	43	31	10	---ER-32---
329.032.090.070	9,0	32	23	43	31	10	---ER-32---
329.032.100.080	10,0	32	23	43	31	10	---ER-32---
329.032.110.090	11,0	32	23	43	31	10	---ER-32---
329.032.120.090	12,0	32	23	43	31	10	---ER-32---

SI MONTANO SU TUTTI I TIPI DI PORTAPINZA ER
IT FITS ON ALL TYPES OF ER COLLET CHUCKS
PASST ZU ALLEN ER-SPANNZANGENFUTTERN
À MONTER SUR TOUS LES TYPES DE PORTE-PINCE ER

L'UTILIZZO DEL REFRIGERANTE ATTRAVERSO LA PINZA È SCONSIGLIATO
COOLING THROUGH THE COLLET IS NOT RECOMMENDED
KÜHLUNG DURCH DIE SPANNZANGE NICHT EMPFOHLEN
L'UTILISATION DU RÉFRIGÉRANT À TRAVERS LA PINCE EST DÉCONSEILLÉE

ART. 235..

NEW

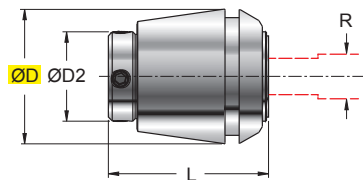
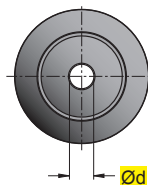

PINZA PER ALESATORI CON OSCILLAZIONE RADIALE DIN 6499
COLLET WITH RADIAL COMPENSATION FOR REAMING DIN 6499
SPANNZANGEN MIT RADIALAUSGLEICH ZUM REIBEN DIN6499
PINCE POUR ALESOIRS AVEC OSCILLATION RADIALE DIN 6499

ART.	Ød	ØD	ØD2	L	R	
235.025.030.000	3,0	25	18,5	35	0,5	---ER-25---
235.025.040.000	4,0	25	18,5	35	0,5	---ER-25---
235.025.050.000	5,0	25	18,5	35	0,5	---ER-25---
235.025.060.000	6,0	25	18,5	35	0,5	---ER-25---
235.025.070.000	7,0	25	18,5	35	0,5	---ER-25---
235.025.080.000	8,0	25	18,5	35	0,5	---ER-25---
235.025.090.000	9,0	25	18,5	35	0,5	---ER-25---
235.025.100.000	10,0	25	18,5	35	0,5	---ER-25---

SI MONTANO SU TUTTI I TIPI DI PORTAPINZA ER
IT FITS ON ALL TYPES OF ER COLLET CHUCKS
PASST ZU ALLEN ER-SPANNZANGENFUTTERN
À MONTER SUR TOUS LES TYPES DE PORTE-PINCE ER

ADATTE ANCHE PER LA MASCHIATURA RIGIDA
ALSO SUITABLE FOR RIGID TAPPING OPERATIONS
AUCH ZUM SYNCHRONISIERTEN GEWINDEBOHREN GEEIGNET
CONVIENT ÉGALEMENT POUR LE TARAUDAGE RIGIDE

ART.	Ød	ØD	ØD2	L	R	
235.032.040.000	4,0	32	24	44	0,5	---ER-32---
235.032.050.000	5,0	32	24	44	0,5	---ER-32---
235.032.060.000	6,0	32	24	44	0,5	---ER-32---
235.032.070.000	7,0	32	24	44	0,5	---ER-32---
235.032.080.000	8,0	32	24	44	0,5	---ER-32---
235.032.090.000	9,0	32	24	44	0,5	---ER-32---
235.032.100.000	10,0	32	24	44	0,5	---ER-32---
235.032.110.000	11,0	32	24	44	0,5	---ER-32---
235.032.120.000	12,0	32	24	44	0,5	---ER-32---
235.032.140.000	14,0	32	24	44	0,5	---ER-32---

L'UTILIZZO DEL REFRIGERANTE ATTRAVERSO LA PINZA È SCONSIGLIATO
COOLING THROUGH THE COLLET IS NOT RECOMMENDED
KÜHLUNG DURCH DIE SPANNZANGE NICHT EMPFOHLEN
L'UTILISATION DU RÉFRIGÉRANT À TRAVERS LA PINCE EST DÉCONSEILLÉE

ART. 216..

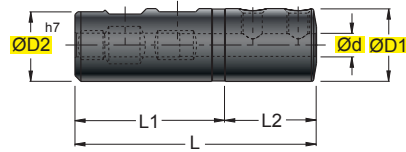

BOCCOLA DI RIDUZIONE PER UTENSILE PER MINIALESATURA
COLLET ADAPTERS FOR MINI BOHRING TOOL
REDUKTION FÜR MINI BOHRSTANGE
DOUILLE DE RÉDUCTION POUR OUTIL À ALÉSÉR MINIATURE

0,005

(mm)							1505	5025
ART.	ØD2	Ød	ØD1	L	L1	L2		
216.016.005.016	16	5	16	53	33	20	GR606	5003
216.016.006.016	16	6	16	55	33	22		
216.016.008.020	16	8	20	60	33	27		
216.016.010.022	16	10	22	60	33	27		
216.016.012.024	16	12	24	65	33	32		

ART. CIL.. MF..W

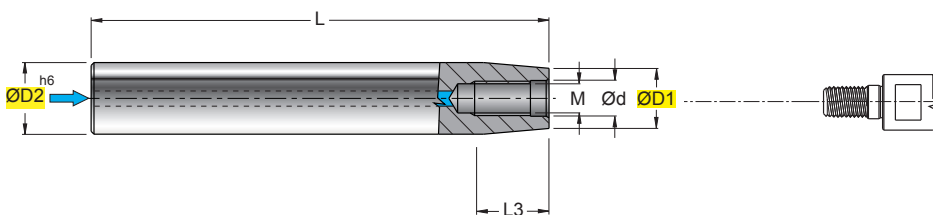

art. 253..VW
S1089W..
S1503.9W..
S2000.89W..
S613/4.9.45W..
S659W...
S809W...
S849W...
S929...
S959...
S9002.9W..
S9004.9W..
S9005.9W..
S9006.9W..

PROLUNGA IN ACCIAIO CON ATTACCO CILINDRICO PER MODULARE FILETTATO
STEEL EXTENSION WITH CYLINDRICAL CONNECTION FOR THREADED MODULAR TOOL SYSTEM
STAHLVERLÄNGERUNG MIT ZYLINDRAUFNAHME FÜR GEWINDE-MODULARWERKZEUGSYSTEM
RALLONGE EN ACIER AVEC ATTACHEMENT CILYNDRIQUE POUR LE SYSTEME MODULAIRE FILETÉ

(mm)						
ART.	M	Ød	ØD1	ØD2	L	L3
CIL.012.MF005.115W	5	5,5	8	12	115	14
CIL.012.MF006.115W	6	6,5	10	12	115	14
CIL.016.MF008.127W	8	8,5	13	16	127	15
CIL.020.MF010.140W	10	10,5	18	20	140	15
CIL.025.MF012.160W	12	12,5	21	25	160	20
CIL.032.MF016.187W	16	17,0	29	32	187	20

ART. CIL..CTS..W

NEW

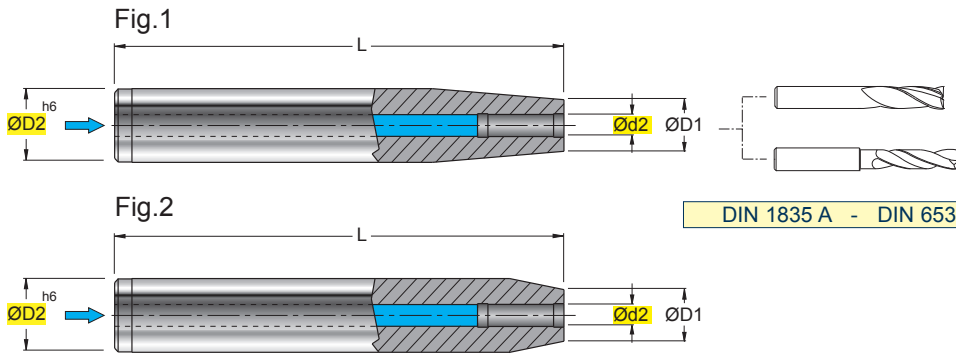

PROLUNGA IN ACCIAIO CON ATTACCO A CALETTAMENTO TERMICO
STEEL SHRINK-FIT EXTENSION
STAHLVERLÄNGERUNG MIT SCHRUMPFVERBINDUNG
RALLONGE EN ACIER AVEC ATTACHEMENT À EMBOÎTEMENT THERMIQUE

(mm)											
ART.	Ød2	ØD1	ØD2 ^{h6}	L	Fig.						
CIL.012.CTS003.160W	3	8	12	160	2						
CIL.012.CTS004.160W	4	8	12	160	2						
CIL.016.CTS003.160W	3	10	16	160	2						
CIL.016.CTS004.160W	4	10	16	160	2						
CIL.016.CTS005.160W	5	10	16	160	2						
CIL.016.CTS006.160W	6	10	16	160	2						
CIL.020.CTS006.160W	6	10	20	160	2						
CIL.020.CTS008.160W	8	12	20	160	2						
CIL.025.CTS010.160W	10	20	25	160	2						
CIL.025.CTS010.200W	10	20	25	200	2						
CIL.025.CTS012.160W	12	20	25	160	2						
CIL.025.CTS012.200W	12	20	25	200	2						
CIL.025.CTS014.160W	14	20	25	160	2						
CIL.025.CTS016.160W	16	22	25	160	2						
CIL.025.CTS016.200W	16	22	25	200	2						
CIL.032.CTS016.200W	16	22	32	200	1						

ART. CIL.. MFV..W

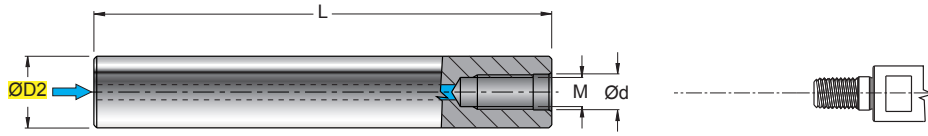

art. 253..VW
S1089W..
S1503.9W..
S2000.89W..
S613/4.9.45W..
S659W..
S809W..
S849W..
S929..
S959..
S9002.9W..
S9004.9W..
S9005.9W..
S9006.9W..

PROLUNGA ANTIVIBRANTE IN METALLO DURO CON ATTACCO CILINDRICO PER MODULARE FILETTATO
DAMPED SOLID CARBIDE EXTENSION WITH CYLINDRICAL SHANK FOR THREADED MODULAR SYSTEM
SCHWINGUNGSGEDÄMPFTE VOLLHARTMETALLVERLÄNGERUNG MIT ZYLINDERAUFNAHME FÜR MODULARSYSTEM
RALLONGE ANTIVIBRATOIRE EN CARBURE AVEC QUEUE CYLINDRIQUE POUR SYSTEME MODULAIRE FILETE

(mm)												
ART.	M	Ød	ØD2	L	kg							
CIL_010.MFV005.075W	5	5,5	10	75	0,07							
CIL_010.MFV005.100W	5	5,5	10	100	0,10							
CIL_010.MFV005.150W	5	5,5	10	150	0,15							
CIL_012.MFV006.075W	6	6,5	12	75	0,11							
CIL_012.MFV006.100W	6	6,5	12	100	0,14							
CIL_012.MFV006.150W	6	6,5	12	150	0,22							
CIL_014.MFV008.100W	8	8,5	14	100	0,16							
CIL_014.MFV008.150W	8	8,5	14	150	0,30							
CIL_014.MFV008.200W	8	8,5	14	200	0,41							
CIL_016.MFV008.100W	8	8,5	16	100	0,26							
CIL_016.MFV008.150W	8	8,5	16	150	0,38							
CIL_016.MFV008.200W	8	8,5	16	200	0,52							
CIL_020.MFV010.150W	10	10,5	20	150	0,59							
CIL_020.MFV010.200W	10	10,5	20	200	0,80							
CIL_020.MFV010.250W	10	10,5	20	250	1,01							
CIL_025.MFV012.150W	12	12,5	25	150	0,93							
CIL_025.MFV012.200W	12	12,5	25	200	1,26							
CIL_025.MFV012.250W	12	12,5	25	250	1,58							
CIL_025.MFV012.300W	12	12,5	25	300	1,91							
CIL_032.MFV016.150W	16	17,0	32	150	1,50							
CIL_032.MFV016.200W	16	17,0	32	200	2,05							
CIL_032.MFV016.250W	16	17,0	32	250	2,59							
CIL_032.MFV016.300W	16	17,0	32	300	3,15							

ART. 253..VW

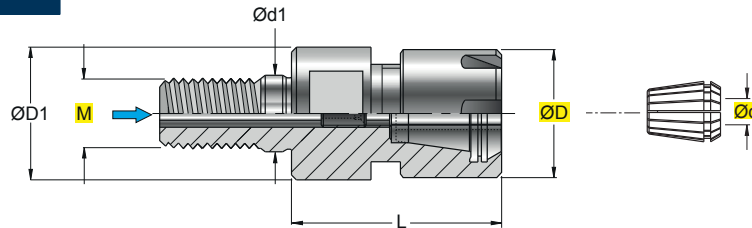

art. 228..
228Q.. (Recommended)
230..
230QN..
328..
330..
329..
235..

ADATTATORE PORTAPINZA CON ATTACCO FILETTATO
COLLET CHUCK ADAPTER WITH THREADED CONNECTION
SPANNZANGENFUTTER-ADAPTER MIT GEWINDEAUFNAHME
ADAPTEUR PORTE-PINCE AVEC RACCORD FILETE

(mm)											
ART.	M	Ød	Ød1	ØD	ØD1	L					
253.016.022.040VW New	16	0,5-10	17,0	22	29	40	RGM ER16				938.016
253.016.035.045VW	16	0,5-16	17,0	35	29	45	RGM ER25				938.025

ART. CWE..MC..

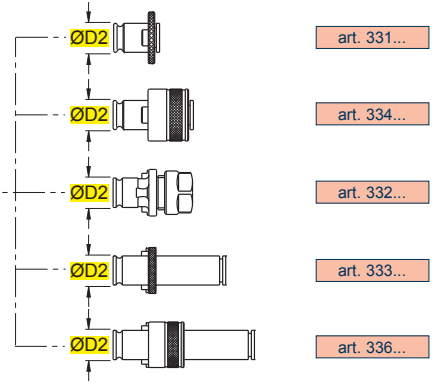
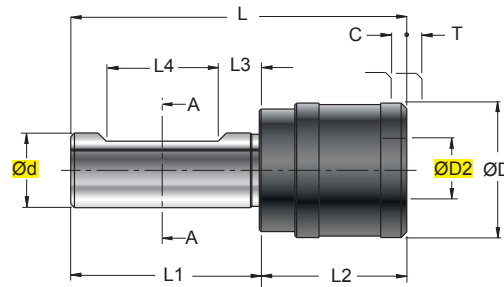
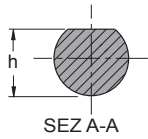

PORTAMASCHIO A CAMBIO RAPIDO CON DOPPIA COMPENSAZIONE ASSIALE
QUICK-CHANGE TAP HOLDER WITH DOUBLE AXIAL COMPENSATION
GEWINDESCHNEID-SCHNELLWECHSELFUTTER MIT DOPPELAUSGLEICH
MANDRINS DE TARAUDAGE À CHANGEMENT RAPIDE À DOUBLE COMPENSATION AXIALE

(mm)

ART.	ØD	Ød	ØD2	L	L1	L2	L3	L4	h	C	T
CWE.020.MC019.041	38	20	19	90	50	40	10,5	30	18	7,5	7,5
CWE.025.MC031.063	55	25	31	120	56	64	10,5	30	23	12,5	12,5
CWE.032.MC048.109	79	32	48	169	60	109	6,0	37	30	24	24

ART. CWE..MS..

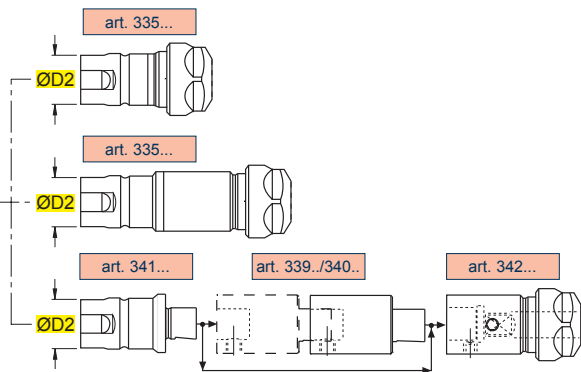
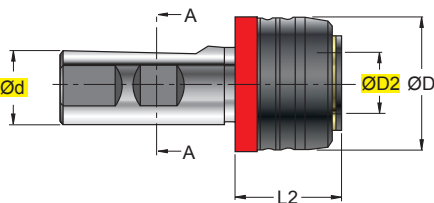
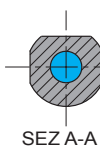

PORTAMASCHIO PER MASCHIATURA SINCRONIZZATA
TAP HOLDERS FOR SYNCHRONIZED TAPPING
GEWINDEBOHRERHALTER FÜR SYNCHRON STEUERUNG
MANDRINS DE TARAUDAGE POUR TARAUDAGE SYNCHRONISÉ

(mm)

ART.	ØD	Ød	ØD2	L2
CWE.025.MS016.034	43	25	20	34
CWE.025.MS020.056	60	25	32	56
CWE.040.MS033.080	87	40	50	80

CARATTERISTICHE TECNICHE - TECHNICAL CHARACTERISTICS

1. Perfetto allineamento maschio-foro: 0,003 mm
2. Durata del maschio tripla rispetto ad un sistema di maschiatura tradizionale
3. Cambio rapido del maschio e della bussola
4. Adatto per maschiatura rigida sincronizzata con compensazione in sfilamento (1mm) ed in rientro (0,2mm)
5. Predisposto per il passaggio della lubrificazione fino a 50 bar
6. Ingombro ridotto

BUSSOLE SENZA FRIZIONE

TAP ADAPTERS WITHOUT OVERLOAD CLUTCH.

GEWINDEBOHRERAUFNABME OHNE DREHMOMENTBEGRENZUNG

DOUILLES SANS EMBRAYAGE.

		DIN371	DIN376-374	DIN353	DIN2182	DIN2183
331.019.028.021		M2-M2,5				
331.019.035.027	333.019.035.027	M3	M5		1/8"	
331.019.040.030		M3,5				
331.019.045.034	333.019.045.034	M4	M6		5/32"	1/4"
331.019.060.049	333.019.060.049	M5-M6	M8		7/32"	
331.019.070.055	333.019.070.055		M10	R1/8"	1/4"	3/8"
331.019.080.062	333.019.080.062	M8			5/16"	7/16"
331.019.090.070	333.019.090.070		M12		3/8"	1/2"
331.019.100.080	333.019.100.080	M10				
331.019.110.090			M14	R1/4"		9/16"
	333.031.060.049	M5-M6	M8		7/32"	
	333.031.070.055		M10	R1/8"	1/4"	3/8"
331.031.080.062	333.031.080.062	M8			5/16"	7/16"
331.031.090.070	333.031.090.070		M12		3/8"	1/2"
331.031.100.080	333.031.100.080	M10				
331.031.110.090	333.031.110.090		M14	R1/4"		9/16"
331.031.120.090	333.031.120.090		M16	R3/8"		5/8"
331.031.140.110	333.031.140.110		M18			11/16"
331.031.160.120	333.031.160.120		M20	R1/2"		13/16"
331.031.180.145			M22-M24	R5/8"		7/8-15/16"
331.031.200.160			M27	R3/4"		1"
331.031.220.180			M30			
331.048.120.090			M16	R3/8"		5/8"
331.048.140.110			M18			11/16"
331.048.160.120			M20	R1/2"		13/16"
331.048.180.145			M22-M24	R5/8"		7/8-15/16"
331.048.200.160			M27	R3/4"		1"
331.048.220.180			M30	R7/8"		1,1/8"
331.048.250.200			M33	R1"		1,1/4"
331.048.280.220			M36	R1,1/8"		1,3/8"
331.048.320.240			M42	R1,1/4"		1,1/2-1,5/8"
331.048.360.290			M48	R1,2/2"		1,3/4-1,7/8"

BUSSOLE CON FRIZIONE
(* PRETARATE (** DA TARARE

TAP ADAPTERS WITH OVERLOAD CLUTCH.
(* PRE-CALIBRATED (** UNCALIBRATED

GEWINDEBOHRERAUFNABME MIT DREHMOMENTBEGRENZUNG
(* VORKALIBRIERT (** UNKALIBRIERT

DOUILLES SANS EMBRAYAGE
(* PRE-CALIBRÉES (** À CALIBRER

		(*) DIN371	DIN376	(**) DIN376-374	DIN353	DIN2182	DIN2183
334.019.028.021		M2-M2,5					
334.019.035.027	336.019.035.027	M3		M5		1/8"	
334.019.040.030		M3,5					
334.019.045.034	336.019.045.034	M4		M6		5/32"	1/4"
334.019.060.049	336.019.060.049.5 336.019.060.049.6	M5 M6		M8		7/32"	
334.019.070.055	336.019.070.055		M10		R1/8"	1/4"	3/8"
334.019.080.062	336.019.080.062	M8				5/16"	7/16"
334.019.090.070	336.019.090.070		M12			3/8"	1/2"
334.019.100.080	336.019.100.080	M10					
	336.031.060.049	M6				5/16"	7/16"
	336.031.070.055		M10				
334.031.080.062	336.031.080.062	M8					
334.031.090.070	336.031.090.070		M12			3/8"	1/2"
334.031.100.080	336.031.100.080	M10					
334.031.110.090	336.031.110.090		M14		R1/4"		9/16"
334.031.120.090	336.031.120.090		M16		R3/8"		5/8"
334.031.140.110	336.031.140.110		M18				11/16"
334.031.160.120	336.031.160.120		M20		R1/2"		13/16"
334.031.180.145			M22-M24		R5/8"		7/8-15/16"
334.048.120.090			M16		R3/8"		5/8"
334.048.140.110			M18				11/16"
334.048.160.120			M20		R1/2"		13/16"
334.048.180.145			M22-M24		R5/8"		7/8-15/16"
334.048.200.160			M27		R3/4"		1"
334.048.220.180			M30		R7/8"		1,1/8"
334.048.250.200			M33		R1"		1,1/4"
334.048.280.220			M36		R1,1/8"		1,3/8"

ART. 331..

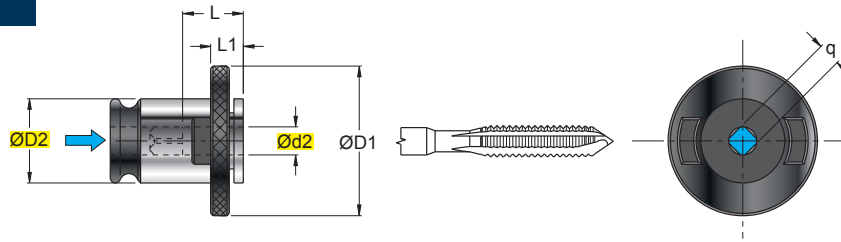

BUSSOLA PORTA MASCHI
TAP-COLLET
GEWINDEBOHRER-AUFNAHME
DOUILLE PORTE-TARAUDS

(mm)										
ART.	Ød2	ØD2	ØD1	L	L1	q				
331.019.028.021	2,8	19	30	17	7	2,1				
331.019.035.027	3,5	19	30	17	7	2,7				
331.019.040.030	4,0	19	30	17	7	3,0				
331.019.045.034	4,5	19	30	17	7	3,4				
331.019.060.049	6,0	19	30	17	7	4,9				
331.019.070.055	7,0	19	30	17	7	5,5				
331.019.080.062	8,0	19	30	17	7	6,2				
331.019.090.070	9,0	19	30	17	7	7,0				
331.019.100.080	10,0	19	30	17	7	8,0				
331.019.110.090	11,0	19	30	17	7	9,0				
331.031.080.062	8,0	31	48	30	11	6,2				
331.031.090.070	9,0	31	48	30	11	7,0				
331.031.100.080	10,0	31	48	30	11	8,0				
331.031.110.090	11,0	31	48	30	11	9,0				
331.031.120.090	12,0	31	48	30	11	9,0				
331.031.140.110	14,0	31	48	30	11	11,0				
331.031.160.120	16,0	31	48	30	11	12,0				
331.031.180.145	18,0	31	48	30	11	14,5				
331.031.200.160(*)	20,0	31	48	30	11	16,0				
331.031.220.180(*)	22,0	31	48	30	11	18,0				
331.048.120.090	12,0	48	70	44	14	9,0				
331.048.140.110	14,0	48	70	44	14	11,0				
331.048.160.120	16,0	48	70	44	14	12,0				
331.048.180.145	18,0	48	70	44	14	14,5				
331.048.200.160	20,0	48	70	44	14	16,0				
331.048.220.180	22,0	48	70	44	14	18,0				
331.048.250.200	25,0	48	70	44	14	20,0				
331.048.280.220	28,0	48	70	44	14	22,0				
331.048.320.240(*)	32,0	48	70	44	14	24,0				
331.048.360.290(*)	36,0	48	70	44	14	29,0				

(*) = PER LAVORAZIONI LEGGERE
SUITABLE FOR LIGHT MACHINING
FÜR LEICHTMETALLBEARBEITUNG
APTE POUR USINAGE LÉGER

ART. 333..

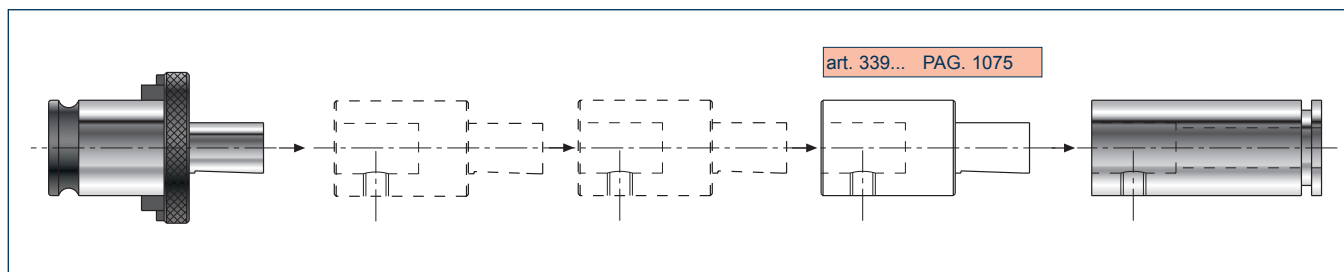
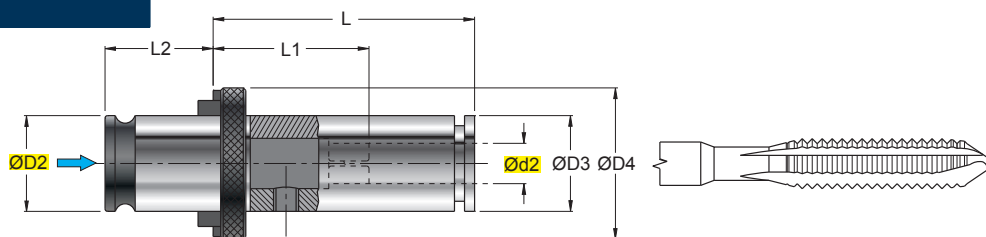

BUSSOLA PORTA MASCHI MODULARE PROLUNGATA
EXTENDED MODULAR TAP-COLLET LONGTYPE
VERLÄNGERTE MODULARE GEWINDEBOHRERAUFNAHME
DOUILLE PORTE -TARAUDS MODULAIRE SERIE LONGUE

ART.	(mm)										
	Ød2	ØD2	ØD3	ØD4	L	L1	L2				
333.019.035.027	3,5	19	23	30	52	33	21,5	GR606		5003	339.019.019.025 339.019.019.050
333.019.045.034	4,5	19	23	30	52	33	21,5	GR606		5003	339.019.019.025 339.019.019.050
333.019.060.049	6,0	19	23	30	52	33	21,5	GR606		5003	339.019.019.025 339.019.019.050
333.019.070.055	7,0	19	23	30	52	33	21,5	GR606		5003	339.019.019.025 339.019.019.050
333.019.080.062	8,0	19	23	30	52	33	21,5	GR606		5003	339.019.019.025 339.019.019.050
333.019.090.070	9,0	19	23	30	52	33	21,5	GR606		5003	339.019.019.025 339.019.019.050
333.019.100.080	10,0	19	23	30	52	33	21,5	GR606		5003	339.019.019.025 339.019.019.050
333.031.060.049	6,0	31	34,5	46	74	44	35	GR1008		5005	339.031.031.050 339.031.031.100
333.031.070.055	7,0	31	34,5	46	74	44	35	GR1008		5005	339.031.031.050 339.031.031.100
333.031.080.062	8,0	31	34,5	46	74	44	35	GR1008		5005	339.031.031.050 339.031.031.100
333.031.090.070	9,0	31	34,5	46	74	44	35	GR1008		5005	339.031.031.050 339.031.031.100
333.031.100.080	10,0	31	34,5	46	74	44	35	GR1008		5005	339.031.031.050 339.031.031.100
333.031.110.090	11,0	31	34,5	46	74	44	35	GR1008		5005	339.031.031.050 339.031.031.100
333.031.120.090	12,0	31	34,5	46	74	44	35	GR1008		5005	339.031.031.050 339.031.031.100
333.031.140.110	14,0	31	34,5	46	74	44	35	GR1008		5005	339.031.031.050 339.031.031.100
333.031.160.120	16,0	31	34,5	46	74	44	35	GR1008		5005	339.031.031.050 339.031.031.100

ART. 334..

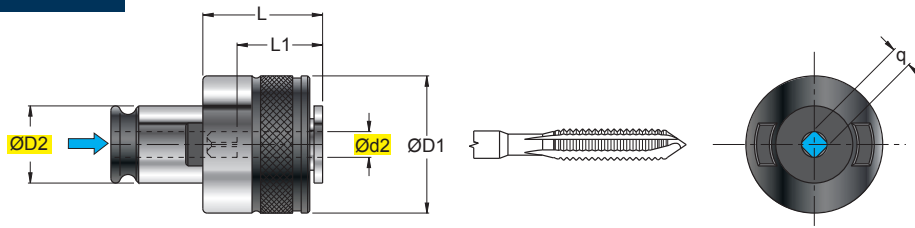

BUSSOLA PORTA MASCHI CON FRIZIONE
TAP-COLLET WITH OVERLOAD CLUTCH
GEWINDEBOHRER-AUFNAHME MIT DREHMOMENTBEGRENZUNG
DOUILLE PORTE-TARAUDS AVEC EMBRAYAGE

(mm)													
ART.	Ød2	ØD2	ØD1	L	L1	q							
334.019.028.021	2,8	19	32	25	17	2,1							
334.019.035.027	3,5	19	32	25	17	2,7							
334.019.040.030	4,0	19	32	25	17	3,0							
334.019.045.034	4,5	19	32	25	17	3,4							
334.019.060.049	6,0	19	32	25	17	4,9							
334.019.070.055	7,0	19	32	25	17	5,5							
334.019.080.062	8,0	19	32	25	17	6,2							
334.019.090.070	9,0	19	32	25	17	7,0							
334.019.100.080	10,0	19	32	25	17	8,0							
334.031.060.049	6,0	31	50	34	30	4,9							
334.031.070.055	7,0	31	50	34	30	5,5							
334.031.080.062	8,0	31	50	34	30	6,2							
334.031.090.070	9,0	31	50	34	30	7,0							
334.031.100.080	10,0	31	50	34	30	8,0							
334.031.110.090	11,0	31	50	34	30	9,0							
334.031.120.090	12,0	31	50	34	30	9,0							
334.031.140.110	14,0	31	50	34	30	11,0							
334.031.160.120	16,0	31	50	34	30	12,0							
334.031.180.145	18,0	31	50	34	30	14,5							
334.048.120.090	12,0	48	72	45	44	9,0							
334.048.140.110	14,0	48	72	45	44	11,0							
334.048.160.120	16,0	48	72	45	44	12,0							
334.048.180.145	18,0	48	72	45	44	14,5							
334.048.200.160	20,0	48	72	45	44	16,0							
334.048.220.180	22,0	48	72	45	44	18,0							
334.048.250.200	25,0	48	72	45	44	20,0							
334.048.280.220	28,0	48	72	45	44	22,0							

ART. 336..

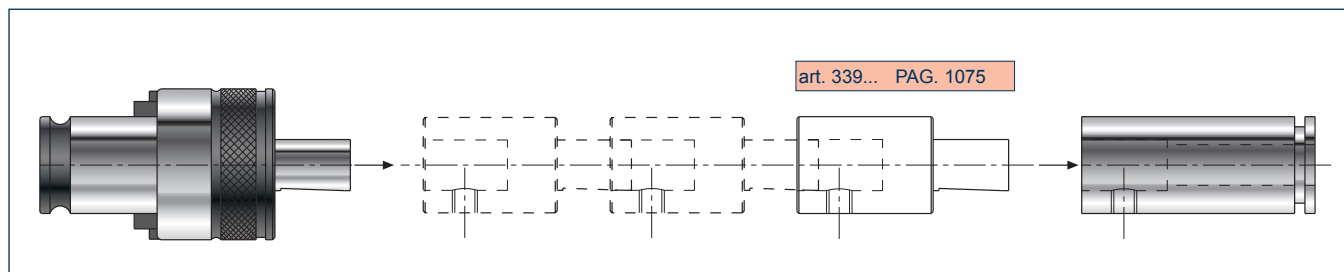
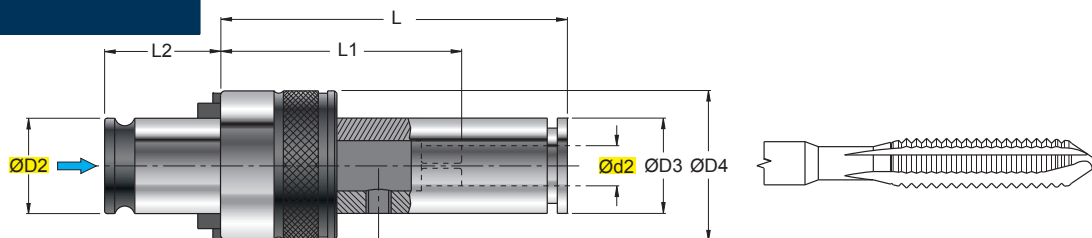



BUSSOLA PORTA MASCHI MODULARE PROLUNGATA CON FRIZIONE
EXTENDED MODULAR TAP-COLLET WITH OVERLOAD CLUTCH
VERLÄNGERTE MODULARE GEWINDEBOHRERAUFNAHME MIT DREHMOMENTBEGRENZUNG
DOUILLE PORTE-TARAUDS MODULAIRE PROLONGÉ AVEC EMBRAYAGE

ART.	(mm)							GR606		5003	
	Ød2	ØD2	ØD3	ØD4	L	L1	L2				
336.019.035.027	3,5	19	23	32	70	51	21,5			339.019.019.025 339.019.019.050	
336.019.045.034	4,5	19	23	32	70	51	21,5			339.019.019.025 339.019.019.050	
336.019.060.049.5	6,0	19	23	32	70	51	21,5			339.019.019.025 339.019.019.050	
336.019.060.049.6	6,0	19	23	32	70	51	21,5			339.019.019.025 339.019.019.050	
336.019.070.055	7,0	19	23	32	70	51	21,5			339.019.019.025 339.019.019.050	
336.019.080.062	8,0	19	23	32	70	51	21,5			339.019.019.025 339.019.019.050	
336.019.090.070	9,0	19	23	32	70	51	21,5			339.019.019.025 339.019.019.050	
336.019.100.080	10,0	19	23	32	70	51	21,5			339.019.019.025 339.019.019.050	
336.031.060.049	6,0	31	34,5	50	96	66	35	GR1008		5003 339.031.031.050 339.031.031.100	
336.031.070.055	7,0	31	34,5	50	96	66	35	GR1008		5003 339.031.031.050 339.031.031.100	
336.031.080.062	8,0	31	34,5	50	96	66	35	GR1008		5003 339.031.031.050 339.031.031.100	
336.031.090.070	9,0	31	34,5	50	96	66	35	GR1008		5003 339.031.031.050 339.031.031.100	
336.031.100.080	10,0	31	34,5	50	96	66	35	GR1008		5003 339.031.031.050 339.031.031.100	
336.031.110.090	11,0	31	34,5	50	96	66	35	GR1008		5003 339.031.031.050 339.031.031.100	
336.031.120.090	12,0	31	34,5	50	96	66	35	GR1008		5003 339.031.031.050 339.031.031.100	
336.031.140.110	14,0	31	34,5	50	96	66	35	GR1008		5003 339.031.031.050 339.031.031.100	
336.031.160.120	16,0	31	34,5	50	96	66	35	GR1008		5003 339.031.031.050 339.031.031.100	

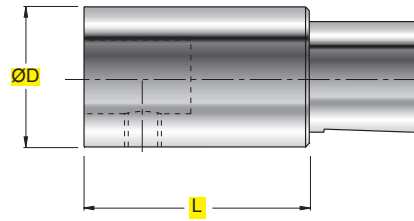
**ART. 339..
340..**



PROLUNGA PER BUSSOLA PORTAMASCHI MODULARE
EXTENSION FOR MODULAR TAP-COLLET
VERLÄNGERUNG FÜR MODULARE GEWINDEBOHRERAUFNAHME
RALLONGE POUR DOUILLE PORTE-TARAUDS MODULAIRE

(mm)				
ART.	ØD	L		
339.019.019.025	23	25	GR 606	5003
339.019.019.050	23	50		
339.031.031.050	35	50	GR 1008	5005
339.031.031.100	35	100		
340.048.048.050	48	50	GR 808	5004
340.048.048.100	48	100		

ART. 335..

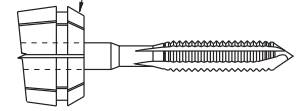
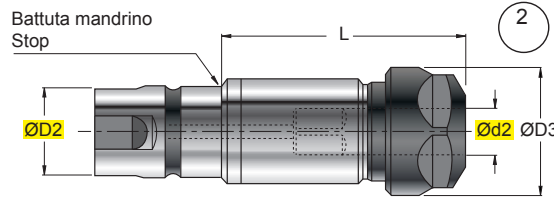
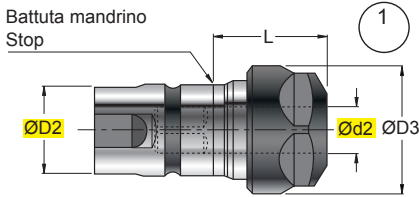

art. 328... PAG. 1064
art. 330... PAG. 1064
art. 329... PAG. 1065
art. 235... PAG. 1065

BUSSOLE PORTA MASCHIO PER MASCHIATURE SINCRONIZZATE
TAP-COLLET FOR SYNCHRONIZED TAPPING
GEWINDEBOHRER-AUFNAHME FÜR SYNCHRONSTEUERUNG
DOUILLE PORTE-TARAUD POUR TARAUDAGES SYNCHRONIZEES

ART.	(mm)			L	FIGURA FIGURE BILD FIGURE				
	Ød2	ØD2	ØD3						
335.020.ER016.024	2-10	20	28	24	1	--.016.--			
335.032.ER025.028	2-16	32	42	28	1	--.025.--			
335.040.ER040.032	6-26	50	63	32	1	--.040.--			
335.020.ER016.055	2-10	20	28	55	2	--.016.--			
335.032.ER025.086	2-16	32	42	86	2	--.025.--			
335.040.ER040.095	6-26	50	63	95	2	--.040.--			

ART. 341..

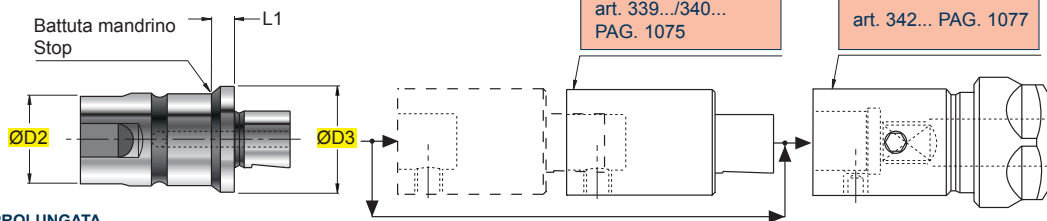

CORPO BUSSOLA PROLUNGATA
EXTENDED TAP ADAPTER BODY
EINSATZ MIT LANGE AUSFÜHRUNG
CORPS DE LA DOUILLE PROLONGÉ

ART.	ØD2	ØD3	L1						
341.023.020.005	20	23	5			--.016.--			
341.035.032.007	32	35	7			--.025.--			
341.050.050.002	50	50	2			--.040.--			

ART. 342..

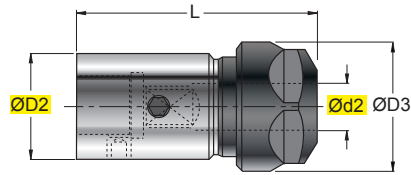

art. 328... PAG. 1064
art. 330... PAG. 1064
art. 329... PAG. 1065
art. 235... PAG. 1065

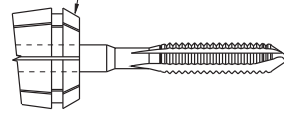

TERMINALE
TERMINAL
TERMINAL
TERMINAL



ART.	Ød2	ØD2	ØD3	L					
342.023.ER016.050	2-10	23	28	50	--.016.--				
342.035.ER025.079	2-16	35	42	79	--.025.--				
342.048.ER040.093	6-26	48	63	93	--.040.--				

ART. RCDM..

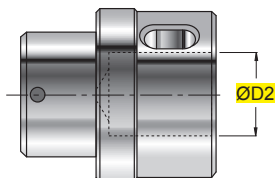

SUPPORTO DI MONTAGGIO
ASSEMBLY SUPPORT
MONTAGE BLOCK
SUPPORT DE MONTAGE

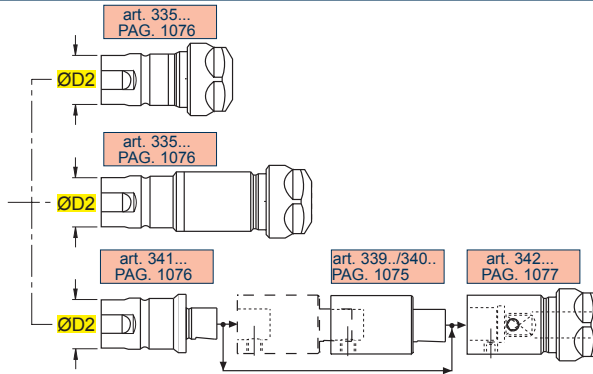

art. 328... PAG. 1064
art. 330... PAG. 1064
art. 329... PAG. 1065
art. 235... PAG. 1065

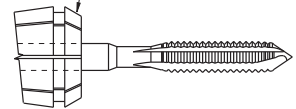

ART.	ØD2								
RCDM 20	20	--.016.--							
RCDM 32	32	--.025.--							
RCDM 50	50	--.040.--							

ART. 361..ER..

NEW

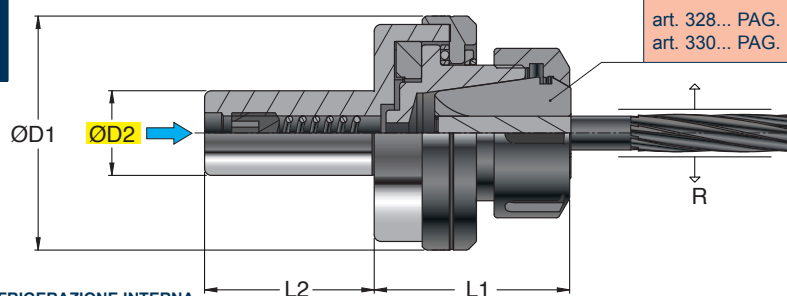

ER-DIN 6499

PORTA ALESATORI FLOTTANTI CON REFRIGERAZIONE INTERNA
FLOATING REAMER HOLDERS WITH INNER COOLING
SCHWIMMENDE REIBAHLENHALTER MIT INNENKÜHLUNG
PINCIE POUR ALESOIRS AVEC OSCILLATION RADIALE DIN 6499

ART.	ØD2	ØD1	L1	L2	R				
361.016.ER16.046	16	42	44	46	1	--.016.--	RGS ER16		925.022
361.020.ER25.046	20	57	53	46	1	--.025.--	RGS ER32		925.052
361.032.ER32.050	32	69	53	50	1	--.032.--	RGS ER40		925.068

CARATTERISTICHE TECNICHE - TECHNICAL CHARACTERISTICS

1. L'alesatore oscilla su un cuscinetto a sfere per compensare gli errori di allineamento tra il mandrino della macchina e il pezzo in lavorazione
2. La spinta della molla mantiene l'utensile centrato anche in posizione orizzontale
3. La vite regola la pressione della molla per regolare il movimento radiale
4. Allentato di 0,1/0,2 la ghiera si permette all'alesatore di avere un movimento pendolare

1. Free moving ball bearing drive, permit to reamer to follow drilled hole of workpiece
2. Pressure of spring keeps reamer centered, even in horizontal position
3. Screw allows adjustment of floating level
4. Unscrewing nut for 0,1/0,2 mm, the reamer has a pendulum float

ART. 218..

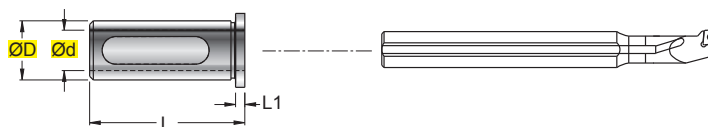

BOCOLA DI RIDUZIONE
COLLET ADAPTERS
REDUKTION
DOUILLES DE RÉDUCTION

ART.	(mm)				L1	ART.	(mm)				L1
	ØD	Ød _{H7}	L	L1			ØD	Ød _{H7}	L	L1	
218.025.016.000	25	16	54	2	218.040.016.000	40	16	68	2		
218.025.020.000	25	20	54	2	218.040.020.000	40	20	68	2		
218.032.016.000	32	16	58	2	218.040.025.000	40	25	68	2		
218.032.020.000	32	20	58	2	218.040.032.000	40	32	68	2		
218.032.025.000	32	25	58	2							

ART. BPUH..

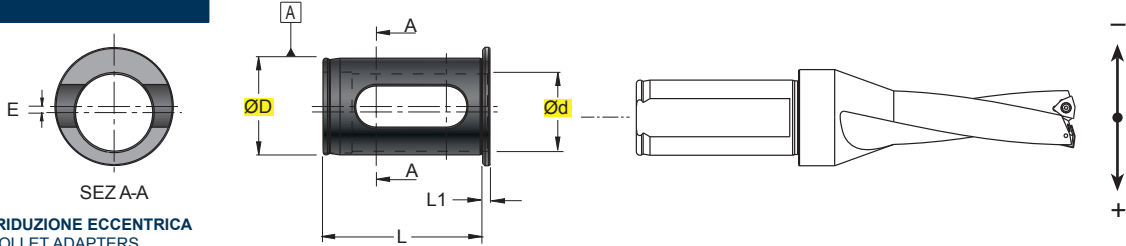

BOCCOLA DI RIDUZIONE ECCENTRICA
ECCENTRIC COLLET ADAPTERS
EXZENTERREDUZIERHÜLSE
DOUILLES DE RÉDUCTION EXECENTRIQUE

ART.	(mm)			L	L1	ART.	(mm)			L	L1
	0/-0,01 ØD	+0,01/0 Ød	E				0/-0,01 ØD	+0,01/0 Ød	E		
BPUH.3225.010	32	25	+/-0,1	56	3	BPUH.5040.010	50	40	+/-0,1	76	3
BPUH.3225.030	32	25	+0,3	56	3	BPUH.5040.030	50	40	+0,3	76	3
BPUH.4032.010	40	32	+/-0,1	66	3						
BPUH.4032.030	40	32	+0,3	66	3						

LE PUNTE TDC, SDQ SI POSSONO USARE SU MACCHINE CON PUNTA ROTANTE E PEZZO FERMO, CON BOCCOLE PER DISASSAMENTO. LE PUNTE POSSONO ESSERE DISASSATE DA -0,1 A +0,3 mm. DA USARE SOLO CON MANDRINI TIPO PU.

TDC AND SDQ DRILL BITS CAN BE USED ON MACHINES WITH ROTATING DRILL AND STATIONARY WORKPIECE, WITH OFFSET BUSHINGS. THE DRILL CAN BE OFFSET BY -0,1 TO +0,3 mm. ONLY FOR USE WITH PU...CHUCKS

DIE BOHRER TDC SDQ KÖNNEN AN MASCHINEN MIT DREHENDEM BOHRER UND UNBEWEGLICHEM WERKSTÜCK VERWENDET WERDEN. MIT LAGERN ZUR ACHSVERSETZUNG. DIE BOHRER KÖNNEN VON -0,1 BIS +0,3 mm AUS DER ACHSLINIE VERSETZT WERDEN. NUR ZUM EINSATZ MIT PU...AUFNAHMEN

ON PEUT UTILISER LES FORETS TDC SDQ SUR MACHINES AVEC FORET ROTATIVE ET PIÈCE QUE NE BOUGE PAS. AVEC DOUILLES POUR DÉSAXEMENT. LES FORETS PEUVENT ÊTRE DÉSAXÉS DEPUIS -0,1 JUSQU'À +0,3 mm. À UTILISER SEULEMENT AVEC MANDRINS DU TYPE PU.

ART. BEMSN..

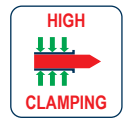
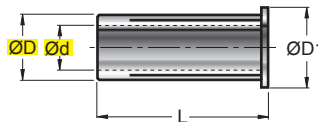

BOCCOLE DI RIDUZIONE CILINDRICHE PER MANDRINI A FORTE SERRAGGIO
CYLINDRICAL REDUCTION COLLETS FOR HEAVY-DUTY CHUCKS
ZYLINDRISCHE REDUZIERBUCHSEN FÜR KRAFTSPANNFUTTER
DOUILLES DE RÉDUCTION CILINDRIQUES POUR MANDRINS A SERRAGE FORT

Nm Max 600 0,005

ART.	(mm)				ART.	(mm)			
	ØD	Ød	ØD1	L		ØD	Ød	ØD1	L
BEMSN.2006	20	6	30	52,5	BEMSN.3206	32	6	36	63
BEMSN.2008	20	8	30	52,5	BEMSN.3208	32	8	36	63
BEMSN.2010	20	10	30	52,5	BEMSN.3210	32	10	36	63
BEMSN.2012	20	12	30	52,5	BEMSN.3212	32	12	36	63
BEMSN.2016	20	16	30	52,5	BEMSN.3216	32	16	36	63
					BEMSN.3218	32	18	36	63
					BEMSN.3220	32	20	36	63
					BEMSN.3225 New	32	25	36	63

ART. BMIS..

NEW

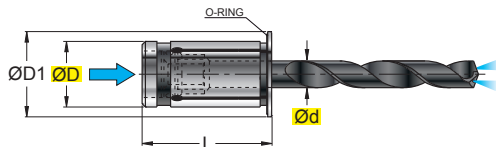

- LA BOCCOLA BMIS.. HA UNA TENUTA DEL LUBRIFICANTE FINO A 80 bar.
- SI PREGA DI INSERIRE L'UTENSILE NELLA BOCCOLA BMIS.. PRIMA DI INSERIRE LA BOCCOLA NEL MANDRINO.

- THE BMIS.. COLLET IS COOLANT-PROOF UP TO 80 BAR.
- FIT THE TOOL INTO THE BMIS.. COLLET BEFORE FITTING THE COLLET INTO THE CHUCK

- DIE BMIS.. HÜLSE IST BIS 80 BAR SCHMIERSTOFFFEST.
- BITTE STECKEN SIE DAS WERKZEUG IN DIE BMIS.. HÜLSE, BEVOR SIE DIE HÜLSE IN DIE AUFNAHME EINSETZEN

- LA DOUILLE BMIS.. EST DOTÉE D'UNE ÉTANCHÉITÉ DU LUBRIFIANT JUSQU'À 80 BARS.
- IL EST CONSEILLÉ D'INTRODUIRE L'OUTIL DANS LA DOUILLE BMIS.. AVANT D'INTRODUIRE LA DOUILLE DANS LE MANDRIN.

BOCCOLE DI RIDUZIONE CILINDRICHE CON GOMMA DI TENUTA PER MANDRINI IDRAULICI
CYLINDRICAL REDUCTION COLLETS WITH O-RING FOR HYDRAULIC CHUCKS
ZYLINDRISCHE REDUZIERBUCHSEN MIT GUMMIDICHTUNG FÜR HYDRAULISCHE WERKZEUGAUFNAHMEN
DOUILLES DE RÉDUCTION CILINDRIQUES AVEC JOINT TORIQUE ETANCHE EN CAOUTCHOUC POUR MANDRINS HYDRAULIQUES

ART.	(mm)				ART.	(mm)				ART.	(mm)			
	ØD	Ød	ØD1	L		ØD	Ød	ØD1	L		ØD	Ød	ØD1	L
BMIS 2003	20	3	29	52,5	BMIS 2010	20	10	29	52,5	BMIS 3206	32	6	39	63,5
BMIS 2004	20	4	29	52,5	BMIS 2012	20	12	29	52,5	BMIS 3208	32	8	39	63,5
BMIS 2005	20	5	29	52,5	BMIS 2016	20	16	29	52,5	BMIS 3210	32	10	39	63,5
BMIS 2006	20	6	29	52,5						BMIS 3212	32	12	39	63,5
BMIS 2008	20	8	29	52,5						BMIS 3216	32	16	39	63,5

ART. BECR..

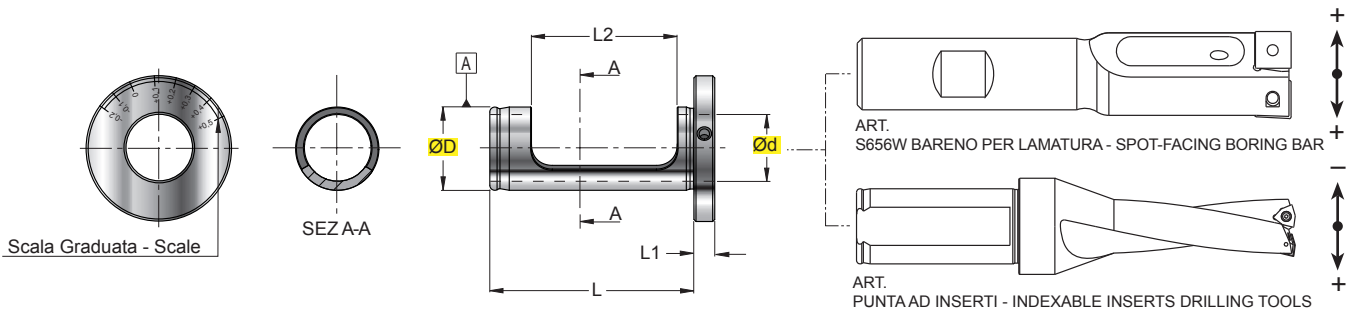

BOCCOLE DISASSATRICI REGOLABILI
ADJUSTABLE OFFSET COLLETS
EINSTELLBARE ACHSVERSATZ-BÜCHSEN
DOUILLES DESAXANTES AVEC REGULATION

ART.	(mm)		L	L1	L2	Campi Reg. Ø Ø Adjustment ranges				
	^{h7} ØD	^{H7} Ød								
BECR.1620	20	16	49	5	35	+0,4/-0,2				
BECR.2025	25	20	43	4	30	+0,4/-0,2				
BECR.2532	32	25	48	6	33	+0,4/-0,2				
BECR.3240	40	32	53	6	35	+0,4/-0,2				

**MODALITÀ D'IMPIEGO BOCCOLA BECR.. - USE OF COLLET BECR..
ANWENDUNG DER BÜCHSE BECR.. - MODE D'EMPLOI POUR LA DOUILLE BECR..**

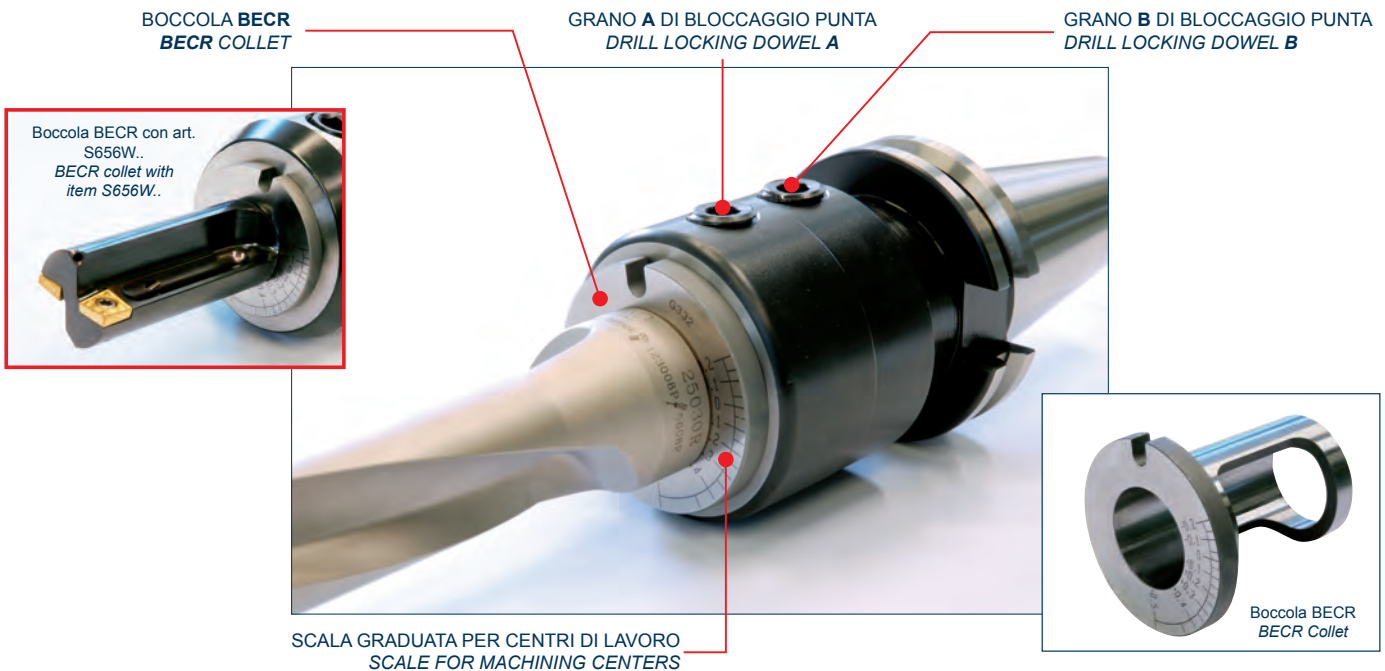

**REGOLAZIONE DEL DIAMETRO - PER I CENTRI DI LAVORO - DIAMETER ADJUSTMENT-FOR MACHINING CENTRES
DURCHMESSEREINSTELLUNG-FÜR BEARBEITUNGSZENTREN - REGULATION DU DIAMETRE POUR LE CENTRE DE TRAVAIL**

- Per ottenere un diametro maggiore del diametro nominale, ruotare la boccia in **senso antiorario** verso il segno + , per ottenere un diametro minore, ruotare la boccia in **senso orario** verso il segno -
- To obtain a diameter larger than the rated diameter, rotate the collet **counter-clockwise** towards the symbol +, to obtain a smaller diameter, rotate the collet **clockwise** towards the symbol -
- Um einen Durchmesser größer als den Nenndurchmesser zu erhalten, Büchse **gegen den Uhrzeigersinn** zum Symbol + drehen, um einem kleineren Durchmesser zu erhalten, Büchse **im Uhrzeigersinn** zum Symbol - drehen.
- Pour obtenir un diamètre plus grande du diamètre nominale, tourner la douille dans le **sens antihoraire** vers le signe +, pour obtenir un diamètre plus petit tourner la douille dans le **sens horaire** vers le signe -

POSIZIONE DI REGOLAZIONE : Punta Destra = Grano di bloccaggio in alto, inserto esterno a destra
Punta Sinistra = Grano di bloccaggio in alto, inserto esterno a sinistra
ADJUSTMENT POSITION : Right Drill = Locking dowel on the top, outer insert on the right
Left Drill = Locking dowel on the top, outer insert on the left



Nelle figure punta destra - Right-hand shown

- LA SCALA GRADUATA DELLA BUSSOLA BECR É SOLAMENTE INDICATIVA.
- NON DEVE ESSERE ASSOLUTAMENTE USATA COME "GHIERA DIVISORE" DI UN MANDRINO.
- NEL CASO DI LUNGHEZZE SUPERIORI A L/D 4 O DI AMPIE REGOLAZIONI, É NECESSARIO RIDURRE L'AVANZAMENTO.
- THE SCALE ON THE BECR COLLET IS PROVIDED JUST AS AN INDICATION.
- ABSOLUTELY NOT TO BE USED AS "DIVIDING RING NUT" FOR AN ARBOR
- IN CASE OF LENGTHS OVER L/D 4 OR LARGE ADJUSTMENTS FEED MUST BE REDUCED
- DIE SKALENEINTEILUNG DER BÜCHSE BECR DIENT NUR ALS ANHALTSPUNKT.
- SIE DARF AUF KEINEN FALL ALS "TRENNHÜLSE" EINER SPINDEL ANGESEHEN WERDEN.
- BEI LÄNGEN ÜBER L/D 4 ODER BEI GROSSEN EINSTELLUNGEN MUSS DER VORSCHUB VERKÜRZT WERDEN.
- L'ECHELLE GRADUEE DE LA DOUILLE BECR EST UNIQUEMENT A TITRE INDICATIF.
- ELLE NE DOIT ABSOLUMENT PAS ETRE UTILISEE COMME "BAGUE DE SEPARATION" D'UNE BROCHE.
- DANS LE CAS DE LONGUEURS SUPERIEURES A L/D 4 OU D'AMPLES REGLAGES IL Y A LIEU DE REDUIRE L'AVANCE.

Operazioni da eseguire per portare il liquido refrigerante al centro del barenò.

Operations required to convey the coolant to the centre of the boring bar.

Änderungen für die Kühlmittelzufuhr bei bohrstangen mit IK.

Operations à faire pour acheminer le liquide refrigerant vers le centre de la barre d'alesage.

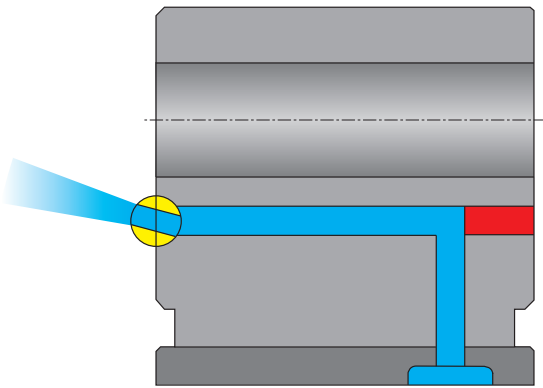

- Forare il portautensile come evidenziato in rosso.
- Follow the instructions in red for the drilling of the toolholder.
- Die Bohrungen in der Bohrstangenaufnahme neu anbringen wie in der Skizze mit rot gekennzeichnet.
- Percer le porte-outil comme il est mis en évidence en rouge.

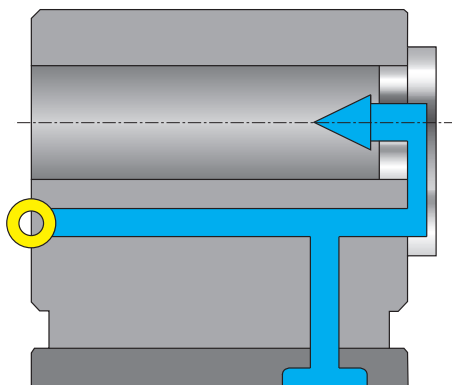

- Applicare la chiusura posteriore.
- Fit the back plug.
- Die Kühlmitteldüse verschliessen.
- Appliquer la fermeture postérieure.

BOCCOLA DI RIDUZIONE PORTA BARENO CON PASSAGGIO DEL REFRIGERANTE.
 THROUGH COOLANT BORING BAR REDUCING COUPLING.
 BOHRSTANGEN-REDUZIERHÜLSE MIT SCHMIERSTOFFDURCHFLUSS.
 DOUILLE DE RÉDUCTION PORTE BARRE D'ALÉSAGE AVEC PASSAGE DU FLUIDE DE RÉFRIGÉRATION.

L'uscita del refrigerante avviene attraverso la scanalatura interna della riduzione e l'eventuale foro dell'utensile.

Il truciolo viene espulso tramite il getto forzato del lubrificante.

The coolant is discharged from the internal channel in the reduction or from the hole in the holder. The chip is discharged through the pressure-jet of the coolant.

Das Kühlmittel tritt seitlich an der Reduzierung aus und auch, soweit vorhanden, an der Kühlmittelbohrung der Bohrstange. Der Span wird durch die Innenkühlung besser aus dem Werkstück gespült.

Le réfrigérant sort par la rainure interne de la réduction et l'éventuel trou de l'outil. Le copeau est expulsé par le jet forcé du lubrifiant.

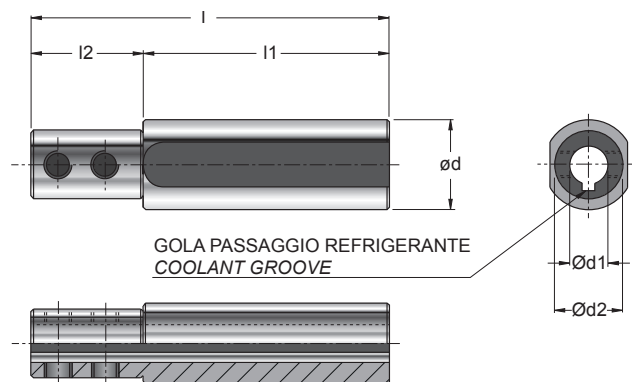

F.1

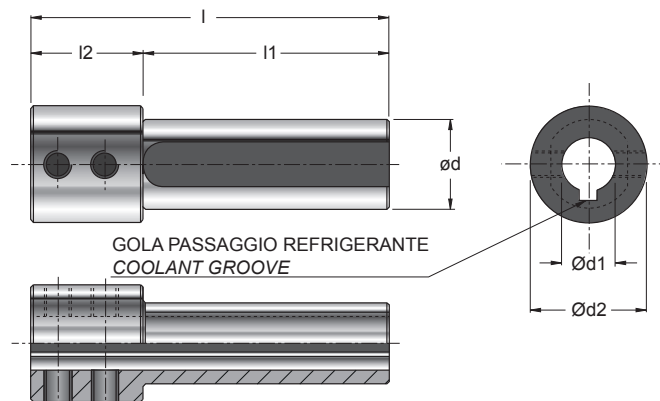

F.2

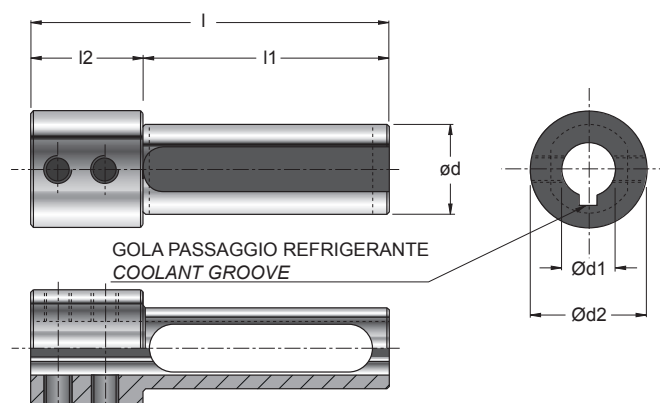

F.3

ART.	F.	h7	H7	ød2	l	l1	l2
		ød	ød1				
BKN-025.008	1	25	08	24,5	95	65	30
BKN-025.010	1	25	10	24,5	95	65	30
BKN-025.012	1	25	12	24,5	95	65	30
BKN-025.016	2	25	16	32,0	95	65	30
BKN-032.008	1	32	08	28	95	65	30
BKN-032.010	1	32	10	28	95	65	30
BKN-032.012	1	32	12	28	95	65	30
BKN-032.016	1	32	16	28	95	65	30
BKN-032.020	2	32	20	38	95	65	30
BKN-032.025	3	32	25	43	95	65	30
BKN-040.008	1	40	08	31,5	95	65	30
BKN-040.010	1	40	10	31,5	95	65	30
BKN-040.012	1	40	12	31,5	95	65	30
BKN-040.016	1	40	16	31,5	95	65	30
BKN-040.020	2	40	20	47,5	95	65	30
BKN-040.025	2	40	25	47,5	95	65	30
BKN-040.032	3	40	32	47,5	95	65	30
BKN-050.016	1	50	16	40	95	65	30
BKN-050.020	1	50	20	40	95	65	30
BKN-050.025	1	50	25	40	95	65	30
BKN-050.032	2	50	32	56	95	65	30
BKN-050.040	3	50	40	56	95	65	30

ART. 06 36..UN

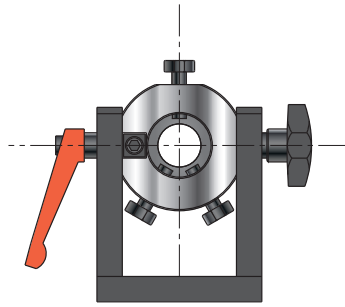

ATTREZZO PER IL MONT. E LO SMONT. DI MANDRINI
TOOL FOR THE ASSEMBLY AND DISASSEMBLY OF ARBORS
MONTAGE HILFE
OUTIL POUR LE MONTAGE ET LE DEMONTAGE DE MANDRINS

ART.									
06 3620.40.UN	HSK63	ISO40	ISO40						
06 3622.50.UN	HSK100	ISO50	ISO50						

ART. A-140..

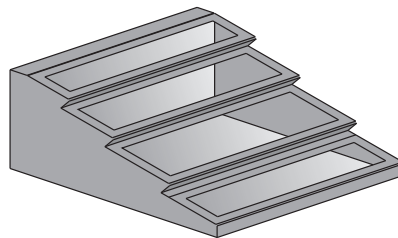

TELAIO DA BANCO PORTAMANDRINI
BENCH-MOUNTED STORAGE RACK ARBORS
AUFNAHMETRAEGER
BOITE DE COMPTOIR PORTE-MANDRINS

ART.		N°BOCCOLE							
A140	A100	24							
	A105	24							
	A110	18							
	A115	15							
	A120	24							
	A125	18							
	A130	18							

ART. A-1..

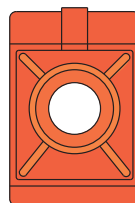

BOCCOLA PORTAMANDRINI
STORAGE BASE FOR ARBORS
AUFNAHMEBUCHSE
RÉDUCTIONS PORTE-MANDRINS

ART.		DIM							
A100	ISO30	65x138x48H							
A105	ISO40	65x138x63H							
A110	ISO45	83x138x63H							
A115	ISO50	102x138x63H							
A120	VDI30	65x138x74H							
A125	VDI40	83x138x82H							
A130	VDI50	83x138x98H							

ART. RGC..

CON CUSCINETTO
WITH BEARING
MIT LAGER
AVEC COUSSINET

PRE-EQUILIBRATE
PRE-BALANCED

GHIERE DI PRECISIONE
PRECISION RING NUTS
PRÄZISIONSRINGE
FRETTE DE PRECISION

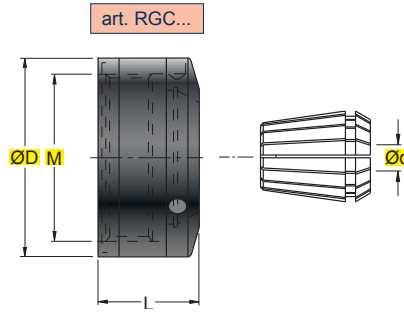

art. 228..
228Q.. (Recommened)
230..
230QN..
328..
330..
329..
235..

(mm)											
ART.	Ød	ØD	M	L							
RGC ER16	0,5-10	30	22x1,5	18		--.016.--				925.022	
RGC ER25	0,5-16	40	32x1,5	20,5		--.025.--				925.040	
RGC ER32	2,5-20	50	40x1,5	23,5		--.032.--				925.052	
RGC ER40	3-30	63	50x1,5	26		--.040.--				925.068	

ART. RGS.. ART. RGSE.. ART. RGM..

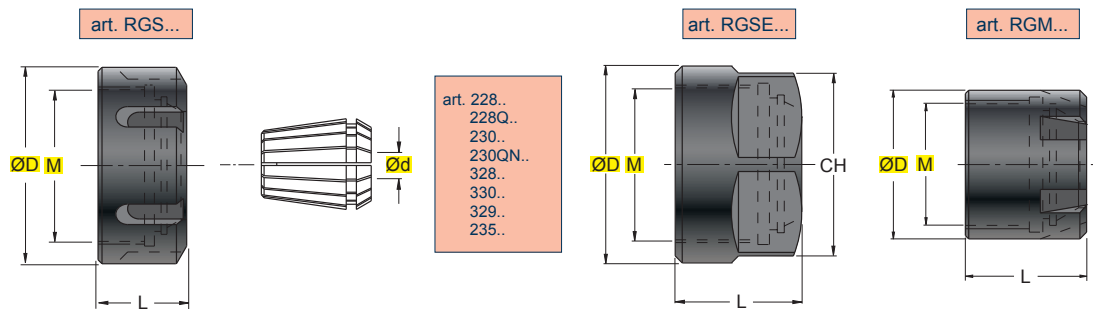

GHIERE
RINGS
RING
FRETTE

(mm)												
ART.	Ød	ØD	M	CH	L							
RGS ER16	0,5-10	32	22x1,5	-	17		--.016.--			925.022	-	927.022
RGS ER25	0,5-16	42	32x1,5	-	20		--.025.--			925.040	-	927.040
RGS ER32	2,5-20	50	40x1,5	-	22		--.032.--			925.052	-	927.052
RGS ER40	3-30	63	50x1,5	-	26		--.040.--			925.068	-	927.068
RGSE ER16	0,5-10	28	22x1,5	25	17		--.016.--			-	-	-
RGM ER11	0,5-7	16	13x0,75	-	12		--.011.--			-	938.011	-
RGM ER16	0,5-10	22	19x1	-	18		--.016.--			-	938.016	-
RGM ER25	0,5-16	35	30x1	-	20		--.025.--			-	938.025	-

ART. RGSW..

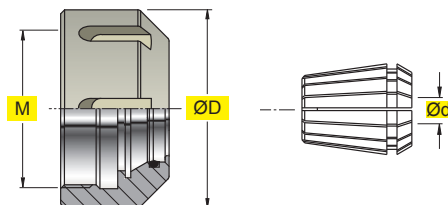
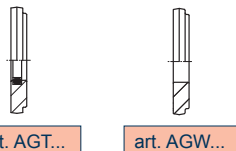

art. 228..
228Q.. (Recommened)
230..
230QN..
328..
330..
329..
235..

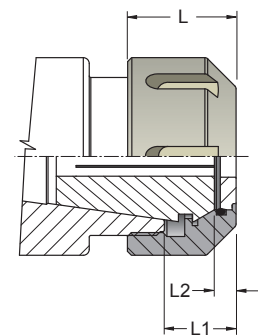

GHIERE A TENUTA IDRAULICA
SEALING RINGS
DICHTSCHEIBEN
FRETTE À ÉTANCHÉITÉ HYDRAULIQUE

(mm)											
ART.	Ød	ØD	M	L	L1	L2	Nm				
RGSW ER25	2-16	42	32x1,5	25	17	5	80÷100	--.025.--	ORM 0210-20	925.040	927.040
RGSW ER32	2-20	50	40x1,5	27	18	5	90÷110	--.032.--	OR-0267-178	925.052	927.052

ART. AGT..

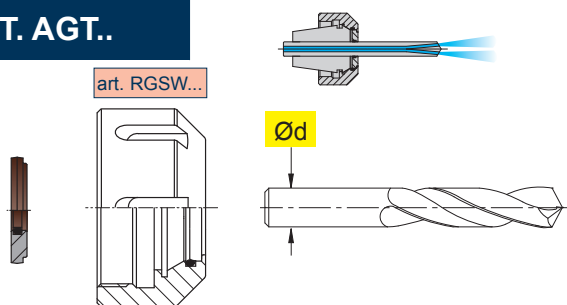

ANELLI PER ADDUZIONE ATTRAVERSO L'UTENSILE
RINGS FOR COOLANT THROUGH THE TOOL
RINGE ZUR KÜHLMITTEL-INNENFÜHRUNG
BAGUES D'ADDITION À TRAVERS L'OUTIL

(mm)



ART.	Ød	
AGT 25 4.0	4,0 ÷ 3,5	OR-0035-150
AGT 25 4.5	4,5 ÷ 4,0	OR-0040-150
AGT 25 5.0	5,0 ÷ 4,5	OR-0045-150
AGT 25 5.5	5,5 ÷ 5,0	OR-0050-150
AGT 25 6.0	6,0 ÷ 5,5	OR-0055-150
AGT 25 6.5	6,5 ÷ 6,0	OR-0060-150
AGT 25 7.0	7,0 ÷ 6,5	OR-0065-150
AGT 25 7.5	7,5 ÷ 7,0	OR-0070-150
AGT 25 8.0	8,0 ÷ 7,5	OR-0075-150
AGT 25 8.5	8,5 ÷ 8,0	OR-0080-150
AGT 25 9.0	9,0 ÷ 8,5	OR-0085-150
AGT 25 9.5	9,5 ÷ 9,0	OR-0090-150
AGT 25 10.0	10,0 ÷ 9,5	OR-0095-150
AGT 25 10.5	10,5 ÷ 10,0	OR-0100-150
AGT 25 11.0	11,0 ÷ 10,5	OR-0105-150
AGT 25 11.5	11,5 ÷ 11,0	OR-0110-150
AGT 25 12.0	12,0 ÷ 11,5	OR-0115-150
AGT 25 12.5	12,5 ÷ 12,0	OR-0120-150
AGT 25 13.0	13,0 ÷ 12,5	OR-0125-150
AGT 25 13.5	13,5 ÷ 13,0	OR-0130-150
AGT 25 14.0	14,0 ÷ 13,5	OR-0135-150
AGT 25 14.5	14,5 ÷ 14,0	OR-0140-150
AGT 25 15.0	15,0 ÷ 14,5	OR-0145-150
AGT 25 15.5	15,5 ÷ 15,0	OR-0150-150
AGT 25 16.0	16,0 ÷ 15,5	OR-0155-150
AGT 32 4.0	4,0 ÷ 3,5	OR-0035-150
AGT 32 4.5	4,5 ÷ 4,0	OR-0040-150
AGT 32 5.0	5,0 ÷ 4,5	OR-0045-150
AGT 32 5.5	5,5 ÷ 5,0	OR-0050-150
AGT 32 6.0	6,0 ÷ 5,5	OR-0055-150
AGT 32 6.5	6,5 ÷ 6,0	OR-0060-150
AGT 32 7.0	7,0 ÷ 6,5	OR-0065-150
AGT 32 7.5	7,5 ÷ 7,0	OR-0070-150
AGT 32 8.0	8,0 ÷ 7,5	OR-0075-150
AGT 32 8.5	8,5 ÷ 8,0	OR-0080-150
AGT 32 9.0	9,0 ÷ 8,5	OR-0085-150
AGT 32 9.5	9,5 ÷ 9,0	OR-0090-150
AGT 32 10.0	10,0 ÷ 9,5	OR-0095-150
AGT 32 10.5	10,5 ÷ 10,0	OR-0100-150
AGT 32 11.0	11,0 ÷ 10,5	OR-0105-150
AGT 32 11.5	11,5 ÷ 11,0	OR-0110-150
AGT 32 12.0	12,0 ÷ 11,5	OR-0115-150
AGT 32 12.5	12,5 ÷ 12,0	OR-0120-150
AGT 32 13.0	13,0 ÷ 12,5	OR-0125-150
AGT 32 13.5	13,5 ÷ 13,0	OR-0130-150
AGT 32 14.0	14,0 ÷ 13,5	OR-0135-150
AGT 32 14.5	14,5 ÷ 14,0	OR-0140-150
AGT 32 15.0	15,0 ÷ 14,5	OR-0145-150
AGT 32 15.5	15,5 ÷ 15,0	OR-0150-150
AGT 32 16.0	16,0 ÷ 15,5	OR-0155-150
AGT 32 16.5	16,5 ÷ 16,0	OR-0160-150
AGT 32 17.0	17,0 ÷ 16,5	OR-0165-150
AGT 32 17.5	17,5 ÷ 17,0	OR-0170-150
AGT 32 18.0	18,0 ÷ 17,5	OR-0175-150
AGT 32 18.5	18,5 ÷ 18,0	OR-0180-150
AGT 32 19.0	19,0 ÷ 18,5	OR-0185-150
AGT 32 19.5	19,5 ÷ 19,0	OR-0190-150
AGT 32 20.0	20,0 ÷ 19,5	OR-0195-150

ART. AGW..

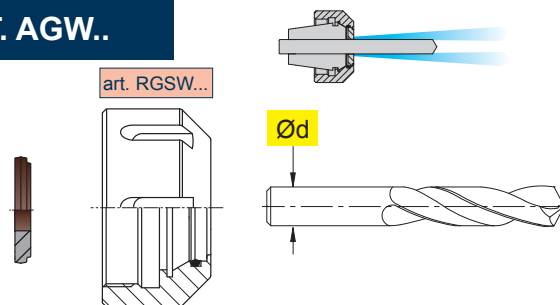

ANELLI PER ADDUZIONE INTORNO ALL'UTENSILE
RINGS FOR COOLANT AROUND THE TOOL
RINGE ZUR KÜHLMITTELFÜHRUNG UM DAS WERKZEUG
BAGUES D'ADDITION AUTOUR L'OUTIL

(mm)

ART.	Ød	
AGW 32 4.0	4,0 ÷ 3,5	
AGW 32 4.5	4,5 ÷ 4,0	
AGW 32 5.0	5,0 ÷ 4,5	
AGW 32 5.5	5,5 ÷ 5,0	
AGW 32 6.0	6,0 ÷ 5,5	
AGW 32 6.5	6,5 ÷ 6,0	
AGW 32 7.0	7,0 ÷ 6,5	
AGW 32 7.5	7,5 ÷ 7,0	
AGW 32 8.0	8,0 ÷ 7,5	
AGW 32 8.5	8,5 ÷ 8,0	
AGW 32 9.0	9,0 ÷ 8,5	
AGW 32 9.5	9,5 ÷ 9,0	
AGW 32 10.0	10,0 ÷ 9,5	
AGW 32 10.5	10,5 ÷ 10,0	
AGW 32 11.0	11,0 ÷ 10,5	
AGW 32 11.5	11,5 ÷ 11,0	
AGW 32 12.0	12,0 ÷ 11,5	
AGW 32 12.5	12,5 ÷ 12,0	
AGW 32 13.0	13,0 ÷ 12,5	
AGW 32 13.5	13,5 ÷ 13,0	
AGW 32 14.0	14,0 ÷ 13,5	
AGW 32 14.5	14,5 ÷ 14,0	
AGW 32 15.0	15,0 ÷ 14,5	
AGW 32 15.5	15,5 ÷ 15,0	
AGW 32 16.0	16,0 ÷ 15,5	
AGW 32 16.5	16,5 ÷ 16,0	
AGW 32 17.0	17,0 ÷ 16,5	
AGW 32 17.5	17,5 ÷ 17,0	
AGW 32 18.0	18,0 ÷ 17,5	
AGW 32 18.5	18,5 ÷ 18,0	
AGW 32 19.0	19,0 ÷ 18,5	
AGW 32 19.5	19,5 ÷ 19,0	
AGW 32 20.0	20,0 ÷ 19,5	

ART. AGMS..

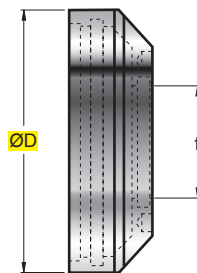

ANELLO DI TENUTA
SEALING RING
DICHRING
BAGUE D'ÉTANCHÉITÉ

ART.	(mm)	
	ØD	f
AGMS.020.060	47	6+5,5
AGMS.020.065	47	6,5+6
AGMS.020.070	47	7+6,5
AGMS.020.075	47	7,5+7
AGMS.020.080	47	8+7,5
AGMS.020.085	47	8,5+8
AGMS.020.090	47	9+8,5
AGMS.020.095	47	9,5+9
AGMS.020.100	47	10+9,5
AGMS.020.105	47	10,5+10
AGMS.020.110	47	11+10,5
AGMS.020.115	47	11,5+11
AGMS.020.120	47	12+11,5
AGMS.020.125	47	12,5+12
AGMS.020.130	47	13+12,5
AGMS.020.135	47	13,5+13
AGMS.020.140	47	14+13,5
AGMS.020.145	47	14,5+14
AGMS.020.150	47	15+14,5
AGMS.020.155	47	15,5+15
AGMS.020.160	47	16+15,5
AGMS.020.165	47	16,5+16
AGMS.020.170	47	17+16,5
AGMS.020.175	47	17,5+17
AGMS.020.180	47	18+17,5
AGMS.020.185	47	18,5+18
AGMS.020.200	47	20+19,5
AGMS.032.060	68	6+5,5
AGMS.032.065	68	6,5+6
AGMS.032.070	68	7+6,5
AGMS.032.075	68	7,5+7
AGMS.032.080	68	8+7,5
AGMS.032.085	68	8,5+8
AGMS.032.090	68	9+8,5
AGMS.032.095	68	9,5+9
AGMS.032.100	68	10+9,5
AGMS.032.105	68	10,5+10
AGMS.032.110	68	11+10,5
AGMS.032.115	68	11,5+11
AGMS.032.120	68	12+11,5
AGMS.032.125	68	12,5+12
AGMS.032.130	68	13+12,5
AGMS.032.135	68	13,5+13
AGMS.032.140	68	14+13,5
AGMS.032.145	68	14,5+14
AGMS.032.150	68	15+14,5
AGMS.032.155	68	15,5+15
AGMS.032.160	68	16+15,5
AGMS.032.165	68	16,5+16
AGMS.032.170	68	17+16,5
AGMS.032.175	68	17,5+17
AGMS.032.180	68	18+17,5
AGMS.032.185	68	18,5+18
AGMS.032.190	68	19+18,5
AGMS.032.195	68	19,5+19
AGMS.032.200	68	20+19,5

ART.	(mm)	
	ØD	f
AGMS.032.205	68	20,5+20
AGMS.032.210	68	21+20,5
AGMS.032.215	68	21,5+21
AGMS.032.220	68	22+21,5
AGMS.032.225	68	22,5+22
AGMS.032.230	68	23+22,5
AGMS.032.235	68	23,5+23
AGMS.032.240	68	24+23,5
AGMS.032.245	68	24,5+24
AGMS.032.250	68	25+24,5
AGMS.032.255	68	25,5+25
AGMS.032.260	68	26+25,5
AGMS.032.265	68	26,5+26
AGMS.032.270	68	27+26,5
AGMS.032.275	68	27,5+27
AGMS.032.280	68	28+27,5
AGMS.032.285	68	28,5+28
AGMS.032.290	68	29+28,5
AGMS.032.295	68	29,5+29
AGMS.032.300	68	30+29,5
AGMS.032.305	68	30,5+30
AGMS.032.310	68	31+30,5
AGMS.032.315	68	31,5+30
AGMS.032.320	68	32+31,5

ART. 56..

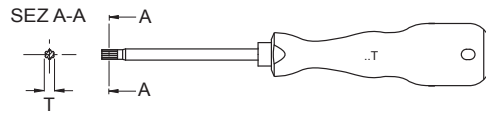

TORX

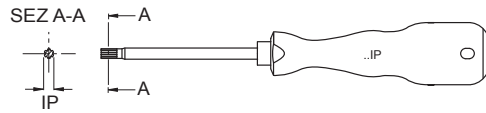

TORX PLUS

CACCIAVITI
SCREWDRIVERS
SCHRAUBENDREHER
TOURNEVISSES

ART.	(mm)		ART.	(mm)	
	Torx	Torx Plus		Torx	Torx Plus
5605P	-	5IP	5610P	-	10IP
5606	6	-	5615	15	-
5606P	-	6IP	5615P	-	15IP
5607	7	-	5620	20	-
5607P	-	7IP	5620P	-	20IP
5608	8	-	5625	25	-
5608P	-	8IP	5625P New	-	25IP
5609	9	-			
5609P	-	9IP			

ART. KITDP00000



KIT DINAPLUS
DYNAPLUS KIT
DYNAPLUS KIT
KIT DINAPLUS

ART. 26000

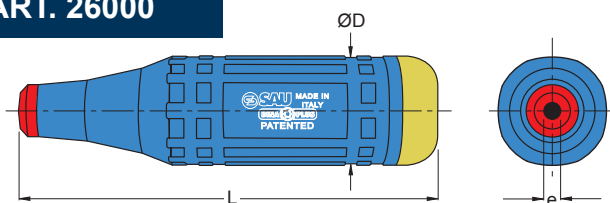

MANICO CACCIAVITE DINAPLUS
DYNAPLUS SCREWDRIVER HANDLE
DYNAPLUS SCHRAUBENDREHER-GRIFF
MANCHE TOURNEVIS DYNAPLUS

Contenuto del kit / Content of the kit :

- n°1 cacciavite / screwdriver DINAPLUS
- n°1 TORX T6 (Nm0,6)
- n°1 TORX T7 (Nm0,9)
- n°1 TORX T8 (Nm1,2)
- n°1 TORX T9 (Nm1,4)
- n°1 TORX T10 (Nm2,0)
- n°1 TORX T15 (Nm3,0)
- n°1 TORX T20 (Nm5,0)
- n°1 TORX PLUS IP6 (Nm0,6)
- n°1 TORX PLUS IP7 (Nm0,9)
- n°1 TORX PLUS IP8 (Nm1,2)
- n°1 TORX PLUS IP9 (Nm1,4)
- n°1 TORX PLUS IP10 (Nm2,0)
- n°1 TORX PLUS IP15 (Nm3,0)
- n°1 TORX PLUS IP20 (Nm5,0)

ART.	(mm)			270../290..
	e	ØD	L	
26000	7,3	33,2	131,4	

ART. 270..

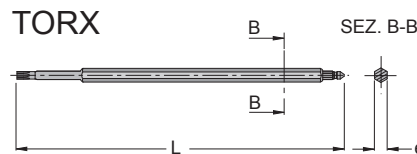

LAMA INTERCAMBIABILE
INTERCHANGEABLE BLADE
AUSTAUSCHBARES MESSER
LAME INTERCHANGEABLE

ART. 290..

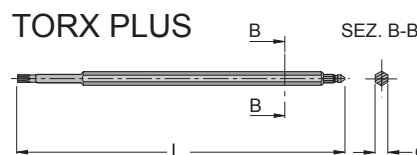

LAMA INTERCAMBIABILE
INTERCHANGEABLE BLADE
AUSTAUSCHBARES MESSER
LAME INTERCHANGEABLE

ART.	(mm)		Torx Plus	e	L	Nm Max	TIPO TYPE	COD. KIT
	Torx	Plus						
27006	6	-	6,3	175	0,6	Torx	27000	
27007	7	-	6,3	175	0,9			
27008	8	-	6,3	175	1,2			
27009	9	-	6,3	175	1,4			
27010	10	-	6,3	175	2,0			
27015	15	-	6,3	175	3,0			
27020	20	-	6,3	175	5,0			
29006	-	6IP	6,3	175	0,6	Torx Plus	29000	
29007	-	7IP	6,3	175	0,9			
29008	-	8IP	6,3	175	1,2			
29009	-	9IP	6,3	175	1,4			
29010	-	10IP	6,3	175	2,0			
29015	-	15IP	6,3	175	3,0			
29020	-	20IP	6,3	175	5,0			

CARATTERISTICHE E VANTAGGI:

- Grazie al sistema DINAPLUS si eviteranno serraggi eccessivi con conseguente grippaggio della vite o rottura inserto, tutto ciò con un sistema automatico, semplice ed intuitivo
- Facilissimo da usare, nessun tipo di regolazione da effettuare, la regolazione avviene automaticamente inserendo la lama nell'impugnatura.
- Ampia gamma di lame utilizzabili (T6÷T20 / IP6÷IP20), facilmente identificabili, inserite in un comodo KIT.
- Nello svitamento la coppia di serraggio è al 100%
- Impugnatura elegante, in alluminio anodizzato

USO:

Inserire nell'impugnatura la lama adatta alla sede torx da utilizzare, **dopo essersi assicurati che abbia raggiunto la battuta (udibile con un "clack")**, (il numero presente ne stabilirà la grandezza esatta) (fig.1a), per avvitare, ruotare in senso orario il cacciavite fino a raggiungere lo scatto (udibile con un "clack"), che determina la giusta coppia di serraggio della vite (fig.2), per svitare, ruotare in senso antiorario il cacciavite (fig.3). L'estrazione di una qualsiasi lama dall'impugnatura si può effettuare quando la stessa si trova in posizione neutra (fig.1b) e subito dopo il clack di avvitamento di una vite (fig.2) operazioni diverse da quelle indicate potrebbero compromettere l'integrità del cacciavite.

FEATURES AND ADVANTAGES:

- The DINAPLUS system avoids overtightening which can seize the screws or break the insert. The system is automatic, simple and user-friendly.
- Very easy to use, no adjustments required, the blade is set automatically in the handle.
- Wide range of blades (T6÷T20 / IP6÷IP20), easily identifiable in a handy KIT.
- 100% unscrewing torque
- Elegant handle in anodised aluminium.

USE:

Insert the blade in the handle suited to the torx head screw to use but before doing so, **make sure it has snapped in (you should hear a "click")**, (the number gives the exact size) (fig.1a). To screw down, turn the screwdriver clockwise until you **hear the click**, which means the tightening torque is right (fig.2), while to unscrew it turn the screwdriver anticlockwise (fig.3). All blades can be taken out of the handle only when the latter is in the neutral position (fig.1b) and straight after the tightening click of a screw (fig.2); the screwdriver could be damaged if done any differently.



Viti TORX	Viti TORX PLUS	Nm
T6	IP6	0,6
T7	IP7	0,9
T8	IP8	1,2
T9	IP9	1,4
T10	IP10	2,0
T15	IP15	3,0
T20	IP20	5,0



ART. 55..

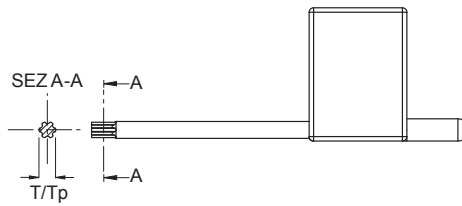

CHIAVE A BANDIERA
FLAG KEY
FLAGGE-SCHLÜSSEL
CLÉ À "PAVILLON"

(mm)			(mm)		
ART.	Torx	Torx Plus	ART.	Torx	Torx Plus
5506P	-	6IP	5520	20	-
5507P	-	7IP	5520P	-	20IP
5508P	-	8IP	5525	25	-
5509	9	-			
5510	10	-			
5510P New	-	10IP			
5515P	-	15IP			

ART. 54..

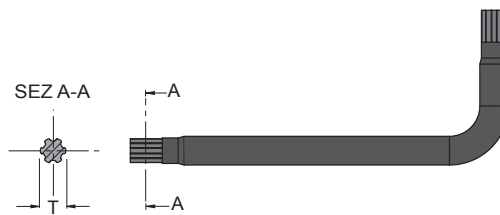

CHIAVE TORX A L
TORX KEY (L-SHAPED)
TORX-SCHLÜSSEL (L-FÖRMIG)
CLÉ TORX À L

(mm)			(mm)		
ART.	Torx	Torx Plus	ART.	Torx	Torx Plus
5407	7	-	5420	20	-
5408	8	-	5420P New	-	20IP
5409	9	-	5425	25	-
5410	10	-	5430	30	-
5410P New	-	10IP	5440	40	-
5415	15	-			
5415P New	-	15IP			

ART. CTT..

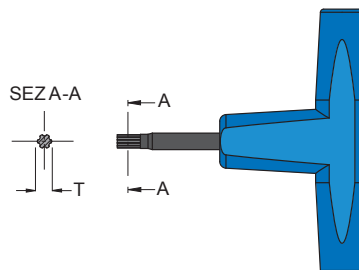

CHIAVE TORX A T
TORX KEY (T-SHAPED)
TORX-SCHLÜSSEL (T-FÖRMIG)
CLÉ TORX À T

(mm)	
ART.	Torx
CTT 20	20
CTT 25	25

ART. 50..

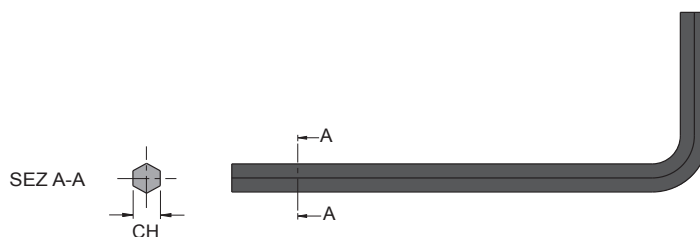

CHIAVE A BRUGOLA A L
L-SETSCREW WRENCH
L-INBUSSCHLÜSSEL
CLÉ À 6 PANS À L

(mm)		(mm)	
ART.	CH	ART.	CH
5015	1,5	5005	5,0
5002	2,0	5006	6,0
5025	2,5	5007	7,0
5003	3,0	5008	8,0
5035	3,5	5010	10,0
5004	4,0	5017	17,0
5045	4,5		

ART. CH-TRL30-40

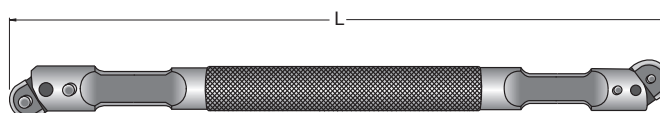

CHIAVE ERGONOMICA MONTAGGIO/ESTRAZIONE INSERTI
INSERT ASSEMBLY/REMOVAL ERGONOMIC KEY
ERGONOMISCHER MONTAGE-/AUSZIEHLSCHLÜSSEL FÜR WENDEPLATTEN
CLÉ A MANCHE ERGONOMIQUE DE MONTAGE/EXTRACTION DES PLAQUETTES

(mm)	
ART.	L
CH-TRL30-40	220

ART. 45.95.6..

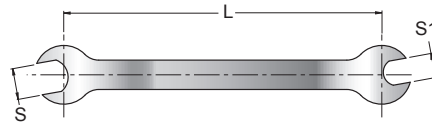

CHIAVE PER UNITÀ MICROREGISTRABILI
KEY FOR MICRO-BORING UNITS
SCHLÜSSEL FÜR FEINBOHREINHEITEN
CLÉ POUR UNITÉS MICROMÉTRIQUES



(mm)

ART.	L	S	S1
45.95.640	130	13	10
45.95.644	130	22	15

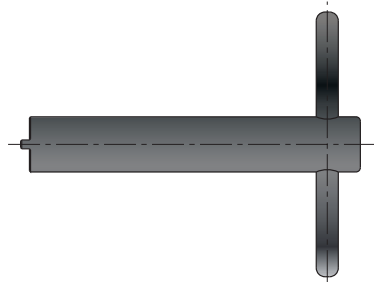
ART. CH-HK..





CHIAVE A DENTI PER BOCCOLE BCF
PIN WRENCH FOR BCF BUSHING
ZAPFENSCHLÜSSEL FÜR BCF-BUCHSEN
CLÉ À GIFFES POUR DOUILLE BCF

ART.		ART.	
CH-HK040	ATR012 HK40	CH-HK080	ATR020 HK80
CH-HK050	ATR016 HK50	CH-HK100	ATR024 HK100
CH-HK063	ATR018 HK63		

ART. 925..



CHIAVE A SETTORE CON DENTE PER GHIERE RGS/RGC
PIN WRENCH FOR RGS/RGC
ZAPFENSCHLÜSSEL FÜR RGS/RGE RING
CLÉ À SECTEUR AVEC GRIFFE POUR FRETTEES RGS/RGC

ART.		
925.022	RGC ER16	RGS ER16
925.040	RGC ER25	RGS ER25
925.052	RGC ER32	RGS ER32
925.058	-	-
925.068	RGC ER40	RGS ER40

ART. 927..

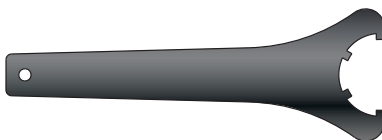

CHIAVE A SETTORE CON 4 DENTI PER GHIERE RGS
PIN WRENCH(4TEETH) FOR RGS
ZAPFENSCHLÜSSEL FÜR RGS (4 ZÄHNE)
CLÉ À SECTEUR À 4 GRIFFES POUR FRETTEES RGS

ART.		
927.022	RGS ER16	
927.040	RGS ER25	
927.052	RGS ER32	
927.068	RGS ER40	

ART. 938..

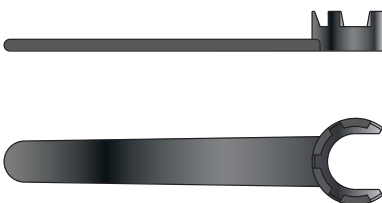

CHIAVE A SETTORI PER GHIERE RGM
PIN WRENCH FOR RGM
ZAPFENSCHLÜSSEL FÜR RGM-RINGE
CLÉ À SECTEUR POUR FRETTEES RGM

ART.		
938.011	RGM ER11	
938.016	RGM ER16	
938.025	RGM ER25	

ART. 423..



CHIAVE PER VITI CON TESTA A CROCE
CROSS-SLOTTED SCREW WRENCH
KREUZSCHLÜSSEL
CLÉ POUR VIS AVEC TÊTE À CROIX

ART.		
423.016.000.000		422.016..
423.022.000.000		422.022..
423.027.000.000		422.027..
423.032.000.000		422.032..
423.040.000.000		422.040..

ART. 195..

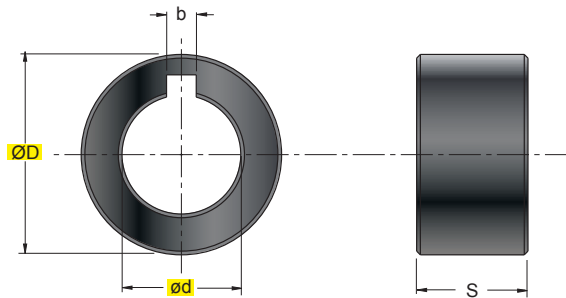

ANELLO DISTANZIATORE PER PORTAFRESA COMBINATO
DISTANCE RING FOR COMBI MILL-HOLDER
Distanzring für Kombi-Fräseraufnahme
Bague d'entretoise pour mandrin porte-fraise combiné

ART.	(mm)								
	ØD	ød	b	S					
195.016.010	25	16	4	1					
195.016.020	27	16	4	2					
195.016.030	27	16	4	3					
195.016.040	27	16	4	4					
195.016.050	27	16	4	5					
195.022.010	33	22	6	1					
195.022.020	34	22	6	2					
195.022.030	34	22	6	3					
195.022.040	34	22	6	4					
195.022.050	34	22	6	5					
195.027.010	39	27	7	1					
195.027.020	41	27	7	2					
195.027.030	41	27	7	3					
195.027.040	41	27	7	4					
195.027.050	41	27	7	5					
195.032.010	45	32	8	1					
195.032.020	47	32	8	2					
195.032.030	47	32	8	3					
195.032.040	47	32	8	4					
195.032.050	47	32	8	5					
195.040.010	54	40	10	1					
195.040.020	55	40	10	2					
195.040.030	55	40	10	3					
195.040.040	55	40	10	4					
195.040.050	55	40	10	5					
195.050.010	67	50	12	1					
195.050.020	69	50	12	2					
195.050.030	69	50	12	3					
195.050.060	69	50	12	6					

ART. ESMS..



ESTRATTORE PER PINZE
 EXTRACTOR FOR COLLETS
 ENTFERNER FÜR REDUZIERHULSEN
 EXTRACTEUR POUR PINCES

ART.		
ESMS.010		

ART. ATUB..

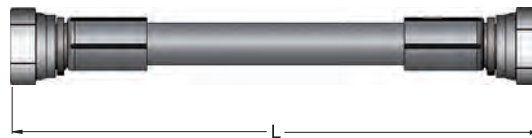

TUBO DRITTO RACCORDATO
 FITTED HOSE STRAIGHT
 GERADE SCHLAUCHLEITUNG
 TUBE DROIT RACCORDE

ART.	L (mm)	
ATUB150TT0	150	3/16"FF 1/8G-1/8G
ATUB225TT0	225	3/16"FF 1/8G-1/8G
ATUB300TT0	300	3/16"FF 1/8G-1/8G

ART. A00MM18..



RACCORDO DRITTO
 STRAIGHT FITTING
 GERADE VERBINDUNGSSTÜCK
 RACCORD DROIT

ART.	
A00MM18180	MM 1/8G-1/8G
A00MM18100	MM 1/8G-M10

ART. ARIMF14180

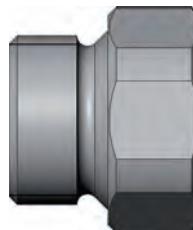

RIDUZIONE
 ADAPTER
 REDUZIERUNGEN
 RÉDUCTION

ART.	
ARIMF14180	FM 1/8G-1/4G

ART. A90MM18..

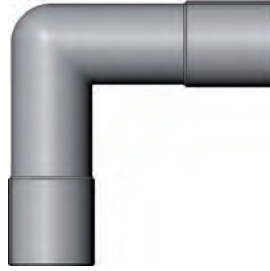

RACCORDO 90°
90° FITTING
90°-KUPPLUNG
RACCORD 90°

ART.

A90MM18180	MM 1/8G-1/8G
A90MM18100	MM 1/8G-M10

ART. ABS000M100



ANELLO DI TENUTA
SEALING RING
DICHRING
ANNEAU D'ETANCHEITE

ART.

ABS000M100	B-SEAL M10
------------	------------

ART. AOG...F18

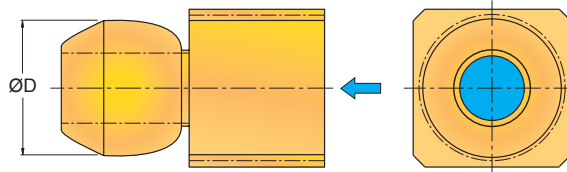

OGIVA LUBROREFRIGERANTE
COOLING LUBRICANT NOSE CONE
KÜHLSCHMIERMITTEL-NASENKEGEL
OGIVE LUBRIFIANTE-RÉFRIGÉRANTE

ART.	ØD	F 1/8G	ART.	ØD	F 1/8G
AOG100F18	10,0	F 1/8G	AOG150F18	15,0	F 1/8G
AOG120F18	12,0	F 1/8G	AOG159F18	15,9	F 1/8G
AOG127F18	12,7	F 1/8G			

ART. MS...

- STAFFA ARRESTO LATERALE, COPPIA TASSELLI 16mm, CHIAVE A PIPA, CHIAVE A BRUGOLA A T, IN DOTAZIONE
- SIDE STOP BRACKET, PAIR OF SMALL BLOCKS 16mm, PIPE WRENCH, T-SETScrew WRENCH, INCLUDED

NEW

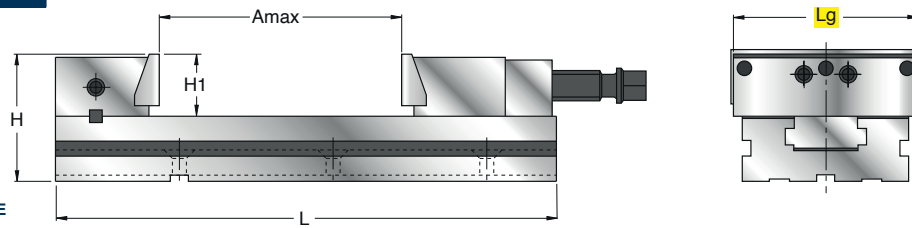

MORSA MODULARE DI PRECISIONE
MODULAR PRECISION VICE
MODULARER PRÄZISIONSSCHRAUBSTOCK
ETAU MODULAIRE DE PRECISION

ART.	(mm)			kg	ART.	(mm)			kg
	Lg	Amax	L			Lg	Amax	L	
MS125150	125	150	345	20,00	MS200300	200	300	520	65,00
MS150200	150	200	420	32,00	MS200400	200	400	655	69,00
MS150300	150	300	520	37,00	MS200500	200	500	795	74,00
MS175300	175	300	520	50,00					
MS175400	175	400	655	63,00					

- BLOCCAGGIO CON CHIAVE A BRUGOLA HRC 60 E PRECISIONE 0,02/0,03
- CLAMPING WITH ALLEN KEY HRC 60 AND 0,02/0,03 PRECISION

ART. GNL...

NEW

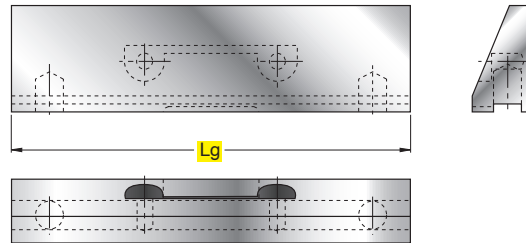

GANASCIA LISCIA
SMOOTH JAW
GLATTE BACKE
MACHOIRE LISSE

ART.	Lg
* GNL125	125
* GNL150	150
* GNL175	175
* GNL200	200

* COPPIA - COUPLE - PAAR - COUPLE

ART. GNR...

NEW

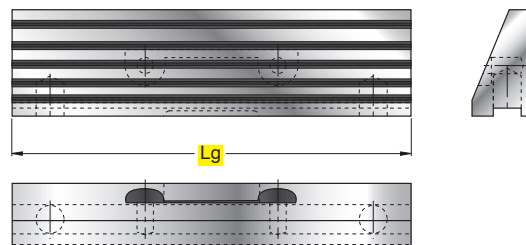

GANASCIA RIGATA
GROOVED JAW
RIFFELBACKE
MACHOIRE STRIEE

ART.	Lg
* GNR125	125
* GNR150	150
* GNR175	175
* GNR200	200

* COPPIA - COUPLE - PAAR - COUPLE

ART. GNS...

NEW

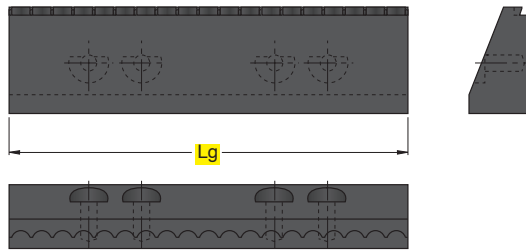

GANASCIA "SMART GRIP"
"SMART GRIP" JAW
"SMART GRIP" BACKE
MACHOIRE "SMART GRIP"

ART.	Lg
------	----

*GNS150	150
---------	-----

* COPPIA - COUPLE - PAAR - COUPLE

ART. GNP...

NEW

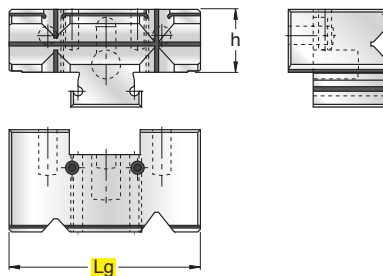

GANASCIA A PRISMA
PRISM JAW
PRISMA-BACKE
MACHOIRE A PRISME

ART.	Lg	h
------	----	---

GNP125	125	32
--------	-----	----

GNP150	150	44
--------	-----	----

ART.	Lg	h
------	----	---

GNP175	175	46
--------	-----	----

GNP200	200	52
--------	-----	----

ART. BLV...

NEW

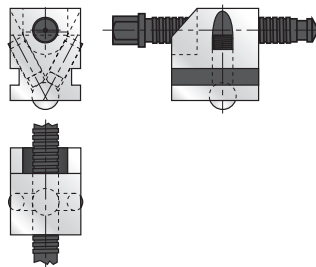

BLOCCHETTO - VITE
BLOCK - SCREW
BLOCK - SCHRAUBE
CALE - VIS

ART.	Misura Measure Mesure Messen
------	---------------------------------------

BLV125	125
--------	-----

BLV150	150
--------	-----

ART.	Misura Measure Mesure Messen
------	---------------------------------------

BLV175	175
--------	-----

BLV200	200
--------	-----

ART. BAG...

NEW

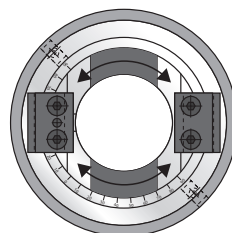

BASE GIREVOLE
SWIVEL BASE
SCHWENKFUSS
BASE TOURNANTE

ART.	Misura Measure Mesure Messen
------	---------------------------------------

BAG125	125
--------	-----

BAG150	150
--------	-----

ART.	Misura Measure Mesure Messen
------	---------------------------------------

BAG175	175
--------	-----

BAG200	200
--------	-----

ART. SPM-CN...

NEW

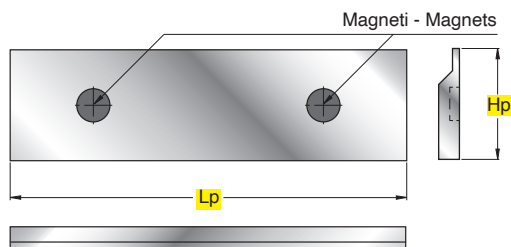



PIASTRE PARALLELE MAGNETICHE AL NEODIMIO
NEODYMIUM MAGNETIC PARALLEL PLATES
PARALLEL-MAGNETPLATTEN AUS NEODYM
PLAQUES PARALLELES MAGNETIQUES AU NEODYME

CN

ART.	Hp	Lp
* SPM-CN-200145	20,0	145
* SPM-CN-250145	25,0	145
* SPM-CN-300145	30,0	145
* SPM-CN-350145	35,0	145
* SPM-CN-375145	37,5	145
* SPM-CN-400145	40,0	145
* SPM-CN-425145	42,5	145
* SPM-CN-450145	45,0	145
* SPM-CN-475145	47,5	145
* SPM-CN-500145	50,0	145
* SPM-CN-550145	55,0	145
* SPM-CN-575145	57,5	145

* COPPIA - COUPLE - PAAR - COUPLE

 CN = ACCIAIO CARBONITRURATO

 CN = CARBONITRIDED STEEL

 CN = KARBONITRIERTER STAHL

 CN = ACIER CARBONITRURÉ

ART. KIT-DIS-M10

NEW

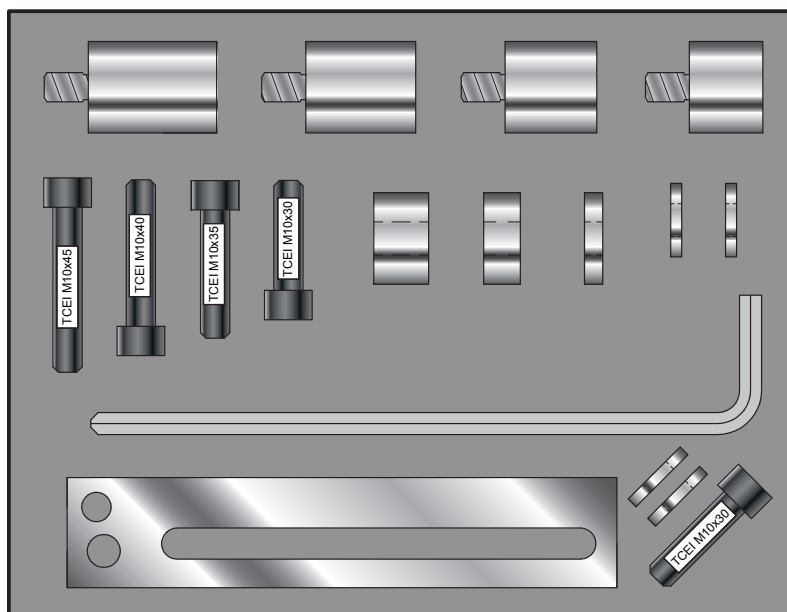

KIT DI ACCESSORI DI BATTUTA E DISTANZIALI PER MORSE DI PRECISIONE
STOP SET AND SPACERS FOR PRECISION VISES
ANSCHLAGSET UND ABSTANDSHALTER FÜR PRÄZISIONSSCHRAUBSTÖCKE
JEU D'ACCESSOIRES DE BUTEE ET ENTRETOISES POUR ETAUX DE PRECISION

Contenuto del KIT / Content of the KIT

- n°1	Distanziale / Spacer	05x25x11
- n°1	Distanziale / Spacer	10x25x11
- n°1	Distanziale / Spacer	15x25x11
- n°1	Distanziale / Spacer	20x25xM10
- n°1	Distanziale / Spacer	25x25xM10
- n°1	Distanziale / Spacer	30x25xM10
- n°1	Distanziale / Spacer	35x25xM10
- n°1	Battuta / Stop	30x15x150xM10
- n°4	Rondella rinforzata / Reinforced washer	20x11x3
- n°2	Vite 8.8 Tcei / Socket head cap screw 8.8	M10x30
- n°1	Vite 8.8 Tcei / Socket head cap screw 8.8	M10x35
- n°1	Vite 8.8 Tcei / Socket head cap screw 8.8	M10x40
- n°1	Vite 8.8 Tcei / Socket head cap screw 8.8	M10x45
- n°1	Chiave Inbus / Allen key	CrV-CH8

ART. MOLYKOTE HSC PLUS 1000

NEW

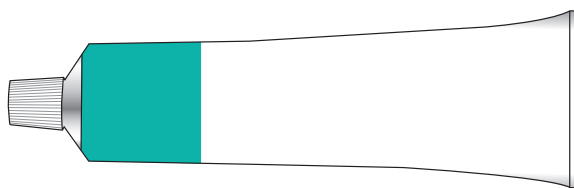

PASTA MOLYKOTE HSC PLUS TUBETTO 100gr
MOLYKOTE HSC PLUS PASTE, TUBE 100G
MOLYKOTE HSC PLUS PASTE, TUBE 100G
PATE MOLYKOTE HSC PLUS TUBE 100 G

ART.	Misura Measure Mesure Messen
MOLYKOTE HSC PLUS 1000	100gr

COME SI USA - HOW TO USE

Se possibile, pulire la filettatura e i bulloni usati con una spazzola metallica. Spalmare una quantità adeguata di pasta sulle zone di contatto in modo da ottenere una buona tenuta. Un eccesso non è dannoso. Per non alterarne le proprietà la pasta non deve essere miscelata con grassi o oli.

If possible, clean the thread and used bolts with a wire brush. Spread an adequate amount of the paste on the contact areas in order to obtain a good seal. An excess is not harmful. In order not to alter the properties, the paste must not be mixed with greases or oils.

CARATTERISTICHE TECNICHE - TECHNICAL CHARACTERISTICS

1. Utilizzabile in un ampio intervallo di temperature
2. Capacità di portata elevata
3. Buona protezione contro la corrosione
4. Previene il grippaggio in caso di esposizione prolungata a temperature elevate
5. Buona conduttività elettrica

1. Wide service temperature range
2. High load carrying capacity
3. Good corrosion protection
4. Prevents seizure after long exposure to high temperatures
5. Good electrical conductivity

INDICE - INDEX - INHALTSÜBERSICHT - INDEX - INDICE

- Viti di fissaggio inserti - Insert clamping screws		1104	- Sedi in metallo duro - Solid carbide seats		1117
- Viti staffe - Bracket screws		1105	- Rompitruccioli - Chip-breakers		1119
- Viti leve - Lever screws		1106	- Anelli di trascinamento - Driving rings		1119
- Viti a testa cilindrica - Cheese-headed screws		1106	- Rondelle - Washers		1119
- Viti - Screws		1108	- Spessori - Shims		1120
- Viti di regolazione - Adjusting screws		1109	- Tasselli - Small blocks		1120
- Viti a testa svasata - Countersunk screws		1109	- Adattatori - Adapters		1120
- Grani - Dowels		1110	- Blocchetti - Blocks		1121
- Prigionieri - Stud bolts		1112	- Punzoni - Punches		1121
- Boccole - Bushes		1113	- Guarnizioni OR - OR seals		1121
- Chiavette di trascinamento - Driving keys		1113	- Molle - Springs		1122
- Perni - Pins		1114	- Raccordi/Ugelli - Joints/Nozzles		1122
- Leve - Levers		1115	- Anelli Seeger - Seeger rings		1122
- Staffe - Brackets		1115	- Spine - Pins		1123
- Cunei - Wedges		1116	- Porta inserto per unità microreg. - Insert holder for micro-boring unit		1123
- Sedi in acciaio - Steel seats		1117	- Componenti Smussatori - Components chamfering tools		1124

VITI DI FISSAGGIO INSERTI - INSERT CLAMPING SCREWS
WENDEPLATTENSCHRAUBEN - VISSÉS POUR LE FIXAGE PLAQUETTES

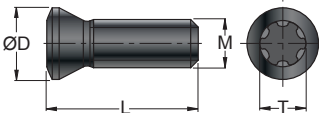
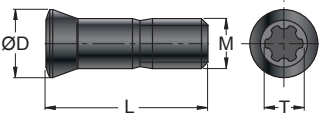
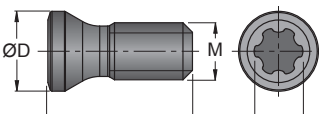
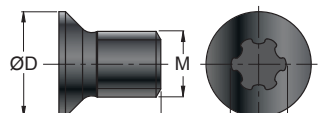
	ART.	(mm)				Nm	
		ØD	M	L	Torx		
	121837P	2,7	M1,8x0,35	3,7	6IP	0,4±0,5	
	122033	2,7	M2x0,4	3,3	6	0,5±0,6	
	12203	2,7	M2x0,4	3,6	6	0,5±0,6	
	12204P	2,6	M2x0,4	4,8	6IP	0,5±0,6	
	122041P	2,7	M2x0,4	4,0	6IP	0,5±0,6	
	122042	2,8	M2x0,4	4,0	6	0,5±0,6	
	12205	3,6	M2x0,4	5,4	6	0,5±0,6	
	12224	3,0	M2,2x0,45	4,5	7	0,9±1,0	
	12225P	3,0	M2,2x0,45	5,15	7IP	0,9±1,0	
	122285P	3,0	M2,2x0,45	8,5	7IP	0,9±1,0	
	1225P	3,5	M2,5x0,45	7,0	7IP	1,0±1,2	
	122510P	3,5	M2,5x0,45	10,0	7IP	1,0±1,2	
	12253	3,5	M2,5x0,45	4,5	7	1,0±1,2	
	12254P	3,5	M2,5x0,45	5,5	7IP	1,0±1,2	
	122545	3,0	M2,5x0,45	4,5	7	1,0±1,2	
	122549	3,2	M2,5x0,45	5,0	7	1,0±1,2	
	12255P	3,6	M2,5x0,45	5,5	8IP	1,1±1,3	
	122555PK	3,4	M2,5x0,45	5,5	8	1,1±1,3	
	12256CP	3,5	M2,5x0,45	5,5	8IP	1,1±1,3	
	12256P	3,5	M2,5x0,45	6,3	8IP	1,1±1,3	
	122564P	3,45	M2,5x0,45	6,4	8IP	1,1±1,3	
	123006	4,1	M3x0,5	5,4	8	1,2±1,5	
	123008P	4,1	M3x0,5	7,3	8IP	1,2±1,5	
	123010	4,3	M3x0,5	8,8	8	1,2±1,5	
	123009P	4,8	M3,5x0,6	9,4	10IP	2,0±3,0	
	123084P	4,4	M3x0,5	8,4	8IP	1,2±1,5	
	123505	5,2	M3,5x0,6	6,7	15	3,0±3,5	
	123507P	5,2	M3,5x0,6	7,2	15IP	3,0±3,5	
	123509P	5,2	M3,5x0,6	8,6	15IP	3,0±3,5	
	123511P	5,2	M3,5x0,6	11,0	15IP	3,0±3,5	
	123512P	5,3	M3,5x0,6	12,1	15IP	3,0±3,5	
	12404P	4,4	M4x0,7	4,5	8IP	1,2±1,5	
	1240P	5,3	M4x0,7	11,0	15IP	3,8±5,0	
	12409P	5,3	M4x0,7	8,5	15IP	3,8±5,0	
	124095P	5,65	M4x0,7	9,5	15IP	3,8±5,0	
	124011P	6,5	M4x0,7	11,5	20IP	3,8±5,0	
	1440	5,3	M4x0,7	7,4	15	3,5±4,0	
	124015P	5,7	M4x0,7	15	15IP	3,8±5,0	
	124510P	6,6	M4,5x0,75	10,5	20IP	4,0±5,0	
	124511P	6,9	M4,5x0,75	11,0	20IP	4,0±5,0	
	124512P	6,6	M4,5x0,75	11,5	20IP	4,0±5,0	
	124513P	6,6	M4,5x0,75	13,0	20IP	4,0±5,0	
	125088	6,6	M5x0,8	8,8	20	5,5±7,0	
	125009	7,2	M5x0,8	9,0	20	5,5±7,0	
	125011	7,2	M5x0,8	10,5	20	5,5±7,0	
126011	9,2	M6x1	11,0	25	7,5±9,0		
126012	8,5	M6x1	12,0	25	7,5±9,0		
126014P	11,2	M6x1	14,0	20IP	4,0±5,0		
126018P	8,5	M6x1	18,2	25IP	7,5±9,0		
	12RA08	3,1	M2,5x0,35	6,25	7	0,8±1,0	
	12RA10	3,7	M3x0,35	7,8	8	1,8±2,0	
	12RA12P	4,7	M3,5x0,6	9,5	10	2,8±3,0	
	12RA16P	5,8	M4x0,7	13,3	15IP	4,5±5,5	
	12RA20P	6,8	M5x0,8	16,2	20IP	5,5±7,0	
	12RA25	8,4	M6x1	20,0	30	10±13	
	12RA32	11,0	M8x1,25	25,0	40	24±30	
	C03007	4,2	M3x0,5	7,6	9IP	1,5±2,0	
	C04008P	5,5	M4x0,7	8,2	15IP	3,8±5,0	
	C04011P	5,5	M4x0,7	10,5	15IP	3,8±5,0	
	C93504	5,25	M3,5x0,6	3,5	9	1,8±2,0	
	C93505P	5,25	M3,5x0,6	4,1	9IP	1,8±2,0	
	C94005P	6,4	M4x0,7	5,0	15IP	2,0±2,2	
	C94006	6,4	M4x0,7	6,2	15	2,0±2,2	
	C94008P	6,4	M4x0,7	8,2	15IP	2,0±2,2	
	C94010P	6,4	M4x0,7	10,0	15IP	2,0±2,2	

VITI DI FISSAGGIO INSERTI - INSERT CLAMPING SCREWS
WENDEPLATTENSPPANNSCHRAUBEN - VISSIS POUR LE FIXAGE PLAQUETTES

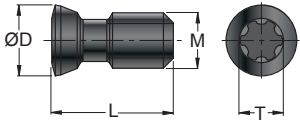
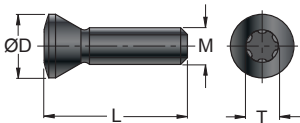
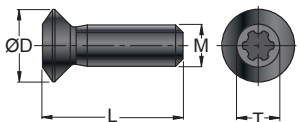
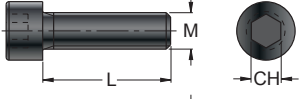
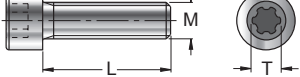
	ART.	(mm)				Nm 
		ØD	M	L	Torx/CH	
	FS 242 FS 243 FS 244P	6,4 6,4 5,04	M5x0,8 M5x0,8 M4x0,7	9,5 11 9,0	20 20 15IP	5,5±7,0 5,5±7,0 3,5±4,0
	S16TP S22T	5,5 7,5	5-40UNC 8-32UNC	12,4 14,9	10IP 20	1,8±2,0 2,5±3,0
	SM 521 SM 522 SM 523 SM 612	8,8 8,8 8,8 10	M5x0,8 M5x0,8 M5x0,8 M6x1	17 20 15 17	20 20 20 CH4	5,0±6,0 5,0±6,0 5,0±6,0 5,5±7,0
	SM 516 SM 520 SM 614 SM 620	- - - -	M5x0,8 M5x0,8 M6x1 M6x1	16 20 14 20	CH 4 CH 4 CH 5 CH 5	5,0±6,0 5,0±6,0 5,5±7,0 5,5±7,0
	VBZ0412 VBZ0516	- -	M4x0,7 M5x0,8	16 21	CH 3 CH 4	5,0±6,0 5,0±6,0

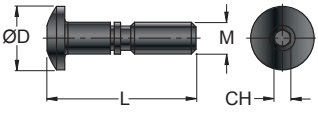
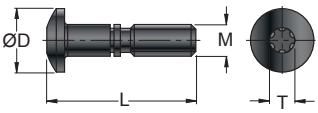

VITI STAFFE - BRACKET SCREWS
PRATZENSCHRAUBEN - VISSIS POUR BRIDES

	ART.	(mm)					
		ØD	M	L	CH	Torx	
	1614	10	W1/4"	25	4	-	PER STAFFA: FOR BRACKET: 2316 / 2326 100-53 100-50 / 100-52 100-51
	100-82	7,8	M5x0,8	18,5	-	9	
	100-84	10	M5x0,8	23,5	2,5	-	
	100-85	11	M6x1	25,5	3	-	

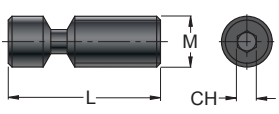
**VITI LEVE - LEVER SCREWS
HEBELSCHRAUBEN - VISSÉS LEVIERS**

	ART.	(mm)				
		ØD	M	L	CH	
	1603	—	M5x0,8	9,5	2	
	1604	—	M6x1	13,6	2,5	
	1605	—	M5x0,8	12	2	
	1606	—	M6x1	17	2,5	
	1608	—	M8x1	21	3	
	1610	—	M10x1	27	4	
	1618	—	M8x1	24	3	
	1628	—	M8x1	22	3	
	1638	—	M8x1	21	3	
	1648	—	M8x1	17	3	

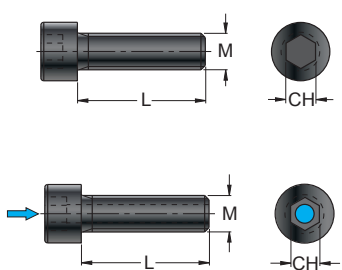
**VITI A TESTA CILINDRICA - CHEESE-HEADED SCREWS
ZYLINDERKOPFSCHRAUBEN - VISSÉS À TÊTE CYLINDRIQUE**

	ART.	(mm)				
		ØD	M	L	CH	
	905.004.070.010	—	M4x0,7	10	3	
	905.005.080.012	—	M5x0,8	12	4	
	905.010.150.045	—	M10x1,5	45	8	
	905.010.150.070	—	M10x1,5	70	8	
	905.012.175.035	—	M12x1,75	35	10	
	905.012.175.055	—	M12x1,75	55	10	
	AL 6X14	—	M6x1	14	4	
	AL 10X30	—	M10x1,5	30	7	
	AL 10X40	—	M10x1,5	40	7	
	AL 12X35	—	M12x1,75	35	8	
	AL 16X35	—	M16x2	35	12	
	AL 20X45	—	M20x2,5	45	14	
	VB 02	—	M3x0,5	10	2,5	
	VB 03	—	M3x0,5	12	2,5	
	VB 04	—	M4x0,7	10	3	
	VB 05	—	M5x0,8	14	4	
	VB 06	—	M6x1	17,5	5	
	VB 06C	—	M6x1	30	5	
	VB 06L	—	M6x1	16	5	
	VB 06XL	—	M6x1	25	5	
	VB 10	—	M10x1,5	45	8	
	VB 12	—	M12x1,75	55	10	
	VB 12C	—	M12x1,75	25	10	
	VB 16	—	M16x2	55	14	
	VB 20 	—	M20x2,5	70	12	
	VBC 04	—	M4x0,7	12	3	
	VBC 05	—	M5x0,8	14	4	
	VBC 06	—	M6x1	16	5	

**VITI A TESTA CILINDRICA - CHEESE-HEADED SCREWS
ZYLINDERKOPFSCHRAUBEN - VISSÉS À TÊTE CYLINDRIQUE**

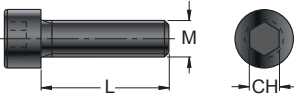
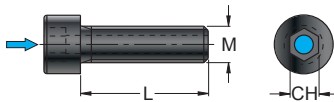
	ART.	(mm)					
		ØD	M	L	CH	Torx	
	VBL 03	-	M3x0,5	4,3	2,5	-	
	VBL 03C	-	M3x0,5	3,5	2,5	-	
	VBL 03L	-	M3x0,5	6	2,5	-	
	VBL 03XL	-	M3x0,5	8	2,5	-	
	VBL 05	-	M5x0,8	20	4	-	
	VBL 05L	-	M5x0,8	80	4	-	
	VBL 06	-	M6x1	30	5	-	
	VBL 06BL	-	M6x1	28	5	-	
	VBL 06C	-	M6x1	12	5	-	
	VBL 06L	-	M6x1	35	5	-	
	VBL 08	-	M8x1,25	45	6	-	
	VBL 10	-	M10x1,5	65	8	-	
	VBL 10C	-	M10x1,5	50	8	-	
	VBL 10L	-	M10x1,5	75	8	-	
	VBSF08C	-	M8x1,25	25	6	-	
	VBSF08L	-	M8x1,25	35	6	-	
	VBSF10	-	M10x1,5	30	8	-	
	VBSF10L	-	M10x1,5	45	8	-	
	VBSF10XL	-	M10x1,5	50	8	-	
	VBSF12	-	M12x1,75	35	10	-	
	VBSF12L	-	M12x1,75	45	10	-	
	VBSF16	-	M16x2	35	14	-	
	VBSF16L	-	M16x2	45	14	-	
	VBSF20	-	M20x2,5	45	17	-	
	VBTF10	-	M10x1,5	100	8	-	
	VBTF10L	-	M10x1,5	120	8	-	
	VS16TP	-	5-40UNC	4,2	-	10IP	
	VS22T	-	8-32UNC	5,2	-	20	

**VITI - SCREWS
SCHRAUBEN - VISSÉS**

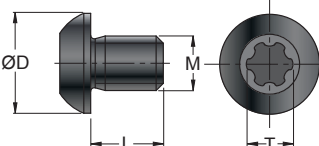
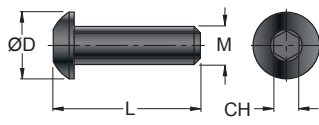
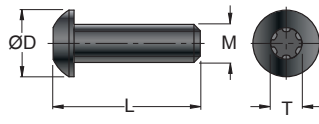
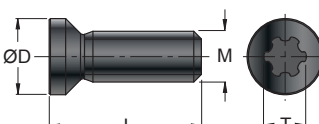
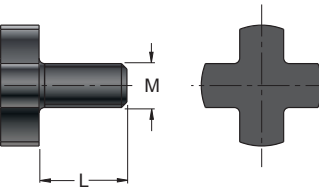
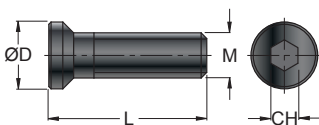
	ART.	(mm)					
		ØD	M	L	CH	Torx	
	100-86P 100-87P	5,4 7,4	M3x0,5 M4x0,7	4 4	- -	8IP 15IP	
 	1803 1803C 1803N 1804 1806 1806C 1808	5,5 5,5 5,5 7,3 10,3 10,3 13,8	M3x0,5 M3x0,5 M3x0,5 M4x0,7 M6x1 M6x1 M8x1,25	11,5 9,5 11,5 12,5 25 23 35	2 2 - 2,5 4 4 5	- - 9 - - - -	
	183008P 184012P 185014P N° 3 183008P 45.95.532 N° 3 184012P 45.95.536 N° 3 185014P 45.95.538	4,4 6,0 10,0	M3x0,5 M4x0,7 M5x0,8	8 12 14	- - -	8 15 20	
	422.016.000.000 422.022.000.000 422.027.000.000 422.032.000.000 422.040.000.000	- - - - -	M8x1,25 M10x1,5 M12x1,75 M16x2 M20x2,5	16 18 22 25 30	- - - - -	- - - - -	
	VBSF08 VBSF10AV	11 14	M8x1,25 M10x1,5	35 40	5 6	- -	

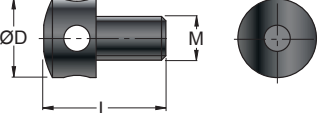

**VITI DI REGOLAZIONE - ADJUSTING SCREWS
STELLSCHRAUBEN - VISSÉS DE RÉGLAGE**

	ART.	(mm)					
		ØD	M	L	CH	Torx	
	1403	5	M3x0,5	11	-	-	
	1405	9	M5x0,8	14	-	-	
	1406	10	M6x1	15	-	-	

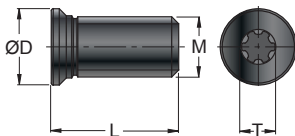
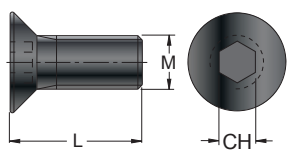
**VITI A TESTA SVASATA - COUNTERSUNK SCREWS
SENKSCHEUBEN - VISSÉS À TÊTE ÉVASÉE**

	ART.	(mm)					
		ØD	M	L	CH	Torx	
	KMS 3	6	M5x0,8	8	-	9	
	KMS 4	7,6	M6x1	12,7	-	15	
	KMS 4S	7,6	M6x1	11,0	-	15	
	KMS 5	10,2	M8x1	16	-	15	
	KMS 6	11,8	M10x1	16	-	15	
	VBS 0308	-	M3x0,5	8	2	-	
	VBS 08	-	M8x1,25	35	5	-	
	VBS 10	-	M10x1,5	30	6	-	
	VBS 12	-	M12x1,75	35	8	-	
	VBS 16	-	M16x2	40	10	-	
	VBS 20	-	M20x2,5	40	12	-	
	VBS 24	-	M24x3	40	14	-	

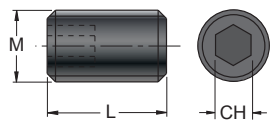
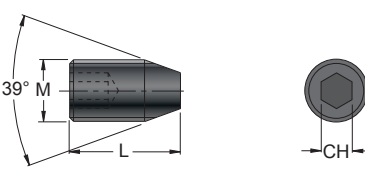
**GRANI - DOWELS
MADENSCHRAUBEN - GRAINS**

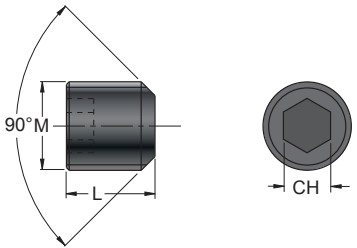
	ART.	(mm)					
		M	M1	L	CH	Torx	
	1503	M3x0,5	-	4	1,5	-	
	1504	M4x0,7	-	4	2	-	
	1505	M5x0,8	-	5	2,5	-	
	4196	M6x1	-	10	3	-	
	901.004.012.000	M4x0,7	-	12	2	-	
	901.006.016.010	M6x1	-	16	3	-	
	901.006.020.010	M6x1	-	20	3	-	
	901.006.025.010	M6x1	-	25	3	-	
	901.006.030.010	M6x1	-	30	3	-	
	901.006.040.010	M6x1	-	40	3	-	
	901.008.040.012	M8x1,25	-	40	4	-	
	GR 05	M5x0,8	-	10	2,5	-	
	GR 06	M6x1	-	10	3	-	
	GR 08	M8x1,25	-	10	4	-	
	GR 10	M10x1,5	-	12	5	-	
	GR 1010F	M10x1	-	10	5	-	
	GR 12	M12x1,75	-	16	6	-	
	GR 1208	M12x1,75	-	8	6	-	
	GR 1212	M12x1,75	-	12	6	-	
	GR 1215	M12x1,5	-	16	6	-	
	GR 14	M14x2	-	16	6	-	
	GR 1414	M14x2	-	14	6	-	
	GR 1415	M14x1,5	-	16	6	-	
	GR 16	M16x2	-	16	8	-	
	GR 1610	M16x1	-	10	8	-	
	GR 1612	M16x2	-	12	8	-	
	GR 1615	M16x1,5	-	16	8	-	
	GR 18	M18x2	-	20	10	-	
	GR 1814	M18x2	-	14	10	-	
	GR 1815	M18x1,5	-	20	10	-	
	GR 1818	M18x2	-	18	10	-	
	GR 20	M20x2	-	20	10	-	
	GR 2015	M20x1,5	-	20	10	-	
	GR 2016	M20x2	-	16	10	-	
	GR 2420	M24x2	-	20	17	-	
	GR 810F	M8x1	-	10	4	-	
	218-1814	1/8G	-	7	5	-	

**GRANI - DOWELS
MADENSCHRAUBEN - GRAINS**

	ART.	(mm)					
		M	M1	L	CH	T	
	GR 304C	M3x0,5	-	4	1,5	-	
	GR 404C	M4x0,7	-	4	2	-	
	GR 408C	M4x0,7	-	8	2	-	
	GR 410C	M4x0,7	-	10	2	-	
	GR 505	M5x0,8	-	5	2,5	-	
	GR 505C	M5x0,8	-	5	2,5	-	
	GR 505FP	M5x0,5	-	5	-	9	
	GR 508C	M5x0,8	-	8	2,5	-	
	GR 510C	M5x0,8	-	10	2,5	-	
	GR 606	M6x1	-	6	3	-	
	GR 608	M6x1	-	8	3	-	
	GR 610	M6x1	-	10	3	-	
	GR 612	M6x1	-	12	3	-	
	GR 614	M6x1	-	14	3	-	
	GR 618.05	M6x0,5	-	18	3,5	-	
	GR 806	M8x1,25	-	6	4	-	
	GR 808	M8x1,25	-	8	4	-	
	GR 810	M8x1,25	-	10	4	-	
	GR 812	M8x1,25	-	12	4	-	
	GR 814	M8x1,25	-	14	4	-	
GR 816	M8x1,25	-	16	5	-		
GR 1008	M10x1,5	-	8	5	-		
	GR10Q26	M10x1,5	-	15,0	5	-	
	GR12Q34	M12x1,75	-	19,8	6	-	
	GR16Q42	M16x2	-	24,9	8	-	
	GRB3	M3x0,5	-	16	1,5	-	
	GRB4	M4x0,7	-	25	2	-	
	GRB4C	M4x0,7	-	20	2	-	
	GRB4L	M4x0,7	-	35	2	-	
	GRB5	M5x0,8	-	40	2,5	-	
	GRB6	M6x1	-	60	3	-	
	GRB6C	M6x1	-	50	3	-	
GRB6L	M6x1	-	70	3	-		
	GRF10	M10x1,5	-	14	3	-	
	GRF18	M18x1,5	-	20	5	-	
	GRF22	M22x1,5	-	20	5	-	
	GRT14	M5x0,8	-	8	2,5	-	
	GRT18	M6x1	-	10	3	-	
	GRT22	M8x1,25	-	13,5	4	-	
	GRT27	M8x1,25	-	15	4	-	
	GRT32	M10x1,5	-	18	5	-	
	GRT40	M12x1,75	-	20	6	-	
	GRT63	M16x2	-	25	8	-	
GRT80	M20x2,5	-	35	10	-		

**GRANI - DOWELS
MADENSCHRAUBEN - GRAINS**

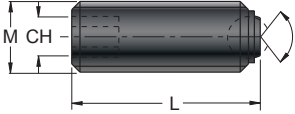
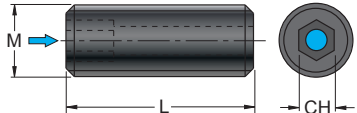
	ART.	(mm)				
		M	M1	L	CH	
	GWH10	M10x1,5	-	12	5	
	GWR05 GWR06 GWR08 GWR10 GWR12 GWR14 GWR16 GWR20	M5x0,8 M6x1 M8x1,25 M10x1,5 M12x1,75 M14x2 M16x2 M20x2,5	- - - - - - - -	12 14 16 20 20 14 20 24	2,5 3 4 5 6 6 8 10	

**PRIGIONIERI - STUD BOLTS
STIFTBOLZEN - PRISIONNERS**

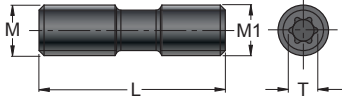
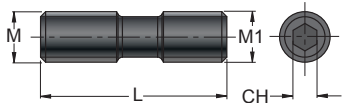
	ART.	(mm)					Nm
		M	M1	L	Torx		
	STCM04 STCM20 STCM25	M8x1sx M6x1sx M6x1sx	M8x1 M6x1 M6x1	30 30 25	25 15 15	7,0+8,0 5,0+6,0 5,0+6,0	
	VDST 206	M6x1sx	M6x1	17	20	5,5+7,0	
	VDST 2008	M8x0,75	M8x1,25	30	CH 4	8,0+10,0	

**BOCCOLE - BUSHES
BUCHSEN - DOUILLES**

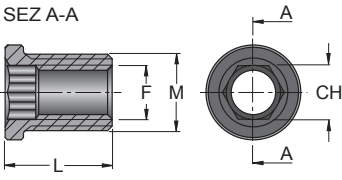
	ART.	(mm)					
		M	L	F	H	CH	
	BCL 7	M5x0,5	7	M3,5x0,6	—	3,5	
	BCL 15	M6x0,75	9	M4,5x0,75	—	4,5	

**CHIAVETTA DI TRASCINAMENTO - DRIVING KEYS
MITNAHMEKEILE - CLAVETTES D'ENTRAÎNEMENT**

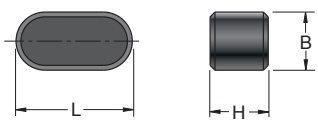
	ART.	(mm)					
		L	B	H			
	CT 0410	9,8	4	4			
	CT 0420	19,8	4	4			
	CT 0612	11,8	6	6			
	CT 0625	24,6	6	6			
	CT 0715	16,1	7	7			
	CT 0725	24,8	7	7			
	CT 0820	17,9	8	7			
	CT 0828	27,8	8	7			
	CT 1020	19,8	10	8			
	CT 1032	31,8	10	8			
	CT 1236	35,5	12	8			



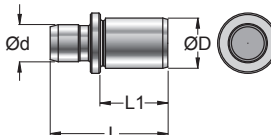
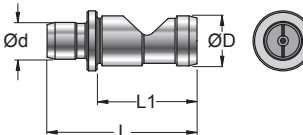
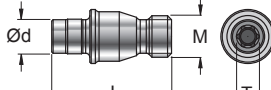
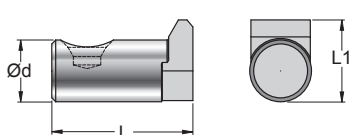
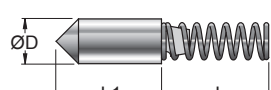



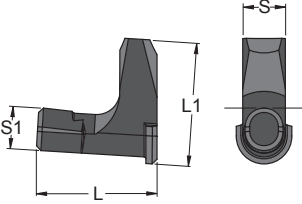



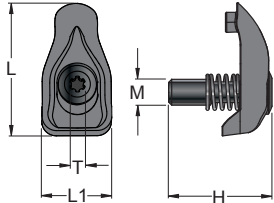

**PERNI - PINS
STIFTE - TOURILLONS**

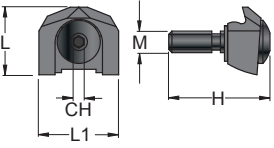
	ART.	(mm)					
		ØD/M	Ød	L	L1	T	
	4184	4	3,69	10,0	5,9	-	
	4185	6	5,0	11,5	6,5	-	
	4187	5	3,69	9,9	4,9	-	
	4188	5	3,69	11,7	6,7	-	
	4190	6	5,0	14,3	9,3	-	
	4186	5	3,69	15,0	10,0	-	
	4192	6	5,0	18,5	13,5	-	
	KLM 34L	M5x0,8	3,65	13,1	-	T8	
	KLM 44	M6x1	5,0	13,3	-	T15	
	KLM 46	M6x1	5,0	17,3	-	T15	
	KLM 46L	M6x1	5,0	18,7	-	T15	
	KLM 46S	M6x1	5,0	16,6	-	T15	
	KLM 58	M8x1	6,25	22,0	-	T15	
	KLM 68	M10x1	7,8	22,0	-	T25	
	477.020	-	5,75	22,0	8,3	-	
	477.025	-	7,75	23,0	11,3	-	
	477.032	-	9,75	26,0	13,4	-	
	477.040	-	11,75	32,0	16,9	-	
	477.050	-	15,75	36,0	20,9	-	
	477.063	-	19,75	47,0	26,6	-	
	477.080	-	24,75	56,5	30,1	-	
	4204	4,8	-	12	10,5	-	

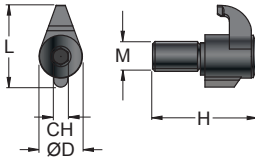

**LEVE - LEVERS
HEBEL - LEVIERS**

	ART.	(mm)				
		L	L1	S	S1	
	8008	6,3	7,8	2,2	2,6	
	8009	12,1	9,7	3,5	3,6	
	8010	7,7	9,5	3,6	3,2	
	8012	13,1	12,7	4,7	4,6	
	8016	17,1	15,5	6,0	6,0	
	8019	19,6	21,1	7,5	7,5	
	8212	12,6	10,6	4,8	4,7	
	8216	9,5	10,0	3,7	3,2	
	8410	10,0	11,6	3,5	3,8	
	8411	11,5	11,6	3,5	3,8	
8415	14,7	15,3	4,7	4,7		

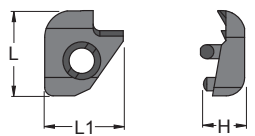
**STAFFE - BRACKETS
PRATZEN - BRIDES**

	ART.	(mm)								
		M	L	ØD/L1	H	CH/T				
	100-11	M4x0,7	21,8	11,0	17	IP9				
	100-21	M5x0,8	25,8	14,5	20	T15	100-11.1	100-11.2	100-11.3	
	100-31	M6x1	31,2	17,7	25	T20	100-21.1	100-21.2	100-21.3	
	100-41	M6x1	35,1	19,0	25	T20	100-31.1	100-31.2	100-31.3	
							100-41.1	100-31.2	100-31.3	
	100-50	M5x0,8	15,6	18,5	23,5	2,5				
	100-51	M6x1	16,5	24	25,5	3	100-50.1	100-84	RP051010	EMI H5
	100-52	M5x0,8	15,6	18,5	23,5	2,5	100-51.1	100-85	RP061205	EMI H6
	100-53	M5x0,8	12,7	16,2	18,5	T10	100-52.1	100-84	RP051010	EMI H5
							100-56.1	100-82	-	EMI H5
	2304	M4x0,7	13,3	8	14	2,5				
	2304C	M4x0,7	13,3	8	14	2,5	-	-	-	
	2305	M5x0,8	16,5	10	19	3	-	-	-	
	2305C	M5x0,8	16,5	10	19	3	-	-	-	
	2316	-	25,4	23,5	12,3	-				
	2326	-	25,4	23,5	12,3	-				

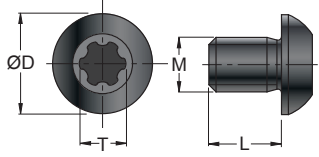
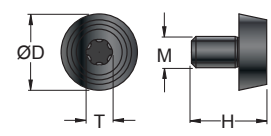
**STAFFE - BRACKETS
PRATZEN - BRIDES**

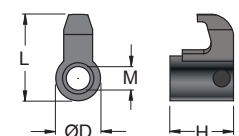
	ART.	(mm)					Torx		
		M	L	ØD/L1	H				
	2435P	M3,5x0,6	7,2	8	-	15IP			
	2440 2445	M4x0,7 M4,5x0,75	- -	9 11	8,2 10,8	15 20IP	 2403 2404	 C04008 124510P	
	CKM 12 CKM 21 CKM 22	M8x1sx M6x1sx M6x1sx	22,2 18,25 21,25	10,8 9,45 9,45	17,5 13,4 13,4	- - -			

**CUNEI - WEDGES
KEILE - COINS**

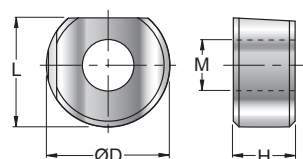
	ART.	(mm)						
		M	L	ØD	H	H1		
	460.063.010.006	M6x1sx	10,5	12	6	-		

**SEDI IN ACCIAIO - STEEL SEATS
STAHLITZE - SIÈGES EN ACIER**

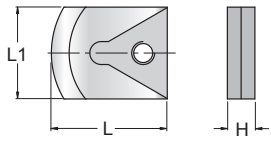
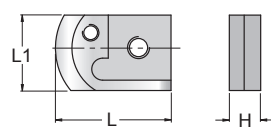
	ART.	(mm)					
		d	d1	L	L1	H	
	S11 S16	-	-	12,7	10	2,8	
		-	-	19,5	15,9	4,8	
	S12.4	-	-	20,9	13,7	5,7	

**SEDI IN METALLO DURO - SOLID CARBIDE SEATS
HARTMETALLSITZE - SIÈGES EN CARBURE**

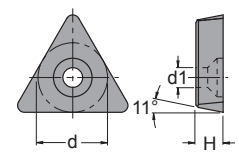
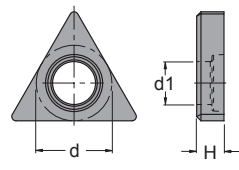
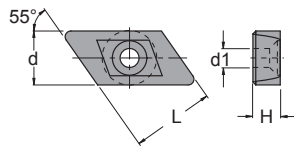
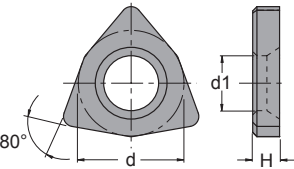
	ART.	(mm)					
		d	d1	L	α	H	
	3116	8,1	2,3	-	11°	3,18	
	3216	8,8	5,0	-	-	3,18	
	3222	11,9	6,0	-	-	4,76	
	3415	8,75	5,5	-	-	2,38	
	3416	9,0	5,0	-	-	2,85	
	3418	8,4	5,4	-	-	2,70	
	3422	11,85	6,5	-	-	3,18	
	3226 3236	9,4 9,4	3,3 3,3	14,5 14,5	- -	4,76 4,76	
	3306 3308M	8,9 12,5	4,8 6,5	- -	- -	2,9 3,18	

**SEDI IN METALLO DURO - SOLID CARBIDE SEATS
HARTMETALLSITZE - SIÈGES EN CARBURE**

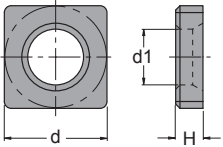
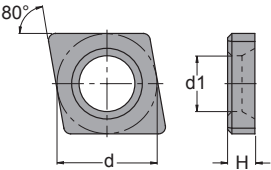
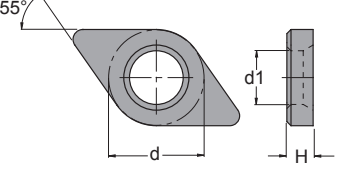
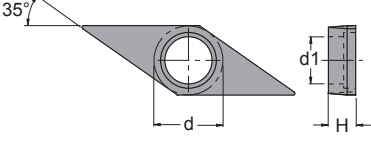
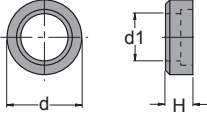
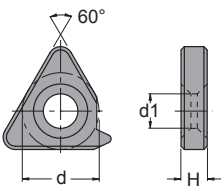
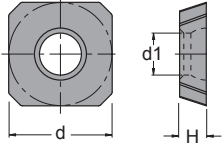
	ART.	(mm)					
		d	d1	L	α	H	
	3509 3511 3512 3514 3515 3519 KSN433 KSN633	8,5 11,4 11,96 11,6 14,7 17,8 12,5 18,8	5,5 6,5 6,5 6,9 8,0 9,7 7,3 11,2	- - - - - - - -	- - - - - - - -	2,38 3,18 3,18 3,1 4,76 4,76 4,76 4,76	
	3608 3609 3610 3611 3612 3616 3619 KCN433 KCN533 KCN633	8,5 8,4 8,5 11,4 11,7 14,5 18,0 12,5 15,6 18,8	4,8 5,5 4,8 6,5 6,5 8,0 9,7 7,3 9,7 11,2	- - - - - - - - - -	- - - - - - - - - -	3,97 2,38 3,18 3,18 3,18 4,76 4,76 4,76 4,84 4,76	
	3710 3711 3715 KDN433	8,5 8,4 11,65 12,45	4,8 5,5 6,5 7,4	- - - -	- - - -	3,18 2,38 3,18 4,82	
	3716 KVN323	8,1 9,3	5,5 5,8	- -	- -	3,18 3,2	
	3810	8,7	5,5	-	-	3,18	
	U16ER U16IR U22ER U22IR	9,52 9,52 12,7 12,7	4 4 5,3 5,3	- - - -	- - - -	3,18 3,18 3,97 3,97	
	PA13M	10,65	5,3	-	9°	3,0	

**ROMPITRUCIOLI - CHIP-BREAKERS
SPANBRECHER - BRISE-COUPEAUX**

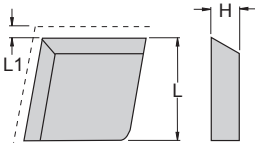
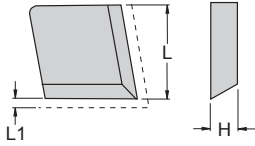
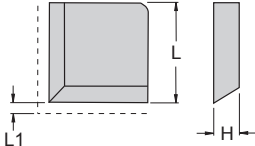
	ART.	(mm)					
		d	d1	L	L1	H	
	RCK1225	-	-	10,7	2,3	2,5	
	RCN1225	-	-	10,7	2,3	2,5	
	RSN1225	-	-	10,7	2,3	2,5	

**ANELLI DI TRASCINAMENTO - DRIVING RINGS
MITNAHMERINGE - BAGUES D'ENTRAÎNEMENT**

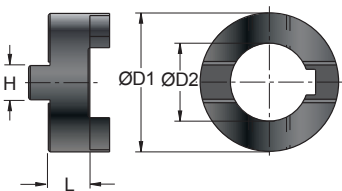
	ART.	(mm)					
		ØD1	ØD2	H	L		
	08.3501.016.AT	32,0	16,5	7,9	10		
	08.3502.022.AT	40,0	22,5	9,9	12		
	08.3503.027.AT	48,0	27,5	11,9	12		
	08.3504.032.AT	57,5	32,5	13,9	14		
	08.3505.040.AT	69,5	40,5	15,9	14		
	08.3506.050.AT	90,0	50,5	17,9	16		

**RONDELLE - WASHERS
UNTERLEGSCHIEBEN - RONDELLES**

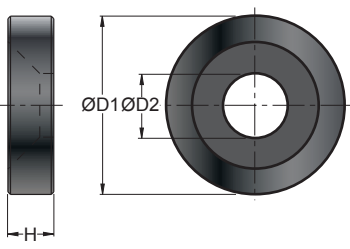
	ART.	(mm)					
		ØD1	ØD2	H	L		
	RS 16	22	8,5	7	-		
	RS 22	29	10,5	8	-		
	RS 27	36	12,5	9	-		
	RS 32	43	16,5	10	-		
	RS 40	52	20,5	11	-		
	RS 50	64	24,5	13	-		
	RS 60	75	24,5	14	-		
	RSPU 04	7,2	4,5	4	-		

**SPessori - SHIMS
UNTERLAGEN - ÉPAISSEUR**

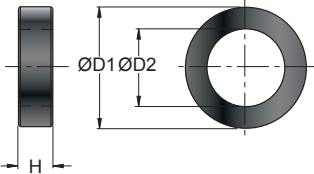
	ART.	(mm)				
		ØD1	ØD2	H	L	
	RP 101616	20	11,0	2,0	-	

**TASSELLI - SMALL BLOCKS
DÜBEL - CHEVILLE**

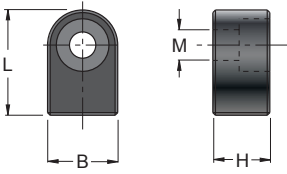
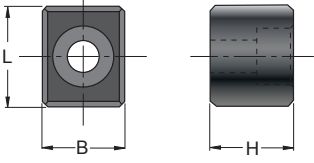
	ART.	(mm)					
		ØD	L	B	H	M	
	426.063.010.008	-	18,5	10,0	8	4	
	426.080.012.008	-	21,0	12,0	8	5	
	CHF 16	-	14,5	8,0	7	3	
	CHF 22	-	18,5	10,0	10	4	
	CHF 27	-	21,0	12,0	12	5	
	CHF 32	-	23,5	14,0	14	6	
	CHF 40 L	-	23,5	16,0	16	6	
	CHF 16V	-	16,8	8,0	6,8	3	
	CHF 22V	-	20,6	10,0	8,0	4	
	CHF 27V	-	24,4	12,0	9,0	5	
	CHF 32V	-	27,8	14,0	11,7	5	
	CHT 14	-	12,2	6,0	3,5	3	
	CHT 18	-	12,2	6,0	4,0	3	
	CHT 22	-	12,2	8,0	4,5	3	
CHT 27	-	12,2	8,0	6,5	3		
	TSFS16	-	11	8	10,5	-	
	TSFS22	-	13	10	11,5	-	
	TSFS27	-	15	12	12,5	-	
	TSFS32	-	17	14	14	-	
	TSFS40	-	19,5	16	16	-	
	TSFF40	-	19,5	15,9	16	-	
	TSFF60	-	26,6	25,4	25	-	

**ADATTATORE - ADAPTERS
ADAPTER - ADAPTATEURS**

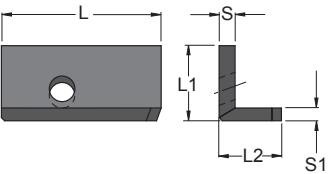
	ART.	(mm)					
		L	L1	L2	S	S1	
	RD 12	50	23,5	19,5	5	4	ADATTATORE DA CARTUCCE 16CA... A CARTUCCE 12CA... ADAPTER CARTRIDGE 16CA... TO 12CA...

**BLOCCHETTI - BLOCKS
BLÖCKE - CALES**

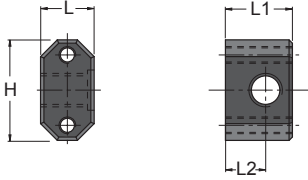
	ART.	(mm)				
		L	L1	L2	H	
	BRA.BLO.10	16	20	12	30	

**PUNZONI - PUNCHES
STEMPEL - POINÇONS**

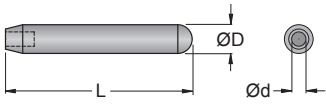
	ART.	(mm)			
		ØD	Ød	L	
	0009 0012 0015 0019	8 10 12 14	4 5 7 8	60 65 70 70	

**GUARNIZIONI OR - OR SEALS
OR-DICHTUNGEN - GARNITURES**

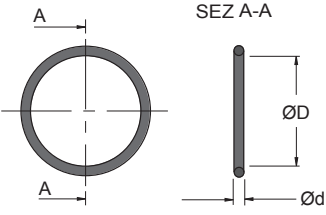
	ART.	(mm)				
		ØD	Ød			
	OR-0035-150	3,5	1,5			
	OR-0040-150	4,0	1,5			
	OR-0045-150	4,5	1,5			
	OR-0050-150	5,0	1,5			
	OR-0055-150	5,5	1,5			
	OR-0060-150	6,0	1,5			
	OR-0065-150	6,5	1,5			
	OR-0070-150	7,0	1,5			
	OR-0075-150	7,5	1,5			
	OR-0080-150	8,0	1,5			
	OR-0085-150	8,5	1,5			
	OR-0090-150	9,0	1,5			
	OR-0095-150	9,5	1,5			
	OR-0100-150	10,0	1,5			
	OR-0105-150	10,5	1,5			
	OR-0110-150	11,0	1,5			
	OR-0115-150	11,5	1,5			
	OR-0120-150	12,0	1,5			
	OR-0125-150	12,5	1,5			
	OR-0130-150	13,0	1,5			
	OR-0135-150	13,5	1,5			
	OR-0140-150	14,0	1,5			
	OR-0145-150	14,5	1,5			
	OR-0150-150	15,0	1,5			
	OR-0155-150	15,5	1,5			
	OR-0160-150	16,0	1,5			
	OR-0165-150	16,5	1,5			
	OR-0170-150	17,0	1,5			
	OR-0175-150	17,5	1,5			
	OR-0180-150	18,0	1,5			
OR-0185-150	18,5	1,5				
OR-0190-150	19,0	1,5				
OR-0195-150	19,5	1,5				
OR-0267-178	26,7	1,78				
OR-0280-2	28,0	2,0				
OR-HK063	11,0	2,0				
OR-HK100	15,0	2,5				
ORM-210-20	21,0	2,0				

**MOLLE - SPRINGS
FEDERN - RESSORTS**

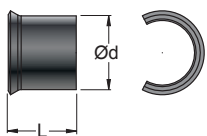
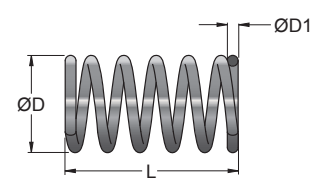
	ART.	(mm)					
		ØD	Ød	ØD1	L	L1	
	4108	-	5	-	4,5	-	
	4109	-	5	-	5,2	-	
	4112	-	6,5	-	6	-	
	4115	-	8	-	9,3	-	
	4119	-	9,5	-	11,2	-	
	4295	9,5	-	1,0	13	-	
	UM010005	2,5	-	0,4	0,4	-	
	UM020005	3,2	-	0,5	0,5	-	
	UM030005	3,5	-	0,7	0,7	-	
	UM040005	4,6	-	0,7	0,7	-	

**RACCORDI/UGELLI - JOINTS/NOZZLES
VERBINDUNGEN/DÜSEN - RACCORDS/TUYÈRES**

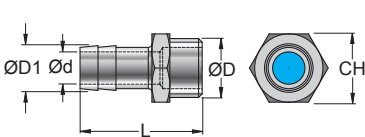
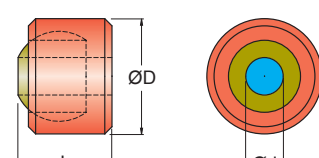
	ART.	(mm)					
		ØD	Ød	ØD1	L	CH	
	260Z3/8-12	3/8"	9	12	34	19	
	RUR 008	8	3	-	7	-	



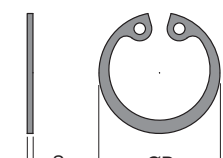

**ANELLI SEEGER - SEEGER RINGS
SEEGER-RINGE - BAGUES SEEGER**

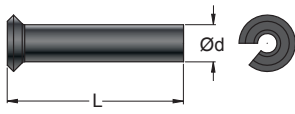
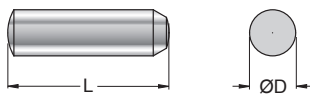
	ART.	(mm)					
		ØD	S				
	EMI H5 EMI H6	6,2 7,4	0,6 0,7				
	SG 161	17,5	1				

**SPINE - PINS
STECKSTIFTE - CHEVILLES**

	ART.	(mm)				
		ØD	Ød	L		
	4002	-	2	10		
	4012	-	3	10		
	2063	2	-	6		
	3098	3	-	10		
	4158	4	-	16		
	903.002.008.000	2	-	8		
	903.004.014.000	4	-	14		
	903.005.018.000	5	-	18		
	903.006.016.000	6	-	16		
	903.006.020.000	6	-	20		
903.008.022.000	8	-	24			

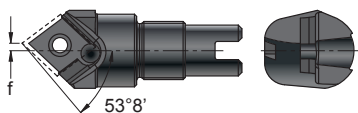
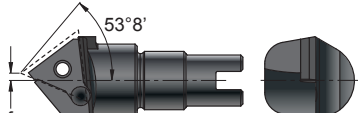
**PORTA INSERO PER UNITÀ MICROREGISTRABILE - INSERT HOLDER FOR MICRO-BORING UNIT
WENDEPLATTENHALTER FÜR FEINBOHREINHEIT - PORTE-PLAQUETTE POUR UNITÉ MICRORÉGLABLE**

	ART.	(mm)				
		α	f			
	UM050003R/L	53°8'	0,36	0602	-	
	UM060003R/L	53°8'	1,07	0602	-	
	UM070003R/L	53°8'	1,30	09T3	-	
	UM080006R/L	53°8'	1,56	09T3	-	
	UM060007R/L	53°8'	1,07	-	0902	
	UM070007R/L	53°8'	1,30	-	1102	
	UM080007R/L	53°8'	1,56	-	16T3	
	UM010003	90°	5,1	0602	-	
	UM020003	90°	6,3	0602	-	
	UM030003	90°	7,2	09T3	-	
	UM040006	90°	10,0	09T3	-	
	UM020007	90°	6,3	-	0902	
	UM030007	90°	7,2	-	1102	
	UM040007	90°	10,0	-	16T3	

COMPONENTI SMUSSATORI - COMPONENTS CHAMFERING TOOLS
ABSCHRÄGBAUTEILE - COMPOSANTES DISPOSITIF DE BISEAUTAGE

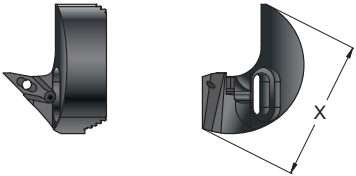
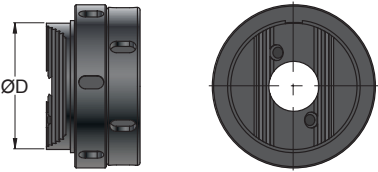
	ART.	(mm)					
		ØD	X				
	<p>LMA.CIL.0618.10W LMA.ER.0618.10</p>	<p>– –</p>	<p>35,5 42,5</p>				
	<p>SMU-ER25-00 SMU-ER32-00 SMU-ER40-00</p>	<p>40 48 57,5</p>	<p>– – –</p>				

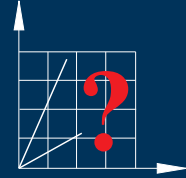

TORNITURA - TAGLIO - SCANALATURA
TURNING - PARTING - GROOVING
BEARBEITUNG - NUTENDREH - ABSTECH
TOURNAGE - TRONÇONNER - RAINURER

Pag. 1126

FRESATURA
MILLING
FRÄSEN
FRAISAGE

Pag. 1133

FORATURA - LAVORAZIONE FORI
DRILLING - MACHINING OF BORES
BOHREN - BEARBEITUNG VON BOHRUNGEN
PERÇAGE - USINAGE DES TROUS

Pag. 1156

FILETTATURA
THREADING
GEWINDEDREHEN
FILETAGE

Pag. 1172

BARENATURA
BORING
AUSBOHREN
ALÉSAGE

Pag. 1179

MANDRINI
TAPER SHANKS
AUFNAHMEN
MANDRINS

Pag. 1180

EQUILIBRATURA
BALANCING SYSTEM
AUSWUCHTSYSTEM
EQUILIBRAGE

Pag. 1189

INFORMAZIONI PER IL FISSAGGIO A VITE CENTRALE
INFORMATION FOR FASTENING WITH A CENTRAL SCREW
ANWEISUNGEN ZUR SPANNUNG MIT ZENTRALSCHRAUBE
INFORMATION POUR LE FIXAGE À VIS CENTRAL

Pag. 1193

NORMATIVE ATTACCHI PER PUNTE E FRESE
DRILL AND MILLING CUTTERS STANDARDS
NORMEN FÜR BOHRER UND FRÄSERAUFNAHMEN
NORMES POUR ATTACHEMENT POUR FRAISE ET FORET

Pag. 1194

TOLLERANZE
TOLERANCES
TOLERANZEN
TOLÉRANCES

Pag. 1198

TABELLA COMPARATIVA DEI MATERIALI
MATERIALS COMPARISON TABLE
MATERIAL VERGLEICHSTABELLE
TABLEAU COMPARATIF DES MATERIAUX

Pag. 1199

TABELLA CONVERSIONE DUREZZE
HARDNESS CONVERSION TABLE
HÄRTEUMRECHNUNGSTABELLE
TABLEAU DE CONVERSION DURETÉS

Pag. 1207

**SIGLE E FORMULE GENERALI
GENERAL ACRONYMS AND FORMULAS**

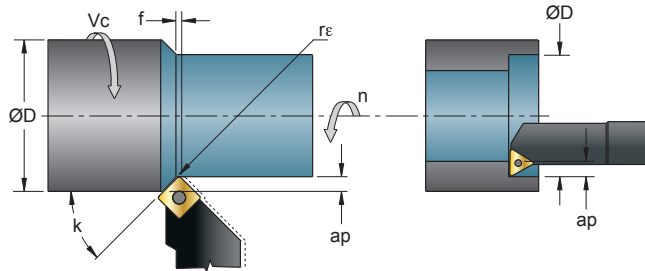

- ap** (mm) = PROFONDITÀ DI TAGLIO
- d** (mm) = DIAMETRO DEL PEZZO
- fn** (mm) = AVANZAMENTO AL GIRO
- h** (mm) = SPESSORE DEL TRUCIOLO
- k** (°) = ANGOLO DI ATTACCO
- Kc** (N/mm²) = FORZA DI TAGLIO SPECIFICA
- Kc1.1** (N/mm²) = FORZA DI STRAPPAMENTO SPECIFICA DEL MATERIALE LAVORATO (VEDI TABELLE MATERIALI PAG 1200/1206)
- mc** = ESPONENTE DI INCREMENTO DELLA FORZA DI TAGLIO (VEDI TABELLE MATERIALI PAG 1200/1206)
- n** (giri/min - min⁻¹) = NUMERO DI GIRI AL MINUTO
- Pc** (KW) = POTENZA ASSORBITA
- Q** (cm³/min) = VOLUME DEL TRUCIOLO ASPORTATO
- r_ε** (mm) = RAGGIO DI PUNTA DELL' INSERTO
- Vc** (m/min) = VELOCITÀ DI TAGLIO
- η** (0,7-0,85) = RENDIMENTO MECCANICO DELLA MACCHINA



- = CUTTING DEPTH
- = WORKPIECE DIAMETER
- = FEED / REV.
- = CHIP THICKNESS
- = CUTTING ANGLE
- = SPECIFIC CUTTING FORCE
- = SPECIFIC TEARING FORCE OF MACHINED MATERIAL (SEE MATERIALS TABLES PAGE 1200/1206)
- = CUTTING FORCE INCREMENT (SEE MATERIALS TABLES PAGE 1200/1206)
- = NUMBER OF REVOLUTIONS / MIN'
- = ABSORBED POWER
- = VOLUME OF CHIP REMOVED
- = INSERT CORNER RADIUS
- = CUTTING SPEED
- = MECHANICAL EFFICIENCY OF THE MACHINE

$$Vc \text{ (m/min)} = \frac{D \cdot 3,14 \cdot n}{1000}$$

$$n \text{ (giri/min - min}^{-1}\text{)} = \frac{Vc \cdot 1000}{D \cdot 3,14}$$

$$h \text{ (mm)} = fn \cdot \sin k$$

$$Kc \text{ (N/mm}^2\text{)} \approx \frac{Kc1.1}{hmc}$$

- APPROSSIMATA: NON TIENE CONTO DELL'ANGOLO DI TAGLIO
- APPROXIMATE VALUE: CUTTING ANGLE NOT TAKEN INTO CONSIDERATION

$$Pc \text{ (KW)} = \frac{Vc \cdot fn \cdot ap \cdot Kc}{60.000 \cdot \eta}$$

$$Q \text{ (cm}^3\text{/min)} = Vc \cdot fn \cdot ap$$

**LUNGHEZZA EFFETTIVA DEL TAGLIANTE - DIMENSIONE INSERTO CONSIGLIATA
TRUE CUTTING EDGE LENGTH - RECOMMENDED INSERT SIZE**

I valori riportati sono consigliati per un uso continuo in sgrossatura, per operazioni più brevi sono possibili profondità di passata superiori.

Listed values are recommended for continuous use during roughing; greater cutting depth is possible for shorter operations.

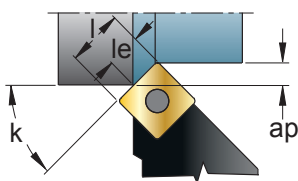

le = 0,4 · d	le = 2/3 · l	le = 2/3 · l	le = 1/2 · l	le = 1/2 · l	le = 1/2 · l	le = 1/4 · l	le = 1/4 · l

RUGOSITÀ - FINITURA SUPERFICIALE
ROUGHNESS – SURFACE FINISH

- La rugosità massima teorica **Rmax** é determinata dalla combinazione del raggio di punta dell'inserto r_ϵ e dall'avanzamento al giro **fn**.
 - Le formule e gli schemi riportati in questa pagina, sono in forma approssimata nei quali si pone: **Rmax ≈ Rt, Ry, Rz**.
 - Non esiste una relazione matematica per la conversione dei vari sistemi di misurazione della rugosità, per cui i valori riportati nella tabella sono da ritenersi orientativi.
- The Maximum theoretical roughness **Rmax** is determined by a combination of the insert corner radius r_ϵ and the feed for revolution **fn**.
 - The formulas and tables are listed on this page in an approximate form, with: **Rmax ≈ Rt, Ry, Rz**.
 - No mathematical relationship exists for conversion between the various systems for measuring roughness; therefore, the values listed in the table are to be considered merely indicative.

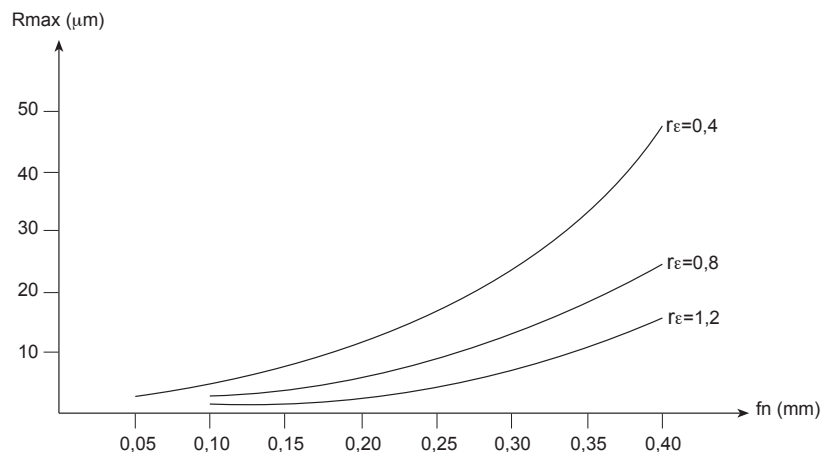
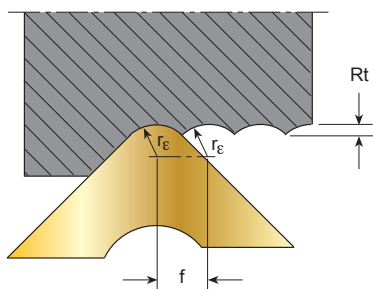

$$R_{max} (\mu m) \approx \frac{f_n^2 \cdot 125}{r_\epsilon}$$

- TEORICA, APPROSSIMATA
- APPROXIMATE THEORETICAL FORMULA

$$f_n (mm) \approx \sqrt{\frac{R_{max} \cdot r_\epsilon}{125}}$$

RUGOSITÀ - FINITURA SUPERFICIALE ROUGHNESS – SURFACE FINISHING					RAGGIO DI PUNTA - CORNER RADIUS r_ϵ (mm)					
					0,2	0,4	0,8	1,2	1,6	2,4
	Ra μm	Rt, Ry,Rz μm	CL	R (FR)	AVANZAMENTO AL GIRO - FEED PER REVOLUTION f_n (mm)					
▽	50	180 - 220	N12	-	/	/	/	/	/	1,94
▽	25	90 - 110	N11	-	/	/	/	0,97	1,12	1,38
▽	12,5	46 - 57	N10	R100	/	/	0,57	0,7	0,81	0,99
▽▽	6,3	23 - 32	N9	R40	/	0,29	0,42	0,51	0,59	0,72
▽▽	3,2	12 - 16	N8	R25/R16	0,15	0,21	0,3	0,37	0,42	0,52
▽▽	1,6	5,9 - 8	N7	R10	0,1	0,15	0,21	0,26	0,3	0,36
▽▽▽	0,8	3 - 4,8	N6	R6,3	0,08	0,11	0,16	0,19	0,22	0,27
▽▽▽	0,4	1,6 - 2,8	N5	R3,2/R2	0,06	0,08	0,12	0,15	0,17	0,21
▽▽▽	0,2	1 - 1,8	N4	R1,25	0,05	0,07	0,09	0,12	0,13	0,16

AVANZAMENTI MASSIMI CONSIGLIATI SECONDO IL RAGGIO E LA FORMA INSERTO (CON ANGOLO $k = 75^\circ - 105^\circ$)
MAXIMUM RECOMMENDED FEED ACCORDING TO THE RADIUS AND THE INSERT SHAPE (WITH ANGLE $k = 75^\circ - 105^\circ$)

FORMA INSERTO INSERT SHAPE	RAGGIO INSERTO r_ϵ - INSERT RADIUS					
	0,2	0,4	0,8	1,2	1,6	2,4
	AVANZAMENTO AL GIRO MASSIMO - MAXIMUM FEED PER REVOLUTION f_n (mm)					
	0,13	0,25	0,5	0,8	1,0	1,6
	0,08	0,16	0,32	0,5	0,63	1,0

**TIPOLOGIE DI USURA DEL TAGLIENTE
TYPES OF TOOL WEAR**

CRATERIZZAZIONE - CRATER WEAR

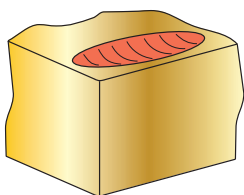

- Diminuire la velocità di taglio.
- Ridurre l'avanzamento.
- Scegliere una qualità più resistente all'usura.
- Controllare se il refrigerante è usato correttamente.
- Reduce cutting speed
- Reduce feed
- Change to a more wear-resistant grade
- Supply cutting fluid in adequate volume

USURA SUL FIANCO - FLANK WEAR

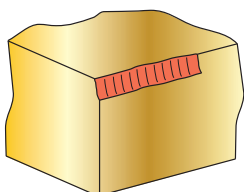

- Aumentare l'avanzamento.
- Scegliere una qualità più resistente all'usura.
- Ridurre la velocità di taglio.
- Increase feed
- Change to a more wear-resistant grade
- Reduce cutting speed

SCHEGGIATURA - CHIPPING

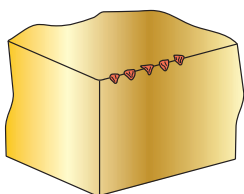

- Usare una qualità più tenace.
- Aumentare la stabilità della lavorazione.
- Velocità di taglio troppo bassa.
- Avanzamento troppo elevato.
- Change to a tougher grade
- Increase machining stability
- Cutting speed is too high
- Feed rate is too high

DEFORMAZIONE PLASTICA - PLASTIC DEFORMATION

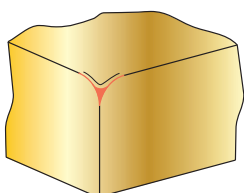

- Usare il refrigerante correttamente.
- Diminuire la velocità di taglio.
- Scegliere una qualità più resistente all'usura.
- Ridurre l'avanzamento.
- Supply cutting fluid in adequate volume
- Reduce the cutting speeds
- Change to a more wear-resistant grade
- Reduce feed rate

FORMAZIONE DEL TAGLIENTE DI RIPORTO - CHIP WELDING

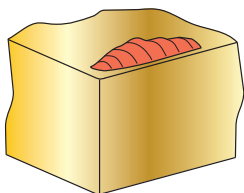

- Aumentare la velocità di taglio.
- Utilizzare un rivestimento adeguato.
- Scegliere un inserto con maggior angolo di spoglia superiore.
- Increase cutting speed
- Tool grade with low affinity (coated grade - cermet grade).
- Select an insert with a greater face rake angle

ROTTURA DEL TAGLIANTE - FRACTURE OF THE CUTTING EDGE

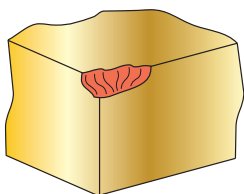

- Scegliere una qualità più tenace.
- Diminuire l'avanzamento.
- Scegliere un inserto con tagliente rinforzato.
- Change to a tougher grade
- Reduce feed rate
- Select an insert with reinforced cutting edge

INDICAZIONI E CONSIGLI PER IL TAGLIO
CUTTING INSTRUCTIONS AND SUGGESTIONS

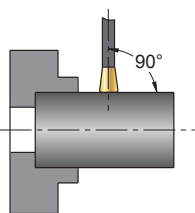

Controllare che la lama sia posizionata a 90° rispetto al pezzo, il filo tagliente deve essere parallelo al pezzo.

Make sure that the blade is placed at a 90° angle to the workpiece; the cutting edge must be parallel to the workpiece.

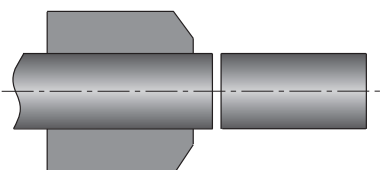

Occorre un bloccaggio sicuro del pezzo, eseguire il taglio in prossimità della presa.

Make sure that the workpiece is securely held in place; begin cutting near where it is being held.

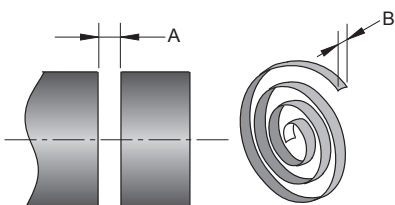

Forma del truciolo a spirale, controllare che la larghezza del truciolo sia inferiore alla larghezza del taglio $B < A$.

The chip will have a spiral shape; make sure that the width of the chip is less than the width of cut $B < A$

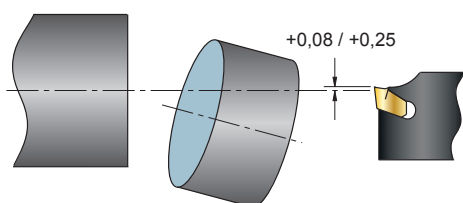

Nel taglio fino al centro di un corpo pieno il tagliente deve essere posizionato sopra centro da +0,08 a 0,25 mm.

When cutting to the center of a solid body, the cutting edge must be placed +0,08 to 0,25 mm above the center

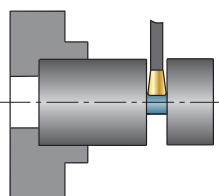

Nel taglio fino al centro di un corpo pieno ridurre l' avanzamento negli ultimi 5 mm fino al 50%.

When cutting to the center of a solid body, reduce the feed by 50% during the last 5 mm.

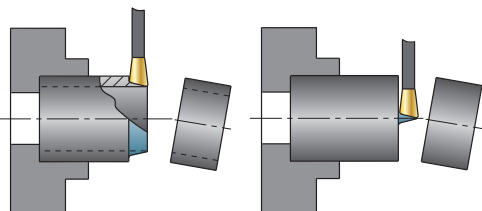

Nel taglio dei tubi e per tagli senza peduncolo, usare un inserto con tagliente inclinato. Ridurre l'avanzamento dal 20% al 50%

Use an insert with a tilted cutting edge when cutting tubes and for cuts without burrs. Reduce the feed by 20% to 50%.

INDICAZIONI E CONSIGLI PER LA SCANALATURA
GROOVING INSTRUCTIONS AND SUGGESTIONS

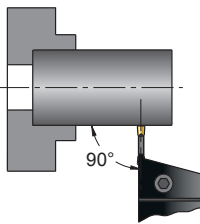

Controllare che l'utensile sia posizionato a 90° rispetto al pezzo, il filo tagliente deve essere parallelo al pezzo.

Make sure that the tool is placed at a 90° angle to the workpiece; the cutting edge must be parallel to the workpiece

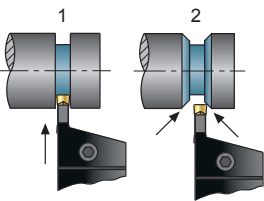

Sequenza corretta per eseguire una scanalatura ed i relativi smussi.

Proper sequence for making a groove and the corresponding chamfering

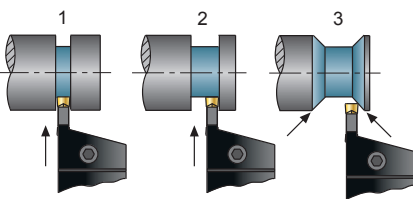

Sequenza corretta per eseguire la scanalatura di gole per pulegge.

Proper sequence for grooving Pulley Races

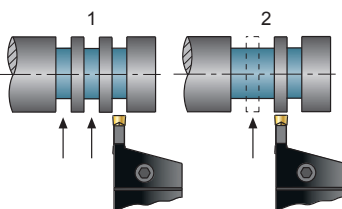

Sequenza corretta per eseguire gole di grandi dimensioni mediante scanalatura a tuffo.

Proper sequence for making large races by means of deep grooving.

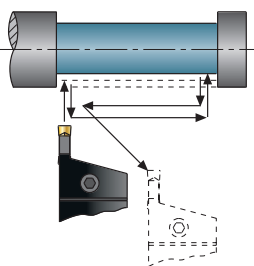

Sequenza corretta per eseguire la lavorazione di sgrossatura in scanalatura

Proper sequence for roughing during grooving

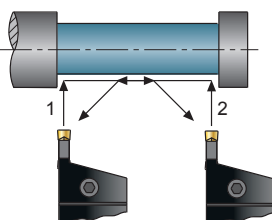

Sequenza corretta per eseguire la lavorazione di finitura in scanalatura

Proper sequence for finishing during grooving

MONTAGGIO SU STOZZATRICI ASSEMBLY ON SLOTTING MACHINES

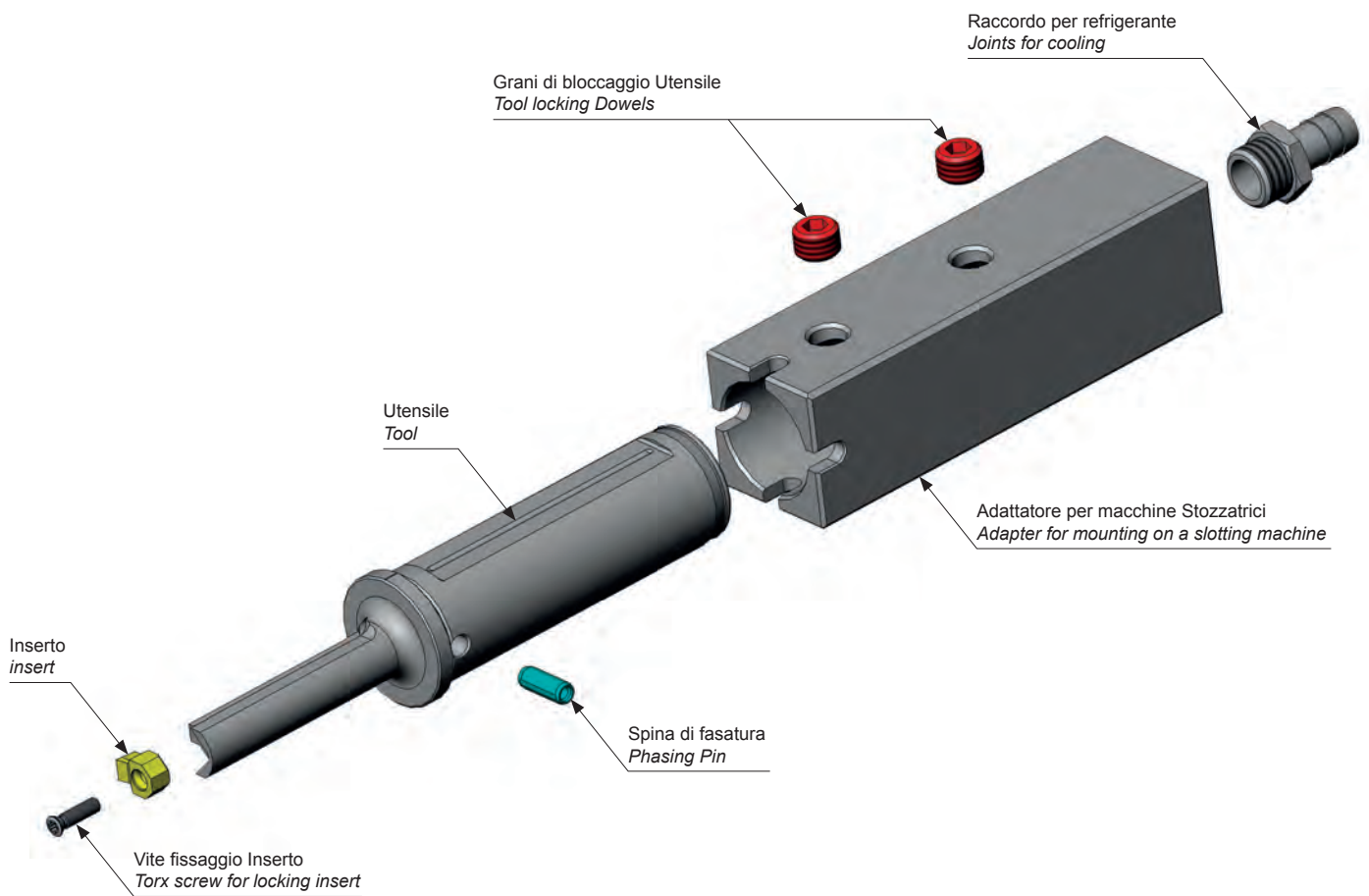

MONTAGGIO SU TORNIO ASSEMBLY ON LATHE

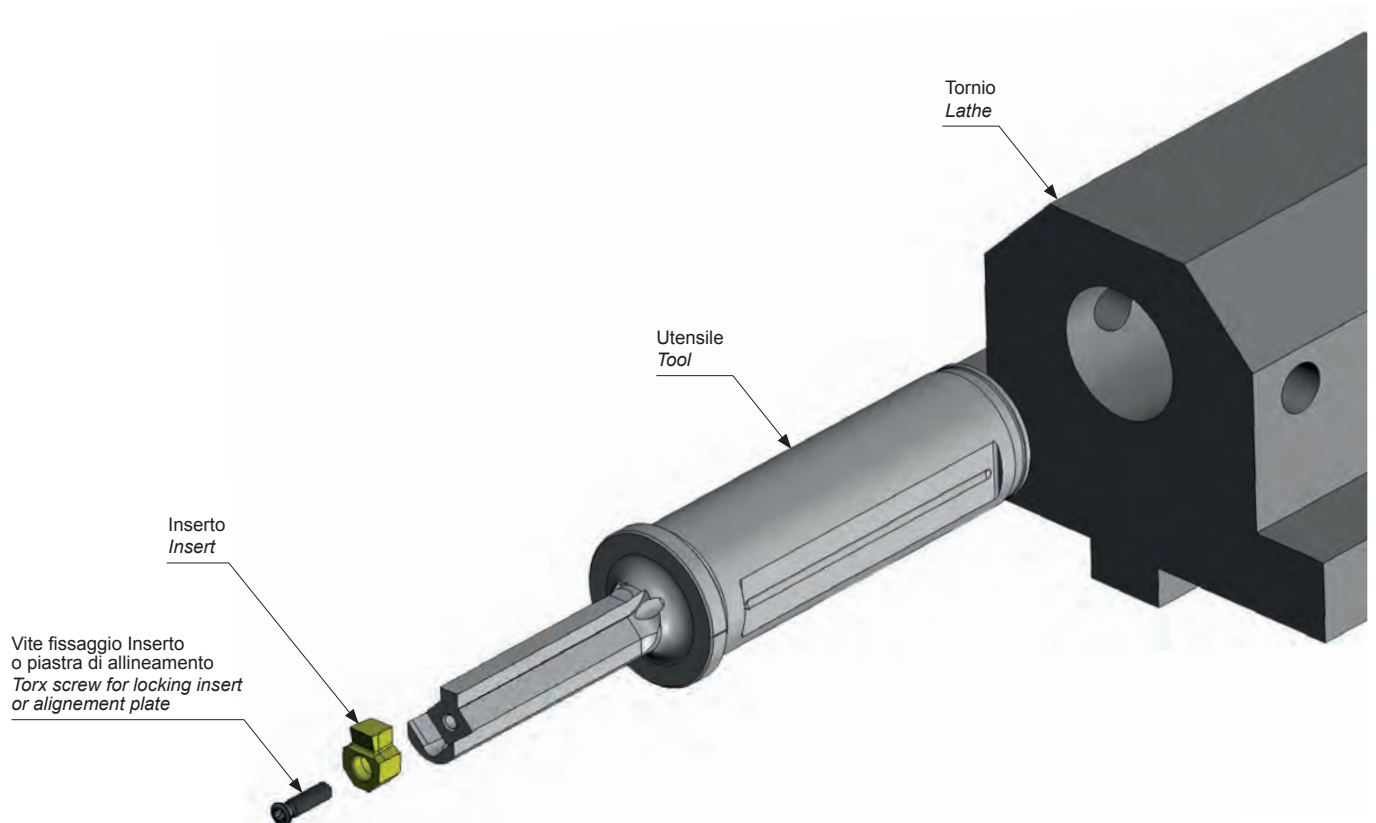

CALCOLO POSIZIONE IN ENTRATA CALCULATION OF THE ENTRY POSITION

INDICAZIONI E CONSIGLI

- È necessario realizzare una gola di scarico al fondo della brocciatura per agevolare l'uscita dell'inserto
- L'utensile non dovrebbe toccare il fondo gola in ritorno
- L'utilizzo dell'olio da taglio o dell'emulsione aiuta ad ottenere una finitura superficiale migliore ed una evacuazione del truciolo più efficace
- Posizionare l'inserto verso l'alto per favorire la fuoriuscita del truciolo
- Il posizionamento dell'utensile è molto importante, controllare il diametro del pezzo prima di iniziare
- Tenere sempre presente il calcolo della posizione di partenza con l'aggiunta della distanza di sicurezza

INDICATIONS AND ADVICE

- It is necessary to create a drainage groove at the bottom of the broaching to facilitate the exit of the insert
- The tool should not touch the bottom of the groove as it is removed
- The use of cutting oil or emulsion helps to obtain a better surface finish and more effective chip evacuation
- Position the insert upwards to facilitate chip escape
- The positioning of the tool is very important, check the diameter of the piece before starting
- Always keep in mind the starting position calculation plus the safety distance

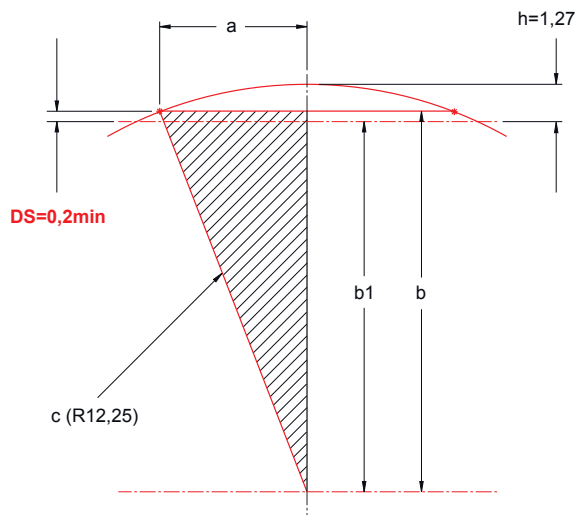

- DS (mm) = DISTANZA DI SICUREZZA
SAFETY DISTANCE
- a (mm) = LARGHEZZA DEL TAGLIANTE /2
WIDTH OF THE CUTTING EDGE /2
- c (mm) = RAGGIO DI INGRESSO
ENTRY RADIUS
- b1 (mm) = POSIZIONE DI PARTENZA
STARTING POSITION
- h (mm) = DISTANZA TANGENZA "FORO - FILO TAGLIANTE"
"HOLE - CUTTING EDGE" TANGENT DISTANCE

Calcolo posizione di partenza b_1 Starting position calculation b_1

$$c^2 \text{ (mm)} = a^2 + b^2$$

$$b^2 \text{ (mm)} = c^2 - a^2$$

$$b \text{ (mm)} = \sqrt{c^2 - a^2}$$

$$b \text{ (mm)} = \sqrt{12,25^2 - 5^2}$$

$$b \text{ (mm)} = 11,18$$

$$b_1 \text{ (mm)} = b - DS$$

$$b_1 \text{ (mm)} = 11,18 - 0,2 = 10,98$$

N.B.

Equivalente ad un diametro di partenza $\varnothing 21,96$ mm
Equivalent to a starting diameter of $\varnothing 21,96$ mm

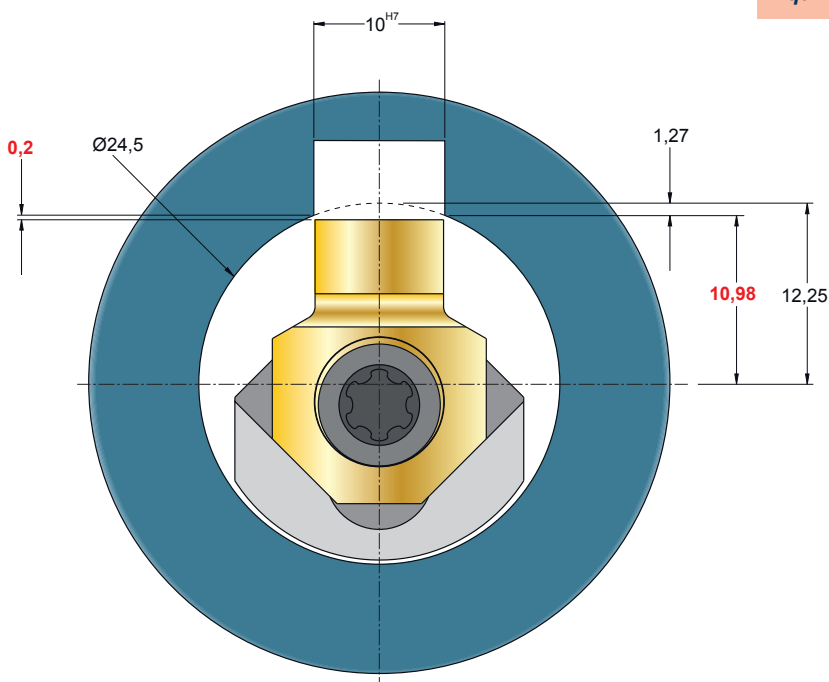

Esempio di lavorazione:

Diametro del foro 24,5mm, Larghezza di brocciatura 10mm: considerando un raggio di ingresso di 12,25mm ed una distanza di sicurezza di 0,2mm dallo spigolo dell'inserto, l'utensile deve essere posizionato ad una posizione di partenza di 10,98mm dal centro del foro per evitare la collisione all'inizio della lavorazione.

Machining example:

Hole diameter 24,5mm, Broaching width 10mm: considering an entry radius of 12,25mm and a safety distance of 0.2mm from the edge of the insert, the tool must be positioned at a starting position of 10,98mm from the center of the hole to avoid collision at the start of machining.

INDICAZIONI E CONSIGLI PER LA LAVORAZIONE
 MACHINING INSTRUCTIONS AND SUGGESTIONS

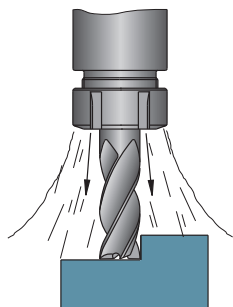
 ARIA COMPRESSA
 COMPRESSED AIR

- Per avere un buon rendimento del tagliente si devono evitare le variazioni termiche
- La scelta prioritaria nella lavorazione di acciaio è costituita dalla fresatura a secco, preferibilmente con aria compressa attraverso il mandrino per rimuovere i trucioli

- For good cutting edge efficiency it is necessary to avoid heat variations
- The highest-priority choice when processing steel is dry milling, preferably with compressed air through the chuck to remove chips

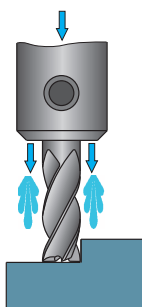
 REFRIGERANTE INTERNO
 INTERNAL COOLANT

- Nella lavorazione delle leghe resistenti al calore è consigliabile usare il refrigerante per raffreddare il materiale e per migliorare l'evacuazione del truciolo.
- Nella lavorazione di acciai inox e di alluminio è consigliabile usare il refrigerante per evitare incollamenti di materiale e per agevolare l'evacuazione del truciolo.
- Nella lavorazione delle ghise è consigliabile usare il refrigerante per abbattere la polvere che si produce durante la lavorazione.

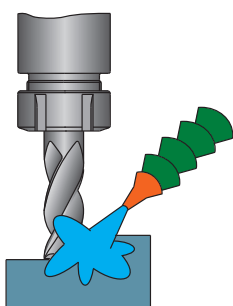
 REFRIGERANTE ESTERNO
 EXTERNAL COOLANT

- When processing heat resistant alloys, it is advisable to use cutting fluid for cooling the material and for improving the removal of chips
- When machining stainless steel and aluminum it is advisable to use coolant to prevent material from sticking and to facilitate the removal of chips
- When machining cast irons it is advisable to use coolant to cut down the amount of dust produced during processing

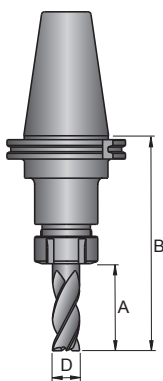

- Per avere una maggiore stabilità dell'utensile ed una maggiore precisione della lavorazione si consiglia di contenere più possibile la sporgenza A e B, si consiglia anche di lavorare con un diametro di fresa più grande possibile. Una sporgenza ridotta del 20% riduce la flessione dell'utensile del 50%. Un diametro superiore del 20% può ridurre del 50% la flessione dell'utensile.

- For increased stability of the tool and greater processing precision, it is advisable to keep the protrusions A and B as small as possible; it is also advisable to use a milling cutter with a diameter that is as large as possible. A protrusion that is reduced by 20% reduces tool flexure by 50%. A diameter that is 20% larger can reduce tool flexure by 50%.

INDICAZIONI E CONSIGLI PER LA LAVORAZIONE
MACHINING INSTRUCTIONS AND SUGGESTIONS

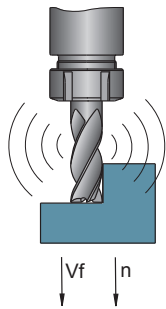

- Se le condizioni di lavoro non sono rigide, vi sono vibrazioni o rumori si consiglia di ridurre il numero di giri e l'avanzamento proporzionalmente.

- If the machining conditions are not rigid, or if there are vibrations or sounds, it is advisable to proportionally reduce the rpm and feed rate

A

B

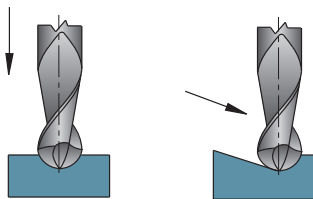

- Se le condizioni lo permettono, si consiglia di penetrare come in figura B. Quando si penetra assialmente, figura A, diminuire l'avanzamento del 50%

- If the machining conditions allow it, it is suggested to penetrate as shown in Figure B. When penetrating axially, as shown in Figure A, reduce the feed rate by 50%.

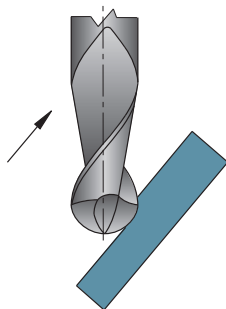

- Quando le condizioni lo permettono, lavorare le pareti inclinate in tiro, come indicato in figura

- When the machining conditions allow it, back-machine the raking walls as shown in the figure

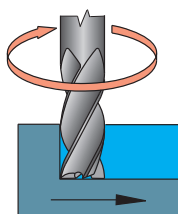

- Per ottenere una migliore rugosità ed una maggiore durata del tagliente si consiglia di lavorare in concordanza

- To obtain increased roughness and a longer life of the cutting edge, accordance machining is suggested

LAVORAZIONE AD ALTA VELOCITÀ DI TAGLIO
 HIGH CUTTING SPEED MACHINING

 HIGH
 SPEED
 CUTTING

VANTAGGI:

- Diminuzione dei tempi macchina, aumento della produttività
- Negli stampi : riduzione di aggiustaggio manuale e di lavorazioni EDM (elettroerosione) a filo o a tuffo
- Finiture superficiali migliori paragonabili alla rettifica, profili 3D più costanti
- Possibilità di lavorare materiali temprati con durezza fino a 70 HRC
- Riduzione degli sforzi in lavorazione, lavorazione di sezioni sottili senza deformazioni
- Smaltimento del calore sul truciolo, nessuna deformazione

FATTORI INDISPENSABILI PER LA LAVORAZIONE HSC:

- I profili devono essere calcolati a CAD
- I percorsi utensile devono prevedere un'entrata fluida dell'utensile in lavorazione, movimenti semicircolari con entrate in tangenza nelle riprese dei profili, sovrametallo costante su tutto il profilo da eseguire
- La macchina deve essere predisposta per la lavorazione HSC : grande memoria di dati, velocità di lettura dei blocchi programma, velocità di rotazione mandrino, rigidità, dinamica e precisione degli assi
- Usare mandrini di precisione, bilanciati e stabili; consigliati gli attacchi HSK o ISO40
- Utilizzare utensili studiati per questo utilizzo, con molti denti; consigliate le frese in metallo duro integrale



ADVANTAGES:

- Reduction of machine times, increase in productivity.
- In the dies: reduction of manual adjustments and long or deep EDM machining (electron discharge machining).
- Improved surface finishes that are comparable to grinding, more constant 3D profiles
- Possibility of machining tempered materials with hardness up to 70 HRC.
- Reduction of machining strain, machining of thin sections without deformations.
- Dispersion of the heat onto the chip, no deformation.

INDISPENSABLE FACTORS FOR HSC MACHINING:

- The profiles must be calculated with CAD
- The tool paths must include a fluid inlet for the tool being used for machining, semicircular movements with inlets that are tangent to the profile intakes, and constant machining allowance on the entire profile to be executed.
- The machine must be designed for HSC machining: a large amount of data storage, fast reading of program blocks, fast chuck rotation, rigidity, dynamic, and precision of the axes.
- Use precise, balanced, and stable chucks; HSK or ISO40 attachments are recommended.
- Use multi-toothed tools that were designed for this use; solid carbide milling cutters are recommended.

ELICA CON ANGOLO VARIABILE E TESTA A DIVISIONE IRREGOLARE HELIX WITH VARIABLE ANGLE AND HEAD WITH IRREGULAR HELIX ANGLES

divisione
irregolare
-
irregular
helix angles

$$\alpha_1 \neq \alpha_2 \neq \alpha_3 \neq \alpha_4$$

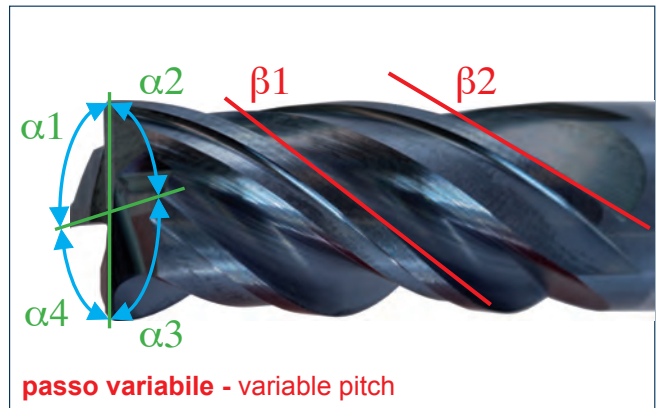
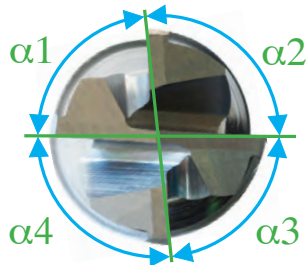

CARATTERISTICHE:

- I taglienti delle frese hanno passo dell'elica variabile; ciò comporta una divisione irregolare dei taglienti. Una fresa con passo dell'elica normale crea molte vibrazioni, la fresa a elica differenziata elimina le vibrazioni, svolge una finitura del pezzo lavorato migliore ed ha una durata superiore.

VANTAGGI:

- Lavorazioni senza vibrazioni
- Migliori finiture
- Maggiori profondità di passata
- Aumento degli avanzamenti
- Aumento della vita utensile

Le frese a passo variabile standard sono prodotte con angoli dell'elica 35°/38°.

Per lavorazioni di materiali tipo alluminio e inox produciamo frese con angoli dell'elica a 43°/45°.



CHARACTERISTICS:

- The cutting-edges of the milling cutters feature a variable helix pitch; this results in an irregular division of the cutting edges. A cutter with a normal helix pitch produces a lot of vibrations, whereas a differentiated helix cutter eliminates all vibrations, produces a better finish and a longer tool life.

ADVANTAGES:

- Vibration-free manufacturing
- Better finish
- Higher cutting-depth
- Higher feed
- Longer tool life

Standard variable pitch cutters are manufactured with 35°/38° helix angle.

For materials such as aluminum and stainless steel we manufacture cutters with 43°/45° helix angles.

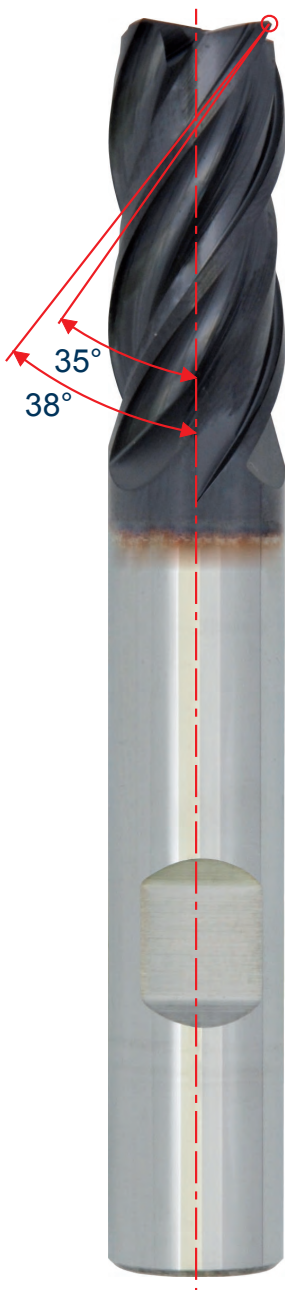

**FRESE HIGH PERFORMANCE - HIGH PERFORMANCE MILLING CUTTERS -
 HIGH PERFORMANCE FRÄSER - FRAISES HAUTES PERFORMANCES**

1

Fresa con gambo scaricato:

Utensile con scarico tra la fine del tagliente e l'inizio del gambo.
 Per lavorazioni superiori alla lunghezza del tagliente.

Milling cutter with undercut shank:

Tool with undercut between the end of the cutting edge and the beginning of the shank.
 For machining that exceeds the length of the cutting edge.

2

Fresa a passo variabile e a divisione irregolare:

Riduzione delle vibrazioni.
 Migliori Finiture.

Milling cutter with variable pitch and unequal flute spacing:

Reduces vibration.
 Better Finishing.

3

Tagliente con rompitruciolo speciale:

lunghezza truciolo ridotta e accostamenti assiali elevati, con conseguente miglioramento della rimozione dei trucioli.

Cutting edge with special chipbreaker:

reduced chip length and high axial squeeze, resulting in improved chip removal.

4

Raggio Torico:

Maggiore resistenza alla sollecitazione termica e meccanica e quindi maggiore rendimento.
 Rinforza il tagliente.

Toric Radius:

Greater resistance to thermal and mechanical stress and, therefore, greater efficiency.
 Reinforces the cutting edge.

5

Geometria frontale scaricata per la fresatura in penetrazione ad alto rendimento:

Fresature con elevato angolo di penetrazione.

Front undercut geometry for high-performance penetration milling:

Milling with high penetration angle.

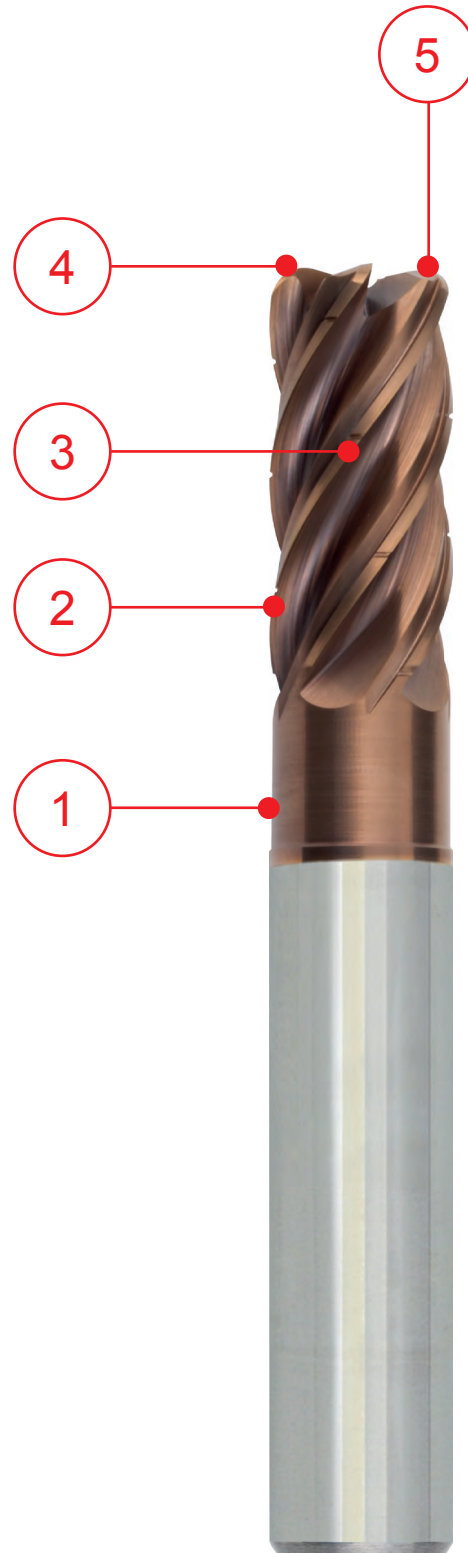

**FRESATURA TROCOIDALE - TROCHOIDAL MILLING -
 TROCHOIDES FRÄSEN - FRAISAGE TROCHOIDAL**
**La lavorazione trocoidale:**

È una fresatura con movimento circolare e avanzamento radiale che genera basse forze di taglio permettendo di utilizzare la tecnica "HSC" *HIGH SPEED CUTTING* (lavorazioni ad alta velocità)

Campo di applicazione:

Lavorazioni di cave, tasche, scanalature complete o parziali con elevate profondità di taglio quando si generano vibrazioni.

Perché utilizzare la fresatura Trocoidale:

1. Utilizzo di tutta la lunghezza del tagliente per passata.

Si ottiene una distribuzione uniforme su tutto il tagliente di calore e usura, permettendo maggior vita utensile.

2. L'avanzamento radiale "ae" deve lavorare piccoli archi.

Creando trucioli di basso spessore, "hm" (spessore medio del truciolo) basso, si possono impiegare frese con più taglienti, evacuando rapidamente il truciolo e quindi mantenendo bassa la temperatura del tagliente, generando basse forze di taglio radiali, allungando la vita utensile.

3. Larghezza cave superiore del diametro fresa.

Si utilizzano frese con diametro inferiore, permettendo la lavorazione di cave con differenti larghezze, con lo stesso utensile portando a una maggior versatilità.

4. In molti casi si ottiene un volume truciolo maggiore rispetto alla lavorazione tradizionale.

Riassumendo:

- Alto volume truciolo.
- Maggior vita utensile.
- Riduzione di vibrazioni.
- Massima velocità di taglio "Vc" e di avanzamento "fz".
- Basso calore.
- Riduzione di consumi energetici.

Caratteristiche, per una lavorazione Trocoidale ottimale:

- Macchina utensile di ultima generazione.
- Cam di ultima generazione.
- Utensili della serie "SM5215" - "SMW5405"

**Trochoidal machining:**

This type of milling is performed through circular movements and radial feed, which generate low cutting forces that allow the use of the "HSC" HIGH SPEED CUTTING technique.

Field of application:

Machining of slots, pockets, complete or partial grooves with high cutting depths when vibrations are generated.

Why use trochoidal milling:

1. Use of the entire length of the cutting edge per stroke.

Heat is distributed uniformly over the entire cutting edge, which therefore wears out evenly, thus allowing a longer tool life.

2. The radial "ae" feed must machine small arcs.

By creating not very thick chips, i.e. low "hm" (average chip thickness), you can use milling cutters with multiple cutting edges, quickly removing the chip and therefore keeping the cutting edge at a low temperature, generating low radial cutting forces and extending tool life.

3. Slot width greater than milling cutter diameter.

Milling cutters with smaller diameters are used, allowing the machining of slots with different widths, with the same tool, leading to greater versatility.

4. In many cases, a higher chip volume is obtained compared to traditional machining.

In summary:

- High chip volume.
- Longer tool life.
- Vibration reduction.
- Maximum "Vc" cutting speed and "fz" feed rate.
- Low heat.
- Less energy consumption.

Features for optimal trochoidal machining:

- Latest generation machine tool.
- Latest generation CAM.
- Tools of the "SM5215" - "SMW5405" series.

INDICAZIONI E CONSIGLI PER LA LAVORAZIONE
MACHINING INSTRUCTIONS AND SUGGESTIONS

CONCORDANZA - ACCORDANCE

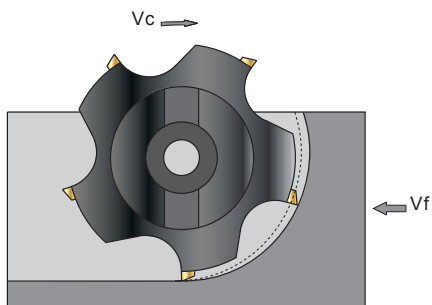

Da preferire la fresatura in concordanza se ci sono le condizioni di stabilità e di potenza della macchina.

DISCORDANZA - DISCORDANCE

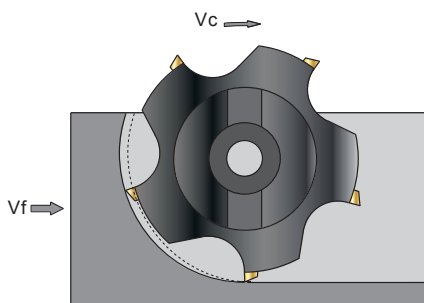

Accordance milling is preferable if conditions of stability and machine power are present

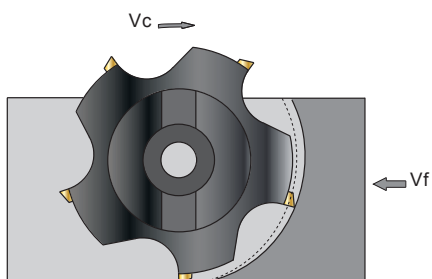

Posizione fra pezzo e fresa consigliata.

Reccomeded position between workpiece and milling cutter

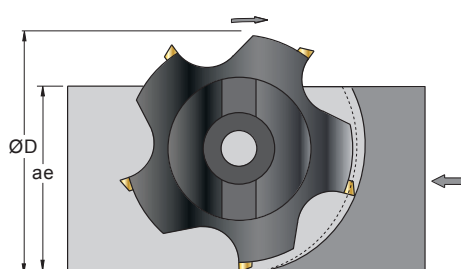

ØD della fresa per spianatura consigliato in funzione della larghezza ae:
ØD = + 20/30% di ae.

Diameter (ØD) of the flattening milling cutter that is reccomeded according to the width ae: diameter (ØD) = +20-30% of ae

PASSO NORMALE - STANDARD PITCH

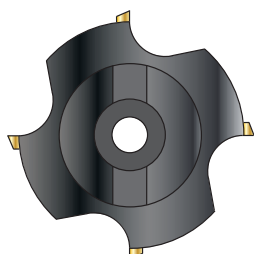

Per la lavorazione di acciaio in genere e con macchina di piccola potenza.

For generic steel machining with a low-power machine

INDICAZIONI E CONSIGLI PER LA LAVORAZIONE
MACHINING INSTRUCTIONS AND SUGGESTIONS

PASSO LARGO - WIDE PITCH

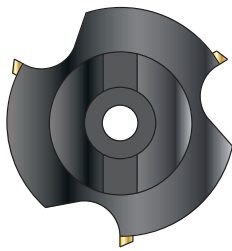

Per la lavorazione di leghe leggere, inox austenitici, leghe resistenti al calore, con macchina di piccola potenza e con utensili lunghi.

For machining light alloys, austenitic stainless, heat-resistant alloys, with a low-power machine, and with long tools

PASSO FINE - FINE PITCH

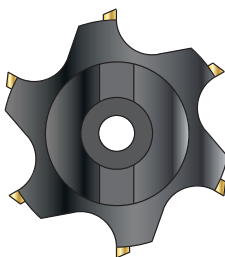

Per la lavorazione di ghisa grigia, in condizioni di stabilità e con macchine di buona potenza.

For machining gray iron, under stable conditions with a powerfull machine

INSERTO CON RAGGIO - INSERT WITH RADIUS

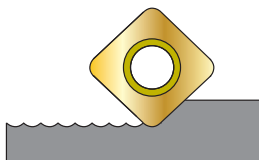

Si ottiene una superficie con elevata rugosità anche in condizione di basso avanzamento.

A surface with a high degree of roughness is achieved, even with a low feed rate

INSERTO CON PIANO - INSERT WITH PLANE SURFACE

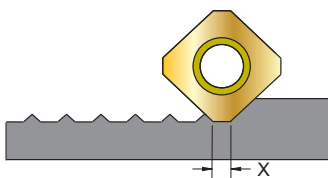

Si ottiene una superficie con buona rugosità solo se X (mm) é uguale o maggiore all'avanzamento al giro della fresa.

Surface with a good degree of roughness is achieved only if X (mm) is greater than or equal to the feed per revolution of the milling cutter

INSERTO RASCHIANTE - SCRAPING INSERT

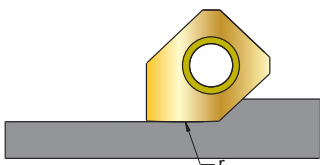

Si ottiene una superficie con ottima rugosità particolarmente indicato nella lavorazione della ghisa.

A surface with a good degree of roughness is obtained which is especially suitable for machining cast iron

SIGLE E FORMULE GENERALI
GENERAL ACRONYMS AND FORMULAS

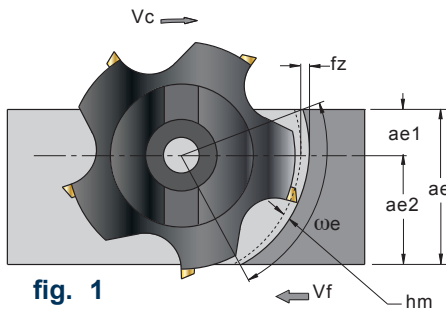
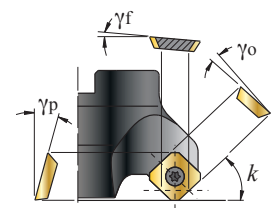
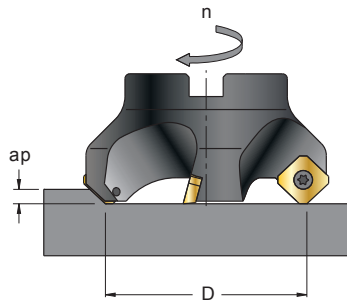

fig. 1



- ae** (mm) = LARGHEZZA DELLA FRESATURA
- ap** (mm) = PROFONDITÀ DELLA FRESATURA
- D** (mm) = DIAMETRO DELLA FRESA
- fn** (mm) = AVANZAMENTO AL GIRO
- fz** (mm) = AVANZAMENTO AL DENTE
- hm** (mm) = SPESSORE MEDIO DEL TRUCIOLO
- K** = FATTORE DI AVANZAMENTO
- Kc** (N/mm²) = FORZA DI TAGLIO SPECIFICA



- = CUTTING-PARTING WIDTH
- = DEPTH OF AXIAL CUTTING
- = MILLING DIAMETER
- = FEED / REV.
- = TOOTH FEED
- = CHIP 'S AVERAGE THICKNESS
- = FACTOR OF FEED
- = SPECIFIC CUTTING FORCE

- Kc1.1** (N/mm²) = FORZA DI STRAPPAMENTO SPECIFICA DEL MATERIALE LAVORATO (VEDI TABELLE MATERIALI PAG 1200/1206)
- mc** = ESPONENTE DI INCREMENTO DELLA FORZA SPECIFICA DI TAGLIO (VEDI TABELLE MATERIALI PAG 1200/1206)
- n** (giri/min - min⁻¹) = NUMERO DI GIRI AL MINUTO
- Pc** (kw) = POTENZA ASSORBITA
- Q** (cm³/min) = VOLUME DEL TRUCIOLO ASPORTATO
- Vc** (m/min) = VELOCITÀ DI TAGLIO
- Vf** (mm/min) = VELOCITÀ DI AVANZAMENTO
- z** = NUMERO DENTI DELLA FRESA
- η** (0,7-0,85) = RENDIMENTO MECCANICO DELLA MACCHINA
- ωe** (°) = ANGOLO DI IMPEGNO
- k** (°) = ANGOLO DI REGISTRAZIONE O DI ATTACCO AL PROFILO
- γp** (°) = ANGOLO ASSIALE (VALORE INDICATO NELLA PAGINA DI OGNI FRESA)
- γf** (°) = ANGOLO RADIALE (VALORE INDICATO NELLA PAGINA DI OGNI FRESA)
- γo** (°) = ANGOLO DI SPOGLIA ORTOGONALE (SUPERIORE) (VALORE INDICATO NELLA PAGINA DI OGNI FRESA)
- γw** (0°+30°) = ANGOLO DI SPOGLIA SUPERIORE DELL'INSERTO

- = SPECIFIC TEARING FORCE OF MACHINED MATERIAL (SEE MATERIALS TABLES, PAGE 1200/1206)
- = SPECIFIC CUTTING FORCE INCREMENT (SEE MATERIALS TABLES, PAGE 1200/1206)
- = NUMBER OF REVOLUTIONS / MIN'
- = ABSORBED POWER
- = VOLUME OF CHIP REMOVED
- = CUTTING SPEED
- = FEED RATE
- = NUMBER OF TEETH
- = MECHANICAL EFFICIENCY OF THE MACHINE
- = CUTTING ANGLE
- = SIDE CUTTING EDGE ANGLE – ENTERING ANGLE
- = AXIAL ANGLE (VALUE LISTED ON EACH MILLING CUTTER PAGE)
- = RADIAL RAKE ANGLE (VALUE LISTED ON EACH MILLING CUTTER PAGE)
- = TRUE RAKE ANGLE (VALUE LISTED ON EACH MILLING CUTTER PAGE)
- = FRONT RAKE ANGLE

$$Vc \text{ (m/min)} = \frac{D \cdot 3,14 \cdot n}{1000}$$

$$n \text{ (giri/min - min}^{-1}\text{)} = \frac{Vc \cdot 1000}{D \cdot 3,14}$$

$$Vf \text{ (mm/min)} = fz \cdot n \cdot z$$

$$fn \text{ (mm)} = fz \cdot z$$

$$fz \text{ (mm)} = \frac{Vf}{n \cdot z}$$

$$Q \text{ (cm}^3\text{/min)} = \frac{ae \cdot ap \cdot Vf}{1000}$$

$$Pc \text{ (KW)} = \frac{ae \cdot ap \cdot Vf}{60.000.000 \cdot \eta} \cdot Kc$$

$$Kc \text{ (N/mm}^2\text{)} = \frac{1 - 0,015 \cdot (\gamma_o + \gamma_w)}{hm^{mc}} \cdot Kc1.1$$

fig. 1

$$\omega_e \text{ (}^\circ\text{)} = \arcsin\left(\frac{2 \cdot ae1}{D}\right) + \arcsin\left(\frac{2 \cdot ae2}{D}\right)$$

$$fz \text{ (mm)} = \frac{hm \cdot 3,14 \cdot D \cdot \omega_e}{\sin k \cdot ae \cdot 360}$$

$$hm \text{ (mm)} = \frac{360 \cdot fz \cdot ae \cdot \sin k}{3,14 \cdot D \cdot \omega_e}$$

ae/D ≤ 0,3

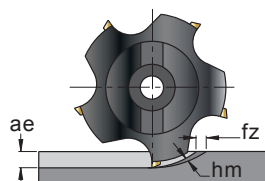

$$hm \approx fz \cdot \sqrt{\frac{ae}{D}}$$

$$fz \approx hm \cdot \sqrt{\frac{D}{ae}}$$

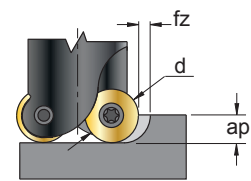

$$hm \approx fz \cdot \sqrt{\frac{ap}{d}}$$

$$fz \approx hm \cdot \sqrt{\frac{d}{ap}}$$

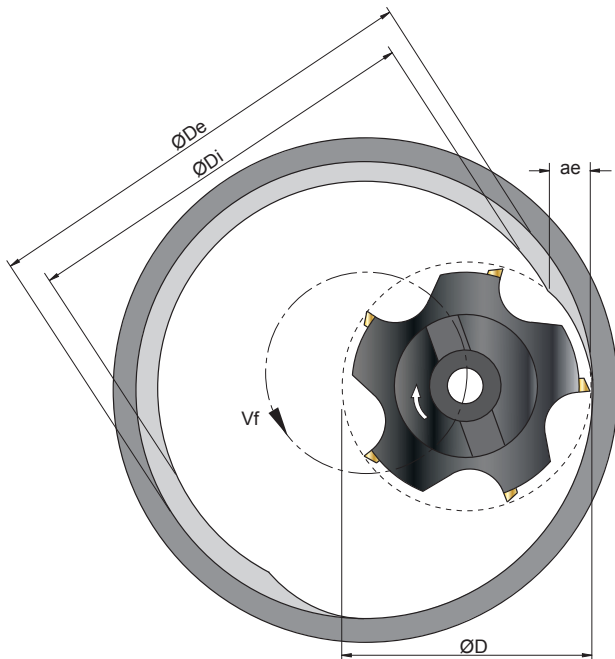
FRESATURA PER INTERPOLAZIONE CIRCOLARE - FORMULE
MILLING FOR CIRCULAR INTERPOLATION - FORMULAS
INTERPOLAZIONE CIRCOLARE INTERNA
INTERNAL CIRCULAR INTERPOLATION

$$ae \text{ (mm)} = \frac{\varnothing D_e^2 - \varnothing D_i^2}{4 \cdot (\varnothing D_e - \varnothing D)}$$

$$V_f \text{ (mm/min)} = \left(1 - \frac{\varnothing D}{\varnothing D_e}\right) \cdot n \cdot f_z \cdot z$$

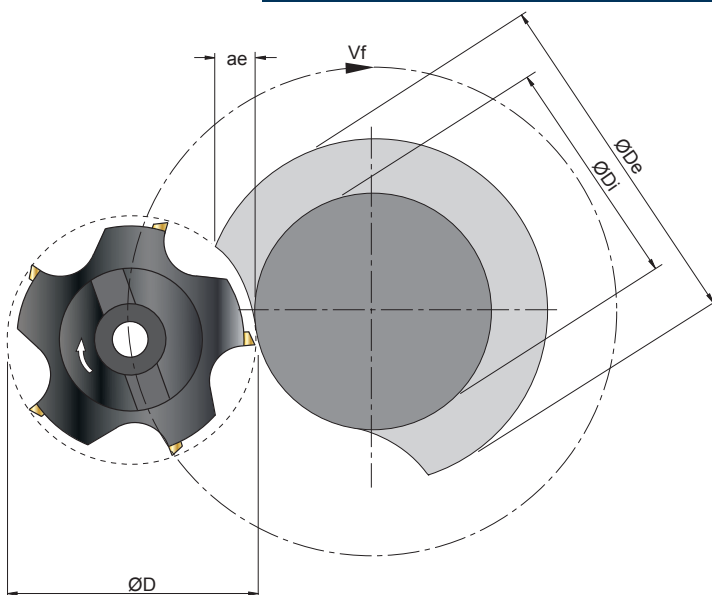
INTERPOLAZIONE CIRCOLARE ESTERNA
EXTERNAL CIRCULAR INTERPOLATION

$$ae \text{ (mm)} = \frac{\varnothing D_e^2 - \varnothing D_i^2}{4 \cdot (\varnothing D_i + \varnothing D)}$$

$$V_f \text{ (mm/min)} = \left(1 + \frac{\varnothing D}{\varnothing D_i}\right) \cdot n \cdot f_z \cdot z$$

LE INDICAZIONI SOPRA RIPORTATE VALGONO ANCHE PER LA FILETTATURA, TENENDO PRESENTE CHE IN QUESTO CASO SI TRATTA DI INTERPOLAZIONE ELICOIDALE.
 THE ABOVE-MENTIONED INSTRUCTIONS ALSO APPLY TO THREADING, BUT IN THIS CASE THEY REFER TO HELICAL INTERPOLATION

**CALCOLO INTERPOLAZIONE ELICOIDALE
CALCULATION OF HELICAL INTERPOLATION**

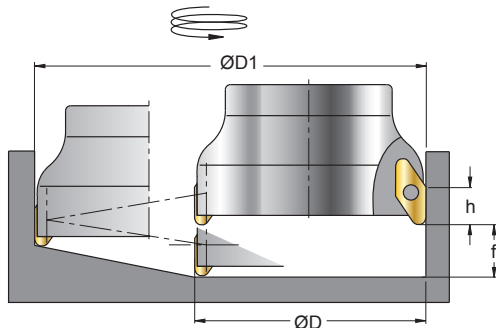

$$f \text{ (mm)} = (\text{ØD1} - \text{ØD}) \cdot 3,14 \cdot \tan \beta$$



**“f” NON DEVE MAI ESSERE SUPERIORE A “h”
“f” SHOULD NEVER BE HIGHER THAN “h”**

β (°) = ANGOLO DI PENETRAZIONE OBLIQUA - RAMPING ANGLE

PER I VALORI DI β VEDERE PAG ARTICOLO INTERESSATO
FOR β VALUES SEE PAGE ITEM IN QUESTION

**CALCOLO LUNGHEZZA PENETRAZIONE OBLIQUA
CALCULATION OF RAMPING LENGTH**

$$L1 \text{ (mm)} = \frac{ap}{\tan \beta}$$

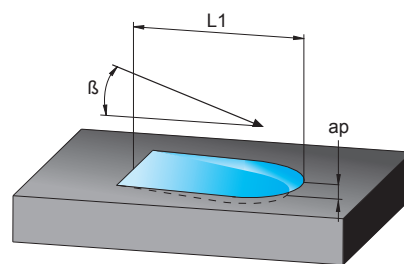

β (°) = ANGOLO DI PENETRAZIONE OBLIQUA - RAMPING ANGLE
L1 (mm) = LUNGHEZZA DI PENETRAZIONE OBLIQUA - RAMPING LENGTH
ap (mm) = PROFONDITÀ DELLA FRESATURA - DEPTH OF AXIAL CUTTING

PER I VALORI DI β VEDERE PAG ARTICOLO INTERESSATO
FOR β VALUES SEE PAGE ITEM IN QUESTION

LAVORAZIONE PER INTERPOLAZIONE ELICOIDALE, ESECUZIONE FORI DAL PIENO
 HELICAL INTERPOLATION MACHINING, BORES MADE IN THE SOLID BODY

FRESE PER SPALLAMENTO
 SHOULDER MILLING CUTTERS

DIAMETRO MINIMO DI INTERPOLAZIONE
 MINIMUM DIAMETER OF INTERPOLATION

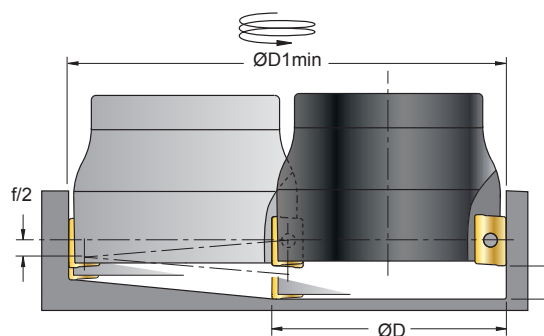

DIAMETRO MASSIMO DI INTERPOLAZIONE
 MAXIMUM DIAMETER OF INTERPOLATION

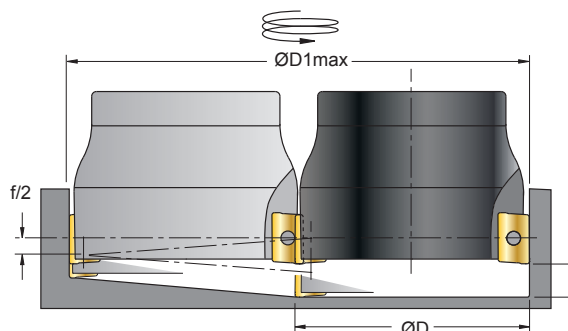

MASSIMA LARGHEZZA FRESATURA
 CON FORO PASSANTE
 MAXIMUM MILLING WIDTH WITH THROUGH HOLE

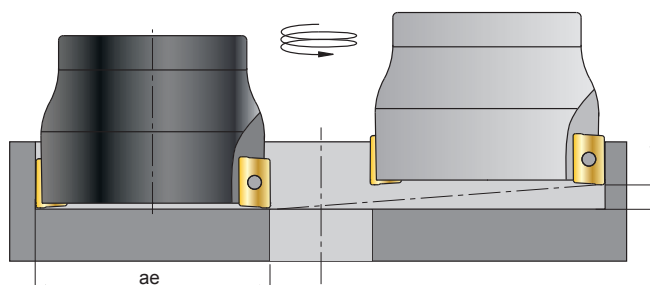

COD.	INSERTO INSERT	ØD	β	Foro cieco Blind hole				foro passante through hole	
				ØD1 min.	f max.	ØD1 max.	f max.	ae	f
S 1086W 015 - 10	AP..1003..	15	4°	23,3	1,0	28,5	1,0	13	(...)
S 1086W 016 - 10	AP..1003..	16	3,5°	25,3	1,0	30,5	1,0	14	(...)
S 1086W 017 - 10	AP..1003..	17	3°	27,3	1,0	32,5	1,0	15	(...)
S 1086W 018 - 10	AP..1003..	18	2,5°	29,3	1,0	34,5	1,0	16	(...)
S 1086W 019 - 10	AP..1003..	19	2°	31,3	1,0	36,5	1,0	17	(...)
S 1086W 020 - 10	AP..1003..	20	1,5°	33,3	1,0	38,5	1,0	18	(...)
S 1086W 022 - 10	AP..1003..	22	1,5°	37,3	1,0	42,5	1,0	20	(...)
S 1086W 024 - 10	AP..1003..	24	1°	41,3	1,0	46,5	1,0	22	(...)
S 1086W 025 - 10	AP..1003..	25	0,9°	43,3	1,0	48,5	1,0	23	(...)
S 1086W 028 - 10	AP..1003..	28	0,9°	49,3	1,0	54,5	1,0	26	(...)
S 1086W 029 - 10	AP..1003..	29	0,8°	51,3	1,0	56,5	1,0	27	(...)
S 1086W 030 - 10	AP..1003..	30	0,8°	53,3	1,0	58,5	1,0	28	(...)
S 1086W 032 - 10	AP..1003..	32	0,6°	57,3	1,0	62,5	1,0	30	(...)
S 1086GW 020 - 10	AP..1003..	20	1,5°	33,3	1,0	38,5	1,0	18	(...)
S 1086GW 025 - 10	AP..1003..	25	0,9°	43,3	1,0	48,5	1,0	23	(...)

LAVORAZIONE PER INTERPOLAZIONE ELICOIDALE, ESECUZIONE FORI DAL PIENO
HELICAL INTERPOLATION MACHINING, BORES MADE IN THE SOLID BODY

COD.	INSERTO INSERT	ØD	β	Foro cieco Blind hole				foro passante through hole	
				ØD1 min.	f max.	ØD1 max.	f max.	ae	f
S 1086GW 032 - 10	AP..1003..	32	0,6°	57,3	1,0	62,5	1,0	30	(...)
S 1086GXL 020 - 10	AP..1003..	20	1,5°	33,3	1,0	38,5	1,0	18	(...)
S 1086GXL 025 - 10	AP..1003..	25	0,9°	43,3	1,0	48,5	1,0	23	(...)
S 1086GXL 032 - 10	AP..1003..	32	0,6°	57,3	1,0	62,5	1,0	30	(...)
S 1086GXL 040 - 10	AP..1003..	40	-	73,3	1,0	78,5	1,0	38	(...)
S 1086XLZ 015 - 10	AP..1003..	15	4°	23,3	1,0	28,5	1,0	13	(...)
S 1086XLZ 016 - 10	AP..1003..	16	3,5°	25,3	1,0	30,5	1,0	14	(...)
S 1086XLZ 017 - 10	AP..1003..	17	3°	27,3	1,0	32,5	1,0	15	(...)
S 1086XLZ 018 - 10	AP..1003..	18	2,5°	29,3	1,0	34,5	1,0	16	(...)
S 1086XLZ 019 - 10	AP..1003..	19	2°	31,3	1,0	36,5	1,0	17	(...)
S 1086XLZ 020 - 10	AP..1003..	20	1,5°	33,3	1,0	38,5	1,0	18	(...)
S 1086XLZ 022 - 10	AP..1003..	22	1,5°	37,3	1,0	42,5	1,0	20	(...)
S 1086XLZ 024 - 10	AP..1003..	24	1°	41,3	1,0	46,5	1,0	22	(...)
S 1086XLZ 025 - 10	AP..1003..	25	0,9°	43,3	1,0	48,5	1,0	23	(...)
S 1086XLZ 028 - 10	AP..1003..	28	0,9°	49,3	1,0	54,5	1,0	26	(...)
S 1086XLZ 029 - 10	AP..1003..	29	0,8°	51,3	1,0	56,5	1,0	27	(...)
S 1086XLZ 030 - 10	AP..1003..	30	0,8°	53,3	1,0	58,5	1,0	28	(...)
S 1086XLZ 032 - 10	AP..1003..	32	0,6°	57,3	1,0	62,5	1,0	30	(...)
S 1086XLZM 016 - 10	AP..1003..	16	1,5°	25,3	1,0	30,5	1,0	14	(...)
S 1086XLZM 020 - 10	AP..1003..	20	1,5°	33,3	1,0	38,5	1,0	18	(...)
S 1086XLZM 025 - 10	AP..1003..	25	0,9°	43,3	1,0	48,5	1,0	23	(...)
S 1088 040 - 10	AP..1003..	40	-	73,3	1,0	78,5	1,0	38	(...)
S 1088 050 - 10	AP..1003..	50	-	93,3	1,0	98,5	1,0	48	(...)
S 1088 063 - 10	AP..1003..	63	-	119,3	1,0	124,5	1,0	61	(...)
S 1088W 040 - 10	AP..1003..	40	-	73,3	1,0	78,5	1,0	38	(...)
S 1088W 050 - 10	AP..1003..	50	-	93,3	1,0	98,5	1,0	48	(...)
S 1088W 063 - 10	AP..1003..	63	-	119,3	1,0	124,5	1,0	61	(...)
S 1088GW 040 - 10	AP..1003..	40	-	73,3	1,0	78,5	1,0	38	(...)
S 1088GW 050 - 10	AP..1003..	50	-	93,3	1,0	98,5	1,0	48	(...)
S 1088GW 063 - 10	AP..1003..	63	-	119,3	1,0	124,5	1,0	61	(...)
S 1696W 025 - 16	AP..1604..	25	3,5°	40,6	1,5	48,0	1,5	23	(...)
S 1696W 032 - 16	AP..1604..	32	2,0°	54,6	1,5	62,0	1,5	30	(...)
S 1696W 040 - 16	AP..1604..	40	1,5°	70,6	1,5	78,0	1,5	38	(...)
S 1696XLZ 025 - 16	AP..1604..	25	3,5°	40,6	1,5	48,0	1,5	23	(...)
S 1696XLZ 032 - 16	AP..1604..	32	2,0°	54,6	1,5	62,0	1,5	30	(...)
S 1696XLZ 040 - 16	AP..1604..	40	1,5°	70,6	1,5	78,0	1,5	38	(...)
S 1696XLZM 025 - 16	AP..1604..	25	3,5°	40,6	1,5	48,0	1,5	23	(...)
S 1696XLZM 032 - 16	AP..1604..	32	2,0°	54,6	1,5	62,0	1,5	30	(...)
S 1698 040 - 16	AP..1604..	40	1,8°	70,6	1,5	78,0	1,5	38	(...)
S 1698 050 - 16	AP..1604..	50	1,0°	90,6	1,5	98,0	1,5	48	(...)
S 1698 063 - 16	AP..1604..	63	0,7°	116,6	1,5	124,0	1,5	61	(...)
S 1698 080 - 16	AP..1604..	80	0,6°	150,6	1,5	158,0	1,5	78	(...)
S 1698 100 - 16	AP..1604..	100	0,4°	190,6	1,5	198,0	1,5	98	(...)
S 1698 125 - 16	AP..1604..	125	0,3°	240,6	1,5	248,0	1,5	123	(...)

LAVORAZIONE PER INTERPOLAZIONE ELICOIDALE, ESECUZIONE FORI DAL PIENO
HELICAL INTERPOLATION MACHINING, BORES MADE IN THE SOLID BODY

COD.	INSERTO INSERT	ØD	β	Foro cieco Blind hole				foro passante through hole	
				ØD1 min.	f max.	ØD1 max.	f max.	ae	f
S 1698W 040 - 16	AP..1604..	40	1,8°	70,6	1,5	78,0	1,5	38	(...)
S 1698W 050 - 16	AP..1604..	50	1,0°	90,6	1,5	98,0	1,5	48	(...)
S 1698W 063 - 16	AP..1604..	63	0,7°	116,6	1,5	124,0	1,5	61	(...)
S 1698W 080 - 16	AP..1604..	80	0,6°	150,6	1,5	158,0	1,5	78	(...)
S 1698W 100 - 16	AP..1604..	100	0,4°	190,6	1,5	198,0	1,5	98	(...)
S 1698W 125 - 16	AP..1604..	125	0,3°	240,6	1,5	248,0	1,5	123	(...)
S 1698GW 040 - 16	AP..1604..	40	1,8°	70,6	1,5	78,0	1,5	38	(...)
S 1698GW 050 - 16	AP..1604..	50	1,0°	90,6	1,5	98,0	1,5	48	(...)
S 1698GW 063 - 16	AP..1604..	63	0,7°	116,6	1,5	124,0	1,5	61	(...)
S 1698GW 080 - 16	AP..1604..	80	0,6°	150,6	1,5	158,0	1,5	78	(...)
S 1698GW 100 - 16	AP..1604..	100	0,4°	190,6	1,5	198,0	1,5	98	(...)
S 1698GW 125 - 16	AP..1604..	125	0,3°	240,6	1,5	248,0	1,5	123	(...)
S9001-6W-020-02-10	LNMM 1006..	20	4°	33,5	3,0	38,5	4,0	18	(...)
S9001-6W-020-03-10	LNMM 1006..	20	4°	33,5	3,0	38,5	4,0	18	(...)
S9001-6W-025-02-10	LNMM 1006..	25	3,5°	43,5	4,0	48,5	4,0	23	(...)
S9001-6W-025-03-10	LNMM 1006..	25	3,5°	43,5	4,0	48,5	4,0	23	(...)
S9001-6W-032-03-10	LNMM 1006..	32	3°	57,5	4,0	62,5	4,5	30	(...)
S9001-6W-032-04-10	LNMM 1006..	32	3°	57,5	4,0	62,5	4,5	30	(...)
S9001-6W-040-04-10	LNMM 1006..	40	2°	73,5	3,5	78,5	4,0	38	(...)
S9001-6W-040-05-10	LNMM 1006..	40	2°	73,5	3,5	78,5	4,0	38	(...)
S9001-6XLW-020-02-10	LNMM 1006..	20	4°	33,5	3,0	38,5	4,0	18	(...)
S9001-6XLW-025-02-10	LNMM 1006..	25	3,5°	43,5	4,0	48,5	4,0	23	(...)
S9001-6XLW-032-03-10	LNMM 1006..	32	3°	57,5	4,0	62,5	4,5	30	(...)
S9001-6XLMW-020-02-10	LNMM 1006..	20	4°	33,5	3,0	38,5	4,0	18	(...)
S9001-6XLMW-025-02-10	LNMM 1006..	25	3,5°	43,5	4,0	48,5	4,0	23	(...)
S9001-6XLMW-032-03-10	LNMM 1006..	32	3°	57,5	4,0	62,5	4,5	30	(...)
S9001-8W-040-04-10	LNMM 1006..	40	2°	73,5	4,0	78,5	4,0	38	(...)
S9001-8W-040-05-10	LNMM 1006..	40	2°	73,5	4,0	78,5	4,0	38	(...)
S9001-8W-050-05-10	LNMM 1006..	50	1,5°	93,5	3,5	98,5	3,5	48	(...)
S9001-8W-050-07-10	LNMM 1006..	50	1,5°	93,5	3,5	98,5	3,5	48	(...)
S9001-8W-063-06-10	LNMM 1006..	63	1°	119,5	3,5	124,5	3,5	61	(...)
S9001-8W-063-06-10	LNMM 1006..	63	1°	119,5	3,5	124,5	3,5	61	(...)
S9001-6W-032-02-15	LNMM 1510..	32	2,5°	54,0	3,0	62,0	2,0	30	(...)
S9001-6W-032-03-15	LNMM 1510..	32	2,5°	54,0	3,0	62,0	2,0	30	(...)
S9001-6W-040-03-15	LNMM 1510..	40	2°	70,0	3,0	78,0	4,0	38	(...)
S9001-6W-040-04-15	LNMM 1510..	40	2°	70,0	3,0	78,0	4,0	38	(...)
S9001-8W-050-03-15	LNMM 1510..	50	2°	90,0	4,0	98,0	5,0	48	(...)
S9001-8W-050-04-15	LNMM 1510..	50	2°	90,0	4,0	98,0	5,0	48	(...)
S9001-8W-063-04-15	LNMM 1510..	63	2°	116,0	5,0	124,0	5,0	61	(...)
S9001-8W-063-06-15	LNMM 1510..	63	2°	116,0	5,0	124,0	5,0	61	(...)
S9001-8W-080-05-15	LNMM 1510..	80	1,5°	150,0	5,0	158,0	5,0	78	(...)
S9001-8W-080-07-15	LNMM 1510..	80	1,5°	150,0	5,0	158,0	5,0	78	(...)
S 2000.86W 010-01.07	BD.. 0703..	10	6°	15,4	1,78	19,0	2,97	8	(...)
S 2000.86W 012-02.07	BD.. 0703..	12	3,5°	19,4	1,42	23,0	2,11	10	(...)

 - PER FORI PASSANTI CALCOLARE f MEDIANTE LA FORMULA DI PAG 1143

 - FOR THROUGH HOLES, CALCULATE f USING THE FORMULA ON PAGE 1143

 - FÜR DURCHGANGLÖCHER IST f ÜBER DIE FORMEL VON SEITE 1143 ZU BERECHNEN

 - EN CAS DE TROUS DE PASSAGE CALCULER f MOYENNANT LA FORMULE PAGE 1143

LAVORAZIONE PER INTERPOLAZIONE ELICOIDALE, ESECUZIONE FORI DAL PIENO
HELICAL INTERPOLATION MACHINING, BORES MADE IN THE SOLID BODY

COD.	INSERTO INSERT	ØD	β	Foro cieco Blind hole				foro passante through hole	
				ØD1 min.	f max.	ØD1 max.	f max.	ae	f
S 2000.86W 014-02.07	BD.. 0703..	14	3°	23,4	1,55	27,0	2,14	12	(...)
S 2000.86W 016-03.07	BD.. 0703..	16	1,8°	27,4	1,12	31,0	1,48	14	(...)
S 2000.86W 020-04.07	BD.. 0703..	20	1,4°	35,4	1,18	39,0	1,46	18	(...)
S 2000.86W 025-05.07	BD.. 0703..	25	1,0°	45,4	1,12	49,0	1,32	23	(...)
S 2000.89W 018-03.07	BD.. 0703..	18	1,6°	31,4	1,18	35,0	1,49	16	(...)
S 2000.89W 022-03.07	BD.. 0703..	22	1,2°	39,4	1,14	43,0	1,38	20	(...)
S 2000.89W 022-04.07	BD.. 0703..	22	1,2°	39,4	1,14	43,0	1,38	20	(...)
S 2000.89W 028-05.07	BD.. 0703..	28	0,9°	51,4	1,15	55,0	1,33	26	(...)
S 2000.89W 035-07.07	BD.. 0703..	35	0,7°	65,4	1,17	69,0	1,30	33	(...)
S 2000.86W 016-02.11	BD.. 11T3..	16	3°	25,3	1,53	30,0	2,30	14	(...)
S 2000.86W 020-03.11	BD.. 11T3..	20	5°	33,3	3,65	38,0	4,94	18	(...)
S 2000.86W 025-03.11	BD.. 11T3..	25	2,5°	43,3	2,51	48,0	3,15	23	(...)
S 2000.86W 032-04.11	BD.. 11T3..	32	1,5°	57,3	2,08	62,0	2,47	30	(...)
S 2000.86XLW 020-02-11	BD.. 11T3..	20	5°	33,3	3,65	38,0	4,94	18	(...)
S 2000.86XLW 025-02-11	BD.. 11T3..	25	2,5°	43,3	2,51	48,0	3,15	23	(...)
S 2000.86XLW 032-02-11	BD.. 11T3..	32	1,5°	57,3	2,08	62,0	2,47	30	(...)
S 2000.86XLW 040-02-11	BD.. 11T3..	40	0,7°	73,3	1,28	78,0	1,46	38	(...)
S 2000.86XLW 040-03-11	BD.. 11T3..	40	0,7°	73,3	1,28	78,0	1,46	38	(...)
S 2000.86MW 016-02.11	BD.. 11T3..	16	3°	25,3	1,53	30,0	2,30	14	(...)
S 2000.86MW 020-03.11	BD.. 11T3..	20	5°	33,3	3,65	38,0	4,94	18	(...)
S 2000.86MW 025-03.11	BD.. 11T3..	25	2,5°	43,3	2,51	48,0	3,15	23	(...)
S 2000.86MW 032-04.11	BD.. 11T3..	32	1,5°	57,3	2,08	62,0	2,47	30	(...)
S 2000.86XLMW 018-02-11	BD.. 11T3..	18	3°	29,3	1,86	34,0	2,63	16	(...)
S 2000.86XLMW 020-02-11	BD.. 11T3..	20	5°	33,3	3,65	38,0	4,94	18	(...)
S 2000.86XLMW 020-03-11	BD.. 11T3..	20	5°	33,3	3,65	38,0	4,94	18	(...)
S 2000.86XLMW 022-02-11	BD.. 11T3..	22	2,5°	37,3	2,09	42,0	2,74	20	(...)
S 2000.86XLMW 022-03-11	BD.. 11T3..	22	2,5°	37,3	2,09	42,0	2,74	20	(...)
S 2000.86XLMW 025-02-11	BD.. 11T3..	25	2,5°	43,3	2,51	48,0	3,15	23	(...)
S 2000.86XLMW 025-03-11	BD.. 11T3..	25	2,5°	43,3	2,51	48,0	3,15	23	(...)
S 2000.86XLMW 032-02-11	BD.. 11T3..	32	1,5°	57,3	2,08	62,0	2,47	30	(...)
S 2000.86XLMW 032-03-11	BD.. 11T3..	32	1,5°	57,3	2,08	62,0	2,47	30	(...)
S 2000.88W 040-05.11	BD.. 11T3..	40	0,7°	73,3	1,28	78,0	1,46	38	(...)
S 2000.88W 050-05.11	BD.. 11T3..	50	-	-	-	-	-	-	(...)
S 2000.88W 063-06.11	BD.. 11T3..	63	-	-	-	-	-	-	(...)
S 2000.88W 080-07.11	BD.. 11T3..	80	-	-	-	-	-	-	(...)
S 2000.89W 016-02.11	BD.. 11T3..	16	3°	25,3	1,53	30,0	2,30	14	(...)
S 2000.89W 020-03.11	BD.. 11T3..	20	5°	33,3	3,65	38,0	4,94	18	(...)
S 2000.89W 022-03.11	BD.. 11T3..	22	2,5°	37,3	2,09	42,0	2,74	20	(...)
S 2000.89W 025-03.11	BD.. 11T3..	25	2,5°	43,3	2,51	48,0	3,15	23	(...)
S 2000.89W 028-03.11	BD.. 11T3..	28	1,5°	49,3	1,75	54,0	2,14	26	(...)
S 2000.89W 028-04.11	BD.. 11T3..	28	1,5°	49,3	1,75	54,0	2,14	26	(...)
S 2000.89W 032-04.11	BD.. 11T3..	32	1,5°	57,3	2,08	62,0	2,47	30	(...)
S 2000.89W 035-04.11	BD.. 11T3..	35	1°	63,3	1,55	68,0	1,81	33	(...)
S 2000.89W 035-05.11	BD.. 11T3..	35	1°	63,3	1,55	68,0	1,81	33	(...)

LAVORAZIONE PER INTERPOLAZIONE ELICOIDALE, ESECUZIONE FORI DAL PIENO
HELICAL INTERPOLATION MACHINING, BORES MADE IN THE SOLID BODY

COD.	INSERTO INSERT	ØD	β	Foro cieco Blind hole				foro passante through hole	
				ØD1 min.	f max.	ØD1 max.	f max.	ae	f
S 2000.86W 025-02-17	BD.. 1704..	25	4,5°	40,4	3,81	48,0	5,4	23	(...)
S 2000.86W 032-03-17	BD.. 1704..	32	2,5°	54,4	3,07	62,0	3,9	30	(...)
S 2000.86W 040-04-17	BD.. 1704..	40	2°	70,4	3,33	78,0	4,0	38	(...)
S 2000.86XMLMW 025-02-17	BD.. 1704..	25	4,5°	40,4	3,81	48,0	5,4	23	(...)
S 2000.86XMLMW 032-03-17	BD.. 1704..	32	2,5°	54,4	3,07	62,0	3,9	30	(...)
S 2000.86XMLMW 040-04-17	BD.. 1704..	40	2°	70,4	3,33	78,0	4,0	38	(...)
S 2000.88W 040-04-17	BD.. 1704..	40	2°	70,4	3,33	78,0	4,0	38	(...)
S 2000.88W 050-04-17	BD.. 1704..	50	1,5°	90,4	3,32	98,0	3,8	48	(...)
S 2000.88W 050-05-17	BD.. 1704..	50	1,5°	90,4	3,32	98,0	3,8	48	(...)
S 2000.88W 063-05-17	BD.. 1704..	63	1°	116,4	2,93	124,0	3,3	61	(...)
S 2000.88W 063-06-17	BD.. 1704..	63	1°	116,4	2,93	124,0	3,3	61	(...)
S 2000.88W 080-06-17	BD.. 1704..	80	1°	150,4	3,86	158,0	4,2	78	(...)
S 2000.88W 100-07-17	BD.. 1704..	100	0,5°	190,4	2,48	198,0	2,6	98	(...)
S9002-6W-016-02-11	VDKT 11T2..	16	35°	25,7	8,5	31,0	8,5	30	(...)
S9002-6W-020-02-11	VDKT 11T2..	20	26°	33,7	8,5	39,0	8,5	38	(...)
S9002-6W-025-03-11	VDKT 11T2..	25	19,5°	43,7	8,5	49,0	8,5	48	(...)
S9002-9W-016-02-11	VDKT 11T2..	16	35°	25,7	8,5	31,0	8,5	30	(...)
S9002-9W-020-02-11	VDKT 11T2..	20	26°	33,7	8,5	39,0	8,5	38	(...)
S9002-9W-025-03-11	VDKT 11T2..	25	19,5°	43,7	8,5	49,0	8,5	48	(...)
S9002-8W-042-03-22	VCKT 2205..	42	23°	71,3	15	81,0	15	82	(...)
S9002-8W-052-03-22	VCKT 2205..	52	17°	91,3	15	101,0	15	102	(...)
S9002-8W-066-04-22	VCKT 2205..	66	12,5°	119,3	15	129,0	15	130	(...)
S9002-9W-032-02-22	VCKT 2205..	32	35°	51,3	15	61,0	15	62	(...)
S9002-9W-042-03-22	VCKT 2205..	42	23°	71,3	15	81,0	15	82	(...)
S 9005-6W 032-03-09	TOKX 09T3..	32	1°	61	0,7	64	0,7	30	(...)
S 9005-6W 035-04-09	TOKX 09T3..	35	0,9°	67	0,7	70	0,7	33	(...)
S 9005-6W 040-04-09	TOKX 09T3..	40	0,8°	77	0,7	80	0,7	38	(...)
S 9005-6XLW 032-03-09	TOKX 09T3..	32	1°	61	0,7	64	0,7	30	(...)
S 9005-6XLW 035-04-09	TOKX 09T3..	35	0,9°	67	0,7	70	0,7	33	(...)
S 9005-6XLW 040-04-09	TOKX 09T3..	40	0,8°	77	0,7	80	0,7	38	(...)
S 9005-8W 040-04-09	TOKX 09T3..	40	0,8°	77	0,7	80	0,7	38	(...)
S 9005-8W 050-05-09	TOKX 09T3..	50	0,5°	97	0,7	100	0,7	48	(...)
S 9005-8W 063-06-09	TOKX 09T3..	63	0,5°	123	0,7	126	0,7	61	(...)
S 9005-8W 080-07-09	TOKX 09T3..	80	0,5°	157	0,7	160	0,7	78	(...)
S 9005.8W 100-07-09	TOKX 09T3..	100	0,5°	197	0,7	200	0,7	98	(...)
S 9005-8W 100-09-09	TOKX 09T3..	100	0,5°	197	0,7	200	0,7	98	(...)
S 9005-8W 125-08-09	TOKX 09T3..	125	0,5°	247	0,7	250	0,7	123	(...)
S 9005-8W 125-10-09	TOKX 09T3..	125	0,5°	247	0,7	250	0,7	123	(...)
S 9005-9W 032-03-09	TOKX 09T3..	32	1°	61	0,7	64	0,7	30	(...)
S 9005-9W 035-04-09	TOKX 09T3..	35	0,9°	67	0,7	70	0,7	33	(...)
S 9005-9W 040-04-09	TOKX 09T3..	40	0,8°	77	0,7	80	0,7	38	(...)
S 9006-6W 020-03-06	TNGX 0604..	20	2°	37	1,2	40	1,2	18	(...)
S 9006-6W 025-03-06	TNGX 0604..	25	1,5°	47	1,0	50	1,0	23	(...)
S 9006-6W 025-04-06	TNGX 0604..	25	1,5°	47	1,0	50	1,0	23	(...)

 - PER FORI PASSANTI CALCOLARE f MEDIANTE LA FORMULA DI PAG 1143

 - FOR THROUGH HOLES, CALCULATE f USING THE FORMULA ON PAGE 1143

 - FÜR DURCHGANGLÖCHER IST f ÜBER DIE FORMEL VON SEITE 1143 ZU BERECHNEN

 - EN CAS DE TROUS DE PASSAGE CALCULER f MOYENNANT LA FORMULE PAGE 1143

LAVORAZIONE PER INTERPOLAZIONE ELICOIDALE, ESECUZIONE FORI DAL PIENO
 HELICAL INTERPOLATION MACHINING, BORES MADE IN THE SOLID BODY

S 806/808/809 ... - (INS. RD ..)

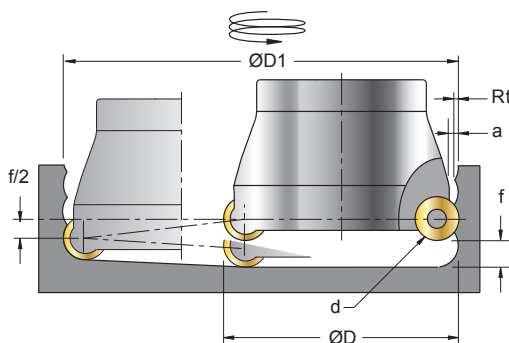

(mm)	d (mm) inserto - insert																	
	05			07T1			0702			10			12			16		
ød	ØD1 min	ØD1 max	f max	ØD1 min	ØD1 max	f max	ØD1 min	ØD1 max	f max	ØD1 min	ØD1 max	f max	ØD1 min	ØD1 max	f max	ØD1 min	ØD1 max	f max
10	11	19	1,5															
12	15	23	2	13	24	1,5												
12,5				14	24	1,5												
15	21	29	2				17	29	2									
16	23	31	2				19	31	3									
20	31	39	2				27	39	3	21	39	2,5						
25	41	49	2				37	49	3	31,5	49	4	27,5	49	3,5			
30							47	59	3	41,5	59	4						
32							51	63	3	45,5	63	4	41,5	63	5	33	63	3
35							57	69	3	51,5	69	4	47,5	69	5			
40										61,5	79	4	57,5	79	5	50	79	6
42										65,5	83	4	61,5	83	5			
48													72,0	95	5			
50													77,5	99	5	70	99	6
52													81,5	103	5	74	103	6
63													103,5	125	5	96	125	6
66													109,5	131	5	102	131	6
80													137,5	159	5	130	159	6
100																170	199	6
125																220	249	6
160																290	319	6

Rt (mm) PROFONDITÀ DELLA RIGATURA
 Rt (mm) GROOVE DEPTH

$$Rt = 0,5 \cdot (\text{ØD} - \sqrt{\text{ØD}^2 - ae^2})$$

(mm)	d (mm) inserto - insert					
	05	07T1	0702	10	12	16
f	(mm)					
	Rt					
1	0,051	0,036	0,036	0,025	0,021	0,016
2	0,209	0,146	0,146	0,101	0,084	0,063
3		0,338	0,338	0,230	0,191	0,142
4				0,417	0,343	0,254
5				0,670	0,546	0,401
6					0,804	0,584
7						0,806
8						1,072
a	1	1	1	1	2	3

LAVORAZIONE A TUFFO OBLIQUA S806 - S808 - S809
 OBLIQUE PLUNGE MACHINING S806 - S808 - S809

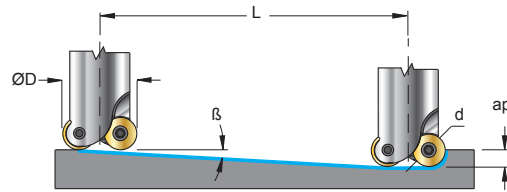

ØD		d=05 ap=2,5	d=07 ap=3,5	d=10 ap=5	d=12 ap=6	d=16 ap=8	
10	β	β = 28,9° L = 4,52					
12		β = 13,8° L = 10,17	β = 22,7° L = 8,36				
12,5			β = 22° L = 8,66				
15		β = 8,6° L = 16,53	β = 20° L = 9,6				
16		β = 7,7° L = 18,5	β = 16,8° L = 11,6				
20		β = 6,9° L = 20,65	β = 11° L = 18	β = 39° L = 6,17			
25		β = 4° L = 35,75	β = 7,3° L = 27,3	β = 14,3° L = 19,6	β = 26° L = 12,3		
30			β = 5,4° L = 37	β = 9,3° L = 30,5			
32			β = 4,9° L = 40,8	β = 8,6° L = 33	β = 14,3° L = 23,5	β = 43° L = 8,57	
35			β = 4,3° L = 46,5	β = 7,3° L = 39	β = 11,9° L = 28,4		
40		L		β = 5,8° L = 49,2	β = 9,3° L = 36,6	β = 14,5° L = 30,9	
42				β = 5,4° L = 52,9	β = 8,3° L = 41,1		
48					β = 6,8° L = 50,3		
50					β = 6,1° L = 56,1	β = 9,5° L = 47,8	
52					β = 5,7° L = 60,1	β = 8,8° L = 51,6	
63					β = 4,3° L = 79,8	β = 7,1° L = 64,2	
66				β = 4,1° L = 83,7	β = 6° L = 76,1		
80				β = 3,2° L = 107,3	β = 4,5° L = 101,6		
100					β = 3,7° L = 123,7		
125					β = 2,8° L = 163,5		
160				β = 1,8° L = 254,5			

Tmax (mm) MASSIMA PROFONDITÀ DI PENETRAZIONE VERTICALE
 Tmax (mm) MAXIMUM DEPTH OF VERTICAL PENETRATION

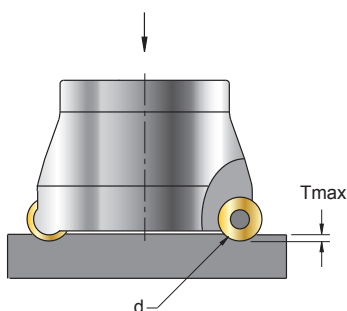

	d (mm) inserto - insert					
	05	07(01)	07(02)	10	12	16
Tmax (mm)	1,2	1,8	1,8	2,6	3,6	4,5

LAVORAZIONE OBLIQUA IN TIRATA S806 - S808 - S809
OBLIQUE BACK MILLING S806 - S808 - S809

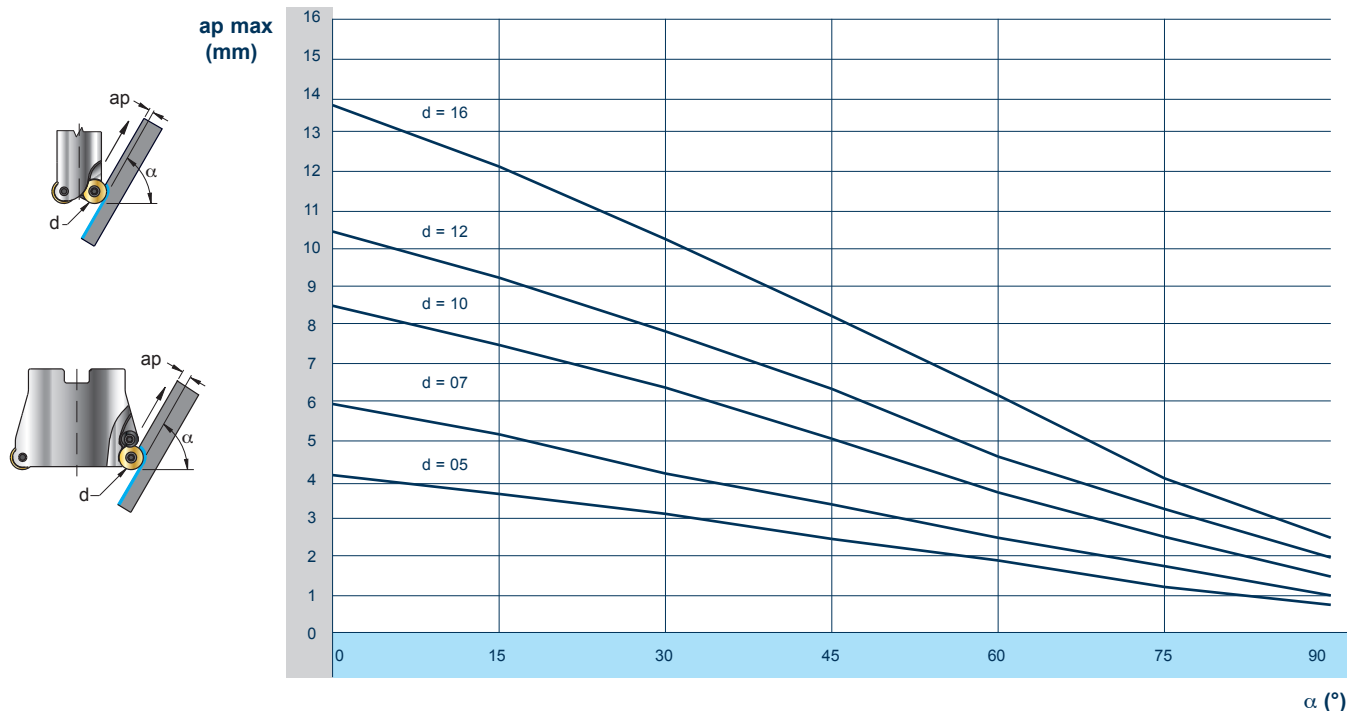

LAVORAZIONE OBLIQUA ØDe (EFFETTIVO)
OBLIQUE DRIVEN MACHINING ØDe (EFFECTIVE)

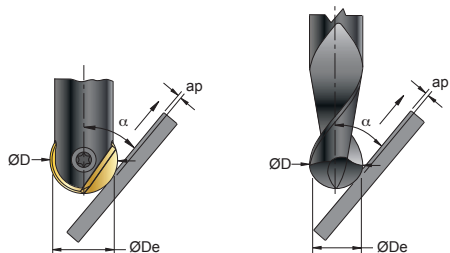

$$\text{ØDe (mm)} = \text{ØD} \cdot \cos \left(\alpha - \arccos \left(\frac{\text{ØD} - 2 \cdot \text{ap}}{\text{ØD}} \right) \right)$$

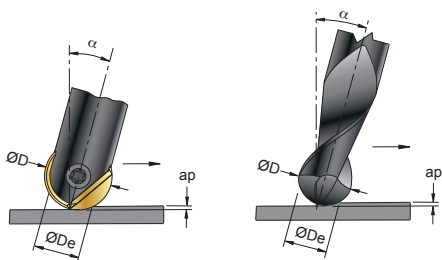

$$\text{ØDe (mm)} = \text{ØD} \cdot \sin \left(\alpha + \arccos \left(\frac{\text{ØD} - 2 \cdot \text{ap}}{\text{ØD}} \right) \right)$$

PER EVITARE LA VELOCITÀ DI TAGLIO $V_c=0$ m/min AL CENTRO FRESA, SI CONSIGLIA DI LAVORARE CON UNA INCLINAZIONE $\alpha=12-15^\circ$

TO AVOID CUTTING SPEED TO THE CENTER OF THE MILLING CUTTER, IS RECOMMENDED TO MACHINING WITH INCLINATION $\alpha=12-15^\circ$

RUGOSITÀ Rmax IN BASE AL PASSO DI FRESATURA
Rmax ROUGHNESS DEPENDS ON MILLING PITCH

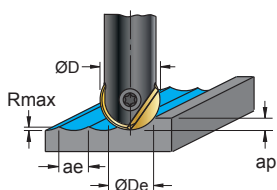

$$R_{\text{max}} = 0,5 \cdot \left(\text{ØD} - \sqrt{\text{ØD}^2 - \text{ae}^2} \right)$$

R (mm)	Rmax (finitura-finishing) (µm)									
	ae (mm)									
	0,1	0,2	0,3	0,4	0,5	0,6	0,7	0,8	0,9	1,0
4	0,3	1,0	3,0	5,0	8,0	11	15	20	25	31
5	0,3	1,0	2,3	4,0	6,3	9,0	12,3	16,0	20,3	25,0
6	0,2	0,8	1,9	3,3	5,2	7,5	10,2	13,3	16,9	20,8
8	0,2	0,6	1,4	2,5	3,9	5,6	7,7	10,0	12,7	15,6
10	0,1	0,5	1,1	2,0	3,1	4,5	6,1	8,0	10,1	12,5
12,5	0,1	0,4	0,9	1,6	2,5	3,6	4,9	6,4	8,1	10,0
15	0,1	0,3	0,8	1,3	2,1	3,0	4,1	5,3	6,8	8,3
16	0,1	0,3	0,7	1,3	2,0	2,8	3,8	5,0	6,3	7,8

**CAMPO D'IMPIEGO S846..W../S848..W../S849..W..
APPLICATION FIELD S846..W../S848..W../S849..W..**

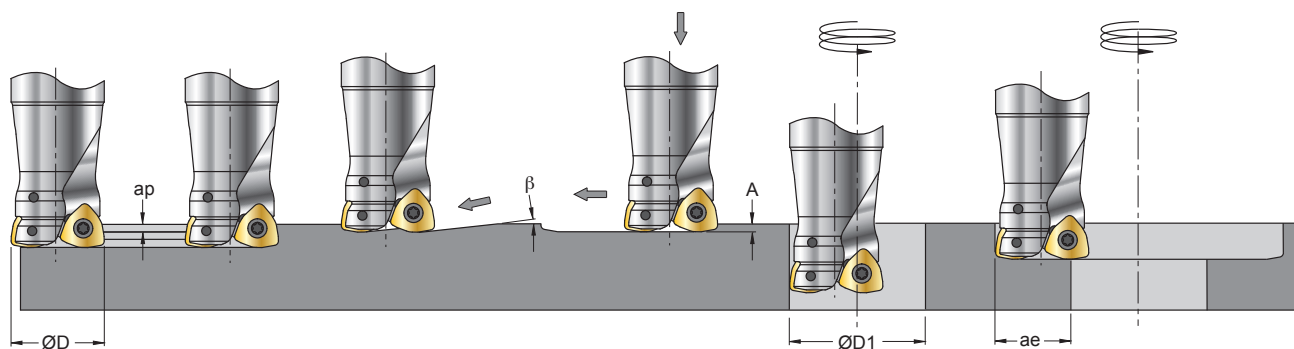

ART.	ØD (mm)	ap max (mm)	β max (°)	A max (mm)	ØD1 min (mm)	ØD1 max (mm)	ae max (mm)
S846LW/XLW 025-06 - S849W 025-06	25	1,5	5°	1,0	33	47	20
S846LW/XLW 026-06 - S849W 026-06	26		4,5°		35	49	21
S846LW/XLW 032-06 - S849W 032-06	32		3,5°		47	61	27
S846LW/XLW 033-06 - S849W 033-06	33		3°		49	63	28
S848W 040-06	40		2°		63	77	35
S846LW/XLW 032-08 - S849W 032-08	32		10°		37	61	26
S846LW/XLW 033-08 - S849W 033-08	33		8°		40	63	27
S846LW/GLW/XLW/GXLW 040-08 - S849W/GW 040-08	40		6°		53	77	34
S848W 050-08	50		4°		72	97	44
S848W 052-08	52		2,5°		76	101	46
S848W 063-08	63				98	123	57
S848W 066-08	66				104	129	60
S848W 080-08	80				132	157	74
S848W 100-08	100		1°		172	197	94

**CAMPO D'IMPIEGO S1502.8W..
APPLICATION FIELD S1502.8W..**

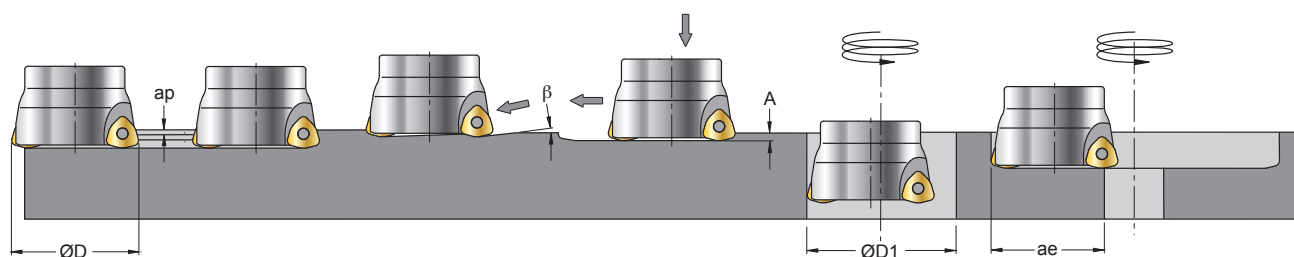

ART.	ØD (mm)	ap max (mm)	β max (°)	A max (mm)	ØD1 min (mm)	ØD1 max (mm)	ae max (mm)
S1502.8W-050-03-14	50	2	4,3	1,5	73	95	43
S1502.8W-050-04-14	50		4,3		73	95	43
S1502.8W-052-03-14	52		4		77	99	45
S1502.8W-052-04-14	52		4		77	99	45
S1502.8W-063-04-14	63		2,7		99	121	56
S1502.8W-063-05-14	63		2,7		99	121	56
S1502.8W-066-04-14	66		2,5		105	127	59
S1502.8W-066-05-14	66		2,5		105	127	59
S1502.8W-080-05-14	80		1,9		133	155	73
S1502.8W-080-06-14	80		1,9		133	155	73

CAMPO D'IMPIEGO S1503..W..
APPLICATION FIELD S1503..W..

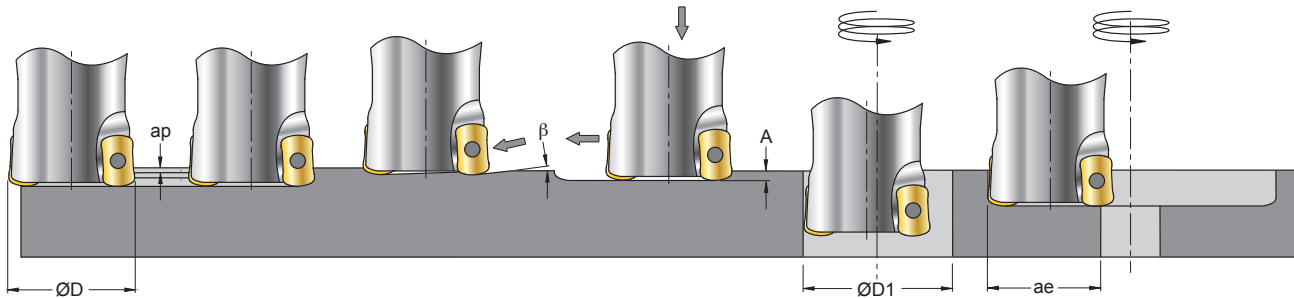

ART.	ØD (mm)	ap max (mm)	β max (°)	A max (mm)	ØD1 min (mm)	ØD1 max (mm)	ae max (mm)
S 1503.6LW-016-02-06	16	1	3,5	0,4	22	30	12,5
S 1503.6LW-018-02-06	18		2,7		26	34	14,5
S 1503.6LW-020-03-06	20		2,3		30	38	16,5
S 1503.6LW-020-04-06	20		2,3		30	38	16,5
S 1503.6LW-022-03-06	22		1,9		34	42	18,5
S 1503.6LW-022-04-06	22		1,9		34	42	18,5
S 1503.6LW-025-04-06	25		1,6		40	48	21,5
S 1503.6LW-025-05-06	25		1,6		40	48	21,5
S 1503.6LW-028-04-06	28		1,3		46	54	24,5
S 1503.6LW-028-05-06	28		1,3		46	54	24,5
S 1503.6LW-030-04-06	30		1,2		50	58	26,5
S 1503.6LW-030-05-06	30		1,2		50	58	26,5
S 1503.6LW-032-05-06	32		1,1		54	62	28,5
S 1503.6LW-032-06-06	32		1,1		54	62	28,5
S 1503.6LW-035-05-06	35		1,0		60	68	31,5
S 1503.6LW-035-06-06	35		1,0		60	68	31,5
S 1503.6LW-040-06-06	40		0,8		70	78	36,5
S 1503.6LW-040-08-06	40		0,8		70	78	36,5
S 1503.8W-040-06-06	40		0,8		70	78	36,5
S 1503.8W-040-08-06	40		0,8		70	78	36,5
S 1503.8W-050-07-06	50		0,6		90	98	46,5
S 1503.8W-050-09-06	50		0,6		90	98	46,5
S 1503.8W-052-07-06	52		0,6		92	100	48,5
S 1503.8W-052-09-06	52		0,6		92	100	48,5
S 1503.8W-063-09-06	63		0,5		103	111	61,5
S 1503.8W-063-11-06	63		0,5		103	111	61,5
S 1503.9W-016-02-06	16		3,5		22	30	12,5
S 1503.9W-018-02-06	18		2,7		26	34	14,5
S 1503.9W-020-03-06	20		2,3		30	38	16,5
S 1503.9W-020-04-06	20		2,3		30	38	16,5
S 1503.9W-022-03-06	22		1,9		34	42	18,5
S 1503.9W-022-04-06	22		1,9		34	42	18,5
S 1503.9W-025-04-06	25		1,6		40	48	21,5
S 1503.9W-025-05-06	25		1,6		40	48	21,5
S 1503.9W-028-04-06	28		1,3		46	54	24,5
S 1503.9W-028-05-06	28	1,3	46	54	24,5		
S 1503.9W-030-04-06	30	1,2	50	58	26,5		
S 1503.9W-030-05-06	30	1,2	50	58	26,5		
S 1503.9W-032-05-06	32	1,1	54	62	28,5		
S 1503.9W-032-06-06	32	1,1	54	62	28,5		
S 1503.9W-035-05-06	35	1,0	60	68	31,5		
S 1503.9W-035-06-06	35	1,0	60	68	31,5		

INDICAZIONI E CONSIGLI PER LA FORATURA CON PUNTE IN METALLO DURO
INSTRUCTIONS AND SUGGESTIONS FOR MACHINING WITH CARBIDE DRILLS

PRESSIONE E PORTATA REFRIGERANTE
COOLANT PRESSURE AND FLOW RATE

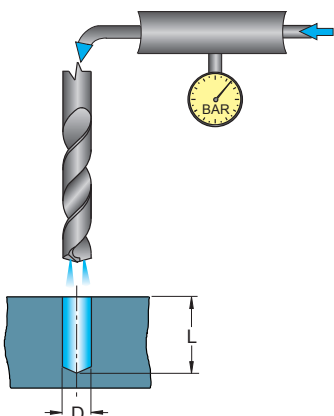

L	Pressione-Pressure		Portata-Flow rate	
	D<5	D>5	D=8	D=16
	BAR/PSI		L/min.	
< 3 X D	20÷30	10÷20	1,5÷3	8÷10
> 3 X D	30÷40	20÷30	2,5÷4	12÷15

- Per forature generiche usare una concentrazione del refrigerante minima del 6-8%.

- Per forature di acciai legati, acciai inox e leghe resistenti al calore, usare una concentrazione minima del refrigerante del 10%.

- For general drilling use a minimum coolant concentration of 6-8%.

- For drilling steel alloys, stainless steel, and heat resistant alloys, use a minimum coolant concentration of 10%.

PRESSIONE/VOLUME DEL REFRIGERANTE PER PUNTE FORATE
COOLANT PRESSURE/VOLUME FOR DRILLS WITH COOLANT BORE

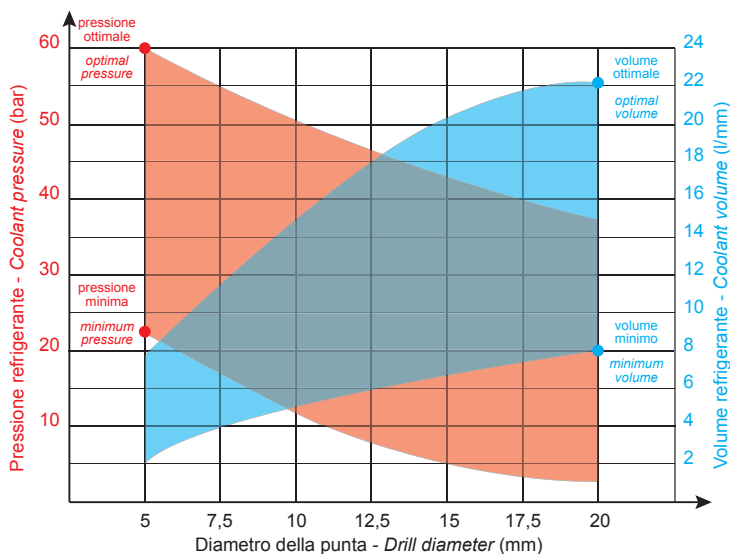

- La pressione del refrigerante è un fattore chiave nella foratura profonda. Valori inadeguati di pressione o volume del refrigerante possono comportare la prematura rottura della punta. È decisamente consigliabile l'uso di refrigerante ad alta pressione. La pressione tipica raccomandata dovrebbe rientrare nel campo 40-70 bar.

- Coolant pressure is a key factor in deep drilling. Inadequate coolant pressure or volume values can lead to premature drill breakage. The use of a high-pressure coolant is highly recommended. The typical recommended pressure should range between 40 and 70 bars.

PROFONDITÀ UTILE DI FORATURA
USEFUL DRILLING DEPTH

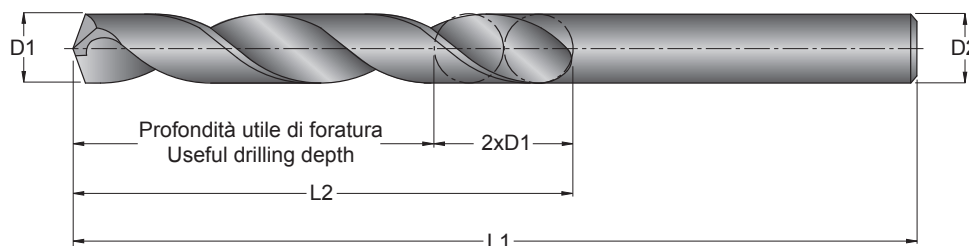

- Per una buona evacuazione del truciolo, la profondità utile di foratura si ricava sottraendo alla lunghezza dell'elica (L2), 2 volte la dimensione del diametro (D1)

- For a good chip evacuation, the best useful drilling depth is calculated by subtracting twice the size of the diameter (D1) from the length of the drill flute (L2)

INDICAZIONI E CONSIGLI PER LA LAVORAZIONE CON PUNTE IN METALLO DURO
INSTRUCTIONS AND SUGGESTIONS FOR MACHINING WITH CARBIDE DRILLS

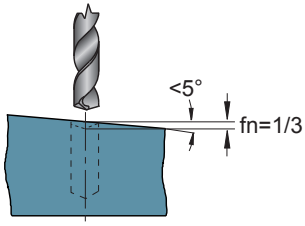

- Per la foratura di superfici inclinate fino a max 5°, diminuire l'avanzamento **fn** ad 1/3 finchè la punta lavora sulla superficie inclinata.

- For drilling surfaces that are tilted up to a maximum of 5°, reduce the feed rate **fn** to 1/3 as long as the drill is machining the tilted surface

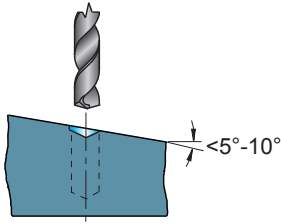

- Per la foratura di superfici inclinate fino a 10° è necessario eseguire prima un'operazione di centratura.

- Superfici con angolo superiore a 10° devono essere prima fresate.

- For drilling surfaces that are tilted up to 10°, it is first necessary to perform a centering operation

- Surfaces tilted by more than 10° must first be milled

(*)

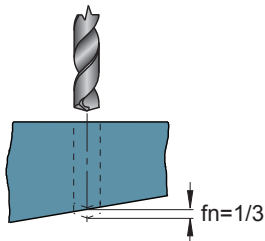

- Per i fori passanti su superfici inclinate diminuire l'avanzamento ad 1/3 nella fase di uscita.

-For through bores on tilted surfaces, reduce the feed rate to 1/3 during the exit phase

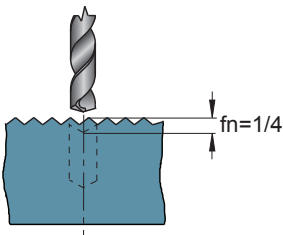

- Per la foratura di superfici irregolari diminuire l'avanzamento ad 1/4 finchè la punta è in fase di entrata.

- For drilling irregular surfaces, reduce the feed rate to 1/4 as long as the drill is entering the material

(*)

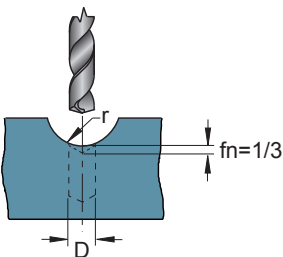

- La foratura di superfici concave è possibile solo se il raggio **r** è maggiore di 15 x D. Ridurre l'avanzamento ad 1/3 finchè la punta è in fase di entrata.

- Drilling concave surfaces is possible only if the radius **r** is greater than 15 x D. Reduce the feed rate to 1/3 as long as the drill is entering the material

(*)

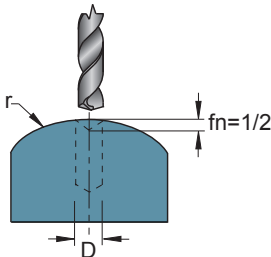

- La foratura di superfici convesse è possibile solo se il raggio **r** è maggiore di 4 x D. Ridurre l'avanzamento ad 1/2 finchè la punta è in fase di entrata.

- Drilling convex surfaces is possible only if the radius **r** is greater than 4 x D. Reduce the feed rate to 1/2 as long as the drill is entering the material

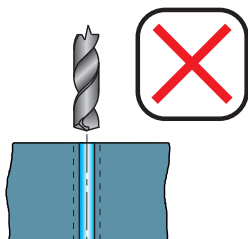

- Non è possibile eseguire l'allargatura di fori preesistenti

- It is not possible to enlarge existing bores

INDICAZIONI E CONSIGLI PER LA LAVORAZIONE CON PUNTE IN METALLO DURO
INSTRUCTIONS AND SUGGESTIONS FOR MACHINING WITH CARBIDE DRILLS

(*)

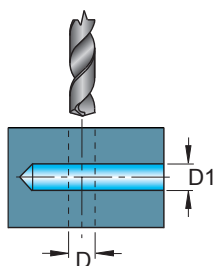

-L' esecuzione di fori trasversali è sconsigliabile, può comunque essere eseguita se il foro **D1** è in asse col foro **D**. Diminuire l'avanzamento a 1/4 durante l'entrata e l'uscita dal foro trasversale.

-It is advisable not to drill transverse bores; however, it is possible to drill these types of bores if bore **D1** is on the same axis as the bore **D**. Reduce the feed rate to 1/4 when entering and exiting the transverse bore

(*)

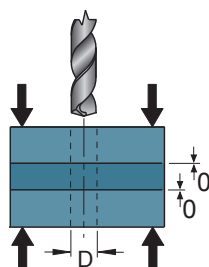

-La foratura di piastre sovrapposte è sconsigliabile, può comunque essere eseguita solo se vengono adottate le seguenti precauzioni:

- 1) assicurarsi che le piastre siano bloccate adeguatamente
- 2) assicurarsi che non ci siano spazi vuoti tra le piastre

-It is advisable not to drill overlapping plates; however, it is possible to perform this type of drilling only if the following precautions are adopted:

- 1) Make sure that the plates are adequately secured.
- 2) Make sure that there are no empty spaces between the plates

(*)

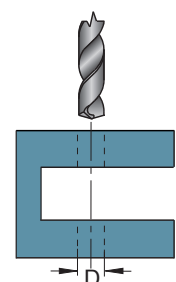

-La foratura di più elementi distanti tra loro è possibile solo con le seguenti punte: SDF0802 - SDF1201

-Combinations of several elements distant from each other can only be drilled with the following drill bits: SDF0802 - SDF1201

Max 0,03 mm

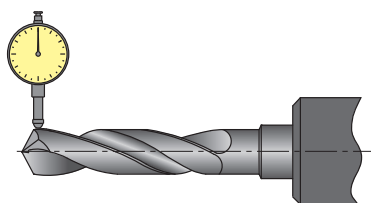

-L' eccentricità massima non deve mai superare 0,02 mm e nelle Micropunte non deve mai superare 0,01 mm

-Maximum eccentricity must never exceed 0.02 mm and for micro-drills it must never exceed 0,01mm

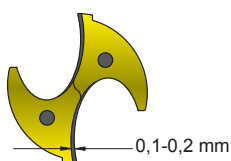

-Si consiglia di interrompere la foratura quando si raggiunge una usura massima sul tagliente di 0,2 mm

-It is recommended to stop boring when a maximum wear of 0.2 mm on the cutting edge is achieved

(*)

IN QUESTE LAVORAZIONI SI CONSIGLIA DI USARE LE PUNTE: SDF0802 - SDF1201
 FOR THESE APPLICATIONS SDF0802 - SDF1201 TYPES ARE RECOMMENDED

INDICAZIONI E CONSIGLI PER LA LAVORAZIONE CON PUNTE M.D.I. \geq 12XD
INSTRUCTIONS AND SUGGESTIONS FOR MACHINING WITH HM DRILLS \geq 12XD



- Fase 1.

Eeguire Preforo con punta "PILOTA" 3xD [SDF0371].

- Phase 1

Make the pre-bore with the "PILOT" 3XD drill [SDF0371].

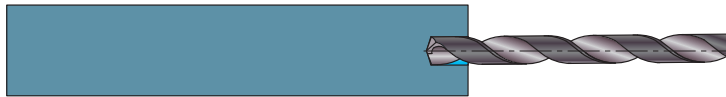

- Fase 2.

Entrare nel Preforo con la punta extralunga ad un numero di giri limitato (\approx 500 giri/min) e un avanzamento ridotto (\approx 1000 mm) fino a circa 1mm dalla fine del Preforo. Successivamente aprire la refrigerazione e aumentare il numero di giri.

- Phase 2

Enter the pre-bore with an extra-long drill at a limited speed (\approx 500 rpm) and with reduced feed (\approx 1000 mm) up to about 1mm from the end of the pre-bore. Afterwards open the refrigeration and increase the speed.

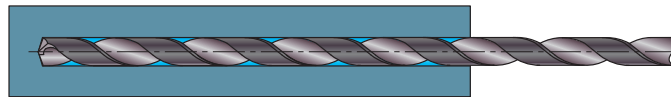

- Fase 3.

Eeguire la foratura profonda con avanzamento adeguato fino alla fine del foro, senza step di uscita per lo scarico del truciolo.

- Phase 3

Perform the plunge drilling with adequate feed up to the end of the bore without the outlet step for chip discharge



- Fase 4.

Raggiunta la fine del foro stabilito, ritrarre la punta di 1mm, ridurre il numero di giri (\approx 500 giri/min), uscire completamente dal foro ad un avanzamento ridotto (\approx 2000 mm), chiudere la refrigerazione.

- Phase 4

When the end of the set bore is reached, retract the bit 1mm, reduce the speed (\approx 500 rpm), come completely out of the bore at a reduced feed (\approx 2000 mm), and close the refrigeration

SIGLE E FORMULE GENERALI
GENERAL ACRONYMS AND FORMULS

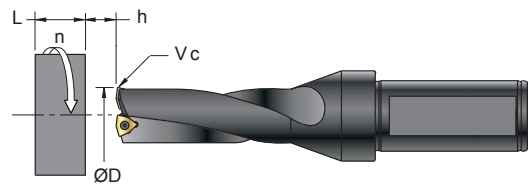
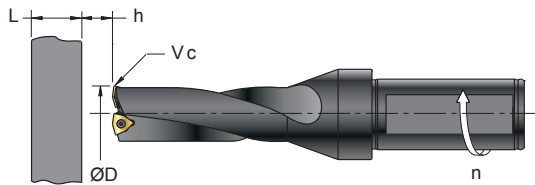

- At** (mm²) = AREA DEL FORO
- ØD** (mm) = DIAMETRO DELLA PUNTA
- f** (mm) = AVANZAMENTO AL GIRO
- Ff** (N) = SPINTA ASSIALE
- h** (mm) = DISTANZA DI AVVICINAMENTO
- Kc** (N/mm²) = FORZA DI TAGLIO SPECIFICA
- L** (mm) = PROFONDITÀ DI FORATURA
- Mc** (Nm) = COPPIA , MOMENTO TORCENTE
- n** (giri/min - min⁻¹) = NUMERO DI GIRI AL MINUTO
- Pc** (KW) = POTENZA ASSORBITA
- Q** (cm³/min) = VOLUME DEL TRUCIOLO ASPORTATO
- Tc** (min) = TEMPO DI FORATURA
- Vc** (m/min) = VELOCITÀ DI TAGLIO
- Vf** (mm/min) = VELOCITÀ DI AVANZAMENTO
- η (0,7-0,85) = RENDIMENTO MECCANICO DELLA MACCHINA



- = BORE AREA
- = DRILL DIAMETER
- = FEED / REV.
- = AXIAL THRUST
- = DISTANCE OF APPROACH
- = SPECIFIC CUTTING FORCE
- = DRILLING DEPTH
- = TORQUE
- = NUMBER OF REVOLUTIONS / MIN
- = ABSORBED POWER
- = VOLUME OF CHIP REMOVED
- = DRILLING TIME
- = CUTTING SPEED
- = FEED RATE
- = MECHANICAL EFFICIENCY OF THE MACHINE

$$Vc \text{ (m/min)} = \frac{\text{ØD} \cdot 3,14 \cdot n}{1000}$$

$$n \text{ (giri/min - min}^{-1}\text{)} = \frac{Vc \cdot 1000}{\text{ØD} \cdot 3,14}$$

$$Vf \text{ (mm/min)} = f \cdot n$$

$$Q \text{ (cm}^3\text{/min)} = \frac{Vf \cdot At}{1000}$$

$$At \text{ (mm}^2\text{)} = \frac{3,14 \cdot \text{ØD}^2}{4}$$

$$Tc \text{ (min)} = \frac{L + h}{Vf}$$

$$Pc \text{ (KW)} = \frac{Q}{60 \cdot 1000 \cdot \eta} \cdot Kc \cdot \sin K$$

$$Mc \text{ (Nm)} = \frac{f \cdot Kc}{1000} \cdot \frac{\text{ØD}^2}{8} \cdot \sin K$$

$\sin K = 1$ (k=90°) PUNTE A INSERTI - INSERT DRILLS
 $\sin K = 0,91$ (k=70°) PUNTE INTEGRALI - CARBIDE DRILLS

$$Ff \text{ (N)} \approx 0,7 \cdot \frac{\text{ØD}}{2} \cdot f \cdot kc \cdot \sin K \quad \text{APPROSSIMATA - APPROXIMATE}$$

FORZA SPECIFICA DI TAGLIO **Kc** PER GRUPPO DI MATERIALE (APPROSSIMATA)
 SPECIFIC CUTTING FORCE (**Kc**) FOR MATERIAL GROUP (APPROXIMATE)

GR.	Kc	GR.	Kc	GR.	Kc	GR.	Kc	GR.	Kc
1	1690	10	2600	15	1440	21	880	31	3250
2	1900	11	3060	16	1630	22	880	32	4130
3	1900	12	2340	17	1530	23	880	33	4020
4	2090	13	2340	18	1690	24	880	34	4130
5	2090	14,1	2690	19	1650	25	880	35	4130
6	1900	14,2	2690	20	1780	26	880		
7	2200					27	880		
8	2500					28	880		
9	2800								

DISASSAMENTO TEORICO PER PUNTE AD INSERTI (CONSIGLIATO SOLO PER LAVORAZIONI SU TORNO)
THEORETICAL OFFSET FOR INSERT DRILLS (RECOMMENDED ONLY FOR LATHE MACHINING)

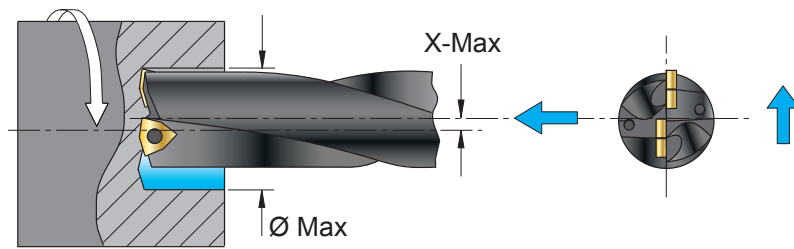

ØD	TDC X max	Ø max	TDBC X max	Ø max	SDQ X max	Ø max	ØD	TDC X max	Ø max	TDBC X max	Ø max	SDQ X max	Ø max
13	-	-	-	-	-	-	32,5	3,10	38,70	-	-	0,50	33,50
14	-	-	-	-	-	-	33	3,00	39,00	-	-	0,40	33,80
15	-	-	-	-	1,20	17,40	33,5	2,90	39,3	-	-	0,25	34,00
15,5	-	-	-	-	1,10	17,70	34	2,80	39,60	-	-	0,10	34,20
16	-	-	-	-	0,90	17,80	34,5	2,65	39,8	-	-	1,60	37,70
16,5	-	-	-	-	0,80	18,10	35	2,50	40,00	-	-	1,50	38,00
17	-	-	-	-	0,70	18,40	35,5	2,40	40,30	-	-	1,35	38,20
17,5	1,50	20,50	-	-	0,60	18,70	36	2,30	40,60	-	-	1,30	38,60
18	1,40	20,80	-	-	0,50	19,00	36,5	2,15	40,80	-	-	1,10	38,70
18,5	1,30	21,10	-	-	0,30	19,10	37	2,00	41,00	-	-	0,90	38,80
19	1,20	21,40	2,50	24,00	0,20	19,40	37,5	1,90	41,30	-	-	0,80	39,10
19,5	1,10	21,70	-	-	0,10	19,70	38	1,80	41,60	5,00	48,00	0,70	39,40
20	1,00	22,00	-	-	1,10	22,20	38,5	1,65	41,80	-	-	0,60	39,70
20,5	0,80	22,10	-	-	1,05	22,60	39	1,50	42,00	-	-	0,50	40,00
21	1,60	24,20	-	-	1,00	23,00	39,5	1,35	42,2	-	-	0,35	40,20
21,5	1,55	24,60	-	-	0,75	23,00	40	1,20	42,40	-	-	2,70	45,40
22	1,50	25,00	-	-	0,60	23,20	41	1,00	43,00	-	-	2,45	45,90
22,5	1,35	25,20	-	-	0,50	23,50	42	4,20	50,40	-	-	2,10	46,20
23	1,25	25,50	-	-	0,35	23,70	43	4,00	51,00	-	-	1,90	46,80
23,5	1,15	25,80	-	-	1,40	26,30	44	3,70	51,40	-	-	1,70	47,40
24	1,00	26,00	3,00	30,00	1,35	26,70	45	3,50	52,00	-	-	1,50	48,00
24,5	0,90	26,30	-	-	1,20	26,90	46	3,30	52,60	-	-	1,20	48,40
25	0,80	26,60	-	-	1,10	27,20	47	3,00	53,00	-	-	0,90	48,80
25,5	0,40	26,30	-	-	0,90	27,30	48	2,70	53,40	3,00	54,00	0,70	49,40
26	2,50	31,00	-	-	0,80	27,60	49	2,50	54,00	-	-	0,40	49,80
26,5	2,35	31,20	-	-	0,60	27,70	50	2,20	54,40	-	-	3,70	57,40
27	2,20	31,40	-	-	0,50	28,00	51	2,00	55,00	-	-	3,40	57,8
27,5	2,15	31,80	-	-	0,40	28,30	52	1,80	55,60	-	-	3,10	58,20
28	2,10	32,20	-	-	0,25	28,50	53	1,50	56,00	-	-	2,80	58,60
28,5	2,00	32,50	-	-	0,15	28,80	54	1,20	56,40	-	-	2,60	59,20
29	1,80	32,60	-	-	0,10	29,20	55	0,80	56,60	-	-	2,40	59,80
29,5	1,65	32,80	-	-	0,00	29,50	56	0,60	57,20	-	-	2,20	60,40
30	1,50	33,00	4,00	38,00	1,10	32,20	57	0,50	58,00	-	-	2,00	61,00
30,5	1,10	32,70	-	-	0,95	32,40	58	0,40	58,80	-	-	1,70	61,40
31	3,50	38,00	-	-	0,90	32,80	59	0,00	-	-	-	1,50	62,00
31,5	3,30	38,10	-	-	0,75	33,00	60	-	-	-	-	1,10	62,20
32	3,20	38,40	-	-	0,60	33,20							

QUANDO SI UTILIZZANO LE PUNTE DISASSATE OCCORRE DIMINUIRE L'AVANZAMENTO ANCHE FINO AL 30-50%

WHEN OFFSET DRILLS ARE USED, IT IS NECESSARY TO REDUCE FEED RATE BY UP TO 30-50%.

INDICAZIONI E CONSIGLI PER LA LAVORAZIONE CON PUNTE AD INSERTI
INSTRUCTIONS AND SUGGESTIONS FOR MACHINING USING INSERT DRILLS

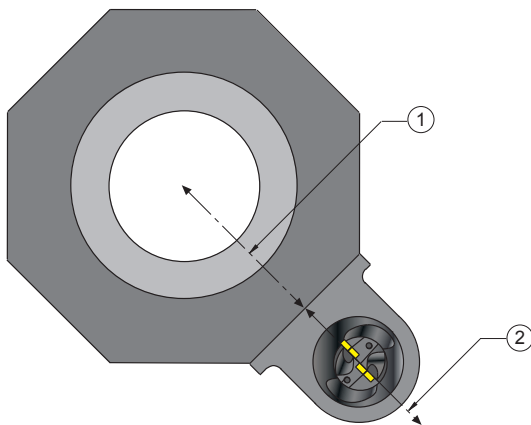

-È indispensabile che il piano 2, sul quale si trovano gli inserti della punta, sia parallelo al piano 1, sul quale si muove la torretta del tornio

-It is absolutely necessary for surface 2, on which the drill inserts are located, to be parallel to surface 1, on which the lathe turret moves

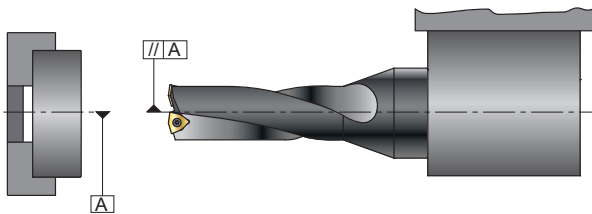

-È indispensabile che sul tornio l'asse della punta e quello del pezzo siano coassiali

-It is absolutely necessary for the drill axis and the workpiece axis to be coaxial on the late

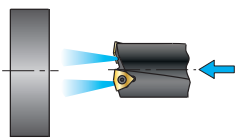

-Per forature con profondità maggiore di $1x \text{ } \varnothing D$ è indispensabile il liquido refrigerante dall' interno della punta

-For bores that are deeper than $1x \text{ } \varnothing D$, it is absolutely necessary for the cutting fluid to be fed through the drill

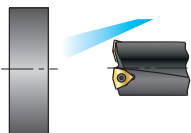

-Con il liquido refrigerante all' esterno della punta è possibile eseguire una lunghezza di foratura max pari a $1x \text{ } \varnothing D$

-When the cutting fluid is outside of the drill, it is possible to achieve a maximum bore length of $1x \text{ } \varnothing D$

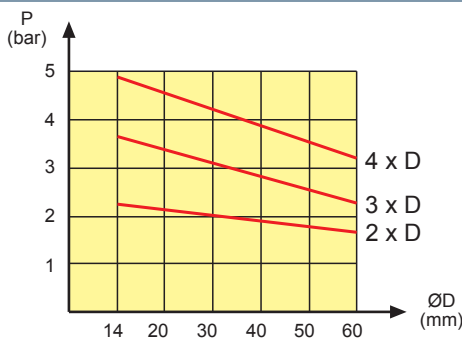

-P = Pressione liquido refrigerante
 -P = Coolant Pressure

-Q = Portata liquido refrigerante
 -Q = Coolant flow rate

-Nelle tabelle sono riportati valori orientativi per lavorazioni in orizzontale
 -Reference values for horizontal machining are indicated in the tables

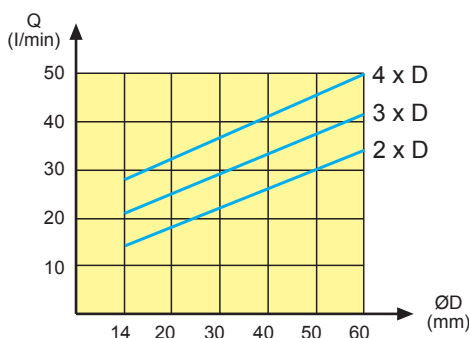

-Per lavorazioni in verticale aumentare i valori del 30-40%
 -For vertical machining the values should be increased by 30-40%

-Se la rottura del truciolo è buona si possono diminuire i valori del 30-40%
 -If chip breakage is good it is possible to reduce the values by 30-40%

-Se la rottura del truciolo non è buona si consiglia di aumentare i valori del 30-50%
 -If chip breakage is not good it is recommended to increase the values by 30-50%

INDICAZIONI E CONSIGLI PER LA LAVORAZIONE CON PUNTE AD INSERTI
 INSTRUCTIONS AND SUGGESTIONS FOR MACHINING USING INSERT DRILLS

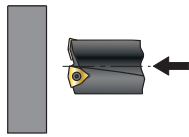

-Piano pari condizione ottimale
 -Level surface, optimum condition

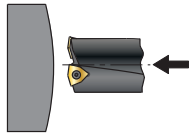

-Piano convesso condizione sufficiente
 -Convex surface, adequate condition

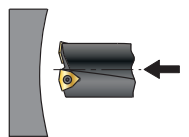

-Piano concavo condizione precaria, diminuire l' avanzamento del 30/50%
 -Surface concave, precarious condition; reduce feed rate by 30-50%

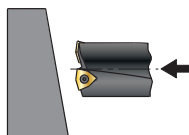

-Piano inclinato in entrata condizione precaria, diminuire l' avanzamento del 30/50%
 -Surface tilted at inlet, precarious condition; reduce feed rate by 30-50%

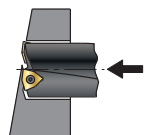

-Piano inclinato in uscita condizione precaria, diminuire l' avanzamento del 30/50%
 -Surface tilted at outlet, precarious condition; reduce feed rate by 30-50%

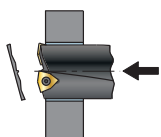

-In tornitura, nelle forature passanti, si genera un dischetto che può essere proiettato ad alta velocità, assicurarsi che vi siano adeguate protezioni per l'operatore.
 -When making through bores during turning, a small disk is formed which might be ejected at high speeds; make sure that the operator is adequately protected.

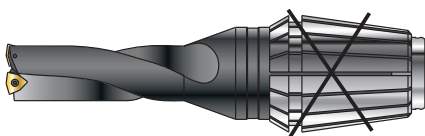

-Occorre che il bloccaggio della punta sia sicuro, sono quindi sconsigliate prese con pinze elastiche tipo ER.
 -It is necessary for the drill to be held securely in place; therefore, ER type elastic clamps are not recommended

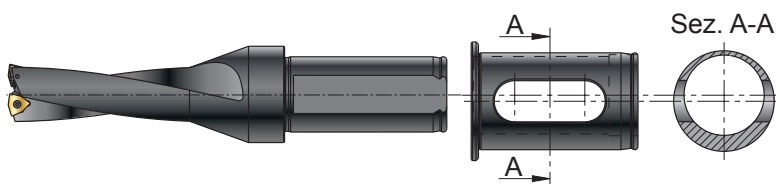

- Le punte **TDC - SDQ** si possono usare su macchine con punta rotante e pezzo fermo, con boccole per disassamento: ART. BPUH... e BECR..
 - Le punte possono essere disassate a -0,1 e +0,3mm con BPUH..
 - Le punte possono essere disassate con regolazione da -0,2 a +0,4 con BECR..
 - **TDC, SDQ**, drills can be used on machines with rotating drill and stationary workpiece, with offset bushings: part no. BPUH and BECR
 - The drills, can be offset to -0.1 and +0.3mm with BPUH..
 - The drills, can be offset with adjustment from -0,2 to +0,4 with BECR..

PUNTE CON DOPPIO PIANO DI BLOCCAGGIO
DRILLS WITH DOUBLE CLAMPING PLANE

FIG.1

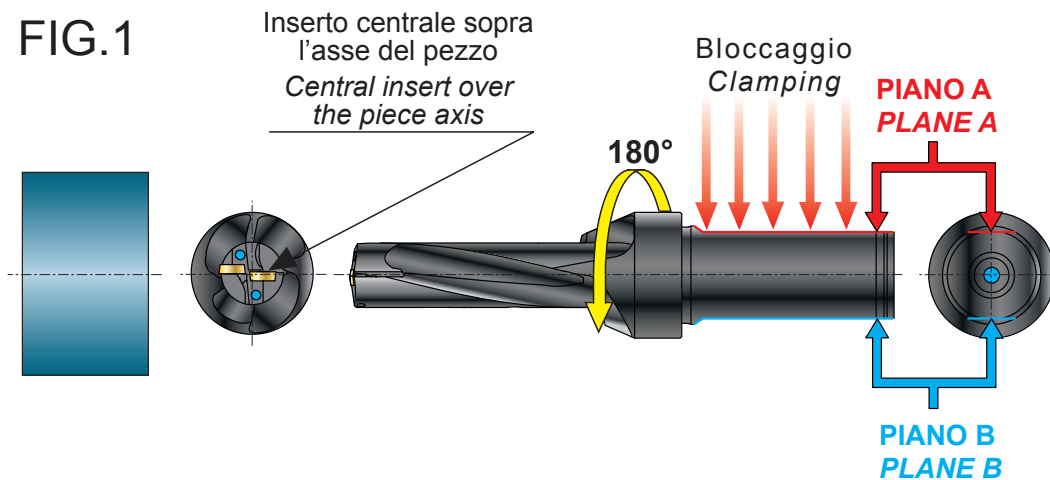
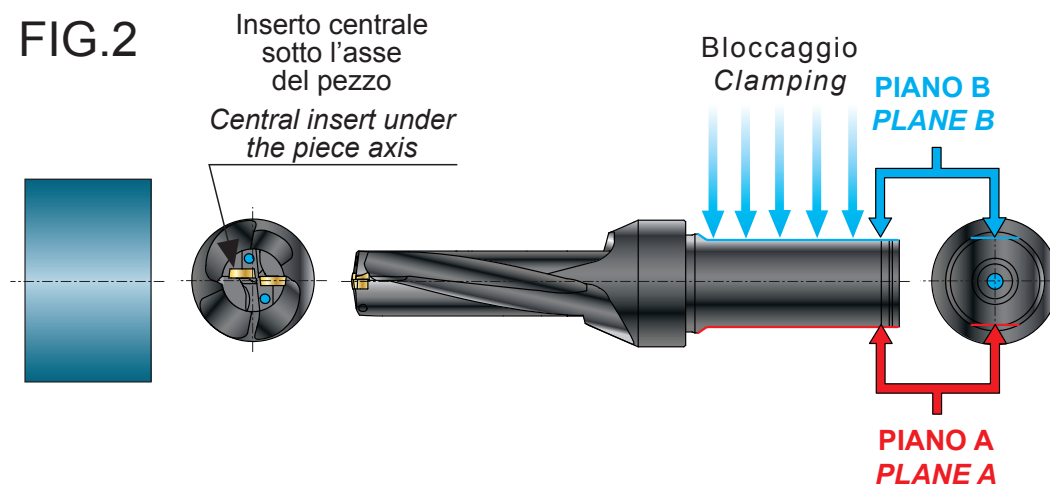

FIG.2



NEL CASO DI FUNZIONAMENTO NON OTTIMALE DELLA PUNTA (ES.FIG1), GIRARLA DI 180°, IN MODO DA CAMBIARE PIANO DI BLOCCAGGIO (ES.FIG2).

IN CASE OF IMPERFECT OPERATION OF THE DRILL (EX.FIG1), TURN IT BY 180° SO AS TO CHANGE THE CLAMPING PLANE (EX.FIG2).

UTENSILI MULTIUSO FORANTI: PRINCIPALI APPLICAZIONI
ALL PURPOSE DRILLING TOOLS: MAIN APPLICATIONS

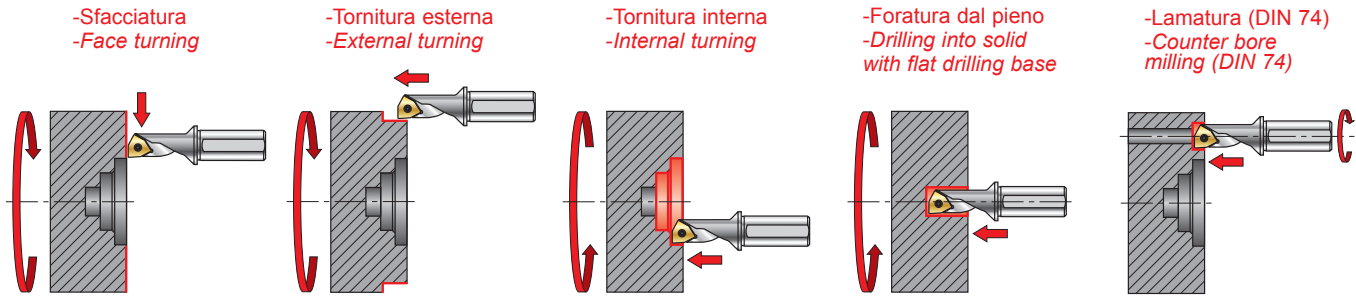

-Cinque lavorazioni, un unico utensile

Questo utensile universale per tornire e forare sostituisce fino a 5 utensili ISO e riduce i tempi di lavorazione fino al 30% con conseguente risparmio a livello di tempi di sostituzione dell'utensile ed inutili movimentazione dello stesso.

-Five machining operations, one tool

The universal turning-drilling-tool substitutes up to 5 ISO-tools and reduces machining times up to 30% through saving of tool changing times and unnecessary tool movements.

UTENSILI MULTIUSO FORANTI: UTILIZZO TAGLIANTE SECONDARIO
ALL PURPOSE DRILLING TOOLS: SECONDARY CUTTING EDGE CAN BE USED

-Foratura disassata, disassamento positivo
 -Drilling off center, positive offset

-Foratura disassata, disassamento negativo
 -Drilling off center, negative offset

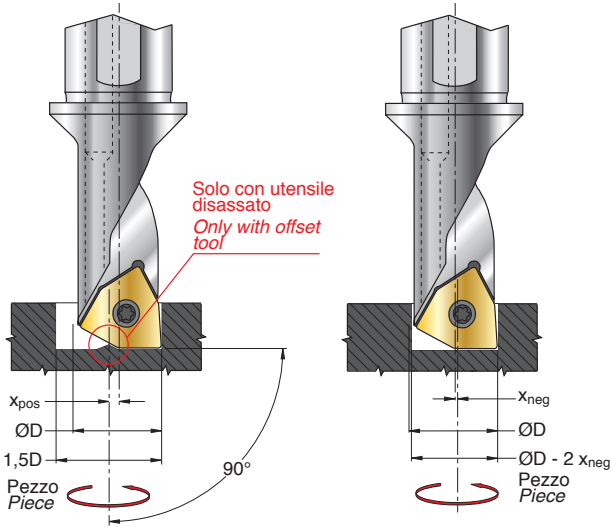

-Smussatura interna
 -Internal chamfering

-Smussatura esterna
 -External chamfering

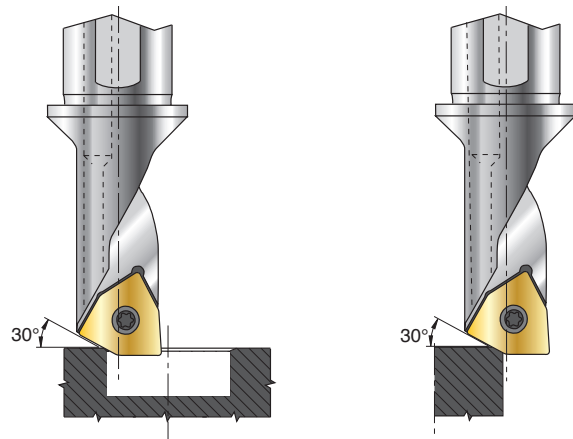

- Operazioni eseguibili solo in tornitura
 - Operations possible only in turning

X_{pos} = DISASSAMENTO POSITIVO
 OFFSET, POSITIVE

$$X_{pos} = \frac{(1,1 \cdot \text{ØD}) - \text{ØD}}{2}$$

ØD = DIAMETRO NOMINALE UTENSILE
 NOMINAL TOOL DIAMETER

$$X_{pos} = \frac{(1,5 \cdot \text{ØD}) - \text{ØD}}{2}$$

X_{neg} = DISASSAMENTO NEGATIVO
 OFFSET, NEGATIVE

$$X_{neg} = \frac{\text{ØD}_{min} - \text{ØD}}{2}$$

ØD = DIAMETRO NOMINALE UTENSILE
 NOMINAL TOOL DIAMETER

ART.	ØD^{H13}	Acciaio Steel		Alluminio Aluminium	
		ØD_{max}	X_{pos}	ØD_{max}	X_{pos}
SMT 08.. 04R/L	8	8,8	0,40	12,0	2,00
SMT 10.. 05R/L	10	11,0	0,50	15,0	2,50
SMT 11.. 06R/L	11	12,1	0,55	16,5	2,75
SMT 15.. 07R/L	15	16,5	0,75	22,5	3,75
SMT 18.. 09R/L	18	19,8	0,90	27,0	4,50
SMT 20.. 10R/L	20	22,0	1,00	30,0	5,00
SMT 26.. 13R/L	26	28,6	1,30	39,0	6,50

ART.	ØD^{H13}	ØD_{min}	X_{neg}
SMT 08.. 04R/L	8	7,8	0,10
SMT 10.. 05R/L	10	9,8	0,10
SMT 11.. 06R/L	11	10,8	0,10
SMT 15.. 07R/L	15	14,7	0,15
SMT 18.. 09R/L	18	17,7	0,15
SMT 20.. 10R/L	20	19,7	0,15
SMT 26.. 13R/L	26	25,7	0,15

UTENSILI MULTIUSO FORANTI: CARATTERISTICHE E VANTAGGI
ALL PURPOSE DRILLING TOOLS: FEATURES AND BENEFITS

SVASATURA CON UTENSILI MULTIUSO FORANTI

I diametri degli utensili multiuso foranti sono studiati per realizzare svasature secondo la norma DIN 74 nelle forme:
 H3, J3 e K3 in un'unica operazione

Forma H3 per: viti a testa cilindrica secondo DIN 84
 viti ad esagono incassato secondo DIN 7984
 viti a testa cilindrica secondo DIN 7513 forma B
 viti a testa cilindrica secondo DIN 7500 parte1 forma A

Forma J3 per: viti ad esagono incassato secondo DIN 6912
 (testa della vite bassa)

Forma K3 per: vite ad esagono incassato secondo DIN 912

*** Con fermadado secondo DIN 7980**

CORE DRILLING WITH ALL PURPOSE DRILLING TOOLS

The diameters of the pentatek-tools are designed to produce counter-bores accordino to DIN 74 forms:
 H3, J3 and K3 in one operation

Form H3 for: Cheese-head screws accordino to DIN 84
 Socket head cap screws to DIN 7984
 Cheese-head screws accordino to DIN 7513 form B
 Cheese-head screws accordino to DIN 7500 part1 form A

Form J3 for: Socket head cap screws accordino to DIN 6912
 (low screw head, key guide)





Form K3 for: Socket head cap screws accordino to DIN 912

*** With lock washer according to DIN 7980**

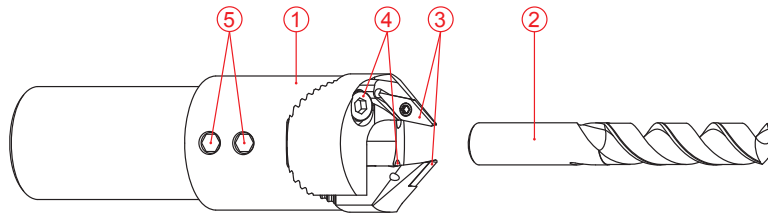
ART.	Filetto Diametro Nominale Thread nominal diameter	ØD	H13
SMT 08.. 04R/L	M4	8	0/+0,220
SMT 10.. 05R/L	M5	10	0/+0,220
SMT 11.. 06R/L	M6	11	0/+0,270
SMT 15.. 07R/L	M8	15	0/+0,270
SMT 18.. 09R/L	M10	18	0/+0,330
SMT 20.. 10R/L	M12	20	0/+0,330
SMT 26.. 13R/L	M16	26	0/+0,330





Schema di montaggio SMU.C...10W - SMU.C...10W assembly scheme - Montageschema SMU.C...10W - Schéma de montage SMU.C...10W

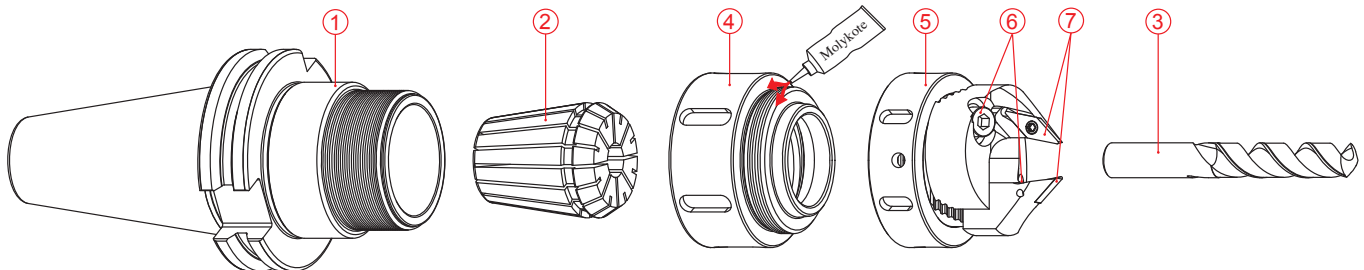

-  - Inserire la punta (2) nel corpo dello smussatore SMU.C...10W (1)
- Avvicinare gli inserti (3) alla punta (2)
- Posizionare il vertice inserto dello smussatore a 2/3 del dorso dell'elica della punta dal filo tagliente (vedi immagine Pag.674)
- Accostare gli inserti (3) al dorso della punta (2) e serrare le viti (4)
- Serrare i grani (5) per bloccare la punta (3)
-  - Insert the drill (2) in the body of chamferer SMU.C...10W (1)
- Bring the inserts (3) close to the drill (2)
- Place the top of the chamferer insert at 2/3 of the drill pitch flank from the cutting edge (refer to the figure on p. .674)
- Place the inserts (3) on the flank of the drill (2) and tighten the screws (4)
- Tighten the grub screws (5) to lock the drill (3) in place
-  - Bohrer (2) in den Körper des Abschrägwerkzeugs SMU.C...10W (1) einsetzen
- Wendeschneidplatten (3) an den Bohrer (2) annähern
- Spitze der Ansträg-Wendeschneidplatte auf 2/3 des Schraubenrückens des Bohrers ab der Schneidkante positionieren (siehe Abbildung Seite .674)
- Wendeschneidplatten (3) an den Rücken des Bohrers (2) annähern und die Schrauben (4) anziehen
- Stifte (5) anziehen, um den Bohrer (3) zu blockieren
-  - Insérer la pointe (2) dans le corps du dispositif de biseautage SMU.C...10W (1)
- Rapprocher les plaquettes (3) de la pointe (2)
- Positionner le sommet de la plaquette du dispositif de biseautage à 2/3 du dos de l'hélice de la pointe à partir du fil tranchant (voir image Pages.674)
- Approcher les plaquettes (3) du dos de la pointe (2) et serrer les vis (4)
- Serrer les goujons (5) pour bloquer la pointe (3)

Schema di montaggio SMU.ER...10 - SMU.ER...10 assembly scheme - Montageschema SMU.ER...10 - Schéma de montage SMU.ER...10



-  - Inserire la pinza (2) nella ghiera (4)
- Inserire la punta (3) nella pinza (2) e serrare la ghiera (4) nel mandrino ..ER.. (1)
- Avvitare la parte con le lame porta-inserto (5) nella ghiera (4) e applicare il Molycote sul filetto
- Avvicinare gli inserti (7) alla punta (3)
- Posizionare il vertice inserto dello smussatore a 2/3 del dorso dell'elica della punta dal filo tagliente (vedi immagine Pag.675)
- Serrare la ghiera (5) tenendo ferme le lame porta inserto.
- Accostare gli inserti (7) alla punta (3) e stringere le viti (6)
-  - Insert the collet (2) in the ring nut (4)
- Insert the drill (3) in the collet (2) and tighten the ring nut (4) in the ..ER.. chuck (1)
- Screw the part with the insert holder blades (5) in the ring nut (4) and apply some Molycote on the thread
- Bring the inserts (7) close to the drill (3)
- Place the top of the chamferer insert at 2/3 of the drill pitch flank from the cutting edge (refer to the figure on p. 675)
- Tighten the ring nut (5) while keeping the insert holder blades still.
- Place the inserts (7) on the drill (3) and tighten the screws (6)
-  - Spannzange (2) in die Nutmutter (4) einsetzen
- Bohrer (3) in die Spannzange (2) einsetzen und die Nutmutter (4) im Dorn ..ER.. (1) anziehen
- Den Teil mit den Wendeschneidplattenhalter-Schwertern (5) in der Nutmutter (4) anschrauben und das Molycote auf das Gewinde auftragen
- Wendeschneidplatten (7) an den Bohrer (3) annähern
- Spitze des Ansträg-Wendeschneidplatten auf 2/3 des Schraubenrückens des Bohrers ab der Schneidkante positionieren (siehe Abbildung Seite 675)
- Nutmutter (5) anziehen und dabei die Wendeschneidplattenhalter- Schwerter festhalten.
- Wendeschneidplatten (7) an den Bohrer (3) herantführen und die Schrauben (6) anziehen
-  - Insérer la pince (2) dans la bague (4)
- Insérer la pointe (3) dans la pince (2) et serrer la bague (4) dans le mandrin ..ER.. (1)
- Visser la partie avec les lames porte-plaquette (5) dans la bague (4) et appliquer le Molycote sur le filet
- Rapprocher les plaquettes (7) de la pointe (3)
- Positionner le sommet de la plaquette du dispositif de biseautage à 2/3 du dos de l'hélice de la pointe à partir du fil tranchant (voir image Pages 675)
- Serrer la bague (5) en tenant les lames porte-plaquette fixes.
- Approcher les plaquettes (7) de la pointe (3) et serrer les vis (6)

Ingombri smussatori SMU.C..10W - Overall sizes chamfering tools SMU.C..10W
 Aussenabmessungen abschrägwerkzeuge SMU.C..10W - Encombremets chanfreineurs SMU.C..10W

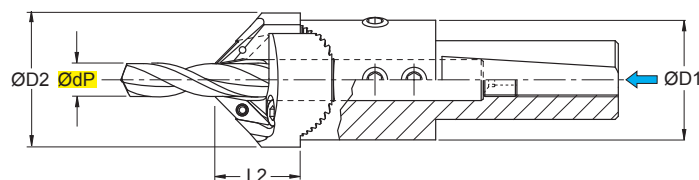

COD.	$\varnothing dp$	$\varnothing D1$	$\varnothing D2$	L2
SMU.C025.0506.10W	5	35	36,5	26
	5,5	35	37	26
	6	35	36	26
SMU.C025.0608.10W	6,5	35	36	26
	7	35	36,5	26
	7,5	35	37	26
	8	35	37,5	26
SMU.C025.0810.10W	8,5	35	37,5	26
	9	35	38	26
	9,5	35	38,5	26
	10	35	39	26
SMU.C025.1012.10W	10,5	35	39	26
	11	35	39,5	26
	11,5	35	41	26
	12	35	41	26
SMU.C025.1214.10W	12,5	35	41	26
	13	35	41	26
	13,5	35	41	26
	14	35	41,5	26
SMU.C032.1416.10W	14,5	40	43	26
	15	40	43	26
	15,5	40	43,5	26
	16	40	44	26
SMU.C032.1618.10W	16,5	40	45	26
	17	40	45	26
	17,5	40	45,5	26
	18	40	45,5	26

Ingombri smussatori SMU.ER..10 - Overall sizes chamfering tools SMU.ER..10
 Aussenabmessungen abschrägwerkzeuge SMU.ER..10 - Encombremets chanfreineurs SMU.ER..10

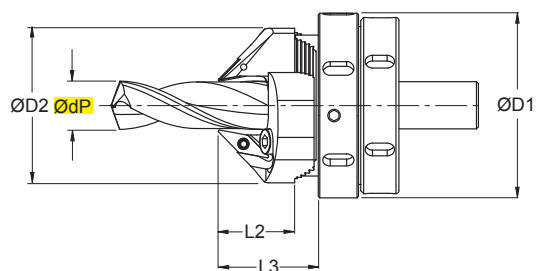

COD.	Ødp	ØD1	ØD2	L2	L3
SMU.ER25.0616.10	5	52	45,1	26	37
	5,5	52	45,1	26	37
	6	52	45,1	26	37
	6,5	52	45,2	26	37
	7	52	45,4	26	37
	7,5	52	45,6	26	37
	8	52	46	26	37
	8,5	52	46,2	26	37
	9	52	46,4	26	37
	9,5	52	46,8	26	37
	10	52	47,3	26	37
	10,5	52	47,5	26	37
	11	52	47,7	26	37
	11,5	52	48,1	26	37
	12	52	48,4	26	37
	12,5	52	48,7	26	37
	13	52	49,1	26	37
	13,5	52	49,4	26	37
14	52	50,6	26	37	
14,5	52	50,8	26	37	
15	52	50,9	26	37	
15,5	52	51,6	26	37	
16	52	52	26	37	

Ingombri smussatori SMU.ER..10 - Overall sizes chamfering tools SMU.ER..10
 Aussenabmessungen abschrägwerkzeuge SMU.ER..10 - Encombremets chanfreineurs SMU.ER..10

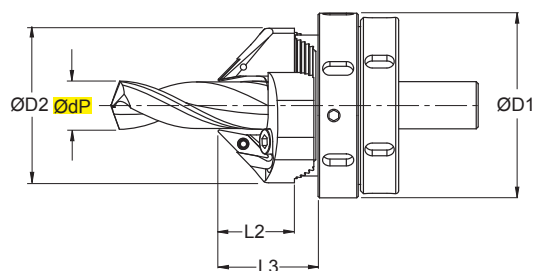

COD.	Ødp	ØD1	ØD2	L2	L3
SMU.ER32.0618.10	5	62	48	26	37
	5,5	62	48	26	37
	6	62	48	26	37
	6,5	62	48	26	37
	7	62	48	26	37
	7,5	62	48	26	37
	8	62	48	26	37
	8,5	62	48	26	37
	9	62	48	26	37
	9,5	62	48	26	37
	10	62	48	26	37
	10,5	62	48	26	37
	11	62	48	26	37
	11,5	62	48,4	26	37
	12	62	48,6	26	37
	12,5	62	49,2	26	37
	13	62	49,5	26	37
	13,5	62	49,5	26	37
	14	62	50,8	26	37
	14,5	62	51	26	37
15	62	51	26	37	
15,5	62	51,7	26	37	
16	62	52,2	26	37	
16,5	62	52,4	26	37	
17	62	53,4	26	37	
17,5	62	53,5	26	37	
18	62	53,8	26	37	

Ingombri smussatori SMU.ER..10 - Overall sizes chamfering tools SMU.ER..10
 Aussenabmessungen abschrägwerkzeuge SMU.ER..10 - Encombremets chanfreineurs SMU.ER..10

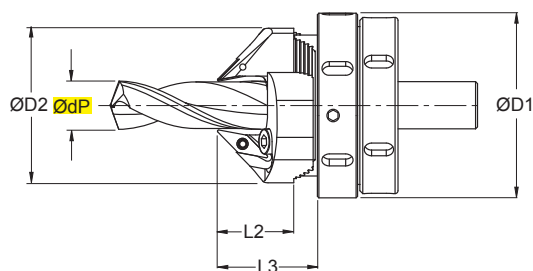

COD.	Ødp	ØD1	ØD2	L2	L3
SMU.ER40.0618.10	5	70	57,5	26	37
	5,5	70	57,5	26	37
	6	70	57,5	26	37
	6,5	70	57,5	26	37
	7	70	57,5	26	37
	7,5	70	57,5	26	37
	8	70	57,5	26	37
	8,5	70	57,5	26	37
	9	70	57,5	26	37
	9,5	70	57,5	26	37
	10	70	57,5	26	37
	10,5	70	57,5	26	37
	11	70	57,5	26	37
	11,5	70	57,5	26	37
	12	70	57,5	26	37
	12,5	70	57,5	26	37
	13	70	57,5	26	37
	13,5	70	57,5	26	37
	14	70	57,5	26	37
	14,5	70	57,5	26	37
15	70	57,5	26	37	
15,5	70	57,5	26	37	
16	70	57,5	26	37	
16,5	70	57,5	26	37	
17	70	57,5	26	37	
17,5	70	57,5	26	37	
18	70	57,5	26	37	

FILETTATURA METRICA ISO PASSO GROSSO (M) - 6H (UNI 4535 - 64)
ISO COARSE PITCH (M) - 6H (UNI 4535 - 64) METRIC SCREW THREAD

FILETTO THREAD	PASSO STEP	Ø INTERNO - INTERNAL		Ø FORO Ø HOLE	FILETTO THREAD	PASSO STEP	Ø INTERNO - INTERNAL		Ø FORO Ø HOLE
		Ø MIN.	Ø MAX.				Ø MIN.	Ø MAX.	
M2	0,40	1,567	1,679	1,60	M18	2,50	15,294	15,744	15,505
M2,5	0,45	2,013	2,138	2,05	M20	2,50	17,294	17,744	17,50
M3	0,50	2,459	2,599	2,50	M22	2,50	19,294	19,744	19,50
M3,5	0,60	2,850	3,010	2,90	M24	3,00	20,752	21,252	21,00
M4	0,70	3,242	3,422	3,30	M27	3,00	23,752	24,252	24,00
M4,5	0,75	3,688	3,878	3,70	M30	3,50	26,211	26,771	26,50
M5	0,80	4,134	4,334	4,20	M33	3,50	29,211	29,771	29,50
M6	1,00	4,917	5,153	5,00	M36	4,00	31,670	32,270	32,00
M7	1,00	5,917	6,153	6,00	M39	4,00	34,670	35,270	35,00
M8	1,25	6,647	6,912	6,80	M42	4,50	37,129	37,799	37,50
M9	1,25	7,647	7,912	7,80	M45	4,50	40,129	40,799	40,50
M10	1,50	8,376	8,676	8,50	M48	5,00	42,587	43,297	43,00
M11	1,50	9,376	9,676	9,50	M52	5,00	46,587	47,297	47,00
M12	1,75	10,106	10,441	10,20	M56	5,50	50,046	50,796	50,50
M14	2,00	11,835	12,210	12,00	M60	5,50	54,046	54,796	54,50
M16	2,00	13,835	14,210	14,00	M64	6,00	57,505	58,305	58,00

FILETTATURA METRICA ISO PASSO FINE (MF) - 6H (UNI 4535 - 64)
ISO FINE PITCH (MF) - 6H (UNI 4535 - 64) METRIC SCREW THREAD

FILETTO THREAD	PASSO STEP	Ø INTERNO - INTERNAL		Ø FORO Ø HOLE	FILETTO THREAD	PASSO STEP	Ø INTERNO - INTERNAL		Ø FORO Ø HOLE
		Ø MIN.	Ø MAX.				Ø MIN.	Ø MAX.	
MF2	0,25	1,729	1,774	1,75	MF27	1,50	25,376	25,676	25,50
MF2,2	0,25	1,929	1,974	1,95	MF28	1,50	26,376	26,676	26,50
					MF30	1,50	28,376	28,676	28,50
MF2,5	0,35	2,121	2,184	2,15	MF32	1,50	30,376	30,676	30,50
MF3	0,35	2,621	2,684	2,65	MF33	1,50	31,376	31,676	31,50
MF3,5	0,35	3,121	3,184	3,15	MF36	1,50	34,376	34,676	34,50
					MF38	1,50	36,376	36,676	36,50
MF4	0,50	3,459	3,599	3,50	MF40	1,50	38,376	38,676	38,50
MF5	0,50	4,459	4,599	4,50	MF42	1,50	40,376	40,676	40,50
MF6	0,50	5,459	5,599	5,50	MF45	1,50	43,376	43,676	43,50
					MF48	1,50	46,376	46,676	46,50
MF6	0,75	5,188	5,378	5,20	MF50	1,50	48,376	48,676	48,50
MF8	0,75	7,188	7,378	7,20	MF52	1,50	50,376	50,676	50,50
MF10	0,75	9,188	9,378	9,20					
MF12	0,75	11,188	11,378	11,20	MF18	2,00	15,835	16,210	16,00
					MF20	2,00	17,835	18,210	18,00
MF8	1,00	6,917	7,153	7,00	MF22	2,00	19,835	20,210	20,00
MF9	1,00	7,917	8,153	8,00	MF24	2,00	21,835	22,210	22,00
MF10	1,00	8,917	9,153	9,00	MF27	2,00	24,835	25,210	25,00
MF12	1,00	10,917	11,153	11,00	MF28	2,00	25,835	26,210	26,00
MF14	1,00	12,917	13,153	13,00	MF30	2,00	27,835	28,210	28,00
MF16	1,00	14,917	15,153	15,00	MF32	2,00	29,835	30,210	30,00
MF18	1,00	16,917	17,153	17,00	MF33	2,00	30,835	31,210	31,00
MF20	1,00	18,917	19,153	19,00	MF36	2,00	33,835	34,210	34,00
MF22	1,00	20,917	21,153	21,00	MF39	2,00	36,835	37,210	37,00
MF24	1,00	22,917	23,153	23,00	MF40	2,00	37,835	38,210	38,00
MF26	1,00	24,917	25,153	25,00	MF42	2,00	39,835	40,210	40,00
MF28	1,00	26,917	27,153	27,00	MF45	2,00	42,835	43,210	43,00
MF30	1,00	28,917	29,153	29,00	MF48	2,00	45,835	46,210	46,00
					MF50	2,00	47,835	48,210	48,00
MF10	1,25	8,647	8,912	8,80	MF52	2,00	49,835	50,210	50,00
MF12	1,25	10,647	10,912	10,80					
MF14	1,25	12,647	12,912	12,80	MF30	3,00	26,752	27,525	27,00
					MF33	3,00	29,752	30,525	30,00
MF12	1,50	10,376	10,676	10,50	MF36	3,00	32,752	33,525	33,00
MF14	1,50	12,376	12,676	12,50	MF39	3,00	35,752	36,525	36,00
MF16	1,50	14,376	14,676	14,50	MF42	3,00	38,752	39,525	39,00
MF18	1,50	16,376	16,676	16,50	MF45	3,00	41,752	42,525	42,00
MF20	1,50	18,376	18,676	18,50	MF48	3,00	44,752	45,525	45,00
MF22	1,50	20,376	20,676	20,50	MF50	3,00	46,752	47,525	47,00
MF24	1,50	22,376	22,676	22,50	MF52	3,00	48,752	49,525	49,00
MF26	1,50	24,376	24,676	24,50					

FILETTATURA GAS CILINDRICA BSP (G) (UNI ISO 228)
BSP (G) (UNI ISO 228) CYLINDRICAL GAS SCREW THREAD

FILETTO THREAD	PASSO STEP	Ø INTERNO - INTERNAL		Ø FORO Ø HOLE	FILETTO THREAD	PASSO STEP	Ø INTERNO - INTERNAL		Ø FORO Ø HOLE
		Ø MIN.	Ø MAX.				Ø MIN.	Ø MAX.	
G 1/8"	28	8,566	8,848	8,70	G 1+1/2"	11	44,845	45,485	45,20
G 1/4"	19	11,445	11,890	11,80	G 1+3/4"	11	50,788	51,428	51,20
G 3/8"	19	14,950	15,395	15,25	G 2	11	56,656	57,296	57,00
G 1/2"	14	18,631	19,172	19,00	G 2+1/4"	11	62,752	63,392	63,10
G 5/8"	14	20,587	21,128	21,00	G 2+1/2"	11	72,226	72,866	72,50
G 3/4"	14	24,117	24,658	24,50	G 2+3/4"	11	78,576	79,216	79,00
G 7/8"	14	27,877	28,418	28,20	G 3"	11	84,926	85,566	85,20
G 1"	11	30,291	30,931	30,70	G 3+1/4"	11	91,022	91,662	91,50
G 1+1/8"	11	34,939	35,579	35,50	G 3+1/2"	11	97,372	98,012	97,80
G 1+1/4"	11	38,952	39,592	39,50	G 3+3/4"	11	103,722	104,362	104,00
G 1+3/8"	11	41,365	42,005	41,80	G 4	11	110,072	110,712	110,50

FILETTATURA AMERICANA UNC -2B (ANSI B 1.1)
2B (ANSI B 1.1) - US STANDARD SCREW THREAD

FILETTO THREAD	PASSO STEP	Ø INTERNO - INTERNAL		Ø FORO Ø HOLE	FILETTO THREAD	PASSO STEP	Ø INTERNO - INTERNAL		Ø FORO Ø HOLE
		Ø MIN.	Ø MAX.				Ø MIN.	Ø MAX.	
4	40	2,181	2,385	2,35	7/8"	9	19,177	19,520	19,50
5	40	2,493	2,697	2,65	1"	8	21,971	22,344	22,25
6	32	2,642	2,896	2,85	1+1/8"	7	24,638	25,082	25,00
8	32	3,302	3,531	3,50	1+1/4"	7	27,813	28,258	28,20
10	24	3,683	3,937	3,90	1+3/8"	6	30,353	30,851	30,75
1/4"	20	4,978	5,250	5,20	1+1/2"	6	33,528	34,026	34,00
5/16"	18	6,401	6,731	6,60	1+3/4"	5	38,964	39,560	39,50
3/8"	16	7,798	8,082	8,00	2"	4,5	44,679	45,367	45,00
7/16"	14	9,144	9,441	9,40	2+1/4"	4,5	51,029	51,717	51,50
1/2"	13	10,592	10,881	10,80	2+1/2"	4	56,617	57,389	57,00
9/16"	12	11,989	12,301	12,20	2+3/4"	4	62,967	63,739	63,50
5/8"	11	13,386	13,693	13,60	3	4	69,317	70,089	70,00
3/4"	10	16,307	16,624	16,50					

FILETTATURA AMERICANA UNF -2B (ANSI B 1.1)
UNF - 2B (ANSI B 1.1) - US STANDARD SCREW THREAD

FILETTO THREAD	PASSO STEP	Ø INTERNO - INTERNAL		Ø FORO Ø HOLE	FILETTO THREAD	PASSO STEP	Ø INTERNO - INTERNAL		Ø FORO Ø HOLE
		Ø MIN.	Ø MAX.				Ø MIN.	Ø MAX.	
4	48	2,255	2,459	2,40	3/4"	16	17,323	17,546	17,50
6	40	2,819	3,023	2,95	7/8"	14	20,269	20,493	20,40
8	36	3,404	3,607	3,50	1"	12	23,114	23,363	23,25
10	32	3,962	4,166	4,10	1+1/8"	12	26,289	26,538	26,50
1/4"	28	5,359	5,563	5,50	1+1/4"	12	29,464	29,713	29,50
5/16"	24	6,782	6,995	6,90	1+3/8"	12	32,639	32,888	32,80
3/8"	24	8,382	8,565	8,50	1+1/2"	12	35,814	36,063	36,00
7/16"	20	9,728	9,947	9,90					
1/2"	20	11,328	11,524	11,50					
9/16"	18	12,751	12,969	12,90					
5/8"	18	14,351	14,554	14,50					

DIAMETRO DEL FORO PER L'UTILIZZO DEI MASCHI A RULLARE
HOLE DIAMETER FOR USING TAPS TO BE ROLLED

FILETTATURA METRICA ISO ISO METRIC SCREW THREAD	FILETTATURA AMERICANA UNC UNC US STANDARD SCREW THREAD	FILETTATURA AMERICANA UNF UNF US STANDARD SCREW THREAD
M3	2,75	1/4" (20)
M4	3,65	5/16" (18)
M5	4,60	3/8" (16)
M6	5,55	7/16" (14)
M8	7,40	1/2" (13)
M10	9,30	
M12	11,10	
M14	13,00	
M16	15,00	

PARAMETRI DI TAGLIO PER MICROFRESE A FILETTARE
CUTTING PARAMETER FOR MICRO-THREADING MILLS

DIN ISO 513	MATERIALE MATERIAL	VT mt/min	fz Ø3	fz Ø6	fz Ø8	fz Ø10	fz Ø12	fz Ø15
P	ACCIAIO NON LEGATO, ACCIAIO FUSO NOT-ALLOY STEEL, CAST STEEL							
	ACCIAIO DEBOLMENTE LEGATO LOW-ALLOY STEEL	60-120	0,04-0,07	0,09-0,13	0,14-0,15	0,15-0,16	0,16-0,17	0,17-0,18
	ACCIAIO ALTO LEGATO, ACCIAIO DA UTENSILI HIGH ALLOY STEEL, TOOL STEEL	60-90	0,03-0,06	0,08-0,10	0,12-0,13	0,13-0,14	0,15-0,16	0,17-0,18
	ACCIAIO INOSSIDABILE STAINLESS STEEL MARTENSITICO MARTENSITICO							
M	ACCIAIO INOSSIDABILE STAINLESS STEEL	60-90	0,02-0,04	0,05-0,06	0,07-0,08	0,09-0,10	0,10-0,11	0,12-0,13
K	GHISA GRIGIA GRAY IRON							
	GHISA A GRAFITE SFEROIDALE, NODULARE NODULAR CAST IRON	40-80	0,04-0,07	0,09-0,13	0,14-0,15	0,15-0,16	0,16-0,17	0,17-0,18
	GHISA MALLEABILE (DURA) MALLEABLE CAST IRON							
N	LEGHE DI ALLUMINIO ALUMINIUM ALLOYS	80-150	0,04-0,07	0,09-0,13	0,14-0,15	0,15-0,16	0,16-0,17	0,17-0,18
	LEGHE COLATE DI ALLUMINIO CAST ALUMINIUM ALLOYS							
	RAME E LEGHE DI RAME COPPER, COPPER ALLOYS							
	MATERIALI NON METALLICI NONMETALLIC MATERIALS	50-20	0,09-0,12	0,14-0,18	0,18-0,19	0,18-0,19	0,18-0,19	0,19-0,20
S	LEGHE RESISTENTI AL CALORE HIGH-TEMPERATURE ALLOYS							
	TITANIO, LEGHE DI TITANIO TITANIUM, TITANIUM ALLOYS	20-40	0,03-0,04	0,04-0,06	0,05-0,06	0,06-0,07	0,06-0,07	0,07-0,08

* I diametri della tabella sono riferiti al gambo dell'utensile

* The diameters in the table refer to the tool shank

PARAMETRI DI TAGLIO PER FRESE A FILETTARE
CUTTING PARAMETER FOR THREADING MILLS

DIN ISO 513	MATERIALE MATERIAL	VT mt/min	fz Ø6	fz Ø8	fz Ø10	fz Ø12	fz Ø14	fz Ø16	fz Ø18	fz Ø20
P	ACCIAIO NON LEGATO, ACCIAIO FUSO NOT-ALLOY STEEL, CAST STEEL	90÷120	0,01±0,04	0,04±0,08	0,08±0,10	0,10±0,12	0,12±0,14	0,14±0,16	0,16±0,18	0,18±0,20
	ACCIAIO DEBOLMENTE LEGATO LOW-ALLOY STEEL	80÷160	0,01±0,03	0,03±0,07	0,07±0,09	0,09±0,11	0,11±0,13	0,13±0,15	0,15±0,17	0,17±0,19
	ACCIAIO ALTO LEGATO, ACCIAIO DA UTENSILI HIGH ALLOY STEEL, TOOL STEEL	60÷120	0,01±0,02	0,02±0,06	0,06±0,08	0,08±0,10	0,10±0,12	0,12±0,14	0,14±0,16	0,16±0,18
	ACCIAIO INOSSIDABILE STAINLESS STEEL MARTENSITICO MARTENSITICO									
M	ACCIAIO INOSSIDABILE STAINLESS STEEL	40÷80	0,01±0,03	0,03±0,05	0,05±0,07	0,07±0,09	0,09±0,11	0,11±0,13	0,13±0,15	0,13±0,15
K	GHISA GRIGIA GRAY IRON	80÷160	0,03±0,06	0,06±0,09	0,09±0,12	0,12±0,15	0,15±0,18	0,15±0,18	0,18±0,20	0,18±0,20
	GHISA A GRAFITE SFEROIDALE, NODULARE NODULAR CAST IRON	70÷140	0,03±0,05	0,05±0,07	0,07±0,09	0,09±0,11	0,11±0,13	0,13±0,15	0,15±0,17	0,17±0,19
	GHISA MALLEABILE (DURA) MALLEABLE CAST IRON	60÷110	0,02±0,04	0,04±0,06	0,06±0,08	0,08±0,09	0,09±0,10	0,10±0,11	0,11±0,12	0,12±0,13
N	LEGHE DI ALLUMINIO ALUMINIUM ALLOYS	100÷250	0,01±0,04	0,04±0,08	0,08±0,10	0,10±0,12	0,12±0,14	0,14±0,16	0,16±0,18	0,18±0,20
	LEGHE COLATE DI ALLUMINIO CAST ALUMINIUM ALLOYS	150÷250	0,01±0,04	0,04±0,08	0,08±0,10	0,10±0,12	0,12±0,14	0,14±0,16	0,16±0,18	0,18±0,20
	RAME E LEGHE DI RAME COPPER, COPPER ALLOYS	150÷250	0,01±0,04	0,04±0,08	0,08±0,10	0,10±0,12	0,12±0,14	0,14±0,16	0,16±0,18	0,18±0,20
	MATERIALI NON METALLICI NONMETALLIC MATERIALS	150÷250	0,01±0,04	0,04±0,08	0,08±0,10	0,10±0,12	0,12±0,14	0,14±0,16	0,16±0,18	0,18±0,20
S	LEGHE RESISTENTI AL CALORE HIGH-TEMPERATURE ALLOYS	30÷60	0,005±0,01	0,01±0,020	0,020±0,030	0,030±0,040	0,040±0,050	0,050±0,060	0,060±0,070	0,070±0,080
	TITANIO, LEGHE DI TITANIO TITANIUM, TITANIUM ALLOYS	30÷80	0,01±0,02	0,02±0,03	0,03±0,04	0,04±0,05	0,05±0,06	0,06±0,07	0,07±0,08	0,08±0,09
H	ACCIAIO TEMPRATO HARDENED STEEL									
	GHISA FUSA, GETTI DI GHISA CHILL CAST IRON									
	GHISA TEMPRATA HARDENED CAST IRON									

* I diametri della tabella sono riferiti al gambo dell'utensile

* The diameters in the table refer to the tool shank

**CONSIGLI PER LA FRESATURA DI FILETTI
SUGGESTIONS FOR MILLING THE THREADS**

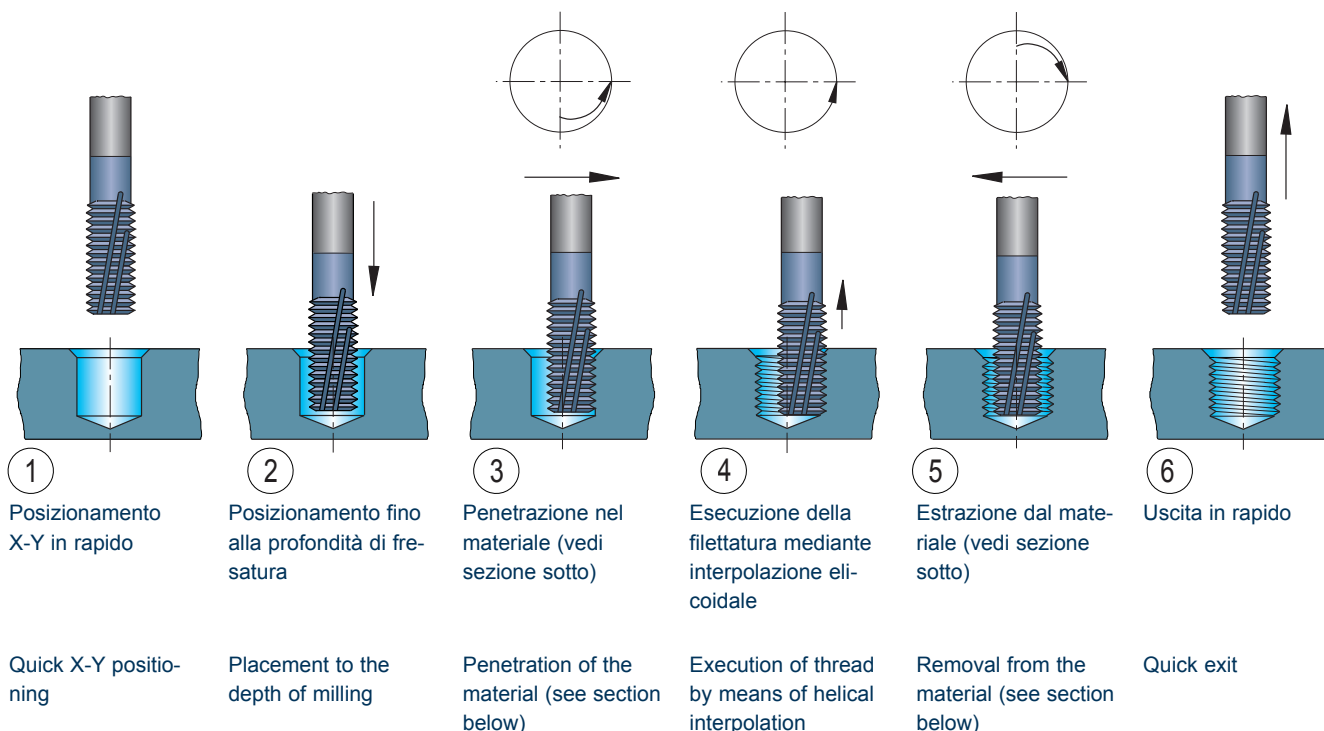

- Per filettature interne usare un diametro fresa non superiore ai 2/3 del diametro del filetto, per i filetti a passo fine 3/4. Per filettature esterne il diametro fresa non deve essere superiore al diametro del filetto.

- For inner threading use a milling cutter diameter no greater than 2/3 of the diameter of the thread, for fine thread pitches use 3/4. For outer threading the milling cutter diameter must not be greater than the diameter of the thread.

FILETTATURA INTERNA - INTERNAL THREADING

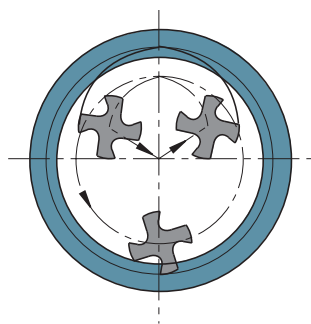

- Per evitare tracce sul filetto, eseguire la penetrazione e l'estrazione con una traiettoria circolare, avanzando di un passo. Se si esegue la penetrazione diritta ridurre l'avanzamento del 70-75%

- To prevent marks in the thread, execute the penetration and the removal with a circular trajectory, advancing by a step. If straight penetration is executed, reduce the feed rate by 70-75%.

FILETTATURA ESTERNA - EXTERNAL THREADING

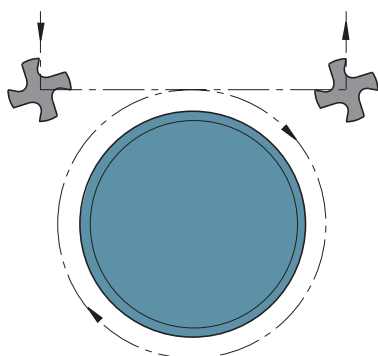

- Per evitare tracce nel filetto, eseguire la penetrazione e l'estrazione con una traiettoria tangenziale, avanzando di un passo. Se si esegue la penetrazione diritta ridurre l'avanzamento del 70-75%.

- To prevent marks in the thread, execute the penetration and the removal with a tangential trajectory, advancing by a step. If straight penetration is executed, reduce the feed rate by 70-75%.

METODI DI FRESATURA DI FILETTI
METHODS OF MILLING THE THREADS

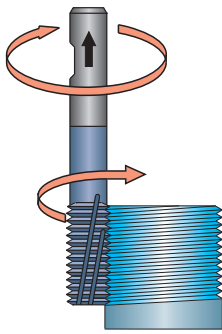

- Filetto destro
fresatura in discordanza

- Right-hand thread,
discordance milling

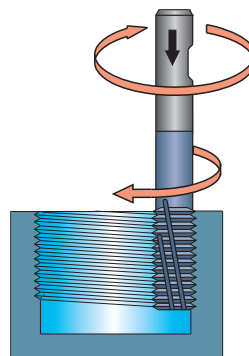

- Filetto destro
fresatura in discordanza

- Right-hand thread,
discordance milling

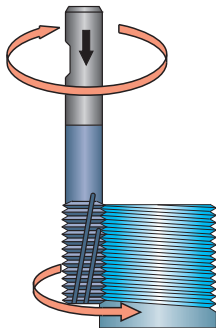

- Filetto sinistro
fresatura in discordanza

- Left-hand thread,
discordance milling

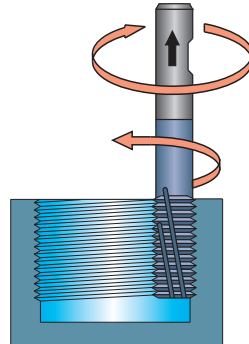

- Filetto sinistro
fresatura in discordanza

- Left-hand thread,
discordance milling

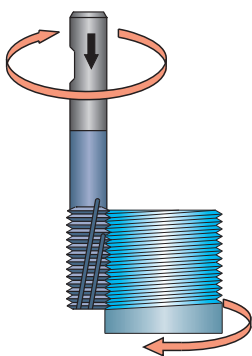

- Filetto destro
fresatura in concordanza

- Right-hand thread,
accordance milling

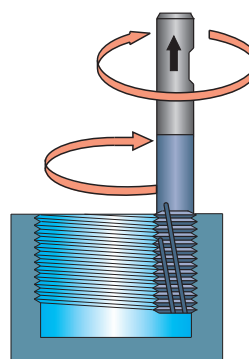

- Filetto destro
fresatura in concordanza

- Right-hand thread,
accordance milling

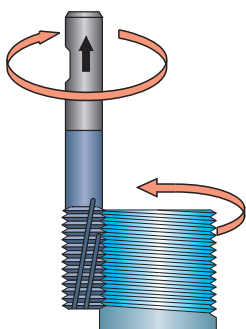

- Filetto sinistro
fresatura in concordanza

- Left-hand thread,
accordance milling

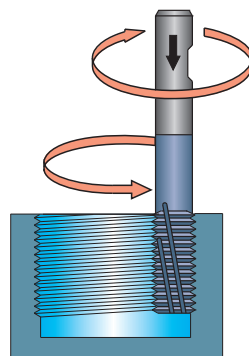

- Filetto sinistro
fresatura in concordanza

- Left-hand thread,
accordance milling

SIGLE E FORMULE GENERALI
GENERAL ACRONYMS AND FORMULAS

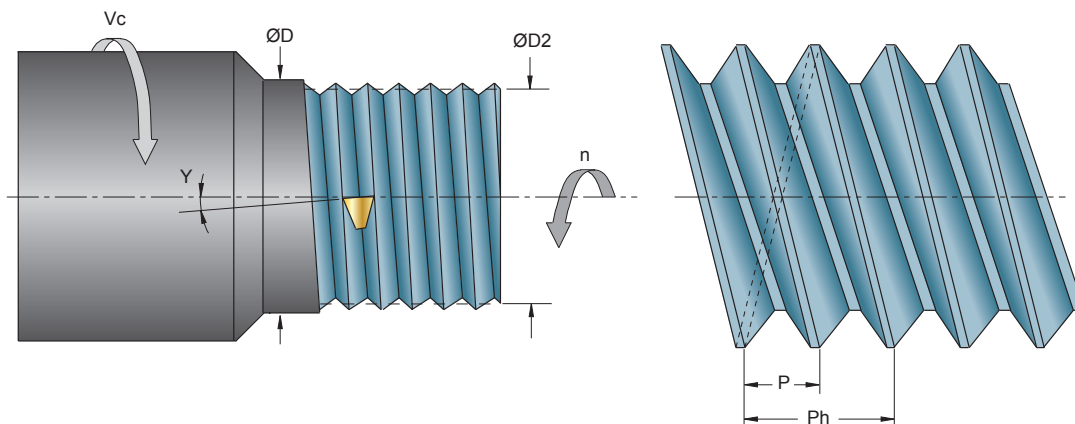

ØD (mm)	= DIAMETRO DEL PEZZO DA FILETTARE
ØD2 (mm)	= DIAMETRO MEDIO DELLA FILETTATURA
n (giri/min - min ⁻¹)	= NUMERO DI GIRI AL MINUTO
N	= NUMERO DI PRINCIPI
P (mm)	= PASSO DEL FILETTO
Ph (mm)	= PASSO DELL' ELICA (FILETTATURE A PIÙ PRINCIPI)
Sv (m/min)	= AVANZAMENTO
Vc (m/min)	= VELOCITÀ DI TAGLIO
γ (°)	= ANGOLO DELL' ELICA



ØD (mm)	= WORKPIECE DIAMETER
ØD2 (mm)	= MEDIUM THREAD DIAMETER
n (giri/min - min ⁻¹)	= NUMBER OF REVOLUTIONS / MIN
N	= MULTI-START NUMBER
P (mm)	= THREAD PITCH
Ph (mm)	= SCREW PITCH (MULTI-START THREAD)
Sv (m/min)	= FEED
Vc (m/min)	= CUTTING SPEED
γ (°)	= LEAD ANGLE

$$Vc \text{ (m/min)} = \frac{\text{ØD} \cdot 3,14 \cdot n}{1000}$$

$$n \text{ (giri/min - min}^{-1}\text{)} = \frac{Vc \cdot 1000}{\text{ØD} \cdot 3,14}$$

$$Ph \text{ (mm)} = P \cdot N$$

$$Sv \text{ (m/min)} = \frac{n \cdot Ph}{1000}$$

$$\gamma \text{ (}^\circ\text{)} = \arctan \frac{Ph}{\text{ØD2} \cdot 3,14}$$

INDICAZIONI PER L' APPLICAZIONE DELLE UNITÀ MICROMETRICHE
INSTRUCTIONS FOR INSTALLATION OF MICRO-BORING UNITS

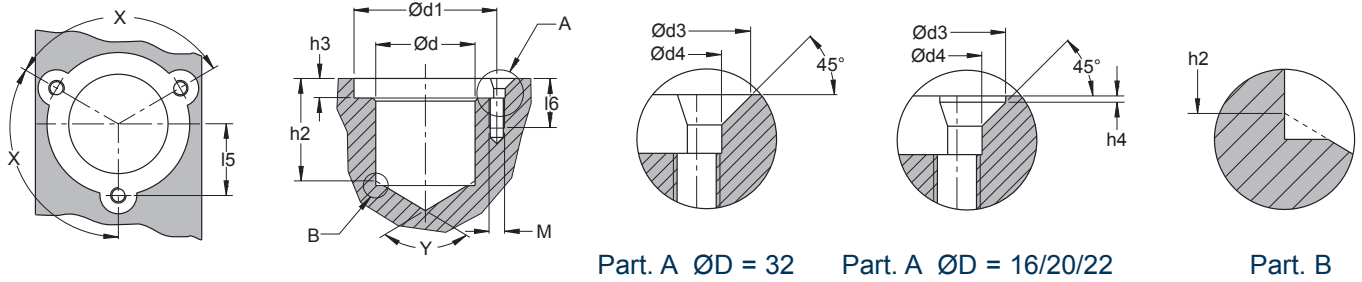

H7	+0,2 0	+0,3 0	+0,2 0	+0,02 -0,02	+0,1 0	+0,02 -0,02	+15' -15'	MAX			
ØD	Ød1	Ød3	Ød4	h2	h3	h4	M	I5	I6	X	Y
16	19	4,6	3,2	11,5	2,8	1,6	m3	9,65	9	120°	118°
20	25	4,6	3,2	15,5	4,0	1,6	m3	12,50	9	120°	118°
22	30	6,5	4,3	24,0	5,0	1,8	m4	15,40	13	120°	118°
32	46	11,9	5,4	33,0	6,3	-	m5	23,00	16	120°	118°

DIAMETRO MINIMO (ØD1min.) DI BARENATURA
MINIMUM BORE DIAMETER (ØD1min.)

ART.	Ød	ØD1min.	f	H
L348C.31.0602	16	25,4	0,36	10,9
L348C.32.0602	20	33,1	1,07	14,6
L348C.33.09T3	22	42,6	1,30	17,1
L348C.34.09T3	32	60,0	1,56	26,2
L348C.32.0902	20	33,1	1,07	14,6
L348C.33.1102	22	42,6	1,30	17,1
L348C.34.16T3	32	60,0	1,56	26,2
L348C.11.0602	16	27,6	5,1	10,2
L348C.12.0602	20	37,1	6,3	13,7
L348C.13.09T3	22	49,1	7,2	16,3
L348C.14.09T3	32	69,0	10,0	25,1
L348C.12.0902	20	37,1	6,3	13,7
L348C.13.1102	22	49,1	7,2	16,3
L348C.14.16T3	32	69,0	10,0	25,1

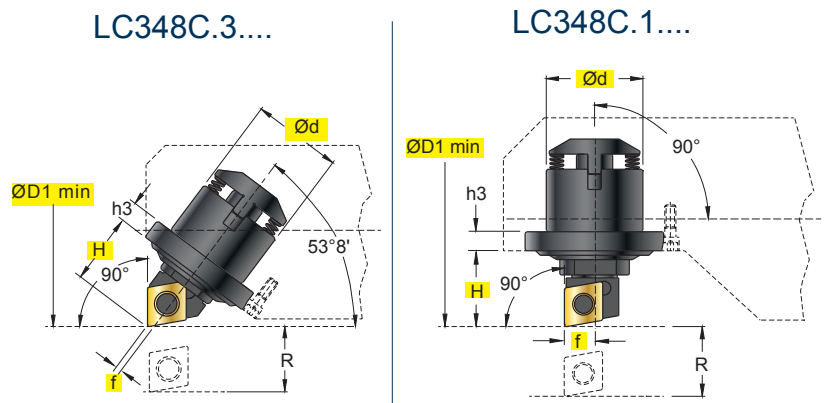

DIMENSIONI CARTUCCE
CARTRIDGES DIMENSIONS

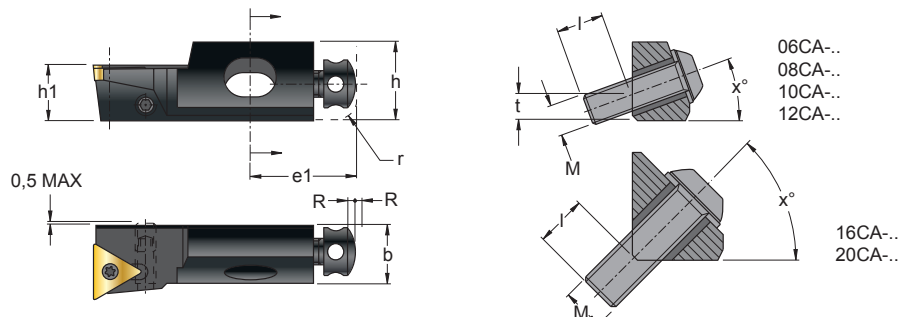

ART.	H1	h	b	e1	x°	t	M	l	r	R
06CA-05	5,5	7,5	6,0	13	20°	2,1	M3x0,5	4,0	2	1,0
06CA-06	6,0	8,5	6,0	12	20°	3,5	M3x0,5	4,0	3	1,0
08CA-..	8,0	11,0	7,5	17	20°	4,5	M4x0,7	5,0	3	1,0
10CA-..	10,0	15,0	11,0	20	20°	5,0	M6x1	9,5	4	1,5
12CA-..	12,0	20,0	15,0	20	20°	6,0	M6x1	7,5	5	1,5
16CA-..	16,0	25,0	20,0	25	45°	-	M8x1,25	11,5	6	1,5
20CA-..	20,0	30,0	20,0	30	45°	-	M8x1,25	10,0	6	1,5

**HSK
DIN 69893-A**

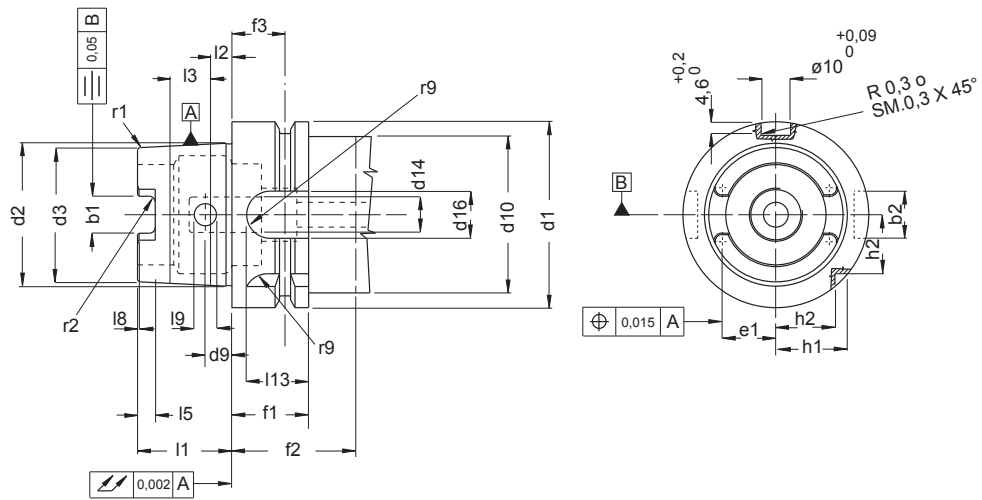

HSK	32	40	50	63	80	100	125	160
b2	7	9	12	16	18	20	25	32
d1	32	40	50	63	80	100	125	160
d2	$\begin{matrix} +0,007 \\ +0,005 \end{matrix}$ 24	$\begin{matrix} +0,007 \\ +0,005 \end{matrix}$ 30	$\begin{matrix} +0,009 \\ +0,006 \end{matrix}$ 38	$\begin{matrix} +0,011 \\ +0,007 \end{matrix}$ 48	$\begin{matrix} +0,013 \\ +0,008 \end{matrix}$ 60	$\begin{matrix} +0,015 \\ +0,009 \end{matrix}$ 75	$\begin{matrix} +0,018 \\ +0,011 \end{matrix}$ 95	$\begin{matrix} +0,018 \\ +0,011 \end{matrix}$ 120
d3	$\begin{matrix} +0,005 \\ +0,003 \end{matrix}$ 23,270	$\begin{matrix} +0,005 \\ +0,003 \end{matrix}$ 29,050	$\begin{matrix} +0,006 \\ +0,003 \end{matrix}$ 36,900	$\begin{matrix} +0,007 \\ +0,003 \end{matrix}$ 46,530	$\begin{matrix} +0,008 \\ +0,003 \end{matrix}$ 58,100	$\begin{matrix} +0,009 \\ +0,003 \end{matrix}$ 72,600	$\begin{matrix} +0,011 \\ +0,004 \end{matrix}$ 91,950	$\begin{matrix} +0,011 \\ +0,004 \end{matrix}$ 116,000
d9	4	4,6	6	7,5	8,5	12	-	-
d10 max	26	34	42	53	67	85	105	130
d14 f8	6	8	10	12	14	16	18	20
d16	M10 x 1	M12 x 1	M16 x 1	M18 x 1	M20 x 1,5	M24 x 1,5	M30 x 1,5	M35 x 1,5
e1	8,905	11,081	13,997	18,110	22,073	27,561	35,580	44,538
e2	4,903	5,903	7,648	9,15	11,898	14,888	18,388	22,888
f1	20	20	26	26	26	29	29	31
f3	16	16	18	18	18	20	20	22
h1	13	17	21	26,5	34	44	55,5	72
h2	9,5	12	15,5	20	25	31,5	39,5	50
l1	16	20	25	32	40	50	63	80
l2	3,2	4	5	6,3	8	10	12,5	16
l3	7,3	9,5	11	14,7	19	24	30,5	40
l9	5	6	7,5	9	12	15	-	-
l13	12	12	19	21	22	24	24	24
r1	0,6	0,8	1	1,2	1,6	2	2,5	3,2

DIN 69871

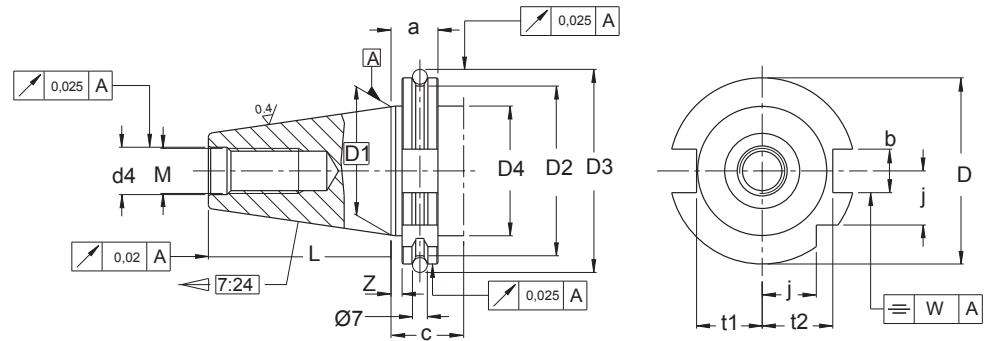

ISO	D	D1	D2	D3	L	a	Z	b	t1	t2	j	M	d4	W	c	D4	TYPE CAT D4
40	63,55	44,45	56,25	72,30	68,40	19,1	3,2	16,1	22,8	25,0	18,5	M16	17	0,12	35	50	39,00
45	82,55	57,15	75,25	91,35	82,70	19,1	3,2	19,3	29,1	31,3	24,0	M20	21	0,12	35	63	57,40
50	97,50	69,85	91,25	107,25	101,75	19,1	3,2	25,7	35,5	37,7	30,0	M24	25	0,20	35	80	70,10

DIN 69871/B

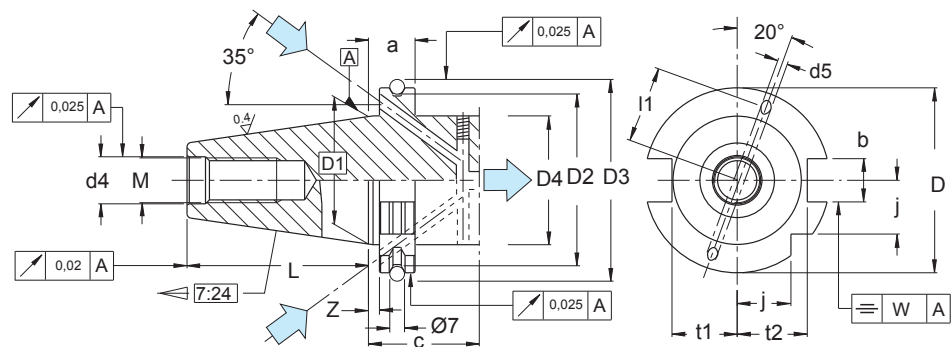

ISO	D	D1	D2	D3	L	a	Z	b	t1	t2	j	M	d4	d5	l1	W	C	D4	TYPE CAT D4
40	63,55	44,45	56,25	72,30	68,40	19,1	3,2	16,1	22,8	25,0	18,5	M16	17	4	27	0,12	35	50	39,00
45	82,55	57,15	75,25	91,35	82,70	19,1	3,2	19,3	29,1	31,3	24,0	M20	21	5	35	0,12	35	63	57,40
50	97,50	69,85	91,25	107,25	101,75	19,1	3,2	25,7	35,5	37,7	30,0	M24	25	6	42	0,20	35	80	70,10

MAS 403 BT

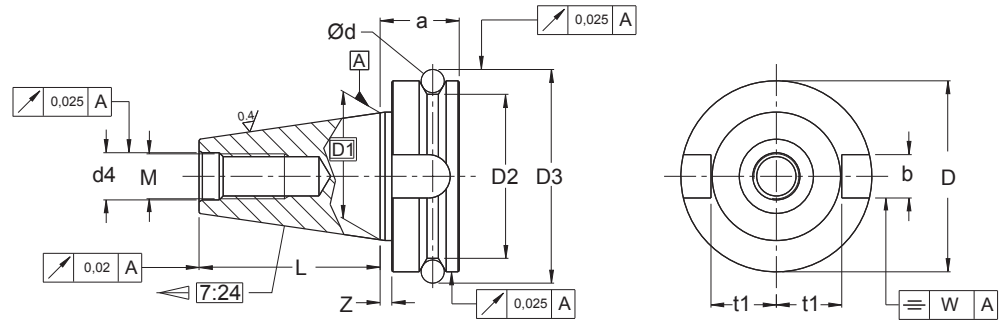

ISO	D	D1	D2	D3	L	a	Z	b	t1	d	M	d4	W				
40	63	44,45	53	75,679	65,4	27	2	16,1	22,6	10	M16	17	0,12				
45	85	57,15	73	100,215	82,8	33	3	19,3	29,1	12	M20	21	0,12				
50	100	69,85	85	119,020	101,8	38	3	25,7	35,4	15	M24	25	0,20				

MAS 403 BT/B

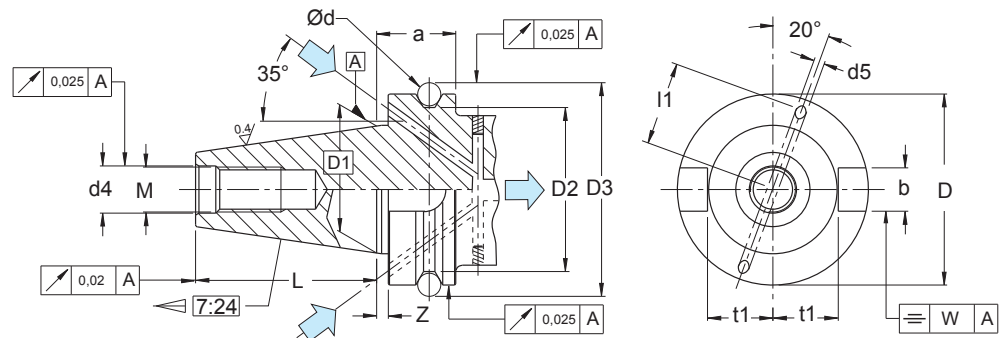

ISO	D	D1	D2	D3	L	a	Z	b	t1	d	M	d4	W	l1	d5		
40	63	44,45	53	75,679	65,4	27	2	16,1	22,6	10	M16	17	0,12	27	4		
45	85	57,15	73	100,215	82,8	33	3	19,3	29,1	12	M20	21	0,12	35	5		
50	100	69,85	85	119,020	101,8	38	3	25,7	35,4	15	M24	25	0,20	42	6		

**PSC
ISO 26623-1**

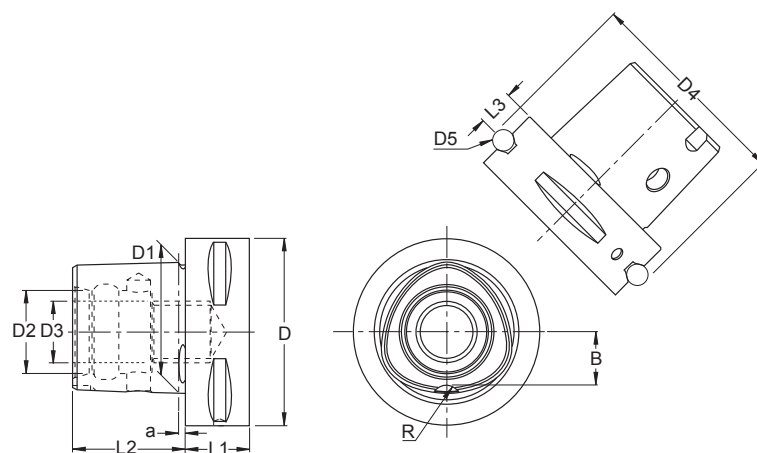

PSC	D	D1	D2	D3	D4	D5	L1min	L2	L3	a	B	R
32	32	22	15	M12 x 1,5	39,0	5	15	19	6	2,5	9,0	3
40	40	28	18	M14 x 1,5	46,0	5	20	24	8	2,5	11,0	3
50	50	35	21	M16 x 1,5	59,3	7	20	30	10	3,0	14,0	4
63	63	44	28	M20 x 2,0	70,7	7	22	38	12	3,0	18,0	5
80	80	55	32	M20 x 2,0	86,0	7	30	48	12	3,0	22,2	6
100	100	72	43	M24 x 2,0	110,0	10	32	60	16	3,0	29,2	6

FORMA A

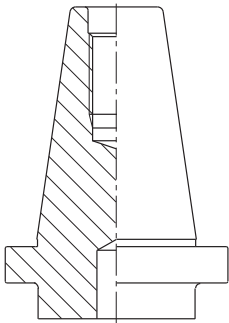

FORMA AD

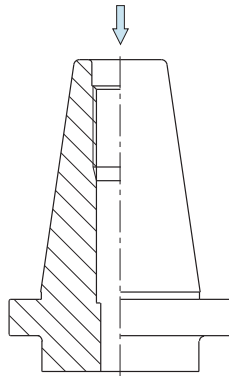

FORMA B

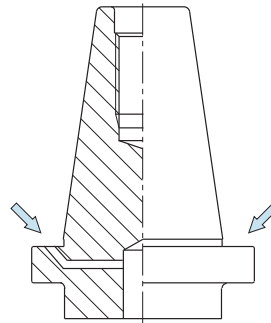

FORMA A-AD-B

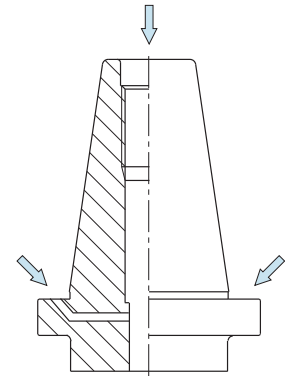

MODULARE - MODULAR

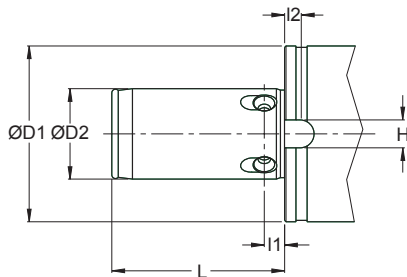

ØD2 = Ø32-40

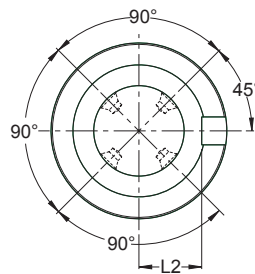

ØD2 = Ø14-18-22-27

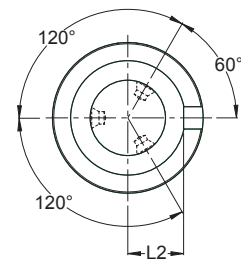

ØD2 ^{h6}	ØD1	L	l1 ±0,05	l2	H ^{+0,05 +0,10}	L2 ^{-0,1 -0,3}			
14	27	20	6	4	6	9,5			
18	35	25	6,5	4	6	13			
22	42	30	7	4	8	16			
27	54	35	7,5	5	8	20			
32	63	62	7,35	5,5	10	22,5			
40	78	82	9,35	7	12	29			

MODULARE - MODULAR

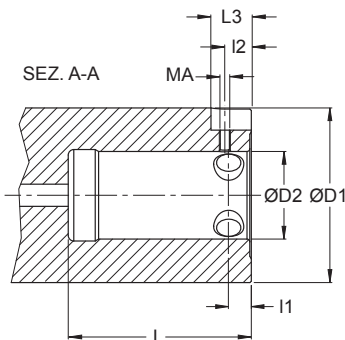

ØD2 = Ø32-40

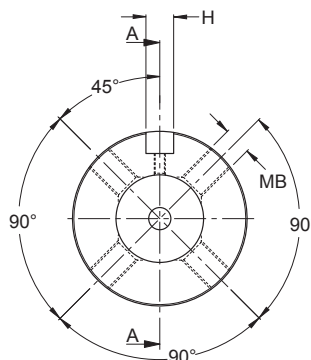

ØD2 = Ø14-18-22-27

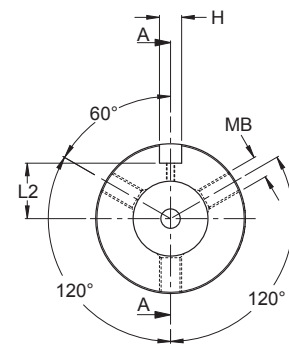

ØD2 ^{H6}	ØD1	L	l1 ±0,1	l2	H ^{+0,02 +0}	L2 ^{+0,2 +0}	L3 ^{+0,5 +0,3}	MA	MB
14	27	23	6,5	4	6	9,5	8	M3	M5
18	35	28	7	4	6	13	8	M3	M6
22	42	33	8	4	8	16	8	M3	M8
27	54	38	8	4	8	20	8	M3	M8
32	63	66	8,1	9,5	10	23,5	14,5	M4	M10
40	78	84	10	10	12	29	16	M5	M15

FORMA - A
A-FORM
A-FORM
FORME-A

Flangia a V con cave di fresatura ed alloggiamento chip, per cambi utensili automatici, indicato per centri di lavoro. Cono con 2 cave di trascinamento diverse, con foro per compatibilità con cambio manuale. Adduzione refrigerante dal centro attraverso un raccordo flottante accessorio.

V Flange with slots for timing and chips, for automatic tool changes, suitable for automatic tool changes, suitable for machining centers. Cone with two different driving slots, with bore for compatibility with manual change. Coolant feed from the center through an additional floating connector.

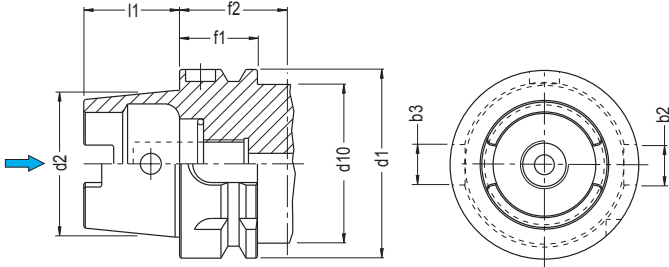

	32	40	50	63	80	100	125	160
d1	32	40	50	63	80	100	125	160
d2	24	30	38	48	60	75	95	120
d10	26	34	42	53	67	85	105	130
l1	16	20	25	32	40	50	63	80
f1	20	20	26	26	26	29	29	31
f2	35	35	42	42	42	45	45	47
b2	7	9	12	16	18	20	25	32
b3	9	11	14	18	20	22	28	36

FORMA - B
B-FORM
B-FORM
FORME-B

Flangia a V con 2 cave uguali di trascinamento ed alloggiamento chip, per cambi utensili automatici, indicato per centri di lavoro e torni. Cono senza cave di trascinamento, con foro per compatibilità con cambio manuale. Adduzione refrigerante dal centro attraverso un raccordo flottante accessorio oppure attraverso 2 fori nella flangia.

V Flange with 2 Driving slots of equal size for chips, for automatic tool changes, suitable for machining centers and lathes. Cone without driving slots, with bore for compatibility with manual change. Coolant feed from the center through an additional floating connector or through 2 bores in the flange.

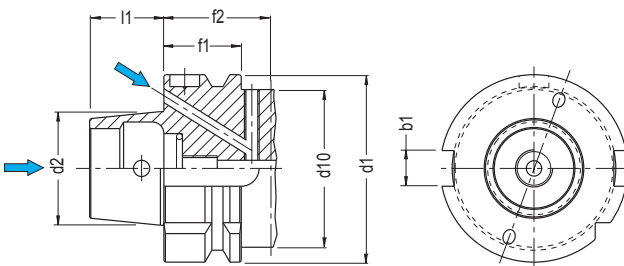

	40	50	63	80	100	125	160	
d1	40	50	63	80	100	125	160	
d2	24	30	38	48	60	75	95	
d10	34	42	53	67	85	105	130	
l1	16	20	25	32	40	50	63	
f1	20	26	26	26	29	29	31	
f2	35	42	42	42	45	45	47	
b1	10	12	16	18	20	25	32	

FORMA - C
C-FORM
C-FORM
FORME-C

Flangia cilindrica per macchine con cambio manuale. Cono con 2 cave di trascinamento diverse, con foro per cambio manuale. Con foro centrale di adduzione refrigerante.

Cylindrical flange for machines with manual change. Cone with 2 different driving slots, with bores for manual change. Cone with centered bore for coolant feed.

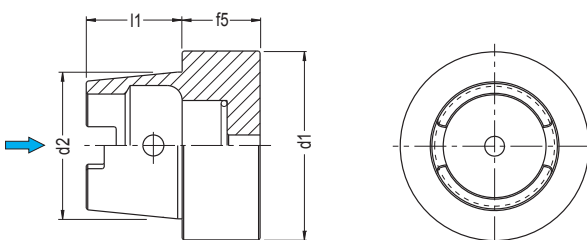

	32	40	50	63	80	100	125	160
d1	32	40	50	63	80	100	125	160
d2	24	30	38	48	60	75	95	120
l1	16	20	25	32	40	50	63	80
f5	10	10	12,5	12,5	16	16	-	-

FORMA - D
D-FORM
D-FORM
FORME-D



Flangia cilindrica con 2 cave uguali di trascinamento per macchine con cambio manuale.
 Cono senza cave di trascinamento, con foro per cambio manuale.
 Adduzione refrigerante dal centro attraverso un raccordo flottante accessorio oppure attraverso 2 fori nella flangia.



Cylindrical flange with 2 driving slots of equal size, for machines with manual change.
 Cone without driving slots, with bore for manual change.
 Coolant feed from the center through an additional floating connector or through 2 bores in the flange.

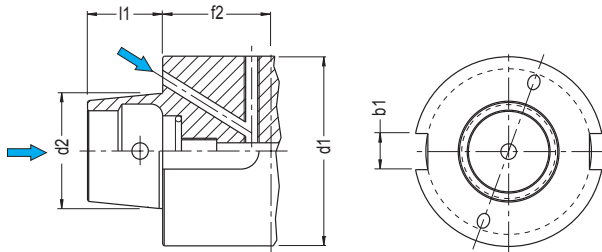

	40	50	63	80	100	125	160
d1	40	50	63	80	100	125	160
d2	24	30	38	48	60	75	95
l1	16	20	25	32	40	50	63
f2	35	42	42	42	45	45	47
b1	10	12	16	18	20	25	32

FORMA - E
E-FORM
E-FORM
FORME-E



Flangia a V senza cave per cambi utensili automatici, indicato per macchine ad alta velocità.
 Cono senza cave di trascinamento e senza foro per cambio manuale.
 Con foro centrale di adduzione refrigerante.



V Flange without slots for automatic tool changes, suitable for high speed machines.
 Cone without driving slots and without bore for manual change.
 Cone with centered bore for coolant feed.

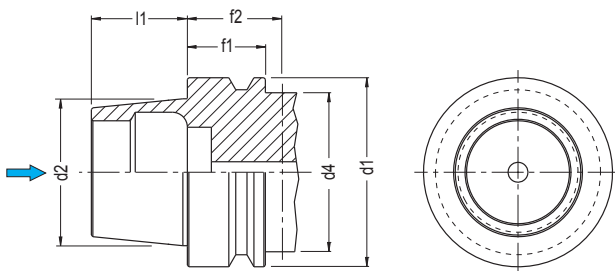

	25	32	40	50	63		
d1	25	32	40	50	63		
d2	19	24	30	38	48		
d4	20	26	34	42	53		
l1	13	16	20	25	32		
f1	10	20	20	26	26		
f2	20	35	35	42	42		

FORMA - F
F-FORM
F-FORM
FORME-F



Flangia a V senza cave per cambi utensili automatici, indicato per macchine ad alta velocità.
 Cono senza cave di trascinamento e senza foro per cambio manuale.
 Con foro centrale di adduzione refrigerante.



V Flange without slots for automatic tool changes, suitable for high speed machines.
 Cone without driving slots and without bore for manual change.
 Cone with centered bore for coolant feed.

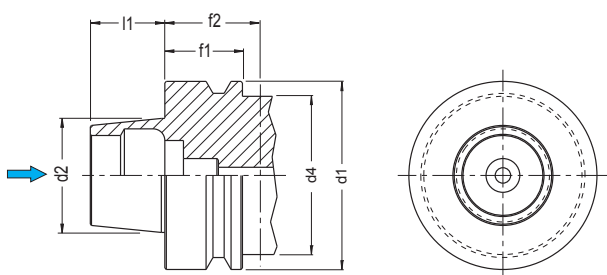

	50	63	80				
d1	50	63	80				
d2	30	38	48				
d4	42	53	67				
l1	20	25	32				
f1	26	26	26				
f2	42	42	42				

STESSO INGOMBRO PER ARTICOLI DI: MASCHIATURA - FORATURA - ALESATURA - RADDRIZZATURA
 SAME OVERALL SIZE FOR: TAPPING - DRILLING - BORING - STRAIGHTENING ITEMS

FORATURA
DRILLING

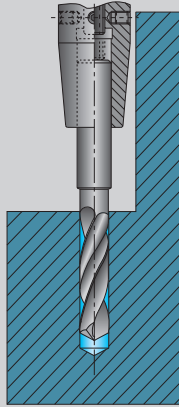

MASCHIATURA
TAPPING

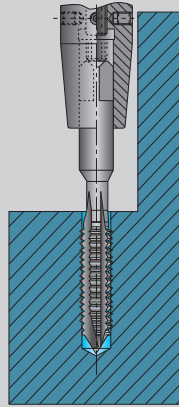

ALESATURA
BORING

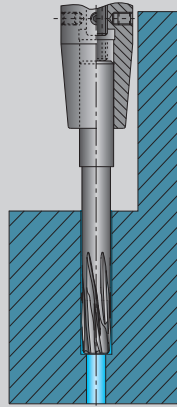

RADDRIZZATURA
STRAIGHTENING

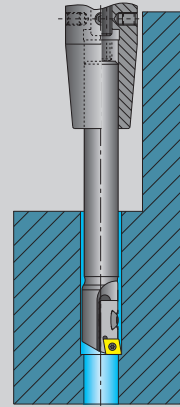

POSSIBILITÀ DI MODIFICA DEI MANDRINI
POSSIBILITY TO MODIFY THE CHUCKS

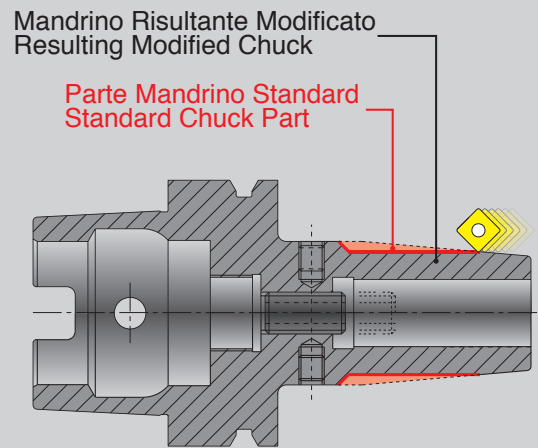
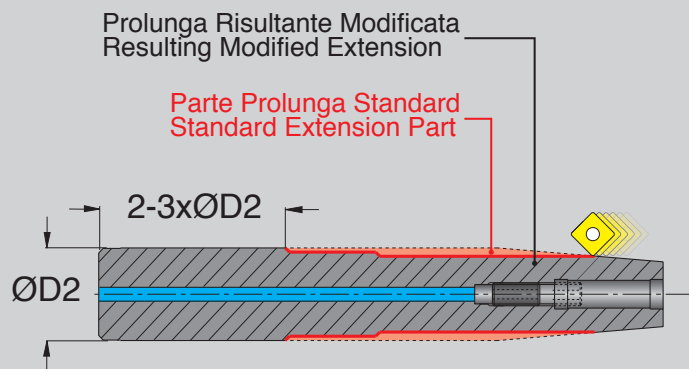

REFRIGERAZIONE INTERNA
INTERNAL COOLING

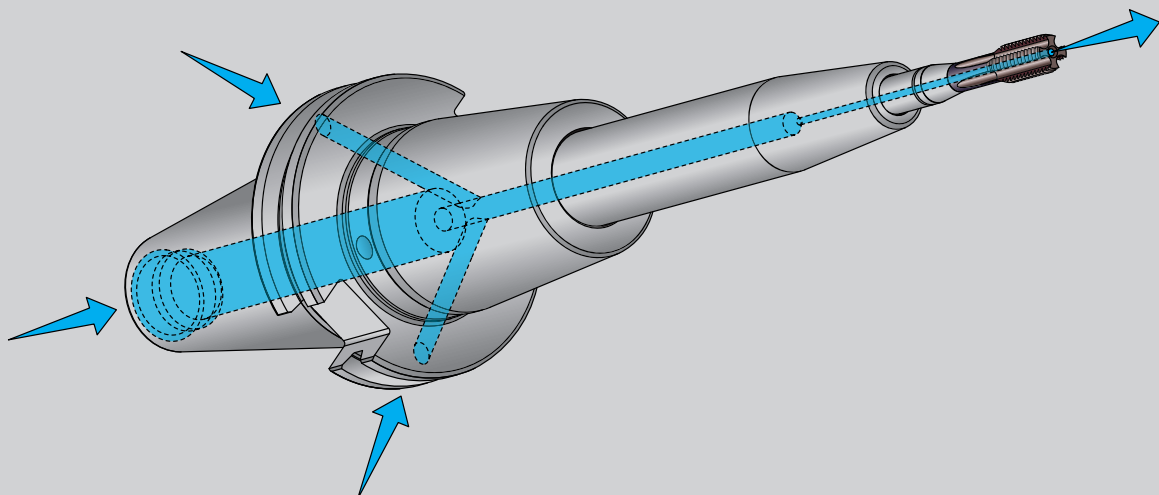

TECNICA DEL SISTEMA DI CALETTAMENTO A CALDO TECHNIQUE OF THE SHRINKING-ON SYSTEM

Il fissaggio a caldo si basa sul principio della dilatazione degli acciai in funzione della variazione di temperatura: aumentando la temperatura del mandrino nella zona da dilatare, si ottiene un aumento del diametro interno che permette l'inserimento dell'utensile a gambo cilindrico. Raffreddando il mandrino il foro interno torna alla dimensione normale, creando una costante ed elevata pressione su tutta la superficie in contatto con l'utensile. Il risultato è un insieme molto omogeneo di mandrino ed utensile con una forza di serraggio radiale molto forte tale da creare un sistema rigido e preciso. Utilizzando il riscaldamento per induzione magnetica si ottiene una velocità di riscaldamento del mandrino tale che l'utensile non ha il tempo di riscaldarsi, consentendo di calettare **utensili in acciaio super rapido e in metallo duro**.

Le temperature ottenute durante la fase di riscaldamento, che normalmente dura pochi secondi, sono pari a circa 300-340°, per cui molto inferiori a temperature che potrebbero creare delle alterazioni strutturali del materiale di cui sono composti i mandrini, per cui è teoricamente possibile eseguire il processo un numero infinito di volte senza avere deformazioni permanenti.

This clamping system is based upon the principle of the expansion of steel determined by temperature variations. By increasing the taper shank temperature in the area that must be expanded, an enlargement of the internal diameter is obtained, thus enabling the fitting of a cylinder stem tool. When cooling down the taper shank, the normal size of the internal bore is restored, creating a constant high pressure on the whole surface touching the tool. The result is a highly homogeneous connection between taper shank and tool with very high radial clamping force which creates a rigid and precise system. By using the magnetic induction heating system it is possible to achieve a very fast heating of the taper shank before the tool has time enough to be heated.

This enables the shrinking-on of **HSS and solid carbide tools**.

The temperatures obtained during the heating phase, that normally lasts only a few seconds, are about 300-340°, therefore much lower than those that might cause structural alterations in the material of the taper shanks.

Therefore it is theoretically possible to perform the process an infinite number of times without having any permanent.

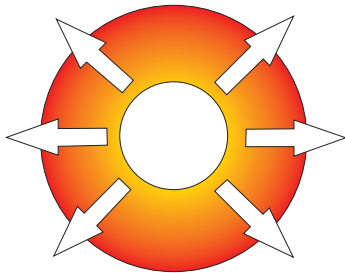

IL CALORE ESPANDE IL DIAMETRO INTERNO
 HEAT EXPANDS THE INSIDE DIAMETER

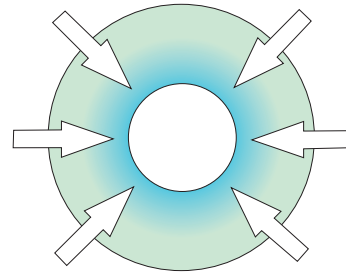

IL RAFFREDDAMENTO RESTRINGE IL DIAMETRO INTERNO
 COOLING CONTRACTS THE INSIDE DIAMETER

VANTAGGI DELLA TECNOLOGIA DEL CALETTAMENTO A CALDO ADVANTAGES OF THE SHRINK-FIT TECHNOLOGY

1. Rapido inserimento ed estrazione dell'utensile
 2. Elevata forza di bloccaggio radiale ed elevata trasmissione di coppia
 3. Notevole diminuzione della forza di bloccaggio ad alte velocità
 4. Maggiore durata dell'utensile e del mandrino
 5. Ottima finitura superficiale del materiale lavorato grazie all'elevata rigidità del sistema di bloccaggio ed alla ridotta tolleranza di concentricità
 6. Ottima rigidità flessionale e radiale
 7. Dimensioni ridotte del mandrino e profilo compatto della sede utensile che riduce al minimo gli ingombri; la sede utensile ha un angolo di 4,5° come da normativa DIN 69882-8
 8. Bloccaggio di utensili in metallo duro ed in acciaio super rapido con tolleranza del gambo h6 secondo DIN 6535HA e DIN 1835A sullo stesso mandrino
 9. Mandrini con elevata durata e stabilità di forma, grazie all'utilizzo di acciaio speciale resistente alle alte temperature e di particolari trattamenti termici
 10. Valori di concentricità nell'accoppiamento mandrino-utensile inferiori a 3 MICRON con ripetibilità assoluta nel tempo
 11. Mandrini progettati con geometria simmetrica senza masse di sbilanciamento adatti per lavorazioni ad alta velocità, per le quali è richiesta una elevata equilibratura dinamica
 12. Flessibilità elevata grazie alla possibilità di combinare i mandrini con prolunghe ed accessori di vario tipo
-
1. Quick installation and removal of the tool
 2. High radial clamping force and high torque transmission
 3. Notable reduction of the clamping force at high speed
 4. Longer tool and taper shank life
 5. Excellent surface finishing of the work piece thanks to the rigidity of the clamping system and low concentricity tolerance
 6. Excellent bending strength and radial rigidity
 7. Small taper shank size and compact profile of the insert pocket to minimize the overall dimensions; the tool seat features a corner of 4,5° according to DIN 69882-8
 8. Clamping of solid carbide and HSS tools with h6 tolerance for the stem according to DIN 6535HA and DIN 1835A on the same taper shank
 9. Taper shanks with high resistance and shape stability thanks to the use of special steel resistant to high temperatures and special heat treatments
 10. Concentricity values in the connection between tool and taper shank lower than 3 micron with absolute repeatability over time
 11. Taper shanks designed with symmetrical geometry without unbalancing masses, suitable for high speed machining which, however requires a high dynamic balancing
 12. High flexibility thanks to the possibility of combining the taper shanks with extensions and accessories of various type

MANDRINO A CALETTAMENTO TERMICO
SHRINKING-ON TAPER SHANKS
WERKZEUGAUFNAHMEN MIT SCHRUMPFVERBINDUNG
MANDRIN À EMBOÎTEMENT THERMIQUE

CTS

I mandrini CTS sono la **prima scelta** per l'impiego di questa tecnologia in quanto rappresentano l'equilibrio ideale tra ingombro, rigidità e trasmissione di coppia. Le dimensioni di ingombro sono secondo la normativa DIN 69882-8. Visto il loro largo impiego é disponibile una vasta gamma di dimensioni con fori di calettamento da Ø3 a Ø32 in versione corta e lunga. Questi mandrini sono stati progettati e realizzati principalmente per ridurre al minimo gli ingombri nella zona di taglio.

The CTS taper shanks are the **first choice** for the application of this technology since they represent the perfect combination of reduced dimensions, rigidity and torque transmission. The overall dimensions comply with the requirement set down in DIN 69882-8. Being widely used, they are available in a large range of sizes with shrinking-on bores varying from Ø3 to Ø32, in short and long versions. These taper shanks were designed and manufactured mainly to reduce obstacles in the cutting area to the minimum.

STATO DI EQUILIBRATURA - BALANCING STATUS

SK - DIN 69871		HSK - DIN 69893		BT - MAS 403		ISO 26623-1	
MANDRINI EQUILIBRATI CON FORI FILETTATI PER EQUILIBRATURA FINE PRE-BALANCED TAPER SHANKS WITH THREADED BORES FOR FINE BALANCING							
SK 040	Rpm 25000 G.2,5	HSK 63 A	Rpm 25000 G.2,5	BT 040	Rpm 25000 G.2,5	PSC63	Rpm 25000 G.2,5
SK 050	Rpm 25000 G.2,5	HSK 100 A	Rpm 25000 G.2,5	BT 050	Rpm 25000 G.2,5	PSC80	Rpm 25000 G.2,5

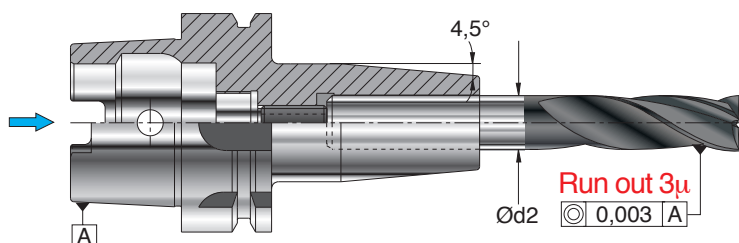

Utilizzare utensili con gambo cilindrico in tolleranza h6 o inferiore.
Use tools with cylinder shaft in h6 tolerance or lower.

MANDRINO A CALETTAMENTO TERMICO PROLUNGABILE
EXTENSIBLE SHRINK FIT
VERLÄNGERBARES SCHRUMPFUTTER
MANDRIN PROLONGEABLE À EMBOÎTEMENT THERMIQUE

CTPN

Questa versione è consigliata unitamente all'utilizzo di **utensili a gambo lungo, prolunghe cilindriche** a calettamento termico dell'utensile, prolunghe cilindriche in metallo duro antivibrante e nell'impiego sia in fresatura che alesatura di fori, dove si voglia sfruttare la possibilità di regolazione della sporgenza utile dell'utensile, ottimizzandone al meglio l'impiego.

This version is recommended together with the use of **long stem tools**, tool shrink coupling **cylindrical extensions**, cylindrical extensions in nonvibrating solid carbide and for the application both in milling and the boring of holes, to exploit the regulation possibilities of the tool's useful protrusion and optimize the machining results to the best possible level.

STATO DI EQUILIBRATURA - BALANCING STATUS

SK - DIN 69871		HSK - DIN 69893		BT - MAS 403	
MANDRINI EQUILIBRATI CON FORI FILETTATI PER EQUILIBRATURA FINE PRE-BALANCED TAPER SHANKS WITH THREADED BORES FOR FINE BALANCING					
SK 040	Rpm 25000 G.6,3	HSK 63 A	Rpm 25000 G.6,3	BT 040	Rpm 25000 G.6,3
SK 050	Rpm 25000 G.6,3	HSK 100 A	Rpm 25000 G.6,3	BT 050	Rpm 25000 G.6,3

Utilizzare utensili con gambo cilindrico in tolleranza h6 o inferiore. - Use tools with cylinder shaft in h6 tolerance or lower.

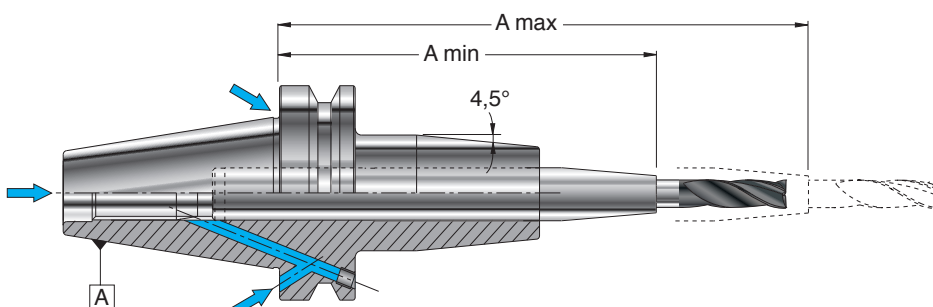

G - CLASSE DI EQUILIBRATURA (NORMA ISO 1940)
G - BALANCING CLASS (STANDARD ISO 1940)

G (mm/sec)	= velocità del baricentro	= Barycenter speed
E (g·mm/kg - µm)	= Squilibrio totale residuo accettabile per unità di massa (squilibrio residuo specifico) o scostamento della massa dal baricentro	= Total acceptable residual imbalance per unit of mass (specific residual imbalance) or deviation of the mass from the barycenter
ω (rad/sec - sec ⁻¹)	= velocità angolare	= Angular speed
n (giri/min - min ⁻¹)	= velocità di rotazione	= Rotation speed

$$G \text{ (mm/sec)} = \frac{E \cdot \omega}{1000}$$

$$E \text{ (g·mm/kg - } \mu\text{m)} = \frac{G \cdot 1000}{\omega}$$

$$\omega \text{ (rad/sec - sec}^{-1}\text{)} = \frac{n \cdot 3,14}{30}$$

E (g·mm/kg - µm)

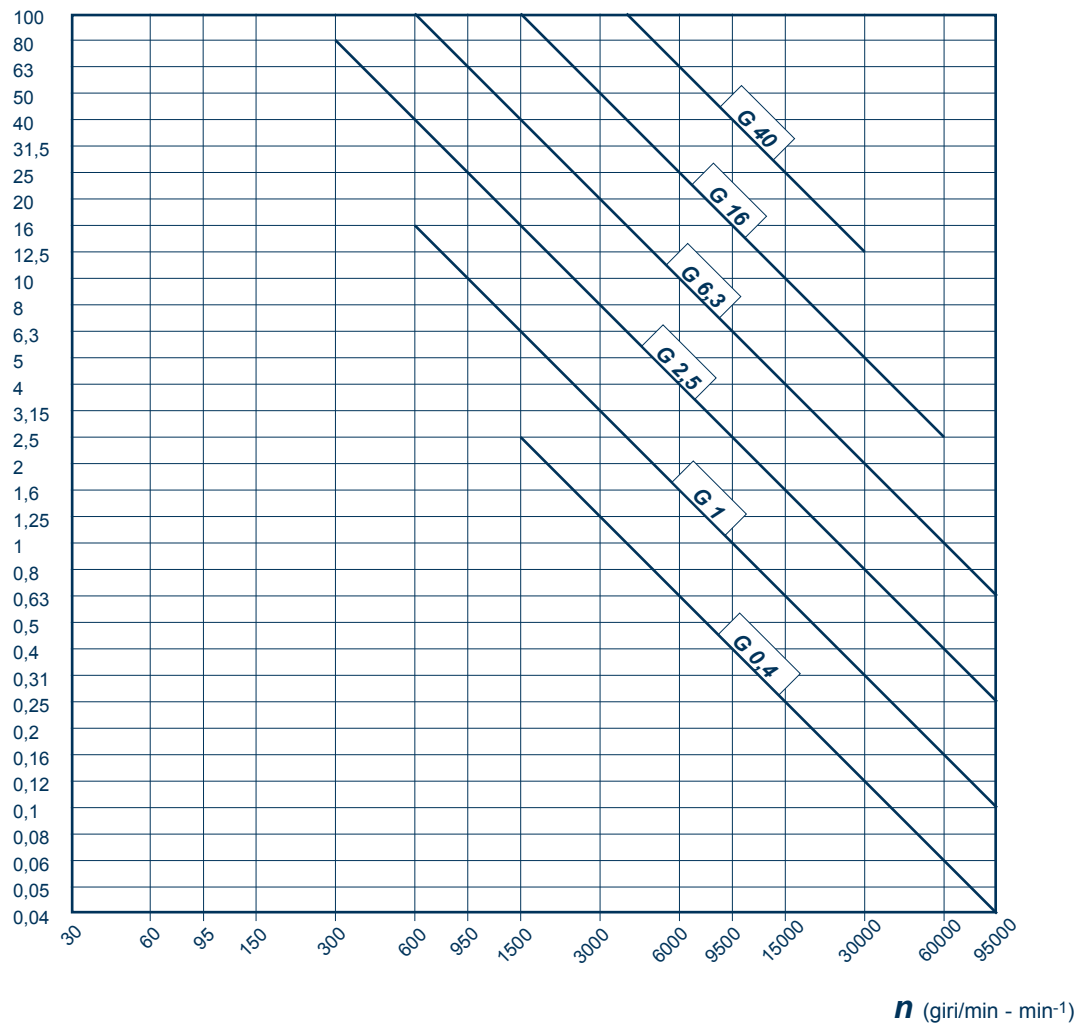

VANTAGGI CON L'EQUILIBRATURA DEGLI UTENSILI

- Aumenta la vita dell' utensile
- Aumenta la vita del mandrino
- Minori sollecitazioni meccaniche della macchina
- Migliora la rugosità delle superfici lavorate
- Tolleranze dimensionali più strette
- Migliora la qualità del prodotto

- ADVANTAGES OF BALANCING THE TOOLS

- Increased tool life
- Increased chuck life
- Less mechanical stress on the machine
- Improved roughness of machined surfaces
- Reduced dimensional tolerance
- Improved product quality

**SQUILIBRIO ED EQUILIBRATURA
BALANCING AND IMBALANCE**

- Lo squilibrio **U**, é lo scostamento tra l' asse di rotazione e l' asse geometrico (o baricentro). Viene anche definito come disuniformità di materiale rispetto all'asse di rotazione. Lo squilibrio indica la distanza di masse eccentriche in senso radiale, rispetto all'asse di rotazione.
- Lo squilibrio genera una FORZA CENTRIFUGA **F**, che cresce con il quadrato della velocità.
- L'EQUILIBRATURA ha lo scopo di limitare lo squilibrio residuo di un corpo rotante a valori logici in termini tecnici ed economici.
- La norma ISO 1940 definisce la classe di equilibratura per ogni tipo di corpo rotante allo scopo di definire uno squilibrio residuo accettabile che eviti eccessi di costi e grosse mancanze di equilibratura per lo scopo del rotante stesso.
- Per le macchine utensili e parti di macchine utensili la Norma ISO1940 stabilisce che é sufficiente una classe di equilibratura G6,3, classi superiori sono spesso inutili in quanto le eccentricità che si verificano in macchina durante l'uso, sono superiori a quelle dell'equilibratura.
- The imbalance **U** is the difference between the axis of rotation and the geometric (or barycentric) axis. It is also defined as a material unevenness in relation to the axis of rotation. The imbalance indicates the distance of eccentric masses in a radial direction, in relation to the axis of rotation.
- The imbalance generates a CENTRIFUGAL FORCE **F** which increases in proportion to the speed.
- The purpose of the BALANCING is to limit the residual imbalance of a rotating body to logical values in technical and economic terms.
- The Standard ISO 1940 defines the BALANCING CLASS for each type of rotating body, with the purpose of defining the acceptable residual imbalance that avoids excessive costs and large lacks of balancing for the purpose of the rotation itself.
- For machine tools and machine tool parts Standard ISO1940 establishes that a balancing class of G6.3 is sufficient; higher classes are often not useful because the eccentricities that exist in the machine during use are greater than the balancing eccentricities.

F (N)	= forza centrifuga rotante	= Rotating centrifugal force
U (g·m)	= squilibrio	= Imbalance
ω (rad/sec - sec ⁻¹)	= velocità angolare	= Angular speed
M (Kg)	= Massa del rotante	= Rotation mass
e (µm)	= scostamento del baricentro, eccentricità	= Deviation of barycenter, eccentricity
m (g)	= Massa di equilibratura	= Balancing mass
r (mm)	= Raggio su cui eseguire l'equilibratura	= Radius upon which balancing is performed
m_a (g)	= Massa residua accettabile	= Acceptable residual mass

$$F(N) = U \cdot \omega^2$$

$$U(g \cdot m) = M \cdot e$$

$$m(g) = \frac{M \cdot e}{r}$$

$$m_a(g) = \frac{M \cdot E}{r}$$

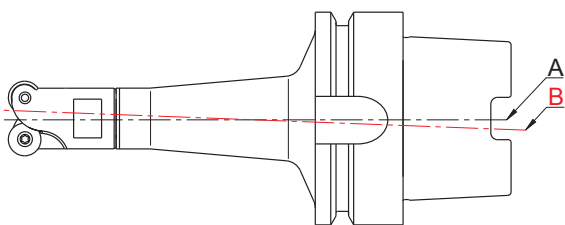

A - Asse di rotazione - Axis of rotation
B - Asse geometrico - Geometric axis or barycenter

**EQUILIBRATURA PER ASPORTAZIONE
BALANCING BY REMOVAL**

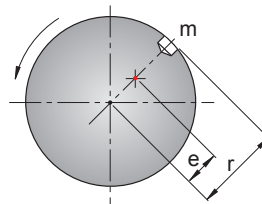

**EQUILIBRATURA PER APPORTO
BALANCING BY ADDING MATERIAL**

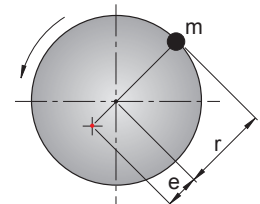

- Vengono considerati 2 tipi di squilibrio e relativa equilibratura : **STATICO** se misurato su di un unico piano, **DINAMICO** se misurato su 2 piani.
- I valori riportati nella tabella della classe di equilibratura, sono riferiti a squilibrio statico, per lo squilibrio dinamico $e=e/2$ per ogni piano di equilibratura
- Two types of imbalance and corresponding balancing are taken into consideration: **STATIC** if measured on a single surface and **DYNAMIC** if measured on 2 surfaces.
- The values listed in the table of balancing classes refer to static imbalance; for dynamic imbalance $e=e/2$ for each balancing surface



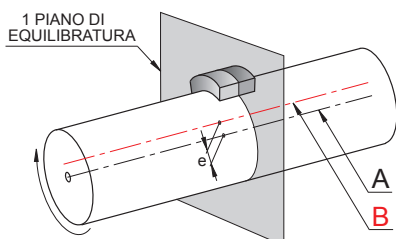

**SQUILIBRIO STATICO (per utensili corti)
STATIC IMBALANCE (for short tools)**

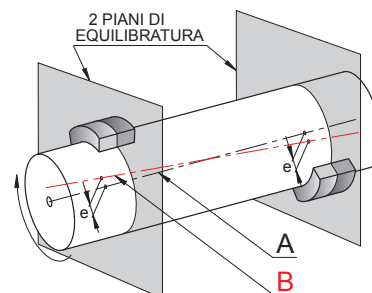



**SQUILIBRIO DINAMICO (per utensili lunghi)
DYNAMIC IMBALANCE (for long tools)**





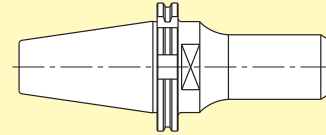

-  **EQUILIBRATURA / PRE-EQUILIBRATURA**
-  **BALANCING / PRE-BALANCING**
-  **AUSWUCHTUNG / DIE AUSWUCHTUNG**
-  **EQUILIBRAGE / PRE-EQUILIBRAGE**



-  - La pre-equilibratura consiste nella correzione degli squilibri teorici delle asimmetrie dei mandrini, calcolate mediante sistemi di progettazione CAD 3D.
- La pre-equilibratura si calcola solamente sul corpo mandrino senza accessori e ricambi, ad esclusione dei mandrini **WE** e **PU**, i quali sono pre-equilibrati calcolando la posizione teorica della vite di bloccaggio dell'utensile.
- I valori teorici di pre-equilibratura sono riportati sotto, per rotazioni superiori a quelle calcolate, si consiglia di effettuare una operazione aggiuntiva di equilibratura finale (Vedi **PAG** 1189).
- Alcuni mandrini sono forniti già equilibrati, in questo caso viene segnalato con una nota specifica..

-  - Pre-balancing consists in the correction of the theoretical imbalances of the chucks' asymmetries, calculated by means of CAD 3D design systems
- Pre-balancing is calculated only on the chuck body without accessories or spare parts, with the exception of **WE** and **PU** chucks which are balanced by calculating the theoretical position of the tool locking screws.
- The theoretical values of pre-balancing are listed below, for rotation speeds higher than those that are calculated, it is advisable to perform an additional final balancing operation (Refer to **PAGE** 1189).
- Some chucks have already been balanced before leaving the factory, in this case a specific note to this effect will be included.

-  - Die auswuchtung besteht in der korrektur der theoretischen ungleicheiten der aufnahmen symmetrien, die mit planungssystemen CAD 3D errechnet werden.
- Die auswuchtung wird nur für den aufnahmekörpern ohne zubehör und ersatzteile berechnet, ausschliesslich der aufnahmen **WE** und **PU**, die ausgewuchtet werden, indem die theoretische position der befestigungsschraube des werkzeugs berechnet wird.
- Die theoretischen werte der auswuchtung werden unten angeführt, übersteigen die drehungen jene berechneten, wird empfohlen zusätzlich eine endauswuchtung vorzunehmen (Siehe **SEITE** 1189)
- Einige aufnahmen werden bereits ausgewuchtet geliefert, diese sind gekennzeichnet.

-  - Le pré-équilibrage consiste à corriger les déséquilibres théoriques des asymétries des mandrins calculées selon des systèmes CAO (conception assistée par ordinateur) 3D
- Le pré-équilibrage se calcule seulement sur le corps du mandrin sans accessoire ni pièce de rechange à l'exception des mandrins **WE** et **PU**, qui sont pré-équilibrés en calculant la position théorique de la vis de blocage de l'outil.
- Les valeurs théoriques de pré-équilibrage sont reprises ci-dessous. pour des rotations supérieures a celles calculées, il est conseillé d'effectuer une opération supplémentaire d'équilibrage final (Voir **PAGE** 1189)
- Certains mandrins sont fournis déjà équilibrés et cela est signalé par une note spécifique.

HSK-DIN 69893 (63)		HSK-DIN 69893 (100)	
G 6,3 8000 min ⁻¹		G 6,3 8000 min ⁻¹	
G 6,3 10000 min ⁻¹		G 2,5 20000 min ⁻¹	
G 6,3 15000 min ⁻¹		G 2,5 25000 min ⁻¹	
G 2,5 20000 min ⁻¹			
G 2,5 25000 min ⁻¹			
DIN 69871 (40)		DIN 69871 (50)	
G 6,3 8000 min ⁻¹		G 6,3 6000 min ⁻¹	
G 6,3 15000 min ⁻¹		G 6,3 8000 min ⁻¹	
G 2,5 20000 min ⁻¹		G 2,5 20000 min ⁻¹	
G 2,5 25000 min ⁻¹		G 2,5 25000 min ⁻¹	
MAS-403-BT (40)		MAS-403-BT (50)	
G 6,3 8000 min ⁻¹		G 6,3 6000 min ⁻¹	
G 6,3 15000 min ⁻¹		G 6,3 8000 min ⁻¹	
G 2,5 20000 min ⁻¹		G 2,5 20000 min ⁻¹	
G 2,5 25000 min ⁻¹		G 2,5 25000 min ⁻¹	
ISO 26623-1 (PSC40)	ISO 26623-1 (PSC50)	ISO 26623-1 (PSC63)	ISO 26623-1 (PSC80)
G 6,3 8000 min ⁻¹	G 6,3 8000 min ⁻¹	G 6,3 8000 min ⁻¹	G 2,5 25000 min ⁻¹
		G 2,5 25000 min ⁻¹	

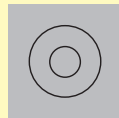

- CONCENTRICITÀ TRA ATTACCO E SEDE UTENSILE**
- CONCENTRICITY BETWEEN ATTACHMENT AND TOOL SEAT**
- KONZENTRIZITÄT ZWISCHEN AUFNAHME UND WERKZEUGSITZ**
- CONCENTRICITÉ ENTRE FIXATION ET LOGEMENT OUTIL**

HSK DIN 69893 - DIN 69871 - MAS 403 BT

HSK-DIN 69893	
0,01	
0,003	
0,004	
0,005	
DIN 69871	
0,01	
0,003	
0,004	
0,005	
MAS-403-BT	
0,01	
0,003	
0,004	
0,005	
ISO 26623-1	
0,003	
0,004	

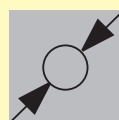
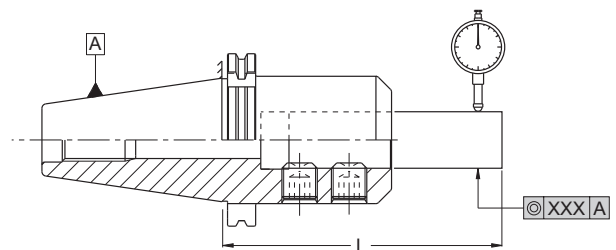

- TOLLERANZA FORI DEI MANDRINI**
- BORE TOLERANCE FOR CHUCKS**
- TOLERANZ AUFNAHMENBOHRUNGEN**
- TOLÉRANCE TROUS DES MANDRINS**

HSK DIN 69893 - DIN 69871 - MAS 403 BT

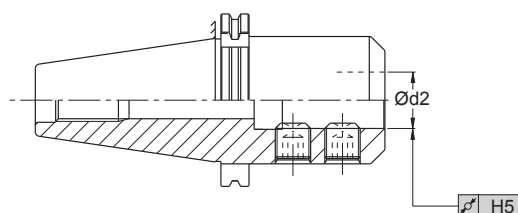

INFORMAZIONI PER IL FISSAGGIO A VITE DEGLI INSERTI
INFORMATION FOR FASTENING INSERTS WITH SCREW



- Applicare MOLYKOTE Sul filetto e sotto la testa della vite
- Apply MOLYKOTE on the thread and under the head of the screw

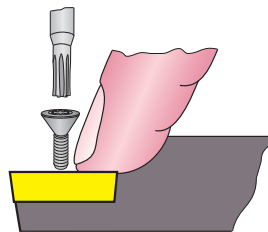

- Prima di serrare la vite, assicurarsi che l'inserto aderisca bene sugli appoggi e sul fondo della sede come indicato in figura
- Per non danneggiare le viti e per avere un montaggio corretto usare un cacciavite dinamometrico
- ATTENZIONE: se il pretensionamento diminuisce, sostituire la vite di bloccaggio.
- Before tightening the screw, make sure that the insert properly adheres to the supports and to the bottom of the seat as shown in the figure.
- So as not to damage the screws and to correctly perform the installation, use a dynamometric screwdriver.
- IMPORTANT: if the pre-tightening lessens, replace the fastening screw

**ATTACCO CILINDRICO
 CYLINDRICAL SHANK**

DIN 6535

METALLO DURO - CARBIDE

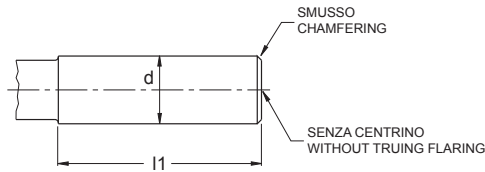

FORMA - FORM HA

d	$l1$	d	$l1$
2	28	12	45
3		14	
4		48	16
5			18
6	36	20	50
8		25	56
10	40	32	60

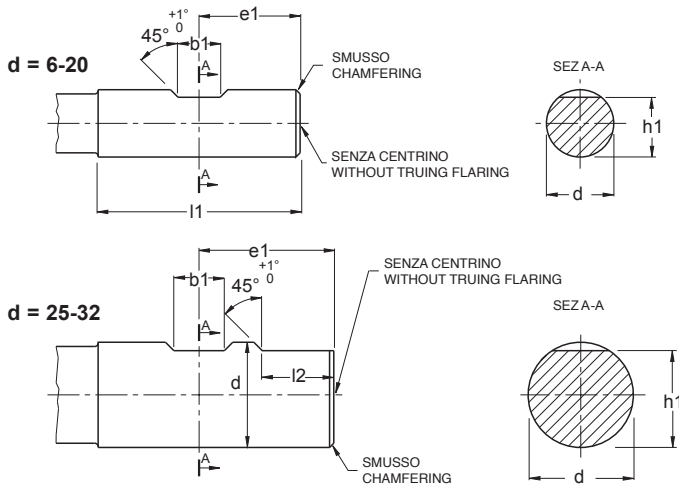

FORMA - FORM HB (WELDON)

d	$b1$	$e1$	$h1$	$l1$	$l2$
6	4,2	18,0	5,1	36	-
8	5,5		6,9		
10	7,0	20,0	8,5	40	
12	8,0	22,5	10,4	45	
14			12,7		
16	10,0	24,0	14,2	48	
18			16,2		
20	11,0	25,0	18,2	50	17
25	12,0	32,0	23,0	56	
32	14,0	36,0	30,0	60	19

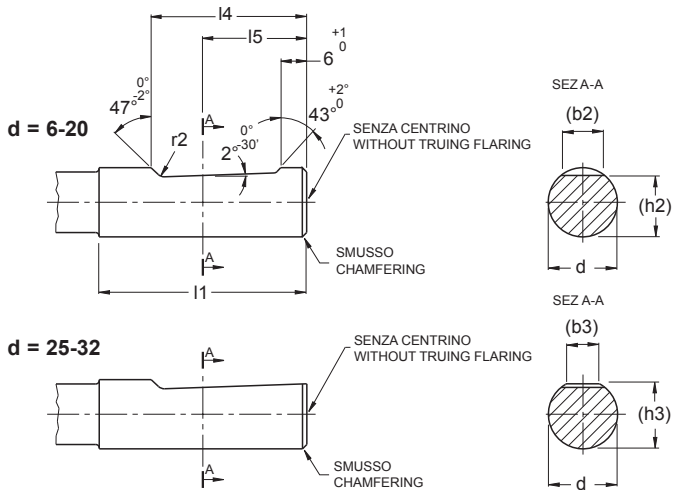

FORMA - FORM HE (WHISTLE-NOTCH)

d	$(b2) \approx (b3)$	$h2$	$(h3)$	$l1$	$l4$	$l5$	$r2$ min
6	4,3	-	5,1	-	36	25	18
8	5,5	-	6,9	-		28	20
10	7,1	-	8,5	-	45	33	22,5
12	8,2	-	10,4	-		36	24
14	8,1	-	12,7	-	48	38	25
16	10,1	-	14,2	-		44	32
18	10,8	-	16,2	-	56	48	35
20	11,4	-	18,2	-		50	38
25	13,6	9,3	23,0	24,1	60	48	35
32	15,5	9,9	30,0	31,2	60	48	35

ATTACCO SHANK

DIN 1809

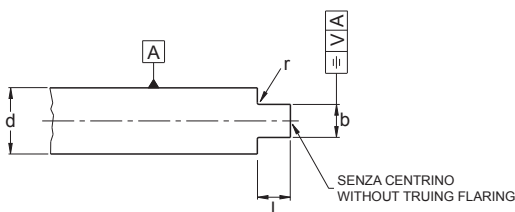

d	b	l	r	v	d	b	l	r	v
3+3,5	1,6	2,2	0,2	0,05	>15+18	8,0	8,0	0,4	0,08
>3,5+4	2,0	2,2	0,2		>18+21	10,0	10,0	0,4	
>4+4,5	2,2	2,5	0,2		>21+24	11,0	11,0	0,6	0,10
>4,5+5,5	2,5	2,5	0,2		>24+27	13,0	13,0	0,6	
>5,5+6,5	3,0	3,0	0,2		>27+30	14,0	14,0	0,6	
>6,5+8	3,5	3,5	0,2	0,06	>30+34	16,0	16,0	0,6	0,15
>8+9,5	4,5	4,5	0,4		>34+38	18,0	18,0	0,6	
>9,5+11	5,0	5,0	0,4		>38+42	20,0	19,0	0,6	
>11+13	6,0	6,0	0,4		>42+46	22,0	20,0	1,0	
>13+15	7,0	7,0	0,4		0,08	>46+50	24,0	22,0	1,0

**ATTACCO CILINDRICO
 CYLINDRICAL SHANK**

DIN 1835

ACCIAIO - STEEL

FORMA - FORM A

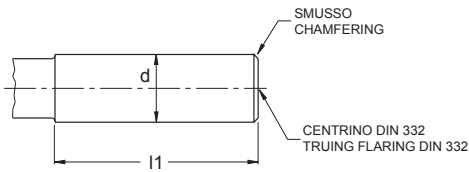

d	$h6$	$l1$	$+2_0$
3			
4		28	
5			
6		36	
8		40	
10		45	
12			

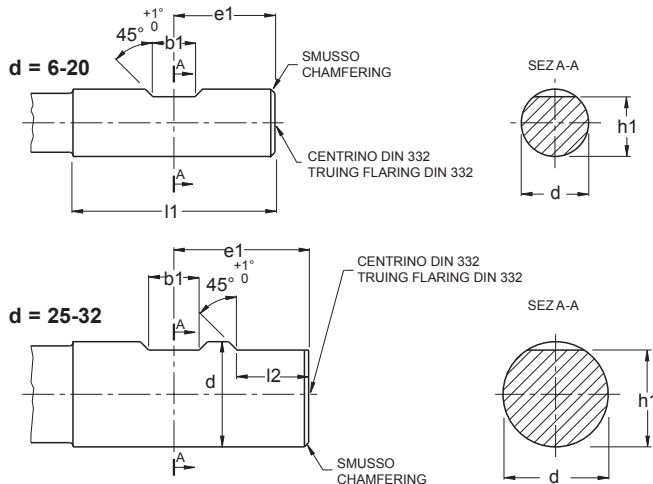

FORMA - FORM B (WELDON)

d	$h6$	$b1$	$+0,05_0$	$e1$	0^{-1}	$h1$	$h13$	$l1$	$+2_0$	$l2$	$+1_0$
6		4,2		18,0		4,8		36			
8		5,5		20,0		6,6		40			
10		7,0		22,5		8,4		45			
12		8,0		24,0		10,4		48			
16		10,0		25,0		14,2		50			
20		11,0		32,0		18,2		56		17	
25		12,0		36,0		23,0		60		19	
32		14,0		40,0		27,0		70		23	
40		18,0		45,0		30,0		80			
50				50,0		36,8		90			
63						40,8					

FORMA - FORM E (WHISTLE-NOTCH)

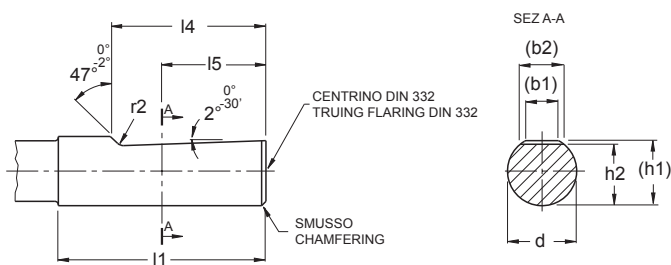

d	$h6$	$(b1) \approx (b2)$	$(h1)$	$h2$	$h13$	$l1$	$+2_0$	$l4$	0^{-1}	$l5$	$r2$	min
6		3,5	4,8	5,4	4,8	36		25		18		
8		4,7	6,1	7,2	6,6	40		28		20		1,2
10		5,7	7,3	9,1	8,4	45		33		22,5		
12		6,0	8,2	11,2	10,4	48		36		24		
16		7,6	10,1	15,0	14,2	50		38		25		1,6
20		8,4	11,5	19,1	18,2	56		44		32		
25		9,3	13,6	24,1	23,0	60		48		35		
32		9,9	15,5	31,2	30,0							

**ATTACCO CONO MORSE
 MORSE CONE ARBOR**

UNI-ISO 296

ACCIAIO - STEEL

FORMA - FORM AE

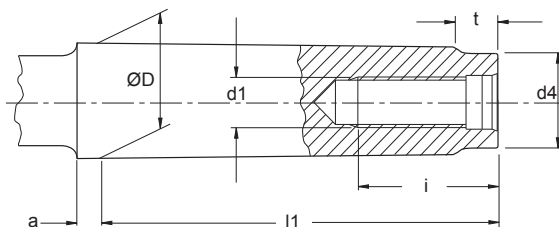

N°	ØD	a	d1	d4 max	l1 max	i min	t max
1	12,065	3,5	M6	9	53,5	16	5
2	17,780	5	M10	14	64	24	5
3	23,825	5	M12	19	81	24	7
4	31,267	6,5	M16	25	102,5	32	9
5	44,399	6,5	M20	35,7	129,5	40	10

FORMA - FORM AI

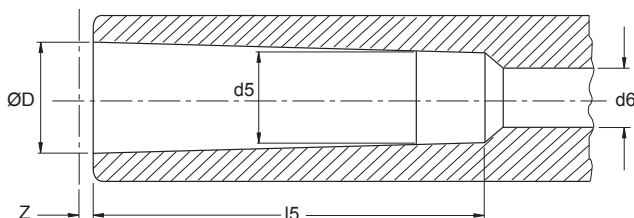

N°	ØD	Z	$d5$	$d6$	$l5$	min
1	12,065	1	9,7	7	56	
2	17,780	1	14,9	11,5	67	
3	23,825	1	20,2	14	84	
4	31,267	1,5	26,5	18	107	
5	44,399	1,5	38,2	23	135	

ATTACCO CON CHIAVETTA DI TRASCINAMENTO
TOOL-SYSTEM WITH KEY DRIVE

DIN 138

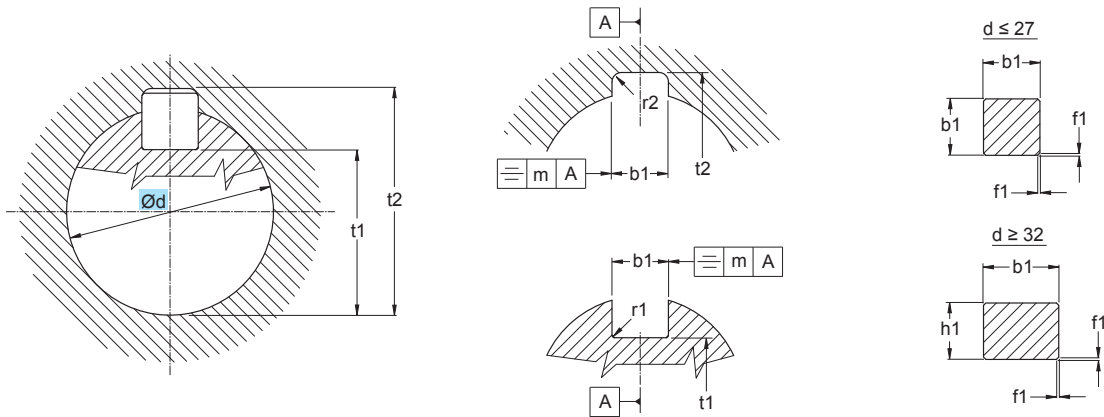

d	$b1$	$h1$	$t1$	$t2$	$r1$	$r2$	$f1$	m
16	4	-	$13,2^{0}_{-0,1}$	$17,7^{+0,1}_{0}$	$0,16^{0}_{-0,08}$	$0,6^{0}_{-0,2}$	$0,16^{+0,09}_{0}$	0,1
22	6	-	$17,6^{0}_{-0,1}$	$24,1^{+0,1}_{0}$	$0,25^{0}_{-0,09}$	$1,0^{0}_{-0,3}$	$0,25^{+0,15}_{0}$	
27	7	-	$22,0^{0}_{-0,2}$	$29,8^{+0,2}_{0}$		$1,2^{0}_{-0,3}$		
32	8	7	$27,0^{0}_{-0,2}$	$34,8^{+0,2}_{0}$	$0,40^{0}_{-0,15}$	$0,4^{+0,2}_{0}$		
40	10	8	$34,5^{0}_{-0,2}$	$43,5^{+0,2}_{0}$				
50	12	8	$44,5^{0}_{-0,2}$	$53,6^{+0,2}_{0}$	$1,6^{0}_{-0,5}$			

ATTACCO MODULARE FILETTATO
MODULAR THREADED TOOL-SYSTEM

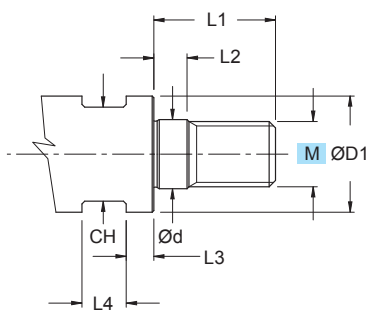

M	$\varnothing d$	$\varnothing D1$	$L1$	$L2$	$L3$	$L4$	CH
5	5,5	8	12	4,7	-	4,5	6
6	6,5	9,7	14,7	6	2	6	8
8	8,5	13	17	5	3	6	10
10	10,5	18	19	5	4	8	15
12	12,5	21,0	22	5	5	8	17
16	17,0	29,0	24	5	8	10	24

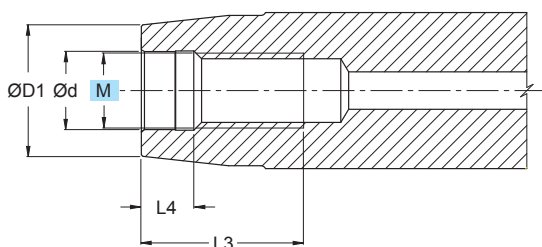

M	$\varnothing d$	$\varnothing D1$	$L3$	$L4$			
5	5,5	8	16,5	6,5			
6	6,5	10	18	7			
8	8,5	9,3	20	8			
10	10,5	18	24	8			
12	12,5	21	26	8,5			
16	17	29	30	9,5			

ATTACCO A TRASCINAMENTO FRONTALE, COMPATIBILE
ATTACHMENT WITH FRONT DRIVE, COMPATIBLE

ISO 6462

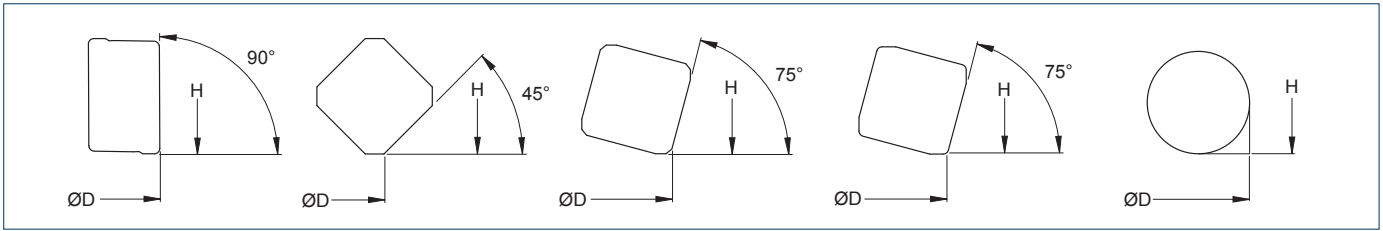

FORMA - FORM A

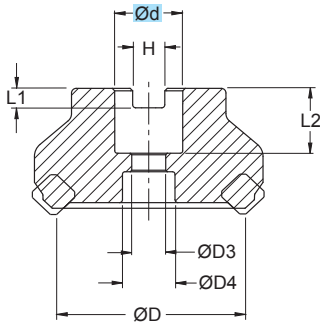

H7 Ød	ØD	ØD3	ØD4	H11 H	H12 L1	^{+0,5} ₀ L2		
16	32-40	8,5	13,5	8,4	5,6	19		
22	50-63	11	18,0	10,4	6,3	21		
27	80	13	20,0	12,4	7,0	24		
32	100	17	26,0	14,4	8,0	25		
40	125	22	32,0	16,4	9,0	30		

FORMA - FORM B

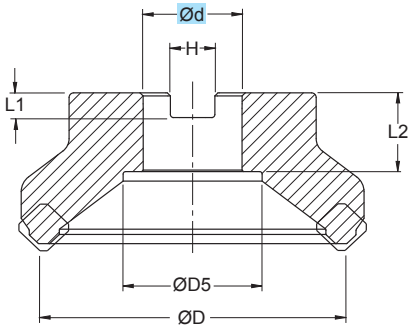

H7 Ød	ØD	ØD5	H11 H	H12 L1	^{+0,5} ₀ L2		
27	80	38	12,4	7,0	24		
32	100	45	14,4	8,0	25		
40	125	56	16,4	9,0	30		

FORMA - FORM C Ød = 40 D Ød = 60

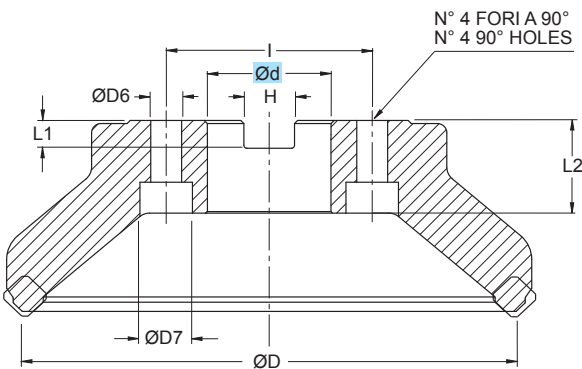

H7 Ød	ØD	ØD6	ØD7	H11 H	I	H12 L1	^{+0,5} ₀ L2
40	125-160	14	-	16,4	66,7	9,0	30
60	200-250	18	26	25,7	101,6	14,0	-

FORMA - FORM E

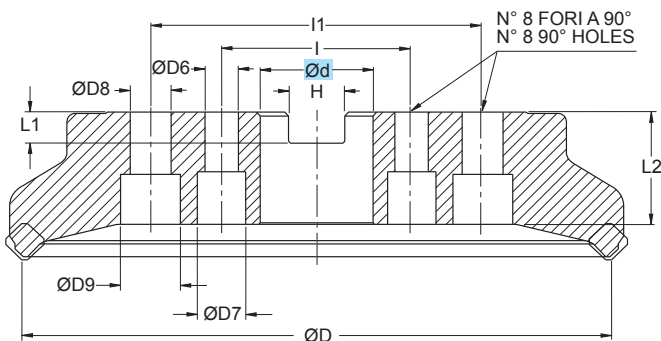

H7 Ød	ØD	ØD6	ØD7	ØD8	ØD9	H11 H	H12 I	H12 I1	L1	^{+0,5} ₀ L2
60	315	18	26	22	34	14	101,6	177,8	14	60

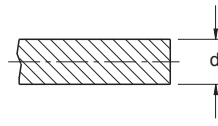
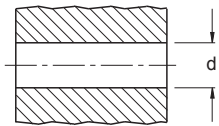







SCOSTAMENTO DEI FORI IN μm
BORE DEVIATION EXPRESSED IN μm







SCOSTAMENTO DEGLI ALBERI IN μm
SHAFTS DEVIATION EXPRESSED IN μm







d	F6	H7		d11	e9	g6	h5	h6	h7	h8	h10	m7
0÷3	+12 +6	+10 0		-20 -80	-14 -39	-2 -8	0 -4	0 -6	0 -10	0 -14	0 -40	+14 +4
>3÷6	+18 +10	+12 0		-30 -105	-20 -50	-4 -12	0 -5	0 -8	0 -12	0 -18	0 -48	+20 +8
>6÷10	+22 +13	+15 0		-40 -130	-25 -61	-5 -14	0 -6	0 -9	0 -15	0 -22	0 -58	+25 +10
>10÷18	+27 +16	+18 0		-50 -160	-32 -75	-6 -17	0 -8	0 -11	0 -18	0 -27	0 -70	+30 +12
>18÷30	+33 +20	+21 0		-65 -195	-40 -92	-7 -20	0 -9	0 -13	0 -21	0 -33	0 -84	+36 +15
>30÷50	+41 +25	+25 0		-80 -240	-50 -112	-9 -25	0 -11	0 -16	0 -25	0 -39	0 -100	+42 +17
>50÷80	+49 +30	+30 0		-100 -290	-60 -134	-10 -29	0 -13	0 -19	0 -30	0 -46	0 -120	+50 +20
>80÷120	+58 +36	+35 0		-120 -340	-72 -159	-12 -34	0 -15	0 -22	0 -35	0 -54	0 -140	+58 +23
>120÷180	+68 +43	+40 0		-145 -395	-85 -185	-14 -39	0 -18	0 -25	0 -40	0 -63	0 -160	+67 +27
>180÷250	+79 +50	+46 0		-170 -460	-100 -215	-15 -44	0 -20	0 -29	0 -46	0 -72	0 -185	+77 +31
>250÷315	+88 +56	+52 0		-190 -510	-110 -240	-17 -49	0 -23	0 -32	0 -52	0 -81	0 -210	+86 +34
>315÷400	+98 +62	+57 0		-210 -570	-125 -265	-18 -54	0 -25	0 -36	0 -57	0 -89	0 -230	+94 +37
>400÷500	+108 +68	+63 0		-230 -630	-135 -290	-20 -60	0 -27	0 -40	0 -63	0 -97	0 -250	+103 +40







GRUPPI DI MATERIALE - MATERIALS GROUP







DIN ISO 513	MATERIALE MATERIAL	TIPO DI LEGA ALLOYS TYPE	STATO STATE	HB ¹⁾ HRC ²⁾ N/mm ²	VDI 3323 GR.
P	ACCIAIO NON LEGATO, ACCIAIO FUSO NOT-ALLOY STEEL, CAST STEEL	C < 0,15 %	Ricotto (di addolcimento) - Annealed(soft)	125	1
		C < 0,15-0,55 %	Ricotto (di addolcimento) - Annealed(soft)	190	2
			Bonificato - Quenched and Tempered	250	3
		C > 0,55 %	Ricotto (di addolcimento) - Annealed(soft)	220	4
			Bonificato - Quenched and Tempered	300	5
		ACCIAIO DEBOLMENTE LEGATO LOW-ALLOY STEEL	Ricotto (di addolcimento) - Annealed(soft)	180	6
	Bonificato - Quenched and Tempered		250/300	7/8	
	Bonificato - Quenched and Tempered		350	9	
	ACCIAIO ALTO LEGATO, ACCIAIO DA UTENSILI HIGH ALLOY STEEL, TOOL STEEL	Ricotto (di addolcimento) - Annealed(soft)	200	10	
		Bonificato - Quenched and Tempered	325	11	
	ACCIAIO INOSSIDABILE STAINLESS STEEL	Ferritico/ Martensitico - Ferritic/ Martensitic	200	12	
		Martensitico/Indurito x Precipitazione Martensitic/ Precipitation Hardened	240	13	
	M	ACCIAIO INOSSIDABILE STAINLESS STEEL	Austenitico - Austenitic	180	14.1
Duplex (Austenitico/Ferritico) Duplex (Austenitic/Ferritic)			230-260	14.2	
Ferritico / Perlitico - Ferritic / Pearlitic			180	15	
K	GHISA GRIGIA GRAY IRON	G, GG	Perlitico - Pearlitic	260	16
		GHISA A GRAFITE SFEROIDALE, NODULARE NODULAR CAST IRON	GS, GGG	Ferritico - Ferritic	160
	Perlitico - Pearlitic		250	18	
	GHISA MALLEABILE (DURA) MALLEABLE CAST IRON	GMN, GTS/GTW	Ferritico - Ferritic	130	19
			Perlitico - Pearlitic	230	20
	N	LEGHE DI ALLUMINIO ALUMINIUM ALLOYS		Non Invecchiabile - cannot be aged	60
			Invecchiato - Aged	100	22
LEGHE COLATE DI ALLUMINIO CAST ALUMINIUM ALLOYS		Si <= 12 %	Non Invecchiabile - cannot be aged	75	23
		Si > 12 %	Invecchiato - Aged	90	24
RAME E LEGHE DI RAME COPPER, COPPER ALLOYS		Ottone aut. Pb>1% - Free cutting brass	-	110	26
		Ottone, Bronzo - Brass, Bronze	-	90	27
		Bronzo, Rame elettrolitico - Bronze, Electrolytic copper	-	100	28
MATERIALI NON METALLICI NONMETALLIC MATERIALS		Duroplastica, rinf. con fibre - Thermosetting, fiber reinf.	-	-	29
		Gomma dura, Ebanite - Hard rubber, Ebanite	-	-	30
S		LEGHE RESISTENTI AL CALORE HIGH-TEMPERATURE ALLOYS	Base Fe - Fe-Basis	Ricotto (di addolcimento) - Annealed(soft)	200
	Invecchiato - Aged			280	32
	Base Ni o Co - Ni/Co-Basis		Ricotto (di addolcimento) - Annealed(soft)	250	33
			Invecchiato - Aged	350	34
			Colato - Cast	320	35
	TITANIO, LEGHE DI TITANIO TITANIUM, TITANIUM ALLOYS	Titanio puro - pure titan	-	400 ²⁾	36
		Leghe Alfa + Beta - Alpha+Beta alloys	Colato - Cast	1050 ²⁾	37
H	ACCIAIO TEMPRATO HARDENED STEEL		Temprato - Hardened	45 ¹⁾	38.1
			Temprato - Hardened	55 ¹⁾	38.2
			Temprato - Hardened	60 ¹⁾	39.1
			Temprato - Hardened	> 62 ¹⁾	39.2
	GHISA FUSA, GETTI DI GHISA CHILL CAST IRON		Colato - Cast	400	40.1
			Colato - Cast	> 440	40.2
GHISA TEMPRATA HARDENED CAST IRON		Temprato - Hardened	55 ¹⁾	41.1	
		Temprato - Hardened	57 ¹⁾	41.2	
G	GRAFITE GRAPHITE			-	42
R	RESINA PER MODELLI, LEGNO RESIN, WOOD			-	43







								VDI 3323 GR.	
UNI	W/STOFF DIN	AISI	BS	AFNOR	JIS	kc1.1	mc		
ACCIAIO NON LEGATO RICOTTO ANNEALED NOT-ALLOY STEEL						C < 0,15% 125 HB			
CF 10 SPb 20	1.0722	10 SPb 20	11 L 08	-	10 PbF 2	-	1350	0,21	1
CF 9 SMn 28	1.0715	9 SMn 28	1213	230 M 07	S 250	SUM22	1350	0,21	
CF 9 SMn 36	1.0736	9 SMn 36	1215	240 M 07	S 300	-	1350	0,21	
CF 9 SMnPb 28	1.0718	9 SMnPb 28	12 L 13	-	S 250 Pb	SUM22L	1350	0,21	
CF 9 SMnPb 36	1.0737	9 SMnPb 36	12 I 14	-	S 300 Pb	-	1350	0,21	
C15; C16	1.0401	C 15	1015	080 M 15	AF3 7 C 12; XC 18	S15C	1350	0,21	
C20; C21	1.0402	C 22	1020	050 A 20	AF 42 C 20	S20C	1350	0,21	
C 16	1.1141	Ck 15	1015	080 M 15	XC 15; XC 18	S15C	1350	0,21	
ACCIAIO NON LEGATO RICOTTO ANNEALED NOT-ALLOY STEEL						C 0,15-0,55% 180 HB			
C 28 Mn	1.1170	28 Mn 6	1330	150 M 28	20 M 5	SCMn1	1450	0,22	2
-	1.0726	35 S 20	1140	212 M 36	35 MF 4	-	1450	0,22	
-	1.1167	36 Mn 5	-	-	-	SMn438(H)	1450	0,22	
-	1.1157	40 Mn 4	1039	150 M 36	35 M 5	-	1450	0,22	
C 35	1.0501	C 35	1035	060 A 35	AF 55 C 35	S35C	1450	0,22	
C 45	1.0503	C 45	1045	080 M 46	AF 65 C 45	S45C	1450	0,22	
C 45	1.1191	GS-Ck 45	1045	080 M 46	XC 42	S45C	1450	0,22	
C 36	1.1183	Cf 35	-	-	-	S35C	1450	0,22	
C 53	1.1213	Cf 53	-	-	-	S50C	1450	0,22	
ACCIAIO NON LEGATO BONIFICATO QUENCHED AND TEMPERED NOT-ALLOY STEEL						C 0,15-0,55% 250 HB			
C 28 Mn	1.1170	28 Mn 6	1330	150 M 28	20 M 5	SCMn1	1600	0,22	3
-	1.0726	35 S 20	1140	212 M 36	35 MF 4	-	1600	0,22	
-	1.1167	36 Mn 5	-	-	-	SMn438(H)	1600	0,22	
-	1.1157	40 Mn 4	1039	150 M 36	35 M 5	-	1600	0,22	
C 35	1.0501	C 35	1035	060 A 35	AF 55 C 35	S35C	1600	0,22	
C 45	1.0503	C 45	1045	080 M 46	AF 65 C 45	S45C	1600	0,22	
C 45	1.1191	GS-Ck 45	1045	080 M 46	XC 42	S45C	1600	0,22	
C 36	1.1183	Cf 35	-	-	-	S35C	1600	0,22	
C 53	1.1213	Cf 53	-	-	-	S50C	1600	0,22	
ACCIAIO NON LEGATO RICOTTO ANNEALED NOT-ALLOY STEEL						C > 0,55% 220 HB			
C 36 KU	1.1545	C 105 W1	W 110	-	Y1 105	SK3	1600	0,24	4
-	1.1663	C 125 W	W 112	-	Y2 120	SK2	1600	0,24	
C 55	1.0535	C 55	1055	070 M 55	-	S55C	1600	0,24	
C 60	1.0601	C 60	1060	080 A 62	CC 55	-	1600	0,24	
-	1.1274	Ck 101	1095	060 A 96	-	SUP4	1600	0,24	
C 50	1.1203	Ck 55	1055	070 M 55	XC 55	S55C	1600	0,24	
C 60	1.1221	Ck 60	1060	080 A 62	XC 60	S58C	1600	0,24	
-	1.5710	36 NiCr 6	3135	640 A 35	35 NC 6	SNC236	1600	0,24	
-	1.5120	38 MnSi 4	-	-	-	-	1600	0,24	
ACCIAIO NON LEGATO BONIFICATO QUENCHED AND TEMPERED NOT-ALLOY STEEL						C > 0,55% 300 HB			
C 36 KU	1.1545	C 105 W1	W 110	-	Y1 105	SK3	1700	0,24	5
-	1.1663	C 125 W	W 112	-	Y2 120	SK2	1700	0,24	
C 55	1.0535	C 55	1055	070 M 55	-	-	1700	0,24	
C 60	1.0601	C 60	1060	080 A 62	CC 55	-	1700	0,24	
-	1.1274	Ck 101	1095	060 A 96	-	SUP4	1700	0,24	
C 50	1.1203	Ck 55	1055	070 M 55	XC 55	S55C	1700	0,24	
C 60	1.1221	Ck 60	1060	080 A 62	XC 60	S58C	1700	0,24	
-	1.5710	36 NiCr 6	3135	640 A 35	35 NC 6	SNC236	1700	0,24	
-	1.5120	38 MnSi 4	-	-	-	-	1700	0,24	
ACCIAIO DEBOLMENTE LEGATO RICOTTO ANNEALED LOW ALLOY STEEL						180 HB			
-	1.2067	100Cr 6	L 3	BL 3	Y 100 C 6	-	1700	0,24	6
107 WCr 5	1.2419	105 WCr 6	-	-	105 WC 13	SKS2;SKS3	1700	0,24	
-	1.7380	12 CrMo 9 10	A 182-F22	1501-622 Gr.31	10 CD 9. 10	-	1700	0,24	
14 CrMo 4 5	1.7335	13 CrMo 4 4	A 182-F11	1501-620 Gr 27	15 CD 3.5	-	1700	0,24	
-	1.7715	14 MoV 6 3	-	1503-660-440	-	-	1700	0,24	
14 Ni 6	1.5622	14 Ni 6	A 350-LF 5	-	16 N 6	-	1700	0,24	
16 NiCr 11	1.5732	14 NiCr 10	3415	-	14 NC 11	SNC415(H)	1700	0,24	
16 NiCr 11	1.5752	14 NiCr 14	3310;9314	655 M 13	12 NC 15	SNC815(H)	1700	0,24	
-	1.6657	14 NiCrMo 34	-	832 M13	-	-	1700	0,24	
-	1.7015	15 Cr 3	5015	523 M 15	12 C 3	SCr415(H)	1700	0,24	

								VDI 3323 GR.	
UNI	W/STOFF DIN	AISI	BS	AFNOR	JIS	kc1.1	mc		
ACCIAIO DEBOLMENTE LEGATO RICOTTO ANNEALED LOW ALLOY STEEL						180 HB			
-	1.7262	15 CrMo 5	-	-	12 CD 4	SCM415(H)	1700	0,24	
16 Mo3KW	1.5415	15 Mo 3	A 104 Gr A	1501-240	15 D 3	-	1700	0,24	
16 MnCr 5	1.7131	16 MnCr 5	5115	527 M 17	16 MC 5	-	1700	0,24	
16 Mo 5	1.5423	16 Mo 5	4520	1503-245-420	-	-	1700	0,24	
-	1.6587	17 CrNiMo 6	-	820 A 16	18 NCD 6	-	1700	0,24	
20 NiCrMo 2	1.6523	21 NiCrMo 2	8620	805 M 20	20 NCD 2	SNCM220(H)	1700	0,24	
25 CVrMo 4	1.7218	25 CrMo 4	4130	1717 CDS 110	25 CD 4 S	SCM420;SCM430	1700	0,24	
32 CrMo 12	1.7361	32 CrMo 12	-	722 M 24	30 CD 12	-	1700	0,24	
34 Cr 4	1.7033	34 Cr 4	5132	530 A 32	32 C 4	SCr430(H)	1700	0,24	
35 CrMo 4	1.7220	34 CrMo 4	4135; 4137	708 A 37	35 CD 4	SCM432;SCCRM3	1700	0,24	
35 NiCrMo 6	1.6582	34 CrNiMo 6	4340	817 M 40	35 NCD 6	-	1700	0,24	
36 NiCrMo 4	1.6511	36 CrNiMo 4	9840	816 M 40	40 NCD 3	-	1700	0,24	
-	1.8523	39 CrMoV 13 9	-	897 M 39	-	-	1700	0,24	
40 NiCrMo 2	1.6546	40 NiCrMo 2 2	8740	311-TYPE 7	40 NCD 2	SNCM240	1700	0,24	
41 Cr 4	1.7035	41 Cr 4	5140	530 M 40	42 C 4	SCr440(H)	1700	0,24	
41 CrAlMo 7	1.8509	41 CrAlMo 7	A 355 Cl A	905 M 39	40 CAD 6.12	-	1700	0,24	
41 CrMo 4	1.7223	41 CrMo 4	4142; 4140	708 M 40	42 CD 4 TS	SCM440	1700	0,24	
-	1.7045	42 Cr 4	5140	530 A 40	42 C 4 TS	SCr440	1700	0,24	
42 CrMo 4	1.7225	42 CrMo 4	4142; 4140	708 M 40	42 CD 4	SCM440(H)	1700	0,24	
45 WCrV 8 KU	1.2542	45 WCrV 7	S 1	BS 1	-	-	1700	0,24	
50 CrV 4	1.8159	50 CrV 4	6150	735 A 50	50 CV 4	SUP10	1700	0,24	
-	1.7176	55 Cr 3	5155	527 A 60	55 C 3	SUP9(A)	1700	0,24	
-	1.2713	55 NiCrMoV 6	L 6	-	55 NCDV 7	SKT4	1700	0,24	
55 Si 8	1.0904	55 Si 7	9255	240 A 53	55 S 7	-	1700	0,24	
-	1.8161	58 CrV 4	-	-	-	-	1700	0,24	
60 SiCr 8	1.0961	60 SiCr 7	9262	-	60 SC 7	-	1700	0,24	
ACCIAIO DEBOLMENTE LEGATO BONIFICATO QUENCHED AND TEMPERED LOW-ALLOY STEEL						250-300 HB			
-	1.7380	12 CrMo 9 10	A 182-F22	1501-622 Gr.31	10 CD 9. 10	-	1800	0,24	
14 CrMo 4 5	1.7335	13 CrMo 4 4	A 182-F11	1501-620 Gr 27	15 CD 3.5	-	1800	0,24	
-	1.7715	14 MoV 6 3	-	1503-660-440	-	-	1800	0,24	
-	1.5622	14 Ni 6	A 350-LF 5	-	16 N 6	-	1800	0,24	
16 NiCr 11	1.5732	14 NiCr 10	3415	-	14 NC 11	SNC415(H)	1800	0,24	
-	1.5752	14 NiCr 14	3310;9314	655 M 13	12 NC 15	SNC815(H)	1800	0,24	
15 NiCrMo 13	1.6657	14 NiCrMo 13 4	-	-	-	-	1800	0,24	
-	1.7015	15 Cr 3	5015	523 M 15	12 C 3	SCr415(H)	1800	0,24	
-	1.7262	15 CrMo 5	-	-	12 CD 4	SCM415(H)	1800	0,24	
16 Mo3 KW	1.5415	15 Mo 3	A 104 Gr A	1501-240	15 D 3	-	1800	0,24	
16 MnCr 5	1.7131	16 MnCr 5	5115	527 M 17	16 MC 5	-	1800	0,24	
-	1.5423	16 Mo 5	4520	1503-245-420	-	-	1800	0,24	
-	1.6587	17 CrNiMo 6	-	820 A 16	18 NCD 6	-	1800	0,24	
20 NiCrMo 2	1.6523	21 NiCrMo 2	8620	805 M 20	20 NCD 2	SNCM220(H)	1800	0,24	
25 CrMo 4	1.7218	25 CrMo 4	4130	1717 CDS 110	25 CD 4 S	SCM420;SCM430	1800	0,24	
34 Cr 4	1.7033	34 Cr 4	5132	530 A 32	32 C 4	SCr430(H)	1800	0,24	
ACCIAIO DEBOLMENTE LEGATO BONIFICATO QUENCHED AND TEMPERED LOW-ALLOY STEEL						350 HB			
-	1.2067	100Cr 6	L 3	BL 3	Y 100 C 6	-	1900	0,24	
107 WCr 5	1.2419	105 WCr 6	-	-	105 WC 13	SKS2;SKS3	1900	0,24	
32 CrMo 12	1.7361	32 CrMo 12	-	722 M 24	30 CD 12	-	1900	0,24	
35 CrMo 4	1.7220	34 CrMo 4	4135; 4137	708 A 37	35 CD 4	SCM432;SCCRM3	1900	0,24	
35 NiCrMo 6	1.6582	34 CrNiMo 6	4340	817 M 40	35 NCD 6	-	1900	0,24	
36 NiCrMo 4	1.6511	36 CrNiMo 4	9840	816 M 40	40 NCD 3	-	1900	0,24	
-	1.5710	36 NiCr 6	3135	640 A 35	35 NC 6	SNC236	1900	0,24	
-	1.5120	38 MnSi 4	-	-	-	-	1900	0,24	
-	1.8523	39 CrMoV 13 9	-	897 M 39	-	-	1900	0,24	
40 NiCrMo 2	1.6546	40 NiCrMo 2 2	8740	311-TYPE 7	40 NCD 2	SNCM240	1900	0,24	
41 Cr 4	1.7035	41 Cr 4	5140	530 M 40	42 C 4	SCr440(H)	1900	0,24	
41 CrAlMo 7	1.8509	41 CrAlMo 7	A 355 Cl A	905 M 39	40 CAD 6.12	-	1900	0,24	
41 CrMo 4	1.7223	41 CrMo 4	4142; 4140	708 M 40	42 CD 4 TS	SCM440	1900	0,24	
-	1.7045	42 Cr 4	5140	530 A 40	42 C 4 TS	SCr440	1900	0,24	
42 CrMo 4	1.7225	42 CrMo 4	4142; 4140	708 M 40	42 CD 4	SCM440(H)	1900	0,24	
45 WCrV 8 KU	1.2542	45 WCrV 7	S 1	BS 1	-	-	1900	0,24	
50 CrV 4	1.8159	50 CrV 4	6150	735 A 50	50 CV 4	SUP10	1900	0,24	
-	1.7176	55 Cr 3	5155	527 A 60	55 C 3	SUP9(A)	1900	0,24	
-	1.2713	55 NiCrMoV 6	L 6	-	55 NCDV 7	SKT4	1900	0,24	
55 Si 8	1.0904	55 Si 7	9255	240 A 53	55 S 7	-	1900	0,24	
-	1.8161	58 CrV 4	-	-	-	-	1900	0,24	
-	1.0961	60 SiCr 7	9262	-	60 SC 7	-	1900	0,24	

								VDI 3323 GR.
UNI	W/STOFF DIN	AISI	BS	AFNOR	JIS	kc1.1	mc	
ACCIAIO MOLTO LEGATO RICOTTO ANNEALED HIGH-ALLOY STEEL						200 HB		
12 Ni 19	1.5680	12 Ni 19	2515	-	Z 18 N 5	-	2000	0,23
X 45 CrSi 8	1.4718	G-X 45 CrSi 9 3	HNV 3	401 S 45	Z 45 CS 9	SUH1	2000	0,23
-	1.3355	S 18-0-1	T 1	BT 1	Z 80 WCV 18-04-01	SKH2	2000	0,23
-	1.3255	S 18-1-2-5	T 4	BT 4	Z 80 WKCVCV 18-05-04-0	SKH3	2000	0,23
HS 2 9 2	1.3348	S 2-9-2	M 7	-	Z 100 DCWV 09-04-02	-	2000	0,23
HS 6 5 2	1.3343	S 6-5-2	M 2	BM 2	Z 85 WDCVCV 06-05-04-0	SKH51	2000	0,23
HS 6 5 2 5	1.3243	S 6-5-2-5	-	-	Z 85 WDKCVCV 06-05-05	SKH55	2000	0,23
X 100 CrMoV51KU	1.2363	X 100 CrMoV 5 1	A 2	BA 2	Z 100 CDV 5	SKD12	2000	0,23
X 165 CrMoW12KU	1.2601	X 165 CrMoV 12	-	-	-	-	2000	0,23
X 210 Cr 13KU (K100)	1.2080	X 210 Cr 12	D 3	BD 3	Z 200 C 12	SKD1	2000	0,23
X 215 CrW 12 1KU	1.2436	X 210 CrW 12	-	-	-	SKD2	2000	0,23
X 30 WCrV 9 3KU	1.2581	X 30 WCrV 9 3	H 21	BH 21	Z 30 WCV 9	SKD5	2000	0,23
X 40 CrMoV 511KU	1.2344	X 40 CrMoV 5 1	H 13	BH 13	Z 40 CDV 5	SKD61	2000	0,23
ACCIAIO MOLTO LEGATO BONIFICATO QUENCHED AND TEMPERED HIGH-ALLOY STEEL						350 HB		
12 Ni 19	1.5680	12 Ni 19	2515	-	Z 18 N 5	-	2500	0,23
X 45 CrSi 8	1.4718	G-X 45 CrSi 9 3	HNV 3	401 S 45	Z 45 CS 9	SUH1	2500	0,23
-	1.3355	S 18-0-1	T 1	BT 1	Z 80 WCV 18-04-01	SKH2	2500	0,23
-	1.3255	S 18-1-2-5	T 4	BT 4	Z 80 WKCVCV 18-05-04-0	SKH3	2500	0,23
HS 2 9 2	1.3348	S 2-9-2	M 7	-	Z 100 DCWV 09-04-02	-	2500	0,23
HS 6 5 2	1.3343	S 6-5-2	M 2	BM 2	Z 85 WDCVCV 06-05-04-0	SKH51	2500	0,23
HS 6 5 2 5	1.3243	S 6-5-2-5	-	-	Z 85 WDKCVCV 06-05-05	SKH55	2500	0,23
X 100 CrMoV51KU	1.2363	X 100 CrMoV 5 1	A 2	BA 2	Z 100 CDV 5	SKD12	2500	0,23
X 165 CrMoW12KU	1.2601	X 165 CrMoV 12	-	-	-	-	2500	0,23
X 210 Cr 13KU (K100)	1.2080	X 210 Cr 12	D 3	BD 3	Z 200 C 12	SKD1	2500	0,23
X 215 CrW 12 1KU	1.2436	X 210 CrW 12	-	-	-	SKD2	2500	0,23
X 30 WCrV 9 3KU	1.2581	X 30 WCrV 9 3	H 21	BH 21	Z 30 WCV 9	SKD5	2500	0,23
X 40 CrMoV511KU	1.2344	X 40 CrMoV 5 1	H 13	BH 13	Z 40 CDV 5	SKD61	2500	0,23
ACCIAIO INOSSIDABILE FERRITICO O MARTENSITICO RICOTTO ANNEALED FERRITIC OR MARTENSITIC STAINLESS STEEL						200 HB		
X 6 Cr 13	1.4000	X 6 Cr 13	403	403 S 17	Z 6 C 13	SUS403	1700	0,21
-	1.4001	G-X 7 Cr 13	-	-	-	-	1700	0,21
-	1.4016	X 6 Cr 17	430	430 S 15	Z 8 C 17	SUS430	1700	0,21
X 8 CrMo 17	1.4113	X 6 CrMo 17	434	434 S 17	Z 8 CD 17.01	SUS434	1700	0,21
X 6 CrTi 17	1.4510	X 6 CrTi 17	430Ti	-	Z 4 CT 17	-	1700	0,24
X 6 CrTi 12	1.4512	X 5 CrTi 12	409	409 S 19	Z 6 CT 12	SUH409	1700	0,24
X 10 CrAl 12	1.4724	X 6 CrAl 13	405	405 S 17	Z 8 CA 12	SUS405	1700	0,24
X 12 CrS 13	1.4005	X 12 CrS 13	416	416 S 21	Z 11 CF 13	SUS416	1700	0,24
-	1.4006	X 10 Cr 13	410; CA-15	410 S 21	Z 12 C 13	SUS410	1700	0,21
X 10 CrS 17	1.4104	X 12 CrMoS 17	430 F	-	Z 10 CF 17	SUS430F	1700	0,21
X 20 Cr 13	1.4021	X 42 Cr 13	420	420 S 37	Z 20 C 13	-	1900	0,24
X 30 Cr 13	1.4028	X 30 Cr 13	420	420 S 45	Z 30 C 13	(SUS420J1)	1900	0,24
X 16 CrNi 16	1.4031	X 40 Cr 13	420	-	Z 40 C 14	(SUS420J1)	1900	0,24
-	1.4057	X 20 CrNi 17 2	431	431 S 29	Z 15 CN 16.02	SUS431	1700	0,21
-	1.4112	X 90 CrMov 18	440B	-	-	SUS440B	1900	0,24
-	1.4923	X 22 CrMov 12 1	-	-	-	-	1900	0,24
X 105 CrMo 17	1.4125	X 105 CrMo 17	440C	-	Z 100 CD 17	SUS440C	2000	0,24
X 16 Cr 26	1.4749	X 18 CrN 28	446	-	-	SUH446	2000	0,24
-	1.4935	X 20 Cr MoWV 12 1	422	-	-	-	2000	0,24
ACCIAIO INOSSIDABILE MARTENSITICO BONIFICATO O INVECCHIATO QUENCHED AND TEMPERED OR AGED MARTENSITIC STAINLESS STEEL						330 HB		
X 12 CrS 13	1.4005	X 12 CrS 13	416	416 S 21	Z 11 CF 13	SUS416	1700	0,24
-	1.4006	X 10 Cr 13	410; CA-15	410 S 21	Z 12 C 13	SUS410	2000	0,21
X 10 CrS 17	1.4104	X 12 CrMoS 17	430 F	-	Z 10 CF 17	SUS430F	2000	0,21
X 20 Cr 13	1.4021	X 42 Cr 13	420	420 S 37	Z 20 C 13	-	1900	0,24
X 30 Cr 13	1.4028	X 30 Cr 13	420	420 S 45	Z 30 C 13	(SUS420J1)	1900	0,24
X 16 CrNi 16	1.4031	X 40 Cr 13	420	-	Z 40 C 14	(SUS420J1)	1900	0,24
-	1.4057	X 20 CrNi 17 2	431	431 S 29	Z 15 CN 16.02	SUS431	2000	0,21
-	1.4112	X 90 CrMoV 18	440B	-	-	SUS440B	1900	0,24
-	1.4923	X 22 CrMoV 12 1	-	-	-	-	1900	0,24
X 105 Cr Mo 17	1.4125	X 105 CrMo 17	440C	-	Z 100 CD 17	SUS440C	2000	0,24
X 16 Cr 26	1.4749	X 18 CrN 28	446	-	-	SUH446	2000	0,24
-	1.4935	X 20 CrMoWV 12 1	422	-	-	-	2000	0,24

									VDI 3323 GR.
UNI	W/STOFF DIN	AISI	BS	AFNOR	JIS	kc1.1	mc		
ACCIAIO INOSSIDABILE AUSTENITICO SOLUBILIZZATO AUSTENITIC STAINLESS STEEL SOLUBILIZED									
180 HB									
X 5 CrNi 18 10	1.4301	X 5 CrNi 18 9	304; 304 H	304 S 15	Z 6 CN 18.09	SUS304	1900	0,20	14.1
X 10 CrNiS 18.09	1.4305	X 10 CrNiS 18 9	303	303 S 21	Z 10 CNF 18.09	SUS303	1900	0,20	
X 2 CrNi 18 11	1.4306	X 2 CrNi 18 10	304L	304 S 11	Z 3 CN 19-11	SCS19	1750	0,20	
-	1.4308	G-X 6 CrNi 18 9	CF-8	304 C 15	Z 6 CN 18.10 M	SCS13	1900	0,20	
X 12 CrNi17 07	1.4310	X 12 CrNi 17 7	301	301 S 21	Z 12 CN 17.07	SUS301	1900	0,20	
X 8 CrNi 19 10	1.4312	X 8 CrNi 18 12	305	305 S 19	-	SUS305	1750	0,20	
-	1.4948	X 6 CrNi 18 11	304H	304 S 51	Z 5 CN 18-09	SUS304(H)	1750	0,20	
-	1.4311	X 2 CrNiN 18 10	304 LN	304 S 62	Z 2 CN 18.10	SUS304LN	1900	0,20	
X 5 CrNiMo 17 12	1.4401	X 5 CrNiMo 17 12 2	316	316 S 31	Z 7 CND 17-11-02	SUS316	1900	0,20	
X 2 CrNiMo 17 12	1.4404	X 2 CrNiMo 17 13 2	316L	316 S 11	Z 3 CND 17-12-02	-	1900	0,20	
-	1.4408	X 6 CrNiMo 18 10	CF-8M	304 C 15	-	SCS14	1900	0,20	
X 2 CrNiMo 18 16	1.4428	X 2 CrNiMo 18 16 4	317L	317 S 12	Z 2 CND 19-15-04	SUS317L	1900	0,20	
X 2 CrNiMo 17 13	1.4435	X 2 CrNiMo 18 14 3	316L	316 S 13	Z 3 CND 18-14-03	SCS16	1900	0,20	
-	1.4436	X 5 CrNiMo 17 13 3	316	316 S 16	Z 6 CND 17.12	-	1900	0,20	
-	1.4449	X 5 CrNiMo 17 13	317	317 S 16	-	SUS317	1900	0,20	
X 6 CrNiTi 18 11	1.4541	X 6 CrNiTi 18 10	321	321 S 12	Z 6 CNT 18.10	SUS321	1900	0,20	
X 6 CrNiMoTi 17 12	1.4571	X 6 CrNiMoTi 17 12 2	316 Ti	320 S 31	Z 6 CNT 17.12	-	1900	0,20	
X 6 CrNiNb 18 11	1.4550	X 6 CrNiNb 18 10	347	347 S 17	Z 6 CNNb 18.10	SUS347	1900	0,20	
X 6 CrNi 23 14	1.4833	X 6 CrNi 22 13	309S	309 S 13	Z 15 CN 24-13	SUS309S	1900	0,20	
X 6 CrNi 25 20	1.4845	X 12 CrNi 25 21	310 S	310 S 24	Z 12 CN 25.20	SUH310	1900	0,20	
X 2 CrMnN 17 7 5	1.4371	X 3 CrMnNiN 18 8 7	202	284 S 16	Z 8 CMN 18-08-05	SUS202	2050	0,20	
X 2 CrNiMoN 17 13 5	1.4439	X 2 CrNiMoN 17 13 5	S31726	-	Z 3 CND 18-14-06 AZ	-	2050	0,20	
X 16 CrNiSi 25 20	1.4841	X 15 CrNiSi 25 20	310	314 S 31	Z 15 CNS 25-20	-	2050	0,20	
-	1.4864	X 12 NiCrSi 16	330	NA 17	Z 12 NCS 35-16	SUH330	2050	0,20	
ACCIAIO INOSSIDABILE AUSTENITICO-FERRITICO (DUPLEX) SOLUBILIZZATO FERRITIC-AUSTENITIC STAINLESS STEEL SOLUBILIZED									
230-260 HB									
X 2 CrNiN 23 4	1.4362	X 2 CrNiN 23 4	S32304	-	Z 2 CN 23-04 AZ	-	2150	0,20	14.2
X 2 CrNiMoN 17 11 2	1.4406	X 2 CrNiMoN 17 13 2	316LN	316 S 61	Z 2 CND 17-12 AZ	SUS316LN	2150	0,20	
X 2 CrNiMoN 17 13 3	1.4429	X 2 CrNiMoN 17 13 2	316LN	316 S 63	Z 2 CND 17-13 AZ	SUS316LN	2150	0,20	
X 1 NiCrMoCu 25 20 5	1.4539	X 2 NiCrMoCu 25 20 5	CN-7M-No8904	904 S 13	Z 1 NCDU 25-20	-	2150	0,20	
X 2 CrNiMoN 25 7 4	1.4410	X 3 CrNiMoN 25 7 4	S32750	-	-	-	2150	0,20	
-	1.4417	X 2 CrNiMoSi 15	S31500	-	2376	-	2150	0,20	
-	1.4460	X 2 CrNiMoZ75	329	-	-	SUS329JL	2150	0,20	
-	1.4462	X 2 CrNiMoN 22-5-3	S31803	318 S 13	Z 3 CND ZZ-05 AZ	-	2150	0,20	
X 2 CrNiMoCuWN 25 7 4	1.4501	-	-	-	-	-	2150	0,20	
X 2 CrNiMoCuN 25 6 3	1.4507	-	-	-	-	-	2150	0,20	
-	1.4821	X 20 CrNiSi25 4	-	-	Z 20 CNS25.04	-	2150	0,20	
-	1.4823	G-X40 CrNiSi27 4	-	-	-	-	2150	0,20	
X 4 CrNiCuNb 16 4	1.4532	X 7 CrNiMoAl 15 7	15-7 PH	-	Z 8 CNDA 15.07	-	2150	0,20	
X 4 CrNiCuNb 16 4	1.4540	X 4 CrNiCuNb 16 4	15-5 PH	-	Z 6 CNU 15.05	-	2150	0,20	
X 5 CrNiCuNb 17 4	1.4542	X 5 CrNiCuNb 17 4	S17400	-	-	SCS24	2150	0,20	
X 7 CrNiAl 17 7	1.4568	X 7 CrNiAl177	17-7 PH	-	Z 8 CNA 17.07	-	2150	0,20	
GHISA GRIGIA PERLITICA / FERRITICA PEARLITIC/FERRITIC GRAY IRON									
180 HB									
G 10	0.6010	GG-10	A48-20 B	-	Ft 10 D	-	1150	0,22	15
G 14	0.6015	GG-15	A48-25 B	GRADE 150	Ft 15 D	FC150	1150	0,22	
G 20	0.6020	GG-20	A48-30 B	GRADE 220	Ft 20 D	FC200	1150	0,22	
G 25	0.6025	GG-25	A48-40 B	GRADE 260	Ft 25 D	FC250	1150	0,22	
GHISA GRIGIA PERLITICA / MARTENSITICA PEARLITIC/MARTENSITIC GRAY IRON									
260 HB									
G 25	0.6025	GG-25	A48-40 B	GRADE 260	Ft 25 D	FC250	1300	0,28	16
G 30	0.6030	GG-30	A48-45 B	GRADE 300	Ft 30 D	FC300	1300	0,28	
G 35	0.6035	GG-35	A48-50 B	GRADE 350	Ft 35 D	FC350	1300	0,28	
-	0.6040	GG-40	A48-60 B	GRADE 400	Ft 40 D	-	1300	0,28	
GHISA A GRAFITE SFEROIDALE (NODULARE) FERRITICA FERRITIC NODULAR CAST IRON									
160 HB									
-	0.7033	GGG-35.3	-	-	-	-	1200	0,25	17
GS 400-12	0.7040	GGG-40	60-40-18	SNG 420-12	FGS 400-12	FCD400	1200	0,25	
GSO 42-15	0.7043	GGG-40.3	-	SNG 370-17	FGS 370-17	-	1200	0,25	
GHISA A GRAFITE SFEROIDALE (NODULARE) PERLITICA PEARLITIC NODULAR CAST IRON									
250 HB									
GS 500-7	0.7050	GGG-50	65-45-12	SNG 500-7	FGS 500-7	FCD500	1350	0,28	18
GS 600-2	0.7060	GGG-60	80-55-06	SNG 600-3	FGS 600-3	FCD600	1350	0,28	
GS 700-2	0.7070	GGG-70	100-70-03	SNG 700-2	FGS 700-2	FCD700	1350	0,28	
-	0.7660	GGG-NiCr 20 2	A 439 TY.D2	S-NiCr 20 2	S-NC 20 2	-	1350	0,28	
-	0.7652	GGG-NiMn 13 7	-	S-NiMn 13 7	S-NM 13 7	-	1350	0,28	

								VDI 3323 GR.
UNI	W/STOFF DIN	AISI	BS	AFNOR	JIS	kc1.1	mc	
GHISA MALLEABILE (DURA) FERRITICA FERRITIC MALLEABLE (HARD) CAST IRON						130 HB		
GMB40	0.8040	GTW-40	-	W410/4	MB40-10	-	1200	0,25
GMB45	0.8045	GTW-45	-	-	-	-	1200	0,25
-	0.8055	GTW-55	-	-	-	-	1200	0,25
-	0.8065	GTW-65	-	-	-	-	1200	0,25
-	0.8135	GTS-35-10	-	B 340-12	MN 35-10	-	1200	0,25
GMN 45	0.8145	GTS-45-06	-	P 440-7	-	FCMW370	1200	0,30
GHISA MALLEABILE (DURA) PERLITICA PEARLITIC MALLEABLE (HARD) CAST IRON						230 HB		
-	0.8035	GTW-35	-	W340/3	MB35-7	-	1500	0,30
GMN 55	0.8155	GTS-55-04	-	P 5110-4	MP 50-5	FCMP490	1500	0,30
GMN 65	0.8165	GTS-65-02	-	P 570-3	MP 60-3	FCMP590	1500	0,30
-	0.8170	GTS-70-02	-	P 690-2	IP 70-2	FCMP690	1500	0,30
ALLUMINIO E SUE LEGHE PER ESTRUSIONE NON INVECCHIABILE ALUMINUM AND WROUGHT ALUMINUM ALLOYS, CANNOT BE AGED						60 HB		
-	3.0205	Al 99	-	-	-	-	700	0,25
-	3.0255	Al99.5	1000	L31/34/36	A59050C	-	700	0,25
-	3.3315	AlMg 1	-	-	-	-	700	0,25
LEGHE DI ALLUMINIO ESTRUSE, INVECCHIABILE WROUGHT ALUMINUM ALLOYS, CAN BE AGED						100 HB		
-	3.1325	AlCuMg 1	-	-	-	-	700	0,25
-	3.2315	AlMgSi 1	-	-	-	-	700	0,25
LEGHE DI ALLUMINIO FUSE, NON INVECCHIABILE CAST ALUMINUM ALLOYS, CANNOT BE AGED						SI < 12% 80 HB		
-	3.1655	AlCuSiPb	-	-	-	-	700	0,25
-	3.1754	G-AlCu5Ni1,5	-	-	-	-	700	0,25
811-04	3.4345	AlZnMgCu0,5	7050	L86	AZ 4 GU/9051	-	700	0,25
-	3.2581	G-AlSi 12	-	-	-	-	700	0,25
-	3.2163	G-AlSi9Cu3	-	-	-	-	700	0,25
LEGHE DI ALLUMINIO FUSE, INVECCHIABILE CAST ALUMINIUM ALLOYS, CAN BE AGED						SI < 12% 90 HB		
-	2.1871	G-AlCu4TiMg	-	-	-	-	700	0,25
-	3.2371	G-AlSi7Mg	4218 B	-	-	-	700	0,25
-	3.2381	G-AlSi10Mg	-	-	-	-	700	0,25
LEGHE DI ALLUMINIO FUSE, NON INVECCHIABILE CAST ALUMINUM ALLOYS, CANNOT BE AGED						SI > 12% 130 HB		
RAME E LEGHE DI RAME : BRONZO - OTTONE, LEGHE AUTOMATICHE COPPER AND COPPER ALLOYS: BRONZE, BRASS, FREE CUTTING ALLOYS						Pb 1%		
-	2.0375	CuZn36Pb3	-	-	-	-	700	0,27
-	2.1090	G-CuSn7ZnPb	C 93200	-	U-E 7 Z 5 Pb 4	-	700	0,27
-	2.1096	G-CuSn5ZnPb	C 83600	LG 2	U-E 5 Pb 5 Z 5	-	700	0,27
-	2.1098	G-CuSn2ZnPb	-	-	-	-	700	0,27
RAME E LEGHE DI RAME : BRONZO - OTTONE, IN GETTI COPPER AND COPPER ALLOYS: BRONZE AND CAST BRASS						90 HB		
-	2.0240	CuZn 15	C23000	CZ 102	CuZn 15	-	700	0,27
-	2.0592	G-CuZn 35 Al 1	C 86500	HTB 1	U-Z 36 N 3	-	700	0,27
-	2.1292	G-CuCrF 35	C 81500	CC1-FF	-	-	700	0,27
-	2.1293	CuCrZr	C 18200	CC 102	U-Cr 0,8 Zr	-	700	0,27
RAME E LEGHE DI RAME : BRONZO, RAME SENZA Pb, RAME ELETTROLITICO COPPER AND COPPER ALLOYS: BRONZE, COPPER WITHOUT LEAD, ELECTROLYTIC COPPER						100 HB		
-	2.0060	E-Cu 57	-	-	-	-	700	0,27
-	2.0590	G-CuZn40Fe	-	-	-	-	700	0,27
-	2.0966	CuAl 10 Ni 5 Fe 4	C 63000	Ca 104	U-A 10 N	-	700	0,27
-	2.0975	G-CuAl 10Ni	B-148-52	-	-	-	700	0,27
MATERIALI NON METALLICI: PLASTICA TERMOINDURENTE, PLASTICA RIFORZATA CON FIBRE NONMETALLIC MATERIALS: THERMOSETTING PLASTICS, FIBER-REINFORCED PLASTICS								29
GOMMA DURA, EBANITE HARD RUBBER, EBONITE								30

								VDI 3323 GR.
UNI	W/STOFF DIN	AISI	BS	AFNOR	JIS	kc1.1	mc	
LEGHE RESISTENTI AL CALORE, BASE Fe, RICOTTE ANNEALED, Fe-BASED, HIGH-TEMPERATURE ALLOYS						200 HB		
-	1.4558	X 2 NiCrAlTi 32 20	N 08800	NA 15	-	-	2600	0,24
-	1.4562	X 1 NiCrMoCu 32 28 7	N 08031	-	-	-	2600	0,24
-	1.4563	X 1 NiCrMoCuN 31 27 4	N 08028	-	Z 1 NCDU 31.27	-	2600	0,24
-	1.4864	X 12 NiCrSi	330	-	Z 12 NCS 35.16	-	2600	0,24
-	1.4864	X 12 NiCrSi 36 16	N 08330	NA 17	Z 12 NCS 35.16	SUH330	2600	0,24
LEGHE RESISTENTI AL CALORE, BASE Fe, TERMOINDURITE THERMOSETTING, Fe-BASED, HIGH-TEMPERATURE ALLOYS						280 HB		
-	1.4958	X 5 NiCrAlTi 31 20	-	-	-	-	3300	0,34
-	1.4977	X 40 CoCrNi 20 20	-	-	Z 42 CNKDOWNb	-	3300	0,34
LEGHE RESISTENTI AL CALORE, BASE Ni O Co, RICOTTE ANNEALED, Ni- OR Co-BASED, HIGH-TEMPERATURE ALLOYS						250 HB		
-	2.4360	NiCu30Fe	Monel 400	NA 13	NU 30	-	3300	0,24
-	2.4610	NiMo16Cr16Ti	Hastelloy C-4	-	-	-	3300	0,24
-	2.4630	NiCr20Ti	Nimonic 75	HR 5, 203-4	NC 20 T	-	3300	0,24
-	2.4631	NiCr20TiAl	-	HR 401,601	Nimonic 80 A	-	3300	0,24
-	2.4642	NiCr29Fe	Inconel 690	-	NC 30 Fe	-	3300	0,24
-	2.4810	G-NiMo30	Hastelloy C	-	-	-	3300	0,24
-	2.4856	NiCr22Mo9Nb	Inconel 625	NA 21	NC 22FeDNb	-	3300	0,24
-	2.4858	NiCr21Mo	Incoloy 825	NA 16	NC 21 Fe DU	-	3300	0,24
LEGHE RESISTENTI AL CALORE, BASE Ni O Co, TERMOINDURITE THERMOSETTING, Ni- OR Co-BASED, HIGH-TEMPERATURE ALLOYS						350 HB		
-	2.4375	NiCu30Al	Monel K 500	NA 18	NU 30 AT	-	3300	0,24
-	2.4668	NiCr19FeNbMo	Inconel 718	-	NC 19 Fe Nb	-	3300	0,24
LEGHE RESISTENTI AL CALORE, BASE Ni O Co, DI FUSIONE CAST, Ni- OR Co-BASED, HIGH-TEMPERATURE ALLOYS						320 HB		
-	2.4669	NiCr15Fe7TiAl	Inconel x-750	-	NC 15 TNb A	-	3300	0,24
-	2.4685	G-NiMo28	Hastelloy B	-	-	-	3300	0,24
-	2.4694	NiCr16Fe7TiAl	Inconel 751	-	-	-	3300	0,24
-	2.4764	CoCr20W15Ni	-	-	-	-	3300	0,24
TITANIO PURO PURE TITANIUM						Rm 400		
-	3.7025	Ti 1	-	2 TA 1	-	-	1400	0,23
-	3.7124	TiCu2	R 50250	2 TA 21-24	-	-	1400	0,23
-	3.7195	TiAl 3 v 2.5	-	-	-	-	1400	0,23
-	3.7225	Ti 1 Pd	R 52250	TP 1	-	-	1400	0,23
LEGHE TITANIO ALFA + BETA, TERMOINDURENTI TITANIUM ALLOYS ALPHA/BETA, THERMOSETTING						Rm 1050		
-	3.7115	TiAl5Sn2	-	-	-	-	1500	0,23
-	3.7145	TiAl6Sn2Zr4Mo2Si	R 54620	-	-	-	1500	0,23
-	3.7165	TiAl6V4	R 56400	TA 10-13; TA 28	T-A 6 V	-	1500	0,23
-	3.7175	TiAl6V6Sn2	-	-	-	-	1500	0,23
-	3.7185	TiAl4MoSn2	-	TA 45-51; TA 57	-	-	1500	0,23
ACCIAIO TEMPRATO E RINVENUTO HARDENED AND TEMPERED STEEL						45 HRC		38.1
ACCIAIO TEMPRATO E RINVENUTO HARDENED AND TEMPERED STEEL						55 HRC		38.2
ACCIAIO TEMPRATO E RINVENUTO HARDENED AND TEMPERED STEEL						60 HRC		39.1
ACCIAIO TEMPRATO E RINVENUTO HARDENED AND TEMPERED STEEL						> 62 HRC		39.2
GHISA DURA (BIANCA), FUSA WHITE CHILL CAST IRON						400 HB		40.1

VICKERS (HV)	BRINELL (HB)	ROCKWELL (HRC)	SHORE C (SH C)	Resistenza trazione Tensile strength (N/mm ²)	VICKERS (HV)	BRINELL (HB)	ROCKWELL (HRC)	SHORE C (SH C)	Resistenza trazione Tensile strength (N/mm ²)
80	76,0	-	-	255	390	371	39,8	53	1255
85	80,7	-	-	270	400	380	40,8	55	1290
90	85,5	-	-	285	410	390	41,8	56	1320
95	90,2	-	-	305	420	399	42,7	57	1350
100	95,0	-	-	320	430	409	43,6	58	1385
105	99,8	-	-	335	440	418	44,5	59	1420
110	105	-	-	350	450	428	45,3	60	1455
115	109	-	16	370	460	437	46,1	61	1485
120	114	-	18	385	470	447	46,9	63	1520
125	119	-	19	400	480	(456)	47,7	-	1555
130	124	-	20	415	490	(466)	48,4	65	1595
135	128	-	-	430	500	(475)	49,1	-	1630
140	133	-	-	450	510	(485)	49,8	66	1665
145	138	-	21	465	520	(494)	50,5	-	1700
150	143	-	22	480	530	(504)	51,1	68	1740
155	147	-	23	495	540	(513)	51,7	-	1775
160	152	-	-	510	550	(523)	52,3	70	1810
165	156	-	-	530	560	(532)	53,0	-	1845
170	162	-	25	545	570	(542)	53,6	71	1880
175	166	-	-	560	580	(551)	54,1	-	1920
180	171	-	26	575	590	(561)	54,7	73	1955
185	176	-	27	595	600	(570)	55,2	-	1995
190	181	-	28	610	610	(580)	55,7	-	2030
195	185	-	-	625	620	(589)	56,3	75	2070
200	190	-	29	640	630	(599)	56,8	-	2105
205	195	-	-	660	640	(608)	57,3	77	2145
210	199	-	30	675	650	(618)	57,8	-	2180
215	204	-	31	690	660	-	58,3	-	-
220	209	-	32	705	670	-	58,8	79	-
225	214	-	-	720	680	-	59,2	80	-
230	219	-	33	740	690	-	59,7	-	-
235	223	-	-	755	700	-	60,1	81	-
240	228	20,3	34	770	720	-	61,0	83	-
245	233	21,3	35	785	740	-	61,8	84	-
250	238	22,2	-	800	760	-	62,5	86	-
255	242	23,1	36	820	780	-	63,3	87	-
260	247	24,0	37	835	800	-	64,0	88	-
265	252	24,8	-	850	820	-	64,7	90	-
270	257	25,6	38	865	840	-	65,3	91	-
275	261	26,4	39	880	860	-	65,9	92	-
280	266	27,1	-	900	880	-	66,4	93	-
285	271	27,8	40	915	900	-	67,0	95	-
290	276	28,5	41	930	920	-	67,5	96	-
295	280	29,2	-	950	940	-	68,0	97	-
300	285	29,8	40	965					
310	295	31,0	43	995					
320	304	32,2	45	1030					
330	314	33,3	46	1060					
340	323	34,4	47	1095					
350	333	35,5	48	1125					
360	342	36,6	50	1155					
370	352	37,7	51	1190					
380	361	38,8	52	1220					

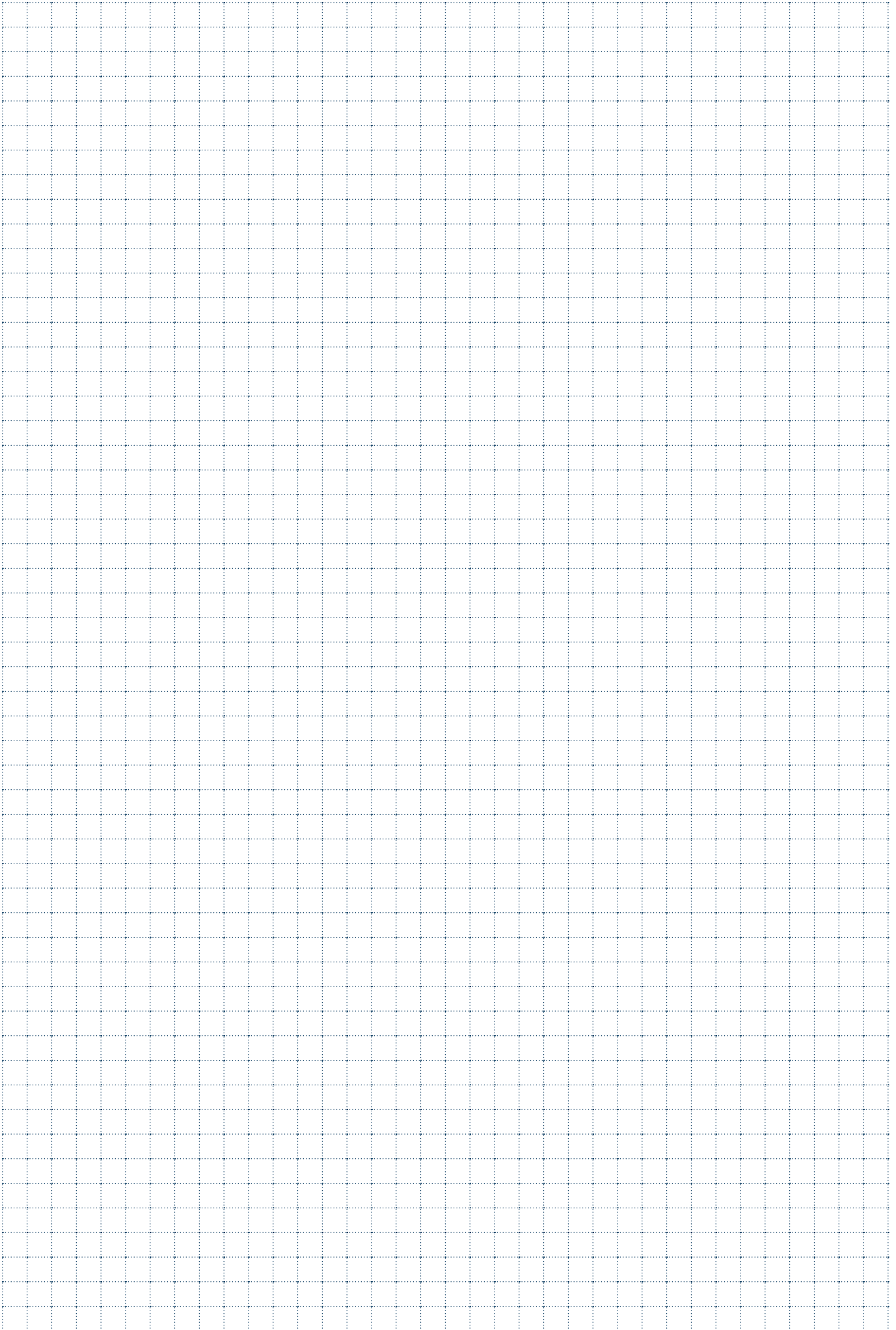

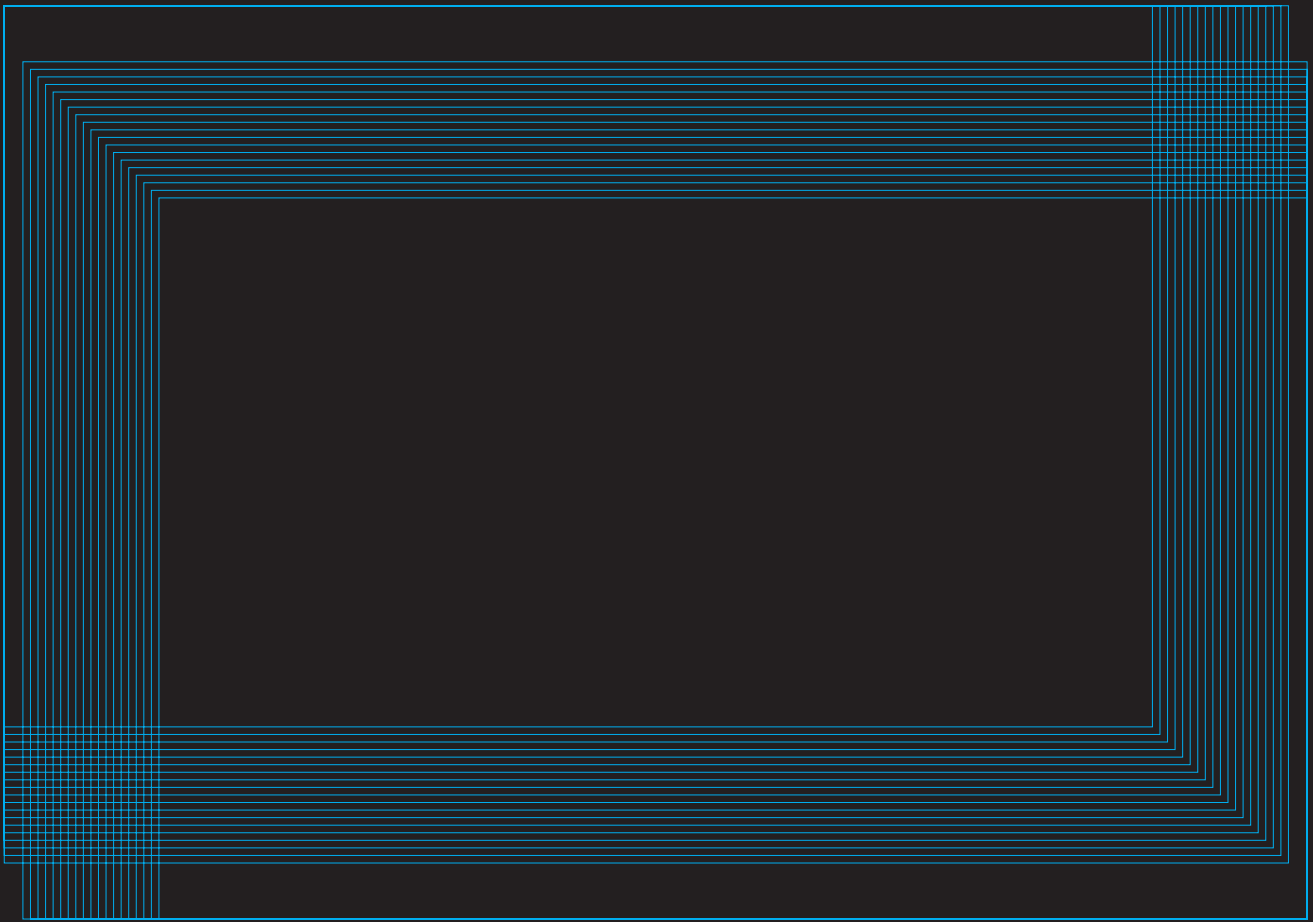

INDICE ALFANUMERICO GENERALE

GENERAL ALPHANUMERIC INDEX
ALLGEMEINE ALPHANUMERISCHE INHALTSÜBERSICHT
INDEX ALPHANUMÉRIQUE GÉNÉRALE
INDICE ALFANUMÉRICO GENERAL



Riepilogo alfanumerico generale

General alphanumeric summary

Algemeine alphanumerische zusammenfassung

Récapitulation alphanumérique générale



ART.	Pag.	ART.	Pag.	ART.	Pag.
00...	1121	161R B ... W	855	253..W	1058
03 599..	1056	161R ... ISO ..M	849	260Z3/8-12	1122
03 599..JIS	1057	161R/L A/AG/G55	844	270..	1090
03 599..MAZAK	1057	161R/L A/AG/G60	842	288 ... W	903
03 599..N	1056	161R/L ... BSPT	860	289 ... 012W	905
06 36..UN	1085	161R/L ... ISO	847	289CA.W	906
061R/L A55	844	161R/L ... NPT	857	289 ... PW	904
061R/L A60	842	161R/L ... RD	863	289 ... S12W	905
061R/L ... BSPT	860	161R/L ... TR	862	289 ... S ...PW	904
061R/L ... ISO	847	161R/L ... UN	851	290..	906
061R/L ... NPT	857	161R/L ... W	854	290..	1090
061R/L ... UN	851	161R ... MJ	864	328..	1064
061R/L ... W	854	161R ... W ..M	856	329..	1065
08 35..	1119	18..	1108	330..	1064
081R/L A55	844	22ER ... ISO ..M	849	331..	1071
081R/L A60	842	22ER/L ... ISO	846	333..	1072
081R/L ... BSPT	860	22ER/L N55	844	334..	1073
081R/L ... ISO	847	22ER/L N60	842	335..	1076
081R/L ... NPT	857	22ER/L ... RD	863	336..	1074
081R/L ... TR	862	22ER/L ... TR	862	339..	1075
081R/L ... UN	851	22ER/L ... UN	850	340..	1075
081R/L ... W	854	22ER/L ... W	853	341..	1076
08U IR ... ISO	847	22ER ... NPT ..M	859	342..	1077
08U IR/L U55	844	22ER ... W ..M	856	356..	893
08U IR/L U60	842	22IR ... ISO ..M	849	357..	893
08U IR/L ... UN	851	22IR/L ... ISO	847	360..	892
08U IR/L ... W	854	22IR/L N60	842	361..ER..	1078
08U IR ... TR	862	22IR/L ... RD	863	370.3..	888
11ER/L A55	844	22IR/L ... TR	862	370.3..C..	1036
11ER/L A60	842	22IR/L ... UN	851	370.8..	889
11ER/L ... ISO	846	22IR/L ... W	854	370.9..	889
11ER/L ... NPT	857	22IR N55	844	370.9..C..	1036
11ER/L ... UN	850	22IR ... NPT ..M	859	371..	891
11ER/L ... W	853	22IR ... W ..M	856	374..	890
111R/L A55	844	23...	1115	375..	894
111R/L A60	842	24..	1116	380..	891
111R/L ... BSPT	860	32...	1117	385..W	895
111R/L ... ISO	847	33...	1117	386..W	895
111R/L ... NPT	857	34...	1117	393..	896
111R/L ... UN	851	35...	1118	396 ...	900
111R/L ... W	854	36...	1118	399/SP ... W	903
111R ... MJ	864	37...	1118	399... W	902
12..	1104	40...	1123	422...	1108
12RA..	1104	41... (Pins)	1114	423..	1095
14...	1109	41.. (Springs)	1122	426...	1120
15...	1110	42...	1114	460..	1116
16...	1106	45.95.6..	1093	477...	1114
16ER B A/AG/G60	843	50..	1092	498..	896
16ER B AG/G55	845	54..	1091	602 ...	901
16ER B ... BSPT	861	55..	1091	603 ...	901
16ER B ... ISO	848	56..	1089	901...	1110
16ER B ... NPT	858	80...	1115	903...	1123
16ER B ... UN	852	82...	1115	905...	1106
16ER B ... W	855	84...	1115	925..	1094
16ER ... ISO ..M	849	100-...	1105	927..	1094
16ER/L A/AG/G55	844	100-5..	1115	938..	1094
16ER/L A/AG/G60	842	100-8..	1108	1440	1104
16ER/L ... BSPT	860	100-11	1115	1614	1105
16ER/L ... ISO	846	100-21	1115	2063	1123
16ER/L ... NPT	857	100-31	1115	3098	1123
16ER/L ... RD	863	100-41	1115	3116	1117
16ER/L ... TR	862	154.15..	237-525	3716	1118
16ER/L ... UN	850	156.15..	237-525	3810	1118
16ER/L ... W	853	180...	1108	4158	1123
16ER ... MJ	864	195..	1095	4196	1110
16ER ... W ..M	856	216..	1066	4295	1122
161R B A/AG/G60	843	218..	1078	26000	1090
161R B AG/G55	845	228..	1059	A	
161R B ... BSPT	861	228Q..	1061	A00MM18..	1096
161R B ... ISO	848	230..	1062	A-1..	1085
161R B ... NPT	858	230QN..	1063	A90MM18..	1097
161R B ... UN	852	235..	1065	A-140..	1085
		253..NCW	1058		
		253..VW	1068		

ART.	Pag.	ART.	Pag.	ART.	Pag.
ABS000M100	1097	C		FM PTGNR/L	96
A..DCLNR/L	102	C0...	1104	FM SCACR/L	97
A..DDUNR/L	103	C9...	1104	FM SCLCR/L	97
AGMS..	1088	CA ..75	908-910	FM SDACR/L	98
AGT..	1087	CA ..90	909-911	FM SJJCR/L	98
AGW..	1087	CCET	201-699-935	FMSR ... F	821
AL...	1106	CCGT	201-699-935	FMSR ... N	820
A..MCLNR/L	111	CCGW	201-699-935	FM SVACR/L	99
A..MDUNR/L	112	CCGW	201-699-935	FM SVJCR/L	99
A..MTFNR/L	109	CCMT	201-202-699	FMUSR2 ... N	816
A..MVPNR/L	113		700-935-936	FMUSR3 ... N	817
A..MVUNR/L	113	CCMX	202-700-936	FS...	1105
A..MVZNR/L	114	CHF16/40L	1120	FTAN ... F	827
A..MWLNR/L..N	110	CH-HK..	1093	FTGAR ... FT	823
ANR/L	831	CHT...	1120	FTMSR ... FT	821
AOG...F18	1097	CH-TRL30-40	1092	FTSR ... N	826
A..PCLNR/L	104	CIL..CTS..W	1067	FTUAR ... FT	825
A..PDUNR/L	105	CIL.. MFV..W	1068	FUAR ... F	825
APFT	527	CIL.. MF..W	1066	FUSR ... N	824
APFX	527	CKJNR/L	91		
APHT	526	CKM...	1116	G	
APKT	526-527	CNGP	193	GIE-7..	240
APKX	526-527	CNMA	193	GMG.. 14,5..	237
APMT	527	CNMG	193-194	GMG.. 25..	238
A..PSKNR/L	106	CNMM	194-195	GNL...	1098
A..PTFNR/L	107	CNMX	195	GNP...	1099
A..PWLNR/L	108	CPGT	202-936	GNR...	1098
ARIMF14180	1096	CPMT	202-936	GNS...	1099
A..SCLCR/L (ØDmin 8,5-15,5)	117	CT...	1113	GR...	1110-1111
A..SCLCR/L (ØDmin 10-50)	118	CTFPR/L..CA	927	GRB...	1111
A..SCUPR/L	116	CTGPR/L..CA	927	GRF...	1111
A..SDNCR/L	127	CTSPR/L..CA	927	GR...Q...	1111
A..SDQCR/L (ØDmin 12,5-19,5)	125	CTT..	1091	GRT...	1111
A..SDQCR/L (ØDmin 16-40)	126	CTTFR/L..CA	927	GSGN 14,5...	237
A..SDUCR/L (ØDmin 12,5-19,5)	121	CTWPR/L..CA	927	GSGN 25..	238
A..SDUCR/L (ØDmin 13-49)	122	CWE..MC..	1069	GSTN 14,5...	237
A..SDXCR/L	128	CWE..MS..	1069	GSTN 25..	238
A..SSKCR/L	135			GWH...	1112
A..STFCR/L	129	D		GWR...	1112
A..STIR/L	154	DCBNR/L	62		
A..STUCR/L	129	DCGT	203	H	
A..SVJBR/L	134	DCGW	203	HKA.. DP..	888
A..SVOCR/L	131	DCKNR/L	63	HSK.063.MD..	978
A..SVQBR/L	134	DCLNR/L	62	HSK.063.PRL..	969
A..SVQCR/L	133	DCMT	204	HSK.100.RDU..	969
A..SVUCR/L	132	DCMX	204	HSK..C..	1036
A..SVXCR/L	133	DCSNR/L	63	HSK..CTPN..	981
A..SWUCR/L	115	DDJNR/L	64	HSK..CTS..	980
ATR..	1056	DNGP	195	HSK..ER..	970
ATUB..	1096	DNMG	195-196	HSK..FC..	975
B		DNMM	196	HSK..FSV..	974
BAG...	1099	DNMX	196	HSK..FSW..	973
BCL ...	1113	DSKNR/L	65	HSK. .MDV..	979
BDGT	528	DSSNR/L	65	HSK..MFSN..	982
BDMT	528	DTJNR/L	66	HSK..MI..	983
BECR..	1080	DWLNR/L	67	HSK..MS..	976
BEMSN..	1079			HSK..PU..	972
BKN..	1084	E		HSK..SF..	977
BLF W .. 2T	913	EMI ...	1122	HSK..WEH..	971
BLM .. 075 ..W	908	E..SCLCR/L..N	119		
BLM .. 090 ..W	909	E..SCUPR/L..N	116	I	
BLS W .. 2T	912	E..SDQCR/L..N	126	ISO.A50.HSK..	968
BLT .. 075 ..W	910	E..SDUCR/L..N	123	ISO.A..FC..	997
BLT .. 090 ..W	911	ESMS..	1096	ISO.A..FF..	996
BLV...	1099	E..STFCR/L..N	130	ISO.A. FSCV..	995
BMIS..	1079	E..SVUCR/L..N	132	ISO.A. FSV..	994
BPUH..	1079	E..SWUCR/L..N	115	ISO.A..MC..	998
BRA.BLO.10	1121			ISO.A..MDV..	1002
B..SCLCR/L	120	F		ISO.A..MI..	1006
B..SDUCR/L	124	FGSR ... N	822	ISO.A..MS..	999
BT 599..	1057	FMMSR2 ... N	814	ISO.A..SF..	1000
BT 599.. xDIN69871	1057	FMMSR3 ... N	815	ISO.A..WEC..	989

Riepilogo alfanumerico generale

General alphanumeric summary

Algemeine alphanumerische zusammenfassung

Récapitulation alphanumérique générale



ART.	Pag.	ART.	Pag.	ART.	Pag.
ISO.B40.MD..	1001	MSA1076VP M..	734	MSU020256STN G..	796
ISO.B40.WE..	990	MSA2171VP MF..	762	MSU020371STN UNC..	776
ISO.B50.WE..	991	MSA2174VP MF..	762	MSU020376STN UNC..	776
ISO.B..CTPN..	1004	MSA2256VP G..	794	MSU020471STN UNF..	786
ISO.B..CTS..	1003	MSA2376VP UNC..	774	MSU020474STN UNF..	786
ISO.B..ER..	988	MSA2474VP UNF..	784	MSU150071STN M..	739
ISO.B..FSW..	993	MSA4071TN M..	737	MSU150071STNW M..	740
ISO.B..MFSN..	1005	MSA4071VP M..	735	MSU150076STN M..	739
ISO.B..MS	999	MSA4076TN M..	737	MSU150076STNW M..	740
ISO.B..PUH..	992	MSA4076VP M..	735	MSU150174STN M..	765
K		MSA4171VP MF..	763	MSU150174STNW MF..	766
KCN...	1118	MSA4174VP MF..	763	MSU150256STN G..	797
KDN 433	1118	MSA4256VP G..	795	MSU150256STNW G..	798
KIT-DIS-M10	1101	MSA4376VP UNC..	775	MSU150371STN UNC..	777
KITDP00000	1090	MSA4474VP UNF..	785	MSU150371STNW UNC..	778
KLM...	1114	MSA5071TN M..	757	MSU150376STN UNC..	777
KMS...	1109	MSA5076TN M..	757	MSU150376STNW UNC..	778
KNUX	196	MSB NR/L	79	MSU150471STN UNF..	787
KSN...	1118	MSG0100NITBW-h6..	760	MSU150471STNW UNF..	788
KVN 323	1118	MSG1071SNS M..	748	MSU150474STN UNF..	787
		MSG1076SNS M..	748	MSU150474STNW UNF..	788
L		MSG1171SNS MF..	769	MTENN	75
L348C.1.. (CC..)	929	MSG1174SNS MF..	769	MTJNR/L	75
L348C.1.. (TC..)	929	MSG1256SNS G..	801	MVJNR/L	80
LMA...	1124	MSG1376SNS UNC..	781	MVPNR/L	81
LNMM	528	MSG1474SNS UNF..	791	MVVNN	80
LNMT	529	MSG010071TL M..	749	MWLN R/L	76
LNMX	529	MSG010071TLW M..	750		
L/R348C.3.. (CC..)	928	MSG010076TL M..	749	O	
L/R348C.3.. (TC..)	928	MSG010076TLW M..	750	ONMU	529
		MSG010174TL MF..	770	OR--	1121
		MSG010174TLW MF..	771	ORM--	1121
		MSG180071TL M..	751		
M		MSG180071TLW M..	752	P	
MAS.A50.HSK..	968	MSG180076TL M..	751	PA...	1118
MAS.A..FC..	1021	MSG180076TLW M..	752	PCB NR/L	68
MAS.A..FF..	1020	MSI2071TB M..	746	PCFNR/L..CA	919
MAS.A..FSCV..	1019	MSI2076TB M..	746	PCG NR/L..CA	919
MAS.A..FSV..	1018	MSI2174TB MF..	767	PCKNR/L	69
MAS.A..MC..	1022	MSI4071TB M..	747	PCLNR/L	68
MAS.A..MDV..	1026	MSI4076TB M..	747	PCLNR/L..CA	919
MAS.A..MI..	1030	MSI4174TB MF..	768	PCLNR/L..TTS	92
MAS.A..MS..	1023	MSI020256TB G..	799	PCSNR/L	69
MAS.A..SF..	1024	MSI020371TB UNC..	779	PDJNR/L	70
MAS.A..WEC..	1013	MSI020376TB UNC..	779	PDJNR/L..TTS	93
MAS.B40.MD..	1025	MSI020471TB UNF..	789	PDNNR/L	70
MAS.B40.WE..	1014	MSI020474TB UNF..	789	PRL..	891
MAS.B50.WE..	1015	MSI160256TB G..	800	PSB NR/L	71
MAS.B..CTPN..	1028	MSI160371TB UNC..	780	PSC.C63.1PA..	1043
MAS.B..CTS..	1027	MSI160376TB UNC..	780	PSC.C63.MFSV..	1042
MAS.B..ER..	1012	MSI160471TB UNF..	790	PSC.C63.PU..	1037
MAS.B..FSW..	1017	MSI160474TB UNF..	790	PSC.C63.U45..	1043
MAS.B..MFSN..	1029	MSK060071TG M..	758	PSC.C..CTS..	1041
MAS.B..PUH..	1016	MSK060076TG M..	758	PSC.C..ER..	1038
MCFNR/L..CA	918	MSK180256TG G..	802	PSC.C..FSW..	1038
MCGNR/L..CA	918	MSKNR/L..CA	918	PSC.C..MC..	1039
MCKNR/L..CA	918	MSN1071VP.. M..	753	PSC.C..MS..	1040
MCLNR/L	77	MSN1076VP.. M..	753	PSC.C..PRL..	1037
MCLNR/L..CA	918	MSN4071VP.. M..	754	PSC.C..SF..	1040
MDJNR/L	78	MSR2071TL M..	743	PSC.C..WE..	1039
MDQNR/L	78	MSR2076TL M..	743	PSDNN	71
MNL ... CA	907	MSR3071TB.. M..	744	PSKNR/L	72
MNL ... UM	907	MSR3076TB.. M..	744	PSKNR/L..CA	921
MOLYKOTE HSC PLUS	1102	MSR4071TL M..	745	PSRNR/L..CA	921
MS...	1098	MSR4076TL M..	745	PSSNR/L	72
MSA15LNBR..	804	MSSNR/L	79	PSSNR/L..CA	921
MSA16LNBR..	805	MST3071TC M..	756	PTFNR/L	73
MSA20XLTC M..	741	MST3076TC M..	756	PTFNR/L..CA	920
MSA40EGSTN M..	808	MST8071TC.. M..	755	PTG NR/L	73
MSA40XLTC M..	742	MST8076TC.. M..	755	PTG NR/L..CA	919
MSA1071TN M..	736	MSU020071STN M..	738	PTSNR/L..CA	920
MSA1071VP M..	734	MSU020076STN M..	738	PTTNR/L..CA	920
MSA1076TN M..	736	MSU020174STN MF..	764		

Riepilogo alfanumerico generale

General alphanumeric summary

Algemeine alphanumerische zusammenfassung

Récapitulation alphanumérique générale



ART.	Pag.	ART.	Pag.	ART.	Pag.
PTWNR/L..CA	920	S 616.45 ..	441	S 2000.88W.. 11	450
PWLNRL	74	S 616.60 ..	441	S 2000.88W.. 17	452
PWLNRL..CA	921	S 616XLZ ..	441	S 2000.89W.. 07	448
Q		S 618 .. 3	442	S 2000.89W.. 11	450
QCMX	685	S 618 .. 4	443	S 4501-8W .. 12N	434
R		S 626 ..	680	S 4502-8W .. 05	436
RA	530	S 636W .. 06	672	S 8801-8 .. 12	438
RAET	530	S 646W .. 06	673	S 8801-8W .. 12	438
RCDM..	1077	S 656W ..	668	S 9001-6W..-10	466
RCGT	205	S 659W ..	669	S 9001-6W..-15	468
RCK 1225	1119	S 662W ..	670	S 9001-6XLMW.. -10	466
RCMT	205	S 663W ..	671	S 9001-6XLW.. -10	466
RCN 1225	1119	S 666W .. 16	488	S 9001-8W..-10	466
RD 12	1120	S 668W .. 16	488	S 9001-8W..-15	468
RDET	531	S 676W ..	440	S 9002-6W...-11	518
RDEW	531	S 676XLZ ..	440	S 9002-8W...-22	520
RDGT	531	S 678W .. 12	440	S 9002-9W...-11	518
RDHT	531	S686 ...	186	S 9002-9W...-22	520
RDHX	531	S686-D ...	188	S 9003.8W .. 13	478
RDU.. (Ext. Reduction)	891	S 806W ..	508	S 9004.6LW- .. -09	480
RDU..Q..	897	S 808W ..	510	S 9004.6XLW- .. -09	480
RDU.. (Reduction)	890	S 809W ..	512	S 9004.8W- .. -09	480
RGC..	1086	S 846GLW	502	S 9004.9W- .. -09	480
RGM..	1086	S 846GXLW	502	S 9005-6W- .. -09	458
RGS..	1086	S 846LW	502	S 9005-6XLW- .. -09	458
RGSE..	1086	S 846XLW	502	S 9005-8W- .. -09	458
RGSW..	1086	S848W	502	S 9005-9W...-09	458
RP...	1120	S848WF	502	S 9006.6W...-06	454
RS..	1119	S849GW	502	S 9006.6W- .. -10	456
RSN 1225	1119	S849W	502	S 9006.6XLW..-06	454
RSPU 04	1119	S 905W ..	498	S 9006.6XLW- .. -10	456
RUR 008	1122	S 926W ..	514	S 9006.8W...-06	454
S		S 929W ..	516	S 9006.8W- .. -10	456
S11	1117	S 950 ..	492	S 9006.9W- .. -06	454
S12.4	1117	S 955 ..	494	S 9006.9W- .. -10	456
S16	1117	S 955M ..	494	SAN0208	646
S16T	1105	S 959 ..	496	SAN0209	648
S22T	1105	S 976W ..	490	SAN0308	638
S100-TS-04-...	8	S 1056W .. 10	484	SAN0309	640
S100-TS-05-...	9	S 1058W .. 10	484	SAN0408	642
S100-TS-06-...	10	S 1058WF .. 10	484	SAN0409	644
S100-TS-07-...	11	S 1086GW..10	460	SAN0508	626
S101-04.9820-...R/L	12	S 1086GXL..10	462	SAN0509	628
S101-05.9020-052...020R/L	22	S 1086W..10	460	SAN0708	630
S101-05.9820-...R/L	14	S 1086XLZ..10	462	SAN0709	632
S101-06-...-020R/L	44	S 1086XLZM..10	462	SAN0808	634
S101-06.9820-...R/L	16	S 1088 .. 10	464	SAN0809	636
S101-07.9820-...R/L	18	S 1088GW .. 10	464	SC63 DCMNN	168
S101-...9847-...R/L	20	S 1088W .. 10	464	SC63 DDMNL	169
S102-04-...-R/L	24	S 1089W ..	464	SC63 SCMCN	177
S102-05-...-R/L	26	S 1296W .. 12	470	SC63 SVMBL	178
S102-06-...-R/L	28	S 1296XLZ .. 12	470	SC.. ANR/L	839
S102-07-...-R/L	30	S 1298G..12	470	SCBCR/L..CA	924
S102-...R...-R/L	32	S 1298GW..12	470	SC.. DCLNR/L	166
S103-06-...E62-15.015R/L	38	S 1298W ..12	470	SC.. DWLNR/L	167
S103-06-...I62-15.015R/L	36	S 1502.8W .. 14	504	SCFCR/L..CA	924
S103-06.R...-E62-15...R/L	42	S 1503.6LW .. 06	506	SCFPR/L..CA	924
S103-06.R...I62-15...R/L	40	S 1503.8W .. 06	506	SCGCR/L..CA	925
S104-...0060-...R	46	S 1503.9W .. 06	506	SCGT	205-937
S105-...0100-...000R/L	34	S 1656W .. 16	486	SCLCR/L	82
S 438 .. 13	432	S 1658 .. 16	486	SCLCR/L..CA	924
S 438G .. 13	432	S 1696W .. 16	472	SCLCR/L..TTS	94
S 438W .. 13	432	S 1696XLZ .. 16	474	SCLPR/L..CA	924
S 438WF .. 13	432	S 1696XLZM..16	474	SCMT	205-937
S 613.9.45W-0-16	444	S 1698 .. 16	476	SCMX	531
S 613.45W-0-16	444	S 1698GW..16	476	SC.. PCLNR/L (Ext.)	170
S 614.9.45W-0-12	445	S 1698W ..16	476	SC.. PCLNR/L (Int.)	179
S 614.45W-0-12	445	S 2000.86MW..11	450	SC.. PDJNR/L	171
S 616.30 ..	441	S 2000.86W.. 07	448	SC.. PWLNR/L (Ext.)	172
		S 2000.86W..11	450	SC.. PWLNR/L (Int.)	180
		S 2000.86W.. 17	452	SCR0183	420
		S 2000.86XLMW..11	450	SCR0184	610
		S 2000.86XLMW.. 17	452	SCR0185	612
		S 2000.86XLW..11	450	SCR0186	614

ART.	Pag.	ART.	Pag.	ART.	Pag.
SCR0187	422	SM1200	276	SNEX	533
SCRRCR/L	82	SM1300	278	SNHX	534
SCRRCR/L..CA	925	SM2203	312	SNMA	196
SCRPR/L..CA	925	SM2315..N01	284	SNMG	196-197
SC.. SCLCR/L (Ext.)	173	SM2417	286	SNMM	197
SC.. SCLCR/L (Int.)	181	SM2417..01	288	SNMX	533
SCSCR/L..CA	925	SM2424	314	SPFAR3	620
SC.. SDJCR/L	174	SM3100	320	SPFAR5	622
SC.. SDUCR/L	182	SM3315..N01	290	SPM-CN...	1100
SC.. SER/L	838	SM3415	368	SPMT	535
SCSPR/L..CA	925	SM3415..TI	370	SPMW	535
SC.. SVHBR/L	175	SM3417	292	SPU 1840-07	663
SC.. SVJBR/L	176	SM3417..N01	294	SRDCN	85
SC.. SVQBR/L	183	SM3510	300	SS230	426
SCTCR/L..CA	925	SM3510..N01	302	S..SCACL/R	930
SCTFPR/L	160	SM3515	372	S..SCDCL/R	930
SCTPR/L..CA	925	SM3515..TI	374	S..SCECL/R	930
SCWCR/L..CA	924	SM3525	376	S..SCLCR/L	117
SCWPR/L..CA	924	SM3525..TI	378	S..SCWCL/R	930
SD1800	586	SM4215	346	S..SDQCR/L	125
SDF0302	592	SM4300	330	S..SDUCR/L	121
SDF0371	616	SM4313	404	SSKCR/L..CA	923
SDF0502	596	SM4313..TI	406	SSSCR/L	86
SDF0802	598	SM4314	398	SSSCR/L..CA	923
SDF1201	600	SM4315	400	S..STACL	931
SDHCR/L	83	SM4315..TI	402	S..STDCL	931
SDJCR/L	83	SM4325	344	S..STECL	931
SDJCR/L..TTS	95	SM4330	336	S..STWCL	931
SDM0301	568	SM4413..LX	408	ST2201	266
SDM0310	576	SM4415	390	ST2205	270
SDM0501	572	SM4415..TI	392	STCM...	1112
SDM0510	580	SM4525	348	STFCR/L	87
SDMN0301	570	SM4701	428	STFCR/L..CA	922
SDMN0310	578	SM5215..TI	410	STGCR/L	87
SDMN0501	574	SM6402	352	STGCR/L..CA	923
SDMN0510	582	SM6432	356	STGR/L	154
SDMT	531	SM6502	354	STN2201	268
SDN0102	604	SM6532	358	STN2205	272
SDNCN	84	SM7215..TI	360	STSCR/L..CA	922
SDQ ..20 R	652	SMR0110	424	STTCR/L..CA	922
SDQ ..30 R	654	SMT ... R/L	678	STWCR/L..CA	922
SDQ ..40R N	656	SMU45	701	STXCR/L..CA	923
SDQM 20R	652	SMU.C...10W	674	SVHCR/L	88
SDQM 30 R	654	SMU-ER...00	1124	SVJBR/L	90
SDR0102	606	SMU.ER...10	675	SVJCR/L	88
SDR0302	590	SMW2200	306	SVVBN	90
SDR0341	588	SMW2203	310	SVVCN	89
SDR0502	594	SMW2300	308	SVXCR/L	89
SEC ... R/L	676	SMW2317	280	SXFCR/L..CA	926
SEDR/L	830	SMW2317..N01	282	SXSCR/L..CA	926
SEEX	532	SMW3100	318	SXTCR/L..CA	926
SEHT	532	SMW3231	322	SXWCR/L..CA	926
SEKT	532	SMW3300	324		
SEKW	532	SMW3301	416	T	
SEKX	532	SMW3304	340	TCGT	206-701-938
SER/L	830	SMW3400	364	TCGW	206-701-938
SET 16ER B 1020 ISO F7030	848	SMW3400..TI	366	TCMT	206-535
SET 16IR B 1020 ISO F7030	848	SMW3414	296		701-938
SET 154.15-16110215 F4340	237-525	SMW3414..N01	298	TCMX	535
SET 154.15-16110215 N3440	237-525	SMW4300	328	TDBC ..25 R/L	664
SET 228-ER..	1060	SMW4304	338	TDC ..30 R/L	658
SET ECL 0812 L 06N	119	SMW4305	394	TDC ..40 R/L	660
SET ECL 0812 R 06N	119	SMW4305..TI	396	TDCS ..30 R	662
SET EDU 1012 L 07N	123	SMW4400	332	THE - 7 - .. R/L	156
SET EDU 1012 R 07N	123	SMW4401	386	THI - 7 - .. R/L	158
SG 161	1122	SMW4401..TI	388	THS - 7 - .. R/L	156
SGTBU	162	SMW4402	334	TNGX	536
SIR/L	831	SMW4403	350	TNMA	197
SKR	810	SMW4404	342	TNMG	197-198
SLT	209	SMW4501	380	TOKX	536
SM..	1105	SMW4501..TI	382	TPMR	206-938
SM..-30	686	SMW4502	384	TRCR/L (GS 14,5)	140
SM..-45	686	SMW5405..TI	412	TRCR/L (GS 25)	142
SM..-55	686	SNCX	533		

Riepilogo alfanumerico generale

General alphanumeric summary

Algemeine alphanumerische zusammenfassung

Récapitulation alphanumérique générale



ART.	Pag.	ART.	Pag.	ART.	Pag.
TRCXR/L	150				
TRFR/L (GS 25)	148				
TRIR/L (GS 14,5)	140				
TRIR/L (GS 25)	142				
TRL	138				
TRLN..	239				
TRWR/L (GS 14,5)	144				
TRWR/L (GS 25)	146				
TRWXR/L	152				
TSFF..	1120				
TSFS..	1120				
U					
U16...	1118				
U22...	1118				
UM0..000.	1123				
UM0..0005	1122				
V					
VB...	1106				
VBC...	1106				
VBGW	207				
VBL...	1107				
VBMT	207				
VBS...	1109				
VBSF...	1107-1108				
VBTF...	1107				
VBZ...	1105				
VCGT	207				
VCGW	207				
VCKT	537				
VCMT	208				
VDKT	537				
VDST 206	1112				
VDST 2008	1112				
VNGP	198				
VNMG	198				
VS16T	1107				
VS22T	1107				
W					
WCGT	208-939				
WCMT	208-685-939				
WCMX	685				
WNGP	199				
WNMA	199				
WNMG	199-200				
WNMT	537				
WNMX	200				
WPMT	537				
WPMW	537				
X					
XCGT	702				
XCHX	703				
XCNT	702				

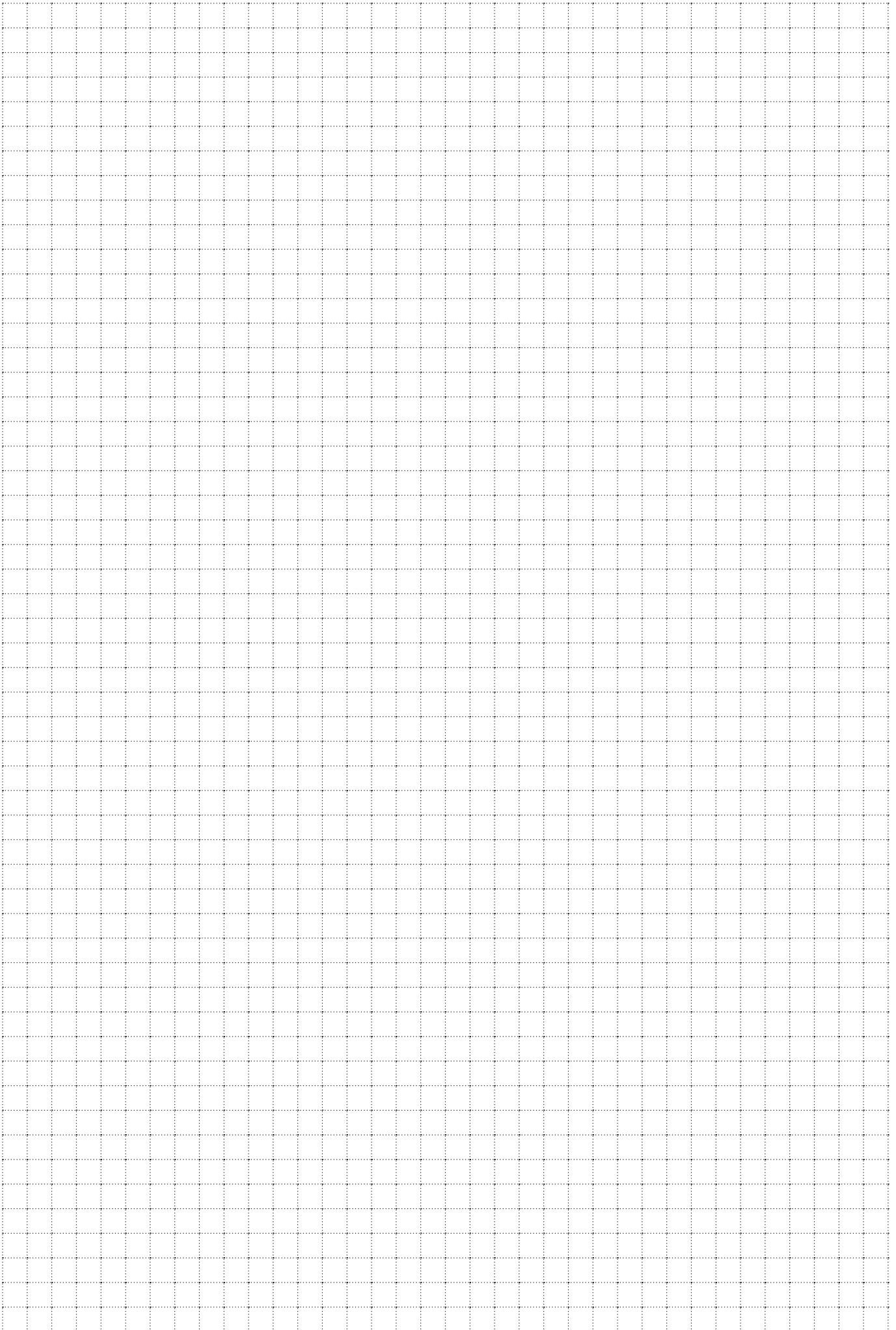

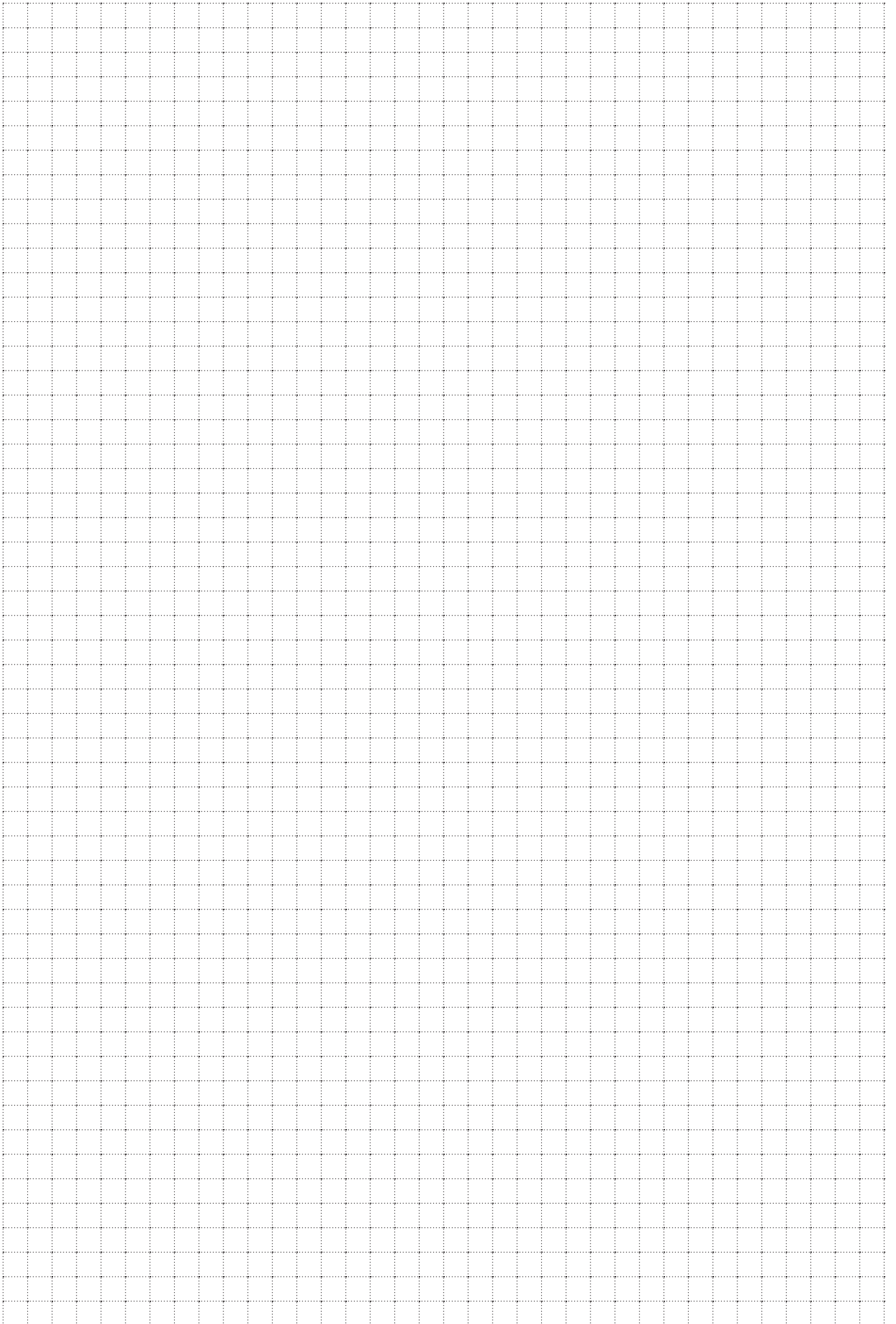

- Le informazioni contenute nel presente catalogo sono il più possibile esatte, ma non sono da ritenersi legalmente vincolanti. Ci riserviamo di apportare modifiche tecniche senza obbligo di preavviso. Le istruzioni e i parametri dati, pur essendo frutto di studi e test eseguiti con la massima professionalità, sono da ritenersi puramente indicativi.

- The information contained in this catalog is as accurate as possible but should not be deemed legally binding. We reserve the right to make technical changes without prior notice. Although the instructions and parameters provided herein are the result of studies and tests carried out with the utmost professionalism, they are purely indicative.

- Vietate copie e riproduzioni di foto, dati e impostazione grafica. I Trasgressori saranno perseguiti a Termine di legge.

- Copies and reproductions of pictures, data and graphic lay-out are forbidden. Infringement will be prosecuted by law.

INSERTI RIVESTITI "SLT" CON TOLLERANZE SPECIALI "SLT" INSERTS, COATED, WITH SPECIAL TOLERANCES

SAU È IN GRADO DI FORNIRE INSERTI PER STOZZATORI CON DIMENSIONI PERSONALIZZATE
SAU CAN PROVIDE INSERTS FOR BROACHING TOOLS IN CUSTOM SIZES

INSERTI "SLT" PER LAVORAZIONI DI STOZZATURA **SENZA** SMUSSO
"SLT" INSERTS FOR BROACHING APPLICATIONS **WITHOUT** CHAMFER

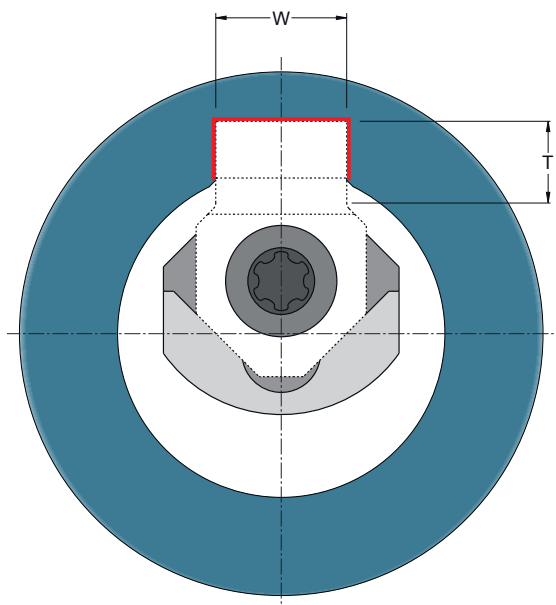

LISTINO INSERTI SPECIALI "SLT" PER STOZZATURA **SENZA** SMUSSO
PRICE LIST SPECIAL "SLT" INSERTS FOR BROACHING APPLICATIONS **WITHOUT** CHAMFER

Utensile Tool	S686.030	S686.040-050	S686.060-080	S686.100-120
Dimensione "W" "W" Dimension	2,70 ÷ 3,80	3,81 ÷ 5,50	5,51 ÷ 9,00	9,01 ÷ 12,5
Min 5 Pz.				
Min 10 Pz.				

DIMENSIONI DA INDICARE IN FASE D'ORDINE
MEASUREMENTS TO BE SPECIFIED WHEN ORDERING

T (mm)	Profondità massima del tagliente Maximum depth of cutting edge	= _____
W (mm)	Larghezza del Tagliente Cutting edge width	= _____
Tolleranza Tolerance	Rang di Tolleranza (Es. +0,008/-0,007) Tolerance range (Ex. +0,008/-0,007)	= _____

INSERTI "SLT" PER LAVORAZIONI DI STOZZATURA **CON** SMUSSO
"SLT" INSERTS FOR BROACHING APPLICATIONS **WITH** CHAMFER

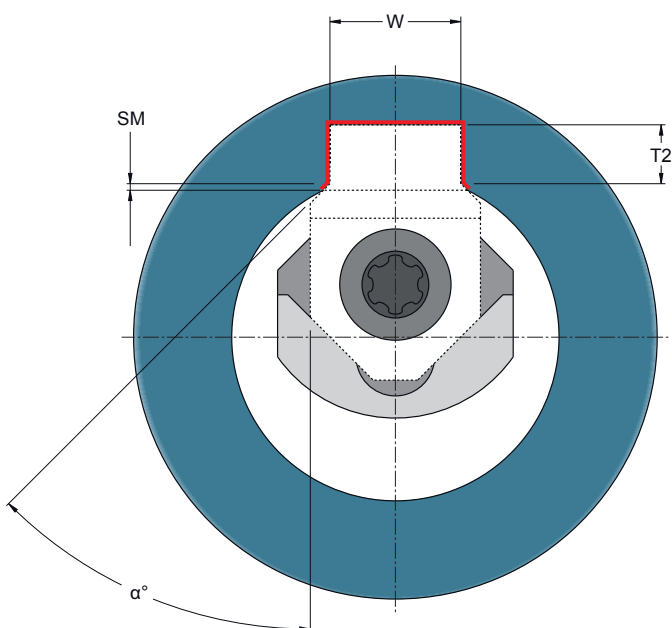

LISTINO INSERTI SPECIALI "SLT" PER STOZZATURA **CON** SMUSSO
PRICE LIST SPECIAL "SLT" BROACHING INSERTS **WITH** CHAMFER

Utensile Tool	S686.030	S686.040-050	S686.060-080	S686.100-120
Dimensione "W" "W" Dimension	2,70 ÷ 3,80	3,81 ÷ 5,50	5,51 ÷ 9,00	9,01 ÷ 12,5
Min 5 Pz.				
Min 10 Pz.				

DIMENSIONI DA INDICARE IN FASE D'ORDINE
MEASUREMENTS TO BE SPECIFIED WHEN ORDERING

α°	Angolo di Smusso Chamfer angle	= _____
T2 (mm)	Profondità del tagliente fino ad inizio smusso Cutting edge depth to chamfer start point	= _____
W (mm)	Larghezza del Tagliente Cutting edge width	= _____
Sm (mm)	Profondità dello Smusso Chamfer depth	= _____
Tolleranza Tolerance	Rang di Tolleranza (Es. +0,008/-0,007) Tolerance range (Ex. +0,008/-0,007)	= _____



QUALITY TOOLS ENGINEERING

Made In Italy

**Sede legale Amministrazione
e stabilimento:**

SAU S.p.A.
Via dei Raseni, 6/B
41040 Polinago (MO) Italy
Tel. 0039 0536 47510
Fax. 0039 0536 47275
infosau@sautool.it
www.sautool.it

**Filiale di Modena
e Magazzino**

Via Mozart, 47
41122 Modena (MO) Italy
Tel. 0039 059 280706
Fax. 0039 059 280109
saumodena@sautool.it
www.sautool.it

Filiale di Torino

Strada Vicinale della Cebrosa 86-A
10156 Torino (TO) Italy
Tel. 0039 011 8960193
Fax. 0039 011 8960193
sautorino@sautool.it
www.sautool.it

